

THE
ENCYCLOPÆDIA BRITANNICA

ELEVENTH EDITION

FIRST	edition, published in three	volumes,	1768—1771.
SECOND	” ” ten	”	1777—1784.
THIRD	” ” eighteen	”	1788—1797.
FOURTH	” ” twenty	”	1801—1810.
FIFTH	” ” twenty	”	1815—1817.
SIXTH	” ” twenty	”	1823—1824.
SEVENTH	” ” twenty-one	”	1830—1842.
EIGHTH	” ” twenty-two	”	1853—1860.
NINTH	” ” twenty-five	”	1875—1889.
TENTH	” ninth edition and eleven supplementary volumes,		1902—1903.
ELEVENTH	” published in twenty-nine volumes,		1910—1911.

COPYRIGHT

in all countries subscribing to the

Bern Convention

by

THE CHANCELLOR, MASTERS AND SCHOLARS

of the

UNIVERSITY OF CAMBRIDGE

All rights reserved

THE
ENCYCLOPÆDIA BRITANNICA

A
DICTIONARY

OF
ARTS, SCIENCES, LITERATURE AND GENERAL
INFORMATION

ELEVENTH EDITION

VOLUME XXIII
REFECTORY to SAINTE-BEUVE

New York
Encyclopædia Britannica, Inc.
342 Madison Avenue

**Copyright, in the United States of America, 1911,
by
The Encyclopædia Britannica Company.**

INITIALS USED IN VOLUME XXIII. TO IDENTIFY INDIVIDUAL
CONTRIBUTORS,¹ WITH THE HEADINGS OF THE
ARTICLES IN THIS VOLUME SO SIGNED.

A. B. Ch.	A. B. CHATWOOD, ASS. M. INST. C. E., M. INST. ELEC. E.	} Safes, Strong-rooms and Vaults
A. C. G.	ALBERT CHARLES LEWIS GOTTHILF GUENTHER, M.A., M.D., PH.D., F.R.S. Keeper of Zoological Department, British Museum, 1875-1895. Gold Medallist. Royal Society, 1878. Author of <i>Catalogue of Colubrine Snakes, Batrachia, Salientia, and Fishes in the British Museum</i> ; &c.	
A. D.	HENRY AUSTIN DOBSON, LL.D. See the biographical article: DOBSON, HENRY AUSTIN.	} Richardson, Samuel.
A. D. Mo.	ANSON DANIEL MORSE, M.A., LL.D. Emeritus Professor of History at Amherst College, Mass. Professor at Amherst College, 1877-1908.	} Republican Party.
A. G.*	ARTHUR GAMGEE, M.D., F.R.S., F.R.C.P., LL.D., D.Sc. (1841-1900). Formerly Fullerian Professor of Physiology, Royal Institution of Great Britain, and Professor of Physiology in the University of Manchester. Author of <i>Text-Book of the Physiological Chemistry of the Animal Body</i> ; &c.	} Respiratory System: <i>Movements of Respiration.</i>
A. Go.*	REV. ALEXANDER GORDON, M.A. Lecturer in Church History in the University of Manchester.	
A. H.*	ALBERT HAUCK, D. TH., D. PH. Professor of Church History in the University of Leipzig, and Director of the Museum of Ecclesiastical Archaeology. Geheimer Kirchenrat of Saxony. Member of the Royal Saxon Academy of Sciences and Corresponding Member of the Academies of Berlin and Munich. Author of <i>Kirchengeschichte Deutschlands</i> ; &c. Editor of the new edition of Herzog's <i>Realencyklopädie für protestantische Theologie und Kirche</i> .	} Relics.
A. Ha.	ADOLF HARNACK, D. PH. See the biographical article: HARNACK, ADOLF.	} Sabellius.
A. H.-S.	SIR A. HOUTUM-SCHINDLER, C.I.E. General in the Persian Army. Author of <i>Eastern Persian Irak</i> .	} Resht.
A. H. Sm.	ARTHUR HAMILTON SMITH, M.A., F.S.A. Keeper of the Department of Greek and Roman Antiquities in the British Museum. Member of the Imperial German Archaeological Institute. Author of <i>Catalogue of Greek Sculpture in the British Museum</i> ; &c.	} Ring (<i>in part</i>).
A. M. C.	AGNES MARY CLERKE. See the biographical article: CLERKE, A. M.	} Regiomontanus.
A. M. F. D.	AGNES MARY FRANCES DUCLAUX. See the biographical article: DUCLAUX, A. M. F.	} Renan.
A. N.	ALFRED NEWTON, F.R.S. See the biographical article: NEWTON, ALFRED.	} Rhea; Rifleman-bird; Roller (<i>Bird</i>); Ruff.
A. P. H.	ALFRED PETER HILLIER, M.D., M.P. Author of <i>South African Studies; The Commonwealth</i> ; &c. Served in Kaffir War, 1878-1879. Partner with Dr L. S. Jameson in medical practice in South Africa till 1896. Member of Reform Committee, Johannesburg, and Political Prisoner at Pretoria, 1895-1896. M.P. for Hitchin division of Herts, 1910.	
A. S. P.-P.	ANDREW SETH PRINGLE-PATTISON, M.A., LL.D., D.C.L. Professor of Logic and Metaphysics in the University of Edinburgh. Gifford Lecturer in the University of Aberdeen, 1911. Fellow of the British Academy. Author of <i>Man's Place in the Cosmos; The Philosophical Radicals</i> ; &c.	} Reid, Thomas (<i>in part</i>).
A. S. Wo.	ARTHUR SMITH WOODWARD, LL.D., F.R.S. Keeper of Geology, Natural History Museum, South Kensington. Secretary of the Geological Society, London.	} Reptiles: <i>History (in part) and General Characters.</i>

¹ A complete list, showing all individual contributors, appears in the final volume.

- A. W. H.*** ARTHUR WILLIAM HOLLAND.
Formerly Scholar of St John's College, Oxford. Bacon Scholar of Gray's Inn, 1900. { Regicide; Rienzi, Cola di.
- A. W. R.** ALEXANDER WOOD RENTON, M.A., LL.B.
Puisne Judge of the Supreme Court of Ceylon. Editor of *Encyclopaedia of the Laws of England*. { Rent.
- C. Ba.** CYRIL BAILEY, M.A.
Fellow, Tutor and Librarian of Balliol College, Oxford. Author of *The Religion of Ancient Rome*; &c. { Roman Religion.
- C. B. P.** CATHERINE BEATRICE PHILLIPS, B.A. (Mts W. ALISON PHILLIPS).
Associate of Bedford College, London. { Robes.
- C. E.*** CHARLES EVERITT, M.A., F.C.S., F.G.S., F.R.A.S.
Sometime Scholar of Magdalen College, Oxford. { Refraction: *Refraction of Light*.
- C. F. A.** CHARLES FRANCIS ATKINSON.
Formerly Scholar of Queen's College, Oxford. Captain, 1st City of London (Royal Fusiliers). Author of *The Wilderness and Cold Harbour*. { Rifle (*in part*);
Roszbach.
- C. H. Ha.** CARLTON HUNTLEY HAYES, A.M., PH.D.
Assistant Professor of History in Columbia University, New York City. Member of the American Historical Association. { Rosary.
- C. H. W. J.** REV. CLAUDE HERMANN WALTER JOHNS, M.A., LITT.D.
Master of St Catharine's College, Cambridge. Canon of Norwich. Author of *Assyrian Deeds and Documents*. { Sabbath: *Babylonian and Assyrian*.
- C. L. K.** CHARLES LETHBRIDGE KINGSFORD, M.A., F.R.HIST.S.
Assistant Secretary to the Board of Education. Author of *Life of Henry V*. Editor of *Chronicles of London* and *Stow's Survey of London*. { Richard II.; Richard III.;
Rivers, Richard Woodville,
Earl;
Russell, Bishop.
- C. M. P.** CHARLES MURRAY PITMAN.
Sometime Scholar of New College, Oxford. Formerly Stroke of the Oxford University Eight. { Rowing.
- C. R. B.** CHARLES RAYMOND BEAZLEY, M.A., D.LITT., F.R.G.S., F.R.HIST.S.
Professor of Modern History in the University of Birmingham. Formerly Fellow of Merton College, Oxford, and University Lecturer in the History of Geography, Lothian Prizeman, Oxford, 1889. Lowell Lecturer, Boston, 1908. Author of *Henry the Navigator*; *The Dawn of Modern Geography*; &c. { Rubruquis, William of
(*in part*).
- C. We.** CECIL WEATHERLY.
Formerly Scholar of Queen's College, Oxford. Barrister-at-Law, Inner Temple. { Saddlery and Harness.
- D. B. Ma.** DUNCAN BLACK MACDONALD, M.A., D.D.
Professor of Semitic Languages, Hartford Theological Seminary, Hartford, Conn. Author of *Development of Muslim Theology, Jurisprudence and Constitutional Theory*; *Selections from Ibn Khaldun*; *Religious Attitude and Life in Islam*; &c. { Rum, or Roum.
- D. C. T.** DAVID CROAL THOMSON.
Formerly Editor of the *Art Journal*. Author of *The Brothers Maris*; *The Barbizon School of Painters*; *Life of "Phia"*; *Life of Bewick*; &c. { Rousseau, Pierre E. T.
- D. F. T.** DONALD FRANCIS TOVEY.
Author of *Essays in Musical Analysis*: comprising *The Classical Concerto*, *The Goldberg Variations*, and analyses of many other classical works. { Rhythm: *in music*;
Rondo.
- D. H.** DAVID HANNAY.
Formerly British Vice-Consul at Barcelona. Author of *Short History of the Royal Navy*; *Life of Emilio Castelar*; &c. { Rigging.
- D. H. M.** DAVID HEINRICH MÜLLER, D.Ph.
Professor of Semitic Languages in the University of Vienna. Hofrat of the Austrian Empire. Knight of the Order of Leopold. Author of *Die Gesetze Hammurabi*; &c. { Sabaeans.
- D. LI. T.** DANIEL LLEUFER THOMAS.
Barrister-at-Law, Lincoln's Inn. Stipendiary Magistrate at Pontypridd and Rhonda. { Rhonda.
- D. M. W.** SIR DONALD MACKENZIE WALLACE, K.C.I.E., K.C.V.O.
Extra Groom of the Bedchamber to H.M. King George V. Director of the Foreign Department of *The Times*, 1891-1899. Member of Institut de Droit International and Officier de l'Instruction Publique of France. Joint-editor of New Volumes (10th ed.) of the *Encyclopaedia Britannica*. Author of *Russia*; *Egypt and Egyptian Question*; *The Web of Empire*; &c. { Russia: *History (in part)*.
- D. R.-M.** DAVID RANDALL-MACIVER, M.A., D.Sc.
Curator of Egyptian Department, University of Pennsylvania. Formerly Worcester Reader in Egyptology, University of Oxford. Author of *Medieval Rhodesia*; &c. { Rhodesia: *Archaeology*.
- E. B.** EDWARD BRECK, M.A., PH.D.
Formerly Foreign Correspondent of the *New York Herald* and the *New York Times*. Author of *Fencing*; *Wilderness Pets*; *Sporting in Nova Scotia*; &c. { Sabre-fencing.
- E. Cu.** EDMUND CURTIS, M.A.
Kemble College, Oxford. Lecturer on History in the University of Sheffield. { Robert Guiscard;
Roger I. of Sicily;
Roger II. of Sicily.
- E. C. B.** RIGHT REV. EDWARD CUTHBERT BUTLER, M.A., O.S.B., D.LITT.
Abbot of Downside Abbey, Bath. Author of "The Lausiac History of Palladius," in *Cambridge Texts and Studies*. { Sabas, St.

- E. F. S.** EDWARD FAIRBROTHER STRANGE.
Assistant Keeper, Victoria and Albert Museum, South Kensington. Member of Council, Japan Society. Author of numerous works on art subjects. Member of Bell's "Cathedral" Series. Joint-editor
- E. G.** EDMUND GOSSE, LL.D., D.C.L.
See the biographical article: GOSSE, EDMUND
- E. Gr.** ERNEST ARTHUR GARDNER, M.A.
See the biographical article: GARDNER, PERCY.
- E. Ha.** REV. EDWIN HATCH, M.A., D.D.
See the biographical article: HATCH, EDWIN.
- E. He.** EDWARD HEAWOOD, M.A.
Gonville and Caius College, Cambridge. Librarian of the Royal Geographical Society, London.
- E. H. B.** SIR EDWARD HERBERT BUNBURY, Bart., M.A., F.R.G.S. (d. 1895).
M.P. for Bury St Edmunds, 1847-1852. Author of *A History of Ancient Geography*; &c.
- E. H. M.** ELLIS HOVELL MINNS, M.A.
University Lecturer in Palaeogeology, Cambridge. Lecturer and Assistant Librarian at Pembroke College, Cambridge. Formerly Fellow of Pembroke College.
- E. L. B.** EDWARD LIVERMORE BURLINGAME, A.M., PH.D.
Editor of *Scribner's Magazine*. Formerly on the Staff of *New York Tribune*.
- E. O.*** EDMUND OWEN, F.R.C.S., LL.D., D.Sc.
Consulting Surgeon to St Mary's Hospital, London, and to the Children's Hospital, Great Ormond Street, London. Chevalier of the Legion of Honour. Late Examiner in Surgery at the Universities of Cambridge, London and Durham. Author of *A Manual of Anatomy for Senior Students*.
- E. Pr.** EDGAR PRESTAGE.
Special Lecturer in Portuguese Literature in the University of Manchester. Examiner in Portuguese in the Universities of London, Manchester, &c. Commandador, Portuguese Order of S. Thiago. Corresponding Member of Lisbon Royal Academy of Sciences, Lisbon Geographical Society; &c. Editor of *Letters of a Portuguese Nun*; *Azurara's Chronicles of Guinea*; &c.
- F. C. C.** FREDERICK CORNWALLIS CONYBEARE, M.A., D.Th.
Fellow of the British Academy. Formerly Fellow of University College, Oxford. Editor of *The Ancient Armenian Texts of Aristotle*. Author of *Myth, Magic and Morals*; &c.
- F. G. P.** FREDERICK GYMER PARSONS, F.R.C.S., F.Z.S.
Vice-President, Anatomical Society of Great Britain and Ireland. Lecturer on Anatomy at St Thomas's Hospital and the London School of Medicine for Women, London. Formerly Hunterian Professor at the Royal College of Surgeons.
- F. G. S.** F. G. STEPHENS.
Formerly Art Critic of the *Athenaeum*. Author of *Artists at Home*; *George Cruikshank*; *Memorials of W. Mulready*; *French and Flemish Pictures*; *Sir E. Landseer*; *T. C. Hook, R.A.*; &c.
- F. Ha.** FREDERIC HARRISON.
See the biographical article: HARRISON, FREDERIC.
- F. J. H.** FRANCIS JOHN HAVERFIELD, M.A., LL.D., F.S.A.
Camden Professor of Ancient History in the University of Oxford. Fellow of Brasenose College. Fellow of the British Academy. Formerly Censor, Student, Tutor and Librarian of Christ Church, Oxford. Ford's Lecturer, 1906-1907. Author of Monographs on Roman History, especially Roman Britain; &c.
- F. J. S.** FREDERICK JOHN SNELL, M.A.
Balliol College, Oxford. Author of *The Age of Chaucer*; &c.
- F. L. G.** FRANCIS LLEWELLYN GRIFFITH, M.A., PH.D., F.S.A.
Reader in Egyptology, Oxford University. Editor of the Archaeological Survey and Archaeological Reports of the Egypt Exploration Fund. Fellow of Imperial German Archaeological Institute.
- F. L. L.** LADY LUGARD.
See the biographical article: LUGARD, SIR F. J. D.
- F. P.** FRANK PODMORE, M.A. (1856-1910).
Sometime Scholar of Pembroke College, Oxford. Author of *Modern Spiritualism*; *Mesmerism and Christian Science*; &c.
- F. R. C.** FRANK R. CANA.
Author of *South Africa from the Great Trek to the Union*.
- F. Wo.** FREDERICK WEDMORE.
See the biographical article: WEDMORE, FREDERICK.
- Repin, Ilya.**
- Rhyme; Rhythm (in verse); Rimbaud, Jean; Rivers, Anthony Woodville, Earl; Rossetti, Christina; Runes, Runic Language and Inscriptions; Rydberg, Abraham; Saga.**
- Rhodes (in part).**
- Sacrifice: In the Christian Church.**
- Rudolf (Lake); Ruwenzori; Sahara (in part).**
- Rhodes (in part).**
- Russian Language.**
- Ripley, George.**
- Respiratory System: Surgery.**
- Resende, André de; Resende, Garcia de; Ribeiro, Bernardim; Sá de Miranda, Francisco de.**
- Sacrament.**
- Reproductive System; Respiratory System: Anatomy.**
- Rossetti, Dante Gabriel (in part).**
- Ruskin, John.**
- Roman Army.**
- Robin Hood (in part).**
- Rosetta.**
- Rhodes, Ceell.**
- Retro-cognition.**
- Rhodesia: History (in part); Sahara (in part).**
- Ribot, Théodule.**

INITIALS AND HEADINGS OF ARTICLES

- F. W. R.*** FREDERICK WILLIAM RUDLER, I.S.O., F.G.S.
Curator and Librarian of the Museum of Practical Geology, London, 1879-1902.
President of the Geologists' Association, 1887-1889. { **Rock-Crystal;**
Rubellite; Ruby.
- G. A.*** GERTRUDE FRANKLIN AHERTON.
Author of *Resénon; Ancestors; The Tower of Ivory*; &c. { **Rezánov.**
- G. Ch.** GEORGE CHRYSYAL, M.A., LL.D.
Professor of Mathematics and Dean of the Faculty of Arts, Edinburgh University.
Hon. Fellow and formerly Fellow and Lecturer of Corpus Christi College, Cambridge. { **Riemann, Georg.**
- G. C. W.** GEORGE CHARLES WILLIAMSON, LITT.D.
Chevalier of the Legion of Honour. Author of *Portrait Miniatures: Life of Richard Cosway, R.A.; George Engeleheart; Portrait Drawings*; &c. Editor of the New Edition of Bryan's *Dictionary of Painters and Engravers.* { **Russell, John (Painter).**
- G. Du.** GEORGE DUTHIE, M.A., F.R.S. (Edin.).
Director of Education, Southern Rhodesia. { **Rhodesia: Geography and**
Statistics.
- G. J. T.** GEORGE JAMES TURNER.
Barrister-at-Law, Lincoln's Inn. Editor of *Select Pleas of the Forests* for the Selden Society. { **Ridings.**
- G. R. P.** GEORGE ROBERT PARKIN, LL.D., C.M.G.
See the biographical article: PARKIN, G. R. { **Rhodes, Cecil: Rhodes**
Scholarships.
- G. Sa.** GEORGE SAINTSBURY, LL.D., D.C.L.
See the biographical article: SAINTSBURY, GEORGE E. B. { **Retz, Cardinal de;**
Romance; Ronard;
Rousseau, Jean Jacques.
- G. Sn.** GRANT SHOWERMAN, A.M., PH.D.
Professor of Latin at the University of Wisconsin. Member of the Archaeological Institute of America. Member of the American Philological Association. Author of *With the Professor; The Great Mother of the Gods*; &c. { **Rhea (Mythology).**
- H. B.** HILARY BAUERMAN, F.G.S. (d. 1909).
Formerly Lecturer on Metallurgy at the Ordnance College, Woolwich. Author of *A Treatise on the Metallurgy of Iron.* { **Safety-Lamp.**
- H. Br.** HENRY BRADLEY, M.A., PH.D.
Joint-editor of the *New English Dictionary* (Oxford). Fellow of the British Academy. Author of *The Story of the Goths; The Making of English*; &c. { **Riddles.**
- H. B. M.** THE VERY REV. CANON H. B. MACKEY, O.S.B.
Author of *Four Essays on St Francis de Sales.* { **Sacred Heart.**
- H. Ch.** HUGH CHISHOLM, M.A.
Formerly Scholar of Corpus Christi College, Oxford. Editor of the 11th edition of the *Encyclopaedia Britannica.* Co-editor of the 10th edition. { **Representation;**
Rosebery, Earl of.
- H. De.** HIPPOLYTE DELEHAYE, S.J.
Assistant in the compilation of the Bollandist publications: *Analecta Bollandiana* and *Acta Sanctorum.* { **Roeh, St;**
Rupert, St; Saint.
- H. E.** KARL HERMANN ETHÉ, M.A., PH.D.
Professor of Oriental Languages, University College, Aberystwyth (University of Wales). Author of *Catalogue of Persian Manuscripts in the India Office Library, London* (Clarendon Press); &c. { **Rümi;**
Sa'di.
- H. F. G.** HANS FRIEDRICH GADOW, F.R.S., PH.D.
Strickland Curator and Lecturer on Zoology in the University of Cambridge.
Author of "Amphibia and Reptiles," in the *Cambridge Natural History.* { **Reptiles: Anatomy and**
Distribution.
- H. F. P.** HENRY FRANCIS PELHAM, LL.D., D.C.L.
See the biographical article: PELHAM, H. F. { **Rome: Ancient History**
(in part).
- H. Go.** HENRY GOUDY, M.A., D.C.L., LL.D.
Regius Professor of Civil Law, Oxford, and Fellow of All Souls' College. Author of *The Law of Bankruptcy in Scotland*; &c. { **Roman Law.**
- H. H.** HENRI SIMON HYMANS, PH.D.
Keeper of the Bibliothèque Royale de Belgique, Brussels. Author of *Rubens: sa vie et son œuvre.* { **Rubens (in part).**
- H. L. H.** HARRIET L. HENNESSY, M.D. (Brux.), L.R.C.P.L., L.R.C.S.I. { **Respiratory System;**
Pathology (in part);
Rheumatoid Arthritis.
- H. M. V.** HERBERT M. VAUGHAN, F.S.A.
Keble College, Oxford. Author of *The Last of the Royal Stuarts; The Medici Popes; The Last Stuart Queen.* { **St Davids.**
- H. R. T.** HENRY RICHARD TEDDER, F.S.A.
Secretary and Librarian of the Athenaeum Club, London. { **Rymer, Thomas.**
- H. St.** HENRY STURT, M.A.
Author of *Idola Theatri; The Idea of a Free Church; Personal Idealism.* { **Relativity of Knowledge.**
- H. S. J.** HENRY STUART JONES, M.A.
Formerly Fellow and Tutor of Trinity College, Oxford, and Director of the British School at Rome. Member of the German Imperial Archaeological Institute. Author of *The Roman Empire*; &c. { **Roman Art;**
Rome: Ancient City (in part);
Christian Rome (in part) and
Ancient History (in part).
- H. S.-K.** SIR HENRY SETON-KARR, C.M.G., M.A.
M.P. for St Helen's, 1885-1906. Author of *My Sporting Holidays*; &c. { **Rifle.**

H. Tr.	SIR HENRY TROTTER, K.C.M.G., C.B. Lieutenant-Colonel, Royal Engineers. H.B.M. Consul-General for Roumania, 1894-1906, and British Delegate on the European Commission of the Danube. Victoria Medallist, Royal Geographical Society, 1878.	Rumania; <i>History (in part)</i> .
H. W. C. D.	HENRY WILLIAM CARLESS DAVIS, M.A. Fellow and Tutor of Balliol College, Oxford. Fellow of All Souls' College, Oxford, 1895-1902. Author of <i>England under the Normans and Angevins</i> ; <i>Charlemagne</i> .	Richard, Earl of Cornwall; Richard I.; Richard of Devizes; Robert of Gloucester; Roger of Hoveden; Roger of Wendover.
H. W. S.	H. WICKHAM STEED. Correspondent of <i>The Times</i> at Vienna. Correspondent of <i>The Times</i> at Rome, 1897-1902.	Ricasoli, Baron.
H. Y.	SIR HENRY YULE, K.C.S.I., C.B. See the biographical article: YULE, SIR HENRY.	Ricci, Matteo; Rubruquis, William of (<i>in part</i>).
I. A.	ISRAEL ABRAHAMS, M.A. Reader in Talmudic and Rabbinic Literature in the University of Cambridge. Formerly President, Jewish Historical Society of England. Author of <i>A Short History of Jewish Literature</i> ; <i>Jewish Life in the Middle Ages</i> ; <i>Judaism</i> ; &c.	Ritual Murder; Sabbatai Sebi; Sabbation; Sachs, Michael.
J. A. H.	JOHN ALLEN HOWE, B.Sc. Curator and Librarian of the Museum of Practical Geology, London. Author of <i>The Geology of Building Stones</i> .	Rhaetic.
J. A. S.	JOHN ADDINGTON SYMONDS, LL.D. See the biographical article: SYMONDS, J. A.	Renaissance.
J. Bra.	JOSEPH BRAUN, S.J. Author of <i>Die Liturgische Gewandung</i> ; &c.	Rochet.
J. Bt.	JAMES BARTLETT. Lecturer on Construction, Architecture, Sanitation, Quantities, &c., at King's College, London. Member of Society of Architects. Member of Institute of Junior Engineers.	Roofs.
J. B. B.	JOHN BAGNALL BURY, D.LITT., D.C.L. See the biographical article: BURY, J. B.	Roman Empire, Later.
J. B. M.	JAMES BASS MULLINGER, M.A. Lecturer in History, St John's College, Cambridge. Formerly University Lecturer in History and President of the Cambridge Antiquarian Society. Birkbeck Lecturer in Ecclesiastical History at Trinity College, Cambridge, 1890-1894. Author of <i>History of the University of Cambridge</i> ; <i>The Schools of Charles the Great</i> ; &c.	Richard of Cirencester.
J. D. B.	JAMES DAVID BOURCHIER, M.A., F.R.G.S. King's College, Cambridge. Correspondent of <i>The Times</i> in South-Eastern Europe. Commander of the Orders of Prince Danilo of Montenegro and of the Saviour of Greece, and Officer of the Order of St Alexander of Bulgaria.	Ristitch, Jovan.
J. E. C.	REV. JOSEPH ESTLIN CARPENTER, M.A., D.LITT., D.D., D.TH. Principal of Manchester College, Oxford. Author of <i>The First Three Gospels, their Origin and Relations</i> ; <i>The Bible in the Nineteenth Century</i> ; &c.	Religion.
J. F. H. B.	SIR JOHN FRANCIS HARPIN BROADBENT, BART., M.A., M.D., F.R.C.P., M.R.C.S. Physician to Out-Patients, St Mary's Hospital, London; Physician to the Hampstead General Hospital; Assistant Physician to the London Fever Hospital. Author of <i>Heart Disease and Aneurysm</i> ; &c.	Rheumatism.
J. F.-K.	JAMES FITZMAURICE-KELLY, LITT.D., F.R.HIST.S. Gilmour Professor of Spanish Language and Literature, Liverpool University. Norman McColl Lecturer, Cambridge University. Fellow of the British Academy. Member of the Royal Spanish Academy. Knight Commander of the Order of Alphonso XII. Author of <i>A History of Spanish Literature</i> ; &c.	Ruiz, Juan.
J. F. M.	JAMES FULLARTON MUIRHEAD, LL.D. Editor of many of Baedeker's Guide Books. Author of <i>America, the Land of Contrasts</i> .	Rhine (<i>in part</i>).
J. F. W.	JOHN FORBES WHITE, M.A., LL.D. (d. 1904). Joint-author of the <i>Life and Art of G. P. Chalmers, R.S.A.</i> ; &c.	Rembrandt (<i>in part</i>).
✕J. G.	HIS EMINENCE CARDINAL JAMES GIBBONS. See the biographical article: GIBBONS, JAMES.	Roman Catholic Church: <i>United States</i> .
J. G. H.	JOSEPH G. HORNER, A.M.I.MECH.E. Author of <i>Plating and Boiler Making</i> ; <i>Practical Metal Turning</i> ; &c.	Rolling-mill.
J. H. A. H.	JOHN HENRY ARTHUR HART, M.A. Fellow, Theological Lecturer and Librarian, St John's College, Cambridge.	Sadducees.
J. H. M.	JOHN HENRY MIDDLETON, M.A., LITT.D., F.S.A., D.C.L. (1846-1896). Slade Professor of Fine Art in the University of Cambridge, 1886-1895. Director of the Fitzwilliam Museum, Cambridge, 1889-1892. Art Director of the South Kensington Museum, 1892-1896. Author of <i>The Engraved Gems of Classical Times</i> ; <i>Illuminated Manuscripts in Classical and Mediaeval Times</i> .	Rietschel, Ernst; Ring (<i>in part</i>); Rome: <i>The Ancient City (in part)</i> ; and <i>Christian Rome (in part)</i> ; Round Towers.
J. H. R.	JOHN HORACE ROUND, M.A., LL.D. Balliol College, Oxford. Author of <i>Feudal England</i> ; <i>Studies in Peerage and Family History</i> ; <i>Peerage and Pedigree</i> .	Register.

- J. H. R.*** JAMES HARVEY ROBINSON, A.M., PH.D.
Professor of History, Columbia University, New York. Author of *Petrarch, the First Modern Scholar; History of Western Europe*; &c.
- J. H. R.** JOHN HOLLAND ROSE, M.A., LITT.D.
Christ's College, Cambridge. Lecturer on Modern History to the Cambridge University Local Lectures Syndicate. Author of *Life of Napoleon I.; Napoleonic Studies; The Development of the European Nations; The Life of Pitt*; &c.
- J. H. V. C.** JOHN HENRY VERRINDER CROWE.
Lieut.-Colonel, Royal Artillery. Commandant of the Royal Military College of Canada. Formerly Chief Instructor in Military Topography and Military History and Tactics at the Royal Military Academy, Woolwich. Author of *Eptome of the Russo-Turkish War, 1877-78*; &c.
- J. J. L.*** REV. JOHN JAMES LIAS, M.A.
Chancellor of Llandaff Cathedral. Formerly Hulsean Lecturer in Divinity and Lady Margaret Preacher, University of Cambridge. Author of *Miracles, Science and Prayer*; &c.
- J. J. T.** SIR JOSEPH JOHN THOMSON, D.Sc., LL.D., PH.D., F.R.S.
Cavendish Professor of Experimental Physics and Fellow of Trinity College, Cambridge. President of the British Association, 1909-1910. Author of *A Treatise on the Motion of Vortex Rings; Application of Dynamics to Physics and Chemistry; Recent Researches in Electricity and Magnetism*; &c.
- J. L. W.** JESSIE LAIDLAY WESTON.
Author of *Arthurian Romances unrepresented in Malory*.
- J. Mt.** JAMES MOFFATT, M.A., D.D.
Minister of the United Free Church of Scotland. Jowett Lecturer, London, 1907. Author of *Historical New Testament*; &c.
- J. S. F.** JOHN SMITH FLETT, D.Sc., F.G.S.
Petrographer to the Geological Survey. Formerly Lecturer on Petrology in Edinburgh University. Neill Medalist of the Royal Society of Edinburgh. Bigsby Medalist of the Geological Society of London.
- J. S. H.** JOHN SCOTT HALDANE, M.A., M.D., LL.D., F.R.S.
Fellow of New College, Oxford, and University Reader in Physiology. Metropolitan Gas Referee to the Board of Trade. Joint-editor and founder of the *Journal of Hygiene*. Author of Blue-books on "The Causes of Death in Colliery Explosions"; &c.
- J. S. R.** JAMES SMITH REID, M.A., LL.M., LITT.D., LL.D.
Professor of Ancient History and Fellow and Tutor of Gonville and Caius College, Cambridge. Hon. Fellow, formerly Fellow and Lecturer, of Christ's College. Editor of *Cicero's Academicæ; De Amicitia*; &c.
- J. T. Be.** JOHN THOMAS BEALBY.
Joint-author of *Stanford's Europe*. Formerly Editor of the *Scottish Geographical Magazine*. Translator of Sven Hedin's *Through Asia, Central Asia and Tibet*; &c.
- J. T. S.*** JAMES THOMSON SHOTWELL, PH.D.
Professor of History in Columbia University, New York City.
- J. W.** JAMES WILLIAMS, M.A., D.C.L., LL.D.
All Souls' Reader in Roman Law in the University of Oxford, and Fellow of Lincoln College. Barrister-at-Law of Lincoln's Inn. Author of *Law of the Universities*; &c.
- J. Wal.*** JAMES WALKER, M.A.
Christ Church, Oxford. Demonstrator in the Clarendon Laboratory. Formerly Vice-President of the Physical Society. Author of *The Analytical Theory of Light*; &c.
- J. We.** JULIUS WELHAUSEN, D.D.
See the biographical article: WELLHAUSEN, JULIUS.
- J. W. H.** JOHN WESLEY HALES, M.A.
Emeritus Professor of English Literature at King's College, London. Hon. Fellow, formerly Fellow and Tutor, of Christ's College, Cambridge. Clark Lecturer in English Literature at Trinity College, Cambridge. Author of *Shakespeare Essays and Notes; Folia Litteraria*; &c.
- K. S.** KATHLEEN SCHLESINGER.
Editor of the *Portfolio of Musical Archaeology*. Author of *The Instruments of the Orchestra*.
- L. F. A.** LAWRENCE F. ABBOTT.
President of *The Outlook Company*, New York.
- L. F. V.-H.** LEVESON FRANCIS VERNON-HARCOURT, M.A., M.INST.C.E. (1839-1907).
Professor of Civil Engineering at University College, London, 1882-1905. Author of *Rivers and Canals; Harbours and Docks; Civil Engineering as applied in Construction*; &c.
- L. J. S.** LEONARD JAMES SPENCER, M.A.
Assistant in Department of Mineralogy, British Museum. Formerly Scholar of Sidney Sussex College, Cambridge, and Harkness Scholar. Editor of the *Mineralogical Magazine*.
- L. L. S.** LIONEL LANCELOT SHADWELL, M.A.
Barrister-at-Law, Lincoln's Inn. One of H.M. Commissioners in Lunacy.
- M. A.** MATTHEW ARNOLD.
See the biographical article: ARNOLD, MATTHEW.
- Reformation, The.
- Reichstadt, Duke of.
- Russo-Turkish War: (1877-78).
- Reusch, Franz H.
- Röntgen Rays.
- Round Table, The.
- Romans, Epistle to the.
- Rhyolite.
- Respiratory System: *Physiology*.
- Ritschl, Friedrich W.; Ruhnken, David; Ruttilus, Claudius Namatianus.
- Riga (in part); Russia: *Geography and Statistics* (in part).
- Richelieu, Cardinal; Sacrilège.
- Roman Catholic Church: *English Law*.
- Refraction: *Double Refraction*.
- Reiske, Johann Jacob
- Robin Hood (in part).
- Regal; Rotta; Sackbut.
- Roosevelt, Theodore.
- River Engineering.
- Rutile.
- Registration.
- Sainte-Beuve.

- M. Cr.** FRANCIS MARION CRAWFORD.
See the biographical article: CRAWFORD, F. MARION. { **Rome: *The Modern City.***
- M. G.** MOSES GASTER, PH.D.
Chief Rabbi of the Sephardic Communities of England. Vice-President, Zionist Congress, 1898, 1899, 1900. Ilchester Lecturer at Oxford on Slavonic and Byzantine Literature, 1886 and 1891. President, Folk-lore Society of England. Vice-President, Anglo-Jewish Association. Author of *History of Rumanian Popular Literature*; &c. { **Rumania: *Literature.***
- M. Ha.** MARCUS HARTOG, M.A., D.Sc., F.I.S.
Professor of Zoology, University College, Cork. Author of "Protozoa," in *Cambridge Natural History*; and papers for various scientific journals. { **Rhizopoda;
Rotifera.**
- M. H. S.** MARION H. SPIELMANN, F.S.A.
Formerly Editor of the *Magazine of Art*. Member of Fine Art Committee of International Exhibitions of Brussels, Paris, Buenos Aires, Rome and the Franco-British Exhibition, London. Author of *History of "Punch"*; *British Portrait Painting to the Opening of the Nineteenth Century*; *Works of G. F. Watts, R.A.*; *British Sculpture and Sculptors of To-day*; *Henriette Ronner*; &c. { **Relief;
Reposués;
Roubilliac, Louis F.**
- M. O. E. C.** MAXIMILIAN OTTO BISMARCK CASPARI, M.A.
Reader in Ancient History at London University. Lecturer in Greek at Birmingham University, 1905-1908. { **Rhodes (in part);
Romanus I-IV. (Eastern Emperors).**
- M. P.*** LÉON JACQUES MAXIME PRINET.
Formerly Archivist to the French National Archives. Auxiliary of the Institute of France (Academy of Moral and Political Sciences). Author of *L'Industrie du sel en Franche-Comté*; *François I et le comté de Bourgogne*; &c. { **Retz, Seigneurs and Dukes of;
Rouault, Joachim.**
- N. W. T.** NORTHCOTE WHITRIDGE THOMAS, M.A.
Government Anthropologist to Southern Nigeria. Corresponding Member of the Société d'Anthropologie de Paris. Author of *Thought Transference*; *Kinship and Marriage in Australia*; &c. { **Sacrifice.**
- O. A.** OSMUND AIRY, M.A., LL.D.
H.M. Divisional Inspector of Schools and Inspector of Training Colleges, Board of Education. Author of *Louis XIV. and the English Restoration*; *Charles II.*; &c. Editor of the *Lauderdale Papers*; &c. { **Russell, Lord William.**
- O. Ba.** OSWALD BARRON, F.S.A.
Editor of *The Ancestor*, 1902-1905. Hon. Genealogist to Standing Council of the Honourable Society of the Baronetage. { **Russell (Family).**
- O. M.*** OCTAVE MAUS, LL.D.
Advocate of the Court of Appeal at Brussels. Director of *L'Art Moderne* and of the *Libre Esthétique*. President of the Association of Belgian writers. Officer of the Legion of Honour. Author of *Le Théâtre de Bayreuth*; *Aux Ambassadeurs*; *Malta, Constantinople et la Crimée*; &c. { **Rops, Félicien.**
- P. A. A.** PHILIP A. ASHWORTH, M.A., DOC. JURIS.
New College, Oxford. Barrister-at-Law. Translator of H. R. von Gneist's *History of the English Constitution*. { **Rhine (in part).**
- P. A. K.** PRINCE PETER ALEXEIVITCH KROPOTKIN.
See the biographical article: KROPOTKIN, PRINCE P. A. { **Riga (in part);
Russia: *Geography and Statistics (in part).***
- P. C. M.** PETER CHALMERS MITCHELL, M.A., F.R.S., F.Z.S., D.Sc., LL.D.
Secretary of the Zoological Society of London. University Demonstrator in Comparative Anatomy and Assistant to Linacre Professor at Oxford, 1888-1891. Author of *Oulines of Biology*; &c. { **Regeneration of Lost Parts;
Reproduction: of Animals.**
- P. Gl.** PETER GILES, M.A., LL.D., LITT.D.
Fellow and Classical Lecturer of Emmanuel College, Cambridge, and University Reader in Comparative Philology. Formerly Secretary of the Cambridge Philological Society. { **S.**
- P. G. K.** PAUL GEORGE KONODY.
Art Critic of the *Observer* and the *Daily Mail*. Formerly Editor of *The Artist*. Author of *The Art of Walter Crane*; *Velasquez: Life and Work*; &c. { **Rembrandt (in part);
Rubens (in part).**
- P. V.** PASQUALE VILLARI.
See the biographical article: VILLARI, PASQUALE. { **Rimini; Rome: *Roman Republic in the Middle Ages.***
- R. A. N.** REYNOLD ALLEYNE NICHOLSON, M.A., LITT.D.
Lecturer in Persian in the University of Cambridge. Sometime Fellow of Trinity College, Cambridge, and Professor of Persian at University College, London. Author of *Selected Poems from the Divāni Shamsi Tabrizi*; *A Literary History of the Arabs*; &c. { **Sābiāns.**
- R. C. J.** SIR RICHARD CLAVERHOUSE JEBB, LL.D., D.C.L.
See the biographical article: JEBB, SIR RICHARD CLAVERHOUSE. { **Rhetoric.**
- R. H. C.** REV. ROBERT HENRY CHARLES, M.A., D.D., D.LITT.
Grinfield Lecturer, and Lecturer in Biblical Studies, Oxford. Fellow of Merton College. Fellow of the British Academy. Formerly Professor of Biblical Greek, Trinity College, Dublin. Author of *Critical History of the Doctrine of a Future Life*; *Book of Jubilees*; &c. { **Revelation, Book of.**

- R. J. M.** RONALD JOHN MCNEILL, M.A.
Christ Church, Oxford. Barrister-at-Law. Formerly Editor of the *St James's Gazette*, London.
- R. L.*** RICHARD LYDEKKE, F.R.S., F.Z.S., F.G.S.
Member of the Staff of the Geological Survey of India, 1874-1882. Author of *Catalogues of Fossil Mammals, Reptiles and Birds in the British Museum; The Deer of all Lands; &c.*
- R. N. B.** ROBERT NISBET BAIN (d. 1909).
Assistant Librarian, British Museum, 1883-1909. Author of *Scandinavia: the Political History of Denmark, Norway and Sweden, 1513-1900; The First Romanovs, 1613-1725; Slavonic Europe: the Political History of Poland and Russia from 1469 to 1790; &c.*
- R. R. M.** ROBERT RANULPH MARETT, M.A.
Reader in Social Anthropology, Oxford University, and Fellow and Tutor of Exeter College. Formerly Dean and Sub-Rector of Exeter College. Author of *The Threshold of Religion*.
- R. S. C.** ROBERT SEYMOUR CONWAY, M.A., D.LITT.
Professor of Latin and Indo-European Philology in the University of Manchester. Formerly Professor of Latin in University College, Cardiff, and Fellow of Gonville and Caius College, Cambridge. Author of *The Italic Dialects*.
- R. W. F. H.** ROBERT WILLIAM FREDERICK HARRISON.
Barrister-at-Law, Inner Temple. Assistant Secretary of the Royal Society, London.
- S. A. C.** STANLEY ARTHUR COOK, M.A.
Lecturer in Hebrew and Syriac, and formerly Fellow, Gonville and Caius College, Cambridge. Editor for the Palestine Exploration Fund. Author of *Glossary of Aramaic Inscriptions; The Law of Moses and the Code of Hammurabi; Critical Notes on Old Testament History; Religion of Ancient Palestine; &c.*
- St C.** VISCOUNT ST CYRES.
See the biographical article: IDDESLEIGH, 1st EARL OF.
- S. H. V.*** SYDNEY HOWARD VINES, M.A., D.Sc., F.R.S.
Sherardian Professor of Botany, Oxford University, and Fellow of Magdalen College. Fellow of the University of London. Hon. Fellow, formerly Fellow and Lecturer, of Christ's College, Cambridge. President of the Linnean Society, 1900-1904. Author of *A Student's Text-Book of Botany; &c.*
- S. N.** SIMON NEWCOMB, D.Sc., LL.D.
See the biographical article: NEWCOMB, SIMON.
- T. AS.** THOMAS ASHBY, M.A., D.LITT. (Oxon.).
Director of British School of Archaeology at Rome. Formerly Scholar of Christ Church, Oxford. Craven Fellow, 1897. Conington Prizeman, 1906. Member of the Imperial German Archaeological Institute. Author of *The Classical Topography of the Roman Campagna*
- T. A. I.** THOMAS ALLAN INGRAM, M.A., LL.D.
Trinity College, Dublin.
- T. Ba.** SIR THOMAS BARCLAY.
Member of the Institute of International Law. Officer of the Legion of Honour. Author of *Problems of International Practice and Diplomacy; &c.* M.P. for Blackburn, 1910.
- T. B. L.** THOMAS BELL LIGHTFOOT, M.INST.C.E., M.INST.MECH.E.
Author of *Preservation of Foods by Cold; &c.*
- T. H.*** THOMAS HARRIS, M.D., F.R.C.P.
Formerly Hon. Physician to Manchester Royal Infirmary, and Lecturer on Diseases of the Respiratory Organs at Owens College, Manchester. Author of numerous articles on diseases of the respiratory organs.
- T. Wo.** THOMAS WOODHOUSE.
Head of the Weaving and Textile Designing Department, Technical College, Dundee.
- T. W.-D.** WALTER THEODORE WATTS-DUNTON.
See the biographical article: WATTS-DUNTON, WALTER THEODORE.
- W. A. B. C.** REV. WILLIAM AUGUSTUS BREVOORT COOLIDGE, M.A., F.R.G.S., PH.D.
Fellow of Magdalen College, Oxford. Professor of English History, St David's College, Lampeter, 1880-1881. Author of *Guide du Haut Dauphiné; The Range of the Tods; Guide to Grindelwald; Guide to Switzerland; The Alps in Nature and in History; &c.* Editor of the *Alpine Journal*, 1880-1881; &c.
- W. A. P.** WALTER ALISON PHILLIPS, M.A.
Formerly Exhibitioner of Merton College and Senior Scholar of St John's College, Oxford. Author of *Modern Europe; &c.*
- Richmond, Earis and Dukes of;
Richmond and Lennox, Duchess of;
Sacheverell, William.
- Reindeer; Rhinoceros (*in part*);
Rhytina; River-hog;
Rocky Mountain Goat;
Rodentia; Roe-buck;
Roquial.
- Repnin;
Reuterholm, Baron;
Sadolin, Jørgen.
- Religion: *Primitive Religion; Ritual.*
- Rome: *Ancient History (in part);*
Rutuli; Sabelle; Sabini.
- Royal Society, The.
- Ruth, Book of (*in part*);
Sabbath (*in part*).
- Roman Catholic Church (*in part*).
- Reproduction: *of Plants;*
Sachs, Julius von.
- Refraction: *Astronomical Refraction.*
- Regillus;
Regium; Rovigo;
Russellae; Ruvo;
St Bernard Passes (*in part*).
- Sacrilege: *English Law.*
- Reprisals.
- Refrigerating.
- Respiratory System: *Pathology (in part).*
- Rope and Rope-making;
Sacking and Sack Manufacture; Sailcloth.
- Rossetti, Dante Gabriel.
- Referendum and Initiative;
Reschen Scheideck;
Rhine; *Swiss Portion;*
Rhone; Rorschach;
Rosa, Monte; Rovereto;
St Bernard Passes (*in part*).
- Rochet: *Church of England;*
Roman Catholic Church (*in part*);
Russia: *Government and Administration.*

INITIALS AND HEADINGS OF ARTICLES

xiii

W. E. A. A.	WILLIAM EDMUND ARMYTAGE AXON, LL.D. Formerly Deputy Chief Librarian of the Manchester Free Libraries. On Literary Staff of <i>Manchester Guardian</i> , 1874-1905. Member of the Gorsedd, with the bardic name of Manceinion. Author of <i>Annals of Manchester</i> ; &c.	Roscoe, William.
W. H. F.	SIR WILLIAM H. FLOWER, F.R.S. See the biographical article: FLOWER, SIR W. H.	Rhinoceros (<i>in part</i>).
W. J. H.*	WILLIAM JAMES HUGHAN. Past S.G.D. of the Grand Lodge of England. Author of <i>Origin of the English Rite of Freemasonry</i> .	Rosicrucianism.
W. M.-L.	WILHELM MEYER-LÜBKE, PH.D. Hofrat of the Austrian Empire. Professor of Romance Philology in the University of Vienna. Author of <i>Grammatik der Romanischen Sprachen</i> ; &c.	Romance Languages.
W. M. R.	WILLIAM MICHAEL ROSSETTI. See the biographical article: ROSSETTI, DANTE G.	Ribera, Giuseppe; Rosa, Salvatore.
W. P. C.	WILLIAM PRIDEAUX COURTNEY. See the biographical article: COURTNEY, BARON.	Rosslyn, Earl of; Russell, 1st Earl.
W. P. P. L.	WILLIAM PITT PREBLE LONGFELLOW. Fellow of the American Institute of Architects. Editor of the <i>American Architect</i> . Author of <i>Cyclopaedia of Architecture in Italy, Greece and the Levant</i> ; &c.	Richardson, Henry Hobson.
W. R. D.	WYNDHAM ROWLAND DUNSTAN, M.A., LL.D., F.R.S., F.C.S. Director of the Imperial Institute. President of the International Association of Tropical Agriculture. Member of the Advisory Committee for Tropical Agriculture, Colonial Office.	Rubber.
W. R. K.	RT. HON. SIR WILLIAM RANN KENNEDY, LL.D. Lord of Appeal. Hon. Fellow of Pembroke College, Cambridge. Fellow of the British Academy. Judge of King's Bench Division of High Court of Justice, 1892-1907.	Russell of Killowen, Lord.
W. R. M.	WILLIAM RICHARD MORFILL, M.A. (d. 1910). Formerly Professor of Russian and the other Slavonic Languages in the University of Oxford. Curator of the Taylorian Institution, Oxford. Author of <i>Russia</i> ; <i>Slavonic Literature</i> ; &c.	Russian Literature.
W. R. S.	WILLIAM ROBERTSON SMITH, LL.D. See the biographical article: SMITH, WILLIAM ROBERTSON.	Reuchlin; Ruth, Book of (<i>in part</i>); Sabbath (<i>in part</i>).

PRINCIPAL UNSIGNED ARTICLES

Reflection of Light.	Rhubarb.	Rodriguez.	Roxburghshire.
Regensburg.	Rice.	Roland, Legend of.	Rubidium.
Regent.	Richmond (Surrey).	Rome (N.Y.).	Rubinstein.
Reims.	Richmond (Va.).	Romulus.	Rügen.
Renfrewshire.	Rickets.	Root.	Running.
Rennes.	Riding.	Rosaceae.	Russo-Japanese War.
Reporting.	Riesengebirge.	Roscommon, Co.	Rutebeuf.
Republic.	Rinderpest.	Rose.	Ruthenium.
Resorein.	Rio de Janeiro.	Roses, Wars of the.	Rutland.
Retainer.	Rio Grande do Sul (State).	Ross and Cromarty.	Ryazan.
Réunion.	Riot.	Rostock.	Sacramento (Cal.).
Reuss.	Ripon.	Rothschild.	Saffron.
Reynard the Fox.	Roads and Streets.	Rotterdam.	Saint Albans.
Rhine Provinces.	Rochester (Kent).	Rouen.	Saint Andrews.
Rhode Island.	Rochester (N.Y.).	Roulette.	Saint Augustine (Fla.).
Rhodium.	Rodney.	Roussillon.	St Denis.

ENCYCLOPÆDIA BRITANNICA

ELEVENTH EDITION

VOLUME XXIII

REFECTORY (med. Lat. *refectorium*, from *reficere*, to refresh), the hall of a monastery, convent, &c., where the religious took their chief meals together. There frequently was a sort of ambo, approached by steps, from which to read the *legenda sanctorum*, &c., during meals. The refectory was generally situated by the side of the S. cloister, so as to be removed from the church but contiguous to the kitchen; sometimes it was divided down the centre into two aisles, as at Fountains Abbey in England, Mont St Michel in France and at Villiers in Belgium, and into three aisles as in St Mary's, York, and the Bernardines, Paris. The refectory of St Martin-des-Champs in Paris is in two aisles, and is now utilized as the library of the École des Arts et Métiers. Its wall pulpit, with an arcaded staircase in the thickness of the wall, is still in perfect preservation.

REFEREE, a person to whom anything is referred; an arbitrator. The court of referees in England was a court to which the House of Commons committed the decision of all questions as to the right of petitioners to be heard in opposition to private bills. As originally constituted the referees consisted of the chairman of ways and means, and other members, the Speaker's counsel and several official referees not members of the House of Commons. In 1903 the appointment of official referees was discontinued. The court now consists of the chairman of ways and means, the deputy chairman and not less than seven other members of the House appointed by the Speaker, and its duty, as defined by a standing order, is to decide upon all petitions against private bills, or against provisional orders or provisional certificates, as to the rights of the petitioners to be heard upon such petitions. In the high court of justice, under the Judicature Act 1873, cases may be submitted to three official referees, for trial, inquiry and report, or assessment of damages. Inquiry and report may be directed in any case, trial only by consent of the parties, or in any matter requiring any prolonged examination of documents or accounts, or any scientific or local investigation which cannot be tried in the ordinary way.

REFERENDUM and **INITIATIVE**, two methods by which the wishes of the general body of electors in a constitutional

state may be expressed with regard to proposed legislation. They are developed to the highest extent in Switzerland, and are best exemplified in the Swiss federal and cantonal constitutions. By these two methods the sovereign people in Switzerland (whether in the confederation or in one of its cantons) approve or reject the bills and resolutions agreed upon by the legislative authority (Referendum), or compel that authority to introduce bills on certain specified subjects (Initiative)—in other words, exercise the rights of the people as regards their elected representatives at times other than general elections. The *Referendum* means "that which is referred" to the sovereign people, and prevailed (up to 1848) in the federal diet, the members of which were bound by instructions, all matters outside which being taken "ad referendum." A similar system obtained previously in the formerly independent confederations of the Grisons and of the Valais, in the former case not merely as between the Three Leagues, and even the bailiwicks of each within its respective league, but also (so far as regards the upper Engadine) the communes making up a bailiwick, though in the Valais the plan prevailed only as between the seven *Zehnten* or bailiwicks. The *Initiative*, on the other hand, is the means by which the sovereign people can compel its elected representatives to take into consideration either some specified object or a draft bill relating thereto, the final result of the deliberations of the legislature being subject by a referendum vote to the approval or rejection of the people. These two institutions therefore enable the sovereign people to control the decisions of the legislature, without having recourse to a dissolution, or waiting for the expiration of its natural term of office.

As might have been expected, both had been adopted by different cantons before they found their way into the federal constitution, which naturally has to take account of the sovereign rights of the cantons of which it is composed. Further, they (at any rate the referendum) were employed in the case of constitutional matters relating to cantonal constitutions before being applied to all or certain specified laws and resolutions. Finally, the action of both has been distinctly conservative in the case of the confederation, though to a less marked degree in the case of the cantons.

Two forms of the Referendum should be carefully distinguished: the *facultative* or optional (brought into play only on the demand of a fixed number of citizens), and the *obligatory* or compulsory (which obtains in all cases that lie within its sphere as defined in the constitution). The Initiative exists only in the facultative form, being exercised when a certain number of citizens demand it. Both came into common use during the Liberal reaction in Switzerland after the Paris revolution of July 1830. In 1831 St Gall first adopted the "facultative referendum" (then and for some time after called the "Veto"), and its example was followed by several cantons before 1848. The "obligatory referendum" appears first in 1852 and 1854 respectively in the Valais and the Grisons, when the older system was reformed, but in its modern form it was first adopted in 1863 by the canton of rural Basel. The Initiative was first adopted in 1845 by Vaud. Of course the cantons with *Landsgemeinden*, Uri, Unterwalden, Appenzell and Glarus (where the citizens appear in person) possessed both from time immemorial. Excluding these there were at the end of 1907 93 cantons, which had the "obligatory referendum" (Aargau, rural Basel, Bern, the Grisons, Schaffhausen, Schwyz, Soleure, Thurgau, the Valais and Zürich), while 73 cantons possess only the "facultative referendum" (Basel town, Geneva, Lucerne, Neuchâtel, St Gall, Ticino, Vaud and Zug). Fribourg alone had neither, save an obligatory referendum (like all the rest) as to the revision of the cantonal constitution. As regards the Initiative, all the cantons have it as to the revision of the cantonal constitution; while all but Fribourg have it also as to bills or legislative projects. In the case both of the facultative referendum and of the Initiative each canton fixes the number of citizens who have a right to exercise this power. The constitution of the Swiss confederation lags behind those of the cantons. It is true that both in 1848 (art. 113) and in 1874 (art. 120) it is provided that a vote on the question whether the constitution shall be revised must take place if either house of the federal legislature or 50,000 qualified voters demand it—of course a popular vote (obligatory referendum) must take place on the finally elaborated project of revision. But as regards bills the case is quite different. The "facultative referendum" was not introduced till 1874 (art. 89) and then only as regards all bills and resolutions not being of a pressing nature, 8 cantons or 30,000 qualified voters being entitled to ask for such a popular vote. But the Initiative did not appear in the federal constitution till it was inserted in 1891 (art. 121), and then merely in the case of a partial (not a total) revision of the constitution, if 50,000 qualified voters require it, whether as regards a subject in general or a draft bill,—of course the federal legislature had an Initiative in this matter in 1848 already. The results of the working of these two institutions in federal matters up to the end of 1908 are as follows. Excluding the votes by which the two federal constitutions of 1848 and 1874 were adopted, there have been 30 (10 of them between 1848 and 1874) votes (obligatory referendum) as to amendments of the federal constitution; in 15 cases only (of which only one was before 1874) did the people accept the amendment proposed. In the case of bills there have been 30 votes (very many bills have not been attacked at all), all of course since the facultative referendum was introduced in 1874; in 11 cases only have the people voted in the affirmative. Finally, with regard to the Initiative, there have been 7 votes, of which two only were in the affirmative. Thus, between 1874 and 1907, of 57 votes 27 only were in the affirmative, while if we include the 10 votes between 1848 and 1874 the figures are respectively 67 and 28, one only having been favourable during that period. The result is to show that the people, voting after mature reflection, are far less radically disposed than has sometimes been imagined.

The method of referendum by itself is also in use in some of the states of the American Union (see UNITED STATES) and in Australia, and under the name of *plébiscite* has been employed in France; but it is best studied in the Swiss constitution.

AUTHORITIES.—W. A. B. Coolidge, "The Early History of the Referendum" (article in the *English Historical Review* for October 1891); T. Curti, *Die schweizerischen Volksrechte, 1848 bis 1900* (Bern, 1900) (Fr. trans. by J. Ronjat with additions by the author, Paris, 1905)—Curti's earlier work, *Geschichte d. schweiz. Volksgesetzgebung* (Bern, 1882), is not entirely superseded by his later one; S. Deploige, *Die Referendum in Switzerland*, Engl. trans. with additional notes (London, 1898); N. Droz, "The Referendum in Switzerland" (article in the *Contemporary Review*, March 1895); J. M. Vincent, *Government in Switzerland*, chaps. v. and six. (New York and London, 1900). See also for the United States and generally, the American works on the Referendum by E. P. Oberholzer (1893 and 1900). (W. A. B. C.)

REFLECTION OF LIGHT. When a ray of light in a homogeneous medium falls upon the bounding surface of another medium, part of it is usually turned back or reflected and part is scattered, the remainder traversing or being absorbed by the second medium. The scattered rays (also termed the irregularly or diffusely reflected rays) play an important part in rendering objects visible—in fact, without diffuse reflection non-luminous objects would be invisible; they are occasioned by irregularities in the surface, but are governed by the same law as holds for regular reflection. This law is: the incident and reflected rays make equal angles with the normal to the reflecting surface at the point of incidence, and are coplanar with the normal. This is equivalent to saying that the path of the ray is a minimum.¹ In fig. 1, MN represents the section of a plane mirror; OR is the incident ray, RP the reflected ray, and TR the normal at R. Then the law states that the angle of incidence ORT equals the angle of reflection PRT, and that OR, RT and RP are in the same plane.

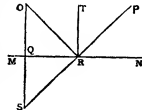

FIG. 1.

This natural law is capable of ready experimental proof (a simple one is to take the altitude of a star with a meridian circle, its depression in a horizontal reflecting surface of mercury and the direction of the nadir), and the most delicate instruments have failed to detect any divergence from it. Its explanation by the Newtonian corpuscular theory is very simple, for we have only to assume that at the point of impact the perpendicular velocity of a corpuscle is reversed, whilst the horizontal velocity is unchanged (the mirror being assumed horizontal). The wave-theory explanation is more complicated, and in the simple form given by Huygens incomplete. The theory as developed by Fresnel shows that regular reflection is due to a small zone in the neighbourhood of the point R (above), there being destructive interference at all other points on the mirror; this theory also accounts for the polarization of the reflected light when incident at a certain angle (see POLARIZATION OF LIGHT). The smoothness or polish of the surface largely controls the reflecting power, for, obviously, crests and furrows, if of sufficient magnitude, disturb the phase relations. The permissible deviation from smoothness depends on the wave-length of the light employed: it appears that surfaces smooth to within $\frac{1}{4}$ th of a wave-length reflect regularly; hence long waves may be regularly reflected by a surface which diffuses short waves. Also the obliquity of the incidence would diminish the effect of any irregularities; this is experimentally confirmed by observing the images produced by matt surfaces or by smoked glass at grazing incidence.

We now give some elementary constructions of reflected rays, or, what comes to the same thing, of images formed by mirrors.

1. If O be a luminous point and OR a ray incident at R on the plane mirror MN (fig. 1) to determine the reflected ray and the image of O. If RP be the reflected ray and RT perpendicular

¹ This principle of the minimum path, however, only holds for plane and convex surfaces; with concave surfaces it may be a maximum in certain cases.

to MN, then, by the law of reflection, angle $ORT = TRP$ or $ORM = PRN$. Hence draw OQ perpendicular to MN , and produce it to S , making $QS = OQ$; join SR and produce to P . It is easily seen that PR and OR are equally inclined to RT (or MN).

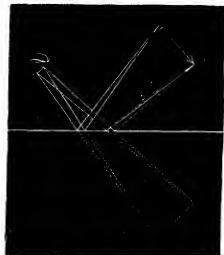

FIG. 2.

A point-eye at P would see a point object O at S , i.e. at a distance below the mirror equal to its height above. If the object be a solid, then the images of its corners are formed by taking points at the same distances below as the corners are above the mirror, and joining these points.

The eye, however, sees the image inverted, i.e., in the same relation as the left hand to the right. Fig. 2 shows how an extended object is viewed in a mirror by a natural eye.

2. If A, B be two parallel plane mirrors and O a luminous point between them (fig. 3) to determine the images of O all lie on the line (produced) PQ passing through O and perpendicular to the mirrors. Let $OP = p, OQ = q$. Then if O' be the image of O in $A, OO' = 2p$; now O' has an image O'' in B , such that $OO'' = OO' + O'Q = 2p + 2q$; similarly O'' has an image O''' in A , such that $OO''' = 4p + 2q$. In the same way O forms an image O_1 in B such that $OO_1 = 2q$; O_1 has an image O_{11} in A , such that $OO_{11} = 2p + 2q$; O_{11} has an image O_{111} in B , such that $OO_{111} = 2p + 4q$, and so on. Hence there are an infinite number of images at definite distances from the mirrors. This explains the vistas as seen, for example, between two parallel mirrors at the ends of a room.

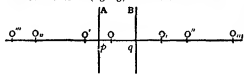

FIG. 3.

3. If A, B be two plane mirrors inclined at an angle θ , and intersecting at C , and O a luminous point between them, determine the position and number of images.

Call arc $OA = a, OB = \beta$. The image of O in A , i.e. a' , is such that Oa' is perpendicular to CA , and $Oa' = 2a$. Also $Ca' = CO$; and it is easily seen that all the images lie on a circle of centre C and radius CO . The image a' forms an image a'' in B such that $Oa'' = OB + Ba' = \beta + Ba' = \beta + Oa' = 2\beta + 2a = 2\theta$. Also a' forms an image a''' in A such that $Oa''' = OA + Aa' = 2a + 2\theta$. And generally $Oa^{2n} = 2n\theta, Oa^{2n+1} = 2n\theta + 2a$. In the same way it can be shown that the image first formed in B gives foci of the general distances: $O\beta^{2n} = 2n\theta, O\beta^{2n+1} = 2n\theta + 2\beta$. The number of images is limited, for when any one falls on the arc ab between the mirrors produced, it lies behind both mirrors, and hence no further image is possible. Suppose a^{2n} be the first image to fall on this arc, then arc $Oa^{2n} > O\beta a$, i.e. $2n\theta > \pi - a$ or $2n > (\pi - a)/\theta$. Similarly if β^{2n+1} be the first to fall on ab , we obtain $2n + 1 > (\pi - \beta)/\theta$. Hence in both cases the number of images is the integer next greater than $(\pi - a)/\theta$. In the same way it can be shown that the number of images of the b series is the integer next greater than $(\pi - \beta)/\theta$. If π/θ be an integer, then the number of images of each series is π/θ , for a/θ and β/θ are proper fractions. But an image of each series coincides; for if $\pi/\theta = 2n$, we have $Oa^{2n} + O\beta^{2n} = 2n\theta + 2n\theta = 4n\theta$ and β^{2n} coincide; and if $\pi/\theta = 2n + 1$, we have $Oa^{2n+1} + O\beta^{2n+1} = 4n\theta + 2(a + \beta) = (4n + 2)\theta = 2\pi$, i.e. a^{2n+1} and β^{2n+1} coincide. Hence the number of images, including the luminous point, is $2\pi/\theta$. This principle is utilized in the *kaleidoscope* (*q.v.*), which produces five images by means of its mirrors inclined at 60° (fig. 4). Fig. 5 shows the seven images formed by mirrors inclined at 45° .

4. To determine the reflection at a spherical surface. Let APB (fig. 6) be a section of a concave spherical mirror through its centre O and luminous point U . If a ray, say UP , meet the surface, it will be reflected along VP , which is coplanar with UP and the normal PO at P , and makes the angle $VPO = \theta$. Hence $VO/VP = OU/UP$. This expression may be simplified if we assume P to be very close to A , i.e. that the ray UP is very slightly inclined to the axis. Writing A for P , we have $VO/AV = OU/AU$; and calling $AU = u, AV = v$ and $AO = r$, this reduces to $u^{-1} + v^{-1} = 2r^{-1}$.

This formula connects the distances of the object and image formed by a spherical concave mirror with the radius of the mirror. Points satisfying this relation are called "conjugate foci," for obviously they are reciprocal, i.e. u and v can be interchanged in the formula.

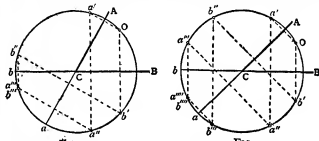

FIG. 4.

FIG. 5.

If u be infinite, as, for example, if the luminous source be a star, then $v^{-1} = 2r^{-1}$, i.e. $v = \frac{1}{2}r$. This value is called the focal length of

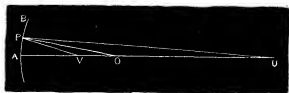

FIG. 6.

the mirror, and the corresponding point, usually denoted by F , is called the "principal focus." This formula requires modification for a convex mirror. If u be always considered as positive (v may be either positive or negative), r must be regarded as positive with concave mirrors and negative with convex. Similarly the focal length, having the same sign as r , has different signs in the two cases.

In this formula all distances are measured from the mirror; but it is sometimes more convenient to measure from the principal focus. If the distances of the object and image from the principal focus be x and y , then $u = x + f$ and $v = y + f$ (remembering that f is positive for concave and negative for convex mirrors). Substituting these values in $u^{-1} + v^{-1} = f^{-1}$ and reducing we obtain $xy = f^2$. Since f^2 is always positive, x and y must have the same sign, i.e. the object and image must lie on the same side of the principal focus.

We now consider the production of the image of a small object placed symmetrically and perpendicular to the axis of a concave (fig. 7) and a convex mirror (fig. 8). Let PQ be the object and A

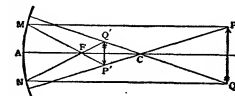

FIG. 7.

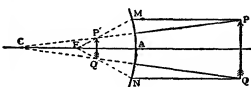

FIG. 8.

the vertex of the mirror. Consider the point P . Now a ray through P and parallel to the axis after meeting the mirror at M is reflected through the focus F . The line MF must therefore contain the image of P . Also a ray through P and also through the centre of curvature C of the mirror is reflected along the same path; this also contains the image of P . Hence the image is at P' , the intersection of the lines MF and PC . Similarly the image of any other point can be found, and the final image deduced. We notice that in fig. 6 the image is inverted and real, and in fig. 7 erect and virtual. The "magnification" or ratio of the size of the image to the object can be deduced from the figures by elementary geometry; it equals the ratio of the distances of the image and object from the mirror or from the centre of curvature of the mirror.

The positions and characters of the images for objects at varying

distances are shown in the table (F is the principal focus and C the centre of curvature of the mirror MA).

CONCAVE MIRROR

Position of Object.	Position of Image.	Character of Image.
∞	F	Real.
Between ∞ and C	Between F and C	Real, inverted, diminished
C	C	" " same size
Between C and F	Between C and ∞	" " magnified
Between F and A	A	Virtual, erect, magnified
		Erect, same size

CONVEX MIRROR

Position of Object.	Position of Image.	Character of Image.
∞	F	Virtual
Between ∞ and A	Between F and A	Virtual, erect, diminished
A	A	Erect, same size

The above discussion of spherical mirrors assumes that the mirror has such a small aperture that the reflected rays from any point unite in a point. This, however, no longer holds when the mirror has a wide aperture, and in general the reflected rays envelop a caustic (q.v., see also ABBERRATION). The only mirror which can sharply reproduce an object-point as an image-point has for its section an ellipse, which is so placed that the object and image are at its foci. This follows from a property of the curve, viz. the sum of the focal distances is constant, and that the focal vectors are equally inclined to the normal at the point. More important than the elliptical mirror, however, is the parabolic, which has the property of converting rays parallel to the axis into a pencil through its focus; or, inversely, rays from a source placed at the focus are converted into a parallel beam; hence the use of this mirror in search-lights and similar devices.

REFORMATION, THE. The Reformation, as commonly understood, means the religious and political revolution of the 16th century, of which the immediate result was the partial disruption of the Western Catholic Church and the establishment of various national and territorial churches. These agreed in repudiating certain of the doctrines, rites and practices of the medieval Church, especially the sacrifice of the Mass and the headship of the bishop of Rome, and, whatever their official designations, came generally to be known as "Protestant." In some cases they introduced new systems of ecclesiastical organization, and in all they sought to justify their innovations by an appeal from the Church's tradition to the Scriptures. The conflicts between Catholics and Protestants speedily merged into the chronic political rivalries, domestic and foreign, which distracted the European states; and religious considerations played a very important part in diplomacy and war for at least a century and a half, from the diet of Augsburg in 1530 to the English revolution and the league of Augsburg, 1688-89. The terms "Reformation" and "Protestantism" are inherited by the modern historian; they are not of his devising, and come to him laden with reminiscences of all the exalted enthusiasms and bitter antipathies engendered by a period of fervid religious dissension. The unmeasured invective of Luther and Aleander has not ceased to re-echo, and the old issues are by no means dead.

The heat of controversy is, however, abating, and during the past thirty or forty years both Catholic and Protestant investigators have been vying with one another in adding to our knowledge and in rectifying old mistakes; while an ever-increasing number of writers pledged to neither party are aiding in developing an idea of the scope and nature of the Reformation which differs radically from the traditional one. We now appreciate too thoroughly the intricacy of the medieval Church; its vast range of activity, secular as well as religious; the inextricable interweaving of the civil and ecclesiastical governments; the slow and painful process of their divorce as the old ideas of the proper functions of the two institutions have changed in both Protestant and Catholic lands: we perceive all too clearly the limitations of the reformers, their distrust of reason and criticism—in short, we know too much about medieval institutions and the process of their disintegration longer to see in the Reformation an abrupt break in the general history

of Europe. No one will, of course, question the importance of the schism which created the distinction between Protestants and Catholics, but it must always be remembered that the religious questions at issue comprised a relatively small part of the whole compass of human aspirations and conduct, even to those to whom religion was especially vital, while a large majority of the leaders in literature, art, science and public affairs went their way seemingly almost wholly unaffected by theological problems.

That the religious elements in the Reformation have been greatly overestimated from a modern point of view can hardly be questioned, and one of the most distinguished students of Church history has ventured the assertion that "The motives, both remote and proximate, which led to the Lutheran revolt were largely secular rather than spiritual." "We may," continues Mr H. C. Lea, "dismiss the religious changes incident to the Reformation with the remark that they were not the object sought, but the means for attaining the object. The existing ecclesiastical system was the practical evolution of dogma, and the overthrow of dogma was the only way to obtain permanent relief from the intolerable abuses of that system" (*Cambridge Modern History*, i. 653). It would perhaps be nearer the truth to say that the secular and spiritual interests intermingled and so permeated one another that it is almost impossible to distinguish them clearly even in thought, while in practice they were so bewilderingly confused that they were never separated, and were constantly mistaken for one another.

The first step in clarifying the situation is to come to a full realization that the medieval Church was essentially an international state, and that the character of the Protestant secession from it was largely determined by this fact.

As Maitland suggests: "We could frame no acceptable definition of a State which would not comprehend the Church. What has it not that a State should have? It has laws, law givers, law courts, lawyers. It uses physical force to compel men to obey the laws. It keeps prisons. In the 13th century, though with squeamish phrases, it pronounced sentence of death. It is no voluntary society; if people are not born into it they are baptized into it when they cannot help themselves. If they attempt to leave they are guilty of *crimen laesae majestatis*, and are likely to be burned. It is supported by involuntary contributions, by tithe and tax" (*Canon Law in the Church of England*, p. 100). The Church was not only organized like a modern bureaucracy, but performed many of the functions of a modern State. It dominated the intellectual and profoundly affected the social interests of western Europe. Its economic influence was multiform and incalculable, owing to its vast property, its system of taxation and its encouragement of monasticism. When Luther made his first great appeal to the German people in his *Address to the German Nobility*, he scarcely adverts to religious matters at all. He deals, on the contrary, almost exclusively with the social, financial, educational, industrial and general moral problems of the day. If Luther, who above all others had the religious issue ever before him, attacks the Church as a source of worldly disorder, it is not surprising that his contemporary Ulrich von Hutten should take a purely secular view of the issues involved. Moreover, in the fascinating collection of popular satires and ephemeral pamphlets made by Schade, one is constantly impressed with the absence of religious fervour, and the highly secular nature of the matters discussed. The same may be said of the various *Gravamina*, or lists of grievances against the papacy drafted from time to time by German diets.

But not only is the character of the Reformation differently conceived from what it once was; our notions of the process of change are being greatly altered. Formerly, writers accounted for the Lutheran movement by so magnifying the horrors of the pre-existing regime that it appeared intolerable, and its abolition consequently inevitable. Protestant writers once contented themselves with a brief caricature of the Church,

Resemblance of the medieval Church to the State.

Historic continuity of the Reformation.

a superficial account of the traffic in indulgences, and a rough and ready assumption, which even Köstlin makes, that the darkness was greatest just before the dawn. Unfortunately this crude solution of the problem proved too much; for conditions were no worse immediately before the revolt than they had been for centuries, and German complaints of papal tyranny go back to Hildegard of Bingen and Walther von der Vogelweide, who antedated Luther by more than three centuries. So a new theory is logically demanded to explain why these conditions, which were chronic, failed to produce a change long before it actually occurred. Singularly enough it is the modern Catholic scholars, Johannes Janssen above all, who, in their efforts further to discredit the Protestant revolt by rehabilitating the institutions which the reformers attacked, have done most to explain the success of the Reformation. A humble, patient Bohemian priest, Hasak, set to work toward half a century ago to bring together the devotional works published during the seventy years immediately succeeding the invention of printing. Every one knows that one at least of these older books, *The German Theology*, was a great favourite of Luther's; but there are many more in Hasak's collection which breathe the same spirit of piety and spiritual emulation. Building upon the foundations laid by Hasak and other Catholic writers who have been too much neglected by Protestant historians, Janssen produced a monumental work in defence of the German Church before Luther's defection. He exhibits the great achievements of the latter part of the 15th and the early portion of the 16th centuries; the art and literature, the material prosperity of the towns and the fostering of the spiritual life of the people. It may well be that his picture is too bright, and that in his obvious anxiety to prove the needlessness of an ecclesiastical revolution he has gone to the opposite extreme from the Protestants. Yet this rehabilitation of pre-Reformation Germany cannot but make a strong appeal to the unbiased historical student who looks to a conscientious study of the antecedents of the revolt as furnishing the true key to the movement.

Outwardly the Reformation would seem to have begun when, on the 10th of December 1520, a professor in the university of Wittenberg invited all the friends of evangelical truth among his students to assemble outside the wall at the ninth hour to witness a pious spectacle—the burning of the "godless book of the papal decrees." He committed to the flames the whole body of the canon law, together with an edict of the head of the Church which had recently been issued against his teachings. In this manner Martin Luther, with the hearty sympathy of a considerable number of his countrymen, publicly proclaimed and illustrated his repudiation of the papal government under which western Europe had lived for centuries. Within a generation after this event the states of north Germany and Scandinavia, England, Scotland, the Dutch Netherlands and portions of Switzerland, had each in its particular manner permanently seceded from the papal monarchy. France, after a long period of uncertainty and disorder, remained faithful to the bishop of Rome. Poland, after a defection of years, was ultimately recovered for the papacy by the zeal and devotion of the Jesuit missionaries. In the Habsburg hereditary dominions the traditional policy and Catholic fervour of the ruling house resulted, after a long struggle, in the restoration of the supremacy of Rome; while in Hungary the national spirit of independence kept Calvinism alive to divide the religious allegiance of the people. In Italy and Spain, on the other hand, the rulers, who continued loyal to the pope, found little difficulty in suppressing any tendencies of revolt on the part of the few converts to the new doctrines. Individuals, often large groups, and even whole districts, had indeed earlier rejected some portions of the Roman Catholic faith, or refused obedience to the ecclesiastical government; but previously to the burning of the canon law by Luther no prince had openly and permanently cast off his allegiance to the international

ecclesiastical state of which the bishop of Rome was head. Now, a prince or legislative assembly that accepted the doctrine of Luther, that the temporal power had been "ordained by God for the chastisement of the wicked and the protection of the good" and must be permitted to exercise its functions "unhindered throughout the whole Christian body, without respect to persons, whether it strikes popes, bishops, priests, monks, nuns, or whoever else"—such a government could proceed to ratify such modifications of the Christian faith as appealed to it in a particular religious confession; it could order its subject to conform to the innovations, and could expel, persecute or tolerate dissenters, as seemed good to it. A "reformed" prince could seize the property of the monasteries, and appropriate such ecclesiastical foundations as he desired. He could make rules for the selection of the clergy, disregarding the ancient canons of the Church and the claims of the pope to the right of ratification. He could cut off entirely all forms of papal taxation and put an end to papal jurisdiction. The personnel, revenue, jurisdiction, ritual, even the faith of the Church, were in this way placed under the complete control of the territorial governments. This is the central and significant fact of the so-called Reformation. Wholly novel and distinctive it is not, for the rulers of Catholic countries, like Spain and France, and of England (before the publication of the Act of Supremacy) could and did limit the pope's claims to unlimited jurisdiction, patronage and taxation, and they introduced the *placet* forbidding the publication within their realms of papal edicts, decisions and orders, without the express sanction of the government—in short, in many ways tended to approach the conditions in Protestant lands. The Reformation was thus essentially a stage in the disengaging of the modern state from that medieval, international ecclesiastical state which had its beginning in the *ecclesia* of the Acts of the Apostles. An appreciation of the issues of the Reformation—or Protestant revolt, as it might be more exactly called—depends therefore upon an understanding of the development of the papal monarchy, the nature of its claims, the relations it established with the civil powers, the abuses which developed in it and the attempts to rectify them, the sources of friction between the Church and the government, and finally the process by which certain of the European states threw off their allegiance to the Christian commonwealth, of which they had so long formed a part.

It is surprising to observe how early the Christian Church assumed the form of a state, and how speedily upon entering into its momentous alliance with the Roman imperial government under Constantine it acquired the chief privileges and prerogatives it was so long to retain. In the twelfth century of the Theodosian Code we see the foundations of the medieval Church already laid; for it was the 4th, not the 13th century that established the principle that defection from the Church was a crime in the eyes of the State, and raised the clergy to a privileged class, exempted from the ordinary taxes, permitted under restrictions to try its own members and to administer the wealth which flowed into its coffers from the gifts of the faithful. The bishop of Rome, who had from the first probably enjoyed a leading position in the Church as "the successor of the two most glorious of the apostles," elaborated his claims to be the divinely appointed head of the ecclesiastical organization. Siricius (384-389), Leo the Great (440-461), and Gelasius I. (492-496) left little for their successors to add to the arguments in favour of the papal supremacy. In short, if we recall the characteristics of the Church in the West from the times of Constantine to those of Theodoric—its reliance upon the civil power for favours and protection, combined with its assumption of a natural superiority over the civil power and its innate tendency to monarchical unity—it becomes clear that Gregory VII. in his effort in the latter half of the 11th century to establish the papacy as the great central power of western Europe was in the main only reaffirming and developing old claims in a new world. His brief statement of the papal powers as he

Revolt of the various European governments from the papal monarchy.

Character of the papal monarchy and its claims.

conceived them is found in his *Dictatus*. The bishop of Rome, who enjoys a unique title, that of "pope," may annul the decrees of all other powers, since he judges all but is judged by none. He may depose emperors and absolve the subjects of the unjust from their allegiance. Gregory's position was almost inexpugnable at a time when it was conceded by practically all that spiritual concerns were incalculably more momentous than secular, that the Church was rightly one and indivisible, with one divinely revealed faith and a system of sacraments absolutely essential to salvation. No one called in question the claim of the clergy to control completely all "spiritual" matters. Moreover, the mightiest secular ruler was but a poor sinner dependent for his eternal welfare on the Church and its head, the pope, who in this way necessarily exercised an indirect control over the civil government, which even the emperor Henry IV. and William the Conqueror would not have been disposed to deny. They would also have conceded the pope the right to play the rôle of a secular ruler in his own lands, as did the German bishops, and to dispose of such fiefs as reverted to him. This class of prerogatives, as well as the right which the pope claimed to ratify the election of the emperor, need not detain us, although they doubtless served in the long run to weaken the papal power. But the pope laid claim to a direct power over the civil governments. Nicholas II. (1058-1061) declared that Jesus had conferred on Peter the control (*juris*) of an earthly as well as of a heavenly empire; and this phrase was embodied in the canon law. Innocent III., a century and a half later, taught that James the brother of the Lord left to Peter not only the government of the whole Church, but that of the whole world (*totum seculum gubernandum*).¹ So the power of the pope no longer rested upon his headship of the Church or his authority as a secular prince, but on a far more comprehensive claim to universal dominion. There was no reason why the bishop of Rome should justify such acts as Innocent himself performed in deposing King John of England and later in annulling Magna Carta; or Gregory IV. when he struck out fourteen articles from the *Sachsenspiegel*; or Nicholas V. when he invested Portugal with the right to subjugate all peoples on the Atlantic coast; or Julius II. when he threatened to transfer the kingdom of France to England; or the conduct of those later pontiffs who condemned the treaties of Westphalia, the Austrian constitution of 1867 and the establishment of the kingdom of Italy. The theory and practice of papal absolutism was successfully promulgated by Gratian in his *Decretum*, completed at Bologna about 1142. This was supplemented by later collections composed mainly of papal decretals. (See CANON LAW and DECRETALS, FALSE.) As every fully equipped university had its faculty of canon law in which the *Corpus juris canonici* was studied, Rashdall is hardly guilty of exaggeration when he says: "By means of the happy thought of the Bolognese monk the popes were enabled to convert the new-born universities—the offspring of that intellectual new birth of Europe which might have been so formidable an enemy to the papal pretensions—into so many engines for the propagation of Ultramontane ideas." Thomas Aquinas was the first theologian to describe the Church as a divinely organized absolute monarchy, whose head concentrated in his person the entire authority of the Church, and was the source of all the ecclesiastical law (*conditor juris*), issuing the decrees of general councils in his own name, and claiming the right to revoke or modify the decrees of former councils—indeed, to make exceptions or to set aside altogether anything which did not rest upon the dictates of divine or natural law. In practice the whole of western Europe was subject to the jurisdiction of one tribunal of last resort, the Roman Curia. The pope claimed the right to tax church property throughout Christendom. He was able to exact an oath of fidelity from the archbishops, named many of the bishops, and asserted the right to transfer and dispose them. The organs of this vast monarchy were the papal Curia, which first appears distinctly in the 11th century (see CURIA ROMANA),

¹See further, Innocent III.

and the legates, who visited the courts of Europe as haughty representatives of the central government of Christendom.

It should always be remembered that the law of the Church was regarded by all lawyers in the later middle ages as the law common to all Europe (*jus commune*). The laws of the Carolingian empire provided that one excommunicated by the Church who did not make his peace within a year and a day should be outlawed, and this general principle was not lost sight of. It was a capital offence in the eyes of the State to disagree with the teachings of the Church, and these, it must be remembered, included a recognition of the papal supremacy. The civil authorities burnt an obstinate heretic, condemned by the Church, without a thought of a new trial. The emperor Frederick II.'s edicts and the so-called *établissements* of St Louis provide that the civil officers should search out suspected heretics and deliver them to the ecclesiastical judges. The civil government recognized monastic vows by regarding a professed monk as civilly dead and by pursuing him and returning him to his monastery if he violated his pledges of obedience and ran away. The State recognized the ecclesiastical tribunals and accorded them a wide jurisdiction that we should now deem essentially secular in its nature. The State also admitted that large classes of its citizens—the clergy, students, crusaders, widows and the miserable and helpless in general—were justiciable only by Church tribunals. By the middle of the 13th century many lawyers took the degree of doctor of both laws (J.U.D.), civil and canon, and practised both. As is well known, temporal rulers constantly selected clergymen as their most trusted advisers. The existence of this theocratic international state was of course conditioned by the weakness of the civil government. So long as feudal monarchy continued, the Church supplied to some extent the deficiencies of the turbulent and ignorant princes by endeavouring to maintain order, administer justice, protect the weak and encourage learning. So soon as the modern national state began to gain strength, the issue between secular rulers and the bishops of Rome took a new form. The clergy naturally stoutly defended the powers which they had long enjoyed and believed to be rightly theirs. On the other hand, the State, which could count upon the support of an ever-increasing number of prosperous and loyal subjects, sought to protect its own interests and showed itself less and less inclined to tolerate the extreme claims of the pope. Moreover, owing to the spread of education, the king was no longer obliged to rely mainly upon the assistance of the clergy in conducting his government.

The chief sources of friction between Church and State were four in number. First, the growth of the practice of "reservation" and "provision," by which the popes assumed the right to appoint their own nominees to vacant sees and other benefices, in defiance of the claims of the crown, the chapters and private patrons. In the case of wealthy bishoprics or abbacies this involved a serious menace to the secular authority. Both pope and king were naturally anxious to place their own friends and supporters in these influential positions. The pope, moreover, had come to depend to a considerable extent for his revenue upon the payments made by his nominees, which represented a corresponding drain on the resources of the secular states. Secondly, there was the great question, how far the lands and other property of the clergy should be subject to taxation. Was this vast amount of property to increase indefinitely without contribution to the maintenance of the secular government? A decretal of Innocent III. permitted the clergy to make voluntary contributions to the king when there was urgent necessity, and the resources of the laity had proved inadequate. But the pope maintained that, except in the most critical cases, his consent must be obtained for such grants. Thirdly, there was the inevitable jealousy between the secular and ecclesiastical courts and the serious problem of the exact extent of the original and appellate jurisdiction of the Roman Curia. Fourthly, and lastly, there was the most fundamental difficulty of all, the extent to which the pope, as the universally acknowledged head

of the Church, was justified in interfering in the internal affairs of particular states. Unfortunately, most matters could be viewed from both a secular and religious standpoint; and even in purely secular affairs the claims of the pope to at least indirect control were practically unlimited. The specific nature of the abuses which flourished in the papal monarchy, the unsuccessful attempts to remedy them, and the measures taken by the chief European states to protect themselves will become apparent as we hastily review the principal events of the 14th and 15th centuries.

As one traces the vicissitudes of the papacy during the two centuries from Boniface VIII. to Leo X. one cannot fail to be impressed with the almost incredible strength of the ecclesiastical state which had been organized and fortified by Gregory VII., Alexander III., Innocent III. and Gregory IX. In spite of the perpetuation of all the old abuses and the continual appearance of new devices for increasing the papal revenue; in spite of the jealousy of kings and princes, the attacks of legists and the preaching of the heretics; in spite of seventy years of exile from the holy city, forty years of distracting schism and discord, and thirty years of conflict with stately oecumenical councils deliberating in the name of the Holy Spirit and intent upon permanently limiting the papal prerogatives; in spite of the unworthy conduct of some of those who ascended the papal throne, their flagrant political ambitions, and their greed; in spite of the spread of knowledge, old and new, the development of historical criticism, and philosophical speculation; in spite, in short, of every danger which could threaten the papal monarchy, it was still intact when Leo X. died in 1521. Nevertheless, permanent if partial dissolution was at hand, for no one of the perils which the popes had seemingly so successfully overcome had failed to weaken the constitution of their empire; and it is impossible to comprehend its comparatively sudden disintegration without reckoning with the varied hostile forces which were accumulating and combining strength during the 14th and 15th centuries. The first serious conflict that arose between the developing modern state and the papacy centred about the pope's claim that the property of the clergy was normally exempt from royal taxation. Boniface VIII. was forced to permit Edward I. and Philip the Fair to continue to demand and receive subsidies granted by the clergy of their realms. Shortly after the bitter humiliation of Boniface by the French government and his death in 1303, the bishop of Bordeaux was elected pope as Clement V. (1305). He preferred to remain in France, and as the Italian cardinals died they were replaced by Frenchmen. The papal court was presently established at Avignon, on the confines of France, where it remained until 1377. While the successors of Clement V. were not so completely under the control of the French kings as has often been alleged, the very proximity of the curia to France served inevitably to intensify national jealousies. The claims of John XXII. (1316-1334) to control the election of the emperor called forth the first fundamental and critical attack on the papal monarchy, by Marsiglio of Padua, who declared in his *Defensor pacis* (1324) that the assumed supremacy of the bishop of Rome was without basis, since it was very doubtful if Peter was ever in Rome, and in any case there was no evidence that he had transmitted any exceptional prerogatives to succeeding bishops. But Marsiglio's logical and elaborate justification for a revolt against the medieval Church produced no perceptible effects. The removal of the papal court from Rome to Avignon, however, not only reduced its prestige but increased the pope's chronic financial embarrassments, by cutting off the income from his own dominions, which he could no longer control, while the unsuccessful wars waged by John XXII., the palace building and the notorious luxury of some of his successors, served enormously to augment the expenses. Various devices were resorted to, old and new, to fill the treasury. The fees of the Curia were raised for the numberless favours, dispensations, absolutions, and exemptions of all kinds which were sought by clerics and laymen. The right claimed by the

pope to fill benefices of all kinds was extended, and the amount contributed to the pope by his nominees amounted to from a third to a half of the first year's revenue (see ANNATES). Boniface VIII. had discovered a rich source of revenue in the jubilee, and in the jubilee indulgences extended to those who could not come to Rome. Clement VI. reduced the period between these lucrative occasions from one hundred to fifty years, and Urban VI. determined in 1389 that they should recur at least once in a generation (every thirty-three years). Church offices, high and low, were regarded as investments from which the pope had his commission.

England showed itself better able than other countries to defend itself against the papal control of church preferment. From 1343 onward, statutes were passed by parliament forbidding any one to accept a papal provision, and cutting off all appeals to the papal curia or ecclesiastical courts in cases involving benefices. Nevertheless, as a statute of 1379 complains, benefices continued to be given "to divers people of another language and of strange lands and nations, and sometimes to actual enemies of the king and of his realm, which never made residence in this same, nor cannot, may not, nor will not in any wise bear and perform the charges of the same benefice in hearing confessions, preaching or teaching the people." When, in 1365, Innocent VI. demanded that the arrears of the tribute promised by King John to the pope should be paid up, parliament abrogated the whole contract on the ground that John had no right to enter into it. A species of anti-clerical movement, which found an unworthy leader in John of Gaunt, developed at this time. The Good Parliament of 1376 declared that, in spite of the laws restricting papal provisions, the popes at Avignon received five times as much revenue from England as the English kings themselves. Secularization was mentioned in parliament. Wycliffe began his public career in 1366 by proving that England was not bound to pay tribute to the pope. Twelve years later he was, like Marsiglio, attacking the very foundations of the papacy itself, as lacking all scriptural sanction. He denounced the papal government as utterly degraded, and urged that the vast property of the Church, which he held to be the chief cause of its degradation, should be secularized and that the clergy should consist of "poor priests," supported only by tithes and alms. They should preach the gospel and encourage the people to seek the truth in the Scriptures themselves, of which a translation into English was completed in 1382. During the later years of his life he attacked the doctrine of transubstantiation, and all the most popular institutions of the Church—indulgences, pilgrimages, invocation of the saints, relics, celibacy of the clergy, auricular confession, &c. His opinions were spread abroad by the hundreds of sermons and popular pamphlets written in English for the people (see WYCLIFFE). For some years after Wycliffe's death his followers, the Lollards, continued to carry on his work; but they roused the effective opposition of the conservative clergy, and were subjected to a persecution which put an end to their public agitation. They rapidly disappeared and, except in Bohemia, Wycliffe's teachings left no clearly traceable impressions. Yet the discussions he aroused, the attacks he made upon the institutions of the medieval Church, and especially the position he assigned to the Scriptures as the exclusive source of revealed truth, serve to make the development of Protestantism under Henry VIII. more explicable than it would otherwise be.

Wycliffe's later attacks upon the papacy had been given point by the return of the popes to Rome in 1377 and the opening of the Great Schism which was to endure for forty years. There had been many anti-popes in the past, but never before had there been such prolonged and genuine doubt as to which of two lines of popes was legitimate, since in this case each was supported by a college of cardinals, the one at Rome, the other at Avignon. Italy, except Naples, took the side of the Italian pope; France, of the Avignon pope; England, in its hostility to France,

The papacy in the 14th century.

England and the papacy in the 14th century.

The Great Schism (1377-1417).

sided with Urban VI. in Rome, Scotland with Clement VII., his rival; Flanders followed England; Urban secured Germany, Hungary and the northern kingdoms; while Spain, after remaining neutral for a time, went over to Clement. Western Christendom had now two papal courts to support. The schism extended down to the bishoprics, and even to the monasteries and parishes, where partisans of the rival popes struggled to obtain possession of sees and benefices. The urgent necessity for healing the schism, the difficulty of uniting the colleges of cardinals, and the prolonged and futile negotiations carried on between the rival popes inevitably raised the whole question of the papal supremacy, and led to the search for a still higher ecclesiastical authority, which, when the normal system of choosing the head of the Church broke down, might re-establish that ecclesiastical unity to which all Europe as yet clung. The idea of the supreme power on earth of a general council of Christendom, deliberating in the name of the Holy Spirit, convoked, if necessary, independently of the popes, was defended by many, and advocated by the university of Paris. The futile council of Pisa in 1409, however, only served to increase to three the number of rival representatives of God on earth. The considerable pamphlet literature of the time substantiates the conclusion of an eminent modern Catholic historian, Ludwig Pastor, who declares that the crisis through which the church passed in this terrible period of the schism was the most serious in all its history. It was at just this period, when the rival popes were engaged in a life-and-death struggle, that heretical movements appeared in England, France, Italy, Germany, and especially in Bohemia, which threatened the whole ecclesiastical order.

The council of Constance assembled in 1414 under auspices hopeful not only for the extinction of the schism but for the general reform of the Church. Its members showed no patience with doctrinal innovations, even such moderate ones as John Huss represented. They turned him over to the secular arm for execution, although they did not thereby succeed in checking the growth of heresy in Bohemia (see HUSS). The healing of the schism proved no very difficult matter; but the council hoped not only to restore unity and suppress heresy, but to re-establish general councils as a regular element in the legislation of the Church. The decree *Sacrosancta* (April 1415) proclaimed that a general council assembled in the Holy Spirit and representing the Catholic Church militant had its power immediately from Christ, and was supreme over every one in the Church, not excluding the pope, in all matters pertaining to the faith and reformation of the Church of God in head and members. The decree *Frequens* (October 1417) provided for the regular convocation of councils in the future. As to ecclesiastical abuses the council could do very little, and finally satisfied itself with making out a list of those which the new pope was required to remedy in co-operation with the deputies chosen by the council. The list serves as an excellent summary of the evils of the papal monarchy as recognized by the unimpeachably orthodox. It included: the number, character and nationality of the cardinals, the abuse of the "reservations" made by the apostolic see, the annates, the collation to benefices, expectative favours, cases to be brought before the papal Curia (including appeals), functions of the papal chancery and penitentiary, benefices in *commendam*, confirmation of elections, income during vacancies, indulgences, tenths, for what reasons and how is a pope to be corrected or deposed. The pope and the representatives of the council made no serious effort to remedy the abuses suggested under these several captions; but the idea of the superiority of a council over the pope, and the right of those who felt aggrieved by papal decisions to appeal to a future council, remained a serious menace to the theory of papal absolutism. The decree *Frequens* was not wholly neglected; though the next council, at Siena, came to naught, the council at Basel, whose chief business was to put an end to the terrible religious war that

had been raging between the Bohemians and Germans, was destined to cause Eugenius IV. much anxiety. It reaffirmed the decree *Sacrosancta*, and refused to recognize the validity of a bull Eugenius issued in December 1431 dissolving it. Two years later political reverses forced the pope to sanction the existence of the council, which not only concluded a treaty with the Bohemian heretics but abolished the papal fees for appointments, confirmation and consecration—above all, the annates—and greatly reduced papal reservations; it issued indulgences, imposed tenths, and established rules for the government of the papal states. France, however, withdrew its support from the council, and in 1438, under purely national auspices, by the famous Pragmatic Sanction of Bourges, adjusted the relations of the Gallican Church to the papacy; and Eugenius soon found himself in a position to repudiate the council and summoned a new one to assemble in 1438 at Ferrara under his control to take up the important question of the pending union with the Greek Church. The higher clergy deserted the council of Basel, and left matters in the hands of the lower clergy, who chose an anti-pope; but the rump council gradually lost credit and its lingering members were finally dispersed. The various nations were left to make terms with a reviving papacy. England had already taken measures to check the papal claims. France in the Pragmatic Sanction reformulated the claim of the councils to be superior to the pope, as well as the decision of the council of Basel in regard to elections, annates and other dues, limitations on ecclesiastical jurisdiction, and appeals to the pope. While the canonical elections were re-established, the prerogatives of the crown were greatly increased, as in England. In short, the national ecclesiastical independence of the French Church was established. The German diet of Regensburg (1439) ratified in the main the decrees of the council of Basel, which clearly gratified the electors, princes and prelates; and Germany for the first time joined the ranks of the countries which subjected the decrees of the highest ecclesiastical instance to the *placet* or approval of the civil authorities. But there was no strong power, as in England and France, to attend to the execution of the provisions.

In 1448 Eugenius's successor, Nicholas V., concluded a concordat with the emperor Frederick III. as representative of the German nation. This confined itself to papal appointments and the annates. In practice it restored the former range of papal reservations, and extended the papal right of appointment to all benefices (except the higher offices in cathedrals and collegiate churches) which fell vacant during the odd months. It also accorded him the right to confirm all newly elected prelates and to receive the annates. Nothing was said in the concordat of a great part of the chief subjects of complaint. This gave the princes an excuse for the theory that the decrees of Constance and Basel were still in force, limiting the papal prerogatives in all respects not noticed in the concordat. It was Germany which gave the restored papacy the greatest amount of anxiety during the generation following the dissolution of the council of Basel. In the "recesses" or formal statements issued at the conclusion of the sessions of the diet one can follow the trend of opinion among the German princes, secular and ecclesiastical. The pope is constantly accused of violating the concordat, and constant demands are made for a general council, or at least a national one, which should undertake to remedy the abuses. The capture of Constantinople by the Turks afforded a new excuse for papal taxation. In 1453 a crusading bull was issued imposing a tenth on all benefices of the earth to equip an expedition against the infidel. The diet held at Frankfort in 1456 recalled the fact that the council of Constance had forbidden the pope to impose tenths without the consent of the clergy in the region affected, and that it was clear that he proposed to "pull the German sheep's fleece over its ears." A German correspondent of Aeneas Sylvius assures him in 1457 that "thousands of tricks are devised by the Roman see which enables it to extract the money from our pockets very

The councils of Constance and Basel.

Germany and the papacy in the 15th century.

neatly, as if we were mere barbarians. Our nation, once so famous, is a slave now, who must pay tribute, and has lain in the dust these many years bemoaning her fate." Aeneas Sylvius issued, immediately after his accession to the papacy as Pius II, the bull *Execrabilis* forbidding all appeals to a future council. This seemed to Germany to cut off its last hope. It found a spokesman in the vigorous Gregory of Heimburg, who accused the pope of issuing the bull so that he and his cardinals might conveniently pillage Germany unhampered by the threat of a council. "By forbidding appeals to a council the pope treats us like slaves, and wishes to take for his own pleasures all that we and our ancestors have accumulated by honest labour. He calls me a chatterer, although he himself is more talkative than a magpie." Heimburg's denunciations of the pope were widely circulated, and in spite of the major excommunication he was taken into the service of the archbishop of Mainz and was his representative at the diet of Nuremberg in 1462. It is thus clear that motives which might ultimately lead to the withdrawal of a certain number of German princes from the papal ecclesiastical state were accumulating and intensifying during the latter half of the 15th century.

It is impossible to review here the complicated political history of the opening years of the 16th century. The names of Charles VIII. and Louis XII. of France, of Ferdinand and Isabella of Spain, of Henry VII. and Henry VIII. of England, of Maximilian the German king, of Popes Alexander VI., Julius II. and Leo X., stand for better organized civil governments, with growing powerful despotic heads; for a perfectly worldly papacy absorbed in the interests of an Italian principality, engaged in constant political negotiations with the European powers which are beginning to regard Italy as their chief field of rivalry, and are using its little states as convenient counters in their game of diplomacy and war. It was in Germany, however, seemingly the weakest and least aggressive of the European states, that the first permanent and successful revolts against the papal monarchy occurred. Nothing came of the lists of German *gravamina*, or of the demands for a council, so long as the incompetent Frederick III. continued to reign. His successor, Maximilian, who was elected emperor in 1493, was mainly preoccupied with his wars and attempts to reform the constitution of the empire; but the diet gave some attention to ecclesiastical reform. For instance, in 1501 it took measures to prevent money raised by the granting of a papal indulgence from leaving the country. After the disruption of the league of Cambray, Maximilian, like Louis XII., was thrown into a violent anti-curial reaction, and in 1510 he sent to the well-known humanist, Joseph Wimpfeling, a copy of the French Pragmatic Sanction, asking his advice and stating that he had determined to free Germany from the yoke of the Curia and prevent the great sums of money from going to Rome. Wimpfeling in his reply rehearsed the old grievances and complained that the contributions made to the pope by the archbishops on receiving the pallium was a great burden on the people. He stated that that of the archbishop of Mainz had been raised from ten to twenty-five thousand gulden, and that there had been seven vacancies within a generation, and consequently the subjects of the elector had been forced to pay that amount seven times. But Wimpfeling had only some timid suggestions to make, and, since Maximilian was once more on happy terms with the pope, political considerations served to cool completely his momentary ardour for ecclesiastical reform. In 1514 the archbishopric of Mainz fell vacant again, and Albert of Brandenburg, already archbishop of Magdeburg and administrator of Halberstadt, longing to add it to his possessions, was elected. After some scandalous negotiations with Leo X. it was arranged that Albert should pay 14,000 ducats for the papal confirmation and 10,000 as a "composition" for permission to continue to hold, against the rules of the Church, his two former archbishoprics. Moreover, in order to permit him to pay the sums, he was to have half the proceeds in his provinces from an indulgence

granted to forward the rebuilding of St Peter's. A Dominican monk, Johann Tetzel, was selected to proclaim the indulgence (together with certain supplementary graces) in the three provinces of the elector. This suggestion came from the curia, not the elector, whose representatives could not suppress the fear that the plan would arouse opposition and perhaps worse. Tetzel's preaching and the exaggerated claims that he was reported to be making for the indulgences attracted the attention of an Augustinian friar, Martin Luther, who had for some years been lecturing on theology at the university of Wittenberg. He found it impossible to reconcile Tetzel's views of indulgences with his own fundamental theory of salvation. He accordingly hastily drafted ninety-five propositions relating to indulgences, and posted an invitation to those who wished to attend a disputation in Wittenberg on the matter, under his presidency. He points out the equivocal character of the word *penitentia*, which meant both "penance" and "penitence"; he declared that "true contrition seeks punishment, while the amplex of pardons relaxes it and causes men to hate it." Christians ought to be taught that he who gives to a poor man or lends to the needy does better than if he bought pardons. He concludes with certain "keen questionings of the laity," as, Why does not the pope empty purgatory forthwith for charity's sake, instead of cautiously for money? Why does he not, since he is rich as Croesus, build St Peter's with his own money instead of taking that of poor believers? It was probably these closing reflections which led to the translation of the theses from Latin into German, and their surprising circulation. It must not be assumed that Luther's ninety-five theses produced any considerable direct results. They awakened the author himself to a consciousness that his doctrines were after all incompatible with some of the Church's teachings, and led him to consider the nature of the papal power which issued the indulgence. Two or three years elapsed before Luther began to be generally known and to exercise a perceptible influence upon affairs.

In July 1518 a diet assembled in Augsburg to consider the new danger from the Turks, who were making rapid conquests under Sultan Selim I. The pope's representative, The diet of Cardinal Cajetan, made it clear that the only safety Augsburg or 1518. lay in the collection of a tenth from the clergy of a twentieth from laymen; but the diet appointed a committee to consider the matter and explain why they proposed to refuse the pope's demands. Protests urging the diet not to weaken came in from all sides. There was an especially bitter denunciation of the Curia by some unknown writer. He claims that "the pope bids his collectors go into the whole world, saying, 'He that believeth, and payeth the tenths, shall be saved.'" But it is not necessary to stand in such fear of the thunder of Christ's vicar, but rather to fear Christ Himself, for it is the Florentine's business, not Christ's, that is at issue." The report of the committee of the diet was completed on the 27th of August 1518. It reviews all the abuses, declares that the German people are the victims of war, devastation and death, and that the common man is beginning to comment on the vast amount of wealth that is collected for expeditions against the Turk through indulgences or otherwise, and yet no expedition takes place. This is the first recognition in the official *gravamina* of the importance of the people. Shortly after the committee submitted its report the clergy of Liège presented a memorial which, as the ambassador from Frankfort observed, set forth in the best Latin all the various forms of rascality of which the *curtisanen* (i.e. *curiales*, officials of the curia) were guilty. From this time on three new streams begin to reinforce the rather feeble current of official efforts for reform. The common man, to whom the diet of Augsburg alludes, had long been raising his voice against the "parsons" (*Pfaffen*); the men of letters, Brand, Erasmus, Reuchlin, and above all Ulrich von Hutten, contributed, each in their way, to discredit the Roman Curia; and lastly, a new type of theology, represented chiefly by Martin Luther, threatened to sweep away the very foundations of the papal monarchy.

The growing discontent of the poor people, whether in country or town, is clearly traceable in Germany during the 15th century, and revolutionary agitation was chronic in southern Germany at least during the first two decades of the 16th. The clergy were satirized and denounced in popular pamphlets and songs. The tithe was an oppressive form of taxation, as were the various fees demanded for the performance of the sacraments. The

Hostility of the masses to the clergy in Germany.

so-called "Reformation of Sigismund," drawn up in 1438, had demanded that the celibacy of the clergy should be abandoned and their excessive wealth reduced. "It is a shame which cries to heaven, this oppression by tithes, dues, penalties, excommunication, and tolls of the peasant, on whose labour all men depend for their existence." In 1476 a poor young shepherd drew thousands to Nicklashausen to hear him denounce the emperor as a rascal and the pope as a worthless fellow, and urge the division of the Church's property among the members of the community. The "parsons" must be killed, and the lords reduced to earn their bread by daily labour. An apocalyptic pamphlet of 1508 shows on its cover the Church upside down, with the peasant performing the services, while the priest guides the plough outside and a monk drives the horses. Doubtless the free peasants of Switzerland contributed to stimulate disorder and discontent, especially in southern Germany. The conspiracies were repeatedly betrayed and the guilty parties terribly punished. That discovered in 1517 made a deep impression on the authorities by reason of its vast extent, and doubtless led the diet of Augsburg to allude to the danger which lay in the refusal of the common man to pay the ecclesiastical taxes. "It was into this mass of seething discontent that the spark of religious protest fell—the one thing needed to fire the train and kindle the social conflagration. This was the society to which Luther spoke, and its discontent was the sounding board which made his words reverberate."¹

On turning from the attitude of the peasants and poorer townspeople to that of the scholars, we find in their writings

a good deal of harsh criticism of the scholastic theology, satirical allusions to the friars, and, in Germany, sharp denunciations of the practices of the Curia. But there are many reasons for believing that the older estimate

of the influence of the so-called Renaissance, or "new learning," in promoting the Protestant revolt was an exaggerated one. The class of humanists which had grown up in Italy during the 15th century, and whose influence had been spreading into Germany, France and England during the generation immediately preceding the opening of the Protestant revolt, represented every phase of religious feeling from mystic piety to cynical indifference, but there were very few anti-clericals among them. The revival of Greek from the time of Chrysoloras onward, instead of begetting a Hellenistic spirit, transported the more serious-minded to the nebulous shores of Neo-Platonism, while the less devout became absorbed in scholarly or literary ambitions, translations, elegantly phrased letters, clever epigrams or indiscriminate invective. It is true that Lorenzo Valla (d. 1457) showed the Donation of Constantine to be a forgery, denied that Dionysius the Areopagite wrote the works ascribed to him, and refuted the commonly accepted notion that each of the apostles had contributed a sentence to the Apostles' Creed. But such attacks were rare and isolated and were not intended to effect a breach in the solid ramparts of the medieval Church, but rather to exhibit the ingenuity of the critic. In the libraries collected under humanistic influences the patristic writers, both Latin and Greek, and the scholastic doctors are conspicuous. Then most of the humanists were clerics, and in Italy they enjoyed the patronage of the popes. They not unnaturally showed a tolerant spirit on the whole toward existing institutions, including the ecclesiastical abuses, and, in general, cared little how long the vulgar herd was left in the superstitious darkness which befitted their estate, so long as the superior man was permitted to hold discreetly any views he pleased. Of this attitude Mutian (1471-1526),

¹Lindsay.

the German humanist who perhaps approached most nearly the Italian type, furnishes a good illustration. He believed that Christianity had existed from all eternity, and that the Greeks and Romans, sharing in God's truth, would share also in the celestial joys. Forms and ceremonies should only be judged as they promoted the great object of life, a clean heart and a right spirit, love to God and one's neighbour. He defined faith as commonly understood to mean "not the conformity of what we say with fact, but an opinion 'upon divine things founded upon credulity which seeks after profit.'" "With the cross," he declares, "we put our foes to flight, we extort money, we consecrate God, we shake hell, we work miracles."

These reflections were, however, for his intimate friends, and like him, his much greater contemporary, Erasmus, abhorred anything suggesting open revolt or revolution. The extraordinary popularity of Erasmus is a sufficient indication that his attitude of mind was viewed with sympathy by the learned, whether in France, England, Germany, Spain or Italy. He was a firm believer in the efficacy of culture. He maintained that old prejudices would disappear with the progress of knowledge, and that superstition and mechanical devices of salvation would be insensibly abandoned. The laity should read their New Testament, and would in this way come to feel the true significance of Christ's life and teachings, which, rather than the Church, formed the centre of Erasmus's religion. The dissidence of dissent, however, filled him with uneasiness, and he abhorred Luther's denial of free will and his exaggerated notion of man's utter depravity; in short, he did nothing whatever to promote the Protestant revolt, except so far as his frank denunciation and his witty arraignment of clerical and monastic weaknesses and soulless ceremonial, especially in his *Praise of Folly* and *Colloquies*, contributed to bring the faults of the Church into strong relief, and in so far as his edition of the New Testament furnished a simple escape from innumerable theological complications.

Erasmus (1466-1536).

A peculiar literary feud in Germany served, about 1515, to throw into sharp contrast the humanistic party, which had been gradually developing during the previous fifty years, and the conservative, monkish, scholastic group, who found their leader among the Dominicans of the university of Cologne. Johann Reuchlin, a well-known scholar, who had been charged by the Dominicans with heresy, not only received the support of the newer type of scholars, who wrote him encouraging letters which he published under the title *Epistolae clarorum virorum*, but this collection suggested to Crotus Rubianus and Ulrich von Hutten one of the most successful satires of the ages, the *Epistolae obscurorum virorum*. As Creighton well said, the chief importance of the "Letters of Obscure Men" lay in its success in popularizing the conception of a stupid party which was opposed to the party of progress. At the same time that the Neo-Platonists, like Ficino and Pico de la Mirandola, and the pantheists, whose God was little more than a reverential conception of the universe at large, and the purely worldly humanists, like Celtes and Bebel, were widely diverging each by his own particular path from the ecclesiastical *Weltanschauung* of the middle ages, Ulrich von Hutten was busy attacking the Curia in his witty *Dialogues*, in the name of German patriotism. He, at least, among the well-known scholars eagerly espoused Luther's cause, as he understood it. A few of the humanists became Protestants—Melancthon, Bucer, Oecolampadius and others—but the great majority of them, even if attracted for the moment by Luther's denunciation of scholasticism, speedily repudiated the movement. In Socinianism (see below) we have perhaps the only instance of humanistic antecedents leading to the formation of a religious sect.

A new type of theology made its appearance at the opening of the 16th century, in sharp contrast with the Aristotelian scholasticism of the Thomists and Scotists. This was due to the renewed enthusiasm for, and appreciation of, St Paul with which Erasmus sympathized, and which found an able exponent in England in John Colet and in France in Lefèvre of Étampes (Faber Stapulensis). Luther was reaching somewhat similar views at the same time,

The new theology and Martin Luther.

although in a strikingly different manner and with far more momentous results for the western world. Martin Luther was beyond doubt the most important single figure in the Protestant revolt. His influence was indeed by no means so decisive and so pervasive as has commonly been supposed, and his attacks on the evils in the Church were no bolder or more comprehensive than those of Marsiglio and Wycliffe, or of several among his contemporaries who owed nothing to his example. Had the German princes not found it to their interests to enforce his principles, he might never have been more than the leader of an obscure mystic sect. He was, moreover, no statesman. He was recklessly impetuous in his temperament, coarse and grossly superstitious according to modern standards. Yet in spite of all these allowances he remains one of the great heroes of all history. Few come in contact with his writings without feeling his deep spiritual nature and an absolute genuineness and marvellous individuality which seem never to sink into mere routine or affectation. In his more important works almost every sentence is alive with that autochthonic quality which makes it unmistakably his. His fundamental religious conception was his own hard-found answer to his own agonized question as to the nature and assurance of salvation. Even if others before him had reached the conviction that the Vulgate's word *justitia* in Romans i. 16-17 meant "righteousness" rather than "justice" in a juridical sense, Luther exhibited supreme religious genius in his interpretation of "God's righteousness" (*Gerechtigkeit*) as over against the "good works" of man, and in the overwhelming importance he attached to the promise that the just shall live by faith. It was his anxiety to remove everything that obscured this central idea which led him to revolt against the ancient Church, and this conception of faith served, when he became leader of the German Protestants, as a touchstone to test the expediency of every innovation. But only gradually did he come to realize that his source of spiritual consolation might undermine altogether the artfully constructed fabric of the medieval Church. As late as 1516 he declared that the life of a monk was never a more enviable one than at that day. He had, however, already begun to look sourly upon Aristotle and the current scholastic theology, which he believed hid the simple truth of the gospel and the desperate state of mankind, who were taught a vain reliance upon outward works and ceremonies, when the only safety lay in throwing oneself on God's mercy. He was suddenly forced to take up the consideration of some of the most fundamental points in the orthodox theology by the appearance of Tetzel in 1517. In his hastily drafted Ninety-five Theses he sought to limit the potency of indulgences, and so indirectly raised the question as to the power of the pope. He was astonished to observe the wide circulation of the theses both in the Latin and German versions. They soon reached Rome, and a Dominican monk, Prierius, wrote a reply in defence of the papal power, in an insolent tone which first served to rouse Luther's suspicion of the theology of the papal Curia. He was summoned to Rome, but, out of consideration for his patron, the important elector of Saxony, he was permitted to appear before the papal legate during the diet of Augsburg in 1518. He boldly contradicted the legate's theological statements, refused to revoke anything and appealed to a future council. On returning to Wittenberg, he turned to the canon law, and was shocked to find it so completely at variance with his notions of Christianity. He reached the conclusion that the papacy was but four hundred years old. Yet, although of human origin, it was established by common consent and with God's sanction, so that no one might withdraw his obedience without offence.

It was not, however, until 1520 that Luther became in a sense the leader of the German people by issuing his three great pamphlets, all of which were published in German as well as in Latin—his *Address to the Christian Nobility of the German Nation*, his *Babylonish Captivity of the Church*, and his *Freedom of the Christian*. In the first he urged that, since the Church had failed to reform itself, the secular government should come to the rescue. "The Romanists have with great

dexterity built themselves about with three walls, which have hitherto protected them against reform; and thereby is Christianity fearfully fallen. In the first place, when the temporal power has pressed them hard, they have affirmed and maintained that the temporal power has no jurisdiction over them—that, on the contrary, the spiritual is above the temporal. Secondly, when it was proposed to admonish them from the Holy Scriptures they said, 'It becometh no one but the pope to interpret the Scriptures,' and, thirdly, when they were threatened with a council, they invented the idea that no one but the pope can call a council. Thus they have secretly stolen our three rods that they may go unpunished, and have entrenched themselves safely behind these three walls in order to carry on all the rascality and wickedness that we now see."

He declares that the distinction between the "spiritual estate," composed of pope, bishops, priests and monks, as over against the "temporal estate" composed of princes, lords, artisans and peasants, is a very fine hypocritical invention of which no one should be afraid. "A cobbler, a smith, a peasant, every man has his own calling and duty, just like the consecrated priests and bishops, and every one in his calling or office must help and serve the rest, so that all may work together for the common good." After overthrowing the other two walls, Luther invites the attention of the German rulers to the old theme of the pomp of the pope and cardinals, for which the Germans must pay. "What the Romanists really mean to do, the 'drunken Germans' are not to see until they have lost everything. . . . If we rightly hang thieves and behead robbers, why do we leave the greed of Rome unpunished? for Rome is the greatest thief and robber that has ever appeared on earth, or ever will; and all in the holy names of the Church and St Peter." After proving that the secular rulers were free and in duty bound to correct the evils of the Church, Luther sketches a plan for preventing money from going to Italy, for reducing the number of idle, begging monks, harmful pilgrimages and excessive holidays. Luxury and drinking were to be suppressed, the universities, especially the divinity schools, reorganized, &c.

Apart from fundamental rejection of the papal supremacy, there was little novel in Luther's appeal. It had all been said before in the various protests of which we have spoken, and very recently by Ulrich von Hutten in his *Dialogues*, but no one had put the case so strongly, or so clearly, before. In addressing the German nobility Luther had refrained from taking up theological or religious doctrines; but in September 1520 he attacked the whole sacramental system of the medieval Church in his *Babylonish Captivity of the Church*. Many reformers, like Glapion, the Franciscan confessor of Charles V., who had read the *Address* with equanimity if not approval, were shocked by Luther's audacity in rejecting the prevailing fundamental religious conceptions. Luther says: "I must begin by denying that there are seven sacraments, and I may lay down for the time being that there are only three—baptism, penance and the bread, and that by the court of Rome all these have been brought into miserable bondage, and the Church despoiled of her liberty." It is, however, in the *Freedom of the Christian* that the essence of Luther's religion is to be found. Man cannot save himself, but is saved then and there so soon as he believes God's promises, and to doubt these is the supreme crime. So salvation was to him not a painful progress toward a goal to be reached by the sacraments and by right conduct, but a state in which man found himself so soon as he despaired absolutely of his own efforts, and threw himself on God's assurances. Man's utter incapacity to do anything to please God, and his utter personal dependence on God's grace seemed to render the whole system of the Church well-nigh gratuitous even if it were purged of all the "sophistry" which to Luther seemed to bury out of sight all that was essential in religion. Luther's gospel was one of love and confidence, not of fear and trembling, and came as an overwhelming revelation to those who understood and accepted it.

The old question of Church reform inevitably reappeared

when the young emperor Charles V. opened his first imperial diet at Worms early in 1521, and a committee of German princes drafted a list of *gravamina*, longer and bitter than any preceding one. While the resolute papal nuncio Aleander was indefatigable in his efforts to induce the diet to condemn Luther's teachings, his curious and instructive despatches to the Roman Curia complain constantly of the ill-treatment and insults he encountered, of the readiness of the printers to issue innumerable copies of Luther's pamphlets and of their reluctance to print anything in the pope's favour. Charles apparently made up his mind immediately and once for all. He approved the *gravamina*, for he believed a thorough reform of the Church essential. This reform he thought should be carried out by a council, even against the pope's will; and he was destined to engage in many fruitless negotiations to this end before the council of Trent at last assembled a score of years later. But he had no patience with a single monk who, led astray by his private judgment, set himself against the faith held by all Christians for a thousand years. "What my forefathers established at the council of Constance and other councils it is my privilege to maintain," he exclaims. Although, to Aleander's chagrin, the emperor consented to summon Luther to Worms, where he received a species of ovation, Charles readily approved the edict drafted by the papal nuncio, in which Luther is accused of having "brought together all previous heresies in one stinking mass," rejecting all law, teaching a life wholly brutish, and urging the lay people to bathe their hands in the blood of priests. He and his adherents were outlawed; no one was to print, sell or read any of his writings, "since they are foul, harmful, suspected, and come from a notorious and stiff-necked heretic." The edict of Worms was entirely in harmony with the laws of Western Christendom, and there were few among the governing classes in Germany at that time who really understood or approved Luther's fundamental ideas; nevertheless—if we except the elector of Brandenburg, George of Saxony, the dukes of Bavaria, and Charles V.'s brother Ferdinand—the princes, including the ecclesiastical rulers and the towns, commonly neglected to publish the edict, much less to enforce it. They were glad to leave Luther unmolested in order to spite the "Curtizanen," as the adherents of the papal Curia were called. The emperor was forced to leave Germany immediately after the diet had dissolved, and was prevented by a succession of wars from returning for nearly ten years. The governing council, which had been organized to represent him in Germany, fell rapidly into disrepute, and exercised no restraining influence on those princes who might desire to act on Luther's theory that the civil government was supreme in matters of Church reform.

The records of printing indicate that religious, social and economic betterment was the subject of an ever-increasing

number of pamphlets. The range of opinion was wide. Men like Thomas Murner, for instance, heartily denounced "the great Lutheran fool," but at the same time bitterly attacked monks and priests, and popularized the conception of the simple man with the hoe (Karsthans). Hans Sachs, on the other hand, sang the praises of the "Wittenberg Nightingale," and a considerable number of prominent men of letters accepted Luther as their guide—Zell and Bucer, in Strassburg, Eberlin in Ulm, Oecolampadius in Augsburg, Osiander and others in Nuremberg, Pellicanus in Nördlingen. Moreover, there gradually developed a group of radicals who were convinced that Luther had not the courage of his convictions. They proposed to abolish the "idolatry" of the Mass and all other outward signs of what they deemed the old superstitions. Luther's colleague at Wittenberg, Carlstadt (*q.v.*), began denouncing the monastic life, the celibacy of the clergy, the veneration of images; and before the end of 1521 we find the first characteristic outward symptoms of Protestantism. Luther had meanwhile been concealed by his friends in the Wartburg, near Eisenach, where he busied himself with a new German translation of the New Testament, to be followed in a few years by the Old Testament. The

Bible had long been available in the language of the people, and there are indications that the numerous early editions of the Scriptures were widely read. Luther, however, possessed resources of style which served to render his version far superior to the older one, and to give it an important place in the development of German literature, as well as in the history of the Protestant churches. During his absence two priests from parishes near Wittenberg married; while several monks, throwing aside their cowls, left their cloisters. Melancthon, who was for a moment carried away by the movement, partook, with several of his students, of the communion under both kinds, and on Christmas Eve a crowd invaded the church of All Saints, broke the lamps, threatened the priests and made sport of the venerable ritual. Next day, Carlstadt, who had laid aside his clerical robes, dispensed the Lord's Supper in the "evangelical fashion." At this time three prophets arrived from Zwickau, eager to hasten the movement of emancipation. They were weavers who had been associated with Thomas Münzer, and like him looked forward to a very radical reform of society. They rejected infant baptism, and were among the forerunners of the Anabaptists.

In January 1522, Carlstadt induced the authorities of Wittenberg to publish the first evangelical church ordinance. The revenues from ecclesiastical foundations, as well as those from the industrial guilds, were to be placed in a common chest, to be in charge of the townsmen and the magistrates. The priests were to receive fixed salaries; begging, even by monks and poor students, was prohibited; the poor, including the monks, were to be supported from the common chest. The service of the Mass was modified, and the laity were to receive the elements in both kinds. Reminders of the old religious usages were to be done away with, and fast days were to be no longer observed. These measures, and the excitement which followed the arrival of the radicals from Zwickau, led Luther to return to Wittenberg in March 1522, where he preached a series of sermons attacking the impatience of the radical party, and setting forth clearly his own views of what the progress of the Reformation should be. "The Word created heaven and earth and all things; the same Word will also create now, and not we poor sinners. Faith must be unconstrained and must be accepted without compulsion. To marry, to do away with images, to become monks and nuns, or for monks and nuns to leave their convent, to eat meat on Friday or not to eat it, and other like things—all these are open questions, and should not be forbidden by any man. . . . What we want is the heart, and to win that we must preach the gospel. Then the Word will drop into one heart to-day and to-morrow into another, and so will work that each will forsake the Mass." Luther succeeded in quieting the people both in Wittenberg and the neighbouring towns, and in preventing the excesses which had threatened to discredit the whole movement.

In January 1522, Leo X. had been succeeded by a new pope, Adrian VI., a devout Dominican theologian, bent on reforming the Church, in which, as he injudiciously confessed through his legate to the diet at Nuremberg, the Roman Curia had perhaps been the chief source

of "that corruption which had spread from the head to the members." The Lutheran heresy he held to be God's terrible judgment on the sins of the clergy. The diet refused to accede to the pope's demand that the edict of Worms should be enforced, and recommended that a Christian council should be summoned in January, to include not only ecclesiastics but laymen, who should be permitted freely to express their opinions. While the diet approved the list of abuses drawn up at Worms, it ordered that Luther's books should no longer be published, and that Luther himself should hold his peace, while learned men were to admonish the erring preachers. The decisions of this diet are noteworthy, since they probably give a very fair idea of the prevailing opinion of the ruling classes in Germany. They refused to regard Luther as in any way their leader, or even to recognize him as a discreet

The Protestant Revolt begins in Saxony, 1522.

person. On the other hand, they did not wish to take the risk of radical measures against the new doctrines, and were glad of an excuse for refusing the demands of the pope. Adrian soon died, worn out by his futile attempts to correct the abuses at home, and was followed by Clement VII., a Medici, less gifted but not less worldly in his instincts than Leo X.

Clement sent one of his ablest Italian diplomatists, Campeggio, to negotiate with the diet which met at Spires in 1524.

He induced the diet to promise to execute the edict of Worms as far as that should be possible; but it was generally understood that it was impossible. The diet renewed the demand for a general council to meet in a German town to settle the affairs of the Church in Germany, and even proposed the convocation of a national council at Spires in November, to effect a temporary adjustment. In this precarious situation Campeggio, realizing the hopelessness of his attempt to induce all the members of the diet to co-operate with him in re-establishing the pope's control, called together at Regensburg a certain number of rulers whom he believed to be rather more favourably disposed toward the pope than their fellows. These included Ferdinand, duke of Austria, the two dukes of Bavaria, the archbishops of Salzburg and Trent, the bishops of Bamberg, Spires, Strassburg and others. He induced these to unite in opposing the Lutheran heresy on condition that the pope would issue a decree providing for some of the most needed reforms. There was to be no more financial oppression on the part of the clergy, and no unseemly payments for performing the church services. Abuses arising from the granting of indulgences were to be remedied, and the excessive number of church holidays, which seriously interfered with the industrial welfare of Germany, was to be reduced. The states in the Catholic League were permitted to retain for their own uses about one-fifth of the ecclesiastical revenue; the clergy was to be subjected to careful discipline; and only authorized preachers were to be tolerated, who based their teachings on the works of the four Latin Church fathers. Thus the agreement of Regensburg is of great moment in the development of the Protestant revolt in Germany. For Austria, Bavaria and the great ecclesiastical states in the south definitely sided with the pope against Luther's heresies, and to this day they still remain Roman Catholic. In the north, on the other hand, it became more and more apparent that the princes were drifting away from the Roman Catholic Church. Moreover, it should be noted that Campeggio's diplomacy was really the beginning of an effective betterment of the old Church, such as had been discussed for two or three centuries. He met the long-standing and general demand for reform without a revolution in doctrines or institutions. A new edition of the German Bible was issued with the view of meeting the needs of Catholics, a new religious literature grew up designed to substantiate the beliefs sanctioned by the Roman Church and to carry out the movement begun long before toward spiritualizing its institutions and rites.

In 1525 the conservative party, which had from the first feared that Luther's teaching would result in sedition, received a new and terrible proof, as it seemed to them, of the noxious influence of the evangelical preachers. The peasant movements alluded to above, which had caused so much anxiety at the diet of Augsburg in 1518, culminated in the fearful Peasant Revolt in which the common man, both in country and town, rose in the name of "God's justice" to avenge long-standing wrongs and establish his rights. Luther was by no means directly responsible for the civil war which followed, but he had certainly contributed to stir up the ancient discontent. He had asserted that, owing to the habit of foreclosing small mortgages, "any one with a hundred gulden could gobble up a peasant a year." The German feudal lords he pronounced hangmen, who knew only how to swindle the poor man—"such fellows were formerly called scoundrels, but now we must call them 'Christians and

revered princes.'" Yet in spite of this harsh talk about princes, Luther relied upon them to forward the reforms in which he was interested, and he justly claimed that he had greatly increased their powers by reducing the authority of the pope and subjecting the clergy in all things to the civil government.

The best known statement of the peasants' grievances is to be found in the famous "Twelve Articles" drawn up in 1524. They certainly showed the unmistakable influence of the evangelical teaching. The peasants demanded that the gospel should be taught them as a guide in life, and that each community should be permitted to choose its pastor and depose him if he conducted himself improperly. "The pastor thus chosen should teach us the gospel pure and simple, without any addition, doctrine or ordinance of man." The old tithes on grain shall continue to be paid, since that is established by the Old Testament. It will serve to support the pastor, and what is left over shall be given to the poor. Serfdom is against God's word, "since Christ has delivered and redeemed us all without exception, by the shedding of his precious blood, the lowly as well as the great." Protests follow against hunting and fishing rights, restrictions on wood-cutting, and excessive demands made on peasants. "In the twelfth place," the declaration characteristically concluded, "it is our conclusion and final resolution that if one or more of the articles here set forth should not be in agreement with the word of God, as we think they are, such articles will we willingly retract if it be proved by a clear explanation of Scripture really to be against the word of God." More radical demands came from the working classes in the towns. The articles of Heilbronn demanded that the property of the Church should be confiscated and used for the community; clergy and nobility alike were to be deprived of all their privileges, so that they could no longer oppress the poor man. The more violent leaders, like Münzer, renewed the old cry that the parsons must be slain. Hundreds of castles and monasteries were destroyed by the frantic peasantry, and some of the nobles were murdered with shocking cruelty. Luther, who believed that the peasants were trying to cloak their dreadful sins with excuses from the gospel, exhorted the government to put down the insurrection. "Have no pity on the poor folk; stab, smite, throttle, who can!" To him the peasants' attempt to abolish serfdom was wholly unchristian, since it was a divinely sanctioned institution, and if they succeeded they would "make God a liar." The German rulers took Luther's advice with terrible literalness, and avenged themselves upon the peasants, whose lot was apparently worse afterwards than before.

The terror inspired by the Peasant War led to a new alliance, the League of Dessau, formed by some of the leading rulers of central and northern Germany, to stamp out the "accursed Lutheran sect." This included Luther's old enemy, Duke George of Saxony, the electors of Brandenburg and Mainz, and two princes of Brunswick. The rumour that the emperor was planning to return to Germany in order to root out the growing heresy, led a few princes who had openly favoured Luther to unite also. Among these the chief were the new elector of Saxony, John (who, unlike his brother, Frederick the Wise, had openly espoused the new doctrines), and the energetic Philip, landgrave of Hesse. The emperor did not return, and since there was no one to settle the religious question in Germany, the diet of Spires (1526) determined that, pending the meeting of the proposed general council, each prince, and each knight and town owing immediate allegiance to the emperor, should decide individually what particular form of religion should prevail within the limits of their territories. Each prince was "so to live, reign and conduct himself as he would be willing to answer before God and His Imperial Majesty." While the evangelical party still hoped that some form of religion might be agreed upon which would prevent the disruption of the Church, the conservatives were confident that the heretics

*Begin-
ning of the
religious
clef between
the
German
states of
the north
and south
in 1524.*

*Appearance
of an
evan-
gelical
party.*

*The
Peasant
Revolt,
1525.*

would soon be suppressed, as they had so often been in the past. The situation tended to become more, rather than less, complicated, and there was every variety of reformer and every degree of conservatism, for there were no standards for those who had rejected the papal supremacy, and even those who continued to accept it differed widely. For example, George of Saxony viewed Aleander, the pope's nuncio, with almost as much suspicion as he did Luther himself.

The religious ideas in South Germany were affected by the development of a reform party in Switzerland, under the influence of Zwingli, who claimed that at Einsiedeln, near the lake of Zürich, he had begun to preach the gospel of Christ in the year 1516 "before any one in my locality had so much as heard the name of Luther." Three years later he became preacher in the cathedral of Zürich.

Here he began to denounce the abuses in the Church, as well as the traffic in mercenaries which had so long been a blot upon his country's honour. From the first he combined religious and political reform. In 1523 he prepared a complete statement of his beliefs, in the form of sixty-seven theses. He maintained that Christ was the only high priest and that the gospel did not gain its sanction from the authority of the Church. He denied the existence of purgatory, and rejected those practices of the Church which Luther had already set aside. Since no one presented himself to refute him, the town council ratified his conclusions, so that the city of Zürich practically withdrew from the Roman Catholic Church. Next year the Mass, processions and the images of saints were abolished. The shrines were opened and the relics burned. Some other towns, including Bern, followed Zürich's example, but the Forest cantons refused to accept the innovations. In 1525 a religious and political league was arranged between Zürich and Constance, which in the following year was joined by St Gallen, Biel, Mühlhausen, Basel and Strassburg. Philip of Hesse was attracted by Zwingli's energy, and was eager that the northern reformers should be brought into closer relations with the south. But the league arranged by Zwingli was directed against the house of Habsburg, and Luther did not deem it right to oppose a prince by force of arms.

Moreover, he did not believe that Zwingli, who conceived the eucharist to be merely symbolical in its character, "held the whole truth of God." Nevertheless, Philip of Hesse finally arranged a religious conference in the castle of Marburg (1520) where Zwingli and Luther met. They were able to agree on fourteen out of the fifteen "Marburg Articles," which stated the chief points in the Christian faith as they were accepted by both. A fundamental difference as to the doctrine of the eucharist, however, stood in the way of the real union.

The diet of Spire (1520) had received a letter from the emperor directing it to look to the enforcement of the edict of Worms against the heretics. No one was to preach against the Mass, and no one was to be prevented from attending it freely. This meant that the evangelical princes would be forced to restore the most characteristic Catholic rite. As they formed only a minority in the diet, they could only draw up a protest, which was signed by John Frederick of Saxony, Philip of Hesse, and fourteen of the three towns, including Strassburg, Nuremberg and Ulm. In this they claimed that the majority had no right to abrogate the stipulations of the former diet of Spire, which permitted each prince to determine religious matters provisionally for himself, for all had unanimously pledged themselves to observe that agreement. They therefore appealed to the emperor and to a future council against the tyranny of the majority. Those who signed this appeal were called *Protestants*, a name which came to be generally applied to those who rejected the supremacy of the pope, the Roman Catholic conceptions of the clergy and of the Mass, and discarded sundry practices of the older Church, without, however, repudiating the Catholic creeds.

The diet of Spire, 1520, and the "Protestants."

During the period which had elapsed since the diet of Worms, the emperor had resided in Spain, busy with a series of wars, waged mainly with the king of France.¹ In 1530 the emperor found himself in a position to visit Germany once more, and summoned the diet to meet at Augsburg, with the hope of settling the religious differences and bringing about harmonious action against the Turk.

The diet and confession of Augsburg, 1530.

The Protestants were requested to submit a statement of their opinions, and on June 25th the "Augsburg Confession" was read to the diet. This was signed by the elector of Saxony and his son and successor, John Frederick, by George, margrave of Brandenburg, two dukes of Lüneburg, Philip of Hesse and Wolfgang of Anhalt, and by the representatives of Nuremberg and Reutlingen. The confession was drafted by Melancthon, who sought consistently to minimize the breach which separated the Lutherans from the old Church. In the first part of the confession the Protestants seek to prove that there is nothing in their doctrines at variance with those of the universal Church "or even of the Roman Church so far as that appears in the writings of the Fathers." They made it clear that they still held a great part of the beliefs of the medieval Church, especially as represented in Augustine's writings, and repudiated the radical notions of the Anabaptists and of Zwingli. In the second part, those practices of the Church are enumerated which the evangelical party rejected; the celibacy of the clergy, the Mass, as previously understood, auricular confession, and monastic vows, the objections to which are stated with much vigour. "Christian perfection is this: to fear God sincerely, to trust assuredly that we have, for Christ's sake, a gracious and merciful God; to ask and look with confidence for help from him in all our affairs, accordingly to our calling, and outwardly to do good works diligently, and to attend to our vocation. In these things doth true perfection and a true worship of God consist. It doth not consist in going about begging, or in wearing a black or a grey cowl." The Protestant princes declared that they had no intention of depriving the bishops of their jurisdiction, but this one thing only is requested of them, "that they would suffer the gospel to be purely taught, and would relax a few observances in which we cannot adhere without sin."

The confession was turned over to a committee of conservative theologians, including Eck, Faber and Cochlaeus. Their refutation of the Protestant positions seemed needlessly sharp to the emperor, and five drafts were made of it. Charles finally reluctantly accepted it, although he would gladly have had it milder, for it made reconciliation hopeless. The majority of the diet approved a recess, allowing the Protestants a brief period of immunity until the 15th of April 1531, after which they were to be put down by force. Meanwhile, they were to make no further innovations, they were not to molest the conservatives, and were to aid the emperor in suppressing the doctrines of Zwingli and of the Anabaptists. The Lutheran princes protested, together with fourteen cities, and left the diet. The diet thereupon decided that the edict of Worms should at last be enforced. All Church property was to be restored, and, perhaps most important of all, the jurisdiction of the Imperial court (*Reichskammergericht*), which was naturally Catholic in its sympathies, was extended to appeals involving the seizure of ecclesiastical benefices, contempt of episcopal decisions and other matters deeply affecting the Protestants. In November the Protestants formed the Schmalkaldic League, which, after the death of Zwingli, in 1531, was joined by a number of the South German towns. The period of immunity assigned to the Protestants passed by; but they were left unmolested, for the emperor was involved in many difficulties, and the Turks were threatening Vienna. Consequently, at the diet of Nuremberg (1532) a recess was drafted indefinitely extending the religious truce and quashing such cases in the *Reichskammergericht* as involved Protestant

Events of course in Germany, 1531-1540.

¹ In 1527 the pope's capital was sacked by Charles's army. This was, of course, but an incident in the purely political relations of the European powers with the pope, and really has no bearing upon the progress of the Protestant revolt.

innovations. The conservatives refused to ratify the recess, which was not published, but the Protestant states declared that they would accept the emperor's word of honour, and furnished him with troops for repelling the Mahomedans. The fact that the conservative princes, especially the dukes of Bavaria, were opposed to any strengthening of the emperor's power, and were in some cases hereditary enemies of the house of Habsburg, served to protect the Protestant princes. In 1534 the Schmalkaldic League succeeded in restoring the banished duke of Württemberg, who declared himself in favour of the Lutheran reformation, and thus added another to the list of German Protestant states. In 1539 George of Saxony died, and was succeeded by his brother Henry, who also accepted the new faith, and in the same year the new elector of Brandenburg became a Protestant. Indeed, there was reason to believe at this time that the archbishops of Mainz, Trier and Cologne, as well as some other bishops, were planning the secularization of their principalities.

To the north, Lutheran influence had spread into Denmark; Sweden and Norway were also brought within its sphere. Christian II. of Denmark, a nephew of the elector of Saxony, came to the throne in 1513, bent on bringing Sweden and Norway, over which he nominally ruled in accordance with the terms of the Union of Kalmar (1397), completely under his control. In order to do this it was necessary to reduce the power of the nobility and clergy, privileged classes exempt from taxation and rivals of the royal power. Denmark had suffered from all the abuses of papal provisions, and the nuncio of Leo X. had been forced in 1518 to flee from the king's wrath. Christian II. set up a supreme court for ecclesiastical matters, and seemed about to adopt a policy similar to that later pursued by Henry VIII. of England, when his work was broken off by a revolt which compelled him to leave the country. Lutheranism continued to make rapid progress, and Christian's successor permitted the clergy to marry, appropriated the annates and protected the Lutherans. Finally Christian III., an ardent Lutheran, ascended the throne in 1536; with the sanction of the diet he severed, in 1537, all connexion with the pope, introducing the Lutheran system of Church government and accepting the Augsburg Confession.¹ Norway was included in the changes, but Sweden had won its independence of Denmark, under Gustavus Vasa, who, in 1523, was proclaimed king. He used the Lutheran theories as an excuse for overthrowing the ecclesiastical aristocracy, which had been insolently powerful in Sweden. In 1527, supported by the diet, he carried his measures for secularizing such portions of the Church property as he thought fit, and for subjecting the Church to the royal power (Ordinances of Vesterås); but many of the old religious ceremonies and practices were permitted to continue, and it was not until 1592 that Lutheranism was officially sanctioned by the Swedish synod.²

Charles V., finding that his efforts to check the spread of the religious schism were unsuccessful, resorted once more to conferences between Roman Catholic and Lutheran theologians, but it became apparent that no permanent compromise was possible. The emperor then succeeded in disrupting the Schmalkaldic League by winning over, on purely political grounds, Philip of Hesse and young Maurice of Saxony, whose father, Henry, had died after a very brief reign. Charles V. had always exhibited the greatest confidence in the proposed general council, the summoning of which had hitherto been frustrated by the popes, and at last, in 1545, the council was summoned to meet at Trent, which lay conveniently upon the confines of Italy and Germany (see TRENT, COUNCIL OF). The Dominicans and, later, members of the newly born Order of Jesus, were conspicuous, among the

theological deputies, while the Protestants, though invited, refused to attend. It was clear from the first that the decisions of the council would be uncompromising in character, and that the Protestants would certainly refuse to be bound by its decrees. And so it fell out. The very first anathemas of the council were directed against those innovations which the Protestants had most at heart. The emperor had now tried threats, conferences and a general council, and all had failed to unify the Church.

Maurice of Saxony, without surrendering his religious beliefs, had become the political friend of the emperor, who had promised him the neighbouring electorate of Saxony. John Frederick, the elector, was defeated at Mühlberg, April 1547, and taken prisoner. Philip of Hesse also surrendered, and Charles tried once more to establish a basis of agreement. Three theologians, including a conservative Lutheran, were chosen to draft the so-called "Augsburg Interim." This reaffirmed the seven sacraments, transubstantiation and the invocation of saints, and declared the pope head of the Church, but adopted Luther's doctrine of justification by faith in a conditional way, as well as the marriage of priests, and considerably modified the theory and practice of the Mass. For four years Charles, backed by the Spanish troops, made efforts to force the Protestant towns to observe the Interim, but with little success. He rapidly grew extremely unpopular, and in 1552 Maurice of Saxony turned upon him and attempted to capture him at Innsbruck. Charles escaped, but Maurice became for the moment leader of the German princes who gathered at Passau (August 1552) to discuss the situation. The settlement, however, was deferred for the meeting of the diet, which took place at Augsburg, 1555. There was a general anxiety to conclude a peace—"beständiger, beharrlicher, unbedingter, für und für ewig währender." There was no other way but to legalize the new faith in Germany, but only those were to be tolerated who accepted the Augsburg Confession. This excluded, of course, not only the Zwinglians and Anabaptists, but the ever-increasing Calvinistic or "Reformed" Church. The principle *cujus regio ejus religio* was adopted, according to which each secular ruler might choose between the old faith and the Lutheran. His decision was to bind all his subjects, but a subject professing another religion from his prince was to be permitted to leave the country. The ecclesiastical rulers, however, were to lose their possessions if they abandoned the old faith.³ Freedom of conscience was thus established for princes alone, and their power became supreme in religious as well as secular matters. The Church and the civil government had been closely associated with one another for centuries, and the old system was perpetuated in the Protestant states. Scarcely any one dreamed that individual subjects could safely be left to believe what they would, and permitted, so long as they did not violate the law of the land, freely to select and practise such religious rites as afforded them help and comfort.

During the three or four years which followed the signing of the Augsburg Confession in 1530 and the formation of the Schmalkaldic League, England, while bitterly denouncing and burning Lutheran heretics in the name of the Holy Catholic Church, was herself engaged in severing the bonds which had for well-nigh a thousand years bound her to the Apostolic See. An independent national Church was formed in 1534, which continued, however, for a time to adhere to all the characteristic beliefs of the medieval Catholic Church, excepting alone the headship of the pope. The circumstances which led to the English schism are dealt with elsewhere (see ENGLAND, CHURCH OF), and need be reviewed here only in the briefest manner. There was some heresy in England during the opening decades of the 16th century, survivals of the Lollardy which now and then brought a victim to the stake. There was also the old discontent among the orthodox in regard to the Church's exactions, bad clerics and

The Council of Trent. compromise was possible. The emperor then succeeded in disrupting the Schmalkaldic League by winning over, on purely political grounds, Philip of Hesse and young Maurice of Saxony, whose father, Henry, had died after a very brief reign. Charles V. had always exhibited the greatest confidence in the proposed general council, the summoning of which had hitherto been frustrated by the popes, and at last, in 1545, the council was summoned to meet at Trent, which lay conveniently upon the confines of Italy and Germany (see TRENT, COUNCIL OF). The Dominicans and, later, members of the newly born Order of Jesus, were conspicuous, among the

¹ The episcopal office was retained, but the "succession" broken, the new Lutheran bishops being consecrated by Buggenhagen, who was only in priest's orders.

² The episcopal system and succession were maintained, and the "Mass vestments" (*i.e.* alb and chasuble) remain in use to this day.

³ This so-called "ecclesiastical reservation" was not included in the main peace.

Events
culminat-
ing in the
religious
peace of
Augsburg,
1555.

Religious
situation
in Eng-
land at the
opening of
the 16th
century.

dissolute and lazy monks. Scholars, like Colet, read the New Testament in Greek and lectured on justification by faith before they knew of Luther, and More included among the institutions of Utopia a rather more liberal and enlightened religion than that which he observed around him. Erasmus was read and approved, and his notion of reform by culture no doubt attracted many adherents among English scholars. Luther's works found their way into England, and were read and studied at both Oxford and Cambridge. In May 1521 Wolsey attended a pompous burning of Lutheran tracts in St Paul's churchyard, where Bishop Fisher preached ardently against the new German heresy. Henry VIII. himself stoutly maintained the headship of the pope, and, as is well known, after examining the arguments of Luther, published his *Defence of the Seven Sacraments* in 1521, which won for him from the pope the glorious title of "Defender of the Faith." The government and the leading men of letters and prelates appear therefore to have harboured no notions of revolt before the matter of the king's divorce became prominent in 1527.

Henry's elder brother Arthur, a notoriously sickly youth of scarce fifteen, had been married to Catherine, daughter of Ferdinand and Isabella, but had died less than five months after the marriage (April 1502), leaving doubts as to whether the union had ever been physically consummated. Political reasons dictated an alliance between the young widow and her brother-in-law Henry, prince of Wales, nearly five years her junior; Julius II. was induced reluctantly to grant the dispensation necessary on account of the relationship, which, according to the canon law and the current interpretation of Leviticus xviii. 16, stood in the way of the union. The wedding took place some years later (1509), and several children were born, none of whom survived except the princess Mary. By 1527 the king had become hopeless of having a male heir by Catherine. He was tired of her, and in love with the black-eyed Anne Boleyn, who refused to be his mistress. He alleged that he was beginning to have a horrible misgiving that his marriage with Catherine had been invalid, perhaps downright "incestuous." The negotiations with Clement VII. with the hope of obtaining a divorce from Catherine, the reluctance of the pope to impeach the dispensation of his predecessor Julius II., and at the same time to alienate the English queen's nephew Charles V., the futile policy of Wolsey and his final ruin in 1529 are described elsewhere (see ENGLISH HISTORY; HENRY VIII.; CATHERINE OF ARAGON). The king's agents secured the opinion of a number of prominent universities that his marriage was void, and an assembly of notables, which he summoned in June 1530, warned the pope of the dangers involved in leaving the royal succession in uncertainty, since the heir was not only a woman, but, as it seemed to many, of illegitimate birth.

Henry's next move was to bring a monstrous charge against the clergy, accusing them of having violated the ancient laws *beginning of Eng-* of *praemunire* in submitting to the authority of papal legates (although he himself had ratified the appointment of Wolsey as legate *à latere*). The clergy of the province of Canterbury were fined £100,000 and compelled to declare the king "their singular protector and only supreme lord, and, as far as that is permitted by the law of Christ, the supreme head of the Church and of the clergy." This the king claimed, perhaps with truth, was only a clearer statement of the provisions of earlier English laws. The following year, 1532, parliament presented a petition to the king (which had been most carefully elaborated by the monarch's own advisers) containing twelve charges against the bishops, relating to their courts, fees, injudicious appointments and abusive treatment of heretics, which combined to cause an unprecedented and "marvellous disorder of the godly quiet, peace and tranquillity" of the realm. For the remedy of these abuses parliament turned to the king, "in whom and by whom the only and sole redress, reformation and remedy herein absolutely rests and remains." The ordinaries met these accusations with a lengthy and dignified answer; but this did not satisfy the king, and convocation was compelled on the

15th of May 1532, further to clarify the ancient laws of the land, as understood by the king, in the very brief, very humble and very pertinent document known as the "Submission of the Clergy." Herein the king's "most humble subjects daily orators, and bedesmen" of the clergy of England, in view of his goodness and fervent Christian zeal and his learning far exceeding that of all other kings that they have read of, agree never to assemble in convocation except at the king's summons, and to enact and promulgate no constitution or ordinances except they receive the royal assent and authority. Moreover the existing canons are to be subjected to the examination of a commission appointed by the king, half its members from parliament, half from the clergy, to abrogate with the king's assent such provisions as the majority find do not stand with God's laws and the laws of the realm. This appeared to place the legislation of the clergy, whether old or new, entirely under the monarch's control. A few months later Thomas Cranmer, who had been one of those to discuss sympathetically Luther's works in the little circle at Cambridge, and who believed the royal supremacy would tend to the remedying of grave abuses and that the pope had acted *ultra vires* in issuing a dispensation for the king's marriage with Catherine, was induced by Henry to succeed Warham as archbishop of Canterbury. About the same time parliament passed an interesting and important statute, forbidding, unless the king should wish to suspend the operation of the law, the payment to the pope of the annates. This item alone amounted during the previous forty-six years, the parliament declared, "at the least to eight score thousand pounds, besides other great and intolerable sums which have yearly been conveyed to the said court of Rome by many other ways and means to the great impoverishment of this realm." The annates were thereafter to accrue to the king; and bishops and archbishops were thenceforth, in case the pope refused to confirm them,¹ to be consecrated and invested within the realm. "In like manner as divers other archbishops and bishops have been heretofore in ancient times by sundry the king's most noble progenitors." No censures, excommunications or interdicts with which the Holy Father might vex or grieve the sovereign lord or his subjects, should be published or in any way impede the usual performance of the sacraments and the holding of the divine services. In February parliament discovered that "by divers sundry old authentic histories and chronicles" it was manifest that the realm of England was an empire governed by one supreme head, the king, to whom all sorts and degrees of people—both clergy and laity—ought to bear next to God a natural and humble obedience, and that to him God had given the authority finally to determine all causes and contentions in the realm, "without restraint, or provocation to any foreign princes or potentates of the world." The ancient statutes of the *praemunire* and provisors are recalled and the penalties attached to their violation re-enacted. All appeals were to be tried within the realm, and suits begun before an archbishop were to be determined by him without further appeal. Acting on this, Cranmer tried the divorce case before his court, which declared the marriage with Catherine void and that with Anne Boleyn, which had been solemnized privately in January, valid. The pope replied by ordering Henry under pain of excommunication to put away Anne and restore Catherine, his legal wife, within ten days. This sentence the emperor, all the Christian princes and the king's own subjects were summoned to carry out by force of arms if necessary.

As might have been anticipated, this caused no break in the policy of the English king and his parliament, and a series of famous acts passed in the year 1534 completed and confirmed the independence of the Church of England, which, except during five years under Queen Mary, was thereafter as completely severed from the papal monarchy as the electorate of Saxony or the duchy of Hesse. The payment of annates and of Peter's pence

¹ Cranmer himself had taken the oath of canonical obedience to the Holy See and duly received the pallium.

Secession of England from the papal monarchy, 1534.

was absolutely forbidden, as well as the application to the bishop of Rome for dispensations. The bishops were thereafter to be elected by the deans and chapters upon receiving the king's *congé d'élire* (q.v.). The Act of Succession provided that, should the king have no sons, Elizabeth, Anne's daughter, should succeed to the crown. The brief Act of Supremacy confirmed the king's claim to be reputed the "only supreme head in earth of the Church of England"; he was to enjoy all the honours, dignities, jurisdictions and profits thereunto appertaining, and to have full power and authority to reform and amend all such errors, heresies and abuses, as by any manner of spiritual authority might lawfully be reformed, or amended, most to the pleasure of Almighty God, and the increase of virtue in Christ's religion, "foreign authority, prescription, or any other thing or things to the contrary hereof, notwithstanding." The Treasons Act, terrible in its operation, included among capital offences that of declaring in words or writing the king to be "a heretic, schismatic, tyrant, infidel or usurper." The convocations were required to abjure the papal supremacy by declaring "that the bishop of Rome has not in Scripture any greater jurisdiction in the kingdom of England than any other foreign bishop." The king had now clarified the ancient laws of the realm to his satisfaction, and could proceed to abolish superstitious rites, remedy abuses, and seize such portions of the Church's possessions, especially pious and monastic foundations, as he deemed superfluous for the maintenance of religion.

In spite of the fact that the separation from Rome had been carried out during the sessions of a single parliament, and that there had been no opportunity for a general expression of opinion on the part of the nation, there is no reason to suppose that the majority of the people, thoughtful or thoughtless, were not ready to reconcile themselves to the abolition of the papal supremacy. It seems just as clear that there was no strong evangelical movement, and that Henry's pretty consistent adherence to the fundamental doctrines of the medieval Church was agreeable to the great mass of his subjects. The ten "Articles devised by the Kyng's Highnes Majestie to stablish Christen quietnes" (1536), together with the "Injunctions" of 1536 and 1538, are chiefly noteworthy for their affirmation of almost all the current doctrines of the Catholic Church, except those relating to the papal supremacy, purgatory, images, relics and pilgrimages, and the old rooted distrust of the Bible in the vernacular. The clergy were bidden to exhort their hearers to the "works of charity, mercy and faith, specially prescribed and commanded in Scripture, and not to repose their trust or affiance in any other works devised by men's phantasies beside Scripture; as in wandering to pilgrimages, offering of money, candles or tapers to images or relics, or kissing or licking the same, saying over a number of beads, not understood or minded on, or in such-like superstition." To this end a copy of the whole English Bible was to be set up in each parish church where the people could read it. During the same years the monasteries, lesser and greater, were dissolved, and the chief shrines were despoiled, notably that of St Thomas of Canterbury. Thus one of the most important of all medieval ecclesiastical institutions, monasticism, came to an end in England. Doubtless the king's sore financial needs had much to do with the dissolution of the abbeys and the plundering of the shrines, but there is no reason to suppose that he was not fully convinced that the monks had long outlived their usefulness and that the shrines were centres of abject superstition and ecclesiastical deceit. Henry, however, stoutly refused to go further in the direction of German Protestantism, even with the prospect of forwarding the proposed union between him and the princes of the Schmalkaldic League. An insurrection of the Yorkshire peasants, which is to be ascribed in part to the distress caused by the enclosure of the commons on which they had been wont to pasture their cattle, and in part to the

destruction of popular shrines, may have caused the king to defend his orthodoxy by introducing into parliament in 1539 the six questions. These parliament enacted into the terrible statute of "The Six Articles," in which a felon's death was prescribed for those who obstinately denied transubstantiation, demanded the communion under both kinds, questioned the binding character of vows of chastity, or the lawfulness of private Masses or the expediency of auricular confession. On the 30th of July 1540 three Lutheran clergymen were burned and three Roman Catholics beheaded, the latter for denying the king's spiritual supremacy. The king's ardent desire that diversities of minds and opinions should be done away with and unity be "charitably established" was further promoted by publishing in 1543 *A Necessary Doctrine and Erudition for any Christian Man, set forth by the King's Majesty of England*, in which the tenets of mediæval theology, except for denial of the supremacy of the bishop of Rome and the unmistakable assertion of the supremacy of the king, were once more restated.

Henry VIII. died in January 1547, having chosen a council of regency for his nine-year-old son Edward, the members of which were favourable to further religious innovations. Somerset, the new Protector, strove to govern on the basis of civil liberty and religious tolerance. The first parliament of the reign swept away almost all the species of treasons created during the previous two centuries, the heresy acts, including the Six Articles, all limitations on printing the Scriptures in English and reading and expounding the same—indeed "all and every act or acts of parliament concerning doctrine or matters of religion." These measures gave a great impetus to religious discussion and local innovations. Representatives of all the new creeds hastened from the Continent to England, where they hoped to find a safe and fertile field for the particular seed they had to plant. It is impossible exactly to estimate the influence which these teachers exerted on the general trend of religious opinion in England; in any case, however, it was not unimportant, and the Articles of Religion and official homilies of the Church of England show unmistakably the influence of Calvin's doctrine. There was, however, no such sudden breach with the traditions of the past as characterized the Reformation in some continental countries. Under Edward VI. the changes were continued on the lines laid down by Henry VIII. The old hierarchy continued, but service books in English were substituted for those in Latin, and preaching was encouraged. A royal visitation, beginning in 1547, discovered, however, such a degree of ignorance and illiteracy among the parish clergy that it became clear that preaching could only be gradually given its due place in the services of the Church. Communion under both kinds and the marriage of the clergy were sanctioned, thus gravely modifying two of the fundamental institutions of the medieval Church. A conservative *Book of Common Prayer and Administration of the Sacraments and other Rites and Ceremonies after the Use of the Church of England*—commonly called the First Prayer Book of Edward VI.—was issued in 1549. This was based upon ancient "uses," and represented no revolutionary change in the traditions of the "old religion." It was followed, however, in 1552 by the second Prayer Book, which was destined to be, with some modifications, the permanent basis of the English service. This made it clear that the communion was no longer to be regarded as a propitiatory sacrifice, the names "Holy Communion" and "Lord's Supper" being definitively substituted for "Mass" (q.v.), while the word "altar" was replaced by "table." In the Forty-two Articles we have the basis of Queen Elizabeth's Thirty-nine Articles. Thus during the reign of Edward we have not only the foundations of the Anglican Church laid, but there appears the beginning of those evangelical and puritanical sects which were to become the "dissenters" of the following centuries.

England becomes Protestant under Edward VI., 1547-1553.

With the death of Edward there came a period of reaction lasting for five years. Queen Mary, unshaken in her attachment to the ancient faith and the papal monarchy, was able with the sanction of a subservient parliament to turn back the wheels of ecclesiastical legislation, to restore the old religion, and to reunite the English Church with the papal monarchy; the pope's legate, Cardinal Pole, was primate of all England. Then, the ancient heresy laws having been revived, came the burnings of Rogers, Hooker, Latimer, Ridley, Cranmer and many a less noteworthy champion of the new religion. It would seem as if this sharp, uncompromising reaction was what was needed to produce a popular realization of the contrast between the *Ecclesia Anglicana* of Henry VIII. and Edward VI., and the alternative of "perfect obedience to the See Apostolic."

Elizabeth, who succeeded her sister Mary in 1558, was suspected to be Protestant in her leanings, and her adviser, Cecil, had received his training as secretary of the Protector Somerset; but the general European situation as well as the young queen's own temperament precluded any abrupt or ostentatious change in religious matters. The new sovereign's first proclamation was directed against all such preaching as might lead to contention and the breaking of the common quiet. In 1559 ten of Henry VIII.'s acts were revived. On Easter Sunday the queen ventured to display her personal preference for the Protestant conception of the eucharist by forbidding the celebrant in her chapel to elevate the host. The royal supremacy was reasserted, the title being modified into "supreme governor"; and a new edition of Edward VI.'s second Prayer Book, with a few changes, was issued. The Marian bishops who refused to recognize these changes were deposed and imprisoned, but care was taken to preserve the "succession" by consecrating others in due form to take their places.¹ Four years later the Thirty-nine Articles imposed an official creed upon the English nation. This was Protestant in its general character: in its appeal to the Scriptures as the sole rule of faith (Art. VI.), its repudiation of the authority of Rome (Art. XXXVII.), its definition of the Church (Art. XIX.), its insistence on justification by faith only (Art. XI.) and repudiation of the sacrifice of the Mass (Arts. XXVIII. and XXXI.). As supreme governor of the Church of England the sovereign strictly controlled all ecclesiastical legislation and appointed royal delegates to hear appeals from the ecclesiastical courts, to be a "papist" or to "hear Mass" (which was construed as the same thing) was to risk incurring the terrible penalties of high treason. By the Act of Uniformity (1559) a uniform ritual, the Book of Common Prayer, was imposed upon clergy and laity alike, and no liberty of public worship was permitted. Every subject was bound under penalty of a fine to attend church on Sunday. While there was in a certain sense freedom of opinion, all printers had to seek a licence from the government for every manner of book or paper, and heresy was so closely affiliated with treason that the free expression of thought, whether reactionary or revolutionary, was beset with grave danger.

Attempts to estimate the width of the gulf separating the Church of England in Elizabeth's time from the corresponding institution as it existed in the early years of her father's reign are likely to be gravely affected by personal bias. There is a theory that no sweeping revolution in dogma took place, but that only a few medieval beliefs were modified or rejected owing to the practical abuses to which they had given rise. To Professor A. F. Pollard, for example, "The Reformation in England was mainly a domestic affair, a national protest against national grievances rather than part of a cosmopolitan movement toward doctrinal change" (*Comb. Mod. Hist.* ii. 478-9). This estimate appeals to persons of widely different views and temperaments. It is as grateful to those who, like many "Anglo-Catholics," desire on religious grounds to establish the doctrinal continuity of the Anglican Church with that of the

middle ages, as it is obvious to those who, like W. K. Clifford, perceive in the ecclesiastical organization and its influence nothing more than a perpetuation of demoralizing medieval superstition. The nonconformists have, moreover, never wearied of denouncing the "papistical" conservatism of the Anglican establishment. On the other hand, the impartial historical student cannot compare the Thirty-nine Articles with the contemporaneous canons and decrees of the council of Trent without being impressed by striking contrasts between the two sets of dogmas. Their spirit is very different. The unmistakable rejection on the part of the English Church of the conception of the eucharist as a sacrifice had alone many wide-reaching implications. Even although the episcopal organization was retained, the conception of "tradition," of the conciliar powers, of the "characters" of the priest, of the celibate life, of purgatory, of "good works," &c.—all these serve clearly to differentiate the teaching of the English Church before and after the Reformation. From this standpoint it is obviously unhistorical to deny that England had a very important part in the cosmopolitan movement toward doctrinal change.

The little backward kingdom of Scotland definitely accepted the new faith two years after Elizabeth's accession, and after having for centuries sided with France against England, she was inevitably forced by the Reformation into an alliance with her ancient enemy to the south when they both faced a confederation of Catholic powers. The first martyr of Luther's gospel had been Patrick Hamilton, who had suffered in 1528; but in spite of a number of executions the new ideas spread, even among the nobility. John Knox, who, after a chequered career, had come under the influence of Calvin at Geneva, returned to Scotland for a few months in 1555, and shortly after (1557) that part of the Scottish nobility which had been won over to the new faith formed their first "covenant" for mutual protection. These "Lords of the Congregation" were able to force some concessions from the queen regent. Knox appeared in Scotland again in 1559, and became a sort of second Calvin. He opened negotiations with Cecil, who induced the reluctant Elizabeth to form an alliance with the Lords of the Congregation, and the English sent a fleet to drive away the French, who were endeavouring to keep their hold on Scotland. In 1560 a confession of faith was prepared by John Knox and five companions. This was adopted by the Scottish parliament, with the resolution "the bishops of Rome have no jurisdiction nor authority in this Realm in tymes cuming." The alliance of England and the Scottish Protestants against the French, and the common secession from the papal monarchy, was in a sense the foundation and beginning of Great Britain. Scottish Calvinism was destined to exercise no little influence, not only on the history of England, but on the form that the Protestant faith was to take in lands beyond the seas, at the time scarcely known to the Europeans.

While France was deeply affected during the 16th century by the Protestant revolt, its government never undertook any thoroughgoing reform of the Church. During the *beginnings of the Protestant political party*, the Huguenots, who finally won a *movement in France* toleration which they continued to enjoy until the 17th century revocation of the edict of Nantes in 1685. It was not until 1789 that the French Church of the middle ages lost its vast possessions and was subjected to a fundamental reconstruction by the Civil Constitution of the Clergy (1791).² Yet no summary of

¹In 1795 the National Convention gruffly declared that the Republic would no longer subsidize any form of worship or furnish buildings for religious services. "The law recognizes no minister of religion, and no one is to appear in public with costumes or ornaments used in religious ceremonies." Bonaparte, in the Concordat which he forced upon the pope in 1801, did not provide for the return of any of the lands of the Church which had been sold, but agreed that the government should pay the salaries of bishops and priests, whose appointment it controlled. While the Roman Catholic religion was declared to be that accepted by the majority of Frenchmen, the state subsidized the Reformed Church, those adhering to the Augsburg Confession and the Jewish community. Over a

both faced a confederation of Catholic powers. The first martyr of Luther's gospel had been Patrick Hamilton, who had suffered in 1528; but in spite of a number of executions the new ideas spread, even among the nobility. John Knox, who, after a chequered career, had come under the influence of Calvin at Geneva, returned to Scotland for a few months in 1555, and shortly after (1557) that part of the Scottish nobility which had been won over to the new faith formed their first "covenant" for mutual protection. These "Lords of the Congregation" were able to force some concessions from the queen regent. Knox appeared in Scotland again in 1559, and became a sort of second Calvin. He opened negotiations with Cecil, who induced the reluctant Elizabeth to form an alliance with the Lords of the Congregation, and the English sent a fleet to drive away the French, who were endeavouring to keep their hold on Scotland. In 1560 a confession of faith was prepared by John Knox and five companions. This was adopted by the Scottish parliament, with the resolution "the bishops of Rome have no jurisdiction nor authority in this Realm in tymes cuming." The alliance of England and the Scottish Protestants against the French, and the common secession from the papal monarchy, was in a sense the foundation and beginning of Great Britain. Scottish Calvinism was destined to exercise no little influence, not only on the history of England, but on the form that the Protestant faith was to take in lands beyond the seas, at the time scarcely known to the Europeans.

While France was deeply affected during the 16th century by the Protestant revolt, its government never undertook any thoroughgoing reform of the Church. During the *beginnings of the Protestant political party*, the Huguenots, who finally won a *movement in France* toleration which they continued to enjoy until the 17th century revocation of the edict of Nantes in 1685. It was not until 1789 that the French Church of the middle ages lost its vast possessions and was subjected to a fundamental reconstruction by the Civil Constitution of the Clergy (1791).² Yet no summary of

²In 1795 the National Convention gruffly declared that the Republic would no longer subsidize any form of worship or furnish buildings for religious services. "The law recognizes no minister of religion, and no one is to appear in public with costumes or ornaments used in religious ceremonies." Bonaparte, in the Concordat which he forced upon the pope in 1801, did not provide for the return of any of the lands of the Church which had been sold, but agreed that the government should pay the salaries of bishops and priests, whose appointment it controlled. While the Roman Catholic religion was declared to be that accepted by the majority of Frenchmen, the state subsidized the Reformed Church, those adhering to the Augsburg Confession and the Jewish community. Over a

the Protestant revolt would be complete without some allusion to the contrast between the course of affairs in France and in the neighbouring countries. The French monarchy, as we have seen, had usually succeeded in holding its own against the centralizing tendencies of the pope. By the Pragmatic Sanction of Bourges (1438) it had secured the advantages of the conciliar movement. In 1516, after Francis I. had won his victory at Marignano, Leo X. concluded a new concordat with France, in which, in view of the repudiation of the offensive Pragmatic Sanction, the patronage of the French Church was turned over, with scarce any restriction, to the French monarch, although in another agreement the annates were reserved to the pope. The encroachments—which had begun in the time of Philip the Fair—of the king's lawyers on the ancient ecclesiastical jurisdiction, had reached a point where there was little cause for jealousy on the part of the State. The *placet* had long prevailed, so that the king had few of the reasons, so important in Germany and England, for quarrelling with the existing system, unless it were on religious grounds. France had been conspicuous in the conciliar movement. It had also furnished its due quota of heretics, although no one so conspicuous as Wycliffe or Huss. Marsiglio of Padua had Frenchmen among his sympathizers and helpers. The first prominent French scholar to "preach Christ from the sources" was Jacques Lefèvre of Etaples, who in 1512 published a new Latin translation of the epistles of St Paul. Later he revised an existing French translation of both the New Testament (which appeared in 1523, almost contemporaneously with Luther's German version) and, two years later, the Old Testament. He agreed with Luther in rejecting transubstantiation, and in believing that works without the grace of God could not make for salvation. The centre of Lefèvre's followers was Meaux, and they found an ardent adherent in Margaret of Angoulême, the king's sister, but had no energetic leader who was willing to face the danger of disturbances. Luther's works found a good many readers in France, but were condemned (1521) by both the Sorbonne and the parlement of Paris. The parlement appointed a commission to discover and punish heretics; the preachers of Meaux fled to Strassburg, and Lefèvre's translation of the Bible was publicly burned. A council held at Sens, 1528-29, approved all those doctrines of the old Church which the Protestants were attacking, and satisfied itself with enumerating a list of necessary conservative reforms.

John Calvin and his "Institutes of the Christian Religion."

After a fierce attack on Protestants caused by the mutilation of a statue of the Virgin, in 1528, the king, anxious to conciliate both the German Protestants and anti-papal England, invited some of the reformers of Meaux to preach in the Louvre. An address written by a young man of twenty-four, Jean Cauvin (to become immortal under his Latin name of Calvinus) was read by the rector of the university. It was a defence of the new evangelical views, and so aroused the Sorbonne that Calvin was forced to flee from Paris. In October 1534, the posting of placards in Paris and other towns, containing brutal attacks on the Mass and denouncing the pope and the "vermin" of bishops, priests and monks as blasphemers and liars, produced an outburst of persecution, in which thirty-five Lutherans were burned, while many fled the country. The events called forth from Calvin, who was in Basel, the famous letter to Francis which forms the preface to his *Institutes of the Christian Religion*. In this address he sought to vindicate the high aims of the Protestants, and to put the king on his guard against those mad men who were disturbing his kingdom with their measures of persecution. The *Institutes*, the first great textbook of Protestant theology, was published in Latin in 1536, and soon (1541) in a French version. The original work is much shorter than in its later editions, for, as Calvin says, he wrote learning and learned century elapsed before the Concordat was abrogated by the Separation Law of 1905 which suppressed all government appropriations for religious purposes and vested the control of Church property in "associations for public worship" (*associations cultuelles*), to be composed of from seven to twenty-five members according to the size of the commune.

His address had little effect on the king. The parlements issued a series of edicts against the heretics, culminating in the very harsh general edict of Fontainebleau, sanctioned by the parlement of Paris in 1543. The Sorbonne issued a concise series of twenty-five articles, refuting the *Institutes* of Calvin. This statement, when approved by the king and his council, was published throughout France, and formed a clear test of orthodoxy. The Sorbonne also drew up a list of prohibited books, including those of Calvin, Luther and Melancthon; and the parlement issued a decree against all printing of Protestant literature. The later years of Francis's reign were noteworthy for the horrible massacre of the Waldenses and the martyrdom of fourteen from the group of Meaux, who were burnt alive in 1546. When Francis died little had been done, in spite of the government's cruelty, to check Protestantism, while a potent organ of evangelical propaganda had been developing just beyond the confines of France in the town of Geneva.

In its long struggle with its bishops and with the dukes of Savoy, Geneva had turned to her neighbours for aid, especially to Bern, with which an alliance was concluded in 1526. Two years later Bern formally sanctioned the innovations advocated by the Protestant preachers, and although predominantly German assumed the rôle of protector of the reform party in the Pays de Vaud and Geneva. William Farel, one of the group of Meaux, who had fled to Switzerland and had been active in the conversion of Bern, went to Geneva in 1531. With the protection afforded him and his companions by Bern, and the absence of well-organized opposition on the part of the Roman Catholics, the new doctrines rapidly spread, and by 1535 Farel was preaching in St Pierre itself. After a public disputation in which the Catholics were weakly represented, and a popular demonstration in favour of the new doctrines, the council of Geneva rather reluctantly sanctioned the abolition of the Mass. Meanwhile Bern had declared war on the duke of Savoy, and had not only conquered a great part of the Pays de Vaud, including the important town of Lausanne, but had enabled Geneva to win its complete independence. In the same year (September 1536), as Calvin was passing through the town on his way back to Strassburg after a short visit in Italy, he was seized by Farel and induced most reluctantly to remain and aid him in thoroughly carrying out the Reformation in a city in which the conservative sentiment was still very strong. As there proved to be a large number in the town councils who did not sympathize with the plans of organization recommended by Calvin and his colleagues, the town preachers were, after a year and a half of unsatisfactory labour, forced to leave Geneva. For three years Calvin sojourned in Germany; he signed the Augsburg Confession, joined the friendship of Melancthon and other leading reformers, and took part in the religious conferences of the period. In 1541 he was induced with great difficulty to surrender once more his hopes of leading the quiet life of a scholar, and to return again to Geneva (September 1541), where he spent the remaining twenty-three years of his life. His ideal was to restore the conditions which he supposed prevailed during the first three centuries of the Church's existence; but the celebrated Ecclesiastical Ordinances adopted by the town in 1541 and revised in 1561 failed fully to realize his ideas, which find a more complete exemplification in the regulations governing the French Church later. He wished for the complete independence and self-government of the Church, with the right of excommunication to be used against the ungodly. The Genevan town councils were quite ready to re-enact all the old police regulations common in that age in regard to excessive display, dancing, obscene songs, &c. It was arranged too that town government should listen to the "Consistory," made up of the "Elders," but the Small Council was to choose the members of the Consistory, two of whom should belong to the Small Council, four to the Council of Sixty, and six to the Council of Two Hundred. One of the four town syndics was to preside over its sessions. The Consistory was thus a sort of committee of

Geneva becomes a centre of propaganda.

the councils, and it had no power to inflict civil punishment on offenders. Thus "we ought," as Lindsay says, "to see in the disciplinary powers and punishments of the Consistory of Geneva not an exhibition of the working of the Church organized on the principles of Calvin, but the ordinary procedure of the town council of a medieval city. Their petty punishments and their minute interferences with private life are only special instances of what was common to all municipal rule in the 16th century." This is true of the supreme crime of heresy, which in the notorious case of Servetus was only an expression of rules laid down over a thousand years earlier in the Theodosian Code. Geneva, however, with its most distinguished of Protestant theologians, became a school of Protestantism, which sent its trained men into the Netherlands, England and Scotland, and especially across the border into France. It served too as a place of refuge for thousands of the persecuted adherents of its beliefs. Calvin's book furnished the Protestants not only with a compact and admirably written handbook of theology, vigorous and clear, but with a system of Church government and a code of morals.

After the death of Francis I., his successor, Henry II., set himself even more strenuously to extirpate heresy; a special branch of the parlement of Paris—the so-called *Chambre ardente* (q.v.)—for the trial of heresy cases was established, and the fierce edict of Chateaubriand (June 1551) explicitly adopted many of the expedients of the papal inquisition. While hundreds were imprisoned or burned, Protestants seemed steadily to increase in numbers, and finally only the expostulations of the parlement of Paris prevented the king from introducing the Inquisition in France in accordance with the wishes of the pope and the cardinal of Lorraine. The civil tribunals, however, practically assumed the functions of regular inquisitorial courts, in spite of the objections urged by the ecclesiastical courts. Notwithstanding these measures for their extermination, the French Protestants were proceeding to organize a church in accordance with the conceptions of the early Christian communities as Calvin described them in his *Institutes*. Beginning with Paris, some fifteen communities with their consistories were established in French towns between 1555 and 1560. In spite of continued persecution a national synod was assembled in Paris in 1559, representing at least twelve Protestant churches in Normandy and central France, which drew up a confession of faith and a book of church discipline. It appears to have been from France rather than from Geneva that the Presbyterian churches of Holland, Scotland and the United States derived their form of government. A reaction against the extreme severity of the king's courts became apparent at this date. Du Bourg and others ventured warmly to defend the Protestants in the parlement of Paris in the very presence of the king and of the cardinal of Lorraine. The higher aristocracy began now to be attracted by the new doctrines, or at least repelled by the flagrant power enjoyed by the Guises during the brief reign of Francis II. (1559-1560). Protestantism was clearly becoming inextricably associated with politics of a very intricate sort. The leading members of the Bourbon branch of the royal family, and Gaspard de Coligny, admiral of France, were conspicuous among the converts to Calvinism. Persecution was revived by the Guises; Du Bourg, the brave defender of the Protestants, was burned as a heretic; yet Calvin could in the closing years of his life form a cheerful estimate that some three hundred thousand of his countrymen had been won over to his views. The death of Francis II. enabled Catherine de' Medici, the queen mother, to assert herself against the Guises, and become the regent of her ten-year-old son Charles IX. A meeting of the States General had already been summoned to consider the state of the realm. Michel de l'Hôpital, the chancellor, who opened the assembly, was an advocate of toleration; he deprecated the abusive use of the terms "Lutherans," "Papists" and "Huguenots," and advocated deferring all action until a council should have been called. The deputies of the clergy were naturally conservative, but advocated certain reforms, an abolition of the Concordat, and a re-establishment of the older Pragmatic Sanction. The

noblesse were divided on the matter of toleration, but the *cahiers* (lists of grievances and suggestions for reform) submitted by the Third Estate demanded, besides regular meetings of the estates every five years, complete toleration and a reform of the Church. This grew a little later into the recommendation that the revenues and possessions of the French Church should be appropriated by the government, which, after properly subsidizing the clergy, might hope, it was estimated, that a surplus of twenty-two millions of livres would accrue to the State. Two hundred and thirty years later this plan was realized in the Civil Constitution of the Clergy. The deliberations of 1561 resulted in the various reforms, the suspension of persecution and the liberation of Huguenot prisoners. These were not accorded freedom of worship, but naturally took advantage of the situation to carry on their services more publicly than ever before. An unsuccessful effort was made at the conference of Poissy to bring the two religious parties together; Beza had an opportunity to defend the Calvinistic cause, and Lainez, the general of the Order of Jesus, that of the bishop of Rome. The government remained tolerant toward the movement, and in January 1562 the Huguenots were given permission to hold public services outside the walls of fortified towns and were not forbidden to meet in private houses within the walls. Catherine, who had promoted these measures, cared nothing for the Protestants, but desired the support of the Bourbon princes. The country was Catholic, and disturbances inevitably occurred, culminating in the attack of the duke of Guise and his troops on the Protestants at Vassy, less than two months after the issuing of the edict.

It is impossible to review here the Wars of Religion which distracted France, from the "massacre of Vassy" to the publication of the edict of Nantes, thirty-six years later. Religious issues became more and more dominated by purely political and dynastic ambitions, and the whole situation was constantly affected by the policy of Philip II. and the struggle going on in the Netherlands. Henry IV. was admirably fitted to reunite France once more, and, after a superficial conversion to the Catholic faith, to meet the needs of his former co-religionists, the Huguenots. The edict of Nantes recapitulated and codified the provisions of a series of earlier edicts of toleration, which had come with each truce during the previous generation. Liberty of conscience in religious matters was secured and the right of private worship to those of the "so-called Reformed religion." Public worship was permitted everywhere where it had existed in 1566-1597, in two places within each *bailliage* and *sénéchaussée*, and in the châteaux of the Protestant nobility, with slight restrictions in the case of lower nobility. Protestants were placed upon a political equality and made eligible to all public offices. To ensure these rights, they were left in military control of two hundred towns, including La Rochelle, Montauban and Montpellier. Jealous of their "sharing the State with the king," Richelieu twenty-five years later reduced the exceptional privileges of the Huguenots, and with the advent of Louis XIV. they began to suffer renewed persecution, which the king at last flattered himself had so far reduced their number that in 1685 he revoked the edict of Nantes and reduced the Protestants to the status of outlaws. It was not until 1786 that they were restored to their civil rights, and by the Declaration of the Rights of Man, in 1789, to their religious freedom.

Contemporaneously with the Wars of Religion in France a long and terrible struggle between the king of Spain and his Dutch and Belgian provinces had resulted in the formation of a Protestant state—the United Netherlands, which was destined to play an important rôle in the history of the Reformed religion. Open both to German and French influences, the Netherlands had been the scene of the first executions of Lutherans; they had been a centre of Anabaptist agitation; but Calvinism finally triumphed in the Confession of Dordrecht, 1572, since Calvin's system of church government did not, like

The French Wars of Religion and the edict of Nantes, 1562-1598.

The United Netherlands and their importance in the history of toleration.

Luther's, imply the sympathy of the civil authorities. Charles V. had valiantly opposed the development of heresy in the Netherlands, and nowhere else had there been such numbers of martyrs, for some thirty thousand are supposed to have been put to death during his reign. Under Philip II. it soon became almost impossible to distinguish clearly between the religious issues and the resistance to the manifold tyranny of Philip and his representatives. William of Orange, who had passed through several phases of religious conviction, stood first and foremost for toleration. Indeed, Holland became the home of modern religious liberty, the haven of innumerable free spirits, and the centre of activity of printers and publishers, who asked for no other *imprimatur* than the prospect of intelligent readers.

It is impossible to offer any exhaustive classification of those who, while they rejected the teachings of the old Church, refused at the same time to conform to the particular types of Protestantism which had found favour in the eyes of the princes and been imposed by them on their subjects. This large class of "dissenters" found themselves as little at home under a Protestant as under a Catholic regime, and have until recently been treated with scant sympathy by historians of the Church. Long before the Protestant revolt, simple, obscure people, under the influence of leaders whose names have been forgotten, lost confidence in the official clergy and their sacraments and formed secret organizations of which vague accounts are found in the reports of the 13th-century inquisitors, Rainerus Sacconi, Bernard Gui, and the rest. Their anti-sacerdotalism appears to have been their chief offence, for the inquisitors admit that they were puritanically careful in word and conduct, and shunned all levity. Similar groups are mentioned in the town chronicles of the early 16th century, and there is reason to assume that informal evangelical movements were no new things when Luther first began to preach. His appeal to the Scriptures against the traditions of the Church encouraged a more active propaganda on the part of Balthasar Hubmaier, Carlstadt, Mûnzer, Johann Denk (d. 1527) and others, some of whom were well-trained scholars capable of maintaining with vigour and effect their ideas of an apostolic life as the high road to salvation. Mûnzer dreamed of an approaching millennium on earth to be heralded by violence and suffering, but Hubmaier and Denk were peaceful evangelists who believed that man's will was free and that each had within him an inner light which would, if he but followed it, guide him to God. To them persecution was an outrage upon Jesus's teachings. Luther and his sympathizers were blind to the reasonableness of the fundamental teachings of these "brethren." The idea of adult baptism, which had after 1525 become generally accepted among them, roused a bitterness which it is rather hard to understand nowadays. But it is easy to see that informal preaching to the people at large, especially after the Peasant Revolt, with which Mûnzer had been identified, should have led to a general condemnation, under the name "Anabaptist" or "Catabaptist," of the heterogeneous dissenters who agreed in rejecting the State religion and associated a condemnation of infant baptism with schemes for social betterment. The terrible events in Mûnster, which was controlled for a short time (1533-34) by a group of Anabaptists under the leadership of John of Leiden, the introduction of polygamy (which appears to have been a peculiar accident rather than a general principle), the speedy capture of the town by an alliance of Catholic and Protestant princes, and the ruthless retribution inflicted by the victors, have been cherished by ecclesiastical writers as a choice and convincing instance of the natural fruits of a rejection of infant baptism. Much truer than the common estimate of the character of the Anabaptists is that given in Sebastian Franck's Chronicle: "They taught nothing but love, faith and the crucifixion of the flesh, manifesting patience and humility under many sufferings, breaking bread with one another in sign of unity and love, helping one another with true helpfulness, lending, borrowing, giving, learning to have all things in common, calling each other 'brother.'" Menno

Simons (b. *circa* 1500) succeeded in bringing the scattered Anabaptist communities into a species of association; he discouraged the earlier apocalyptic hopes, inculcated non-resistance, denounced the evils of State control over religious matters, and emphasized personal conversion, and adult baptism as its appropriate seal. The English Independents and the modern Baptists, as well as the Mennonites, may be regarded as the historical continuation of lines of development going back to the Waldensians and the Bohemian Brethren, and passing down through the German, Dutch and Swiss Anabaptists.

The modern scholar as he reviews the period of the Protestant Revolt looks naturally, but generally in vain, for those rationalistic tendencies which become so clear in the latter part of the 17th century. Luther found no intellectual difficulties in his acceptance and interpretation of the Scriptures as God's word, and in maintaining against the Anabaptists the legitimacy of every old custom that was not obviously contrary to the Scriptures. Indeed, he gloried in the inherent and divine unreasonableness of Christianity, and brutally denounced reason as a cunning fool, "a pretty harlot." The number of questions which Calvin failed to ask or eluded by absolutely irrational expedients frees him from any taint of modern rationalism. But in Servetus, whose execution he approved, we find an isolated, feeble revolt against assumptions which both Catholics and Protestants of all shades accepted without question. It is pretty clear that the common accounts of the Renaissance and of the revival of learning grossly exaggerate the influence of the writers of Greece and Rome, for they produced no obvious rationalistic movement, as would have been the case had Plato and Cicero, Lucretius and Lucian, been taken really seriously. Neoplatonism, which is in some respects nearer the Christian patristic than the Hellenic spirit, was as far as the radical religious thinkers of the Italian Renaissance receded. The only religious movement that can be regarded as even rather vaguely the outcome of humanism is the Socinian. Faustus Sozzini, a native of Sienna (1539-1603), much influenced by his uncle Lelio Sozzini, after a wandering, questioning life, found his way to Poland, where he succeeded in uniting the various Anabaptist sects into a species of church, the doctrines of which are set forth in the Confession of Rakow (near Minsk), published in Polish in 1605 and speedily in German and Latin. The Latin edition declares that although this new statement of the elements of the Christian faith differs from the articles of other Christian creeds it is not to be mistaken for a challenge. It does not aim at binding the opinions of men or at condemning to the tortures of hell-fire those who refuse to accept it. *Absit a nobis ea mens, immo amentia.* "We have, it is true, ventured to prepare a catechism, but we force it on no one; we express our opinions, but we coerce no one. It is free to every one to form his own conclusions in religious matters; and so we do no more than set forth the meaning of divine things as they appear to our minds without, however, attacking or insulting those who differ from us. This is the golden freedom of preaching which the holy words of the New Testament so strictly enjoin upon us. . . . Who art thou, miserable man, who would smother and extinguish in others the fire of God's Spirit which it has pleased him to kindle in them?" The Socinian creed sprang from intellectual rather than religious motives. Sufficient reasons could be assigned for accepting the New Testament as God's word and Christ as the Christian's guide. He was not God, but a divine prophet born of a virgin and raised on the third day as the first-fruits of them that slept. From the standpoint of the history of enlightenment, as Harnack has observed, "Socinianism with its systematic criticism (tentative and imperfect as it may now seem) and its rejection of all the assumptions based upon mere ecclesiastical tradition, can scarcely be rated too highly. That modern Unitarianism is all to be traced back to Sozzini and the Rakow Confession need not be assumed. The anti-Trinitarian path was one which opened invitingly before a considerable class of critical minds, seeming as it did to lead out into

a sunny open, remote from the unfathomable depths of mystery and clouds of religious emotion which beset the way of the sincere Catholic and Protestant alike.

The effects of the Protestant secession on the doctrines, organization and practices of the Roman Catholic Church are difficult to estimate, still more so to substantiate. It is clear that the doctrinal conclusions of the council of Trent were largely determined by the necessity of condemning Protestant tenets, and that the result of the council was to give the Roman Catholic faith a more precise form than it would otherwise have had. It is much less certain that the disciplinary reforms which the council, following the example of its predecessors, re-enacted, owed anything to Protestantism, unless indeed the council would have shown itself less intolerant in respect to such innovations as the use of the vernacular in the services had this not smacked of evangelicism. In the matter of the pope's supremacy, the council followed the canon law and Thomas Aquinas, not the decrees of the council of Constance. It prepared the way for the dogmatic formulation of the plenitude of the papal power three centuries later by the council of the Vatican. The Protestants have sometimes taken credit to themselves for the indubitable reforms in the Roman Catholic Church, which by the end of the 16th century had done away with many of the crying abuses against which councils and diets had so long been protesting. But this conservative reformation had begun before Luther's preaching, and might conceivably have followed much the same course had his doctrine never found popular favour or been ratified by the princes.

In conclusion, a word may be said of the place of the Reformation in the history of progress and enlightenment. A "philosopher," as Gibbon long ago pointed out, who asks from what articles of faith above and against reason the early Reformers enfranchised their followers will be surprised at their timidity rather than scandalized by their freedom. They remained severely orthodox in the doctrines of the Fathers—the Trinity, the Incarnation, the plenary inspiration of the Bible—and they condemned those who rejected their teachings to a hell whose fires they were not tempted to extenuate. Although they surrendered transubstantiation, the loss of one mystery was amply compensated by the stupendous doctrines of original sin, redemption, faith, grace and predestination upon which they founded their theory of salvation. They ceased to appeal to the Virgin and saints, and to venerate images and relics, procure indulgences and go on pilgrimages, they deprecated the monastic life, and no longer nourished faith by the daily repetition of miracles, but in the witch persecutions their demology cost the lives of thousands of innocent women. They broke the chain of authority, without, however, recognizing the propriety of toleration. In any attempt to determine the relative importance of Protestant and Catholic countries in promoting modern progress it must not be forgotten that religion is naturally conservative, and that its avowed business has never been to forward scientific research or political reform. Luther and his contemporaries had not in any degree the modern idea of progress, which first becomes conspicuous with Bacon and Descartes, but believed, on the contrary, that the strangling of reason was the most precious of offerings to God. "Free-thinker" and "rationalist" have been terms of opprobrium whether used by Protestants or Catholics. The pursuit of salvation does not subordinate by any means the whole life and ambition of even ardent believers; statesmen, philosophers, men of letters, scientific investigators and inventors have commonly gone their way regardless of the particular form of Christianity which prevailed in the land in which they lived. The Reformation was, fundamentally, then, but one phase, if the most conspicuous, in the gradual decline of the majestic medieval ecclesiastical State, for this decline has gone on in France, Austria, Spain and Italy, countries in which the Protestant revolt against the ancient Church ended in failure.

BIBLIOGRAPHY.—Reference is made here mainly to works dealing with the Reformation as a whole. Only recent books are mentioned, since the older works have been largely superseded owing to modern critical investigations: Thomas M. Lindsay, *A History of the Reformation*, 2 vols. (1906-7), the best general treatment; *The Cambridge Modern History*, vol. i. (1902), chaps. xviii. and xix., vol. ii. (1904), "The Reformation," and vol. iii. (1905), "The Wars of Religion," with very full bibliographies; M. Creighton, *History of the Papacy during the Reformation*, 6 vols. (new ed. 1899-1901). From a Catholic standpoint: L. Pastor, *Geschichte der Päpste seit dem Ausgang des Mittelalters* (1891 sqq.), especially vol. iv. in two parts, 1906-7, and vol. v., 1900. This in course of publication and is being translated into English (8 vols. have appeared, 1891-1908, covering the period 1305-1521); J. Janssen, *History of the German People at the Close of the Middle Ages*, 12 vols., 1896-1907, corresponding to vols. i.-vi. of the German original, in 8 vols., edited by Pastor, 1897-1904. This is the standard Catholic treatment of the Reformation, and is being supplemented by a series of monographs, *Ergänzungen zu Janssens Geschichte des deutschen Volkes*, which have been appearing since 1898 and correspond with the *Protestant Schriften des Vereins für Reformationsgeschichte* (1883 sqq.). F. von Bezold, *Geschichte der deutschen Reformation* (1890), an excellent illustrated account; E. Froelich, *Protestantisches Christentum und Kirche der Neuzeit*, in the series "Kultur der Gegenwart," Teil i. Abt. 4, i. Hälfte, 1905; Charles Beard, *The Reformation of the Sixteenth Century in its Relation to Modern Thought and Knowledge* (The Hibbert Lectures for 1883), and by the same, *Martin Luther*, vol. i. (no more published; 1889); A. Harnack, *History of Dogma* (trans. from the 3rd German edition, vol. vii., 1900); A. E. Berger, *Die Kulturaufgaben der Reformation* (2nd ed., 1908); Thudichum, *Papsttum und Reformation* (1903); "Janus," *The Pope and the Council* (1866), by Dollinger and others, a suggestive if not wholly accurate sketch of the papal claims; W. Maurenbrecher, *Geschichte der katholischen Reformation*, vol. i. (no more published; 1880); J. Haller, *Papsttum und Kirchenreform*, vol. i. (1903) relates to the 14th century; J. Köstlin, *Martin Luther, sein Leben und seine Schriften*, new edition by Kawerau, 2 vols., 1903, the most useful life of Luther; H. Denife, *Luther und Lutherum*, 2 vols. (1904-6), a bitter but learned arraignment of Luther by a distinguished Dominican scholar. H. Boehmer, *Luther im Lichte der neueren Forschungen* (1906), brief and suggestive. *First Principles of the Reformation, the Three Primary Works of Dr Martin Luther*, edited by Wace and Buchheim,—an English translation of the famous pamphlets of 1520. (J. H. R.)*

REFORMATORY SCHOOL, an institution for the industrial training of juvenile offenders, in which they are lodged, clothed and fed, as well as taught. They are to be distinguished from "industrial schools," which are institutions for potential and not actual delinquents. To reformatory schools in England are sent juveniles up to the age of sixteen who have been convicted of an offence punishable with penal servitude or imprisonment. The order is made by the court before which they are tried; the limit of detention is the age of nineteen. Reformatory schools are regulated by the Children Act 1908, which repealed the Reformatory Schools Act 1866, as amended by acts of 1872, 1874, 1891, 1893, 1899 and 1901. See further **JUVENILE OFFENDERS**.

REFORMED CHURCHES, the name assumed by those Protestant bodies who adopted the tenets of Zwingle (and later of Calvin), as distinguished from those of the Lutheran or Evangelical divines. They are accordingly often spoken of as the Calvinistic Churches, Protestant being sometimes used as a synonym for Lutheran. The great difference is in the attitude towards the Lord's Supper, the Reformed or Calvinistic Churches repudiating it not only transubstantiation but also the Lutheran consubstantiation. They also reject the use of crucifixes and other symbols and ceremonies retained by the Lutherans.

Full details of these divergences are given in M. Schneckenburger, *Vergleichende Darstellung des lutherischen und reformierten Lehrbegriffs* (Stuttgart, 1855); G. B. Winer, *Comparative Darstellung* (Berlin, 1866; Eng. tr., Edinburgh, 1873). See also **REFORMATION**; **PRESBYTERIANISM**; **CAMERONIANS**.

REFORMED CHURCH IN AMERICA, until 1867 called officially "The Reformed Protestant Dutch Church in North America," and still popularly called the Dutch Reformed Church, an American Calvinist church, originating with the settlers from Holland in New York, New Jersey and Delaware, the first permanent settlers of the Reformed faith in the New World. Their earliest settlements were at Manhattan, Wallabout and Fort Orange (now Albany), where the West India Company formally established the Reformed Church of Holland.

Their first minister was Jonas Michaelius, pastor in New Amsterdam of the "church in the fort" (now the Collegiate Church of New York City). The second *domine*, Everardus Bogardus (d. 1647), migrated to New York in 1633 with Governor Wouter van Twiller, with whom he quarrelled continually; in the same year a wooden church "in the fort" was built; and in 1642 it was succeeded by a stone building. A minister, John van Mekelenburg (Johannes Megapolensis) migrated to Rensselaerwyck manor in 1642, preached to the Indians—probably before any other Protestant minister—and after 1649 was settled in New Amsterdam. With the access of English and French settlers, Samuel Drisius, who preached in Dutch, German, English and French, was summoned, and he laboured in New Amsterdam and New York from 1652 to 1673. On Long Island John T. Polhemus preached at Flatbush in 1654-76. During Peter Stuyvesant's governorship there was little toleration of other denominations, but the West India Company reversed his intolerant proclamations against Lutherans and Quakers. About 1659 a French and Dutch church was organized in Harlem. The first church in New Jersey, at Bergen, in 1661, was quickly followed by others at Hackensack and Passaic. After English rule in 1664 displaced Dutch in New York, the relations of the Dutch churches there were much less close with the state Church of Holland; and in 1679 (on the request of the English governor of New York, to whom the people of New Castle appealed) a classis was constituted for the ordination of a pastor for the church in New Castle, Delaware. The Dutch strongly opposed the establishment of the Church of England, and contributed largely toward the adoption (in October 1683) of the Charter of Liberties which confirmed in their privileges all churches then "in practice" in the city of New York and elsewhere in the province, but which was repealed by James II. in 1686, when he established the Church of England in New York but allowed religious liberty to the Dutch and others. The Dutch ministers stood by James's government during Leisler's rebellion. Under William III., Governors Sloughter and Fletcher worked for a law (passed in 1693 and approved in 1697) for the settling of a ministry in New York, Richmond, Westchester and Queen's counties; but the Assembly foiled Fletcher's purpose of establishing a Church of England clergy, although he attempted to construe the act as applying only to the English Church. In 1696 the first church charter in New York was granted to the Reformed Protestant Dutch Church (now the Collegiate Church) of New York City; at this time there were Dutch ministers at Albany and Kingston, on Long Island and in New Jersey; and for years the Dutch and English (Episcopalian) churches alone received charters in New York and New Jersey—the Dutch church being treated practically as an establishment—and the church of the fort and Trinity (Episcopalian; chartered 1697) were fraternally harmonious. In 1700 there were twenty-nine Reformed Dutch churches out of a total of fifty in New York. During the administration of Governor Edward Hyde, Lord Cornbury, many members joined the Episcopal Church and others removed to New Jersey. The Great Awakening crowned the efforts of Theodore J. Frelinghuysen, who had come over as a Dutch pastor in 1720 and had opposed formalism and preached a revival. The Church in America in 1738 asked the Classis of Amsterdam (to whose care it had been transferred from the West India Company) for the privilege of forming a Coetus or Association with power to ordain in America; the Classis, after trying to join the Dutch with the English Presbyterian churches, granted (1747) a Coetus first to the German and then to the Dutch churches, which therefore in September 1754 organized themselves into a classis. This action was opposed by the church of New York City, and partly through this difference and partly because of quarrels over the denominational control of King's College (now Columbia), five members of the Coetus seceded, and as the president of the Coetus was one of them they took the records with them; they were called the *Conferentie*; they organized independently in 1764 and carried on a bitter warfare with the Coetus (now more properly called

the American Classis), which in 1766 (and again in 1770) obtained a charter for Queen's (now Rutgers) College at New Brunswick. But in 1771-72 through the efforts of John H. Livingston (1746-1825), who had become pastor of the New York City church in 1770, on the basis of a plan drafted by the Classis of Amsterdam Coetus and Conferentie were reunited with a substantial independence of Amsterdam, which was made complete in 1792 when the Synod (the nomenclature of synod and classis had been adopted upon the declaration of American Independence) adopted a translation of the eighty-four Articles of Dort on Church Order with seventy-three "explanatory articles."¹ In 1800 there were about forty ministers and one hundred churches. In 1810 the Church was incorporated as the Reformed Protestant Dutch Church; and in 1867 the name was changed to the Reformed Church in America. Preaching in Dutch had nearly ceased in 1820, but about 1846 a new Dutch immigration began, especially in Michigan, and fifty years later Dutch preaching was common in nearly one-third of the churches of the country, only to disappear almost entirely in the next decade. Union with other Reformed churches was planned in 1743, in 1784, in 1816-20, 1873-78 and 1886, but unsuccessfully; however, ministers go from one to another charge in the Dutch and German Reformed, Presbyterian, and to a less degree Congregational churches.

A conservative secession "on account of Hopkinsian errors" in 1822 of six ministers (five then under suspension) organized a General Synod and the classes of Hackensack and Union (central New York) in 1824; it united with the Christian Reformed Church, established by immigrants from Holland after 1835, to which there was added a fresh American secession in 1882 due to opposition (on the part of the seceders) to secret societies.

The organization of the Church is: a General Synod (1794); the (particular) synods of New York (1800), Albany (1800), Chicago (1826) and New Brunswick (1826); classes, corresponding to the presbyteries of other Calvinistic bodies; and the churches, numbering, in 1906, 659. The agencies of the Church are: the Board of Education, privately organized in 1828 and adopted by the General Synod in 1831; a Widows' Fund (1837) and a Disabled Ministers' Fund; a Board of Publication (1855); a Board of Domestic Missions (1831; reorganized 1849) with a Church Building Fund and a Woman's Executive Committee; a Board of Foreign Missions (1832) succeeding the United Missionary Society (1816), which included Presbyterian, Dutch Reformed and Associate Reformed Churches, and which was merged (1826) in the American Board of Commissioners for Foreign Missions, from which the Dutch Church did not entirely separate itself until 1857; and a Woman's Board of Foreign Missions (1875). The principal missions are in India at Arcot (1854; transferred in 1902 to the Synod of S. India) and at Amoy in China (1842); and the work of the Church in Japan was very successful, especially under Guido Fridolin Verbeek* (1830-1898), and 1877 native churches built up by Presbyterian and Dutch Reformed missionaries were organized as the United Church of our Lord Jesus Christ in Japan. There is also an Arabian mission, begun privately in 1888 and transferred to the Board in 1894.

The colleges and institutions of learning connected with the Church are: Rutgers, already mentioned; Union College (1795); the outgrowth of Schenectady Academy, founded in 1785 by Dirck Romeyn, a Dutch minister; Hope College (1866; coeducational) at Holland, Michigan, originally a parochial school (1850) and then (1855) Holland Academy; the Theological Seminary at New Brunswick (*q.v.*); and the Western Theological Seminary (1866) at Holland, Michigan.

In 1906 (according to *Bulletin 103* (1909) of the Bureau of the U.S. Census) there were 659 organizations with 773 church edifices reported and the total membership was 124,938. More than one-half of this total membership (63,350) was in New York state, the principal home of the first great Dutch immigration; more than one-quarter (22,290) was in New Jersey; and the other states were: Michigan (11,260), Illinois (4,962), Iowa (4,835), Wisconsin (2,312) and Pennsylvania (1,979). The Church was also represented in Minnesota, S. Dakota, Oklahoma, Nebraska, Indiana, Ohio, Kansas, N. Dakota, S. Carolina, Washington and Maryland—the order being that of rank in number of communicants.

The Christian Reformed Church, an "old school" secession, had in 1906, 174 organizations, 181 churches and a membership of 26,669,

¹In 1832 the articles of Church government were rearranged and in 1872-74 they were amended.

* See W. E. Griffis, *Verbeek of Japan* (New York, 1900).

of which more than one-half (14,779) was in Michigan, where many of the immigrants who came after 1835 belonged to the secession church in Holland. There were 2990 in Iowa, 2392 in New Jersey, 2332 in Illinois, and smaller numbers in Wisconsin, Indiana, Minnesota, S. Dakota, Ohio, New York, Washington, Kansas, Massachusetts, Montana, N. Dakota, New Mexico, Nebraska and Colorado.

See D. D. Demarest, *The Reformed Church in America* (New York, 1889); E. T. Corwin, *The Manual of the Reformed Church in America* (*ibid.*, 4th ed., 1902), his sketch of the history of the Church in vol. viii. (*ibid.*, 1895) of the American Church History Series, and his *Ecclesiastical Records of the State of New York* (Albany, 1901 sqq.), published by the State of New York.

REFORMED CHURCH IN THE UNITED STATES.

A German Calvinistic church in America, commonly called the German Reformed Church. It traces its origin to the great German immigration of the 17th century, especially to Pennsylvania, where, although the German Lutherans afterwards outnumbered them, the Reformed element was estimated in 1730 to be more than half the whole number of Germans in the colony. In 1709 more than 2000 Palatines emigrated to New York with their pastor, Johann Friedrich Hager (d. c. 1723), who laboured in the Mohawk Valley. A church in Germantown, Virginia, was founded about 1714. Johann Philip Boehm (d. 1749), a school teacher from Worms, although not ordained, preached after 1725 to congregations at Falckner's Swamp, Skippack, and White Marsh, Pennsylvania, and in 1729 he was ordained by Dutch Reformed ministers in New York. Georg Michael Weiss (c. 1700-c. 1762), a graduate of Heidelberg, ordained and sent to America by the Upper Consistory of the Palatinate in 1727, organized a church in Philadelphia; preached at Skippack; worked in Dutchess and Schoharie counties, New York, in 1731-46; and then returned to his old field in Pennsylvania. Johann Heinrich Goetschius was pastor (c. 1731-38) of ten churches in Pennsylvania, and was ordained by the Presbyterian Synod of Philadelphia in 1737. A part of his work was undertaken by Johann Conrad Wirtz, who was ordained by the New Brunswick (New Jersey) Presbytery in 1750, and in 1761-63 was pastor at York, Pennsylvania. A church was built in 1736 at Lancaster, Pennsylvania, where Johann Bartholomaeus Rieger (1707-1769), who came from Germany with Weiss on his return in 1731, had preached for several years. Michael Schlatter (1716-1790), a Swiss of St Gall, sent to America in 1746 by the Synods (Dutch Reformed) of Holland, immediately convened Boehm, Weiss and Rieger in Philadelphia, and with them planned a Coetus, which first met in September 1747; in 1751 he presented the cause of the Coetus in Germany and Holland, where he gathered funds; in 1752 came back to America with six ministers, one of whom, William Stoy (1726-1801), was an active opponent of the Coetus and of clericalism after 1772. Thereafter Schlatter's work was in the charity schools of Pennsylvania, which the people thought were tinged with Episcopalianism. Many churches and pastors were independent of the Coetus, notably John Joachim Zubly (1724-1781), of St Gall, who migrated to S. Carolina in 1726, and was a delegate to the Continental Congress from Georgia, but opposed independence and was banished from Savannah in 1777. Within the Coetus there were two parties. Of the Pietists of the second class one of the leaders was Philip William Otterbein (1726-1813), born in Dillenburg, Nassau, whose system of class-meetings was the basis of a secession from which grew the United Brethren in Christ, commonly called the "New Reformed Church," organized in 1800. During the War of Independence the Pennsylvania members of the Church were mostly attached to the American cause, and Nicholas Herkimer and Baron von Steuben were both Reformed; but in New York and in the South there were many German Loyalists.

Franklin College was founded by Lutherans and Reformed, with much outside help, notably that of Benjamin Franklin, at Lancaster, Pennsylvania, in 1787.

The Coetus had actually assumed the power of ordination in 1772 and formally assumed it in 1791; in 1792 a synodical constitution was prepared; and in 1793 the first independent

synod met in Lancaster and adopted the constitution, thus becoming independent of Holland. Its churches numbered 178, and there were about 15,000 communicants. The strongest churches were those of Philadelphia, Lancaster and Germantown in Pennsylvania, and Frederick in Maryland. The German Reformed churches in Lunenburg county, Nova Scotia, became Presbyterian in 1837; a German church in Waldoboro, Maine, after a century, became Congregational in 1850. The New York churches became Dutch Reformed. The New Jersey churches rapidly fell away, becoming Presbyterian, Dutch Reformed, or Lutheran. In Virginia many churches became Episcopalian and others United Brethren. By 1825, 13 Reformed ministers were settled W. of the Alleghenies. The Synod in 1810 divided itself into eight Classes. In 1824 the Classis of Northampton, Pennsylvania (13 ministers and 80 congregations), became the Synod of Ohio, the parent Synod having refused to allow the Classis to ordain. In 1825 there were 87 ministers, and in the old Synod about 23,300 communicants.

A schism over the establishment of a theological seminary resulted in the organization of a new synod of the "Free German Reformed Congregations of Pennsylvania," which returned to the parent synod in 1837.

John Winebrenner (q.v.), pastor in Harrisburg, Pennsylvania, left the Church in 1828, and in 1830 organized the "Church of God"; his main doctrinal difference with the Reformed Church was on infant baptism.

In 1825 the Church opened a theological seminary at Carlisle, Pennsylvania, affiliated with Dickinson College. James Ross Reilly (1788-1844) travelled in Holland and Germany, collecting money and books for the seminary. It was removed in 1829 to York, where an academy was connected with it; in 1835 the academy (which in 1836 became Marshall College) and in 1837 the seminary removed to Mercersburg, where, in 1840, John W. Nevin (q.v.) became its president, and with Philip Schaff (q.v.) founded the Mercersburg theology, which lost to the Church many who objected to Nevin's (and Schaff's) Romanizing tendencies. The seminary was removed in 1871 from Mercersburg to Lancaster, whither the college had gone in 1853 to form, with Franklin College, Franklin and Marshall College.

In 1842 the Western Synod (i.e. the Synod of Ohio) adopted the constitution of the Eastern, and divided into classes. It founded in 1850 a theological school and Heidelberg University at Tiffin, Ohio. The Synods organized a General Synod in 1863. New German Synods were: that of the North-West (1867), organized at Fort Wayne, Ind.; that of the East (1875), organized at Philadelphia; and the Central Synod (1881), organized at Galion, Ohio. New English Synods were: that of Pittsburg (1870); that of the Potomac (1873); and that of the Interior (1887), organized at Kansas City, Missouri. In 1894 there were eight district synods.

After a long controversy over a liturgy (connected in part with the Mercersburg controversy) a *Directory of Worship* was adopted in 1887.

The principal organizations of the Church are: the Board of Publication (1844); the Society for the Relief of Ministers and their Widows (founded in 1755 by the Pennsylvania Coetus; incorporated in 1810; transferred to the Synod in 1833); a Board of Domestic Missions (1826); a Board of Foreign Missions (1858; reorganized in 1873), which planted a mission in Japan (1879), now a part of the Union Church of Japan, and one in China (1900). The Church has publishing houses in Philadelphia (replacing that of Chambersburg, Pa., founded in 1840 and destroyed in July 1864 by the Confederate army) and in Cleveland, Ohio.

Colleges connected with the Church, besides the seminary at Lancaster, Franklin and Marshall College and Heidelberg University, are: Catawba College (1851) at Newton, North Carolina; and Ursinus College (1869), founded by the Low Church wing, at Collegeville, Pennsylvania, which had, until 1908, a theological seminary, then removed to Dayton, Ohio, where it united with Heidelberg Theological Seminary (until 1908 at Tiffin) to form the Central Theological Seminary.

In 1906, according to *Bulletin 103* (1909) of the Bureau of the United States Census, the Church had 1736 organizations in the

United States, 1740 churches and 292,654 communicants, of whom 177,270 were in Pennsylvania, and about one-sixth (50,732) were in Ohio. Other states in which the Church had communicants were: Maryland (13,442), Wisconsin (8386), Indiana (8289), New York (5700), North Carolina (4718), Iowa (3692), Illinois (2652), Virginia (2288), Kentucky (2101), Michigan (1666), Nebraska (1616), and (less than 1500 in each of the following arranged in rank) S. Dakota, Missouri, New Jersey, Connecticut, Kansas, W. Virginia N. Dakota, Minnesota, District of Columbia, Oregon, Massachusetts, Tennessee, California, Colorado, Arkansas and Oklahoma.

See James I. Good, *History of the Reformed Church in the United States, 1725-1792* (Reading, Pa., 1899), and *Historical Handbook* (Philadelphia, 1902); and the sketch by Joseph Henry Dubbs in vol. viii. (New York, 1895) of the *American Church History Series*.

REFORMED EPISCOPAL CHURCH, a Protestant community in the United States of America, dating from December 1873. The influence of the Tractarian movement began to be felt at an early date in the Episcopal Church of the United States, and the ordination of Arthur Carey in New York, July 1843, a clergyman who denied that there was any difference in points of faith between the Anglican and the Roman Churches and considered the Reformation an unjustifiable act, brought into relief the antagonism between Low Church and High Church, a struggle which went on for a generation with increasing bitterness. The High Church party lost no opportunity of arraigning any Low Churchman who conducted services in non-episcopal churches, and as the Triennial Conference gave no heed to remonstrances on the part of these ecclesiastical offenders they came to the conclusion that they must either crush their consciences or seek relief in separation. The climax was reached when George D. Cummins (1822-1876), assistant bishop of Kentucky, was angrily attacked for officiating at the united communion service held at the meeting of the Sixth General Conference of the Evangelical Alliance in New York, October 1873. This prelate resigned his charge in the Episcopal Church on November 11th, and a month later, with seven other clergymen and a score of laymen, constituted the Reformed Episcopal Church. Cummins was chosen as presiding officer of the new body, and consecrated Charles E. Cheney (b. 1836), rector of Christ Church, Chicago, to be bishop. The following Declaration of Principles (here abridged) was promulgated:—

I. An expression of belief in the Bible as the Word of God, and the sole rule of faith and practice, in the Apostles' Creed, in the divine institution of the two sacraments and in the doctrines of grace substantially as set out in the 39 Articles.

II. The recognition of Episcopacy not as of divine right but as a very ancient and desirable form of church polity.

III. An acceptance of the Prayer Book as revised by the General Convention of the Protestant Episcopal Church in 1785, with liberty to revise it as may seem most conducive to the edification of the people.

IV. A condemnation of certain positions, viz.:

- That the Church of God exists only in one form of ecclesiastical polity.
- That Christian ministers as distinct from all believers have any special priesthood.
- That the Lord's Table is an altar on which the body and blood of Christ are offered anew to the Father.
- That the presence of Christ is a material one.
- That Regeneration is inseparably connected with Baptism.

The Church recognizes no orders of ministry, presbyters and deacons; the Episcopate is an office, not an order, the bishop being the chief presbyter, *primus inter pares*. There are some 7 bishops, 85 clergy and about 9500 communicants. £1000 annually is raised for foreign missionary work in India. The Church was introduced into England in 1877, and has in that country a presiding bishop and about 20 organized congregations. The Church has a theological seminary in Philadelphia.

REFRACTION (Lat. *refringere*, to break open or apart), in physics, the change in the direction of a wave of light, heat or sound which occurs when such a wave passes from one medium into another of different density.

I. REFRACTION OF LIGHT

When a ray of light traversing a homogeneous medium falls on the bounding surface of another transparent homogeneous

medium, it is found that the direction of the transmitted ray in the second medium is different from that of the incident ray; in other words, the ray is refracted or bent at the point of incidence. The laws governing refraction are: (1) the refracted and incident rays are coplanar with the normal to the refracting surface at the point of incidence, and (2) the ratio of the sines of the angles between the normal and the incident and refracted rays is constant for the two media, but depends on the nature of the light employed, i.e. on its wave length. This constant is called the relative refractive index of the second medium, and may be denoted by μ_{ab} , the suffix *ab* signifying that the light passes from medium *a* to medium *b*; similarly μ_{ba} denotes the relative refractive index of *a* with regard to *b*. The absolute refractive index is the index when the first medium is a vacuum. Elementary phenomena in refraction, such as the apparent bending of a stick when partially immersed in water, were observed in very remote times, but the laws, as stated above, were first grasped in the 17th century by W. Snell and published by Descartes, the full importance of the dependence of the refractive index on the nature of the light employed being first thoroughly realized by Newton in his famous prismatic decomposition of white light into a coloured spectrum. Newton gave a theoretical interpretation of these laws on the basis of his corpuscular theory, as did also Huygens on the wave theory (see LIGHT, II. *Theory of*). In this article we only consider refractions at plane surfaces, refraction at spherical surfaces being treated under LENS. The geometrical theory will be followed, the wave theory being treated in LIGHT, DIFFRACTION AND DISPERSION.

Refraction at a Plane Surface.—Let LM (fig. 1) be the surface

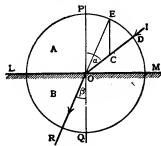

FIG. 1.

dividing two homogeneous media A and B; let IO be a ray in the first medium incident on LM at O, and let OR be the refracted ray. Draw the normal POQ. Then by Snell's law we have invariably $\sin \text{IOP} / \sin \text{OQR} = \mu_{ab}$. Hence if two of these quantities be given the third can be calculated. The commonest question is: Given the incident ray and the refractive index to construct the refracted ray. A simple construction is to take along the incident ray OI, unit distance OC, and a distance OD equal to the refractive index in the same units. Draw CE perpendicular to LM, and draw an arc with centre O and radius OD, cutting CE in E. Then EO produced downwards is the refracted ray. The proof is left to the reader.

In the figure the given incident ray is assumed to be passing from a less dense to a denser medium, and it is seen by the construction or by examining the formula $\sin \beta = \sin \alpha / \mu$ that for all values of α there is a corresponding value of β . Consider the case when the light passes from a denser to a less dense medium. In the equation $\sin \beta = \sin \alpha / \mu$ we have in this case $\mu < 1$. Now if $\sin \alpha < \mu$, we have $\sin \alpha / \mu < 1$, and hence β is real. If $\sin \alpha = \mu$, then $\sin \beta = 1$, i.e. $\beta = 90^\circ$; in other words, the refracted ray in the second medium passes parallel to and grazes the bounding surface. The angle of incidence, which is given by $\sin \alpha = 1/\mu$, is termed the *critical angle*. For greater values it is obvious that $\sin \alpha / \mu > 1$ and there is no refraction into the second medium, the rays being totally reflected back into the first medium; this is called *total internal reflection*.

Images produced by Refraction at Plane Surfaces.—If a luminous point be situated in a medium separated from one of less density by a plane surface, the ray normal to this surface will be unrefracted, whilst the others will undergo refraction according to their angles of emergence. If the rays in the less dense medium be produced into the denser medium, they envelop a caustic, but by restricting ourselves to a small area about the normal ray it is seen that they intersect this ray in a point which is the geometrical

image of the luminous source. The position of this point can be easily determined. If l be the distance of the source below the surface, l' the distance of the image, and μ the refractive index, then $l' = l/\mu$. This theory provides a convenient method for determining the refractive index of a plate. A micrometer microscope, with vertical motion, is focused on a scratch on the surface of its stage; the plate, which has a fine scratch on its upper surface, is now introduced, and the microscope is successively focused on the scratch on the stage as viewed through the plate, and on the scratch on the plate. The difference between the first and third readings gives the thickness of the plate, corresponding to l above, and between the second and third readings the depth of the image, corresponding to l' .

Refraction by a Prism.—In optics a prism is a piece of transparent material bounded by two plane faces which meet at a definite angle, called the refracting angle of the prism, in a straight line called the edge of the prism; a section perpendicular to the edge is called a principal section. Parallel rays, refracted successively at the two faces, emerge from the prism as a system of parallel rays, but the direction is altered by an amount called the *deviation*. The deviation depends on the angles of incidence and emergence; but, since the course of a ray may always be reversed, there must be a stationary value, either a maximum or minimum, when the ray traverses the prism symmetrically, *i.e.* when the angles of incidence and emergence are equal. As a matter of fact, it is a minimum, and the position is called the angle of minimum deviation. The relation between the minimum deviation D , the angle of the prism i , and the refractive index μ is found as follows. Let in fig. 2, PQRS be the course of the

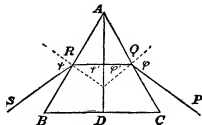

FIG. 2.

ray through the prism; the internal angles ϕ' , ψ' each equal $\frac{1}{2}i$, and the angles of incidence and emergence ϕ , ψ are each equal and connected with ϕ' by Snell's law, *i.e.* $\sin \phi = \mu \sin \phi'$. Also the deviation D is $2(\phi - \phi')$. Hence $\mu = \sin \phi / \sin \phi' = \sin \frac{1}{2}(D+i) / \sin \frac{1}{2}i$.

Refractometers.—Instruments for determining the refractive indices of media are termed refractometers.

The simplest are really spectrometers, consisting of a glass prism, usually hollow and fitted with accurately parallel glass sides, mounted on a table which carries a fixed collimation tube and a movable observing tube, the motion of the latter being recorded on a graduated circle. The collimation tube has a narrow adjustable slit at its outer end and a lens at the nearer end, so that the light leaves the tube as a parallel beam. The refracting angle of the prism, i in our previous notation, is determined by placing the prism with its refracting edge towards the collimator, and observing when the reflections of the slit in the two prism faces coincide with the cross-wires in the observing telescope; half the angle between these two positions gives i . To determine the position of minimum deviation, or D , the prism is removed, and the observing telescope is brought into line with the slit; in this position the graduation is read. The prism is replaced, and the telescope moved until it catches the refracted rays. The prism is now turned about a vertical axis until a position is found when the telescope has to be moved towards the collimator in order to catch the rays; this operation sets the prism at the angle of minimum deviation. The refractive index μ is calculated from the formula given above.

More readily manipulated and of superior accuracy are refractometers depending on total reflection. The Abbe refractometer (fig. 3) essentially consists of a double Abbe prism AB to contain the substance to be experimented with; and a telescope F to observe the border line of the total reflection. The prisms, which are right-angled and made of the same flint glass, are mounted in a hinged frame such that the lower prism, which is used for purposes of illumination, can be locked so that the hypotenuse faces are distant by about 0.15 mm., or rotated away from the upper prism. The double prism is used in examining liquids, a few drops being placed between the prisms; the single prism is used when solids or plastic bodies are employed. The mount is capable of rotation about a horizontal axis by an alidade J. The telescope is provided with a reticule, which can be brought into exact coincidence with the observed border line, and is rigidly fastened to a sector

S graduated directly in refractive indices. The reading is effected by a lens L. Beneath the prisms is a mirror for reflecting light

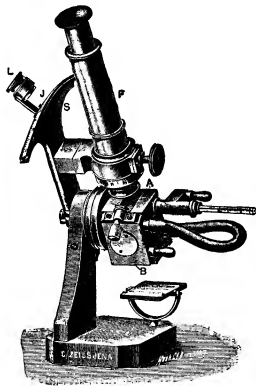

FIG. 3.

into the apparatus. To use the apparatus, the liquid having been inserted between the prisms, or the solid attached by its own adhesiveness or by a drop of monobromnaphthalene to the upper prism, the prism case is rotated until the field of view consists of a light and dark portion, and the border line is now brought into coincidence with the reticule of the telescope. In using a lamp or daylight this border is coloured, and hence a compensator, consisting of two equal Amici prisms, is placed between the objective and the prisms. These Amici prisms can be rotated, in opposite directions, until they produce a dispersion opposite in sign to that originally seen, and hence the border line now appears perfectly sharp and colourless. When at zero the alidade corresponds to a refractive index of 1.3, and any other reading gives the corresponding index correct to about 2 units in the 4th decimal place. Since temperature markedly affects the refractive index, this apparatus is provided with a device for heating the prisms. Figs. 4 and 5 show the course of the rays when a solid and liquid

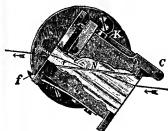

FIG. 4.



FIG. 5.

are being experimented with. Dr R. Wollny's butter refractometer, also made by Zeiss, is constructed similarly to Abbe's form, with the exception that the prism casing is rigidly attached to the telescope, and the observation made by noting the point where the border line intersects an appropriately graduated scale in the focal plane of the telescope objective, fractions being read by a micrometer screw attached to the objective. This apparatus is also provided with an arrangement for heating.

This method of reading is also employed in Zeiss's "dipping refractometer" (fig. 6). This instrument consists of a telescope R having at its lower end a prism P with a refracting angle of 63° , above which and below the objective is a movable compensator A for purposes of annulling the dispersion about the border line. 12

the focal plane of the objective O there is a scale S_c , exact reading being made by a micrometer Z. If a large quantity of liquid be

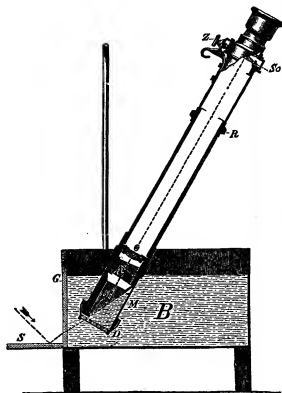

FIG. 6.—Zeiss's Dipping Refractometer.

available it is sufficient to dip the refractometer perpendicularly into a beaker containing the liquid and to transmit light into the instrument by means of a mirror. If only a smaller quantity be available, it is enclosed in a metal beaker M, which forms an extension of the instrument, and the liquid is retained there by a plate D. The instrument is now placed in a trough B, containing water and having one side of ground glass G; light is reflected into the refractometer by means of a mirror S outside this trough. An accuracy of 3.7 units in the 5th decimal place is obtainable.

The Pulfrich refractometer is also largely used, especially for liquids. It consists essentially of a right-angled glass prism placed on a metal foundation with the faces at right angles horizontal and vertical, the hypotenuse face being on the support. The horizontal face is fitted with a small cylindrical vessel to hold the liquid. Light is led to the prism at grazing incidence by means of a collimator, and is refracted through the vertical face, the deviation being observed by a telescope rotating about a graduated circle. From this the refractive index is readily calculated if the refractive index of the prism for the light used be known; a fact supplied by the maker. The instrument is also available for determining the refractive index of isotropic solids. A little of the solid is placed in the vessel and a mixture of monobromophthalene and acetone (in which the solid must be insoluble) is added, and adjustment made by adding either one or other liquid until the border line appears sharp, *i.e.* until the liquid has the same index as the solid.

The Herbert Smith refractometer (fig. 7) is especially suitable for determining the refractive index of gems, a constant which is

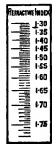

FIG. 7.

most valuable in distinguishing the precious stones. It consists of a hemisphere of very dense glass, having its plane surface fixed

at a certain angle to the axis of the instrument. Light is admitted by a window on the under side, which is inclined at the same angle, but in the opposite sense, to the axis. The light on emerging from the hemisphere is received by a convex lens, in the focal plane of which is a scale graduated to read directly in refractive indices. The light then traverses a positive eye-piece. To use the instrument for a gem, a few drops of methylene iodide (the refractive index of which may be raised to 1.800 by dissolving sulphur in it) are placed on the plane surface of the hemisphere and a facet of the stone then brought into contact with the surface. If monochromatic light be used (*i.e.* the D line of the sodium flame) the field is sharply divided into a light and a dark portion, and the position of the line of demarcation on the scale immediately gives the refractive index. It is necessary for the liquid to have a higher refractive index than the crystal, and also that there is close contact between the facet and the lens. The range of the instrument is between 1.400 and 1.760, the results being correct to two units in the third decimal place if sodium light be used. (C. E.*)

II. DOUBLE REFRACTION

That a stream of light on entry into certain media can give rise to two refracted pencils was discovered in the case of Iceland spar by Erasmus Bartholinus, who found that one pencil had a direction given by the ordinary law of refraction, but that the other was bent in accordance with a new law that he was unable to determine. This law was discovered about eight years later by Christian Huygens. According to Huygens' fundamental principle, the law of refraction is determined by the form and orientation of the wave-surface in the crystal—the locus of points to which a disturbance emanating from a luminous point travels in unit time. In the case of a doubly refracting medium the wave-surface must have two sheets, one of which is spherical, if one of the pencils obey in all cases the ordinary law of refraction. Now Huygens observed that a natural crystal of spar behaves in precisely the same way whichever pair of faces the light passes through, and inferred from this fact that the second sheet of the wave-surface must be a surface of revolution round a line equally inclined to the faces of the rhomb, *i.e.* round the axis of the crystal. He accordingly assumed it to be a spheroid, and finding that refraction in the direction of the axis was the same for both streams, he concluded that the sphere and the spheroid touched one another in the axis.

So far as his experimental means permitted, Huygens verified the law of refraction deduced from this hypothesis, but its correctness remained unrecognized until the measures of W. H. Wollaston in 1802 and of E. T. Malus in 1810. More recently its truth has been established with far more perfect optical appliances by R. T. Glazebrook, Ch. S. Hastings and others.

In the case of Iceland spar and several other crystals the extraordinarily refracted stream is refracted away from the axis, but Jean Baptiste Biot in 1814 discovered that in many cases the reverse occurs, and attributing the extraordinary refractions to forces that act as if they emanated from the axis, he called crystals of the latter kind "attractive," those of the former "repulsive." They are now termed "positive" and "negative" respectively; and Huygens' law applies to both classes, the spheroid being prolate in the case of positive, and oblate in the case of negative crystals. It was at first supposed that Huygens' law applied to all doubly refracting media. Sir David Brewster, however, in 1815, while examining the rings that are seen round the optic axis in polarized light, discovered a number of crystals that possess two optic axes. He showed, moreover, that such crystals belong to the rhombic, monoclinic and anorthic (trigonal) systems, those of the tetragonal and hexagonal systems being uniaxial, and those of the cubic system being optically isotropic.

Huygens found in the course of his researches that the streams that had traversed a rhomb of Iceland spar had acquired new properties with respect to transmission through a second crystal. This phenomenon is called polarization (*q.v.*), and the waves are said to be polarized—the ordinary in its principal plane and the extraordinary in a plane perpendicular to its principal plane, the principal plane of a wave being the plane containing its normal and the axis of the crystal. From the facts of polarization Augustin Jean Fresnel deduced that the

vibrations in plane polarized light are rectilinear and in the plane of the wave, and arguing from the symmetry of uniaxial crystals that vibrations perpendicular to the axis are propagated with the same speed in all directions, he pointed out that this would explain the existence of an ordinary wave, and the relation between its speed and that of the extraordinary wave. From these ideas Fresnel was forced to the conclusion, that he at once verified experimentally, that in biaxial crystals there is no spherical wave, since there is no single direction round which such crystals are symmetrical; and, recognizing the difficulty of a direct determination of the wave-surface, he attempted to represent the laws of double refraction by the aid of a simpler surface.

The essential problem is the determination of the propagational speeds of plane waves as dependent upon the directions of their normals. These being known, the deduction of the wave-surface follows at once, since it is to be regarded as the envelope at any subsequent time of all the plane waves that at a given instant may be supposed to pass through a given point, the ray corresponding to any tangent plane or the direction of transport of energy being by Huygens' principle the radius-vector from the centre to the point of contact. Now Fresnel perceived that in uniaxial crystals the speeds of plane waves in any direction are by Huygens' law the reciprocals of the semi-axes of the central section, parallel to the wave-fronts, of a spheroid, whose polar and equatorial axes are the reciprocals of the equatorial and polar axes of the spheroidal sheet of Huygens' wave-surface, and that the plane of polarization of a wave is perpendicular to the axis that determines its speed. Hence it occurred to him that similar relations with respect to an ellipsoid with three unequal axes would give the speeds and polarizations of the waves in a biaxial crystal, and the results thus deduced he found to be in accordance with all known facts. This ellipsoid is called the ellipsoid of polarization, the index ellipsoid and the indicatrix.

We may go a step further; for by considering the intersection of a wave-front with two waves, whose normals are indefinitely near that of the first and lie in planes perpendicular and parallel respectively to its plane of polarization, it is easy to show that the ray corresponding to the wave is parallel to the line in which the former of the two planes intersects the tangent plane to the ellipsoid at the end of the semi-diameter that determines the wave-velocity; and it follows by similar triangles that the ray-velocity is the reciprocal of the length of the perpendicular from the centre on this tangent plane. The laws of double refraction are thus contained in the following proposition. The propagational speed of a plane wave in any direction is given by the reciprocal of one of the semi-axes of the central section of the ellipsoid of polarization parallel to the wave; the plane of polarization of the wave is perpendicular to this axis; the corresponding ray is parallel to the line of intersection of the tangent plane at the end of the axis and the plane containing the axis and the wave-normal; the ray-velocity is the reciprocal of the length of the perpendicular from the centre on the tangent plane. By reciprocating with respect to a sphere of unit radius concentric with the ellipsoid, we obtain a similar proposition in which the ray takes the place of the wave-normal, the ray-velocity that of the wave-slowness (the reciprocal of the velocity) and vice versa. The wave-surface is thus the apsidal surface of the reciprocal ellipsoid; this gives the simplest means of obtaining its equation, and it is readily seen that its section by each plane of optical symmetry consists of an ellipse and a circle, and that in the plane of greatest and least wave-velocity these curves intersect in four points. The radii-vectors to these points are called the ray-axes.

When the wave-front is parallel to either system of circular sections of the ellipsoid of polarization, the problem of finding the axes of the parallel central section becomes indeterminate, and all waves in this direction are propagated with the same speed, whatever may be their polarization. The normals to the circular sections are thus the optic axes. To determine the rays corresponding to an optic axis, we may note that the ray

and the perpendiculars to it through the centre, in planes perpendicular and parallel to that of the ray and the optic axis, are three lines intersecting at right angles of which the two latter are confined to given planes, viz. the central circular section of the ellipsoid and the normal section of the cylinder touching the ellipsoid along this section: whence by a known proposition the ray describes a cone whose sections parallel to the given planes are circles. Thus a plane perpendicular to the optic axis touches the wave-surface along a circle. Similarly the normals to the circular sections of the reciprocal ellipsoid, or the axes of the tangent cylinders to the polarization-ellipsoid that have circular normal sections, are directions of single-ray velocity or ray-axes, and it may be shown as above that corresponding to a ray-axis there is a cone of wave-normals with circular sections parallel to the normal section of the corresponding tangent cylinder, and its plane of contact with the ellipsoid. Hence the extremities of the ray-axes are conical points on the wave-surface. These peculiarities of the wave-surface are the cause of the celebrated conical refractions discovered by Sir William Rowan Hamilton and H. Lloyd, which afford a decisive proof of the general correctness of Fresnel's wave-surface, though they cannot, as Sir G. Gabriel Stokes (*Math. and Phys. Papers*, iv, 184) has pointed out, be employed to decide between theories that lead to this surface as a near approximation.

In general, both the direction and the magnitude of the axes of the polarization-ellipsoid depend upon the frequency of the light and upon the temperature, but in many cases the possible variations are limited by considerations of symmetry. Thus the optic axis of a uniaxial crystal is invariable, being determined by the principal axis of the system to which it belongs: most crystals are of the same sign for all colours, the refractive indices and their difference both increasing with the frequency, but a few crystals are of opposite sign for the extreme spectral colours, becoming isotropic for some intermediate wave-length. In crystals of the rhombic system the axes of the ellipsoid coincide in all cases with the crystallographic axes, but in a few cases their order of magnitude changes so that the plane of the optic axes for red light is at right angles to that for blue light, the crystal being uniaxial for an intermediate colour. In the case of the monoclinic system one axis is in the direction of the axis of the system, and this is generally, though there are notable exceptions, either the greatest, the least, or the intermediate axis of the ellipsoid for all colours and temperatures. In the latter case the optic axes are in the plane of symmetry, and a variation of their acute bisectrix occasions the phenomenon known as "inclined dispersion": in the two former cases the plane of the optic axes is perpendicular to the plane of symmetry, and if it vary with the colour of the light, the crystals exhibit "crossed" or "horizontal dispersion" according as it is the acute or the obtuse bisectrix that is in the fixed direction.

The optical constants of a crystal may be determined either with a prism or by observations of total reflection. In the latter case the phenomenon is characterized by two angles—the critical angle and the angle between the plane of incidence and the line limiting the region of total reflection in the field of view. With any crystalline surface there are four cases in which this latter angle is 90° , and the principal refractive indices of the crystal are obtained from those calculated from the corresponding critical angles, by excluding that one of the mean values for which the plane of polarization of the limiting rays is perpendicular to the plane of incidence. A difficulty, however, may arise when the crystalline surface is very nearly the plane of the optic axes, as the plane of polarization in the second mean case is then also very nearly perpendicular to the plane of incidence; but since the two mean refractive indices will be very different, the ambiguity can be removed by making, as may easily be done, an approximate measure of the angle between the optic axes and comparing it with the values calculated by using in turn each of these indices (C. M. Viola, *Zeit. für Kryst.*, 1902, 36, p. 245).

A substance originally isotropic can acquire the optical

properties of a crystal under the influence of homogeneous strain, the principal axes of the wave-surface being parallel to those of the strain, and the medium being uniaxial, if the strain be symmetrical. John Kerr also found that a dielectric under electric stress behaves as an uniaxial crystal with its optic axis parallel to the electric force, glass acting as a negative and bisulphide of carbon as a positive crystal (*Phil. Mag.*, 1875 (4), L. 337).

Not content with determining the laws of double refraction, Fresnel also attempted to give their mechanical explanation. He supposed that the aether consists of a system of distinct material points symmetrically arranged and acting on one another by forces that depend for a given pair only on their distance. If in such a system a single molecule be displaced, the projection of the force of restitution on the direction of displacement is proportional to the inverse square of the parallel radius-vector of an ellipsoid; and of all displacements that can occur in a given plane, only those in the direction of the axes of the parallel central section of the quadric develop forces whose projection on the plane is along the displacement. In undulations, however, we are concerned with the elastic forces due to relative displacements, and accordingly, Fresnel assumed that the forces called into play during the propagation of a system of plane waves (of rectilinear transverse vibrations) differ from those developed by the parallel displacement of a single molecule only by a constant factor, independent of the plane of the wave. Next, regarding the aether as incompressible, he assumed that the components of the elastic forces parallel to the wave-front are alone operative, and finally, on the analogy of a stretched string, that the propagational speed of a plane wave of permanent type is proportional to the square root of the effective force developed by the vibrations. With these hypotheses we immediately obtain the laws of double refraction, as given by the ellipsoid of polarization, with the result that the vibrations are perpendicular to the plane of polarization.

In its dynamical foundations Fresnel's theory, though of considerable historical interest, is clearly defective in rigour, and a strict treatment of the aether as a crystalline elastic solid does not lead naturally to Fresnel's laws of double refraction. On the other hand, Lord Kelvin's rotational aether (*Math. and Phys. Papers*, iii. 442)—a medium that has no true rigidity but possesses a quasi-rigidity due to elastic resistance to absolute rotation—gives these laws at once, if we abolish the resistance to compression and, regarding it as gyrostatically isotropic, attribute to it aeolotropic inertia. The equations then obtained are the same as those deduced in the electro-magnetic theory from the circuital laws of A. M. Ampère and Michael Faraday, when the specific inductive capacity is supposed aeolotropic. In order to account for dispersion, it is necessary to take into account the interaction with the radiation of the intra-molecular vibrations of the crystalline substance: thus the total current on the electro-magnetic theory must be regarded as made up of the current of displacement and that due to the oscillations of the electrons within the molecules of the crystal.

BIBLIOGRAPHY.—An interesting and instructive account of Fresnel's work on double refraction has been given by Émile Verdet in his introduction to Fresnel's works: *Œuvres d'Augustin Fresnel*, i. 75 (Paris, 1866); *Œuvres de E. Verdet*, i. 360 (Paris, 1872). For an account of theories of double refraction see the reports of H. Lloyd, Sir C. G. Stokes and R. T. Glazebrook in the *Brit. Ass. Reports* for 1834, 1862 and 1885, and Lord Kelvin's *Baltimore Lectures* (1904). An exposition of the rotational theory of the aether has been given by H. Chipart, *Théorie gyrostatique de la lumière* (Paris, 1904); and P. Drude's *Lehrbuch der Optik*, 2^e Auf. (1906), the first German edition of which was translated by C. Riborg Mann and R. A. Milliken in 1902, treats the subject from the standpoint of the electro-magnetic theory. The methods of determining the optical constants of crystals will be found in Th. Liebisch's *Physikalische Kristallographie* (1897); F. Poehl's *Lehrbuch der Kristallographie* (1906); and I. Walker's *Analytical Theory of Light* (1904). A detailed list of papers on the geometry of the wave-surface has been published by E. Wölffing, *Bibl. Math.*, 1902 (3), iii. 361; and a general account of the subject will be found in the following treatises: L. Fletcher, *The Optical Indiciality* (1892); Th. Preston, *The Theory of Light*, 3rd ed. by C. J. Joly (1901); A. Schuster, *An Introduction to the Theory of*

Optics (1904); R. W. Wood, *Physical Optics* (1905); E. Mascart, *Traité d'optique* (1889); A. Winkelmann, *Handbuch der Physik*. (J. WAL.)

III. ASTRONOMICAL REFRACTION

The refraction of a ray of light by the atmosphere as it passes from a heavenly body to an observer on the earth's surface, is called "astronomical." A knowledge of its amount is a necessary datum in the exact determination of the direction of the body. In its investigation the fundamental hypothesis is that the strata of the air are in equilibrium, which implies that the surfaces of equal density are horizontal. But this condition is being continually disturbed by aerial currents, which produce continual slight fluctuations in the actual refraction, and commonly give to the image of a star a tremulous motion. Except for this slight motion the refraction is always in the vertical direction; that is, the actual zenith distance of the star is always greater than its apparent distance. The refracting power of the air is nearly proportional to its density. Consequently the amount of the refraction varies with the temperature and barometric pressure, being greater the higher the barometer and the lower the temperature.

At moderate zenith distances, the amount of the refraction varies nearly as the tangent of the zenith distance. Under ordinary conditions of pressure and temperature it is, near the zenith, about 1" for each degree of zenith distance. As the tangent increases at a greater rate than the angle, the increase of the refraction soon exceeds 1" for each degree. At 45° from the zenith the tangent is 1 and the mean refraction is about 58". As the horizon is approached the tangent increases more and more rapidly, becoming infinite at the horizon; but the refraction now increases at a less rate, and, when the observed ray is horizontal, or when the object appears on the horizon, the refraction is about 34', or a little greater than the diameter of the sun or moon. It follows that when either of these objects is seen on the horizon their actual direction is entirely below it. One result is that the length of the day is increased by refraction to the extent of about five minutes in low latitudes, and still more in higher latitudes. At 60° the increase is about nine minutes.

The atmosphere, like every other transparent substance, refracts the blue rays of the spectrum more than the red; consequently, when the image of a star near the horizon is observed with a telescope, it presents somewhat the appearance of a spectrum. The edge which is really highest, but seems lowest in the telescope, is blue, and the opposite one red. When the atmosphere is steady this atmospheric spectrum is very marked and renders an exact observation of the star difficult.

BIBLIOGRAPHY.—Refraction has been a favourite subject of research. See Dr. C. Bruhns, *Die astronomische Strahlenbrechung* (Leipzig, 1861), gives a *résumé* of the various formulæ of refraction which had been developed by the leading investigators up to the date 1861. Since then developments of the theory are found in: W. Chauvenet, *Spherical and Practical Astronomy*, i.; F. Brünnow, *Sphärischen Astronomie*; S. Newcomb, *Spherical Astronomy*; R. Radau, "Recherches sur la théorie des réfractions astronomiques" (*Annales de l'Observatoire de Paris*, xvi., 1882), "Essai sur les réfractions astronomiques" (*ibid.*, xix., 1889).

Among the tables of refraction which have been most used are Bessel's, derived from the observations of Bradley in Bessel's *Fundamenta Astronomiæ*; and Bessel's revised tables in his *Tabulae Regionontanae*, in which, however, the constant is too large, but which in an expanded form were mostly used at the observatories until 1870. The constant use of the Poulkova tables, *Tabulae refractionum*, which is reduced to nearly its true value, has gradually replaced that of Bessel. Later tables are those of L. de Ball, published at Leipzig in 1906. (S. N.)

REFRESHER, in English legal phraseology, a further or additional fee paid to counsel where a case is adjourned from one term or sittings to another, or where it extends over more than one day and occupies, either on the first day or partly on the first and partly on a subsequent day or days, more than five hours without being concluded. The refresher allowed for every clear day subsequent to that on which the five hours have expired is five to ten guineas for a leading counsel and from three to seven guineas for other counsel, but the taxing

master is at liberty to allow larger fees in special circumstances. See *Rules of the Supreme Court*, O. 65, r. 48.

REFRIGERATING and ICE-MAKING. "Refrigeration" (from Lat. *frigus*, frost) is the cooling of a body by the transfer of a portion of its heat to another and therefore a cooler body. For ordinary temperatures it is performed directly with water as the cooling agent, especially when well water, which usually has a temperature of from 52° to 55° F., can be obtained. There are, however, an increasingly large number of cases in which temperatures below that of any available natural cooling agent are required, and in these it is necessary to resort to machines which are capable of producing the required cooling effect by taking in heat at low temperatures and rejecting it at temperatures somewhat above that of the natural cooling agent, which for obvious reasons is generally water. The function of a refrigerating machine, therefore, is to take in heat at a low temperature and reject it at a higher one.

This involves the expenditure of a quantity of work W , the amount in any particular case being found by the equation $W = Q_2 - Q_1$, where W is the work, expressed by its equivalent in British thermal units; Q_2 the quantity of heat, also in B.Th.U., given out at the higher temperature T_2 ; and Q_1 the heat taken in at the lower temperature T_1 . It is evident that the discharged heat Q_2 is equal to the abstracted heat Q_1 , plus the work expended, seeing that the work W , which causes the rise in temperature from T_1 to T_2 , is the thermal equivalent of the energy actually expended in raising the temperature to the level at which it is rejected. The relation then between the work expended and the actual cooling work performed denotes the efficiency of the process, and this is expressed by $Q_1/(Q_2 - Q_1)$; but as in a perfect refrigerating machine it is understood that the whole of the heat Q_1 is taken in at the absolute temperature T_1 , and the whole of the heat Q_2 is rejected at the absolute temperature T_2 , the heat quantities are proportional to the temperatures, and the expression $T_1/(T_2 - T_1)$ gives the ideal coefficient of performance for any stated temperature range, whatever working substance is used. These coefficients for a number of cases met with in practice are given in the following table. They

TABLE I.

Temperature at which Heat is abstracted in Degrees Fahr.	Temperature at which Heat is rejected in Degrees Fahr.				
	50°	60°	70°	80°	100°
-10°	7.5	6.4	5.6	5.0	4.5
0°	9.2	7.7	6.6	5.8	5.1
10°	11.7	9.4	7.8	6.7	5.9
20°	16.0	12.0	9.6	8.0	6.8
30°	24.5	16.3	12.2	9.8	8.2
40°	50.0	25.0	16.7	12.5	10.0

show that in all cases the heat abstracted exceeds by many times the heat expended. As an instance, when heat is taken in at 0° and rejected at 70°, a perfect refrigerating machine would abstract 6.6 times as much heat as the equivalent of the energy to be applied. If, however, the heat is to be rejected at 100°, then the coefficient is reduced to 4.6.

By examining Table I. it will be seen how important it is to reduce the temperature range as much as possible, in order to obtain the most economical results. No actual refrigerating machine can be cooled, and reject it at the exact temperature of the cooling water, but, for economy in working, it is of great importance that the differences should be as small as possible.

There are two distinct classes of machines used for refrigerating and ice-making. In the first refrigeration is produced by the expansion of atmospheric air, and in the second by the evaporation of a more or less volatile liquid.

Compressed-air Machines.—A compressed-air refrigerating machine consists in its simplest form of three essential parts—a compressor, a compressed-air cooler, and an expansion cylinder. It is shown diagrammatically in fig. 1 in connexion with a chamber which it is keeping cool. The compressor draws in air from the room and compresses it, the work expended in compression being almost entirely converted into heat. The compressed air, leaving the compressor at the temperature T_2 , passes through the cooler, where it is cooled by means of water, and is then admitted to the expansion cylinder, where it is

expanded to atmospheric pressure, performing work on the piston. The heat equivalent of the mechanical work performed on the piston is abstracted from the air, which is discharged at the temperature T_1 . This temperature T_1 is neces-

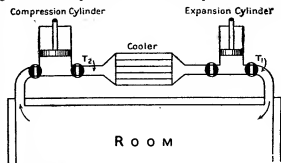

FIG. 1.—Compressed-Air Refrigerating Machine.

sarily very much below the temperature to be maintained in the room, because the cooling effect is produced by transferring heat from the room or its contents to the air, which is thereby heated. The rise in temperature of the air is, in fact, the measure of the cooling effect produced. If such a machine could be constructed with reasonable mechanical efficiency to compress the air to a temperature but slightly above that of the cooling water, and to expand the air to a temperature but slightly below that required to be maintained in the room, we should of course get a result approximating in efficiency somewhat nearly to the figures given in Table I. Unfortunately, however, such results cannot be obtained in practice, because the extreme lightness of the air and its very small heat capacity (which at constant pressure is .2379) would necessitate the employment of a great volume, with extremely large and mechanically inefficient cylinders and apparatus. A pound of air, representing about 12 cub. ft., if raised 10° F. will only take up about 2.4 B.T.U. Consequently, to make such a machine mechanically successful a comparatively small weight of air must be used, and the temperature difference increased; in other words, the air must be discharged at a temperature very much below that to be maintained in the room.

This theory of working is founded on the Carnot cycle for a perfect heat motor, a perfect refrigerating machine being simply a reversed heat motor. Another theory involves the use of the Stirling regenerator, which was proposed in connexion with the Stirling heat engine (see AIR ENGINES). The air machine invented by Dr. A. Kirk in 1862, and described by him in a paper on the "Mechanical Production of Cold" (*Proc. Inst. C.E.*, xxxviii., 1874, 244), is simply a reversed Stirling air engine, the air working in a closed cycle instead of being actually discharged into the room to be cooled, as is the usual practice with ordinary compressed-air machines. Kirk's machine was used commercially with success on a fairly large scale, chiefly for ice-making, and it is recorded that it produced about 4 lb of ice for 1 lb of coal. In 1868 J. Davy Postle read a paper before the Royal Society of Victoria, suggesting the conveyance of meat on board ship in a frozen state by means of refrigerated air, and in 1869 he showed by experiment how it could be done; but his apparatus was not commercially developed. In 1877 a compressed-air machine was designed by J. J. Coleman of Glasgow, and in the early part of 1879 one of his machines was fitted on board the Anchor liner "Circassia," which successfully brought a cargo of chilled beef from America—the first imported by the aid of refrigerating machinery, ice having been previously used. The first successful cargo of frozen mutton from Australia was also brought by a Bell-Coleman machine in 1879. In the Bell-Coleman machine the air was cooled during compression by means of an injection of water, and further by being brought into contact with a shower of water. Another, perhaps the principal feature was the interchanger, an apparatus whereby the compressed air was further cooled before expansion by means of the comparatively cold air from the room in its passage to the compressor, the same air being used over and over again. The object of this interchanger was not only to cool the compressed air before expansion, but to condense part of the moisture in it, so reducing the quantity of ice or snow produced during expansion. A full description of the machine may be found in a paper on "Air-Refrigerating Machinery" by J. J. Coleman (*Proc. Inst. C.E.*, lxxviii., 1882). At the present time the Bell-Coleman machine has practically ceased to exist. In such compressed-air machines

as are now made there is no injection of water during compression, and the compressed air is cooled in a surface cooler, not by actual mixture with a shower of cold water. Further, though the inter-changer is still used by some makers, it has been found by experience that, with properly constructed valves and passages in the expansion cylinder, there is no trouble from the formation of snow, when, as is the general practice, the same air is used over and over again, the compressor taking its supply from the insulated room. So far as the air discharged from the expansion cylinder is concerned, its humidity is precisely the same so long as its temperature and pressure are the same, inasmuch as when discharged from the expansion cylinder it is always in a saturated condition for that temperature and pressure.

The ideal coefficient of performance is about 7, but the actual coefficient will be about $\frac{2}{3}$, after allowing for the losses incidental to working. In practice the air is compressed to about 50 lb per square inch above the atmosphere, its temperature rising to about 300° F. The compressed air then passes through coolers in which it is cooled to within about 5° of the initial temperature of the cooling water, and is deprived of a portion of its moisture, after which it is admitted into the expansion cylinder and expanded nearly to atmospheric pressure. The thermal equivalent of the power exerted on the piston is taken from the air, which, with cooling water at 60° F. and after allowing for friction and other losses, is discharged at a temperature of 60° to 80° below zero F. according to the size of the machine. The pistons of the compression and expansion cylinders are connected to the same crankshaft, and the difference between the power expended in compression and that restored in expansion, plus the friction of the machine, is supplied by means of a steam engine coupled to the crankshaft, or by any other source of power. For marine purposes two complete machines are frequently mounted on one bed-plate and worked either together or separately.

In some machines used in the United States the cold air is not discharged into the rooms but is worked in a closed cycle, the rooms being cooled by means of overhead pipes through which the cold expanded air passes on its way back to the compressor.

Liquid Machines.—Machines of the second class may conveniently be divided into three types: (a) Those in which there is no recovery of the refrigerating agent, water being the agent employed; they will be dealt with as "Vacuum machines." (b) Those in which the agent is recovered by means of mechanical compression; they are termed "Compression machines." (c) Those in which the agent is recovered by means of absorption by a liquid; they are known as "Absorption machines."

In the first class, since the refrigerating liquid is itself rejected, the only agent cheap enough to be employed is water. The vacuum boiling point of water varies with pressure; thus at machines, one atmosphere or 14.7 lb per square inch it is 212° F., whereas at a pressure of .085 lb per square inch it is 32°, and at lower pressures there is a still further fall in temperature. This property is made use of in vacuum machines. Water at ordinary temperature, say 60°, is placed in an air-tight glass or insulated vessel, and when the pressure is reduced by means of a vacuum pump it begins to boil, the heat necessary for evaporation being taken from the water itself. The pressure being still further reduced, the temperature is gradually lowered until the freezing-point is reached and ice formed, when about one-sixth of the original volume has been evaporated.

The earliest machine of this kind appears to have been made in 1755 by Dr. William Cullen, who produced the vacuum by means of a pump alone. In 1810 Sir John Leslie combined with the air pump a vessel containing strong sulphuric acid for absorbing the vapour from the air, and is said to have succeeded in producing 1 to 1½ lb of ice in a single operation. E. C. Carré later adopted the same principle. In 1878 F. Windhausen patented a vacuum machine for producing ice in large quantities, and in 1881 one of these machines, said to be capable of making about 12 tons of ice per day, was put to work in London. The installation was fully described by Carl Pieper (*Trans. Soc. of Engineers*, 1882, p. 145) and by Dr. John Hopkinson (*Journal of Soc. of Arts*, 1882, vol. xxxi. p. 20). The process, however, not being successful from a commercial point of view, was abandoned. At the present time vacuum machines are only employed for domestic purposes. The hand apparatus invented by H. A. Fleuss consists of a vacuum

pump capable of reducing the air pressure to a fraction of a millimetre, the suction pipe of which is connected first with a vessel containing sulphuric acid, and second with the vessel containing the water to be frozen. Both these vessels are mounted on a rocking base, so that the acid can be thoroughly agitated while the machine is being worked. As soon as the pump has sufficiently exhausted the air from the vessel containing the water, vapour is rapidly given off and is absorbed by the acid until sufficient heat has been abstracted to bring about the desired reduction in temperature, the acid becoming heated by the absorption of water vapour, while the water freezes. The small Fleuss machine will produce about 1½ lb of ice in one operation of 20 minutes. Iced water in a carafe for drinking purposes can be produced in about three minutes. The acid vessel holds 9 lb of acid, and nearly 3 lb of ice can be made for each 1 lb of acid before the acid has become too weak to do further duty. Another machine, which can be easily worked by a boy, will produce 20 to 30 lb of ice in one hour, and is perhaps the largest size practicable with this method of freezing. The temperature attainable depends on the strength and condition of the sulphuric acid; ordinarily it can be reduced to zero F., and temperatures 20° lower have frequently been obtained.

Though prior to 1834 several suggestions had been made with regard to the production of ice and the cooling of liquids by the evaporation of a more volatile liquid than water, the **Compression machines.** first machine actually constructed and put to work was made by John Hague in that year from the designs of Jacob Perkins (*Journal of Soc. of Arts*, 1882, vol. xxxi. p. 77). This machine, though never used commercially, is the parent of all modern compression machines. Perkins in his patent specification states that the volatile fluid is by preference ether. In 1856 and 1857 James Harrison of Geelong, Victoria, patented a machine embodying the same principle as that of Perkins, but worked out in a much more complete and practical manner. It is stated that these machines were first made in New South Wales in 1859, but the first Harrison machine adopted successfully for industrial purposes in England was applied in the year 1867 for cooling oil in order to extract the paraffin. In Harrison's machine the agent used was ether ($C_2H_5)_2O$. Improvements were made by Siebe & Company of London, and a considerable number of ether machines both for ice-making and refrigerating purposes were supplied by that firm and others up to the year 1880. In 1870 the subject of refrigeration was investigated by Professor Carl Linde of Munich, who was the first to consider the question from a thermodynamic point of view. He dealt with the coefficient of performance as a common basis of comparison for all machines, and showed that the compression vapour machine more nearly reached the theoretic maximum than any other (*Bayerisches Industrie und Gewerbeblatt*, 1870 and 1871). Linde also examined the physical properties of various liquids, and, after making trials with methylic ether in 1872, built his first ammonia compression machine in 1873. Since then the ammonia compression machine has been most widely adopted, though the carbonic acid machine, also compression, which was first made in 1880 from Linde's designs, is now used to a considerable extent, especially on board ship.

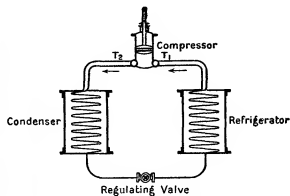

FIG. 2.—Vapour Compression Machine.

A diagram of a vapour compression machine is shown in fig. 2. There are three principal parts, a refrigerator or evaporator, a compression pump, and a condenser. The refrigerator, which

consists of a coil or series of coils, is connected to the suction side of the pump, and the delivery from the pump is connected to the condenser, which is generally of somewhat similar construction to the refrigerator. The condenser and refrigerator are connected by a pipe in which is a valve named the regulator. Outside the refrigerator coils is the air, brine or other substance to be cooled, and outside the condenser is the cooling medium, which, as previously stated, is generally water. The refrigerating liquid (ether, sulphur dioxide, anhydrous ammonia, or carbonic acid) passes from the bottom of the condenser through the regulating valve into the refrigerator in a continuous stream. The pressure in the refrigerator being reduced by the pump and maintained at such a degree as to give the required boiling-point, which is of course always lower than the temperature outside the coils, heat passes from the substance outside, through the coil surfaces, and is taken up by the entering liquid, which is converted into vapour at the temperature T_1 . The vapours thus generated are drawn into the pump, compressed, and discharged into the condenser at the temperature T_2 , which is somewhat above that of the cooling water. Heat is transferred from the compressed vapour to the cooling water and the vapour is converted into a liquid, which collects at the bottom and returns by the regulating valve into the refrigerator. As heat is both taken in and discharged at constant temperature during the change in physical state of the agent, a vapour compression machine must approach the ideal much more nearly than a compressed-air machine, in which there is no such change.

This will be seen by taking as an example a case in which the cold room is to be kept at 10°F . the cooling water being at 60° . Under these conditions, the actual evaporating temperature T_1 , in a well-constructed ammonia compression machine, after allowing for the differences necessary for the exchange of heat, would be about 5° below zero, and the discharge temperature T_2 would be about 75° . An ideal machine, working between 5° below zero and 75° above, has a coefficient of about 5.7, or nearly six times that of an ideal compressed-air machine of usual construction performing the same useful cooling work.

A vapour compression machine does not, however, work precisely in the reversed Carnot cycle, inasmuch as the fall in temperature between the condenser and the refrigerator is not produced, nor is it attempted to be produced, by the adiabatic expansion of the agent, but results from the evaporation of a portion of the liquid itself. In other words, the liquid-refrigerating agent enters the refrigerator at the condenser temperature and introduces heat which has to be taken up by the evaporating liquid before any useful refrigerating effect can be performed. The extent of this loss is determined by the relation between the liquid heat and the latent heat of vaporization at the refrigerator temperature. If r represents the latent heat of the vapour, and q_2 and q_1 the amounts of heat contained in the liquid at the respective temperatures of T_2 and T_1 , then the loss from the heat carried from the condenser into the refrigerator is shown by $(q_2 - q_1)/r$ and the useful refrigerating effect produced in the refrigerator is $r - (q_2 - q_1)$. Assuming, as in the previous example, that T_2 is 75°F . and that T_1 is 5° below zero, the results for various refrigerating agents are as follows:—

TABLE II.

	Latent Heat. r	Liquid Heat. $q_2 - q_1$	Net Refrigeration. $r - (q_2 - q_1)$	Proportion of Loss. $(q_2 - q_1)/r$
Anhydrous ammonia	590.33	72.556	517.774	0.1225
Sulphurous acid	173.13	29.062	144.068	0.168
Carbonic acid	119.85	47.35	72.50	0.395

The results show that the loss is least in the case of anhydrous ammonia and greatest in the case of carbonic acid. At higher condenser temperatures the results are even much more favourable to ammonia. As the critical temperature (88.4°F .) of carbonic acid is approached, the value of r becomes less and less and the refrigerating effect is much reduced. When the critical point is reached the value of r disappears altogether, and a carbonic-acid machine is then dependent for its refrigerating effect on the reduction in temperature produced by the internal work performed in expanding the gaseous carbonic acid from the condenser pressure to that in the refrigerator. The abstraction of heat does not then take place at constant temperature. The expanded vapour enters the refrigerator at a temperature below that of the substance to be cooled, and whatever cooling effect is produced is brought about by the superheating of the vapour, the result being that above the critical point of carbonic acid the difference $T_2 - T_1$ is increased and the efficiency of the machine is reduced. The critical temperature of anhydrous ammonia is about 266°F ., which is never approached in the ordinary working of refrigerating machines. Some of the principal physical properties of sulphurous acid, anhydrous ammonia, and carbonic acid are given in Tables III., IV. and V.

TABLE III.—Leduc's Table for Saturated Sulphur Dioxide Vapour (SO_2).

t Temp. of Ebullition. Degs. Fahr.	Vapour-tension in Pounds per sq. in. Absolute.	g Heat of Liquid from 32°Fahr . B.T.U.	r Latent Heat of Evaporation. B.T.U.	u Volume of one Pound of Saturated Vapour. Cub. ft.
-22	5.546	-19.55	176.98	13.168
-13	7.252	-16.31	174.94	10.268
-4	9.303	-13.05	172.91	8.122
5	11.803	-9.79	170.82	6.504
14	14.789	-6.85	168.75	5.254
23	18.544	-3.26	166.63	4.293
32	22.468	0.00	164.47	3.540
41	27.445	3.27	162.39	2.931
50	33.275	6.55	160.24	2.451
59	39.958	9.83	158.08	2.066
68	47.637	13.10	155.89	1.746
77	56.311	16.38	153.67	1.490
86	66.407	19.69	151.49	1.266
95	77.641	22.99	149.27	1.089
104	90.297	26.28	147.02	0.913

TABLE IV.—Mollier's Table for Saturated Anhydrous Ammonia Vapour (NH_3).

t Temp. of Ebullition. Degs. Fahr.	Vapour-tension in Pounds per sq. in. Absolute.	g Heat of Liquid from 32°Fahr . B.T.U.	r Latent Heat of Evaporation. B.T.U.	u Volume of one Pound of Saturated Vapour. Cub. ft.
-40	10.238	-60.048	690.00	25.630
-31	13.124	-53.064	597.24	20.120
-22	16.920	-45.918	595.08	15.971
-13	21.472	-38.646	593.00	12.783
-4	27.000	-31.212	590.00	10.316
5	33.701	-23.634	586.82	8.394
14	41.522	-15.994	581.00	6.888
23	50.903	-8.028	576.00	5.703
32	61.857	0.000	571.00	4.742
41	74.513	8.172	565.50	3.973
50	89.159	16.506	558.48	3.364
59	105.939	24.966	550.00	2.851
68	124.994	33.588	541.00	2.435
77	146.900	42.354	531.00	2.098
86	170.782	51.282	523.00	1.810
95	197.800	60.336	512.50	1.570
104	227.662	69.552	501.50	1.361

TABLE V.—Mollier's Table for Saturated Carbon Dioxide Vapour (CO_2).

t Temp. of Ebullition. Degs. Fahr.	Vapour-tension in Pounds per sq. in. Absolute.	g Heat of Liquid from 32°Fahr . B.T.U.	r Latent Heat of Evaporation. B.T.U.	u Volume of one Pound of Saturated Vapour. Cub. ft.
-22	213.345	-24.80	126.72	.4330
-13	248.903	-21.06	123.25	.3670
-4	288.727	-17.19	119.43	.3130
5	334.240	-13.17	115.25	.2660
14	385.443	-9.00	110.65	.2295
23	440.913	-4.63	105.53	.1955
32	503.497	0.00	99.81	.1670
41	573.187	4.93	93.35	.1430
50	649.991	10.28	85.93	.1202
59	733.906	16.22	77.40	.1010
68	826.356	23.08	66.47	.0833
77	930.184	31.63	51.80	.0673
86	1039.701	45.45	27.00	.0481
87-8	1062.458	51.61	15.12	.0416
88-43	1070.991	59.24	0.00	.0352

The action of a vapour compression machine is shown in fig. 3. Liquid at the condenser temperature being introduced into the refrigerator through the regulating valve, a small portion evaporates and reduces the remaining liquid to the temperature T_1 . This is shown by the curve AB, and is the useless work represented by the expression $(q_2 - q_1)/r$. Evaporation then continues at the constant temperature T_1 abstracting heat from the substance outside the refrigerator as shown by the line BC. The vapour is then compressed along the line CD to the temperature T_2 , when, by the action of the cooling water in the condenser, heat is abstracted at constant temperature and the vapour condensed along the line DA.

In a compression machine the refrigerator is usually a series of iron or steel coils surrounded by the air, brine or other substance it

is desired to cool. One end (generally the bottom) of the coils is connected to the liquid pipe

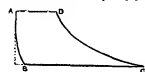

Fig. 3.—Action of Vapour Compression Machine.

the refrigerator, the cooling water being contained in a tank; frequently, however, a series of open coils is employed, the cooling water falling over the coils into a collecting tray below, and this form is perhaps the most convenient for ordinary use as it affords great facilities for inspection and painting. The compressor may be driven by a steam engine or in any other convenient manner. The pressure in the condenser varies according to the temperature of the cooling water, and that in the refrigerator is dependent upon the temperature to which the outside substance is cooled. In an ammonia machine copper and copper alloys must be avoided, but for carbonic acid they are not objectionable.

The compression of ammonia is sometimes carried out on what is known as the "wet" system, and sometimes on the "dry" system. When wet compression is used the regulating valve is opened to such an extent that a little more liquid is passed than can be evaporated in the refrigerator. This liquid enters the compressor with the vapour, and is evaporated there, the heat taken up preventing the rise in temperature during compression which would otherwise take place. The compressed vapour is discharged at a temperature but little above that of the cooling water. With dry compression, vapour alone is drawn into the compressor, and the temperature rises to as much as 180 or 200 degrees. Wet compression theoretically is not quite so efficient as dry compression, but it possesses practical advantages in keeping the working parts of the compressor cool, and it also greatly facilitates the regulation of the liquid, and ensures the full duty of the machine being continuously performed. Very exact comparative trials have been made by Professor M. Schroeter and others with compression machines using sulphur dioxide and ammonia. The results are published in *Vergleichende Versuche an Kältemaschinen*, by Schroeter, Munich, 1890, and in Nos. 32 and 51 of *Bayerisches Industrie und Gewerbeblatt*, 1892. Some of the results obtained by Schroeter in 1893 with an ordinary brine cooling machine on the Linde ammonia system are given in Table VI.—

TABLE VI.

Temperature reduction in refrigerator, Degs. Fahr.	42·8 to 37·4	28·1 to 23	14 to 8·6	-0·4 to -5·8
L.H. in steam cylinder	15·79	16·48	15·20	14·75
L.H. in compressor	14·32	14·3	15·54	17·98
Pressure in refrigerator in pounds per sq. in. above atmosphere . .	45·2	32·6	19·8	0·0
Pressure in condenser in pounds per sq. in. above atmosphere . .	116·0	115·0	130·0	208·0
Heat abstracted in refrigerator, B. T. U. per hour	343192	263400	175375	121218
Heat rejected in condenser, B. T. U. per hour	377567	301200	214347	158504

The principle of the absorption process is chemical or physical rather than mechanical; it depends on the fact that many vapours of low boiling-point are readily absorbed in water, and can be separated again by the application of heat. In its simplest form an absorption machine consists of two iron vessels connected together by a bent pipe. One of these contains a mixture of ammonia and water, which on the application of heat gives off a mixed vapour containing a large proportion of ammonia, a liquid containing but little ammonia being left behind. In the second vessel, which is placed in cold water, the vapour rich in ammonia is condensed under pressure. To produce refrigeration the operation is reversed. On allowing the weak liquor to cool to normal temperature, it becomes greedy of ammonia (at 60° F. at atmospheric pressure water will absorb about 760 times its own volume of ammonia vapour), and this produces an evaporation from the liquid in the vessel previously used as a condenser. This liquid, containing a large proportion of ammonia, gives off vapour at a low temperature, and therefore becomes a refrigerator abstracting heat from water or any surrounding body. When the ammonia is evaporated the operation as described must be again commenced. Such an apparatus is not much used now. Larger and more elaborate machines were made by F. P. E. Carré in France; but no very high degree of perfection was

arrived at, owing to the impossibility of getting an anhydrous product of distillation. In 1867 Rees Reece, taking advantage of the fact that two vapours of different boiling-points, when mixed, can be separated by means of fractional condensation, brought out an absorption machine in which the distillate was very nearly anhydrous. By means of vessels termed the analyser and the rectifier, the bulk of the water was condensed at a comparatively high temperature and run back to the generator, while the ammonia passed into a condenser, and there assumed the liquid form under the pressure produced by the heat in the generator and the cooling action of water circulating outside the condenser tubes.

Fig. 4 is a diagram of an absorption apparatus. The ammonia vapour given off in the refrigerator is absorbed by a cold weak

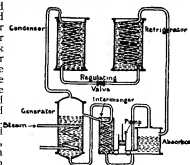

Fig. 4.

liquor from the generator is pumped back into the generator through an interchanger through which also the weak hot liquor from the generator passes on its way to the absorber. In this way the strong liquor is heated before it enters the generator, and the weak liquor is cooled before it enters the absorber.

The generator being heated by means of steam coil, ammonia vapour is driven off at such a pressure as to cause its condensation in the condenser. From the condenser it passes into the refrigerator through a regulating valve in the usual manner. The process is continuous, and is identical with that of the compression machine, with the exception of the return from the temperature T_1 to the temperature T_2 , which is brought about by the direct application of heat instead of by means of mechanical compression. With the same temperature range, however, the same amount of heat has to be acquired in both cases, though from the nature of the process the actual amount of heat demanded from the steam is much greater in the absorption system than in the compression. This is chiefly due to the fact that in the former the heat of vaporization acquired in the refrigerator is rejected in the absorber, so that the whole heat of vaporization has to be supplied again by the steam in the generator. In the latter the vapour passes direct from the refrigerator to the pump, and power has to be expended merely in raising the temperature to a sufficient degree to enable condensation to occur at the temperature of the cooling water. On the other hand, a great advantage is gained in the absorption machine by using the direct heat of the steam, without first converting it into mechanical work, for in this way its latent heat of vaporization can be utilized by condensing the steam in the coils and letting it escape in the form of water. Each pound of steam thus made gives up some 950 units of heat; while in a good steam engine only about 200 units are utilized in the steam cylinder per pound of steam, and in addition allowance has to be made for mechanical inefficiency. In the absorption machine the cooling water has to take up about twice as much heat as in the compression system, owing to the ammonia being twice liquefied—namely, once in the absorber and once in the condenser. It is usual to pass the cooling water first through the condenser and then through the absorber.

The absorption machine is not so economical as the compression; but an actual comparison between the two systems is difficult to make. Information on this head is given in papers read by Dr. Linde and by Professor J. A. Ewing before the Society of Arts (*Journal of the Society of Arts*, vol. xli., 1894, p. 322, and Howard Lectures, January, February and March, 1897).

An absorption apparatus as applied to the cooling of liquids consists of a generator containing coils to which steam is supplied at suitable pressure, an analyser, a rectifier, a condenser either of the submerged or open type, a refrigerator in which the nearly anhydrous ammonia obtained in the condenser is allowed to evaporate, an absorber through which the weak liquor from the generator continually flows and absorbs the anhydrous vapour produced in the refrigerator, and a pump for forcing the strong liquor produced in the absorber back through an economizer into the analyser where, meeting with steam from the generator, the ammonia gas is driven off. The process being thus carried on continuously. Sometimes an additional vessel is employed for heating liquor by means of the exhaust steam from the engine driving the ammonia pump. Absorption machines are also made without a pump for returning the strong liquor to the generator. In these cases they work intermittently. In some machines the same vessel is used alternately as a generator and absorber, while in others, in order

to minimize the loss of time, two vessels are provided which can be used alternately as generators and absorbers.

Applications.—Apart from the economical working of the machine itself, whatever system may be adopted, it is of importance that cold once produced should not be wasted, and it is therefore necessary to use some form of insulation to protect the vessels in which liquids are being cooled, or the rooms of ships' holds in which the freezing or storage processes are being carried on. This insulation generally consists of materials such as charcoal, silicate cotton, granulated cork, small pumice, hair-felt, sawdust, &c., held between layers of wood or brick, and forming a more or less heat-tight box. There is no recognized standard of insulation. For a cold store to be erected inside a brick or stone building, and to be maintained at an internal temperature of from 18° to 20° F., a usual plan is shown in fig. 5. The same insulation is used for the floors and



FIG. 5.—Insulation of a Cold Store.

ceilings, except that the wearing surface of the floor is generally made thicker than the inside lining of the sides. Should the walls or floor be damp, waterproof paper is added. Granulated cork has practically the same insulating properties as silicate cotton, and the same thicknesses may be used. About 10 in. of flake charcoal and vegetable silica, or 11 of small pumice, are required to give the same protection as 7 in. of good silicate cotton. Cork bricks made of compressed granulated cork are frequently used, a thickness of about 5 in. giving the same protection as 7 in. of silicate cotton. The walls and ceilings are finished off with a smooth coating of hard cement and the floors are protected by cement or asphalt, according to the nature of the traffic on them. For lager-beer cellars and fermenting rooms, for bacon-curing cellars, and for similar purposes, brick walls with single or double air spaces are used, and sometimes a space filled with silicate cotton or other insulating material. In Australia and New Zealand pumice, which is found in enormous quantities in the latter country, takes the place of charcoal and silicate cotton. In Canada air spaces are largely used either alone or in combination with silicate cotton or planer shavings. The air spaces, two or three in number, are formed between two layers of tongued and grooved wood, and the total thickness of the insulation is about the same as when silicate cotton alone is used. On board ship charcoal has been almost entirely employed, but silicate cotton and granulated cork are sometimes used. The material is either placed directly up to the skin of the vessel, and kept in place by a double lining of wood inside, in which case a thickness of about 10 in. is used depending upon the depth of the frames, or it is placed between two layers of wood, with an air space next the skin, in which case about 6 in. of flake charcoal is generally sufficient for the insulation of the holds, though for deck-houses and other parts exposed to the sun the thickness must be greater. A layer of sheet zinc or tin has frequently to be used as protection from rats. Given a certain allowable heat transmission, the principal points to be considered in connexion with insulation are, first cost, durability, weight and space occupied, the two last named being specially important factors on board ship. No exact rules can be laid down, as the conditions vary so greatly; and though experiments have been made to determine the actual heat conduction of various materials per unit of surface, thickness and temperature difference, the experience of actual practice is at present the only accepted guide.

With compressed-air machines which discharge the cold air direct into the insulated room or hold, a snow box is provided close to the outlet of the expansion cylinder to catch the snow and congealed oil. The air is distributed by means of wood air trunks with openings controlled by slides, and similar trunks are pro-

vided in connexion with the suction of the compressor to conduct the air back to the machine. With liquid machines of the compression and absorption system, the rooms are either cooled by means of cold pipes or surfaces placed in them, or by a circulation of air cooled in an apparatus separated from the rooms. The cold pipes may be direct-expansion pipes in which the liquid evaporates, or they may be pipes or walls through which circulates an un-congealable brine previously cooled to the desired temperature. The pipes are placed on the ceilings or sides according to circumstances, but they must be arranged so as to induce a circulation of air throughout the compartment and ensure every part being cooled. With what is termed the air circulation system the air is generally circulated by means of a fan, being drawn from the rooms through ducts, passed over a cooler, and returned again to the rooms by other ducts. In some coolers the cooling surfaces consist of direct-expansion pipes placed in clusters of convenient form; in others brine pipes are used; in others there is a shower of cold brine, and in some cases combinations of cold pipes and brine showers. Whether pipes in the rooms or air circulation give the best results is to some extent a matter of opinion, but at the present time the tendency is decidedly in favour of air circulation, at any rate for general cold storage purposes. Whichever system be adopted, it is important for economical reasons that ample cooling surface be allowed, and that all surfaces be kept clean and active, to make the difference between the temperature of the evaporating liquid and the rooms as small as possible. Small surfaces reduce first cost, but involve higher working expenses by decreasing the value of $T_1/(T_2 - T_1)$, and thus demanding more energy, and consequently more fuel, to effect the given result than if larger surfaces were employed.

The general arrangement of an ice factory for producing can ice is shown in fig. 6. The water to be frozen is contained in galvanized

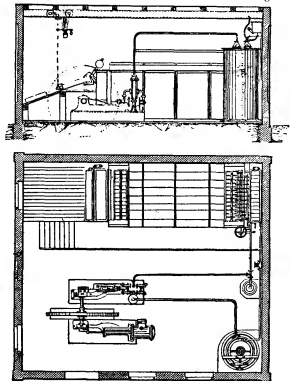

FIG. 6.—General Arrangement of an Ice Factory.

or tinned steel moulds suspended in a tank filled to the proper level with brine maintained at the desired temperature. The moulds are frequently arranged in frames, so that by means of an overhead crane one complete row is lifted at a time. When the water is frozen the moulds are dipped in a tank containing warm water, and on being tipped the blocks of ice fall out. Ordinary water contains air, and ice made from it is generally opaque, due to the inclusion of numerous small air-bubbles. To produce clear ice the water must be agitated during the freezing process, or previously boiled to get rid of the air. Distilled water is frequently used, as well as the water produced by the condensation of the steam from the engine, which of course must be thoroughly purified and filtered. It should be noted, however, that with an ice-making plant of moderate size and a steam-engine of good construction the weight of steam used will not nearly equal the weight of ice produced, so that the difference must be made up either by distillation, which is a costly process, or by ordinary water. Can ice is usually made in blocks weighing 56, 112 or 224 lb, and from 4 to 8 in. thick. For cell ice ordinary water is used, agitated

during freezing. The cells are flat and constructed of galvanized iron, so as to form a hollow space of about 2 in. in width, through which cold brine is circulated by a pump. They are placed vertically in a tank, the distance between them being from 8 to 14 in., according to the thickness of the ice to be produced. The tank is filled with water, which is kept in agitation by means of a reciprocating paddle or piston; in this way the air escapes, and with proper care a block of great transparency is produced. To thaw it off, warm brine is circulated through the cells. A usual size for cell ice is 4 ft. by 3 ft. by 1 ft. mean thickness, the weight being about 6 cwt. If perfectly transparent ice is required, the two sides of the block are not allowed to join up, and it is then called plate ice, which is often made in very large blocks, afterwards divided by saws or steam cutters. In such cases the evaporation of the ammonia or other refrigerating liquid frequently takes place in the cells themselves, brine being dispensed with. With a well-constructed can ice-plant of say 25 tons capacity per day, from 15 to 16 tons of ice should be made in Great Britain to a ton of best steam coal. For cell and plate ice the production is considerably below this, and the first cost of the plant is much greater than that for can ice.

Fig. 7 shows an arrangement of cold storage on land, refrigerated on the air circulation system. The insulated rooms, on two floors,

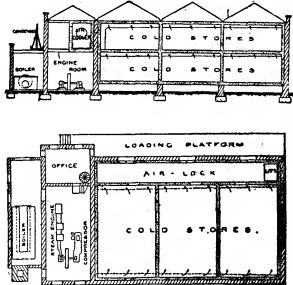

FIG. 7.—Cold Stores.

are approached by corridors, so as to exclude external air, which if allowed to enter would deposit moisture upon the cold goods. The air cooler is placed at the end, and the air is distributed by means of wood ducts furnished with slides for regulating the temperature of the rooms, which are insulated according to the method shown in fig. 5. In some cases, instead of the entrance being at the sides or ends, it is at the top, all goods being raised to the top floor in lifts and lowered by lifts into the rooms. With good machinery the cost of raising is not great, and is probably equalled by the saving in refrigeration, since the rooms hold the heavy cold air as a glass holds water.

Large passenger vessels and yachts are now generally fitted with refrigerating machinery for preserving provisions, cooling water and wine, and making ice. Usually two insulated compartments are provided, one for frozen meats at about 20° F., and one for vegetables, &c., at about 40°. They have a capacity of from 1500 to 3000 cub. ft. or more, according to the number of passengers carried, and they are generally cooled by means of brine pipes, though direct expansion and air circulation are sometimes adopted. A passenger vessel requires from 2 to 4 cwt. of ice per day. On battleships and cruisers the British Admiralty use small compressed-air machines for ice-making, and larger machines, generally on the carbonic-acid system, for cooling the magazines. A modern frozen-meat-carrying vessel will accommodate as much as 120,000 carcasses, partly sheep and partly lambs, requiring a hold capacity of about 300,000 cub. ft. In some vessels both fore and aft holds and 'tween decks are insulated. Lloyd's Committee now issue certificates for refrigerating installations, if constructed according to their rules, and most modern cargo-carrying vessels have their refrigerating machinery classed at Lloyd's. In the meat trade between the River Plate, the United States, Canada and Great Britain, ammonia or carbonic acid machines are now exclusively used, but for the Australian and New Zealand frozen-meat trade compressed-air machines are still employed to a small extent. The holds of meat-carrying vessels are refrigerated either by cold air circulation or by brine pipes.

Though the adoption of refrigerating and ice-making machinery for industrial purposes practically dates from the year 1880, the manufacture of these machines has already assumed very great proportions; indeed, in no branch of mechanical engineering, with the exception of electrical machinery, has there been so remarkable a development in recent years. The sphere of application is extending year by year. The cooling of residential and public buildings in hot countries, though attempted in a few cases in the United States and elsewhere, is yet practically untouched, the manufacture of ice and the preservation of perishable foods (apart from the frozen and chilled meat trades) have in many countries hardly received serious consideration, but in breweries, dairies, margarine works and many other industries there is a large and increasing field for refrigerating and ice-making machinery. A recent application is in the cooling and drying of the air blast for blast furnaces. Though this matter had been discussed for some years, it was only in 1904 that the first plant was put to work at Pittsburg.

For further information reference may be made to the following: Siebel, *Compend. of Mechanical Refrigeration* (Chicago); Redwood, *Theoretical and Practical Ammonia Refrigeration* (New York); Stephansky, *Practical Running of an Ice and Refrigerating Plant* (Boston); Ledoux, *Ice-Making Machines* (New York); Wallis-Taylor, *Refrigerating and Ice-Making Machines* (London); Ritchie Leask, *Refrigerating Machinery* (London); De Volson Wood, *Thermodynamics, Heat Motors and Refrigerating Machinery* (New York); Linde, *Kälteerzeugungsmaschine Lexikon der gesamten Technik*; Behrend, *Eis und Kälteerzeugungsmaschinen* (Halle); De Marchena, *Kompressions Kältemaschinen* (Halle); Theodore Koller, *Die Kälteindustrie* (Vienna); Voorhes, *Indicating the Refrigerating Machine* (Chicago); Norman Selpe, *Machinery for Refrigeration* (Chicago); Hans Lorenz, *Moderne Refrigerating Machinery* (London); Lehnert, *Moderne Kältechnik* (Leipzig); L. Marchis, *Production et utilisation du froid* (Paris); C. Heinel, *Bau und Betrieb von Kältemaschinen Anlagen* (Oldenburg); R. Stetefeld, *Eis und Kälteerzeugungsmaschinen* (Stuttgart). (T. B. L.)

REGAL, a small late-medieval portable organ, furnished with beating-reeds and having two bellows like a positive organ; also in Germany the name given to the reed-stops (beating-reeds) of a large organ, and more especially the "vox humana" stop. The name was not at first applied to the small table instrument, but to certain small brass pipes in the organ, sounded by means of beating-reeds, the longest of the 8-ft. tone being but 5½ in. long. Praetorius (1618) mentions a larger regal used in the court orchestras of some of the German princes, more like a positive, containing 4-ft., 8-ft. and even sometimes 16-ft. tone reeds, and having behind the case two bellows. These regals were used not only at banquets but often to replace positives in small and large churches. The very small regal, sometimes called *Bible-regal*, because it can be taken to pieces and folded up like a book, is also mentioned by the same writer, who states that these little instruments, first made in Nuremberg and Augsburg, have an unpleasantly harsh tone, due to their tiny pipes, not quite an inch long. The pipes in this case were not intended to reinforce the vibrations of the beating-reed or of its overtones as in the reed pipes of the organ, but merely to form an attachment for keeping the reed in its place without interfering with its functions. The beating-reed itself in the older organs of the early middle ages, many of which undoubtedly were reed organs, was made of wood; those of the regal were mostly of brass (hence their "brazen voices"). The length of the vibrating portion of the beating-reed governed the pitch of the pipe and was regulated by means of a wire passing through the socket, the other end pressing on the reed at the proper distance. Drawings of the reeds of regals and other reed-pipes, as well as of the instrument itself, are given by Praetorius (pl. iv., xxxviii).

There is evidence to show that in England, and France also, the word "regal" was applied to reed-stops on the organ; Mersenne (1636) states that "now the word is applied to the vox humana stop on the organ." In England, as late as the reign of George III., there was the appointment of "tuner of the regals" to the Chapel Royal.

The reed-stops required constant tuning, according to Praetorius, who lays special emphasis on the fact that the pitch of the reed-pipes alone falls in summer and rises in winter.

During the 16th and 17th centuries the regal was a very great favourite, and although, owing to the civil wars and the ravages

of time, very few specimens now remain, the regalia are often mentioned in old wills and inventories, such as the list of Henry VIII.'s musical instruments made after his death by Sir Philip Wilder (Brit. Mus. Harleian MS. 1415, fol. 200 seq.), in which no fewer than thirteen pairs of single and five pairs of double regalia are mentioned. Monteverde scored for the regalia in his operas, and the instrument is described and figured by S. Viridung in 1511, Martin Agricola in 1528, and Ottmar Luscinus in 1536, as well as by Michael Praetorius in 1618. (K. S.)

REGALIA (Lat. *regalis*, royal, from *rex*, king), and escutres of royalty. The crown (see CROWN and CORONET) and sceptres (see SCEPTRE) are dealt with separately. Other ancient symbols of royal authority are bracelets, the sword, a robe or mantle, and, in Christian times, a ring. Bracelets, as royal emblems, are mentioned in the Bible in connexion with Saul (2 Sam. i. 10), and they have been commonly used by Eastern monarchs. In Europe their later use seems to have been fitfully confined to England, although they were a very ancient ornament for kings among the Teutonic races. Two coronation bracelets are mentioned among the articles of the regalia ordered to be destroyed at the time of the Commonwealth, and two new ones were made at the Restoration. These are of gold, $1\frac{1}{2}$ in. in width, and ornamented with the rose, thistle, harp and fleur-de-lis in enamel round them. They have not been used for modern coronations.

The sword is one of the usual regalia of most countries, and is girded on to the sovereign during the coronation. In England the one sword has been developed into five. The Sword of State is borne before the sovereign on certain state occasions, and at the coronation is exchanged for a smaller sword, with which the king is ceremonially girded. The three other swords of the regalia are the "Curtana," the Sword of Justice to the Spirituality, and the Sword of Justice to the Temporality. The Curtana has a blade cut off short and square, indicating thereby the quality of mercy.

The mantle, as a symbol of royalty, is almost universal, but in the middle ages other quasi-priestly robes were added to it (see CORONATION). The English mantle was formerly made of silk; latterly cloth of gold has been used. The ring, by which the sovereign is wedded to his kingdom, is not of so wide a range of usage. That of the English kings held a large ruby with a cross engraved on it. Recently a sapphire has been substituted for the ruby. Golden spurs, though included among the regalia, are merely used to touch the king's feet, and are not worn.

The orb and cross was not anciently placed in the king's hands during the coronation ceremony, but was carried by him in the left hand on leaving the church. It is emblematical of monarchical rule, and is only used by a reigning sovereign. The idea is undoubtedly derived from the globe with the figure of Victory with which the Roman emperors are depicted. The larger orb of the English regalia is a magnificent ball of gold, 6 in. in diameter, with a band round the centre edged with gems and pearls. A similar band arches the globe, on the top of which is a remarkably fine amethyst $1\frac{1}{2}$ in. in height, upon which rests the cross of gold outlined with diamonds. There is a smaller orb made for Mary II., who reigned jointly with King William III.

The English regalia, with one or two exceptions, were made for the coronation of Charles II. by Sir Robert Vyner. The Scottish regalia preserved at Edinburgh comprise the crown, dating, in part, from Robert the Bruce, the sword of state given to James IV. by Pope Julius II., and two sceptres.

Besides regalia proper, certain other articles are sometimes included under the name, such as the ampulla for the holy oil, and the coronation spoon. The ampulla is of solid gold in the form of an eagle with outspread wings. It weighs 10 oz., and holds 6 oz. of oil. The spoon was not originally used for its present purpose. It is of the 12th or 13th century, with a long handle and egg-shaped bowl. Its history is quite unknown. See Cyril Davenport, *The English Regalia*, with illustrations in colour of all the regalia; Leopold Wickham Legg, *English Coronation Records: The Ancestor*, Nos. 1 and 2 (1902); Menin, *The Form, &c., of Coronations* (translated from French, 1727).

REGENERATION OF LOST PARTS. A loss and renewal of living material, either continual or periodical, is a familiar occurrence in the tissues of higher animals. The surface of the human skin, the inner lining of the mouth and respiratory organs, the blood corpuscles, the ends of the nails, and many other portions of tissues are continuously being destroyed and replaced. The hair of many mammals, the feathers of birds, the epidermis of reptiles, and the antlers of stags are shed and replaced periodically. In these normal cases the regeneration depends on the existence of special formative layers or groups of cells, and must be regarded in each case as a special adaptation, with individual limitations and peculiarities, rather than as a mere exhibition of the fundamental power of growth and reproduction displayed by living substance. Many tissues, even in the highest animals, are capable of replacing an abnormal loss of substance. Thus in mammals, portions of muscular tissue, of epithelium, of bone, and of nerve, after accidental destruction or removal, may be renewed. The characteristic feature of such cases appears to be, in the higher animals at any rate, that lost cells are replaced only from cells of the same morphological order—epiblastic cells from the epiblast, mesoblastic from the mesoblast, and so forth. It is also becoming clear that, at least in the higher animals, regeneration is in intimate relation with the central nervous system. The process is in direct relation to the general power of growth and reproduction possessed by protoplasm, and is regarded by pathologists as the consequence of "removal of resistances to growth." It is much less common in the tissues of higher plants, in which the adult cells have usually lost the power of reproduction, and in which the regeneration of lost parts is replaced by a very extended capacity for budding. Still, more complicated reproductions of lost parts occur in many cases, and are more difficult to understand.

In Amphibia the entire epidermis, together with the slime-glands and the integumentary sense-organs, is regenerated by the epidermic cells in the vicinity of the defect. The whole limb of a Salamander or a Triton will grow again and again after amputation. Similar renewal is either rarer or more difficult in the case of Siren and Proteus. Frogs regeneration of amputated limbs does not usually take place, but instances have been recorded. Chelonians, crocodiles and snakes are unable to regenerate lost parts to any extent, while lizards and geckos possess the capacity in a high degree. The capacity is absent almost completely in birds and mammals. In coelenterates, worms, and tunicates the power is exhibited in a very varying extent. In Hydra, Nais, and Lumbriculus, after transverse section, each part may complete the whole animal. In most worms the greater, and in particular the anterior part, will grow a new posterior part, but the separated posterior portion dies. In Hydra, sagittal and horizontal amputations result in the completion of the separated parts. In worms such operations result in death, which no doubt may be a mere consequence of the more severe wound. Extremely interesting instances of regeneration are what are called "Heteromorphoses," where the removed part is replaced by a dissimilar structure. The tail of a lizard, grown after amputation, differs in structure from the normal tail: the spinal cord is replaced by an epithelial tube which gives off no nerves; the vertebrae are replaced by an unsegmented cartilaginous tube; very frequently "super-regeneration" occurs, the amputated limb or tail being replaced by double or multiple new structures.

J. Loeb produced many heteromorphoses on lower animals. He lopped off the polyp head and the pedal disc of a *Tubularia*, and supported the lopped stem in an inverted position in the sand; the original pedal end, now superior, gave rise to a new polyp head, while the neck-end, on regeneration, formed a pedal disc. In *Ceriatulus*, a sea-anemone, and in *Glyme*, an ascidian, regeneration after his operations resulted in the formation of new mouth-openings in abnormal places, surrounded by elaborate structures characteristic of normal mouths. Other observers have recorded heteromorphoses in Crustacea, where antennulae have been regenerated in place of eyes. It appears that, in the same fashion as more simply organized animals display a capacity for reproduction of lost parts greater than that of higher animals, so embryos and embryonic structures generally have a higher power of renewal than that displayed by the corresponding adult organs or organisms. Moreover, experimental work on the young stages of organisms has revealed a similar series of "super-regeneration" in heteromorphoses in adult tissues, but more extended in range. H. Driesch, O. Hertwig and others, by separating the segmentation spheres, by destroying some of them, by compressing young embryos by glass plates, and by many other means, have caused cells to develop

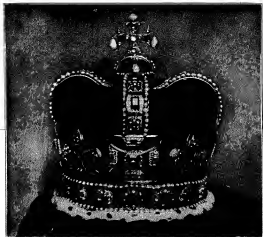

1.—ST. EDWARD'S CROWN. The ancient crown was destroyed at the Commonwealth, and a model made for Charles II's coronation.



2.—THE IMPERIAL STATE CROWN as worn by Queen Victoria. The Black Prince's ruby is in the centre. Modifications in the cap were made for the coronation of King Edward VII, and the smaller "Cullinan" diamond substituted for the sapphire below the ruby.



3.—QUEEN ALEXANDRA'S CORONATION CROWN, with the Koh-i-Noor in centre.



4.—THE CORONET OF THE PRINCE OF WALES.



5.—THE LARGER OR KING'S ORB.

The illustrations on these plates are, except where otherwise stated, reproduced by permission from the unique collection of photographs in the possession of SIR BENJAMIN STONE, formerly M. P. for East Birmingham.



6.—THE LESSER OR QUEEN'S ORB.

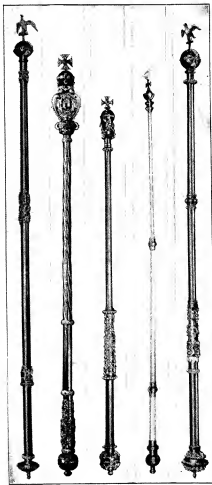

1.—THE SCEPTRES: (a) The Scepter with the Dove; (b) The Royal Scepter with the Cross (cf. Fig. 5), (c) The Queen's Scepter with the Cross; (d) The Queen's Ivory Rod; (e) The Queen's Scepter with the Dove



2.—THE CORONATION SPOON.



3.—THE HEAD OF THE ROYAL SCEPTER with the largest of the "Star of Africa" (Gulistan) Diamonds. Photo, W. E. Gray.

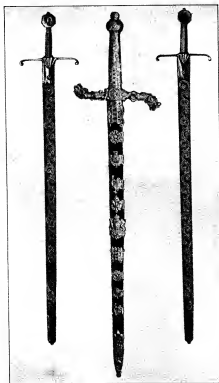

4.—THE SWORDS: (a) The Spiritual Sword of Justice; (b) The Sword of State; (c) The Temporal Sword of Justice. Photo, W. E. Gray.

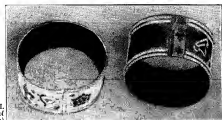

5.—THE BRACELETS.



6.—THE AMPULLA.

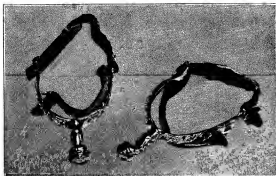

7.—THE ST GEORGE'S SPURS.



1.—THE SILVER-GILT CHRISTENING FONT, made for Charles II.

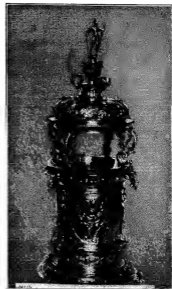

2.—QUEEN ELIZABETH'S SALT-CELLAR.



3.—SILVER-GILT ALTAR DISH, used at Christmas and Easter in the Chapel of St Peter ad Vincula, Tower of London.

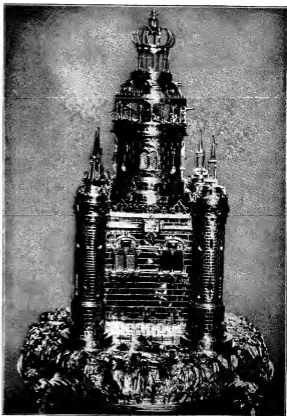

4.—THE GOLD SALT-CELLAR, presented to the Crown by the City of Exeter.

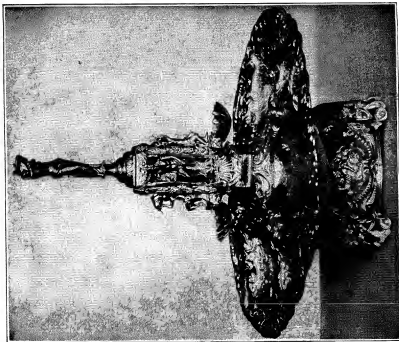

2.—THE WINE FOUNTAIN, presented to Charles II, by the Corporation of Plymouth.



4.—SILVER GILT ALTAR DISH, dated 1666, with representation of the Last Supper; it forms part of the Altar plate at the Coronation and is in the custody of the Sub-Deans of the Chapels Royal.

so as to give rise to structures which in normal development they would not have formed.

It is clear that there are at least three kinds of factors involved in regeneration. There are: (1) Regenerations due to the presence of undifferentiated, or little differentiated, cells, which have retained the normal capacity of multiplication when conditions are favourable. (2) Regenerations due to the presence of special complicated rudiments, the stimulus to the development of which is the removal of the fully formed structure. (3) Regeneration involving the general capacity of protoplasm to respond to changes in the surroundings by changes of growth. The most general view is to regard regenerations as special adaptations; and A. Weismann, following in this matter Arnold Lang, has developed the idea at considerable length, and has found a place for regenerations in his system of the germ-plasm (see HEREDITY) by the conception of the existence of "accessory determinants." Hertwig, on the other hand, attaches great importance to the facts of regeneration as evidence for his view that every cell of a body contains a similar essential plasma.

In E. Schwabe's *Morphologie der Minbildungen* (1904), part i. chap. v., an attempt is made to associate the facts of regeneration with those of embryology and pathology. Our knowledge of the facts, however, is not yet systematic enough to allow of important general conclusions. The power of regeneration appears to be in some cases a special adaptation, but more often simply an expression of the general power of protoplasm to grow and to reproduce its kind. It has been suggested that regenerated parts always represent ancestral stages, but there is no conclusive evidence for this view. (P. C. M.)

REGENSBURG (RATISBON), a city and episcopal see of Germany, in the kingdom of Bavaria, and the capital of the government district of the Upper Palatinate. Pop. (1905) 48,412. It is situated on the right bank of the Danube, opposite the influx of the Regen, 86 m. by rail N.E. from Munich, and 60 m. S.E. of Nuremberg. On the other side of the river is the suburb Stadt-am-Hof, connected with Regensburg by a long stone bridge of the 12th century, above and below which are the islands of Oberer and Unterer Wörth. In appearance the town is quaint and romantic, presenting almost as faithful a picture of a town of the early middle ages as Nuremberg does of the later. One of the most characteristic features in its architecture is the number of strong loop-holed towers attached to the more ancient dwellings. The interesting "street of the envoys" (*Gesandtenstrasse*) is so called, because it contained the residences of most of the envoys to the German diet, whose coats-of-arms may still be seen on many of the houses.

The cathedral, though small, is a very interesting example of pure German Gothic. It was founded in 1275, and completed in 1634, with the exception of the towers, which were finished in 1869. The interior contains numerous interesting monuments, including one of Peter Vischer's masterpieces. Adjoining the cloisters are two chapels of earlier date than the cathedral itself, one of which, known as the "old cathedral," goes back perhaps to the 8th century. The church of St James—also called Schottenkirche—a plain Romanesque basilica of the 12th century, derives its name from the monastery of Irish Benedictines ("Scoti") to which it was attached; the principal doorway is covered with very singular grotesque carvings. The old parish church of St Ulrich is a good example of the Transition style of the 13th century, and contains a valuable antiquarian collection. Examples of the Romanesque basilica style are the church of Obermünster, dating from 1010, and the abbey church of St Emmeran, built in the 13th century, and remarkable as one of the few German churches with a detached belfry. The beautiful cloisters of the ancient abbey, one of the oldest in Germany, are still in fair preservation. In 1809 the conventual buildings were converted into a palace for the prince of Thurn and Taxis, hereditary postmaster-general of the Holy Roman Empire. The town hall, dating in part from the 14th century, contains the rooms occupied by the imperial diet from 1663 to 1806. An historical interest also attaches to the *Gasthof zum Goldenen Kreuz* (Golden Cross Inn),

where Charles V. made the acquaintance of Barbara Blomberg, the mother of Don John of Austria (b. 1547). The house is also shown where Kepler died in 1630. Perhaps the most pleasing modern building in the city is the Gothic villa of the king of Bavaria on the bank of the Danube. At Kumpfmühl, in the immediate neighbourhood of the city, was discovered, in 1885, the remains of a Roman camp with an arched gateway; the latter, known as the *Porta Praetoria*, was cleared in 1887. Among the public institutions of the city should be mentioned the public library, picture gallery, botanical garden, and the institute for the making of stained glass. The educational establishments include two *gymnasias*, an episcopal clerical seminary, a seminary for boys and a school of church music. Among the chief manufactures are iron and steel wares, pottery, parquet flooring, tobacco, and lead pencils. Boat-building is also prosecuted, and a brisk transit trade is carried on in salt, grain and timber.

Near Regensburg are two very handsome classical buildings, erected by Louis I. of Bavaria as national monuments of German patriotism and greatness. The more imposing of the two is the Walhalla, a costly reproduction of the Parthenon, erected as a Teutonic temple of fame on a hill rising from the Danube at Donaustraub, 6 m. to the east. The interior, which is as rich as coloured marbles, gilding, and sculptures can make it, contains the busts of more than a hundred German worthies. The second of King Louis's buildings is the Befreiungshalle at Kelheim, 14 m. above Regensburg; a large circular building, which has for its aim the glorification of the heroes of the war of liberation in 1813.

The early Celtic settlement of *Radespona* (L. Lat. *Ratisbona*) was chosen by the Romans, who named it *Castra Regina*, as the centre of their power on the upper Danube. It is mentioned as a trade centre as early as the 2nd century. It afterwards became the seat of the dukes of Bavaria, and one of the main bulwarks of the East Frankish monarchy; and it was also the focus from which Christianity spread over southern Germany. St Emmeran founded an abbey here in the middle of the 7th century, and St Boniface established the bishopric about a hundred years later. Regensburg acquired the freedom of the empire in the 13th century, and was for a time the most flourishing city in southern Germany. It became the chief seat of the trade with India and the Levant, and the boatmen of Regensburg are frequently heard of as expediting the journeys of the Crusaders. The city was loyally Ghibelline in its sympathies, and was a favourite residence of the emperors. Numerous diets were held here from time to time, and after 1663 it became the regular place of meeting of the German diet. The Reformation found only temporary acceptance at Regensburg, and was met by a counter-reformation inspired by the Jesuits. Before this period the city had almost wholly lost its commercial importance owing to the changes in the great highways of trade. Regensburg had its due share in the Thirty Years' and other wars, and is said to have suffered in all no fewer than seventeen sieges. In 1807 the town and bishopric were assigned to the prince-primate Dalberg, and in 1810 they were ceded to Bavaria. After the battle of Eggenmühl in 1809 the Austrians retired upon Regensburg, and the pursuing French defeated them again beneath its walls and reduced a great part of the city to ashes.

See Gemeiner, *Chronik der Stadt und des Hochstifts Regensburg* (4 vols., Regensburg, 1800-24); *Chroniken der deutschen Städte*, vol. xv. (Leipzig, 1878); Count v. Waldersdorf, *Regensburg in seiner Vergangenheit und Gegenwart* (4th ed., Regensburg, 1896); Fink, *Regensburg in seiner Vorzeit und Gegenwart* (6th ed., Regensburg, 1903); and Schratz, *Führer durch Regensburg* (5th ed., G. Dengler, Regensburg, 1904).

REGENT (from Lat. *regere*, to rule), one who rules or governs, especially one who acts temporarily as an administrator of the realm during the minority or incapacity of the king. This latter function, however, is one unknown to the English common law. "In judgment of law the king, as king, cannot be said to be a minor, for when the royal body politic of the king doth meet with the natural capacity in one person the whole body shall have the quality of the royal politic, which is the greater and more worthy and wherein is no minority. For *omne majus continet in se minus*" (Coke upon Littleton, 43a). But for reasons of necessity a regency, however anomalous it may be in strict law, has frequently been constituted both in England and Scotland. The earliest instance in English history is the appointment of the earl of Pembroke with the assent of the loyal barons on the accession of Henry III.

Whether or not the sanction of parliament is necessary for the appointment is a question which has been much discussed. Lord Coke recommends that the office should depend on the will of

parliament (*Inst.*, vol. iv. p. 58), and in modern times provision for a regency has always been made by act of parliament. In Scotland the appointment of regents was always either by the assent of a council or of parliament. Thus in 1315 the earl of Moray was appointed regent by Robert I. in a council. At a later period appointments by statute was the universal form. Thus by an act of 1342 the earl of Arran was declared regent during the minority of Mary. By an act of 1567 the appointment by Mary of the earl of Moray as regent was confirmed. As late as 1704 provision was made for a regency after the death of Anne. The earliest regency in England resting upon an express statute was that created by 28 Hen. VIII. c. 7, under which the king appointed his executors to exercise the authority of the crown till the successor to the crown should attain the age of eighteen or if a male sixteen if a female. They were to protect the rights to the crown for Somerset, with the assent of the lords spiritual and temporal. No other example of a statutory provision for a regency occurs till 1751. In that year the act of 24 Geo. II. c. 24 constituted the princess-dowager of Wales regent of the kingdom in case the crown should descend to any of her children before such child attained the age of eighteen. A council, called the council of regency, was appointed to assist the princess. A prescribed oath was to be taken by the regent and members of the council. Their conduct was to be regulated by the laws of the kingdom as they were during minority. It was declared to be unlawful for the regent to make war or peace, or ratify any treaty with any foreign power, or prorogue, adjourn or dissolve any parliament without the consent of the majority of the council of regency, or give her assent to any bill for repealing or varying the Act of Settlement, the Act of Uniformity, or the Act of the Scottish parliament for securing the Protestant religion and Presbyterian church government in Scotland (1707, c. 6). That is an invariable provision, and occurs in all subsequent Regency Acts. The reign of George III. affords examples of provision for a regency during both the infancy and incapacity of a king.

The act of 5 Geo. III. c. 27 vested in the king power to appoint a regent under the sign manual, such regent to be one of certain named members of the royal family. The remaining provisions closely followed those of the act of George II. In 1788 the incapacity of the king led to the introduction of a Regency Bill. In the course of the debate in the House of Lords the Duke of York disclaimed on behalf of the prince of Wales any right to assume the regency without the consent of parliament. Owing to the king's recovery the bill ultimately dropped. On a return of the malady in 1810 the act of 51 Geo. III. c. 1 was passed, appointing the prince of Wales regent during the king's incapacity. The royal assent was given by commission authorized by resolution of both Houses. By this act no council of regency was appointed. There was no restriction on the regent's authority over treaties, peace and war, or parliament, as in the previous acts, but his power of granting peerages, offices and pensions was limited. At the accession of William IV. the duchess of Kent was, by 1 Will. IV. c. 2, appointed regent, if necessary, until the Princess Victoria should attain the age of eighteen. No council of regency was appointed. By 1 Vict. c. 72 lords justices were nominated as a kind of regency council without a regent in case the successor to the crown should be out of the realm at the queen's death. They were restricted from granting peerages, and from dissolving parliament without directions from the successor. By 3 & 4 Vict. c. 52 Prince Albert was appointed regent in case any of Queen Victoria's children should succeed to the crown under the age of eighteen. The only restraint on his authority was the usual prohibition to assent to any bill repealing the Act of Settlement, &c. When George V. came to the throne a Regency Bill was again required, as his eldest son was under age, and Queen Mary was appointed. By 10 Geo. IV. c. 7 the office of regent of the United Kingdom cannot be held by a Roman Catholic. A similar disability is imposed in most, if not all, Regency Acts.

REGGIO CALABRIA (anc. *Regium, q.v.*), a town and archiepiscopal see of Calabria, Italy, capital of the province of Reggio, on the Strait of Messina, 248 m. S.S.E. from Naples by rail. Pop. (1906) 39,941 (town); 48,362 (commune). It is the terminus of the railways from Naples along the west coast, and from Metaponto along the east coast of Calabria. The straits are here about 7 m. wide, and the distance to Messina nearly 10 m. The ferryboats to Messina therefore cross by preference from Villa S. Giovanni, 8 m. N. of Reggio, whence the distance is only 5 m. In 1894 the town suffered from an earthquake, though less severely than in 1783. It was totally destroyed, however, by the great earthquake of December 1908; in the centre of the town about 35,000 out of 40,000 persons perished. The cathedral, which dated from the 17th century, and the ancient castle which rose above it, were wrecked. Great damage was done by a seismic wave following the shock. The sea front was swept away, and the level of the land hereabouts was lowered. (See further **MESSINA**.)

REGGIO NELL' EMILIA, a city and episcopal see of Emilia, Italy, the capital of the province of Reggio nell' Emilia (till 1859 part of the duchy of Modena), 38 m. by rail N.W. of Bologna. Pop. (1906) 19,681 (town); 64,548 (commune). The cathedral, originally erected in the 12th century, was reconstructed in the 15th and 16th; the façade shows traces of both periods, the Renaissance work being complete only in the lower portion. S. Prospero, close by, has a façade of 1504, in which are incorporated six marble lions belonging to the original Romanesque edifice. The Madonna della Ghiara, built in 1597 in the form of a Greek cross, and restored in 1900, is beautifully proportioned and finely decorated in stucco and with frescoes of the Bolognese school of the early 17th century. There are several good palaces of the early Renaissance, a fine theatre (1857) and a museum containing important palaeo-ethnological collections, ancient and medieval sculptures, and the natural history collection of Spallanzani. Ludovico Ariosto, the poet (1474-533), was born in Reggio, and his father's house is still preserved. The industries embrace the making of cheese, objects in cement, matches, and brushes, the production of silkworms, and printing; and the town is the centre of a rich agricultural district. It lies on the main line between Bologna and Milan, and is connected by branch lines with Guastalla and Sassuolo (hence a line to Modena).

Regium Lepidi or Regium Lepidum was probably founded by M. Aemilius Lepidus at the time of the construction of the Via Aemilia (187 B.C.). It lay upon this road, half-way between Mutina and Parma. It was during the Roman period a flourishing municipium, but perhaps never became a colony; and it is associated with no event more interesting than the assassination of M. Brutus, the father of Caesar's friend and foe. The bishopric dates perhaps from the 4th century A.D. Under the Lombards the town was the seat of dukes and counts, in the 12th and 13th centuries it formed a flourishing republic, busied in surrounding itself with walls (1220), controlling the Crostolo and constructing navigable canals to the Po, coining money of its own, and establishing prosperous schools. About 1290 it first passed into the hands of Obizzo d'Este, and the authority of the Este family was after many vicissitudes more formally recognized in 1409. In the contest for liberty which began in 1796 and closed with annexation to Piedmont in 1859, Reggio took vigorous part.

REGICIDE (Lat. *rex*, a king, and *caedere*, to kill), the name given to any one who kills a sovereign. Regicides is the name given in English history at the Restoration of 1660 to those persons who were responsible for the execution of Charles I. On the 4th of April 1660 Charles II. in the Declaration of Breda promised a free pardon to all his subjects "excepting only such persons as shall hereafter be excepted by parliament," and on the 14th of May the House of Commons ordered the immediate arrest of "all those persons who sat in judgment upon the late king's majesty when sentence was pronounced." The number of regicides was estimated at 84, this number being composed of the 67 present at the last sitting of the court of justice, 11 others who had attended earlier sittings, 4 officers of the court and the 2 executioners. Many of them were arrested or surrendered themselves, and the House of Commons in considering the proposed bill of indemnity suggested that only twelve of the regicides, who were named, should forfeit their lives; but the House of Lords urged that all the king's judges, with three exceptions, and some others, should be treated in this way.

Eventually a compromise was agreed upon, and the bill as passed on the 29th of August 1660 divided the regicides into six classes for punishment: (1) Four of them, although dead—Cromwell, Ireton, Bradshaw and Pride—were to be attainted for high treason. (2) The estates of twenty others, also dead, were to be subjected to fine or forfeiture. (3) Thirty living regicides were exempted from all indemnity. (4) Nineteen living regicides were also exempted, but with a saving clause that their execution was to be suspended until a special act of parliament was passed for this purpose. (5) Six others were to be punished, but not capitally. (6) Two, Colonels Hutchinsons and Thomas Lister, were simply declared incapable of holding any office. Two regicides—Ingoldby, who declared he had only signed the warrant under compulsion, and Colonel Matthew Thomlinson—escaped without punishment. A court of thirty-four commissioners was then appointed to try the regicides, and the trial took place in October 1660. Twenty-nine were condemned to death, but only ten were actually executed, the remaining nineteen

with six others being imprisoned for life. The ten who were executed at Charing Cross or Tyburn, London, in October 1666, were Thomas Harrison, John Jones, Adrian Scrope, John Carew, Thomas Scot, and Gregory Clement, who had signed the death-warrant; the preacher Hugh Peters; Francis Hacker and Daniel Axtel, who commanded the soldiers at the trial and the execution of the king; John Cook, the solicitor who directed the prosecution. In January 1661 the bodies of Cromwell, Ireton, and Bradshaw were exhumed and hanged at Tyburn, but Pride's does not appear to have been treated in this way. Of the nineteen or twenty regicides who had escaped and were living abroad, three, Sir John Barkstead, John Okey and Miles Corbet, were arrested in Holland and executed in London in April 1662; and one, John Lisle, was murdered at Lausanne. The last survivor of the regicides was probably Edmund Ludlow, who died at Vevey in 1692.

Ludlow's *Memoirs*, edited by C. H. Firth (Oxford, 1894), give interesting details about the regicides in exile. See also D. Masson, *Life of Milton*, vol. vi. (1880), and M. Noble, *Lives of the English Regicides* (1798). (A. W. H.*)

REGILLUS, an ancient lake of Latium, Italy, famous in the legendary history of Rome as the lake in the neighbourhood of which occurred (496 B.C.) the battle which finally decided the hegemony of Rome in Latium. During the battle, so runs the story, the dictator Postumius vowed a temple to Castor and Pollux, who were specially venerated in Tusculum, the chief city of the Latins (it being a Roman usage to invoke the aid of the gods of the enemy), who appeared during the battle, and brought the news of the victory to Rome, watering their horses at the spring of Juturna, close to which their temple in the Forum was erected. There can be little doubt that the lake actually existed. Of the various identifications proposed, the best is that of Nibby, who finds it in a now dry crater lake (Pantano Secco), drained by an *emissarium*, the date of which is uncertain, some 2 m. N. of Frascati. Along the south bank of the lake, at some 30 or 40 ft. above the present bottom, ran the aqueducts of the Aqua Claudia and Anio Novus. Most of the other sites proposed are not, as Regillus should be, within the limits of the territory of Tusculum.

See T. Ashby in *Rendiconti dei Lincei* (1898), 103 sqq., and *Classical Review*, 1898. (T. As.)

REGIMENT (from Late Latin *regimentum*, rule, *regere*, to rule, govern, direct), originally government, command or authority exercised over others, or the office of a ruler or sovereign; in this sense the word was common in the 16th century. The most familiar instance is the title of the tract of John Knox, the *First Blast of the Trumpet against the Monstrous Regiment of Women*. The term as applied to a large body of troops dates from the French army of the 16th century. In the first instance it implied "command," as nowadays we speak of "General A's command," meaning the whole number of troops under his command. The early regiments had no similarity in strength or organization, except that each was under one commander. With the regularization of armies the commands of all such superior officers were gradually reduced to uniformity, and a regiment came to be definitely a colonel's command. In the British infantry the term has no tactical significance, as the number of battalions in a regiment is variable, and one at least is theoretically abroad at all times, while the reserve or territorial battalions serve under a different code to that governing the regular battalions. The whole corps of Royal Artillery is called "the Royal Regiment of Artillery." In the cavalry a regiment is tactically as well as administratively a unit of four squadrons. On the continent of Europe the regiment of infantry is always together under the command of its colonel, and consists of three or four battalions under majors or lieutenant-colonels.

REGINA, the capital city of the province of Saskatchewan, Canada, situated at 104° 36' W. and 50° 27' N., and 357 m. W. of Winnipeg. Pop. (1907) 9804. After the Canadian Pacific railway was completed in 1885, the necessity for a place of government on the railway line pressed itself upon the Dominion government. The North-West Territories were but little settled then, but a central position on the prairies was necessary, where the mounted police might be stationed and where the numerous Indian bands might be easily reached. The minister of the interior at Ottawa, afterwards Governor Dewdney, chose

this spot, and for a number of years Regina was the seat of the Territorial government. The governor took up his abode on the adjoining plain, and the North-West Council met each year, with a show of constitutional government about it. On the formation of the province of Saskatchewan in 1905 the choice of capital was left to the first legislature of the province. Prince Albert, Moose Jaw and Saskatoon all advanced claims, but Regina was decided on as the capital. It probably doubled in population between 1905 and 1907. Its public buildings, churches and residences are worthy of a place of greater pretensions. It is the centre for a rich agricultural district, and for legislation, education, law and other public benefits. It remains the headquarters of the mounted police for the western provinces, and near it is an Indian industrial school of some note.

REGINON, or REGINO of PRÜM, medieval chronicler, was born at Altrip near Spire, and was educated in the monastery of Prüm. Here he became a monk, and in 802, just after the monastery had been sacked by the Danes, he was chosen abbot. In 809, however, he was deprived of this position and he went to Trier, where he was appointed abbot of St Martin's, a house which he reformed. He died in 915, and was buried in the abbey of St Maximin at Trier, his tomb being discovered there in 1581.

Reginon wrote a *Chronicon*, dedicated to Adalberon, bishop of Augsburg (d. 909), which deals with the history of the world from the commencement of the Christian era to 906, especially the history of affairs in Lorraine and the neighbourhood. The first book (to 741) consists mainly of extracts from Bede, Paulus Diaconus and other writers; of the second book (741-906) the latter part is original and valuable, although the chronology is at fault and the author relied chiefly upon tradition and hearsay for his information. The work was continued to 967 by a monk of Trier, possibly Adalbert, archbishop of Magdeburg (d. 981). The chronicle was first published at Mainz in 1521; another edition is in Band I. of the *Monumenta Germaniae historica. Scriptores* (1826); the best is the one edited by F. Kurze (Hanover, 1890). It has been translated into German by W. Wattenbach (Leipzig, 1890). Reginon also drew up at the request of his friend and patron Radbod, archbishop of Trier (d. 915), a *Synodus canonis et disciplinæ ecclesiasticæ*, dedicated to Hatto I., archbishop of Mainz; this is published in Tome 132 of J. P. Migne's *Patrologia Latina*. To Radbod he wrote a letter on music, *Epistola de harmonica institutione*, with a *Tonaribus*, the object of this being to improve the singing in the churches of the diocese. The letter is published in Tome I. of Gerbert's *Scriptores ecclesiasticæ de musica sacra* (1784), and the *Tonaribus* in Tome II. of Coussemaker's *Scriptores de musica mediæ ævæ*. See also H. Ermsch, *Die Glaubwürdigkeit des Abtes Regino von Prüm* (Hamburg, 1894); C. Wawra, *De Reginone Prumensis* (Breslau, 1901); A. Molinier, *Les Sources de l'histoire de France*, Tome I. (1901); and W. Wattenbach, *Deutschlands Geschichtsquellen*, Band I. (1904).

REGIOMONTANUS (1436-1476), German astronomer, was born at Königsberg in Franconia on the 6th of June 1436. The son of a miller, his name originally was Johann Müller, but he called himself, from his birthplace, Joh. de Montegero, an appellation which became gradually modified into Regiomontanus. At Vienna, from 1452, he was the pupil and associate of George Purbach (1423-1461), and they jointly undertook a reform of astronomy rendered necessary by the errors they detected in the Alphonsine Tables. In this they were much hindered by the lack of correct translations of Ptolemy's works; and in 1462 Regiomontanus accompanied Cardinal Bessarion to Italy in search of authentic manuscripts. He rapidly mastered Greek at Rome and Ferrara, lectured on Alfraganus at Padua, and completed at Venice in 1463 Purbach's *Epitome in Cl. Ptolemaei magnam compositionem* (printed at Venice in 1496), and his own *De Triangulis* (Nuremberg, 1533), the earliest work treating of trigonometry as a substantive science. A quarrel with George of Trebizond, the blunders in whose translation of the *Almagest* he had pointed out, obliged him to quit Rome precipitately in 1468. He repaired to Vienna, and was thence summoned to Buda by Matthias Corvinus, king of Hungary, for the purpose of collating Greek manuscripts at a handsome salary. He also finished his *Tabulae Directionum* (Nuremberg, 1475), essentially an astrological work, but containing a valuable table of tangents. An outbreak of war, meanwhile, diverted

the king's attention from learning, and in 1471 Regiomontanus settled at Nuremberg. Bernhard Walther, a rich patrician, became his pupil and patron; and they together equipped the first European observatory, for which Regiomontanus himself constructed instruments of an improved type (described in his posthumous *Scripta*, Nuremberg, 1544). His observations of the great comet of January 1672 supplied the basis of modern cometary astronomy. At a printing-press established in Walther's house by Regiomontanus, Purbach's *Theoricæ planetarum novæ* was published in 1472 or 1473; a series of popular calendars issued from it, and in 1474 a volume of *Ephemerides* calculated by Regiomontanus for thirty-two years (1474-1506), in which the method of "lunar distances," for determining the longitude at sea, was recommended and explained. In 1472 Regiomontanus was summoned to Rome by Pope Sixtus IV. to aid in the reform of the calendar; and there he died, most likely of the plague, on the 6th of July 1476.

AUTHORITIES.—P. Gassendi, *Vita Jo. Regiomontani* (Parisii, 1654); J. G. Doppelmayr, *Historische Nachricht von den Nürnbergischen Mathematicis*, pp. 1-23 (1730); G. A. Will, *Nürnbergischen Gelehrten-Lexikon*, iii. 273 (1757); P. Nicéron, *Mémoires pour servir à l'histoire des hommes illustres*, xxxviii. 357 (1737); J. F. Weidler, *Hist. Astronomie*, p. 313; A. G. Kästner, *Geschichte der Mathematik*, i. 556, 572; J. F. Montucla, *Hist. des mathématiques*, i. 541; E. F. Apelt, *Die Reformation der Sternkunde*, p. 34; M. Cantor, *Vorlesungen über Geschichte der Math.*, ii. 254-264; M. Curtze, *Urkunden zur Gesch. der Math.*, i. 187 (1902); *Corr. Astr.* vii. 21 (1822); G. H. Schubert, *Peurbach und Regiomontanus* (Erlangen, 1828); A. Ziegler, *Regiomontanus ein geistiger Vorläufer des Columbus* (1874); J. B. J. Delambre, *Hist. de l'astronomie au moyen âge*, p. 284; J. S. Bailly, *Hist. de l'astr. moderne*, i. 311; R. Wolf, *Geschichte der Astronomie*, p. 87; S. Günther, *Allg. Deutsche Biog.*, Bd. xxii. p. 504; C. G. Jöcher's *Gelehrten-Lexikon*, iii. 1050, and *Fortsetzung*, vi. 1551 (H. W. Rotermund, Bremen, 1819); *Ersch-Gruber's Encyclopædie*, ii. the xx. p. 205; C. T. von Murr, *Memorabilia Bibliothecarum Norimburgensium*, i. 74 (1786).

REGISTER, a record of facts, proceedings, acts, events, names, &c., entered regularly for reference in a volume kept for that purpose, also the volume in which the entries are made. The Fr. *registre* is taken from the Med. Lat. *registrum* for *registum*, Late Lat. *regesta*, things recorded, hence list, catalogue, from *regere*, to carry or bear back, to transcribe, enter on a roll. For the keeping of public registers dealing with various subjects see **REGISTRATION** and the articles there referred to, and for the records of baptisms, marriages and burials made by a parish clergyman, see section *Parish Registers* below. The keeper of a register was, until the beginning of the 19th century, usually known as a "register," but that title has in Great Britain now been superseded by "registrar"; it still survives in the Lord Clerk Register, an officer of state in Scotland, nominally the official keeper of the national records, whose duties are performed by the Deputy Clerk Register. In the United States the title is still "register." The term "register" has also been applied to mechanical contrivances for the automatic registration or recording of figures, &c. (see **CASH REGISTER**), to a stop in an organ, to the compass of a voice or musical instrument, and also to an apparatus for regulating the in- and outflow of air, heat, steam, smoke or the like. Some of these instances of the application of the term are apparently due to a confusion in etymology, with Lat. *regere*, to rule, regulate.

PARISH REGISTERS were instituted in England by an order of Thomas Cromwell, as viceregent to Henry VIII., "supreme heid undre Christ of the Church of Englande," in September 1538. The idea appears to have been of Spanish origin, Cardinal Ximenes having instituted, as archbishop of Toledo, registers of baptisms in 1497. They included, under the above order, baptisms, marriages and burials, which were to be recorded weekly. In 1597 it was ordered by the Convocation of Canterbury that parchment books should be provided for the registers and that transcripts should be made on parchment of existing registers on paper, and this order was repeated in the 70th canon of 1603. The transcripts then made now usually represent the earliest registers. It was further provided at both these dates that an annual transcript of the

register should be sent to the bishop for preservation in the diocesan registry, which was the origin of the "bishop's transcripts." The "Directory for the publique worship of God," passed by parliament in 1645, provided for the date of birth being also registered, and in August 1653, an Act of "Barebones' Parliament" made a greater change, substituting civil "parish registers" (*sic*) for the clergy, and ordering them to record births, banns, marriages and burials. The "register" was also to publish the banns and a justice to perform the marriage. The register books were well kept under this civil system, but at the Restoration the old system was resumed.

A tax upon births, marriages and burials imposed in 1694 led to the clergy being ordered to register all births, apart from baptisms, but the act soon expired and births were not again registered till 1836. Lord Hardwicke's Marriage Act (1754), by its rigid provisions, increased the registration of marriages by the parochial clergy and prescribed a form of entry. In 1812 parish registers became the subject of parliamentary enactment, owing to the discovery of their deficiencies. Rose's Act provided for their safer custody, for efficient bishops, transcripts, and for uniformity of system. This act continued to regulate the registers till their supersession for practical purposes, in 1837, by civil registration under the act of 1836.

In age, completeness and condition they vary much. A blue book on the subject was published in 1833, but the returns it contains are often inaccurate. A few begin even earlier than Cromwell's order, the oldest being that of Tipton, Staffs, (1513). Between 800 and 900, apparently, begin in 1538 or 1539. The entries were originally made in Latin, but this usage died out early in the 17th century; decay and the crabbed handwriting of the time render the earlier registers extremely difficult to read. There is general agreement as to the shocking neglect of these valuable records in the past, and the loss of volumes appears to have continued even through the 19th century. Their custody is legally vested in the parochial clergy and their wardens, but several proposals have been made for their removal to central depositories. The fees for searching them are determined by the act of 1836, which prescribes half a crown for each certified extract, and sixpence a year for searching, with a shilling for the first year.

The condition of the "bishops' transcripts" was, throughout, much worse than that of the parish registers, there being no funds provided for their custody. The report on Public Records in 1800 drew attention to their neglect, but, in spite of the provisions in Rose's Act (1812), little or nothing was done, and, in spite of their importance as checking, and even sometimes supplementing deficient parish registers, they remained "unarranged, unindexed and unconsultable." Of recent years, however, some improvement has been made. It has also been discovered that transcripts from "peculiar" exist in other than episcopal registries.

Outside the parochial registers, which alone were official in character, there were, till 1754, irregular marriage registers, of which those of the Fleet prison are the most famous, and also registers of private chapels in London. Those of the Fleet and of Mayfair chapel were deposited with the registrar-general, but not authenticated. The registers of dissenting chapels remained unofficial till an act of 1840 validated a number which had been authenticated, and was extended to many others in 1858. Useful information on these registers, now mostly deposited with the registrar-general, will be found in Sims' *Manual*, which also deals with those of private chapels, of English settlements abroad preserved in London, and with English Roman Catholic registers. These last, however, begin only under George II. and are restricted to certain London chapels.

The printing of parish registers has of late made much progress, but the field is so vast that the rate is relatively slow. There is a Parish Register Society, and a section of the Harleian Society engaged on the same work, as well as some county societies and also one for Dublin. But

so many have been issued privately or by individuals that reference should be made to the lists in Marshall's *Genealogist's Guide* (1893) and Dr Cox's *Parish Registers* (1910), and even this last is not perfect. The Huguenot Society has printed several registers of the Protestant Refugees, and Mr Moens that of the London Dutch church. There are also several registers of marriages alone now in print, such as that of St Dunstan's, Stepney, in 3 vols. Colonel Chester's extensive MS. collection of extracts from parish registers is now in the College of Arms, London, and the parishes are indexed in Dr Marshall's book. MS. extracts in the British Museum are dealt with in Sims' *Manual*.

In Scotland registers of baptisms and marriages were instituted by the clergy in 1551, and burials were added by order of the Privy Council in 1616; but these were very imperfectly kept, especially in rural parishes. Yet it was not till 1854 that civil registration was introduced, by act of parliament, in their stead. Some 900 parish registers, beginning about 1563, have been deposited in the Register House, Edinburgh, under acts of parliament which apply to all those prior to 1819. Mr Hallen has printed the register of baptisms of Muthill Episcopal Church.

In Ireland, parish registers were confined to the now dis-established church, which was that of a small minority, and were, as in Scotland, badly kept. Although great inconvenience was caused by this system, civil registration of marriages, when introduced in 1844, was only extended to Protestants, nor was it till 1864 that universal civil registration was introduced, great difficulty under the Old Age Pensions Act being now the result. No provision was made, as in Scotland, for central custody of the registers, which, both Anglican and Nonconformist, remain in their former repositories. Roman Catholic registers in Ireland only began, apparently, to be kept in the 19th century.

In France registers, but only of baptism, were first instituted in 1530. The Council of Trent, however, made registers both of baptisms and of marriages a law of the Catholic Church in 1563, and Louis XIV. imposed a tax on registered baptisms and marriages in 1707.

See Burn, *The History of Parish Registers* (1829, 1862); Sims, *Manual for the Genealogist* (1856, 1888); Chester Waters, *Parish Registers in England* (1870, 1882, 1887); Marshall, *Genealogist's Guide* (1893); A. M. Burke, *Key to the Ancient Parish Registers* (1908); J. C. Cox, *Parish Registers of England* (1910); W. D. Bruce, *Accounts of the Ecclesiastical Courts of Record* (1854); Bigland, *Observations on Parochial Registers* (1764); *Report of the Commissioners on the state of Registers of Births, &c.* (1838); *Lists of Non-parochial Registers and Records in the custody of the Registrar-General* (1841); *Report on Non-parochial Registers* (1857); *Detailed List of the old Parochial Registers of Scotland* (1872). (J. H. R.)

REGISTRATION. In all systems of law the registration of certain legal facts has been regarded as necessary, chiefly for the purpose of ensuring publicity and simplifying evidence. Registers, when made in performance of a public duty, are as a general rule admissible in evidence merely on the production from the proper custody of the registers themselves or (in most cases) of examined or certified copies. The extent to which registration is carried varies very much in different countries. For obvious reasons, judicial decisions are registered in all countries alike. In other matters no general rule can be laid down, except perhaps that on the whole registration is not as fully enforced in the United Kingdom and the United States as in continental states. The most important uses of registration occur in the case of judicial proceedings, land, ships, bills of sale, births, marriages and deaths, companies, friendly and other societies, newspapers, copyrights, patents, designs, trade marks and professions and occupations. In England registrars are attached to the privy council, the Supreme Court and the county courts. In the king's bench division (except in its bankruptcy jurisdiction) the duty of registrars is performed by the masters. Besides exercising limited judicial authority, registrars are responsible for the drawing up and recording of various stages of the proceedings from the petition, writ or

plaint to the final decision.¹ With them are filed affidavits, depositions, pleadings, &c., when such filing is necessary. The difference between filing and registration is that the documents filed are filed without alteration, while only an epitome is usually registered. The Judicature Act 1873 created district registries in the chief towns, the district registrar having an authority similar to that of a registrar of the Supreme Court. In the admiralty division cases of account are usually referred to the registrar and merchants. The registration in the central office of the supreme court of judgments affecting lands, writs of execution, recognizances and *lites pendentes* in England, and the registration in Scotland of abbreviates of adjudications and of inhibitions, are governed by special legislation. All these are among the incumbrances for which search is made on investigating a title. Decisions of criminal courts are said to be recorded, not registered, except in the case of courts of summary jurisdiction, in which, by the Summary Jurisdiction Act 1879, a register of convictions is kept. Probates of wills and letters of administration, which are really judicial decisions, are registered in the principal or district registries of the probate division. In Scotland registration is used for giving a summary remedy on obligations without action by means of the fiction of a judicial decision having been given establishing the obligation.

See also the separate articles LAND REGISTRATION; SHIPPING; BILL OF SALE; COMPANIES; FRIENDLY SOCIETIES; BUILDING SOCIETIES; PRESS LAWS; COPYRIGHT; TRADE MARKS; PATENTS, &c.

Registration of Voters.—Prior to 1832 the right of parliamentary electors in England was determined at the moment of the tender of the vote at the election, or, in the event of a petition against the return, by a scrutiny, a committee of the House of Commons striking off those whose qualification was held to be insufficient, and, on the other hand, adding those who, having tendered their votes at the poll, with a good title to do so, were rejected at the time. A conspicuous feature of the Reform Act of that year was the introduction of a new mode of ascertaining the rights of electors by means of an entirely new system of published lists, subject to claims and objections, and after due inquiry and revision forming a register of voters. Registration was not altogether unknown in Great Britain in connexion with the parliamentary franchise before the Reform Acts of 1832. Thus in the Scottish counties the right to vote depended on the voter's name being upon the roll of freeholders established by an act of Charles II.; a similar register existed in Ireland of freeholders whose freeholds were under £20 annual value; and in the universities of Oxford and Cambridge the rolls of members of Convocation and of the Senate were, as they still are, the registers of parliamentary voters. But except in such cases as the above, the right of a voter had to be determined by the returning officer upon the evidence produced before him when the vote was tendered at a poll. This necessarily took time, and the result was that a contested election in a large constituency might last for weeks. The celebrated Westminster election of 1784, in which the poll began on the 1st of April and ended on the 17th of May, may be mentioned as an illustration. Moreover, the decision of the returning officer was not conclusive; the title of every one who claimed to vote was liable to be reconsidered on an election petition, or, in the case of a rejected vote, in an action for damages by the voter against the returning officer.

The inconvenience of such a state of things would have been greatly aggravated had the old practice continued after the enlargement of the franchise in 1832. The establishment of a general system of registration was therefore a necessary and important part of the reform then effected. It has enabled an election in the most populous constituency to be completed in a single day. It has also been instrumental in the extinction

¹ The antiquity of registration of this kind is proved by the age of the *Registrum Brevium*, or register of writs, called by Lord Coke "a most ancient book of the Common Law" (Coke upon Littleton, 159a).

of the "occasional voter," who formerly gave so much trouble to returning officers and election committees—the person, namely, who acquired a qualifying tenement with the view of using it for a particular election and then disposing of it. The period of qualification now required in all cases, being fixed with reference to the formation of the register, is necessarily so long anterior to any election which it could effect, that the purpose or intention of the voter in acquiring the qualifying tenement has ceased to be material, and is not investigated.

England.—The reform of parliamentary representation in 1832 was followed in 1835 by that of the constitution of municipal corporations, which included the creation of a uniform qualification (now known as the old burgess qualification) for the municipal franchise. In 1888 the municipal franchise was enlarged, and was at the same time extended to the whole country for the formation of constituencies to elect county councils; and in 1894 parochial electors were called into existence for the election of parish councils and for other purposes. Inasmuch as provision was made for the registering of persons entitled to votes for the above purposes, there are now three registers of voters, namely, the parliamentary register, the local government register (*i.e.* in boroughs under the Municipal Corporation Acts, the burgess rolls, and elsewhere the county registers) and the register of parochial electors. Under the Municipal Corporations Act 1835 the registration of burgesses, though on similar lines to that of parliamentary voters, was entirely separate from it. Since, however, the qualification for the municipal franchise covered to a great extent the same ground as that for the parliamentary franchise in boroughs which sent members to parliament, a considerable number of voters in such boroughs were entitled in respect of the same tenement to be upon both parliamentary register and burgess roll. The waste of labour involved in settling their rights twice over was put an end to in 1878, when the system of parliamentary registration was extended to the boroughs in question for municipal purposes, and the lists were directed to be made out in such a shape that the portion common to the two registers could be detached and combined with the portion peculiar to each, so as to form the parliamentary register and the burgess roll respectively. This system of registration was extended to the non-parliamentary boroughs and to the whole country in 1888, the separate municipal registration being completely abolished.

The procedure of parliamentary registration is to be found in its main lines in the Parliamentary Registration Act 1843, which superseded that provided by the Reform Act of 1832, and has itself been considerably amended by later legislation. The acts applying and adapting the system to local government and parochial registration are the Parliamentary and Municipal Registration Act 1878, the County Electors Act 1888, and the Local Government Act 1894. Registration is carried out by local machinery, the common-law parish being taken as the registration unit; and the work of preparing and publishing the lists, which when revised are to form the register, is committed to the overseers. The selection of these officers was no doubt due to their position as the rating authority, and to their consequent opportunities for knowing the ownership and occupation of tenements within their parish. They do not always perform the duties themselves, other persons being empowered to act for them in many parishes by general or local acts of parliament; but in all or almost all cases they are entitled to act personally if they think fit, they sign the lists, and the proceedings are conducted in their name.

In order to render intelligible the following summary of the procedure, it will be necessary to divide the voters to be registered into classes based on the nature of their qualification, since the practice differs in regard to each class. The classes are as follows: (1) Owners, including the old forty-shilling freeholders, the copyholders, long leaseholders and others entitled under the Reform Act of 1832 to vote at parliamentary elections for counties; (2) occupiers, including those entitled to (a) the 10 occupation qualification, (b) the household qualification and (c) the old burgess qualification; (3) lodgers, subdivided into (a) old, *i.e.* those on the previous register for the same lodgings, and (b) new; (4) those entitled to reserved rights, *i.e.* in addition to those (if any still remain) who were entitled to votes before the Reform Act of 1832 in respect of qualifications abolished by that act, (a) free-

hold and burgage tenants in Bristol, Exeter, Norwich, and Nottingham, and (b) livymen of the City of London and freemen of certain old cities and boroughs, whose right to the parliamentary franchise was permanently retained by the same act. In regard to these classes it may be said that the general scheme is that owners must make a claim in the first instance before they can get their names upon the register, but that, once entered on the register, the names will be retained from year to year until removed by the revising barrister; that the lists of occupiers and of freehold and burgage tenants are made out afresh every year by the overseers from their own information and enquiries, though a set being required on the part of the voters, who need only make claims in those their names are omitted; that lodgers must make claims every year; and that livymen and freemen are in the same position as occupiers, except that the lists of livymen are made out by the clerks of the several companies, and those of freemen by the town clerks, the overseers having nothing to do with these voters, whose qualifications are personal and not locally connected with any parish.

The overseers and other officers concerned are required to perform their duties in connexion with registration in accordance with the instructions and precepts, and to use the notices and forms prescribed by Order in Council from time to time. The Registration Order, 1895, directs the clerk of every county council, on or within seven days before the 31st of January in every year, to send a set of the register of each parish in his county a precept with regard to the registration of ownership electors, and to every parish not within a parliamentary or municipal borough a precept with regard to the registration of occupation electors (which expression for this purpose includes lodgers as well as occupiers proper). The town clerk of every borough, municipal or parliamentary, is to send to the overseers of every parish in his borough a precept with regard to the registration of occupation electors. These precepts are set out in the Registration Order, and those issued by the town clerks differ according as the borough is parliamentary only, or municipal only, or both parliamentary and municipal; in the cases of Bristol, Exeter, Norwich and Nottingham they contain directions as to freehold and burgage tenants. The duties of the overseers with regard to registration are set out in detail in the precepts. Along with the precepts are forwarded forms of the various lists and notices required to be used, and with the ownership precept a certain number of copies of that portion of the parliamentary register of the county at the time in force which contains the ownership voters for the parish, the register being so printed that the portion relating to each parish can be detached. It is the duty of the overseers to publish on the 20th of June, in manner hereinafter described, the portion of the register so received, together with a notice to owners not already registered to send in claims by the 20th of July. Meanwhile the overseers are making the inquiries necessary for the preparation of the occupier list. For this purpose they may require returns to be furnished by owners of houses let out in separate tenements, and by employers who have servants entitled to the service franchise. The registrars of births, deaths and marriages are required to furnish the overseers with returns of deaths, as must the assessed tax collectors with returns of defaulters; the relieving officers are to give information as to recipients of parochial relief. On or before the 31st of July the overseers are to make out and sign the lists of voters. These are the following: the list of ownership electors, consisting of the portion of the register previously published with a supplemental list of those who have sent in claims by the 20th of July; the occupier list; and the old lodger list, the last being formed from claims sent in by the 25th of July. The overseers do not select the names in the first and last of these lists; they take them as supplied in the register and claims. It is, however, their duty to write dead or objected to in the margin against the names of persons whom they have reason to believe to be dead or not entitled to vote in respect of the qualification described. The ownership and old lodger lists will be divided into two parts, if the register contains names of owners entitled to a parochial vote only, or if claims by owners or old lodgers have been made limited to that franchise. The occupier list contains the names of persons whom the overseers believe to be qualified, and no others, and therefore will be free from marginal objections. Except in the administrative county of London, it is made out in three divisions—division 1 giving the names of occupiers of property qualifying for both parliamentary and local government votes, divisions 2 and 3 those of occupiers of property qualifying only for parliamentary and only for local government votes respectively. It happens so frequently that the same person is of sufficient value to qualify for the 10 occupation franchise (parliamentary and local government), qualifies both for the household franchise (parliamentary) and for the old burgess franchise (local government), that division 1 would in most cases be the whole list, but for two circumstances. The service franchise is a special modification of the household franchise only; and the service occupants, being therefore restricted to the parliamentary vote, form the bulk of division 2; while peers and women, being excluded from the parliamentary vote, are consequently relegated to division 3. In the administrative county of London the local government register, being coextensive with the register of parochial electors, includes

the whole of the parliamentary register. The occupier lists are consequently there made out in two divisions only, the names which would elsewhere appear in division 2 being placed in division 1. The lists of freehold and burgrave tenants in Bristol, Exeter, Norwich and Nottingham are to be made out and signed by the same date. The overseers have also to make out and sign a list of persons qualified as occupiers to be elected aldermen or councillors, but as non-residents disqualified from being on the local government register. By the same date also the clerks of the livery companies are to make out, sign and deliver to the secondary (two) clerks in the City of London the registration duties which elsewhere fall on the town clerk) the lists of liverymen entitled as such to the parliamentary vote; and the town clerks are to make out and sign the lists of freemen so entitled in towns where this franchise exists.

On the 1st of August all the above lists are to be published, the livery lists by the secondary, lists of freemen by the town clerks and the rest by the overseers. In addition the overseers may have to publish a list of persons disqualified by having been found guilty of corrupt or illegal practices; this list they will receive, when it exists, from the clerk of the county council or town clerk with the precept. Publication of lists and notices by overseers is made by affixing copies on the doors of the church and other places of worship of the parish (or, if there be none, in some public or conspicuous situation in the parish), and also, with the exception to be mentioned, in a public or private place in a municipal borough or urban district, in or near every public or municipal or parochial office and every post and telegraph office in the parish. The exception is that lists and notices relating to ownership electors need not be published at the offices mentioned when the parish is within a parliamentary borough. Publication by the secondary is made by affixing copies outside the Guildhall and Royal Exchange; publication by town clerks is made by affixing copies outside their town hall, or, where there is none, in some public or conspicuous place in their borough. From the 1st to the 20th of August inclusive is allowed for the entry of claims and objections. Those whose names have been omitted from the occupier or reserved rights lists, or the non-resident list, or whose names, place of abode or particulars of qualification have been incorrectly stated in such lists, may send in claims to have their names registered; lodgers who are not qualified as old lodgers, or who have omitted to claim as such, may claim as new lodgers; persons whose names are on the corrupt and illegal practices list may claim to have them omitted. Any person whose name is on the list of parliamentary, local government or parochial electors for the same parliamentary county, administrative county, borough or parish, or whose name is on the same lists, may object to the inclusion of his name on the same lists, and to be sent to the secondary and town clerk, and in other cases to the overseers; and notices of objection must in all cases be sent to the person objected to. All notices must be sent in by the 20th of August, and on or before the 25th of August the overseers, secondary and town clerks are to make out, sign and publish lists of the claimants and persons objected to. It remains to be added that any person on a list of voters (i.e. on one of the lists published on the 1st of August) may make a declaration before a magistrate or commissioner or oaths correcting the entry relating to him. In the case of ownership electors the correction can only deal with the place of abode; in the case of other lists it extends to all particulars stated, and is useful inasmuch as it enables the revising barrister to make corrections as to the qualification which he could not make in the absence of a declaration. The declarations must be delivered to the clerk of the county council or town clerk on or before the 5th of September.

The next stage is the revision of the lists. For this purpose revising barristers are appointed yearly. The period within which

revision courts can be held is from the 8th of September to the 12th of October, both days inclusive. The clerk of the revising court is the clerk of the county court held for each parliamentary division of his county, and the town clerk the first court held for his city or borough; and they respectively produce all lists, notices and declarations in their custody, and answer any questions put to them by the revising barrister. The overseers also attend the courts held for their parish, produce the rate books, original notices of claim and objection, &c., and answer questions. The claimants, objectors and persons objected to appear personally or by representative to support their several contentions. Any person qualified to be an objector may appear to oppose any claims, upon giving notice to the revising barrister that he has reached. The powers of the revising barristers are as follows: As regards persons whose names are on the lists of voters published on the 1st of August, he is to expunge the names, whether objected to or not, of those who are dead or subject to personal incapacity, such as infants and aliens, and for parliamentary purposes peers and women. If an entry is imperfect, the name must be removed, unless the particulars necessary for completing it are supplied to the barrister. All names marginally objected to by overseers must be expunged, unless the voters prove to the barrister that they ought to be retained. Objections made by other objectors must be supported by county council attestation, and if this is not rebutted the name is struck out. Claimants must be ready to support their claims. The declaration attached to a lodger claim is indeed prima

facie proof of the facts stated in it, but other claimants require evidence to make out even a prima facie case, and if they fail to produce it their claims will be disallowed. The barrister is required to correct errors in the lists of voters, and has a discretion to rectify mistakes in claims and objections upon evidence produced to him, although his power in this respect is limited. Lastly, the barrister has to deal with duplicates, as a voter is entitled to be on the register once, but not more than once, as a parliamentary voter for each parliamentary county or borough, as a Burgess for each municipal borough, as a county elector for each electoral division, and as a parochial elector for each parish in which he holds a qualification. Consequently, he deals with duplicate entries by expunging or transferring them to separate parochial lists. The decision of the revising barrister is final and conclusive on all questions of fact; but an appeal lies from him on questions of law at the instance of any person aggrieved by the removal of his name from a list of voters, by the rejection of his claim or objection or by the allowance of a claim which he has opposed. Notice of the intention to appeal must be given to the barrister in writing on the day when his decision is given. The barrister may refuse to state a case for appeal; but if he does so without due cause he may be ordered by the High Court to state a case. The appeal is heard by a divisional court, from whose decision an appeal lies (by leave either of the divisional court or of the court of appeal) to the court of appeal, whose decision is final.

On the completion of the revision the barrister hands the county and borough lists (every page signed and every alteration initiated by him) to the clerk of the county council and the town clerk respectively, to be printed. With the following exceptions the revised lists are to be made up and printed by the 20th of December, and come into force as the register for all purposes on the 1st of January. In the boroughs created by the London Government Act 1899, the whole register is to be made up and printed by the 20th of October, and to come into force for the purpose of borough elections under the Act on the 1st of November. In boroughs subject to the Municipal Corporations Acts, divisions 1 and 2 of the occupier lists are to be made up and printed by the 20th of October, and come into force for the purpose of municipal and county council elections on the 1st of November. Corrections ordered in consequence of a successful appeal from a revising barrister are to be made by the officers having the custody of the registers, but a pending appeal does not affect any right of voting. The register in its final form will consist of the lists published on the 1st of August as corrected, with the claims which have been allowed on revision incorporated therein. It is printed in such form that each list and each division of a list for every parish can be separated from the rest for the purpose of making up the parliamentary, local government and parochial registers respectively. The alphabetical order is followed, except in London and some other large towns, where street order is adopted for all except the ownership lists and lists of liverymen and freemen. The parliamentary register for a parliamentary county will consist of the ownership lists for all parishes in the county, and of the lodger lists and divisions 1 and 2 of the occupier lists for parishes within the county and not within a parliamentary borough. The parliamentary register for a parliamentary borough will consist of the lodger lists, of the lists of freehold and burgrave tenants (if any), and of divisions 1 and 2 of the occupier lists for all parishes within the borough, and also of the borough lists (if any) of liverymen or freemen. The local government register for an administrative county will consist of divisions 1 and 3 of the occupier lists for all parishes in the county, and the Burgess roll for a municipal borough of divisions 1 and 3 of the occupier lists for all parishes in the borough. It will be seen, therefore, that, except in county boroughs, the Burgess roll is also a part of the local government register of the administrative county within which the borough is situate. The register of parochial electors consists of the complete set of lists for each parish; but this does not include the lists of liverymen and freemen, which, as has been stated, are not parish lists.

No one whose name is not on the register can vote at an election. The fact that a man's name is on the register is now so far conclusive of his right that the returning officer is bound to receive his vote. Only two questions may be asked of him when he tenders his vote, namely, whether he is the person whose name is on the register, and whether he has voted before at the election. The Reform Act 1832 allowed him to be asked at parliamentary elections whether he retained the qualification for which he had been registered; but the Reform Act 1843 disallowed that question, and made the register conclusive as to the retention of the qualification. When, however, a petition is presented against an election, the register, although conclusive as to the retention of the qualification, does not prevent the court from inquiring into the existence of personal incapacities, arising in connexion with the election or otherwise, and striking off on scrutiny the votes of persons subject thereto, e.g. aliens, infants, or in parliamentary elections peers, &c.

The City of London is not within the Municipal Corporations Act, and is therefore subject to the general registration law of the formation of its roll of citizens for municipal purposes. But a register of parliamentary, county and parochial electors is made in

the ordinary way. The universities are also exempt from the general law of registration. At Oxford and Cambridge the members of Convocation and the Senate respectively have always formed the parliamentary constituencies; and, as has been already stated, the registers of those members were before 1832, and still are, the parliamentary registers. Similarly, the Reform Act of 1867, which gave parliamentary representation to the university of London, simply enacted that the register of graduates constituting the Convocation should be the parliamentary register of that body.

Scotland.—In Scotland the qualifications for local government and parish electors are the same as those for parliamentary voters, the only difference in the registers being in respect of personal incapacities for the parliamentary franchise, incapacity for the other franchises by reason of non-payment of rates, and duplicates. The principal act regulating registration in burghs is 19 & 20 Vict. c. 58, amended in some particulars as to dates by 31 & 32 Vict. c. 48, § 20. County registration, formerly regulated by 24 & 25 Vict. c. 83, has been assimilated to burgh registration by 48 & 49 Vict. c. 3, § 8 (6). The procedure consists, as in England, of the making and publication of lists of voters, the making of claims and objections, and the holding of a revision court; but there are important differences of detail. Thus, in the parish registers, the unit, parochial machinery is not used for the formation of the register. The parliamentary lists for a county are made up yearly by one or more of the assessors of the county, and those for a burgh by one or more of the assessors for the burgh, or by the clerk of the commissioners. They are published on the 15th of September; and claims and objections must be sent in by the 21st and are published on the 25th of the same month. Publication is made in burghs by posting on or near the town hall, or in some other conspicuous place, in counties by posting the part relating to each parish on the parish church door, and in both cases giving notice by newspaper advertisement of a place where the lists may be perused. The revision is conducted by the sheriff, the time within which his courts may be held being from the 25th of September to the 16th of October, both days inclusive. An appeal lies to three judges of the Court of Session, one taken from each division of the Inner House, and one from the Lords Ordinary of the Outer House. The revised lists are delivered in counties to the sheriff clerk, in burghs to the town clerk, or person to whom the registration duties of town clerk are assigned. The register comes into force for all purposes on the 1st of November.

The municipal register of a royal burgh which is coextensive, or nearly so, with the burgh is the coextensive register with a parliamentary burgh, consists of the parliamentary register with a supplemental list of women who but for their sex would be qualified for the parliamentary vote. The municipal register for a burgh, or for that part of one which is not within a parliamentary burgh, consists of persons possessed of qualifications within the burgh which, if within a parliamentary burgh, would entitle them, or but for their sex would entitle them, to the parliamentary vote. The register of county electors consists of the parliamentary register for a county with the supplemental list hereafter mentioned; but inasmuch as exemption from or failure to pay the consolidated county rate is a disqualification for the county electors' franchise, the names of persons so disqualified are to be marked with a distinctive mark on the register; as are also the names of persons whose qualifications are situated within a burgh, such marks indicating that the persons to whose names they are attached are not entitled to vote as county electors. Every third year, in preparation for the triennial elections of county and parish councils (casual vacancies being filled up by co-optation), a supplemental list is to be made of peers and women possessed of qualifications which but for their rank and sex would entitle them to parliamentary votes. The register of county electors in a county and the municipal register in a burgh form the registers of parish electors for the parishes comprised in each respectively. Inasmuch, however, as a man is entitled to be registered as a parish elector in every parish where he is qualified, duplicate entries are, when required, to be made in the register, with distinctive marks to all but one, to indicate that they confer the parish vote only. These distinctive marks and those previously mentioned are to be made in the lists by the assessors, subject to revision by the sheriff. The register is conclusive to the same extent as in England, except that the vote of a parish elector who is one year in arrear in payment of a parish rate is not to be received. The clerk of the parish county rate is to furnish the returning officer one week before an election with the names of persons so in arrear; and the returning officer is to reject their votes except upon the production of a written receipt. Provision is made by 31 & 32 Vict. c. 48, §§ 27-41, for the formation of registers of parliamentary electors for the universities. The register for each university is to be made annually by the university registrar, with the assistance of two members of the council, from whose decisions an appeal lies to the university court.

Ireland.—There are no parish councils in Ireland, and no parochial electors. There are therefore but two registers of voters, the parliamentary and the local government registers, the latter of which consists of the former with a local government supplement

containing the names of those excluded from the parliamentary register by reason of their being peers or women, and duplicate entries relating to those whose names are registered elsewhere for the same parliamentary constituency. The principal acts regulating registration are 13 & 14 Vict. c. 69, 31 & 32 Vict. c. 112, 48 & 49 Vict. c. 17, and 61 & 62 Vict. c. 2. The lord lieutenant is empowered to make by Order in Council rules for registration, and to prescribe forms; and under this power has made the Registration (Ireland) Rules 1899, now in force. The registration unit is not the parish, but the district electoral division, except where such division is subdivided into wards, or is partly within and partly without any town or ward of a borough or town, in which cases each ward of the division or part of a division is a separate registration unit.

The procedure is as follows, subject to variation in cases where there are clerks of unions who held office on the 31st of March 1898, and have not agreed to transfer their registration duties. The clerk of the peace sends out on the 1st of June a precept in the form prescribed for county registration to the secretary of the county council and clerks of urban district councils, together with a copy of the existing register for their county or district; and a precept in the form prescribed for borough registration to the clerks of the boroughs. As regards registration units not in a parliamentary or municipal borough, the secretary of the county council or clerk of the urban district council is to put marginal objections, "dead" or "objected," where required, to £10 occupiers and householders in the copy of the register, both in the parliamentary list and in the local government supplement. He is also to make out supplemental parliamentary and local government lists of £10 occupiers and householders not on the existing register, and to put marginal objections where required to these. He is to verify on oath before a magistrate the copy of the register and supplemental lists, and to return them to the clerk of the peace by the 8th of July. As regards registration units in a parliamentary borough, but outside a municipal borough, the secretary of the county council or clerk of the urban district council is to make out lists of £10 occupiers and householders with local government supplement, and transmit them to the town clerk of the municipal borough or town. The clerk of the peace is to publish the copy of the register, after himself placing marginal objections where required to voters other than £10 occupiers and householders, and the supplemental lists as received, and also the corrupt and illegal practices list, if any, on the 22nd of July. On the same day the town clerk will publish the list as received, as aforesaid for registration units outside a municipal borough, and the lists, which he will have made out himself for the municipal borough, including the freemen's list and corrupt and illegal practices list. Freemen being entitled to the local government vote will, if resident, be placed on the list of the registration unit where they reside, and will, if non-resident, be allotted by the revising barrister among the registration units of the borough for local government purposes in proportion to the number of electors in each registration unit. Claims are to be sent in to the clerk of the peace and town clerk by the 4th of August, including old list claims and, in the case of the clerk of the peace, ownership claims. Lists of claimants with marginal objections, where required, are to be published by the clerk of the peace and town clerk by the 11th of August. Notices of objection to voters or claimants may be given by the 20th of August; and lists of persons objected to are to be published by the clerk of the peace and town clerk by the 24th of the same month. Publication of lists and notices by a clerk of the peace is made by posting copies of those relating to each registration unit outside every court-house, petty sessions court, and other public offices in the unit; publication by a town clerk is made by posting copies outside the town hall, or, if large be none, in some public and conspicuous place in the borough.

Revising barristers are specially appointed for the county and city of Dublin by the lord lieutenant; elsewhere the county court judges and chairmen of quarter sessions act as such *ex officio*, assisted, when necessary, by additional barristers appointed by the lord lieutenant. The time for the holding of revision courts is from the 8th of September to the 25th of October inclusive. An appeal lies to the court of appeal, whose decision is final. The revised lists are handed to the clerk of the peace; they are to be made up by him by the 31st of December, and come into force on the 1st of January.

The registrar of the university of Dublin is to make out in December a list of the persons entitled to the parliamentary vote for the university, and to print the same in January, and to publish a copy in the university calendar, or in one or more public journals circulating in Ireland. He is to revise the list annually, and expunge the names of those dead or disqualified; but an elector whose name has been expunged because he was supposed to be dead is entitled, if alive, to have his name immediately restored and to vote at any election.

(L. L. S.)

REGIUM (Gr. *Ῥῆγιον*; in Latin the aspirate is omitted), a city of the territory of the Bruttii in South Italy, on the east side of the strait between Italy and Sicily (Strait of Messina).

A colony, mainly of Chalcidians, partly of Messenians from the Peloponnesus, settled at Regium in the 8th century B.C. About 494 B.C. Anaxilas, a member of the Messenian party, made himself master of Regium (apparently—from numismatic evidence, for the coins assignable to this period are modelled on Samian types—with the help of the Samians; see MESSINIA) and about 488 joined with them in occupying Zancle (Messina). Here they remained. (See C. H. Dodd in *Journal of Hellenic Studies*, xxviii. (1908) 56 sqq.) This coinage was resumed after the establishment of the democracy about 461 B.C., when Anaxilas' sons were driven out. In 433 Regium made a treaty with Athens, and in 427 joined the Athenians against Syracuse, but in 415 it remained neutral. An attack which it made on Dionysius I. of Syracuse in 399 was the beginning of a great struggle which in 387 resulted in its complete destruction and the dispersion of its inhabitants as slaves. Restored by the younger Dionysius under the name of Phœbæ, the colony soon recovered its prosperity and resumed its original designation. In 280, when Pyrrhus invaded Italy, the Regines admitted within their walls a Roman garrison of Campanian troops; these mercenaries revolted, massacred the male citizens, and held the city till in 270 they were besieged and put to death by the Roman consul Genucius. The city remained faithful to Rome throughout the Punic wars, and Hannibal never succeeded in taking it. Up till the Social War it struck coins of its own, with Greek legends. Though one of the cities promised by the triumvirs to the veterans, Regium escaped through the favour of Octavius (hence it took the name Regium Julium). It continued, however, to be a Greek city even under the Empire, and never became a colony. Towards the end of the Empire it was made the chief city of the Bruttii.

Of ancient buildings hardly anything remains at Regium, and nothing of the archaic Greek period is *in situ*, except possibly the remains of a temple of Artemis Phœbeis, which have not yet been explored, though various inscriptions relative to it have been found. The museum, however, contains a number of terra-cottas, vases, inscriptions, &c., and a number of Byzantine lead seals. Several baths of the Greek period, modified by the Romans, have been found, and the remains of one of these may still be seen. A large mosaic of the 3rd or 4th century A.D. with representations of wild animals and the figure of a warrior in the centre was found in 1904 and covered up again. The aqueduct and various cisterns connected with it have been traced, and some tombs of the 5th or 4th century B.C. (or even later) were found in 1907.

See *Notizie degli scavi*, passim; P. Larizza, *Rhegium Chalcidense* (Rome, 1905).

REGIUM DONUM, or ROYAL GIFT, an annual grant formerly made from the public funds to Presbyterian and other Non-conformist ministers in Great Britain and Ireland. It dates from the reign of Charles II., who, according to Bishop Burnet, after the declaration of indulgence of 1672 ordered sums of money to be paid to Presbyterian ministers. These gifts or pensions were soon discontinued, but in 1690 William III. made a grant of £1200 a year to the Presbyterian ministers in Ireland as a reward for their services during his struggle with James II. Owing to the opposition of the Irish House of Lords the money was not paid in 1711 and some subsequent years, but it was revived in 1715 by George I., who increased the amount to £2000 a year. Further additions were made in 1784 and in 1792, and in 1868 the sum granted to the Irish Presbyterian ministers was £45,000. The Regium Donum was withdrawn by the act of 1866 which disestablished the Irish church. Provision was made, however, for existing interests therein, and many Presbyterian ministers commuted these on the same terms as the clergy of the church of Ireland.

In England the Regium Donum proper dates from 1721, when Dr Edmund Calamy (1671–1732) received £500 from the royal bounty "for the use and behalf of the poor widows of dissenting ministers." Afterwards this sum was increased to £1000 and was made an annual payment "for the assisting either ministers or their widows," and later it amounted to £1695 per annum. It was given to distributors who represented the three denominations, Presbyterians, Baptists and Independents, enjoying the grant. Among the Nonconformists themselves, however, or

at least among the Baptists and the Independents, there was some objection to this form of state aid, and in 1851 the chancellor of the exchequer announced that it would be withdrawn. This was done six years later.

See J. Stoughton, *History of Religion in England* (1901); J. S. Reid, *History of the Presbyterian Church in Ireland* (Belfast, 1867); and E. Calamy, *Historical Account of my own Life*, edited by J. T. Rutt (1829–30).

REGLA, formerly an important suburb of Havana, Cuba, opposite that city, on the bay; now a part of Havana. Pop. (1899) 11,363. It was formerly the scene of the Havana bull-fights. The church is one of the best in Cuba; the building dates substantially from 1805, but the church settlement goes back to a hermitage established in 1690. Regla is the shipping-point of the Havana sugar trade. It has enormous sugar and tobacco warehouses, fine wharves, a dry dock, foundries and an electric railway plant. It is the western terminus of the eastern line of the United Railways of Havana, and is connected with the main city of Havana by ferry. A fishing village was established here about 1733. At the end of the 18th century Regla was a principal centre of the smuggling trade, and about 1820 was notorious as a resort of pirates. It first secured an *ayuntamiento* (city council) in 1872, and after 1899 was annexed to Havana.

REGNARD, JEAN FRANÇOIS (1655–1709), French comic dramatist, was born in Paris on the 7th of February 1655. His father, a rich shopkeeper, died when Regnard was about twenty, leaving him master of a considerable fortune. He set off at once for Italy, and, after a series of romantic adventures, he journeyed by Holland, Denmark and Sweden to Lapland, and thence by Poland, Turkey, Hungary and Germany back to France. He returned to Paris at the end of 1683, and bought the place of treasurer of France in the Paris district; he had a house at Paris in the Rue Richelieu; and he acquired the small estate of Grillon near Dourdan in the department of Seine-et-Oise, where he hunted, feasted and wrote comedies. This latter amusement he began in 1688 with a piece called *Le Divorce*, which was performed at the Théâtre Italien. In four slight pieces of the same nature he collaborated with Charles Rivière Dufresny. He gained access to the Théâtre Français on the 10th of May 1694 with a piece called *Attendez-moi sous l'orme*, and two years later, on the 19th of December 1696, he produced there the masterly comedy of *Le Joueur*. The idea of the play was evolved in collaboration with Dufresny, but the authors disagreed in carrying it out. Finally they each produced a comedy on the subject, Dufresny in prose, and Regnard in verse. Each accused the other of plagiarism. The plot of Regnard's piece turns on the love of two sisters for Valère, the gambler, who loves one and pretends to love the other, really deceiving them both, because there is no room for any other passion in his character except the love of play. Other of his plays were *La Stérénade* (1694), *Le Bourgeois de Falaise* (1696), *Le Distrait* (1697), *Démocrite* (1700), *Le Retour imprévu* (1700), *Les Fêtes amoureuses* (1704), *Les Ménechmes* (1705), a clever following of Plautus, and his masterpiece, *Le Légataire universel* (1708).

Regnard's death on the 4th of September 1709 renews the doubtful and romantic circumstances of his earlier life. Some hint at poison, but the truth seems to be that his death was hastened by the rate at which he lived.

Besides the plays noticed above and others, Regnard wrote miscellaneous poems, the autobiographical romance of *La Provençale*, and several short accounts in prose of his travels, published posthumously under the title of *Voyages*. Regnard had written a reply to the tenth satire of Boileau, *Contre les femmes*, and Boileau had retorted by putting Regnard among the poets deprecated in his epistle *Sur mes vers*. After the appearance of *Le Joueur* the poet altered his opinion and cut out the allusion. The saying attributed to Boileau when some one, thinking to curry favour, remarked that Regnard was only a mediocre poet, "Il n'est pas médiocrement gai," is both true and very appropriate. His French style, especially in his purely prose works, is not considered faultless. He is often unoriginal in his plots, and, whether Dufresny was or was not justified in his complaint about *Le Joueur*, it seems likely that Regnard owed not a little to him and to others; but he had a thorough grasp of

comic situation and incident, and a most amusing faculty of dialogue.

The first edition of Regnard's works was published in 1731 (5 vols., Rouen and Paris). There is a good selection of almost everything important in the Collection Didot (4 vols., 1819), but there is no absolutely complete edition. The best is that published by Craplet (6 vols., Paris, 1822). A selection by L. Moland appeared in 1893. See also a *Bibliographie et iconographie des œuvres de J. F. Regnard* (Paris, Rouquette, 1878); *Le Poète J. F. Regnard en son château de Grillon*, by J. Guyot (Paris, 1907).

REGNAULT, HENRI (1843-1871), French painter, born at Paris on the 31st October 1843, was the son of Henri Victor Regnault (*q.v.*). On leaving school he successively entered the studios of Montfort, Lamotte and Cabanel, was beaten for the *Grand Prix* (1863) by Layraud and Montchablon, and in 1864 exhibited two portraits in no wise remarkable at the Salon. In 1866, however, he carried off the *Grand Prix* with a work of unusual force and distinction—"Thetis bringing the Arms forged by Vulcan to Achilles" (School of the Fine Arts). The past in Italy did not touch him, but his illustrations to Wey's *Rome* show how observant he was of actual life and manners; even his "Automedon" (School of Fine Arts), executed in obedience to Academic regulations, was but a lively recollection of a carnival horse-race. At Rome, moreover, Regnault came into contact with the modern Hispano-Italian school, a school highly materialistic and inclined to regard even the human subject only as one amongst many sources whence to obtain amusement for the eye. The vital, if narrow, energy of this school told on Regnault with ever-increasing force during the few remaining years of his life. In 1868 he had sent to the Salon a life-size portrait of a lady in which he had made one of the first attempts to render the actual character of fashionable modern life. While making a tour in Spain, he saw Prim pass at the head of his troops, and received that lively image of a military demagogue which he afterwards put on canvas, somewhat to the displeasure of his subject. But this work made an appeal to the imagination of the public, whilst all the later productions of Regnault were addressed exclusively to the eye. After a further flight to Africa, abridged by the necessities of his position as a pensioner of the school of Rome, he painted "Judith," then (1870) "Salome," and, as a work due from the Roman school, despatched from Tangier the large canvas, "Execution without Hearing under the Moorish Kings," in which the painter had played with the blood of the victim as if he were a jeweller toying with rubies. The war arose, and found Regnault foremost in the devoted ranks of Buzenval, where he fell on the 19th of January 1871.

See *Correspondance de H. Regnault*; Duparc, *H. Regnault, sa vie et son œuvre*; Cazalis, *H. Regnault, 1843-1871*; Baillières, *Les Artistes de mon temps*; C. Blanc, *H. Regnault*; P. Mantz, *Gazette des Beaux Arts* (1872).

REGNAULT, HENRI VICTOR (1810-1878), French chemist and physicist, was born on the 21st of July 1810 at Aix-la-Chapelle. His early life was a struggle with poverty. When a boy he went to Paris and obtained a situation in a large drapery establishment, where he remained, occupying every spare hour in study, until he was in his twentieth year. Then he entered the *École Polytechnique*, and passed in 1832 to the *École des Mines*, where he developed an aptitude for experimental chemistry. A few years later he was appointed to a professorship of chemistry at Lyons. His most important contribution to organic chemistry was a series of researches, begun in 1835, on the haloid and other derivatives of unsaturated hydrocarbons. He also studied the alkaloids and organic acids, introduced a classification of the metals according to the facility with which they or their sulphides are oxidized by steam at high temperatures, and effected a comparison of the chemical composition of atmospheric air from all parts of the world. In 1840 he was recalled to Paris by his appointment to the chair of chemistry in the *École Polytechnique*; at the same time he was elected a member of the *Académie des Sciences*, in the chemical section, in room of P. J. Robiquet (1780-1840); and in the following year he became professor of physics in the *Collège de France*, there succeeding P. L. Dulong, his old master, and in many respects

his model. From this time Regnault devoted almost all his attention to practical physics; but in 1847 he published a four-volume treatise on *Chemistry* which has been translated into many languages.

Regnault executed a careful redetermination of the specific heats of all the elements obtainable, and of many compounds—solids, liquids and gases. He investigated the expansibility of gases by heat, determining the coefficient for air as 0.003665, and showed that, contrary to previous opinion, no two gases had precisely the same rate of expansion. By numerous delicate experiments he proved that Boyle's law is only approximately true, and that those gases which are most readily liquefied diverge most widely from obedience to it. He studied the whole subject of thermometry critically; he introduced the use of an accurate air-thermometer, and compared its indications with those of a mercurial thermometer, determining the absolute dilatation of mercury by heat as a step in the process. He also paid attention to hygrometry and devised a hygrometer in which a cooled metal surface is used for the deposition of moisture.

In 1854 he was appointed to succeed J. J. Ebelmen (1814-1852) as director of the porcelain manufactory at Sèvres. He carried on his great research on the expansion of gases in the laboratory at Sèvres, but all the results of his latest work were destroyed during the Franco-German War, in which also his son Henri (noticed above) was killed. Regnault never recovered from the double blow, and, although he lived until the 19th of January 1878, his scientific labours ended in 1872. He wrote more than eighty papers on scientific subjects, and he made important researches in conjunction with other workers. His greatest work, bearing on the practical treatment of steam-engines, forms vol. xxi. of the *Mémoires de l'Académie des Sciences*.

REGNAULT, JEAN BAPTISTE (1754-1829), French painter, was born at Paris on the 9th of October 1754, and died in the same city on the 12th of November 1829. He began life at sea in a merchant vessel, but at the age of fifteen his talent attracted attention, and he was sent to Italy by M. de Monval under the care of Bardin. After his return to Paris, Regnault, in 1776, obtained the *Grand Prix*, and in 1783 he was elected Academician. His diploma picture, the "Education of Achilles by Chiron," is now in the Louvre, as also the "Christ taken down from the Cross," originally executed for the royal chapel at Fontainebleau, and two minor works—the "Origin of Painting" and "Pygmalion praying Venus to give Life to his Statue." Besides various small pictures and allegorical subjects, Regnault was also the author of many large historical paintings; and his school, which reckoned amongst its chief attendants Guérin, Crepin, Lafitte, Blondel, Robert Lefevre and Menjaud, was for a long while the rival in influence of that of David.

REGNAULT DE SAINT JEAN D'ANGÉLY, MICHEL LOUIS ÉTIENNE, COMTE (1761-1819), French politician, was born at Saint Fargeau (Yonne) on the 3rd of December 1761. Before the Revolution he was an *avocat* in Paris and lieutenant of the maritime provostship of Rochefort. In 1789 he was elected deputy to the States General by the Third Estate of the *sénéchaussée* of Saint Jean d'Angély. His eloquence made him a prominent figure in the Constituent Assembly, where he boldly attacked Mirabeau, and settled the dispute about the ashes of Voltaire by decreeing that they belonged to the nation. But the moderation shown by the measures he proposed at the time of the flight of the king to Varennes, by his refusal to accede to the demands for the king's execution, and by the articles he published in the *Journal de Paris* and the *Ami des patriotes*, marked him out for the hostility of the advanced parties. He was arrested after the revolution of the 10th of August 1792, but succeeded in escaping, and during the reaction which followed the fall of Robespierre was appointed administrator of the military hospitals in Paris. His powers of organization brought him to Bonaparte's notice, and he took part in the *coup d'état* of 18 Brumaire, year VIII. (9th of November 1799). Under the Empire he enjoyed the confidence of Bonaparte, and was made councillor of state, president of section in the Council of State,

member of the French Academy, *procureur général* of the high court, and a count of the Empire. He was dismissed on the first restoration of the Bourbons, but resumed his posts during the Hundred Days, and after Waterloo persuaded the emperor to abdicate. He was exiled by the government of the second Restoration, but subsequently obtained leave to return to France. He died on the day of his return to Paris (11th of March 1819). *Les Souvenirs du Comte Regnault de St Jean d'Angély* (Paris, 1817) are spurious. His son, AUGUSTE MICHEL ÉTIENNE REGNAULT DE SAINT JEAN D'ANGÉLY (1794-1870), an army officer, was dismissed from the army by the Restoration government, fought for the Greeks in the Greek War of Independence, and rejoined the French army in 1830. In 1848 he was elected deputy and sat on the right. Under the Second Empire he went through the Crimean and Italian campaigns, and was made senator and marshal for bravery at the battle of Magenta.

RÉGNIER, HENRI FRANÇOIS JOSEPH DE (1864-), French poet, was born at Honfleur (Calvados) on the 28th of December 1864, and was educated in Paris for the law. In 1885 he began to contribute to the Parisian reviews, and his verses found their way into most of the French and Belgian periodicals favourable to the symbolist writers. Having begun, however, to write under the leadership of the Parnassians, he retained the classical tradition, though he adopted some of the innovations of Moréas and Gustave Kahn. His gorgeous and vaguely suggestive style shows the influence of Stéphane Mallarmé, of whom he was an assiduous disciple. His first volume of poems, *Lendemain*, appeared in 1885, and among numerous later volumes are *Poèmes anciens et romanesques* (1890), *Les Jeux rustiques et divins* (1890), *Les Médailles d'argent* (1900), *La Cité des eaux* (1903). He is also the author of a series of realistic novels and tales, among which are *La Ceme de jaspe* (2nd ed., 1897), *La Double Maîtresse* (5th ed., 1900), *Les Vacances d'un jeune homme sage* (1904), and *Les Amants singuliers* (1905). M. de Régnier married Mlle. Marie de Hérédia, daughter of the poet, and herself a novelist and poet under the name of Gérard d'Houville.

See E. Gosse, *French Profiles* (1905), and *Poètes d'aujourd'hui* (6th ed., 1905), by van Bever and Léautaud.

RÉGNIER, MATHURIN (1573-1613), French satirist, was born at Chartres on the 21st of December 1573. His father, Jacques Régnier, was a bourgeois of good means and position; his mother, Simone Desportes, was the sister of the poet Desportes. Desportes, who was richly benefited and in great favour at court, seems to have been regarded as Mathurin Régnier's natural protector and patron; and the boy himself, with a view to his following in his uncle's steps, was tonsured at eight years old. Little is known of his youth, and it is chiefly conjecture which fixes the date of his visit to Italy in a humble position in the suite of the cardinal, François de Joyeuse, in 1587. The cardinal was accredited to the papal court in that year as "protector" of the royal interests. Régnier found his duties irksome, and when, after many years of constant travel in the cardinal's service, he returned definitely to France about 1605, he took advantage of the hospitality of Desportes. He early began the practice of satirical writing, and the enmity which existed between his uncle and the poet Malherbe gave him occasion to attack the latter. In 1606 Desportes died, leaving nothing to Régnier, who, though disappointed of the succession to Desportes's abbacies, obtained a pension of 2000 livres, chargeable upon one of them. He was also made in 1609 canon of Chartres through his friendship with the lax bishop, Philippe Hurault, at whose abbey of Royaumont he spent much time in the later years of his life. But the death of Henry IV. deprived him of his last hope of great preferments. His later life had been one of dissipation, and he died at Rouen at his hotel, the *Écu* d'Orléans, on the 22nd of October 1613.

About the time of his death numerous collections of licentious and satirical poems were published, while others remained in manuscript. Gathered from these there has been a floating

mass of licentious epigrams, &c., attributed to Régnier, little of which is certainly authentic, so that it is very rare to find two editions of Régnier which exactly agree in contents. His undoubted work falls into three classes: regular satires in alexandrine couplets, serious poems in various metres, and satirical or jocular epigrams and light pieces, which often, if not always, exhibit considerable licence of language. The real greatness of Régnier consists in the vigour and polish of his satires, contrasted and heightened as that vigour is with the exquisite feeling and melancholy music of some of his minor poems. In these Régnier is a disciple of Ronsard (whom he defended brilliantly against Malherbe), without the occasional pedantry, the affectation or the undue fluency of the Pléiade; but in the satires he seems to have had no master except the ancients, for some of them were written before the publication of the satires of Vauquelin de la Fresnaye, and the *Tragiques* of D'Aubigné did not appear until 1616. He has sometimes followed Horace closely, but always in an entirely original spirit. His vocabulary is varied and picturesque, and is not marred by the maladroit classicism of some of the Ronsardists. His verse is extraordinarily forcible and nervous, but his chief distinction as a satirist is the way in which he avoids the commonplaces of satire. His keen and accurate knowledge of human nature and even his purely literary qualities extorted the admiration of Boileau. Régnier displayed remarkable independence and acuteness in literary criticism, and the famous passage (*Satire ix.*, *A Monsieur Rapin*) in which he satirizes Malherbe contains the best denunciation of the merely "correct" theory of poetry that has ever been written. Lastly, Régnier had a most unusual descriptive faculty, and the vividness of what he called his narrative satires was not approached in France for at least two centuries after his death. All his merits are displayed in the masterpiece entitled *Macette ou l'Hypocrisie déconcertée*, which does not suffer even on comparison with *Tartuffe*; but hardly any one of the sixteen satires which he has left falls below a very high standard.

Les Premières Œuvres ou satyres de Régnier (Paris, 1608) included the *Discours au roi* and ten satires. There was another in 1609, and others in 1612 and 1613. The author had also contributed to two collections—*Les Muses gaillardes* in 1609 and *Le Temple d'Apollon* in 1611. In 1616 appeared *Les Satyres et autres œuvres folastres du sieur Régnier*, with many additions and some poems by other hands. Two famous editions by Elsevir (Leiden, 1642 and 1652) are highly prized. The chief editions of the 18th century are that of Claude Brossette (printed by Lyon & Woodman, London, 1729), which supplies the standard commentary on Régnier, and that of Lenglet Dufresnoy (printed by J. Tonson, London, 1733). The editions of Prosper Poitevin (Paris, 1860), of Ed. de Barthélémy (Paris, 1862), and of E. Courbet (Paris, 1875), may be specially mentioned. The last, printed after the originals in italic type, and well edited, is perhaps the best. See also Vianey's *Mathurin Régnier* (1896); M. H. Cherrier, *Bibliographie de Mathurin Régnier* (1884).

REGNITZ, a river of Germany, and a left-bank tributary of the Main, the most important river of the province of Lower Bavaria. It is formed by the confluence, near Fürth, of the Rednitz and Pegnitz. The united river flows north through an undulating vine-clad country, past Erlangen, Baiersdorf and Forchheim, from which point it is navigable, and falls into the Main at Bischoberg, just below Bamberg, after a course of 126 m. Near Bamberg it is joined by the Ludwigskanal, which, running parallel to it from Fürth and separated by the railway, forms the water-connexion between the Main and the Danube. Its main tributaries from the right are the Gründlach and the Wiesent, and from the left the Zenn, the Aurach and the Aisch.

REGRATING (O.Fr. *regrater*, to sell by retail), in English criminal law, was the offence of buying and selling again in the same market, or within four miles thereof. (See EN-GROSSING.)

REGULA, the Latin word for a rule, hence particularly applied to the rules of a religious order (see MONASTICISM). In architecture the term is applied to a rule or square, the short fillet or rectangular block, under the *taenia* (q.v.) on the architrave of the Doric entablature.

REGULAR, orderly, following or arranged according to a rule (Lat. *regula*, whence O.Fr. *reule*, whence English "rule"), steady, uniform, formally correct. The earliest and only use in English until the 16th century was in the Med. Lat. sense of *regularis*, one bound by and subject to the rule (*regula*) of a monastic or religious order, a member of the "regular" as opposed to the "secular" clergy, and so, as a substantive, a regular, *i.e.* a monk or friar. Another specific application is to that portion of the armed forces of a nation which are organized on a permanent system, the standing army, as opposed to "irregulars," levies raised on a voluntary basis and disbanded when the particular campaign or war for which they were raised is at an end. In the British army, the forces were divided into regulars, militia and volunteers, until 1906, when they were divided into regular and territorial forces.

REGULUS, MARCUS ATILIUS, Roman general and consul (for the second time) in the ninth year of the First Punic War (256 B.C.). He was one of the commanders in the Punic naval expedition which shattered the Carthaginian fleet at Ecnomus, and landed an army on Carthaginian territory (see PUNIC WARS). The invaders were so successful that the other consul, L. Manlius Vulso, was recalled to Rome, Regulus being left behind to finish the war. After a severe defeat at Adys near Carthage, the Carthaginians were inclined for peace, but the terms proposed by Regulus were so harsh that they resolved to continue the war. In 255, Regulus was completely defeated and taken prisoner by the Spartan Xanthippus. There is no further trustworthy information about him. According to tradition, he remained in captivity until 250, when after the defeat of the Carthaginians at Panormus he was sent to Rome on parole to negotiate a peace or exchange of prisoners. On his arrival he strongly urged the senate to refuse both proposals, and returning to Carthage was tortured to death (Horace, *Odes*, iii. 5). This story made Regulus to the later Romans the type of heroic endurance; but most historians regard it as insufficiently attested, Polybius being silent. The tale was probably invented by the annalists to excuse the cruel treatment of the Carthaginian prisoners by the Romans.

See Polybius i. 25-34; Florus ii. 2; Cicero, *De Officiis*, iii. 26; Livy, *Epit.* 18; Valerius Maximus ix. 2; Sil. Ital. vi. 299-550; Appian, *Punica*, 4; Zonaras viii. 15; see also O. Jäger, *M. Atilius Regulus* (1878).

REHAN, ADA (1860—), American actress, whose real name was Crehan, was born in Limerick, Ireland, on the 22nd of April 1860. Her parents removed to the United States when she was five years old, and it was in Newark, N.J., that in 1874 she made her first stage appearance in a small part in *Across the Continent*. She was with Mrs John Drew's stock company in Philadelphia, John W. Albaugh's in Albany and Baltimore, and other companies for several seasons, playing every kind of minor part, until she became connected with Augustin Daly's theatrical management in 1879. Under his training she soon showed her talents for vivid, charming portrayal of character, first in modern and then in older comedies. She was the heroine in all the Daly adaptations from the German, and added to her triumphs the parts of Peggy in Wycherly's *Country Girl*, Julia in the *Hunchback*, and especially Katharina in *The Taming of the Shrew*, besides playing Rosalind and Viola. Miss Rehan accompanied Daly's company to England (first in 1884), France and Germany (1886). Her life-size portrait as Katharina is in the picture-gallery, and her bust, with Ellen Terry's, at the entrance to the theatre in the Shakespeare Memorial at Stratford-on-Avon.

REHEARSAL (from "rehearse" to say over again, repeat, recount, O.Fr. *rehercer*, from *re*, again, and *hercer*, to harrow, cf. "hearse," the original meaning being to rake or go over the same ground again as with a harrow), a recital of words or statements, particularly the trial performance in private of a play, musical composition, recitation, &c., for the purpose of practice preparatory to the performance in public. In the theatre a "full rehearsal" is one in which the whole performance is gone through with all the performers, a "dress rehearsal"

one in which the performance is carried out with scenery, costumes, properties, &c., exactly as it is to be played in public.

REHOBOAM (Heb. *rehab'am*, probably "the clan is enlarged" see Ecclus. xvii. 23, although on the analogy of Rehobiah and Bab. *ra'bi-'ilam*, 'Am may represent some god; Septuagint reads ροβοαμ), son of Solomon and first king of Judah. On the events which led to his accession and the partition of the Hebrew monarchy, see JEROBOAM, SOLOMON. Although his age is given as forty-one (1 Kings xiv. 21), the account of his treatment of the Israelite deputation (1 Kings xiii.), as also 2 Chron. xiii. 7, give an impression of youth. He was partly of Ammonite origin (1 Kings xiv. 21), and, like his father, continued the foreign worship which his connexions involved. The chief event of his reign was the incursion of Egypt under Sheshonk (Shishak) I., who came up against Judah and despoiled the temple about 930 B.C. (see EGYPT, *History*, § "Deltaic Dynasties"). That this invasion is to be connected with the friendly relations which are said to have subsisted between the first of the Libyan dynasty and Rehoboam's rival is unlikely. Sheshonk has figured his campaign outside the great temple of Karnak with a list of some 150 places which he claims to have conquered, but it is possible that these were only tributary, and the names may be largely based upon older lists. Towns of both Judah and Israel are incorporated, and it is possible that Jerusalem once stood where now the stone is mutilated.¹ The book of Chronicles enumerates several Judean cities fortified by Rehoboam (not necessarily connected with Sheshonk's campaign), and characteristically regards the invasion as a punishment (2 Chron. xi. 5 sqq., xii. 1-15; for the prophet Shemaiah see 1 Kings xii. 21-24). Of Rehoboam's successor Abijah (or Abijam) little is known except a victory over Jeroboam recorded in 2 Chron. xiii. See further ASA, OMRI, and JEWS (*History*), §§ 7, 9.

REICHA, ANTON JOSEPH (1770-1836), French musical theorist and teacher of composition, was born at Prague on the 27th of February 1770, and educated chiefly by his uncle, Joseph Reicha (1746-1795), a clever violoncellist, who first received him into his house at Wallerstein in Bohemia, and afterwards carried him to Bonn. Here, about 1789, he was made flutist in the orchestra of the elector. In 1794 he went to Hamburg and gave music lessons there, also producing the opera *Godefroid de Montfort*. He was in Paris in 1799 and in Vienna from 1802 to 1808, during which period he saw much of Beethoven and Haydn. In the latter year he returned to Paris, where he produced three operas without much success. In 1817 he succeeded Méhul as professor of counterpoint at the Conservatoire. In 1829 he was naturalized as a Frenchman, and in 1835 he was admitted as a member of the Institute in the place of Boieldieu. He died in Paris on the 28th of May 1836. He produced a vast quantity of church music, five operas, a number of symphonies, oratorios and many miscellaneous works. Though clever and ingenious, his compositions are more remarkable for their novelty than for the beauty of the ideas upon which they are based. His fame is, indeed, more securely based upon his didactic works. His *Traité de mélodie* (Paris, 1814), *Cours de composition musicale* (Paris, 1818), *Traité de haute composition musicale* (Paris, 1824-26), and *Art du compositeur dramatique* (Paris, 1833), are valuable and instructive essays for the student, though many of the theories they set forth are now condemned as erroneous.

REICHENAU, a picturesque island in the Untersee or western arm of the lake of Constance, 3 m. long by 1 broad, and connected with the east shore by a causeway three-quarters of a mile long. It belongs to the grand duchy of Baden. The soil

¹ The once popular view that "king of Judah" stands in no. 29 is untenable. See Petrie, *Hist. of Egypt*, ii. p. 235; L. B. Paton, *Syria and Pal.* p. 193 sq.; W. M. Müller, *Mitteil. Vorderasiat. Gesell.*, 1900, p. 19 sq., and *Ency. Bib. col.* 4486. Breasted (*Amer. Journ. of Sem. Lang.*, 1904, p. 36) has made the interesting observation that the list mentions "the field of Abram" (nos. 71 and 72); see further, *id.*, *Egypt Hist. Records*, iv. pp. 348-357.

is very fertile, and excellent wine is produced in sufficient quantity for exportation. The Benedictine abbey of Reichenau, founded in 724, was long celebrated for its wealth and for the services rendered by its monks to the cause of learning. In 1540 the abbey, which had previously been independent, was annexed to the see of Constance, and in 1799 it was secularized. The abbey church, dating in part from the 9th century, contains the tomb of Charles the Fat (d. 888), who retired to this island in 887, after losing the empire of Charlemagne. It now serves as the parish church of Mittelzell, while the churches of Oberzell and Unterzell are also interesting buildings of the Carolingian era.

REICHENBACH, GEORG VON (1772-1826), German astronomical instrument maker, was born at Durlach in Baden on the 24th of August 1772. From 1796 he was occupied with the construction of a dividing engine; in 1804, with Joseph, Liebherr and Joseph Utzschneider, he founded an instrument-making business in Munich; and in 1809 he established, with Joseph Fraunhofer and Utzschneider, optical works at Benedict-beuern, which were moved to Munich in 1823. He withdrew from both enterprises in 1814, and founded with T. L. Ertel a new optical business, from which also he retired in 1821, on obtaining an engineering appointment under the Bavarian government. He died at Munich on the 21st of May 1826.

Reichenbach's principal merit was that he introduced into observatories the meridian or transit circle, combining the transit instrument and the mural circle into one instrument. This had already been done by O. Römer about 1704, but the idea had not been adopted by any one else, except in the transit circle constructed by Edward Troughton for Stephen Groombridge in 1806. The transit circle in the form given it by Reichenbach had one finely divided circle attached to one end of the horizontal axis and read by four verniers on an "alidade circle," the unaltered position of which was tested by a spirit level. The instrument came almost at once into universal use on the continent of Europe (the first one was made for F. W. Bessel in 1819), but in England the mural circle and transit instrument were not superseded for many years.

REICHENBACH, a town of Germany, in the Prussian province of Silesia, situated on the Peile, at the foot of the Eulengebirge, a spur of the Riesengebirge, 30 m. S.W. of Breslau by rail. Pop. (1905) 15,984. Among its industries are weaving, spinning, dyeing, brewing and machine building, and there is a considerable trade in grain and cattle. Reichenbach is memorable for the victory gained here on the 16th of August 1762 by the Prussians over the Austrians. Here was held the congress which resulted in the convention of Reichenbach—signed on the 27th of July 1790 between Great Britain, Prussia, Austria, Poland and Holland—guaranteeing the integrity of Turkey. Here, too, in June 1813, was signed the treaty of alliance between Austria and the Allies for the prosecution of the war against France.

See the *Kurse Geschichte der Stadt Reichenbach* (Reichenbach, 1874).

REICHENBACH, a town in the kingdom of Saxony, situated in a hilly district, known as the Vogtland, 11 m. S.W. of Zwickau, at the junction of the main lines of railway Dresden-Leipzig-Hof. Pop. (1905) 24,915. It contains a handsome town-hall rebuilt in 1833, and a natural history museum. The industries embrace the manufacture of cloth, machinery and carriages, also dyeing and bleaching. The earliest mention of the town occurs in a document of 1212, and it acquired municipal rights in 1367. The woollen manufacture was introduced in the 15th century, and took the place of the mining industry which had been established earlier.

REICHENBERG (Czech, *Liberec*), a town of Bohemia, 87 m. N.E. of Prague by rail. Pop. (1900) 34,099, chiefly German. The most prominent buildings are the new town-hall (1893); the castle of Count Clam Gallas, built in the 17th century, with additions dating from 1774 and 1850; the Erzknechtenskirche, of the 16th century; the Protestant church, a handsome modern Romanesque edifice (1864-68) and the hall of the cloth-workers. Reichenberg is one of the most important centres of trade and industry in Bohemia, its staple industry being the cloth manufacture. Next in importance comes the

spinning and weaving of wool, cotton, linen and carpet manufactures, and dyeing.

Reichenberg is first mentioned in a document of 1348, and from 1622 to 1634 was among the possessions of the great Wallenstein, since whose death it has belonged to the Gallas and Clam Gallas families, though their jurisdiction over the town has long ceased. The cloth-making industry was introduced in 1579.

REICHENHALL, a town and watering-place in the kingdom of Bavaria, finely situated in an amphitheatre of lofty mountains, on the river Saalach, 1570 ft. above sea-level, 9 m. S.W. of Salzburg. Pop. (1900) 4927, excluding visitors. Reichenhall possesses several copious saline springs, producing about 8500 tons of salt per annum. The water of some of the springs, the sources of which are 50 ft. below the surface, is so strongly saturated with salt (up to 24%) that it is at once conducted to the boiling houses, while that of the others is first submitted to a process of evaporation. Reichenhall is the centre of the four chief Bavarian salt-works, which are connected with each other by brine conduits having an aggregate length of 60 m. The surplus brine of Berchtesgaden is conducted to Reichenhall, and thence, in increased volume, to Traunstein and Rosenheim, which possess larger supplies of timber for use as fuel in the process of boiling. Since 1846 Reichenhall has become one of the most fashionable spas and climatic health resorts in Germany, and it is now visited annually by about ten thousand patients, besides many thousand passing tourists. The saline springs are used both for drinking and bathing, and are said to be efficacious in scrofula and incipient tuberculosis.

The brine springs of Reichenhall are mentioned in a document of the 8th century and were perhaps known to the Romans; but almost all trace of antiquity of the town was destroyed by a conflagration in 1834. The brine conduit to Traunstein dates from 1618. The environs abound in numerous charming Alpine excursions.

See G. von Liebig, *Reichenhall, sein Klima und seine Heilmittel* (6th ed., Reichenhall, 1889); and Goldschmidt, *Der Saalach und Reichenhall und seine Umgebung* (Vienna, 1892).

REICHENSBERGER, AUGUST (1808-1895), German politician, was born at Coblenz on the 22nd of March 1808, studied law and entered government service, becoming councillor to the court of appeal (*Appellationsgerichtsrat*) at Cologne in 1849. He was a member of the German parliament at Frankfurt in 1848, when he attached himself to the Right, and of the Erfurt parliament in 1850, when he voted against the Prussian Union. From 1850 to 1863 he sat in the Prussian Lower House, from 1867 to 1884 in the Reichstag, and from 1879 onwards also in the Prussian Chamber of Deputies. Originally of Liberal tendencies, he developed from 1837 onwards ultramontane opinions, founded in 1852 the Catholic group which in 1861 took the name of the Centre party (*Centrum*) and became one of its most conspicuous orators. He died on the 16th of July 1895 at Cologne. He published a considerable number of works on art and architecture, including *Die christlich-germanische Baukunst* (Trier, 1852, 3rd ed., 1860); *Fingerzeige auf dem Gebiete der christlichen Kunst* (Leipzig, 1854); *Augustus Pugin, der Neubegründer der christlichen Kunst in England* (Freiburg, 1877).

See L. v. Pastor, *August Reichensperger*, 2 vols. (Freiburg-im-Breisgau, 1899).

His brother, PETER REICHENSBERGER (1810-1892), councillor to the appeal court at Cologne (1850) and until 1879 to the *Obertribunal* at Berlin, was elected to the Reichstag in 1867 as a member of the Liberal Opposition, but subsequently joined the Centre party. In the *Kulturkampf* he took an active part on the ultramontane side. He had been a member of the Prussian National Assembly in 1848, and in 1888 he published his *Erlebnisse eines alten Parlamentariers im Revolutionsjahr 1848*.

REICHSTADT, NAPOLEON FRANCIS JOSEPH CHARLES, DUKE OF (1811-1832), known by the Bonapartists as Napoleon II., was the son of the Emperor Napoleon I. and Marie Louise, archduchess of Austria. He was born on the 20th of

March 1811, in Paris at the Tuileries palace. He was at first named the king of Rome, after the analogy of the heirs of the emperors of the Holy Roman Empire. By his birth the Napoleonic dynasty seemed to be finally established; but in three years it crumbled in the dust. At the time of the downfall of the empire (April 1814) Marie Louise and the king of Rome were at Blois with Joseph and Jerome Bonaparte, who wished to keep them as hostages. This design, however, was frustrated. Napoleon abdicated in favour of his son; but events prevented the reign of Napoleon II. from being more than titular. While Napoleon repaired to Elba, his consort and child went to Vienna; and they remained in Austria during the Hundred Days (1815), despite efforts made by the Bonapartists to carry off the prince to his father at Paris.

Meanwhile the congress of Vienna had carried out the conditions of the treaty of Fontainebleau (March 1814) whereby the duchies of Parma and Guastalla were to go to the ex-Empress Marie Louise and her son, although much opposition was offered to this proposal by Louis XVIII. and even (so it now appears) by Metternich. The secret treaty of the 31st of May 1815 between Austria, Russia and Prussia secured those possessions to her, her son bearing the title Prince of Parma, with hereditary rights for his descendants. But after the second abdication of Napoleon in favour of his son (22nd of June 1815)—a condition which was wholly nugatory—the powers opposed all participation of the prince in the affairs of Parma. He therefore remained in Austria, while Marie Louise proceeded to Parma. From this time onward he became, as it were, a pawn in the complex game of European politics, his claims being put forward sometimes by Metternich, sometimes by the unionists of Italy, while occasionally malcontents in France used his name to discredit the French Bourbons. The efforts of malcontents increased the resolve of the sovereigns never to allow a son of Napoleon to bear rule; and in November 1816 the court of Vienna informed Marie Louise that her son could not succeed to the duchies. This decision was confirmed by the treaty of Paris of the 10th of June 1817. Marie Louise demanded as a slight compensation that he should have a title derived from the lands of the "Bavarian Palatinate" in northern Bohemia, and the title of "duke of Reichstadt" was therefore conferred on him on the 22nd of July 1818. Thus Napoleon I., who once averred that he would prefer that his son should be strangled rather than brought up as an Austrian prince, lived to see his son reduced to a rank inferior to that of the Austrian archdukes.

His education was confided chiefly to Count Dietrichstein, who found him precocious, volatile, passionate and fond of military affairs. The same judgment was given by Marshal Marmont, duke of Ragusa, who recognized the warlike strain in his character. His nature was sensitive, as appeared on his receiving the news of the death of his father in 1821. The upheaval in France in 1830 and the disturbances which ensued led many Frenchmen to turn their thoughts to Napoleon II.; but though Metternich dallied for a time with the French Bonapartists, he had no intention of inaugurating a Napoleonic revival. By this time, too, the duke's health was on the decline; his impatience of all restraint and his indulgence in physical exercise far beyond his powers aggravated a natural weakness of the chest, and he died on the 22nd of July 1832.

See A. M. Barthélemy and J. P. A. Méry, *Le Fils de l'homme* (Paris, 1829); Baron G. I. Comte de Montbel, *Le Duc de Reichstadt* (Paris, 1832); J. de Saint-Félix, *Histoire de Napoléon II.* (Paris, 1853); Guy de l'Hérault, *Histoire de Napoléon II.* (Paris, 1853); Count Anton von Prokesch-Osten, *Mein Verhältnis zum Herzog von Reichstadt* (Stuttgart, 1878); H. Welschinger, *Le Roi de Rome* (Paris, 1897); E. de Wertheimer, *The Duke of Reichstadt* (Eng. ed., London, 1906); M. Rostand's play *L'Aiglon* is a dramatic setting of the career of the prince. (J. H. R.)

REID, SIR GEORGE (1841—), Scottish artist, was born in Aberdeen on the 31st of October 1841. He developed an early passion for drawing, which led to his being apprenticed in 1854 for seven years to Messrs Keith & Gibb, lithographers in Aberdeen. In 1861 Reid took lessons from an itinerant

portrait-painter, William Niddrie, who had been a pupil of James Giles, R.S.A., and afterwards entered as a student in the school of the Board of Trustees in Edinburgh. He returned to Aberdeen to paint landscapes and portraits for any trifling sum which his work could command. His first portrait to attract attention, from its fine quality, was that of George Macdonald, the poet and novelist, now the property of the university of Aberdeen. His early landscapes were conscientiously painted in the open air and on the spot. But Reid soon came to see that such work was inherently false, painted as the picture was day after day under varying conditions of light and shade. Accordingly, in 1865 he proceeded to Utrecht to study under A. Mollinger, whose work he admired, from its unity and simplicity. This change in his method of viewing Nature was looked on as revolutionary by the Royal Scottish Academy, and for some years his work found little favour in that quarter; but other artists gradually adopted the system of tone-studies, which ultimately prevailed. Reid went to Paris in 1868 to study under the figure painter Yvon; and he worked in 1872 with Josef Israëls at the Hague. From this time forward Reid's success was continuous and marked. He showed his versatility in landscape, as in his "Whins in Bloom," which combined great breadth with fine detail; in flower-pieces, such as his "Roses," which were brilliant in rapid suggestiveness and force; but most of all in his portraits, which are marked by great individuality, and by fine insight into character. His work in black-and-white, his admirable illustrations in brushwork of Edinburgh and its neighbourhood, and also his pen-drawings, about which it has been declared that "his work contains all the subtleties and refinements of a most delicate etching," must also be noted. Elected Associate of the Royal Scottish Academy in 1870, Reid attained full membership in 1877, and took up his residence in Edinburgh in 1882. In 1891 he was elected President—a post which he held until 1902—receiving also the honour of knighthood, and he was awarded a gold medal at the Paris Exhibition of 1900. His brother Samuel (b. 1854) was also a painter and a writer of tales and verse.

REID, ROBERT (1862—), American artist, was born at Stockbridge, Mass., on the 29th of July 1862. He studied at the art schools of the Boston Museum of Fine Arts, the Art Students' League, New York, and under Boulanger and Lefebvre in Paris. His early pictures were figures of French peasants, painted at Étapes, but subsequently he became best known for mural decoration and designs for stained glass. He contributed with others to the frescoes of the dome of the Liberal Arts Building at the Columbian Exposition, Chicago, in 1893. Other work is in the Congressional Library, Washington, the Appellate Court House, New York, and the State House, Boston, where are his three large panels, "James Otis Delivering his Speech against the Writs of Assistance," "Paul Revere's Ride" and the "Boston Tea Party." He executed a panel for the American Pavilion at the Paris Exhibition, 1900, and in 1906 he completed a series of ten stained glass windows for a church at Fairhaven, Mass., for the Rogers Memorial. In 1906 he became a full member of the National Academy of Design.

REID, SIR ROBERT GILLESPIE (1840–1908), Canadian railway contractor, was born at Couparr-Angus, Scotland. When a young man he spent a few years in Australia gold-mining, and in 1871 he settled in America, where he began his career as a contractor. He built one section of the Canadian Pacific railway, and was responsible for the erection of the international bridge over the Niagara river, the international railway bridge over the Rio Grande river and the Lachine bridge over the St. Lawrence. In 1893 Reid signed a contract with the government of Newfoundland by which he undertook to construct a railway from St. John's to Port-aux-Basques and to work the line for ten years in return for a large grant of land. In 1898 he further contracted to work all the railways in Newfoundland for fifty years on condition that at the end

of this time they should become his property. This bargain, which included other matters such as steamers, docks and telegraphs, was extraordinarily favourable to Reid; who, by further enormous grants of land, became one of the largest landed proprietors in the world; public opinion was aroused against it, and at first the governor, Sir Herbert Murray, refused to ratify it. After the premier, Sir James Winter, had been replaced by Mr (afterwards Sir) Robert Bond, the terms of the contract were revised, being made more favourable to Newfoundland, and Reid's interests were transferred to a company, the Reid Newfoundland Company, of which he was the first president (see *NEWFOUNDLAND, Roads and Railways*). Reid was knighted in 1907, and he died on the 3rd of June 1908.

REID, THOMAS (1710-1796), Scottish philosopher, was born at Strachan in Kincardineshire, on the 26th of April 1710. His father was minister of the place for fifty years, and traced his descent from a long line of Presbyterian ministers on Deeside. His mother belonged to the brilliant Gregory family (*q.v.*), which, in the 18th century, gave so many representatives to literature and science in Scotland. Reid graduated at Aberdeen in 1726, and remained there as librarian to the university for ten years, a period which he devoted largely to mathematical reading. In 1737 he was presented to the living of Newmachar near Aberdeen. The parishioners, violently excited at the time about the law of patronage, received him with open hostility; and tradition asserts that his uncle defended him on the pulpit stair with a drawn sword. Though not distinguished as a preacher, he was successful in winning the affections of his people. The publication of Hume's treatise turned his attention to philosophy, and in particular to the theory of external perception. His first publication, however, dealt with a question of philosophical method suggested by the reading of Hutcheson. The "Essay on Quantity, occasioned by reading a Treatise in which Simple and Compound Ratios are applied to Virtue and Merit," denies the possibility of a mathematical treatment of moral subjects. The essay appeared in the *Transactions of the Royal Society* (1748). In 1740 Reid married a cousin, the daughter of a London physician. In 1752 the professors of King's College, Aberdeen, elected him to the chair of philosophy, which he held for twelve years. The foundation of the Aberdeen Philosophical Society (the "Wise Club"), which numbered among its members Campbell, Beattie, Gerard and Dr John Gregory, was mainly owing to the exertions of Reid, who was secretary for the first year (1758). Many of the subjects of discussion were drawn from Hume's speculations; and during the last years of his stay in Aberdeen Reid propounded his new point of view in several papers read before the society. The results of these papers were embodied in the *Enquiry into the Human Mind on the Principles of Common Sense* (1764). The *Enquiry* does not go beyond an analysis of sense perception, and is therefore more limited in scope than the later *Essays*; but if the latter are more mature, there is more freshness about the earlier work. In this year, Reid succeeded Adam Smith as professor of moral philosophy in the university of Glasgow. After seventeen years of active teaching, he retired in order to complete his philosophical system. As a lecturer, he was inferior in charm and eloquence to Brown and Stewart; the latter says that "silent and respectful attention" was accorded to the "simplicity and perspicuity of his style" and "the gravity and authority of his character." His philosophical influence was exerted largely through the writings of Dugald Stewart and Sir William Hamilton. The *Essays on the Intellectual Powers of Man* appeared in 1785, and their ethical complement, the *Essays on the Active Powers of the Human Mind*, in 1788. These, with an account of Aristotle's *Logic* appended to Lord Kames's *Sketches of the History of Man* (1774), conclude the list of works published in Reid's lifetime. Hamilton's edition of Reid also contains an account of the university of Glasgow and a selection of Reid's letters, chiefly addressed to his Aberdeen friends the Skenes, to Lord Kames, and to Dr James Gregory. With the two last named he discussed the materialism of Priestley and

the theory of necessitarianism. He reverted in his old age to the mathematical pursuits of his earlier years, and his ardour for knowledge of every kind remained fresh to the last. He died of paralysis on the 7th of October 1796, his wife and all his children save one having predeceased him. His portrait by Raeburn is the property of Glasgow University, and in the National Portrait Gallery, Edinburgh, there is a good medallion by Tassie, taken in his eighty-first year. His character was marked by independence, economy and generosity.

The key to Reid's philosophy is to be found in his revision from the sceptical conclusions of Hume. In several passages of his writings he expressly dates his philosophical awakening from the appearance of the *Treatise of Human Nature*. In the dedication of the *Enquiry*, he says: "The ingenious author of that treatise upon the principles of Locke—who was no sceptic—hath built a system of scepticism which leaves no ground to believe any one thing rather than its contrary. His reasoning appeared to me to be just; there was, therefore, a necessity to call in question the principles upon which it was founded, or to admit the conclusion." Reid thus takes Hume's scepticism as, on its own showing, a *reductio ad impossibile* (see HUME, *ad fin.*) of accepted philosophical principles, and refuses, accordingly, to separate Hume from his intellectual progenitors. From its origin in Descartes and onwards through Locke and Berkeley, modern philosophy carried with it, Reid contends, the germ of scepticism. Embracing the whole philosophic movement under the name of "the Cartesian system," Reid detects its fundamental error in the unproved assumption shared by these thinkers "that all the objects of my knowledge are ideas in my own mind." This doctrine or hypothesis he usually speaks of as "the ideal system" or "the theory of ideas"; and to it he opposes his own analysis of the act of perception. In view of the results of this analysis, Reid's theory (and the theory of Scottish philosophy generally) has been dubbed natural realism or natural dualism, in contrast to theories like subjective idealism and materialism or to the cosmthetic idealism or hypothetical dualism of the majority of philosophers. But this unduly narrows the scope of Scottish philosophy, which does not exhaust itself, as is sometimes supposed, in uncritically reasserting the independent existence of matter and its immediate presence to mind. The real significance of Reid's doctrine lies in its attack upon Hume's fundamental principles, (1) that all our perceptions are distinct existences, and (2) that the mind never perceives any real connexion among distinct existences (cf. *Appendix to the second volume of the Treatise*, 1750). It is here that the danger of "the ideal system" really lies—in its reduction of reality to "particular perceptions," essentially unconnected with each other. This theory admitted, nothing is left for philosophy save to explain the illusion of necessary connexion. Reid, however, attacks the fundamental assumption. In logical language, he denies the actuality of the abstract particular. The unit of knowledge is not an isolated impression but a judgment; and in such a judgment is contained, even initially, the reference both to a permanent subject and to a permanent world of thought, and, implied in these, such judgments, for example, as those of existence, substance, cause and effect. Such principles are not derived from sensation, but are "suggested" on occasion of sensation, in such a way as to constitute the necessary conditions of our having perceptive experience at all. Thus we do not start with "ideas," and afterwards refer them to objects; we are never restricted to our own minds, but are from the first immediately related to a permanent world. Reid has a variety of names for the principles which, by their presence, lift us out of subjectivity into perception. He calls them "natural judgments," "natural suggestions," "judgments of nature," "judgments immediately inspired by the constitution," "principles of common sense," "first principles," "principles of common sense." The last, *Common Sense*, designation, which became the current one, was undoubtedly unfortunate, and has conveyed to many a false impression of Scottish philosophy. It has been understood as if Reid had merely appealed from the reasoned conclusions of philosophers to the unreasoned beliefs of common life. But Reid's actions are better than his words; his real mode of procedure is to reargue Hume's conclusions by a refutation of the premises inderogated by him from his professors. For the rest, as regards the question of nomenclature, Reid everywhere unites common sense and reason, making the former "only another name for one branch or degree of reason." Reason, as judging of things self-evident, is called common sense to distinguish it from ratiocination or reasoning. And in regard to Reid's favourite proof of the principles in question by reference to "the consent of ages and nations, of the learned and unlearned," it is only fair to observe that this argument assumes a much more scientific form in the *Essays*, where it is almost identified with an appeal to "the structure and grammar of all languages." The structure of all languages, he says, "is grounded upon common sense." To take but one example—"the distinction between sensible qualities and the substance to which they belong, and between thought and the mind that thinks, is not the invention of philosophers; it is found

have been built before the Conquest to command the pass through the valley, there only remains the entrance to a cave beneath, 150 ft. long and from 10 to 12 ft. high, excavated in the sandstone, which was used as a guardroom. The grounds are laid out as a public garden. Near the market house is the site of an ancient chapel dedicated to Thomas à Becket. In the chancel of the parish church of St Mary, a building ranging from Transitional Norman to Perpendicular, is buried Lord Howard, the commander of the English navy against the Spanish Armada. Above the vestry there is a library containing choice manuscripts and rare books. The grammar school was founded in 1675. Among the other public buildings are the town hall, the public hall, the market hall, and the working men's institute. The borough includes the township of Redhill, adjacent on the east. The town has some agricultural trade, and in the neighbourhood are quarries for freestone, heartstone and white sand. The borough is under a mayor, 6 aldermen and 18 councillors. Area, 5994 acres.

Reigate (*Cherchefelle, Regat, Reygate*) owed its first settlement to its situation at a cross-road on the Pilgrim's Way, at the foot of the North Downs; and its early importance to the castle which was the stronghold of the De Warennes in the 12th, 13th and 14th centuries. On the death of Edith, the widow of Edward the Confessor, to whom it belonged, William I. secured the manor of Cherchefelle, as it was then called. It was granted by William Rufus to Earl Warenne, through whose family it passed in 1347 to the earls of Arundel. The name Reigate occurs in 1199. Burghesses of Reigate are mentioned in a close roll of 1348, but no early charter is known. The town was incorporated in 1863. It returned two members to parliament from 1295 till 1831, and afterwards one member only until 1867, when it was disfranchised for corruption. In the reign of Edward I. Earl Warenne held a weekly market on Saturdays, and fairs on Tuesday in Whitsun-week, the eve and day of St Lawrence, and the eve and day of the Exaltation of the Cross, by prescriptive right. Edward II. granted a market on Tuesdays, which is still held. The fair days are now Whit-Tuesday and the 9th of December.

REIMARUS, HERMANN SAMUEL (1694-1768), German philosopher and man of letters, was born at Hamburg, on the 22nd of December 1694. He was educated by his father and by the famous scholar J. A. Fabricius, whose son-in-law he subsequently became. He studied theology, ancient languages, and philosophy at Jena, became *Privatdozent* in the university of Wittenberg in 1716, and in 1720-21 visited Holland and England. In 1723 he became rector of the high school at Wismar in Mecklenburg, and in 1727 professor of Hebrew and Oriental languages in the high school of his native city. This post he held till his death, though offers of more lucrative positions were made to him. His duties were light, and he employed his leisure in the study of philology, mathematics, philosophy, history, political economy, natural science and natural history, for which he made large collections. His house was the centre of the highest culture of Hamburg, and a monument of his influence in that city still remains in the *Haus der patriotischen Gesellschaft*, where the learned and artistic societies partly founded by him still meet. He had seven children, only three of whom survived him—the distinguished physician Johann Albrecht Heinrich, and two daughters, one of them being Elise, Lessing's friend and correspondent. He died on the 1st of March 1768.

Reimarus's reputation as a scholar rests on the valuable edition of Dio Cassius (1750-52) which he prepared from the materials collected by J. A. Fabricius. He published a work on logic (*Vernunftlehre als Anweisung zum richtigen Gebrauche der Vernunft*, 1756, 5th ed., 1790), and two popular books on the religious questions of the day. The first of these was a collection of essays on the principal truths of natural religion (*Abhandlungen von den vornehmsten Wahrheiten der natürlichen Religion*, 1755, 7th ed., 1798); the second (*Betrachtungen über die Triebe der Thiere*, 1760, 4th ed., 1798) dealt with one particular branch of the same subject. His philosophical position is essentially that of Christian Wolff. But he is best known by his *Apologie oder Schutzschrift für die vernünftigen Verehrer Gottes* (carefully kept back during his lifetime), from which, after his death, Lessing published certain chapters under the title of the *Wolfenbüttel Fragments* (see LESSING). The original

MS. is in the Hamburg town library; a copy was made for the university library of Göttingen, 1814, and other copies are known to exist. In addition to the seven fragments published by Lessing, a second portion of the work was issued in 1787 by C. A. E. Schmidt (a pseudonym), under the title *Uebrig noch ungedruckte Werke des Wolfenbüttelschen Fragmentisten*, and a further portion by D. W. Klose in *Niedner's Zeitschrift für historische Theologie*, 1850-52. Two of the five books of the first part and the whole of the second part, as well as appendices on the canon, remain unprinted. But D. F. Strauss has given an exhaustive analysis of the whole work in his book on Reimarus.

The standpoint of the *Apologie* is that of pure naturalistic deism. Miracles and mysteries are denied, and natural religion is put forward as the absolute contradiction revealed. The essential truths of the former are the existence of a wise and good Creator and the immortality of the soul. These truths are discoverable by reason, and are such as can constitute the basis of a universal religion. A revealed religion could never obtain universality, as it could never be intelligible and credible to all men. Even supposing its possibility, the Bible does not present such a revelation. It abounds in error as to matters of fact, contradicts human experience, reason and morals, and is one tissue of folly, deceit, enthusiasm, selfishness and crime. Moreover, it is not a doctrinal compendium, or catechism, which a revelation would have to be. What the Old Testament says of the worship of God is little, and that little worthless, while its writers are unacquainted with the second fundamental truth of religion, the immortality of the soul. The design of the writers of the New Testament, as well as that of Jesus, was not to teach true rational religion, but to serve their own selfish ambitions, in promoting which they exhibit an amazing combination of conscious fraud and enthusiasm. It is important, however, to remember that Reimarus attacked atheism with equal effect and sincerity, and that he was a man of high moral character, respected and esteemed by his contemporaries.

Modern estimates of Reimarus may be found in the works of B. Pfleiderer, O. Pfleiderer and H. Hoffding. Pfleiderer states the position of Reimarus as follows: "God is the Creator of the world, and His wisdom and goodness are conspicuous in it. Immortality is founded upon the essential nature of man and upon the purpose of God in creation. Religion is conducive to our happiness and alone brings satisfaction. Miracles are at variance with the divine purpose; without miracles there could be no revelation" (Pfleiderer, *History of Christian Philosophy of Religion since Kant*, Eng. trans., pp. 550-57, which contains an exposition of the *Abhandlungen und Schutzschrift*). Pfleiderer says the errors of Reimarus were that he ignored historical and literary criticism, sources, date, origin, &c., of documents, and the narratives were said to be either purely divine or purely human. He had no conception of an immanent reason (*Philosophy of Religion*, Eng. trans., vol. i. p. 102). H. Hoffding also has a brief section on the *Schutzschrift*, stating its main position as follows: "Natural religion suffices; a revelation is therefore superfluous. Moreover, such a thing is both physically and morally impossible. God cannot interrupt His own work by miracles; nor can He favour some men above others by relations which are not granted to all, and with which it is not even possible for all to become acquainted. But of all doctrines that of eternal punishment is most contrary, Reimarus thinks, to true ideas of God, and it was this point which first caused him to stumble" (*History of Modern Philosophy*, Eng. trans., 1909, vol. ii. pp. 120-1).

See the "Fragments" as published by Lessing, reprinted in vol. xv. of *Lessing's Werke*, Hempel's edition; D. F. Strauss, *H. S. Reimarus und seine Schutzschrift für die vernünftigen Verehrer Gottes* (1862, 2nd ed. 1877); Charles Voysey, *Fragments from Reimarus* (London, 1879) (a translation of the life of Reimarus by Strauss, with the second part of the seventh fragment, on the "Object of Jesus and his Disciples"); the *Lives of Lessing* by Danzel and G. E. Guhrauer, Sime, and Zimmern; Kuno Fischer, *Geschichte der neuen Philosophie* (vol. ii. pp. 759-72, 2nd ed. 1867); Zeller, *Geschichte der deutschen Philosophie* (2nd ed., 1875, pp. 243-46).

REIMS (REIMES), a city of north-eastern France, chief town of an arrondissement of the department of Marne, 98 m. E.N.E. of Paris, on the Eastern railway. Pop. (1906) 102,800. Reims is situated in a plain on the right bank of the Vesle, a tributary of the Aisne, and on the canal which connects the Aisne with the Marne. South and west rise the "montagne de Reims" and vine-clad hills. Reims is limited S.W. by the Vesle and the canal, N.W. by promenades which separate it from the railway and in other directions by boulevards lined with fine residences. Beyond extend large suburbs, the chief of which are Cérés to the N.E., Coutures to the E., Laon to the N. and Vesle to the W. Of its squares the principal are the Place

Royale, with a statue of Louis XV., and the place du Parvis, with an equestrian statue of Joan of Arc. The rue de Vesle, the chief street, continued under other names, traverses the town from S.W. to N.W., passing through the Place Royale.

The oldest monument in Reims is the Mars Gate (so called from a temple to Mars in the neighbourhood), a triumphal arch 108 ft. in length by 43 in height, consisting of three archways flanked by columns. It is popularly supposed to have been erected by the Remi in honour of Augustus when Agrippa made the great roads terminating at the town, but probably belongs to the 3rd or 4th century. In its vicinity a curious mosaic, measuring 36 ft. by 26, with thirty-five medallions representing animals and gladiators, was discovered in 1860. To these remains must be added a Gallo-Roman sarcophagus, said to be that of the consul Jovinus (see below) and preserved in the archaeological museum in the cloister of the abbey of St Remi. The cathedral of Notre-Dame, where the kings of France used to be crowned, replaced an older church (burned in 1211) built on the site of the basilica where Clovis was baptized by St Remigius. The cathedral, with the exception of the west front, was completed by the end of the 13th century. That portion was erected in the 11th century after 11th-century designs—the nave having in the meantime been lengthened to afford room for the crowds that attended the coronations. In 1481 fire destroyed the roof and the spires. In 1875 the National Assembly voted £80,000 for repairs of the façade and balustrades. This façade is the finest portion of the building, and one of the most perfect masterpieces of the middle ages. The three portals are laden with statues and statuettes. The central portal, dedicated to the Virgin, is surmounted by a rose-window framed in an arch itself decorated with statuary. The "gallery of the kings" above has the baptism of Clovis in the centre and statues of his successors. The towers, 267 ft. high, were originally designed to rise 304 ft.; that on the south contains two great bells, one of which, named "Charlotte" by Cardinal de Lorraine in 1570, weighs more than 11 tons. The façades of the transepts are also decorated with sculptures—that on the north with statues of the principal bishops of Reims, a representation of the Last Judgment and a figure of Christ (*le Beau Dieu*) while that on the south side has a beautiful rose-window with the prophets and apostles. Of the four towers which flanked the transepts nothing remains above the height of the roof since the fire of 1481. Above the choir rises an elegant bell-tower in timber and lead, 55 ft. high, reconstructed in the 15th century. The interior of the cathedral is 455 ft. long, 98 ft. wide in the nave, and 125 ft. high in the centre, and comprises a nave with aisles, transepts with aisles, a choir with double aisles, and an apse with deambulatory and radiating chapels. It has a profusion of statues similar to those of the outside, and stained glass of the 13th century. The rose-window over the main portal and the gallery beneath are of rare magnificence. The cathedral possesses fine tapestries. Of these the most important series is that presented by Robert de Lenoncourt, archbishop under Francis I., representing the life of the Virgin. The north transept contains a fine organ in a Flamboyant Gothic case. The choir clock is ornamented with curious mechanical figures. Several paintings, by Tintoretto, Nicolas Poussin, and others, and the carved woodwork and the railings of the choir, also deserve mention. The treasury contains the Sainte Ampoule, or holy flask, the successor of the ancient one broken at the Revolution (see below), a fragment of which it contains.

The archiepiscopal palace, built between 1498 and 1509, and in part rebuilt in 1675, was occupied by the kings on the occasion of their coronation. The saloon (*salle du Tau*), where the royal banquet was held, has an immense stone chimney of the 15th century, medallions of the archbishops of Reims, and portraits of fourteen kings crowned in the city. Among the other rooms of the royal suite, all of which are of great beauty and richness, is that now used for the meetings of the Reims Academy; the building also contains a library. The chapel of the archiepiscopal palace consists of two storeys, of which the upper still serves as a place of worship. Both the chapel and the *salle du Tau* are decorated with tapestries of the 17th century, known as the *Perpersack* tapestries, after the Flemish weaver who executed them.

After the cathedral, which it almost equals in size, the most celebrated church is St Remi, once attached to an important abbey, the buildings of which are used as a hospital. St Remi dates from the 11th, 12th, 13th and 15th centuries. The nave, the transepts, Romanesque in style, date mainly from the earliest, the façade of the south transept from the latest, of those periods, the choir and apse chapels from the 12th and 13th centuries. The valuable monuments with which the church was at one time filled were pillaged during the Revolution, and even the tomb of the saint is a modern work; but there remain the 12th-century glass windows of the apse and tapestries representing the history of St Remigius, given by Robert de Lenoncourt. The churches of St Jacques, St Maurice (partly rebuilt in 1867), St André, and St Thomas (erected from 1847 to 1853, under the patronage of Cardinal Gousset, now buried within its walls), are all of minor interest. Of the fine church of St Nicaise only insignificant remains are to be seen.

The town hall, erected in the 17th and enlarged in the 19th

century, has a pediment with an equestrian statue of Louis XIII. and a tall and elegant campanile. It contains a picture gallery, ethnographical, archaeological and other collections, and the public library. There are many old houses, the House of the Musicians (13th century) being so called from the seated figures of musicians which decorate the front.

In 1874 the construction of a chain of detached forts was begun in the vicinity, Reims being selected as one of the chief defences of the northern approaches of Paris. The ridge of St Thierry is crowned with a fort of the same name, which with the neighbouring work of Chenay closes the west side of the place. To the north the hill of Brimont has three works guarding the Laon railway and the Aisne canal. Farther east, on the old Roman road, lies the fort de Fresnes. Due east the hills of Arnavy are crowned with five large and important works which cover the approaches from the upper Aisne. Forts Pompelle and Montbré close the south-east side, and the Falaise hills on the Paris side are open and unguarded. The perimeter of the defences is not quite 22 m., and the forts are a mean distance of 6 m. from the centre of the city.

Reims is the seat of an archbishop, a court of assize and a sub-prefect. It is an important centre for the combing, carding and spinning of wool and the weaving of flannel, merino, cloth and woollen goods of all kinds, these industries employing some 24,000 hands; dyeing and "dressing" are also carried on. It is the chief wool market in France, and has a "conditioning house" which determines the loss of weight resulting from the drying of the wool. The manufacture of and trade in champagne is also very important. The wine is stored in large cellars tunnelled in the chalk. Other manufactures are machinery, chemicals, safes, capsules, bottles, casks, candles, soap and paper. The town is well known for its cakes and biscuits.

History.—Before the Roman conquest Reims, as *Durocororum*, was capital of the Remi, from whose name that of the town was subsequently derived. The Remi made voluntary submission to the Romans, and by their fidelity throughout the various Gallic insurrections secured the special favour of their conquerors. Christianity was established in the town by the middle of the 3rd century, at which period the bishopric was founded. The consul Jovinus, an influential supporter of the new faith, repulsed the barbarians who invaded Champagne in 336; but the Vandals captured the town in 406 and slew St Nicasus, and Attila afterwards put it to fire and sword. Clovis, after his victory at Soissons (486), was baptized at Reims in 496 by St Remigius. Later kings desired to be consecrated at Reims with the oil of the sacred phial which was believed to have been brought from heaven by a dove for the baptism of Clovis and was preserved in the abbey of St Remi. Meetings of Pope Stephen III. with Pippin the Short, and of Leo III. with Charlemagne, took place at Reims; and here Louis the Debonnaire was crowned by Stephen IV. Louis IV. gave the town and countship of Reims to the archbishop Artaldus in 940. Louis VII. gave the title of duke and peer to William of Champagne, archbishop from 1176 to 1202, and the archbishops of Reims took precedence of the other ecclesiastical peers of the realm. In the 10th century Reims had become a centre of intellectual culture, Archbishop Adalberon, seconded by the monk Gerbert (afterwards Pope Sylvester II.), having founded schools where the "liberal arts" were taught. Adalberon was also one of the prime authors of the revolution which put the Capet house in the place of the Carolingians. The most important prerogative of the archbishops was the consecration of the kings of France—a privilege which was exercised, except in a few cases, from the time of Philip Augustus to that of Charles X. Louis VII. granted the town a communal charter in 1139. The treaty of Troyes (1420) ceded it to the English, who had made a futile attempt to take it by siege in 1360; but they were expelled on the approach of Joan of Arc, who in 1429 caused Charles VII. to be consecrated in the cathedral. A revolt at Reims, caused by the salt tax in 1461, was cruelly repressed by Louis XI. The town sided with the League (1585), but submitted to Henry IV. after the battle of

Ivry. In the foreign invasions of 1814 it was captured and recaptured; in 1870-71 it was made by the Germans the seat of a governor-general and impoverished by heavy requisitions.

See G. Marlot, *Histoire de la ville, cité et université de Reims*, 4 vols. (Reims, 1843-46); J. Justinus (Baron I. Taylor), *La Ville de Reims* (Paris, 1854).

REIN, a guiding or controlling leather strap or thong, attached to the bit of a ridden or driven horse (see SADDLERY). The word is taken from the O. Fr. *rene*, modern *rêne*, and is usually traced to a supposed Late Latin substantive *retina* formed from *retinere*, to hold back, restrain, cf. classical Latin *retinaculum*, halter. The word, usually in the plural, has been often used figuratively, as a type of that which guides, restrains or controls, e.g. in such phrases as the "reins of government," &c. The "reins," i.e. the kidneys (Lat. *renes*, cf. Gr. *φῶν*, the midriff), or the place where the kidneys are situated, hence the loins, also, figuratively, the seat of the emotions or affections, must be distinguished.

REINACH, JOSEPH (1856-), French author and politician, was born in Paris on the 30th of September 1856. After leaving the Lycée Condorcet he studied for the bar, being called in 1887. He attracted the attention of Gambetta by articles on Balkan politics published in the *Revue bleue*, and joined the staff of the *République française*. In Gambetta's grand ministère M. Reinach was his secretary, and drew up the case for a partial revision of the constitution and for the electoral method known as the *scrutin de liste*. In the *République française* he waged a steady war against General Boulanger which brought him three duels, one with Edmond-Magnier and two with Paul Déroulède. Between 1889 and 1898 he sat for the Chamber of Deputies for Digne. As member of the army commission, reporter of the budgets of the ministries of the interior and of agriculture he brought forward bills for the better treatment of the insane, for the establishment of a colonial ministry, for the taxation of alcohol, and for the reparation of judicial errors. He advocated complete freedom of the theatre and the press, the abolition of public executions, and denounced political corruption of all kinds. He was indirectly implicated in the Panama scandals through his father-in-law, Baron de Reinach, though he made restitution as soon as he learned that he was benefiting by fraud. But he is best known as the champion of Captain Dreyfus. At the time of the original trial he attempted to secure a public hearing of the case, and in 1897 he allied himself with Scheurer-Kestner to demand its revision. He denounced in the *Sicèle* the Henry forgery, and Esterhazy's complicity. His articles in the *Sicèle* aroused the fury of the anti-Dreyfusard party, especially as he was himself a Jew and therefore open to the charge of having undertaken to defend the innocence of Dreyfus on racial grounds. He lost his seat in the Chamber of Deputies, and, having refused to fight Henri Rochefort, eventually brought an action for libel against him. Finally, the "affaire" being terminated and Dreyfus pardoned, he undertook to write the history of the case, the first four volumes of which appeared in 1901. This was completed in 1905. In 1906 M. Reinach was re-elected for Digne. In that year he became member of the commission of the national archives, and next year of the council on prisons. Reinach was a voluminous writer on political subjects. On Gambetta he published three volumes in 1884, and he also edited his speeches. For the criticisms of the anti-Dreyfusard press see Henri Dutrait-Croyon, *Joseph Reinach, historien* (Paris, 1905), a violent criticism in detail of Reinach's history of the "affaire."

His brother, the well-known savant, SALOMON REINACH (1858-), born at St Germain-en-Laye on the 29th of August 1858, was educated at the Ecole normale supérieure, and joined the French school at Athens in 1879. He made valuable archaeological discoveries at Myrina near Smyrna in 1880-82, at Cyne in 1881, at Thasos, Imbros and Lesbos (1882), at Carthage and Meninx (1883-84), at Odessa (1893) and elsewhere. He received honours from the chief learned societies

of Europe, and in 1886 received an appointment at the National Museum of Antiquities at St Germain; in 1893 he became assistant keeper, and in 1902 keeper of the national museums. In 1903 he became joint editor of the *Revue archéologique*, and in the same year officer of the Legion of Honour. The lectures he delivered on art at the Ecole du Louvre in 1902-3 were published by him under the title of *Apollo*. This book has been translated into most European languages, and is one of the most compact handbooks of the subject.

His first published work was a translation of Schopenhauer's *Essay on Free Will* (1877), which passed through many editions. This was followed by many works and articles in the learned reviews of which a list—up to 1903—is available in *Bibliographie de S. R.* (Angers, 1903). His *Manuel de philologie classique* (1880-1884) was crowned by the French association for the study of Greek; his *Grammaire latine* (1886) received a prize from the Society of Secondary Education; *La Nécropole de Myrina* (1887), written with E. Potier, and *Antiquités nationales* were crowned by the Academy of Inscriptions. He compiled an important *Répertoire de la statuaire grecque et romaine* (3 vols., 1897-98); also *Répertoire de peintures du moyen âge et de la Renaissance 1280-1580* (1905, &c.); *Répertoire des usages peints grecs et étrusques* (1900). In 1905 he began his *Cultes, mythes et religions*; and in 1909 he published a general sketch of the history of religions under the title of *Orpheus*. He also translated from the English H. C. Lea's *History of the Inquisition*.

A younger brother, THEODORE REINACH (1860-), also had a brilliant career as a scholar. He pleaded at the Parisian bar in 1881-86, but eventually gave himself up to the study of numismatics. He wrote important works on the ancient kingdoms of Asia Minor—*Trois royaumes de l'Asie Mineure, Cappadoce, Bithynie, Pont* (1888), *Mithridate Eupator* (1890); also a critical edition and translation with H. Weil of Plutarch's *Treatise on Music*; and an *Histoire des Israélites depuis la ruine de leur indépendance nationale jusqu'à nos jours* (2nd ed., 1901). From 1888 to 1897 he edited the *Revue des études grecques*.

REINAUD, JOSEPH TOUSSAINT (1795-1867), French orientalist, was born on the 4th of December 1795 at Lambec, Bouches du Rhône. He came to Paris in 1815, and became a pupil of Silvestre de Sacy. In 1818-19 he was at Rome as an attaché to the French minister, and studied under the Maronites of the Propaganda, but gave special attention to Mahomedan coins. In 1824 he entered the department of oriental MSS. in the Royal Library at Paris, and in 1838, on the death of De Sacy, he succeeded to his chair in the school of living oriental languages. In 1847 he became president of the Société Asiatique, and in 1858 conservator of oriental MSS. in the Imperial Library. His first important work was his classical description of the collections of the duc de Blacas (1828). To history he contributed an essay on the Arab invasions of France, Savoy, Piedmont and Switzerland (1836), and various collections for the period of the crusades; he edited (1840) and in part translated (1848) the geography of Abulfeda; to him too is due a useful edition of the very curious records of early Arab intercourse with China of which Eusebe Renaudot had given but an imperfect translation (*Relation des voyages*, &c., 1845), and various other essays illustrating the ancient and medieval geography of the East. Reinaud died in Paris on the 14th of May 1867.

REINDEER, in its strict sense the title of a European deer distinguished from all other members of the family Cervidae (see DEER), save those of the same genus, by the presence of antlers in both sexes; but, in the wider sense, including Asiatic and North American deer of the same general type, the latter of which are locally designated caribou. Reindeer, or caribou, constitute the genus *Rangifer*, and are large clumsily built deer, inhabiting the sub-Arctic and Arctic regions of both hemispheres. As regards their distinctive features, the antlers are of a complex type and situated close to the occipital ridge of the skull, and thus far away from the sockets of the eyes, with the brow-tines in adult males palmated, laterally compressed, deflected towards the middle of the face, and often unsymmetrically developed. Above the brow-tine is developed a second palmated tine,

which appears to represent the bez-tine of the red-deer; there is no trez-tine, but some distance above the bez the beam is suddenly bent forward to form an "elbow," on the posterior side of which is usually a short back-tine; above the back-tine the beam is continued for some distance to terminate in a large expansion or palmation. The antlers of females are simple and generally smaller. The muzzle is entirely hairy; the ears and tail are short; and the throat is maned. The coat is unspotted at all ages, with a whitish area in the region of the tail. The main hoofs are short and rounded and the lateral hoofs very large. There is a tarsal, but no metatarsal gland and tuft. In the skull the gland-pit is shallow, and the vacuity of moderate size; the nasal bones are well developed, and much expanded at the upper end. Upper canines are wanting; the cheek-teeth are small and low-crowned, with the third lobe of the last molar in the lower jaw minute. The lateral metacarpal bones are represented only by their lower extremities; the importance of this feature being noticed in the article DEER.

In spite of the existence of a number of more or less well-marked geographical forms, and from all parts of the northern hemisphere presenting such a marked similarity that it seems preferable to regard them as all belonging to a single widespread species, of which most of the characters will be the same as those of the genus. American naturalists, however, generally regard these as distinct species. The coat is remarkable for its density and compactness; the general colour of the head and upper parts being clove-brown, with more or less white or whitish grey on the under parts and inner surfaces of the limbs, while there is also some white above the hoofs and on the muzzle, and there may be whitish rings round the eyes; there is a whitish area in the region of the tail, which includes the sides but not the upper surface of the latter; and the tarsal tuft is generally white. The antlers are smooth, and brownish white in colour, but the hoofs jet black. Albino varieties occasionally occur in the wild state. A height of 4 ft. 10 in. at the shoulder has been recorded in the case of one race.

The wild Scandinavian reindeer (*Rangifer tarandus*) may be regarded as the typical form of the species. It is a smaller animal than the American woodland race, with antlers approximating to those of the barren-ground race, but less elongated, and with a distinct back-tine in the male, the brow-tines moderately palmated and frequently serrated, the bez-tine and the trez-tine not extensively expanded. Female antlers are generally much smaller than those of males, although occasionally as large, but with much fewer points. The antlers make their appearance at an unusually early age.

Mr Madison Grant considers that American reindeer, or caribou, may be grouped under two types, one represented by the barren-ground caribou *R. tarandus arcticus*, which is a small animal with immense antlers characterized by the length of the beam, and the consequent wide separation of the terminal palmation from the brow-tine; and the other by the woodland-caribou (*R. t. caribou*), which is a larger animal with shorter and more massive antlers, in which the great terminal expansions are in approximation to the brow-tine owing to the shortness of the beam. Up to 1902 seven other American races had been described, four of which are grouped by Grant with the first and three with the second type. Some of these forms are, however, more or less intermediate between the two main types, as is a pair of antlers from Novaia Zemlia described by the present writer as *R. t. pearsoni*. The Scandinavian reindeer is identified by Mr Grant with the barren-ground type.

Reindeer are domesticated by the Lapps and other nationalities of northern Europe and Asia, to whom these animals are all-important. Domesticated reindeer have also been introduced into Alaska.

See Madison Grant, "The Caribou," 7th Annual Report, New York Zoological Society (1902); J. G. Millais, *Newfoundland and its Untrodden Ways* (1908). (R. L.')

REINECKE, CARL HEINRICH CARSTEN (1824-1910), German composer and pianist, was born at Altona on the 23rd of June 1824; his father, Peter Reinecke (who was also his teacher), being an accomplished musician. At the age of eleven he made his first appearance as a pianist, and when scarcely eighteen he went on a successful tour through Denmark and Sweden. After a stay in Leipzig, where he studied under Mendelssohn and under Schumann, Reinecke went on tour with Königsbaw and Wasielewski, Schumann's biographer, in North Germany and Denmark. From 1846 to 1848 Reinecke was court pianist to Christian VIII. of Denmark. After resigning this post he went first to Paris, and next to Cologne, as professor in the Conservatorium. From 1854 to 1859 he was music director at Barmen, in the latter year filling this post at Breslau University;

in 1860 he became conductor of the famous Leipzig Gewandhaus, a post which (together with that of professor at the Conservatorium) he held with honour and distinction for thirty-five years. He finally retired into private life in 1902 and died in March 1910. During this time Reinecke continually made concert tours to England and elsewhere. His pianoforte playing belonged to a school now almost extinct. Grace and neatness were its characteristics, and at one time Reinecke was probably unrivalled as a Mozart player and an accompanist. His grand opera *König Manfred*, and the comic opera *Auf hohen Befehl*, were at one time frequently played in Germany; and his cantata *Hakon Jarl* is melodiously beautiful, as are many of his songs; while his *Friedensfeier* overture was once quite hackneyed. By far his most valuable works are those written for educational purposes. His sonatas, his "Kindergarten" and much that he has ably edited will keep his name alive.

REINHART, CHARLES STANLEY (1844-1896), American painter and illustrator, was born at Pittsburg, Pennsylvania, and after having been employed in railway work and at a steel factory, studied art in Paris and at the Munich Academy under Straehuber and Otto. He afterwards settled in New York, but spent the years 1882-1886 in Paris. He was a regular exhibitor at the National Academy in New York, and contributed illustrations in black and white and in colours to the leading American periodicals. He died in 1896. Among his best-known pictures are: "Reconnoitring," "Caught Napping," "September Morning," "Mussel Fisherman," "At the Ferry," "Normandy Coast," "Gathering Wood," "The Old Life Boat," "Sunday," and "English Garden"; but it is as an illustrator that he is best known.

REINHART, JOACHIM CHRISTIAN (1761-1847), German painter and etcher, was born at Hof in Bavaria in 1761, and studied under Oeser at Leipzig and under Klingel at Dresden. In 1789 he went to Rome, where he became a follower of the classicist German painters Carstens and Koch. He devoted himself more particularly to landscape painting and to aquatint engraving. Examples of his landscapes are to be found at most of the important German galleries, notably at Frankfurt, Munich, Leipzig and Gotha. In Rome he executed a series of landscape frescoes for the Villa Massimi. He died in Rome in 1847.

REINHOLD, KARL LEONHARD (1758-1823), German philosopher, was born at Vienna. At the age of fourteen he entered the Jesuit college of St Anna, on the dissolution of which (1774) he joined a similar college of the order of St Barnabas. Finding himself out of sympathy with monastic life, he fled in 1783 to North Germany, and settled in Weimar, where he became Wieland's collaborator on the *German Mercury*, and eventually his son-in-law. In the *German Mercury* he published, in the years 1786-87, his *Briefe über die Kantische Philosophie*, which were most important in making Kant known to a wider circle of readers. As a result of the *Letters*, Reinhold received a call to the university of Jena, where he taught from 1787 to 1794. In 1789 he published his chief work, the *Versuch einer neuen Theorie des menschlichen Vorstellungsvermögens*, in which he attempted to simplify the Kantian theory and make it more of a unity. In 1794 he accepted a call to Kiel, where he taught till his death in 1823, but his independent activity was at an end. In later life he was powerfully influenced by Fichte, and subsequently, on grounds of religious feeling, by Jacobi and Bardili. His historical importance belongs entirely to his earlier activity. The development of the Kantian standpoint contained in the "New Theory of Human Understanding" (1789), and in the *Fundament des philosophischen Wissens* (1791), was called by its author *Elementarphilosophie*.

"Reinhold lays greater emphasis than Kant upon the unity and activity of consciousness. The principle of consciousness tells us that every idea is related both to an object and a subject, and is partly to be distinguished, partly united to both. Since form cannot produce matter nor subject object, we are forced to assume a thing-in-itself. But this is a notion which is self-contradictory if consciousness be essentially a relating activity. There is there-

for something which must be thought and yet cannot be thought" (Höfling, *History of Modern Philosophy*, Eng. trans., vol. ii.).

See R. Keil, *Wieland und Reinhold* (2nd ed., Leipzig, 1890); J. E. Erdmann, *Grundriss der Geschichte der Philosophie* (Berlin, 1866); histories of philosophy by R. Folckenberg and W. Windelband.

REINKENS, JOSEPH HUBERT (1821-1896), German Old Catholic bishop, was born at Burtscheid, near Aix-la-Chapelle, on the 1st of March 1821, his father being a gardener. In 1836, on the death of his mother, he took to manual work in order to support his numerous brothers and sisters, but in 1840 he was able to go to the gymnasium at Aix, and he afterwards studied theology at the universities of Bonn and Munich. He was ordained priest in 1848, and in 1849 graduated as doctor in theology. He was soon appointed professor of ecclesiastical history at Breslau, and in 1865 he was made rector of the university. During this period he wrote, among other treatises, monographs on Clement of Alexandria, Hilary of Poitiers and Martin of Tours. In consequence of an essay on art, especially in tragedy, after Aristotle, he was made doctor in philosophy in the university of Leipzig. When, in 1870, the question of papal infallibility was raised, Reinkens attached himself to the party opposed to the proclamation of the dogma. He wrote several pamphlets on church tradition relative to infallibility and on the procedure of the Council. When the dogma of infallibility was proclaimed, Reinkens joined the band of influential theologians, headed by Döllinger, who resolved to organize resistance to the decree. He was one of those who signed the Declaration of Nuremberg in 1871, and at the Bonn conferences with Orientals and Anglicans in 1874 and 1875 he was conspicuous. The Old Catholics having decided to separate themselves from the Church of Rome, Reinkens was chosen their bishop in Germany at an enthusiastic meeting at Cologne in 1873 (see OLD CATHOLICS). On the 11th of August of that year he was consecrated by Dr Heykamp, bishop of Deventer. Reinkens devoted himself zealously to his office, and it was due to his efforts that the Old Catholic movement crystallized into an organized church, with a definite status in the various German states. He wrote a number of theological works after his consecration, but none of them so important as his treatise on Cyprian and the Unity of the Church (1873). The chief act of his episcopal career was his consecration in 1876 of Dr Edward Herzog to preside as bishop over the Old Catholic Church in Switzerland. In 1881 Reinkens visited England, and received Holy Communion more than once with bishops, clergy and laity of the Church of England, and in 1894 he defended the validity of Anglican orders against his co-religionists, the Old Catholics of Holland. He died at Bonn on the 4th of January 1896.

See *Joseph Hubert Reinkens*, by his nephew, J. M. Reinkens (Gotha, 1906).

REISKE, JOHANN JACOB (1716-1774), German scholar and physician, was born on the 25th of December 1716 at Zörbig in Electoral Saxony. From the Waisenhaus at Halle he passed in 1733 to the university of Leipzig, and there spent five years. He tried to find his own way in Greek literature, to which German schools then gave little attention; but, as he had not mastered the grammar, he soon found this a sore task and took up Arabic. He was very poor, having almost nothing beyond his allowance, which for the five years was only two hundred thalers. But everything of which he could cheat his appetite was spent on Arabic books, and when he had read all that was then printed he thirsted for manuscripts, and in March 1738 started on foot for Hamburg, joyous though totally unprovided, on his way to Leiden and the treasures of the Warnerianum. At Hamburg he got some money and letters of recommendation from the Hebraist Wolf, and took ship to Amsterdam. Here d'Orville, to whom he had an introduction, proposed to retain him as his amanuensis at a salary of six hundred guilders. Reiske refused, though he thought the offer very generous; he did not want money, he wanted manuscripts. When he reached Leiden (June 6, 1738) he found that the lectures were over for the term and that the MSS.

were not open to him. But d'Orville and A. Schultens helped him to private teaching and reading for the press, by which he was able to live. He heard the lectures of A. Schultens, and practised himself in Arabic with his son J. J. Schultens. Through Schultens too he got at Arabic MSS., and was even allowed *sub rosa* to take them home with him. Ultimately he seems to have got free access to the collection, which he re-catalogued—the work of almost a whole summer, for which the curators rewarded him with nine guilders.

Reiske's first years in Leiden were not unhappy, till he got into serious trouble by introducing emendations of his own into the second edition of Burmann's *Petronius*, which he had to see through the press. His patrons withdrew from him, and his chance of perhaps becoming professor was gone; d'Orville indeed soon came round, for he could not do without Reiske, who did work of which his patron, after dressing it up in his own style, took the credit. But A. Schultens was never the same as before to him; Reiske indeed was too independent, and hurt him by his open criticisms of his master's way of making Arabic mainly a handmaid of Hebrew. Reiske, however, himself admits that Schultens always behaved honourably to him. In 1742 by Schultens's advice Reiske took up medicine as a study by which he might hope to live if he could not do so by philology. In 1746 he graduated as M.D., the fees being remitted at Schultens's intercession. It was Schultens too who conquered the difficulties opposed to his graduation at the last moment by the faculty of theology on the ground that some of his theses had a materialistic ring. On the 10th of June 1746 he left Holland and settled in Leipzig, where he hoped to get medical practice.

But his shy, proud nature was not fitted to gain patients, and the Leipzig doctors would not recommend one who was not a Leipzig graduate. In 1747 an Arabic dedication to the electoral prince of Saxony got him the title of professor, but neither the faculty of arts nor that of medicine was willing to admit him among them, and he never delivered a course of lectures. He had still to go on doing literary task-work, but his labour was much worse paid in Leipzig than in Leiden. Still he could have lived and sent his old mother, as his custom was, a yearly present of a piece of leather to be sold in retail if he had been a better manager. But, careless for the morrow, he was always printing at his own cost great books which found no buyers. His academical colleagues were hostile; and Ernesti, under a show of friendship, secretly hindered his promotion. His unsparing reviews made bad blood with the pillars of the university.

At length in 1758 the magistrates of Leipzig rescued him from his misery by giving him the rectorate of St Nicolai, and, though he still made no way with the leading men of the university and suffered from the hostility of men like Ruhnen and J. D. Michaelis, he was compensated for this by the esteem of Frederick the Great, of Lessing, Karsten Niebuhr, and many foreign scholars. The last decade of his life was made cheerful by his marriage with Ernestine Müller, who shared all his interests and learned Greek to help him with collations. In proof of his gratitude her portrait stands beside his in the first volume of the *Oratores Graeci*. Reiske died on the 14th of August 1774, and his MS. remains passed, through Lessing's mediation, to the Danish minister Suhm, and are now in the Copenhagen library.

Reiske certainly surpassed all his predecessors in the range and quality of his knowledge of Arabic literature. It was the history, the *realia* of the literature, that always interested him; he did not care for Arabic poetry as such, and the then much praised Hariri seemed to him a grammatical pedant. He read the poets less for their verses than for such scholia as supplied historical notices. Thus for example the scholia on Jarir furnished him with a remarkable notice of the prevalence of Buddhist doctrine and asceticism in Arab lands under the Omayyads. In the *Adnotationes historicae* to his *Abulfeida (Abulf. Annales Moslemici)*, 5 vols., Copenhagen, 1789-91, he collected a veritable treasure of sound and original research; he knew the Byzantine writers as thoroughly as the Arabic authors, and was alike at home in modern works of travel in all languages and in ancient and medieval authorities. He was interested too in

nomatics, and his letters on Arabic coinage (in Eichhorn's *Reperitorium*, vols. ix-xi) form, according to De Sacy, the basis of that branch of study. To comprehensive knowledge and very wide reading he added a sound historical judgment. He was not, like Schultens, deceived by the pretended antiquity of the Yemenite Kasidas.¹ Errors no doubt he made, as in the attempt to ascertain the date of the breach of the dam of Marib.

Though Abulfeda as a late epitomator did not afford a starting-point for methodical study of the sources, Reiske's edition with his version and notes certainly laid the foundation for research in Arabic history. The foundation of Arabic philology, however, was laid not by him but by L. Salyer. To philologic knowledge, which is great, he added it only to understand his authors; he had no feeling for form, for language as language, or for metre.

In Leipzig Reiske worked mainly at Greek, though he continued to draw on his Arabic stores accumulated in Leiden. Yet his merit as an Arabist was sooner recognized than the value of his Greek work. Reiske the Greek scholar has been rightly valued only in recent years, and it is now recognized that he was the first German since Sylburg who had a living knowledge of the Greek tongue. His reputation does not rest on his numerous editions, often hasty or even made to booksellers' orders, but in his remarks, especially his *himeres*. He himself denigrates the *Animadversiones in Scriptores Græcos as Ros ingenui sui*; and in truth these thin booklets outweigh his big editions. Closely following the author's thought he removes obstacles whenever he meets them, but he is so steeped in the language and thinks so truly like a Greek that the difficulties he feels often seem to us to lie in mere points of style. His criticism is empirical and unmethodic, based on immense and careful reading, and applied only when he feels a difficulty; and he is most successful when he has a large mass of tolerably homogenous literature to lean on, whilst on isolated points he is often at a loss. His corrections are often hasty and false; but surprisingly large proportion of them have since received confirmation from MSS. And, though his merits as a Grecian lie mainly in his conjectures, his realism is felt in this sphere also; his German translations especially show more freedom and practical insight, more feeling for actual life, than is common with the scholars of that age.²

For a list of Reiske's writings see Meusel, *ii*, 192 seq. His chief Arabic works (all posthumous) have been mentioned above. In Greek letters his chief works are *Constantini Porphyrogeniti libri Ii de ceremoniis aulae Byzant.*, vols. i-ii. (Leipzig, 1751-66), vol. iii. (Bonn, 1829); *Himado ad Græcos auctores* (5 vols., Leipzig, 1751-66) (the rest lies unprinted at Copenhagen); *Oratorum Græcorum quæ supersunt* (8 vols., Leipzig, 1770-73); *App. crit. ad Demosthenem* (3 vols., ib., 1774-75); *Maximus Tyr.* (ib., 1774); *Plutarchus* (11 vols., ib., 1774-79); *Dionys Iulic.* (6 vols., ib., 1774-77); *Libanus* (4 vols., Altenburg, 1784-97). Various reviews in the *Acta eruditiorum* and *Zuerli. Nachrichten* are characteristic and worth reading. Compare *D. Johann Jacob Reiskens von ihm selbst aufgesetzte Lebensbeschreibung* (Leipzig, 1783). (J. We.)

RÉJANE, GABRIELLE [CHARLOTTE RÉJU] (1837-), French actress, was born in Paris, the daughter of an actor. She was a pupil of Regnier at the Conservatoire, and took the second prize for comedy in 1874. Her *début* was made the next year, during which she played attractively a number of light—especially *soubrette*—parts. Her first great success was in Henri Meilhac's *Ma camarade* (1883), and she soon became known as an emotional actress of rare gifts, notably in *Décoré*, *Germinie Lacerteux*, *Ma cousine*, *Amoureuse* and *Lysistrata*. In 1892 she married M. Porel, the director of the Vaudeville theatre, but the marriage was dissolved in 1905. Her performances in *Madame Sans Gêne* (1893) made her as well known in England and America as in Paris, and in later years she appeared in characteristic parts in both countries, being particularly successful in *Zaza* and *La Passerelle*. She opened the Théâtre Réjane in Paris in 1906. The essence of French vivacity and animated expression appeared to be concentrated in Madame Réjane's acting, and made her unrivalled in the parts which she had made her own.

RELAND, ADRIAN (1676-1718), Dutch Orientalist, was born at Ryp, studied at Utrecht and Leiden, and was professor of Oriental languages successively at Harderwijk (1699) and Utrecht (1701). His most important works were *Palaestina ex veteribus monumentis illustrata* (Utrecht, 1714), and *Antiquitates sacrae veterum Hebraeorum*. (See also Burman, *Traj. Erud.*, p. 296 seq.)

RELAPSING FEVER (*Febris recurrens*), the name given to a specific infectious disease occasionally appearing as an epidemic in communities suffering from scarcity or famine. It is characterized mainly by its sudden invasion, with violent febrile symptoms, which continue for about a week and end in a crisis, but are followed, after another week, by a return of the fever.

This disease has received many other names, the best known of which are famine fever, seven-day, bilious relapsing fever, and spirillum fever. As in the case of typhoid, relapsing fever was long believed to be simply a form of typhus. The distinction between them appears to have been first clearly established in 1826, in connexion with an epidemic in Ireland.

Relapsing fever is highly contagious. With respect to the nature of the contagion, certain important observations have been made (see also PARASITIC DISEASES). In 1873 Obermeier discovered in the blood of persons suffering from relapsing fever minute organisms in the form of spiral filaments of the genus *Spirrochaeta*, measuring in length $\frac{1}{100}$ inch and in breadth $\frac{1}{1000}$ inch, and possessed of rotatory or twisting movements. This organism received the name of *Spirillum obermeieri*. Fritz Schaudinn has brought forward evidence that it is an animal parasite. The most constantly recognized factor in the origin and spread of relapsing fever is destitution; but this cannot be regarded as more than a predisposing cause, since in many lands widespread and destructive famines have prevailed without any outbreak of this fever. Instances, too, have been recorded where epidemics were distinctly associated with overcrowding rather than with privation. Relapsing fever is most commonly met with in the young. One attack does not appear to protect from others, but rather, according to some authorities, engenders liability.

The incubation of the disease is about one week. The symptoms of the fever then show themselves with great abruptness and violence by a rigor, accompanied with pains in the limbs and severe headache. The febrile phenomena are very marked, and the temperature quickly rises to a high point (105° - 107° Fahr.), at which it continues with little variation, while the pulse is rapid (100-140), full and strong. There is intense thirst, a dry brown tongue, bilious vomiting, tenderness over the liver and spleen, and occasionally jaundice. Sometimes a peculiar bronzy appearance of the skin is noticed, but there is no characteristic rash as in typhus. There is much prostration of strength. After the continuance of these symptoms for a period of from five to seven days, the temperature suddenly falls to the normal point or below it, the pulse becomes correspondingly slow, and a profuse perspiration occurs, while the severe headache disappears and the appetite returns. Except for a sense of weakness, the patient feels well and may even return to work, but in some cases there remains a condition of great debility, accompanied with rheumatic pains in the limbs. This state of freedom from fever continues for about a week, when there occurs a well-marked relapse with scarcely less abruptness and severity than in the first attack, and the whole symptoms are of the same character, but they do not, as a rule, continue so long, and they terminate in a crisis in three or four days, after which convalescence proceeds satisfactorily. Second, third and even fourth relapses, however, may occur in exceptional cases.

The mortality in relapsing fever is comparatively small, about 5% being the average death-rate in epidemics (Murchison). The fatal cases occur mostly from the complications common to continued fevers. The treatment is essentially the same as that for typhus fever. Löwenthal and Gabritschewsky by using the serum of an immune horse succeeded in averting the relapse in 40% of cases.

RELATIVITY OF KNOWLEDGE, a philosophic term which was much used by the philosophers of the middle of the 19th century, and has since fallen largely into disuse. It deserves explanation, however, not only because it has occupied so large a space in the writings of some great British thinkers, but also because the main question for which it stands is still matter of eager debate. We get at the meaning of the term most easily by considering what it is that "relativity" is opposed to. "Relativity" of knowledge is opposed to absoluteness or positiveness of knowledge. Now there are two senses in which knowledge may claim to be absolute. The knower may say, "I know this absolutely," or he may say, "I know *this* absolutely." With the emphasis upon the "know" he asserts that his knowledge of the matter in question cannot be affected by anything whatever. "I know absolutely that two and two are four" makes an assertion about the knower's intellectual state: he is convinced that his certain knowledge of the result of adding two to two is independent of any other piece of knowledge. With

¹ *Animadvers. criticae in Hamzae hist. regni Joctanidarum*, in Eichhorn's *Mon. Asi. Hist.*, *Ar.*, 1775.

² For this estimate of Reiske as a Greek scholar the writer is indebted to Prof. U. v. Wilamowitz-Moellendorf.

the emphasis upon the object of knowledge, "I know *this*," we have the other sense of absoluteness of knowledge: it is an assertion that the knower knows the "this," whatever it may be, in its essence or as it truly is in itself. The phrase "relativity of knowledge" has therefore two meanings: (a) that no portion of knowledge is absolute, but is always affected by its relations to other portions of knowledge; (b) that what we know are not absolute things in themselves, but things conditioned in their quality by our channels of knowledge. Each of these two propositions must command assent as soon as uncritical ignorance gives place to philosophic reflection; but each may be exaggerated, indeed has currently been exaggerated, into falsity. The simplest experience—a single note struck upon the piano—would not be what it is to us but for its relation by contrast or comparison with other experiences. This is true; but we may easily exaggerate it into a falsehood by saying that a piece of experience is entirely constituted by its relation to other experiences. Such an extreme relativity, as advocated by T. H. Green in the first chapter of his *Prolegomena to Ethics*, involves the absurdity that our whole experience is a tissue of relations with no points of attachment on which the relations depend. The only motive for advocating it is the prejudice of absolute idealism which would deny that sensation has any part whatever in the constitution of experience. As soon as we recognize the part of sensation, we have no reason to deny the common-sense position that each piece of experience has its own quality, which is modified indefinitely by the relations in which it stands.

The second sense of relativity, that which asserts the impossibility of knowing things except as conditioned by our perceptive faculties, is more important philosophically and has had a more interesting history. To apprehend it is really the first great step in philosophical education. The unphilosophical person assumes that a tree as he sees it is identical with the tree as it is in itself and as it is for other perceptive minds. Reflection shows that our apprehension of the tree is conditioned by the sense-organs with which we have been endowed, and that the apprehension of a blind man, and still more the apprehension of a dog or horse, is quite different from ours. What the tree is in itself—that is, for a perfect intelligence—we cannot know, any more than a dog or horse can know what the tree is for a human intelligence. So far the relativist is on sure ground; but from this truth is developed the paradox that the tree has no objective existence at all and consists entirely of the conscious states of the perceiver. Observe the parallelism of the two paradoxical forms of relativity: one says that things are relations with nothing that is related; the other says that things are perceptive conditions with nothing objective to which the conditions apply. Both make the given nothing and the work of the mind everything.

To see the absurdity of the second paradox of relativity is easier than to refute it. If nothing exists but the conscious states of the perceiver, how does he come to think that there is an objective tree at all? Why does he regard his conscious states as produced by an object? And how does he come to imagine that there are other minds than his own? In short, this kind of relativity leads straight to what is generally known as "the abyss of solipsism." But, like all the great paradoxes of philosophy, it has its value in directing our attention to a vital, yet much neglected, element of experience. We cannot avoid solipsism (*q.v.*) so long as we neglect the element of force or power. If, as Hegel asserted, our experience is all knowledge, and if knowledge is indefinitely transformed by the conditions of knowing, then we are tempted to regard the object as superfluous, and to treat our innate conviction that knowledge has reference to objects as a delusion which philosophical reflection is destined to dispel. The remedy for the paradox is to recognize that the foundation for our belief in the existence of objects is the force which they exercise upon us and the resistance which they offer to our will. What the tree is in regard to its specific qualities depends on what faculties we have for perceiving it. But, whatever specific qualities it may have, it will still exist

as an object, so long as it comes into dynamic relations with our minds.

In the history of thought the relativity of knowledge as just described begins with Descartes, the founder of modern philosophy: the characteristic of modern philosophy is that it lays more stress upon the subjective than upon the objective side of experience. It is a mistake to refer it back to the Greeks. The maxim of Protagoras, for example, "Man is the measure of all things," has a different purpose; it was meant to point to the truth that man rather than nature is the primary object of human study: it is a doctrine of humanism rather than of relativism. To appreciate the relativistic doctrines we find in various thinkers we must take account of the use to which they were put. By Descartes the principle was used as an instrument of scepticism, the beneficent scepticism of pulling down medieval philosophy to make room for modern science; by Berkeley it was used to combat the materialists; by Hume in the cause of scepticism once more against the intellectual dogmatists; by Kant to prepare a justification for a noumenal sphere to be apprehended by faith; by J. S. Mill and Herbert Spencer to support their derivation of all our experience from sensation. It is in Mill's *Examination of Sir William Hamilton's Philosophy* that the classical statement of the Relativity of Knowledge is to be found. The second chapter of that book sets forth the various forms of the doctrine with admirable lucidity and precision, and gives many references to other writers.

For the sake of clearness it seems desirable to keep for the future the term "relativity of knowledge" to the first meaning explained above; for the second meaning it has been superseded in contemporary philosophizing by the terms "subjectivism," "subjective idealism," and, for its extreme form, "solipsism" (*q.v.*) (H. St.).

RELEASE (O.Fr. *reles*, variant of *relais*, from *relaisser*, to release, let go, Lat. *relaxare*), freedom or deliverance from trouble, pain or sorrow, the freeing or discharge from some obligation or debt, the action of letting go or releasing something fixed or set in position. In law, the term is applied to the discharge of some obligation, by which it is extinguished (see DEBT), and to the conveyance of an estate or interest in real or personal property to one who has already some estate or interest therein. For the special form of conveying known as "lease and release," see CONVEYANCING.

RELICS (Lat. *reliquiae*, the equivalent of the English "remains" in the sense of a dead body), the name given in the Catholic Church to, (1) the bodies of the saints, or portions of them, (2) such objects as the saints made use of during their lives, or as were used at their martyrdom. These objects are held by the Church in religious veneration, and by their means it hopes to obtain divine grace and miraculous benefits (*Conc. Trid.*, sess. 24).

These ideas had taken shape, in all essentials, during the early days of the Church, underwent further development in the middle ages, and were maintained by the Catholic Church in the face of the opposition of the Reformers, while all the Protestant Churches rejected them.

The origins of the veneration of relics lie in the anxiety for the preservation of the bodies of the martyrs. Nothing is more natural than that the pious solicitude felt by all men for the bodies of their loved ones should in the primitive Christian Churches have been turned most strongly towards the bodies of those who had met with death in confessing their faith. The account given by the church at Smyrna of the death of their bishop Polycarp (155) gives us an insight into these feelings. The church collected and buried the remains of the martyr, who had been burnt, in order duly to celebrate the anniversary of the martyrdom at the place of burial. The possession of the relics seemed to assure the continuation of the common life of the church with their bishop, of the living with the dead (*Mart. Polyc.* c. 17).

The custom of which we have here for the first time an account had become universal by the 3rd century. In all parts the Christians assembled on the anniversary of the martyrs' death at their graves, to celebrate the Agape and the Eucharist at this spot. It was a favourite custom to bury the dead near the graves of the martyrs; and it was the highest wish of many to "rest with the saints." It was the body lying in the tomb which was venerated (see Euseb. *Hist. eccl.* vii. 11, 24; viii. 6, 7).

But these customs soon underwent a further development. About the end of the 3rd and the beginning of the 4th century

it became customary for the bodies of the martyrs not to be buried, but preserved for the purpose of veneration. Already individual Christians began to possess themselves of portions of the bodies of martyrs, and to carry them about with them. Both these practices met with criticism and opposition, especially from the leading men of the Church. According to the testimony of Athanasius of Alexandria, the hermit Anthony decided that it should be held to be unlawful and impious to leave the bodies of the martyrs unburied (*Vita Ant.* 90). In Carthage the archdeacon and later the bishop Caecilianus severely blamed a certain Lucilla for carrying about with her a relic which she used to kiss before receiving the Eucharist (*Optatus, De schism. Donat.* i. 16). The compiler of the *Acta S. Fructuosi* (a Spanish ecclesiastical, represents the martyred bishop as himself requesting the burial of his relics. But energetic as the opposition was, it was unsuccessful, and died out. For in the meantime opinion as to the efficacy of relics had undergone a transformation, parallel with the growth of the theory, which soon predominated in the Church, that material instruments are the vehicles of divine grace. When the Christians of Smyrna decided that the bones of the martyrs were of more worth than gold or gems, and when Origen (*Exh. ad mart.* 50) spoke of the precious blood of the martyrs, they were thinking of the act of faith which the martyrs had accomplished by the sacrifice of their life. Now, on the other hand, the relic came to be looked upon as in itself a thing of value as the channel of miraculous divine powers. These ideas are set forth by Cyril of Jerusalem. He taught that a certain power dwelt in the body of the saint, even when the soul had departed from it; just as it was the instrument of the soul during life, so the power passed permanently into it (*Cat.* xviii. 16). This was coming very near to a belief that objects which the saints had used during their life had also a share in their miraculous powers. And this conclusion Cyril had already come to (*loc. cit.*).

We can see how early this estimate of relics became general from the fact that the former hesitation as to whether they should be venerated as sacred died out during the 4th century. The Fathers of the Greek Church especially were united in recommending the veneration of relics. All the great theologians of the 4th and 5th centuries may be quoted as evidence of this: Eusebius of Caesarea (*Praep. Ev.* xiii. 11), Gregory of Nazianzus (*Orat. in Cypr.* 17), Gregory of Nyssa (*Orat. de S. Theod. mart.*), Basil of Caesarea (*Ep.* ii. 107), Chrysostom (*Laud. Drosidis*), Theodoret of Cyrus (*Inps.* 67, 11), &c. John of Damascus, the great exponent of dogma in the 8th century, gave expression to the result of a uniform development which had been going on for centuries when he taught that Christ offers the relics to Christians as means of salvation. They must not be looked upon as something that is dead; for through them all good things come to those who pray with faith. Why should it seem impossible to believe in this power of the relics, when water could be made to gush from a rock in the desert? (*De fide orthod.* iv. 15).

Such was the theory; and the practice was in harmony with it. Throughout the whole of the Eastern Church the veneration of relics prevailed. Nobody hesitated to divide up the bodies of the saints in order to afford as many portions of them as possible. They were shared among the inhabitants of cities and villages, Theodoret tells us, and cherished by everybody as healers and physicians for both body and soul (*De cur. Graec.* aff. 8). The transition from the true relic to the hallowed object was especially common. Jerusalem, as early as the time of Eusebius, rejoiced in the possession of the episcopal chair of James the Just (*Hist. eccl.* vii. 10); and as late as the 4th century was discovered the most important of the relics of Christ, the cross which was alleged to have been His. Cyril of Jerusalem already remarks that the whole world was filled with portions of the wood of the cross (*Cat.* iv. 20).

The development which the veneration of relics underwent in the West did not differ essentially from that in the East. Here also the idea came to prevail that the body of the saint, or a portion of it, was possessed of healing and protective power

(Paulinus of Nola, *Poem.* xix. 14 et seq., xxvii. 443). The objection raised by the Aquitanian presbyter Vigilantius (c. 400) to the belief that the souls of the martyrs to a certain extent clung to their ashes, and heard the prayers of those who approached them, appeared to his contemporaries to be frivolous; and he nowhere met with any support.

The only doubt which was felt was as to whether the bodies of the saints should be divided, and removed from their original resting-place. Both practices were forbidden by law under the emperor Theodosius I. (*Cod. Theodos.* ix. 17, 7), and the division of the bodies of martyrs into pieces was prohibited for centuries. Even Pope Gregory I., in a letter to the empress Constantia, disapproved it (*Ep.* iv. 30). Ambrose of Milan, by the discovery of the relics of Protasius and Gervasius (*cf. Ep.* 22 and Augustine, *Confess.* ix. 7), started in the West the long series of discoveries and translations of hitherto unknown relics. His example was followed, to name only the best known instances, by Bishop Theodore of Octodurum (now Martigny in the Vaud), who discovered the relics of the Theban legion which was alleged to have been destroyed by the emperor Maximian on account of its belief in the Christian faith (see *Passio Acacii. Mart.* 16), and by Clematius, a citizen of Cologne, to whom the virgin martyrs of this city revealed themselves (Kraus, *Inschriften der Rheinlande*, No. 294), afterwards to be known as St Ursula and her eleven thousand virgins.

The West was much poorer in relics than the East. Rome, it is true, possessed in the bodies of Peter and Paul a treasure the virtue of which outshone all the sacred treasures of the East. But many other places were entirely wanting in relics. By the discoveries which we have mentioned their number was notably increased. But the longing for these pledges of the divine assistance was insatiable. In order to satisfy it relics were made by placing pieces of cloth on the graves of the saints, which were afterwards taken to their homes and venerated by the pilgrims. The same purpose was served by oil taken from the lamps burning at the graves, flowers from the altars, water from some holy well, pieces of the garments of saints, earth from Jerusalem, and especially keys which had been laid on the grave of St Peter at Rome. All these things were not looked upon as mementoes, but the conviction prevailed that they were informed by a miraculous power, which had passed into them through contact with that which was originally sacred (*cf. Greg. Tur. De Glor. mart.* i. 25; *Greg. I. Ep.* iv. 29, No. 30). A dishonest means of satisfying the craving for relics was that of forging them, and how common this became can be gathered from the many complaints about spurious relics (*Sulp. Sev. Vita Mart.* 8; *Aug. De op. mon.* 28; *Greg. I. Ep.* iv. 30, &c.).

But in the long run these substitutes for relics did not satisfy the Christians of the West, and, following the example of the Eastern Church, they took to dividing the bodies of the saints. Medieval relics in the West also were mostly portions of the bodies of saints or of things which they had used during their lives. The veneration of relics also received a strong impulse from the fact that the Church required that a relic should be deposited in every altar. Among the first of those whom we know to have attached importance to the placing of relics in churches is Ambrose of Milan (*Ep.* 22), and the 7th general council of Nicaea (787) forbade the consecration of churches in which relics were not present, under pain of excommunication. This has remained part of the law of the Roman Catholic Church.

The most famous relics discovered during the middle ages were those of the apostle James at St Jago de Compostella in Spain (see PILGRIMAGE), the bodies of the three kings, which were brought from Milan to Cologne in 1164 by the emperor Frederick I. (*Chron. reg. Colon.* for the year 1164), the so-called *sudarium* of St Veronica, which from the 12th century onwards was preserved in the Capella Santa Maria ad praesepe of St Peter's in Rome (see Dobschütz, *Christusbilder*, p. 218 sec.), and the seamless robe of Christ, the possession of which lent

renown to the cathedral of Trier since the beginning of the 12th century (*Gesta Trevir., Mon. Germ. Scr.* viii. p. 152).

The number of relics increased to a fabulous extent during the middle ages. There were churches which possessed hundreds, even thousands, of relics. In the cathedral of Eichstätt were to be found, as early as 1071, 683 relics (Gundech, *Lib. pont. Hist., Mon. Germ. Scr.* vii. p. 246 seq.); the monastery of Hirschau had 222 in the year 1091 (*De cons. mai. mon., Mon. Germ. Scr.* xiv. p. 261); the monastery of Stedernburg 515 in the year 1166 (*Ann. Sted. Scr.* xvi. p. 212 seq.). But these figures are trifling compared with those at the end of the middle ages. In the year 1520 could be counted 19,013 in the Schlosskirche at Wittenberg, and 21,483 in the Schlosskirche at Halle in 1521 (Köstlin, *Friedrich der W., und die Schlosskirche zu Wittenberg*, p. 58 seq.; Redlich, *Cardinal Albrecht und das Neue Stift zu Halle*, p. 260). There were also collections on the same scale belonging to individuals; a patrician of Nuremberg named Muffel was able to gain possession of 308 relics (*Chroniken der deutschen Städte*, xi. p. 745).

It is curious that while the popular craving for relics had passed all bounds, medieval theology was very cautious in its declarations on the subject of the veneration of relics. Thomas Aquinas based his justification of them on the idea of reverent commemoration; since we venerate the saints, we must also show reverence for their relics, for whoever loves another does honour to that which remains of him after death. On this account it is our duty, in memory of the saints, to pay due honour to their relics and especially to their bodies, which were the temples and dwellings of the Holy Ghost in which He dwelt and worked, and which in the resurrection are to be made like to the body of Christ; and in likewise because God honours them, in that He works wonders in their presence (*Summa theol.* iii. q. 25, art. 6). The great scholastic philosopher abandoned the theory that the relics in themselves are vessels and instruments of the divine grace and miraculous power. But these ideas were revived, on the other hand, by the Catholicism of the counter-Reformation, which again taught and teaches that God grants many benefits to mankind through the sacred bodies of the martyrs (*Conc. Trid. sess.* xxv.). The doctrine has adapted itself to the popular belief. (A. H.)*

RELIEF (through Fr. from Lat. *relevare*, to lift up), an act of raising or lifting off or up. Apart from the general sense of a mitigation, cessation or removal of pain, sorrow, discomfort, &c., and the artistic use (It. *relievo*) of the projection of a figure or design in sculpture from the ground on which it is formed, which is treated below, the term "relief" is used in the following senses; it was one of the feudal incidents between lord and vassal, and consisted of a payment to the lord in kind or money made by the heir on the death of the ancestor for the privilege of succession, for, fiefs not being hereditary, the estate had lapsed to the lord; by this payment the heir *caducum praedium relevabat* (Du Cange, *Gloss.* s.v. *Relevare*). The word is also generally used, in law, for any exemption granted by a court from the strict legal consequences of an act, &c., e.g. to a parliamentary candidate from the penal consequences ensuing from breaches of the regulations of the Corrupt and Illegal Practices Acts. Relief is also the term used in English law for the assistance given to the indigent poor by the Poor Law authorities (see POOR LAW).

RELIEF, a term in sculpture signifying ornament, a figure or figures raised from the ground of a flat surface of which the sculptured portion forms an inherent part of the body of the whole. The design may be in high relief—"alto-relievo" (*q.v.*), or low relief—"bas-relief" or "basso-relievo" (*q.v.*); in the former case the design is almost wholly detached from the ground, the attachment, through "under-cutting," remaining only here and there; in the latter it is wholly attached and may scarcely rise above the surface (as in the modern medal), or it may exceed in projection to about a half the proportionate depth (or thickness) of the figure or object represented. Formerly three terms were commonly employed to express the degree of relief—alto-relievo, basso-relievo and mezzo-relievo (or half-relief); but the

two last-named have been merged by modern custom into "low-relief," to the disadvantage of accurate description. The term relief belongs to modern sculpture. To low relief is understood by us Pliny applied the word *anaglypta*, but it is to be observed that embossing and chasing came within the same category. It may be considered that less sculptural skill (independently of manipulative skill) is needed in high relief than in low relief, because in the former the true relative proportions in the life (whether figure or other object) have to be rendered, while in the latter, although the true height and, in a measure, breadth can be given, the thickness of the object is reduced by at least one-half, sometimes to almost nothing; and yet in spite of this departure from actuality, this abandonment of fact for a pure convention, a true effect must still be produced, not only in respect to perspective, but also of the actual shadows cast. And inasmuch as the compositions are often extremely complicated and have sometimes to suggest retreating planes, the true plane of the material affords little scope for reproducing the required effect. In the beginning the essential idea of the relief was always maintained: that is to say, the sense of the flatness of the slab from which it was cut was impressed throughout the design on the mind of the spectator. Thus the Egyptians merely sunk the outlines and scarcely more than suggested the modelling of the figures, which never projected beyond the face of the surrounding ground. The Persians, the Etruscans and the Greeks carried on the art to the highest perfection, alike in sculpture and architectural ornament, and they applied it to gem sculpture, as in the case of "cameo." Similarly, the inverse treatment of relief—that is, sunk below the surface, in order that when used for seals a true relief is obtained—was early brought to great completeness; this form of engraving is called "intaglio." The degree of projection in relief, broadly speaking, has varied greatly with the periods of art. Thus, in Byzantine and Romanesque art the relief was low. In Gothic it increased with the increased desire to render several planes one behind the other. With the advent of the Renaissance it became still more accentuated, the heads and figures projecting greatly; but such high relief is sometimes found in early work, especially in metal-work. Although we see a return to lower relief in the Henri II. period, it becomes stronger in the Louis XIII. style, very full in Louis XIV. and Louis XV., but in Louis XVI. is considerably reduced. (M. H. S.)

RELIGION. The origin of the Latin word *religio* or *religio* has been the subject of discussion since the time of Cicero. Two alternative derivations have been given, viz. from *religere*, to gather together, and *religare*, to bind back, fasten. *Religere* meant to gather together, collect, hence to go over a subject again in thought, from *re* and *legere*, to collect together, hence to read, collect at a glance. This view is that given by Cicero (*Nat. Deor.* ii. 28, 72). He says: "Qui omnia quae ad cultum deorum pertinenter diligenter retractant et tanquam relegerent, sunt dicti religiosi ex relegendo." "men were called 'religious' from *relegere*, because they reconsidered carefully and, as it were, went over again in thought all that pertained to the worship of the gods." He compares *elegantes* from *eliger*, *diligentes* from *diligere*, and continues, "his enim in verbis omnibus inest vis legendi eadem quae in religioso." This view is supported by the form of the word in the verse quoted by Gellius (iv. 9), "religement esse oportet, religiosum nefas," and by the use of the Greek ἀλέγειν, to pay heed to, frequently with a negative, in the sense of the Latin *negligere* (*neg-legere*), cf. ὄσων ἔστω οὐκ ἀλέγειντες (Homer, *Il.* xvi. 388), heeding not the visitation of the gods, or οὐ γὰρ Κίχλωτες Διὸς . . . ἀλέγουσιν (*Od.* ix. 275). The alternative derivation, from *religare*, to fasten, bind, is that adopted by Lactantius (*Inst.* iv. 28), "Vinculo pietatis obstricti, Deo religati sumus inde ipsa religio nomen cepit." He quotes in support the line from Lucretius (i. 931), "religionum nodis nimen exsolvere." Servius (on Virgil, *Aen.* viii. 349) and St Augustine (*Retract.* i. 13) also take *religare* as the source of the word. It is one that has certainly coloured the meaning of the word, particularly in that use which restricts

it to the monastic life with its binding rules. It also has appealed to Christian thought. Liddon (*Some Elements of Religion*, Lecture I. 19) says: "Lactantius may be wrong in his etymology, but he has certainly seized the broad popular sense of the word when he connects it with the idea of an obligation by which man is bound to an invisible God." Archbishop Trench (*Study of Words*) supposed that when "religion" became equivalent to the monastic life, and "religious" to a monk, the words lost their original meaning, but the *Ancren Riwle*, ante 1225, and the *Cursor Mundi* use the words both in the general and the more particular sense (see quotations in the *New English Dictionary*), and both meanings can be found in the *Imitatio Christi* and in Erasmus's *Colloquia*. (X.)

The study of the forms of belief and worship belonging to different tribes, nations or religious communities has only recently acquired a scientific foundation. The Greek historians early directed their attention to the ideas and customs of the peoples with whom they were brought into contact; and Herodotus has been called the "first anthropologist of religion." Theopompus described the Persian dualism in the 4th century B.C., and when Megasthenes was ambassador to the court of Chandragupta, 302 B.C., he noted the religious usages of the middle Ganges valley. The early Christian Fathers recorded many a valuable observation of the Gentile faiths around them from varying points of view, sympathetic or hostile; and Eusebius and Epiphanius, in the 4th century A.D., attributed to the librarian of Ptolemy Philadelphus the design of collecting the sacred books of the Ethiopians, Indians, Persians, Elamites, Babylonians, Assyrians, Romans, Phoenicians, Syrians and Greeks. The Mahomedan Birûnî (b. A.D. 973) compared the doctrines of the Greeks, Christians, Jews, Manichaeans and Sufis with the philosophies and religions of India. Akbar (1542-1605) gathered Brahmans and Zoroastrians, Jews, Christians and Mahomedans at his court, and endeavoured to get translations of their scriptures. In the next century the Persian author of the *Dabistan* exhibited the doctrines of no less than twelve religions and their various sects. Meanwhile the scholars of the West had begun to work. Thomas Hyde (1636-1703) studied the religion of the ancient Persians; John Spencer (1630-1693) analysed the laws of the Hebrews; and Lord Herbert of Cherbury (*De Religione Gentilium*, 1645) endeavoured to trace all religions back to five "truly Catholic truths" of primitive faith, the first being the existence of God. The doctrine of a primeval revelation survived in various forms for two centuries, and appeared as late as the *Juventus Mundi* of W. E. Gladstone (1868, p. 207 ff.). David Hume, on the other hand, based his essay on *The Natural History of Religion* (1757) on the conception of the development of human society from rude beginnings, and all modern study is frankly founded on the general idea of Evolution.¹

The materials at Hume's command, however, were destined to vast and speedy expansion. The Jesuit missionaries had already been at work in India and China, and a brilliant band of English students, led by Sir William Jones and H. T. Colebrooke, began to make known the treasures of Sanskrit literature, which the great scholars of Germany and France proceeded to develop. In Egypt the discovery of the Rosetta stone placed the key to the hieroglyphics within Western reach; and the decipherment of the cuneiform character enabled the patient scholars of Europe to recover the clues to the contents of the ancient libraries of Babylonia and Assyria. With the aid of inscriptions the cults of Greece and Rome have been largely reconstructed. Travellers and missionaries reported the beliefs and usages of uncivilized tribes in every part of the world, with the result that "ethnography knows no race devoid of religion, but only differences in the degree to which religious ideas have developed" (Ratzel, *History of Mankind*, i. 40). Meanwhile philosophy was at work on the problem of the religious consciousness. The great series of German thinkers, Lessing, Herder, Kant, Hegel, Fichte, Schleiermacher and their

successors, sought to explain religion by means of the phenomena of mind, and to track it to its roots in the processes of thought and feeling. While ethnography was gathering up the facts from every part of the globe, psychology began to analyse the forms of belief, of action and emotion, to discover if possible the key to the multitudinous variety which history revealed. From the historical and linguistic side attention was first fixed upon the myth, and the publication of the ancient hymns of the *Rig Veda* led Max Müller to seek in the common elements of Aryan thought for the secrets of primitive religion (essay on *Comparative Mythology*, 1856). The phenomena of day and night, of sunshine and storm, and other aspects of nature, were invoked by different interpreters to explain the conceptions of the gods, their origins and their relations. Fresh materials were gathered at the same time out of European folk-lore; the work begun by the brothers Grimm was continued by J. W. E. Mannhardt, and a lower stratum of beliefs and rites began to emerge into view beneath the poetic forms of the more developed mythologies. By such preliminary labours the way was prepared for the new science of anthropology.

Since the appearance of Dr E. B. Tylor's classical treatise on *Primitive Culture* (1871), the study of the origins of religion has been pursued with the utmost zeal. Comte had already described the primitive form of the religious consciousness as that in which man conceives of all external bodies as animated by a life analogous to his own (*Philos. Positive*, tome v., 1841, p. 30). This has been since designated as *polyzoism* or *pantheism* or *panimalism*,² and represents the obscure undifferentiated groundwork out of which Tylor's *Animism* arises. Many are the clues by which it has been sought to explain the secret of primitive religion. Hegel, before the anthropological stage, found it in magic. Max Müller, building on philosophy and mythology, affirmed that "Religion consists in the perception of the infinite under such manifestations as are able to influence the moral character of man" (*Natural Religion*, 1809, p. 188). Herbert Spencer derived all religion from the worship of the dead (*Principles of Sociology*, i.), like Grant Allen, and Lippert in Germany. Mr Andrew Lang, on the other hand, supposes that belief in a supreme being came first in order of evolution, but was afterwards thrust into the background by belief in ghosts and lesser divinities (*Magic and Religion*, 1901, p. 224).³ Dr Jevons finds the primitive form in totemism (*Introd. to the History of Religion*, 1896, chap. ix.). Mr J. G. Frazer regards religion (see his definition quoted below) as superposed on an antecedent state of magic. In *The Tree of Life* (1905), Mr E. Crawley interprets it by the vital instinct, and connects its first manifestations with the processes of the organic life. The veteran Wilhelm Wundt (*Mythos und Religion*, ii. 1906, p. 177) recurs to the primitive conceptions of the soul as the source of all subsequent development. The origin of religion, however, can never be determined archaeologically or historically; it must be sought conjecturally through psychology. (J. E. C.)

A. PRIMITIVE RELIGION

There is a point at which the History of Religion becomes in its predominant aspect a History of Religions. The conditions that we describe by the comprehensive term "civilization" occasion a specification and corresponding differentiation of the life of societies; whence there result competing types of culture, each instinct with the spirit of propagandism and, one might almost say, of empire. It is an age of conscious selection as between ideal systems. Instead of necessitating a wasteful and precarious elimination of inadequate customs by the actual destruction of those who practise them—this being the method of natural selection, which, like some Spanish Inquisition, abolishes the heresy by wiping out the heretics one and all—progress now becomes possible along the more direct and less

² Comte's own term "fetichism" was most unfortunately misleading (see FETICHISM). Marett proposed the term "Animatism," *Folk Lore* (1900), xi. p. 171.

³ See his treatise on *The Making of Religion* (1898), and Hartland's article on "The 'High Gods' of Australia," *Folk Lore* (1898), ix. p. 290.

¹ This does not, of course, preclude the possibility of degeneration in particular instances.

painful path of conversion. The heretic, having developed powers of rational choice, perceives his heresy, to wit, his want of adaptation to the moral environment, and turning round embraces the new faith that is the passport to survival.

Far otherwise is it with man at the stage of savagery—the stage of petty groups pursuing a self-centred life of inveterate custom, in an isolation almost as complete as if they were marooned on separate atolls of the ocean. Progress, or at all events change, does indeed take place, though very slowly, since the most primitive savage we know of has his portion of human intelligence, looks after and before, nay, in regard to the pressing needs of every day shows a quite remarkable shrewdness and resource. Speaking generally, however, we must pronounce him unprogressive, since, on the whole, unreflective in regard to his ends. It is the price that must be paid for social discreteness and incoherency. And the consequence of this atomism is not what a careless thinker might be led to assume, extreme diversity, but, on the contrary, extreme homogeneity of culture. It has been found unworkable, for instance, to classify the religions of really primitive peoples under a plurality of heads, as becomes necessary the moment that the presence of a distinctive basis of linked ideas testifies to the individuality of this or that type of higher creed. Primitive religions are like so many similar beads on a string; and the concern of the student of comparative religion is at this stage mainly with the nature of the string, to wit, the common conditions of soul and society that make, say, totemism, or taboo, very much the same thing all the savage world over, when we seek to penetrate to its essence.

This fundamental homogeneity of primitive culture, however, must not be made the excuse for a treatment at the hands of psychology and sociology that dispenses with the study of details and trusts to an a priori method. By all means let universal characterization be attempted—we are about to attempt one here, though well aware of the difficulty in the present state of our knowledge—but they must at least model themselves on the composite photograph rather than the impressionist sketch. An enormous mass of material, mostly quite in the raw, awaits reduction to order on the part of anthropological theorists, as yet a small and ill-supported body of enthusiasts. Under these circumstances it would be premature to expect agreement as to results. In regard to method, however, there is little difference of opinion. Thus, whereas the popular writer abounds in wide generalizations on the subject of primitive humanity, the expert has hitherto for the most part deliberately restricted himself to departmental investigations. Religion, for example, seems altogether too vast a theme for him to embark on, and he usually prefers to deal with some single element or aspect. Again, origins attract the *littérateur*; he revels in describing the transition from the pre-religious to the religious era. But the expert, confining his attention to the known savage, finds him already religious, nay, encumbered with religious survivals of all kinds; for him, then, it suffices to describe things as they now are, or as they were in the comparatively recent fore-time. Lastly, there are many who, being competent in some other branch of science, but having small acquaintance with the scientific study of human culture, are inclined to explain primitive ideas and institutions from without, namely by reference to various external conditions of the mental life of peoples, such as race, climate, food-supply and so on. The anthropological expert, on the other hand, insists on making the primitive point of view itself the be-all and end-all of his investigations. The inwardness of savage religion—the meaning it has for those who practise it—constitutes its essence and meaning likewise for him, who after all is a man and a brother, not one who stands really outside.

In what follows, then, we shall, indeed, venture to present a wholesale appreciation of the religious idea as it is for primitive man in general; but our account will respect the modern anthropological method that bids the student keep closely to the actualities of the religious experience of savages, as it can with reasonable accuracy be gathered from what they do and say.

We have sought to render only the spirit of primitive religion, keeping clear both of technicalities and of departmental investigations. These are left to the separate articles bearing on the subject. There the reader will find the most solid results of recent anthropological research. Here he is merely offered a flimsy thread that, we hope, may guide him through the maze of facts, but alas! is only too likely to break off short in his hand.

Definition of Primitive Religion.—In dealing with a development of culture that has no immutable essence, but is intrinsically fluid and changing, definition must consist either in a definition of type, which indicates prevalence of relevant resemblance as between specimens more or less divergent, or in exterior definition, which delimits the field of inquiry by laying down within what extreme limits this divergence holds. Amongst the numberless definitions of religion that have been suggested, those that have been most frequently adopted for working purposes by anthropologists are Tylor's and Frazer's. Dr E. B. Tylor in *Primitive Culture* (1), i. 424, proposes as a "minimum definition" of religion "the belief in spiritual beings." Objections to this definition on the score of incompleteness are, firstly, that, besides belief, practice must be reckoned with (since, as Dr W. Robertson Smith has made clear in his *Lectures on the Religion of the Semites*, 18 sqq., ritual is in fact primary for primitive religion, whilst dogma and myth are secondary); secondly, that the outlook of such belief and practice is not exclusively towards the spiritual, unless this term be widened until it mean next to nothing, but is likewise towards the quasi-material, as will be shown presently. The merit of this definition, on the other hand, lies in its bilateral form, which calls attention to the need of characterizing both the religious attitude and the religious object to which the former has reference. The same form appears in Dr J. G. Frazer's definition in *The Golden Bough* (2nd ed.), i. 63. He understands by religion "a propitiation or conciliation of powers superior to man which are believed to direct and control the course of nature and of human life." He goes on to explain that by "powers" he means "conscious or personal agents." It is also to be noted that he is here definitely opposing religion to magic, which he holds to be based on the (implicit) assumption "that the course of nature is determined, not by the passions or caprice of personal beings, but by the operation of immutable laws acting mechanically." His definition improves on Tylor's in so far as it makes worship integral to the religious attitude. By regarding the object of religion as necessarily personal, however, he is led to exclude much that the primitive man undoubtedly treats with awe and respect as exerting a mystic effect on his life. Further, in maintaining that the powers recognized by religion are always superior to man, he leaves unclassified a host of practices that display a bargaining, or even a hectoring, spirit on the part of those addressing them (see PRAYER). Threatening or beating a fetish cannot be brought under the head of magic, even if we adopt Frazer's principle (*op. cit.* i. 64) that to constrain or coerce a personal being is to treat him as an inanimate agent; for such a principle is quite inapplicable to cases of mere terrorism, whilst it may be doubted if it even renders the sense of the savage magician's typical notion of his *modus operandi*, viz. as the bringing to bear of a greater *mana* or psychic influence (see below) on what has less, and must therefore do as it is bidden. Such definitions, then, are to be accepted, if at all, as definitions of type, selective designations of leading but not strictly universal features. An encyclopaedic account, however, should rest rather on an exterior definition which can serve as it were to pigeon-hole the whole mass of significant facts. Such an exterior definition is suggested by Mr E. Crawley in *The Tree of Life*, 209, where he points out that "neither the Greek nor the Latin language has any comprehensive term for religion, except in the one *τέπᾱ*, and in the other *sacra*, words which are equivalent to 'sacred.' No other term covers the whole of religious phenomena, and a survey of the complex details of various worships results in showing that no other conception will comprise the whole body of religious facts." It may be added that we have here no generalization imported from a

higher level of culture, but an idea or blend of ideas familiar to primitive thought. An important consequence of thus giving the study of primitive religion the wide scope of a comparative hierology is that magic is no longer divorced from religion, since the sacred will now be found to be coextensive with the magico-religious, that largely undifferentiated plasm out of which religion and magic slowly take separate shape as society comes more and more to contrast legitimate with illicit modes of dealing with the sacred. We may define, then, the religious object as the sacred, and the corresponding religious attitude as consisting in such manifestation of feeling, thought and action in regard to the sacred as is held to conduce to the welfare of the community or to that of individuals considered as members of the community.

Aspects of the Nature of the Sacred.—To exhibit the general character of the sacred as it exists for primitive religion it is simplest to take stock of various aspects recognized by primitive thought as expressed in language. If some, and not the least essential, of these aspects are quasi-negative, it must be remembered that negations—witness the Unseen, the Unknown, the Infinite of a more advanced theology—are well adapted to supply that mystery on which the religious consciousness feeds with the slight basis of conceptual support it needs. (1) *The sacred as the forbidden.* The primitive notion that perhaps comes nearest to our "sacred," whilst it immediately underlies the meanings of the Latin *sacer* and *sanctus*, is that of a *taboo*, a Polynesian term for which equivalents can be quoted from most savage vocabularies. The root idea seems to be that something is marked off as to be shunned, with the added hint of a mystic sanction or penalty enforcing the avoidance. Two derivative senses of a more positive import call for special notice. On the one hand, since that which is tabooed is held to punish the taboo-breaker by a sort of mystic infection, taboo comes to stand for uncleanness and sin. On the other hand, since the isolation of the sacred, even when originally conceived in the interest of the profane, may be interpreted as self-protection on the part of the sacred as against defiling contact, taboo takes on the connotation of ascetic virtue, purity, devotion, dignity and blessedness. Primary and secondary senses of the term between them cover so much ground that it is not surprising to find taboo used in Polynesia as a name for the whole system of religion, founded as it largely is on prohibitions and abstinences. (2) *The sacred as the mysterious.* Another quasi-negative notion of more restricted distribution is that of the mysterious or strange, as we have it expressed, for example, in the Siouan *wakan*, though possibly this is a derivative meaning. Meanwhile, it is certain that what is strange, new or portentous is regularly treated by all savages as sacred. (3) *The sacred as the secret.* The literal sense of the term *churinga*, applied by the Central Australians to their sacred objects, and likewise used more abstractly to denote mystic power, as when a man is said to be "full of *churinga*," is "secret," and is symptomatic of the esotericism that is a striking mark of Australian, and indeed of all primitive, religion, with its insistence on initiation, its exclusion of women, and its strictly enforced reticence concerning traditional lore and proceedings.

(4) *The sacred as the potent.* Passing on to positive conceptions of the sacred, perhaps the most fundamental is that which identifies the efficacy of sacredness with such mystic or magical power as is signified by the *mana* of the Pacific or *orenda* of the Hurons, terms for which analogies are forthcoming on all sides. Of *mana* Dr R. H. Codrington in *The Melanesians*, 119 n., writes: "It essentially belongs to personal beings to originate it, though it may act through the medium of water, or a stone, or a bone. All Melanesian religion consists . . . in getting this *mana* for oneself, or getting it used for one's benefit." E. Tregear's *Maori-Polynesian Comparative Dictionary* shows how the word and its derivatives are used to express thought, memory, emotion, desire, will—in short, psychic energy of all kinds. It also stands for the vehicle of the magician's energy—the spell; which would seem like-

wise to be a meaning, perhaps the root-meaning, of *orenda* (cf. J. N. B. Hewitt, *American Anthropologist*, N.S., iv. 40). Whereas everything, perhaps, has some share of indwelling potency, whatever is sacred manifests this potency in an extraordinary degree, as typically the wonder-working leader of society, whose *mana* consists in his cunning and luck together. Altogether, in *mana* we have what is *par excellence* the primitive religious idea in its positive aspect, taboo representing its negative side, since whatever has *mana* is taboo, and whatever is taboo has *mana*. (5) *The sacred as the animate.* The term "animism," which embodies Tylor's classical theory of primitive religion, is unfortunately somewhat ambiguous. If we take it strictly to mean the belief in ghosts or spirits having the "vaporous materiality" proper to the objects of dream or hallucination, it is certain that the agency of such phantasms is not the sole cause to which all mystic happenings are referred (though ghosts and spirits are everywhere believed in, and appear to be endowed with greater predominance as religious synthesis advances amongst primitive peoples). Thus there is good evidence to show that many of the early gods, notably those that are held to be especially well disposed to man, are conceived rather in the shape of magnified non-natural men dwelling somewhere apart, such as the Mungangaur of the Kurnai of S.E. Australia (cf. A. Lang, *The Making of Religion*², x. sqq.). Such anthropomorphism is with difficulty reduced to the Tylorian animism. The term, however, will have to be used still more vaguely, if it is to cover all attribution of personality, will or vitality. This can be more simply brought under the notion of *mana*. Meanwhile, since quasi-mechanical means are freely resorted to in dealing with the sacred, as when a Maori chief snuffs up the sanctity his fingers have acquired by touching his own sacred head that he may restore the virtue to the part whence it was taken (R. Taylor, *Te Ika a Maui*, 165), or when uncleanness is removed as if it were a physical secretion by washing, wiping and so forth, it is hard to say whether what we should now call a "material" nature is not ascribed to the sacred, more especially when its transmissibility after the manner of a contagion is the trait that holds the attention. It is possible, however, that the savage always distinguishes in a dim way between the material medium and the indwelling principle of vital energy, examples of a pure fetishism, in the sense of the cult of the purely material, recognized as such, being hard to find. (6) *The sacred as the ancient.* The prominence of the notion of the *Aicheringa* "dreamtime," or sacred past, in Central Australian religion illustrates the essential connexion perceived by the savage to lie between the sacred and the traditional. Ritualistic conservatism may be instanced as a practical outcome of this feeling. Another development is ancestor-worship, the organized cult of ancestors marking, however, a certain stage of advance beyond the very primitive, though the dead are always sacred and have *mana* which the living may exploit for their own advantage.

The Activity of the Sacred.—The foregoing views of the sacred, though starting from distinct conceptions, converge in a single complex notion, as may be seen from the many-sided sense borne by such a term as *wakan*, which may stand not only for "mystery," but also for "power, sacred, ancient, grandeur, animate, immortal" (W. J. McGee, *15th Report of U. S. Bureau of Ethnology*, 182). The reason for this convergence is that, whereas there is found great difficulty in characterizing the elusive nature of the sacred, its mode of manifesting itself is recognized to be much the same in all its phases. Uniform characteristics are the fecundity, ambiguity, relativity and transmissibility of its activity. (1) *Fecundity.* The mystic potency of the sacred is no fixed quantity, but is big with possibilities of all sorts. The same sacred person, object, act, will suffice for a variety of purposes. Even where a piece of sympathetic magic appears to promise definite results, or when a departmental god is recognized, there would seem to be room left for a more or less indefinite expectancy. It must be remembered that the meaning of a rite is for the most part obscure

to the participants, being overlaid by its traditional character, which but guarantees a general efficacy. "Blessings come, evils go," may be said to be the magico-religious formula implicit in all socially approved dealings with the sacred, however specialized in semblance. (2) *Ambiguity*. Mystic potency, however, because of the very indefiniteness of its action, is a two-edged sword. The sacred is not to be approached lightly. It will heal or blast, according as it is handled with or without due circumspection. That which is taboo, for instance, the person of the king, or woman's blood, is poison or medicine according as it is manipulated, being inherently just a potentiality for wonder-working in any direction. Not but what primitive thought shows a tendency to mark off a certain kind of mystic power as wholly bad by a special name, e.g. the *arungquilha* of Central Australia; and here, we may note, we come nearest to a conception of magic as something other than religion, the trafficker in *arungquilha* being socially suspect, nay, liable to persecution, and even death (as amongst the Arunta tribe, see Spencer and Gillen, *Native Tribes of C. Australia*, 536), at the hands of his fellows. On the other hand, wholly beneficent powers seem hardly to be recognized, unless we find them in beings such as Mungan-ngaur ("father-our"), who derive an ethical character from their association with the initiation ceremonies and the moral instruction given thereat (cf. Lang, *l.c.*).

(3) *Relativity*. So far we have tended to represent the activity of the sacred as that of a universal force, somewhat in the style of our "electricity" or "mind." It remains to add that this activity manifests itself at numberless independent centres. These differ amongst themselves in the degree of their energy. One spell is stronger than another, one taboo more inviolable than another. Dr W. H. R. Rivers (*The Todas*, 448) gives an interesting analysis of the grades of sanctity apparent in Toda religion. The gods of the hill-tops come first. The sacred buffaloes, their milk, their bells, the dairies and their vessels are on a lower plane; whilst we may note that there are several grades amongst the dairies, increase of sanctity going with elaboration of dairy ritual (cf. *ibid.* 232). Still lower is the dairyman, who is in no way divine, yet has sanctity as one who maintains a condition of ceremonial purity. (4) *Transmissibility*. If, however, this activity originates at certain centres, it tends to spread therefrom in all directions. Dr F. B. Jevons (in *An Introduction to the History of Religion*, vii.) distinguishes between "things taboo," which have the mystic contagion inherent in them, and "things tabooed," to which the taboo-infection has been transmitted. In the former class he places supernatural beings (including men with *mana* as well as ghosts and spirits), blood, newborn children with their mothers, and corpses; which list might be considerably extended, for instance, by the inclusion of natural portents, and animals and plants such as are strikingly odd, dangerous or useful. Any one of these can pass on its sacred quality to other persons and objects (as a corpse defiles the mourner and his clothes), nay to actions, places and times as well (as a corpse will likewise cause work to be tabooed, ground to be set apart, a holy season to be observed). Such transmissibility is commonly explained by the association of ideas, that becoming sacred which as it were reminds one of the sacred; though it is important to add, firstly, that such association takes place under the influence of a selective interest generated by strong religious feeling, and, secondly, that this interest is primarily a collective product, being governed by a social tradition which causes certain possibilities of ideal combination alone to be realized, whilst it is the chief guarantee of the objectivity of what they suggest.

The Exploitation of the Sacred. A. Methods.—It is hard to find terms general enough to cover dealings with the sacred that range from the manipulation of an almost inanimate type of power to intercourse modelled on that between man and man. Primitive religion, however, resorts to either way of approach so indifferently as to prove that there is little or no awareness of an inconsistency of attitude. The radical contrast between mechanical and spiritual religion, though fundamental for modern theology, is alien to the primitive point of view, and is

therefore inappropriate to the purposes of anthropological description. (1) *Acquisition*. Mystic power may be regarded as innate so far as skill, luck or queerness are signs and conditions of its presence. On the whole, however, savage society tends to regard it as something acquired, the product of acts and abstinences having a traditional character for imparting magico-religious virtue. An external symbol in the shape of a ceremony or cult-object is of great assistance to the dim eye of primitive faith. Again, the savage universe is no preserve of man, but is an open field wherein human and non-human activities of all sorts compete on more or less equal terms, yet so that a certain measure of predominance may be secured by a judicious combination of forces. (2) *Concentration*. Hence the magico-religious society or individual practitioner piles ceremony on ceremony, name of power on name of power, relic on relic, to consolidate the forces within reach and assume direction thereof. The transmissibility of the sacred ensures the fusion of powers drawn from all sources, however disparate. (3) *Induction*. It is necessary, however, as it were to bring this force to a head. This would appear to be the essential significance of sacrifice, where a number of sacred operations and instruments are made to discharge their efficacy into the victim as into a vat, so that a blessing-yielding, evil-neutralizing force of highest attainable potency is obtained (see H. Hubert and M. Mauss, "Essai sur la nature et la fonction du sacrifice" in *L'Année sociologique*, ii.).

(4) *Renovation*. An important motif in magico-religious ritual, which may not have been without effect on the development of sacrifice, is, as Dr Frazer's main thesis in *The Golden Bough* asserts, the imparting of reproductive energy to animals, plants and man himself, its cessation being suggested by such phenomena as old age and the fall of the year. To concentrate, induce and renovate are, however, but aspects of one process of acquisition by the transfusion of a transmissible energy. (5) *Demission*. Hubert and Mauss show in their penetrating analysis of sacrifice that after the rite has been brought to its culminating point there follows as a pendant a ceremony of re-entry into ordinary life, the idea of which is preserved in the Christian formula *Ite, missa est*. (6) *Insulation*. Such deposition of sacredness is but an aspect of the wider method that causes a ring-fence to be erected round the sacred to ward off casual trespassers at once in their own interest and to prevent contamination. We see here a natural outcome of religious awe supported by the spirit of esotericism, and by a sense of the need for an expert handling of that which is so potent for good or ill. (7) *Direction*. This last consideration brings to notice the fact that throughout magico-religious practice of all kinds the human operator retains a certain control over the issue. In the numberless transitions that, whilst connecting, separate the spell and the prayer we observe as the accompaniment of every mood from extreme imperiousness to extreme humility an abiding will and desire to help the action out. Even "Thy will be done" preserves the echo of a direction, and, needless to say, this is hardly a form of primitive address. At the bottom is the vague feeling that it is man's own self-directed mysterious energy that is at work, however much it needs to be reinforced from without. Meanwhile, tradition strictly prescribes the ways and means of such reinforcement, so that religion becomes largely a matter of sacred lore; and the expert director of rites, who is likewise usually at this stage the leader of society, comes more and more to be needed as an intermediary between the lay portion of the community and the sacred powers.

B. *Results.*—Hitherto our account of primitive religion has had to move on somewhat abstract lines. His religion is, however, anything but an abstraction to the savage, and stands rather for the whole of his concrete life so far as it is penetrated by a spirit of earnest endeavour. The end and result of primitive religion is, in a word, the consecration of life, the stimulation of the will to live and to do. This bracing of the vital feeling takes place by means of imaginative appeal to the great forces man perceives stirring within him and about him, such appeal proving effective doubtless by reason of the psychological law that to conceive strongly is

to imitate. Meanwhile, that there shall be no clashing of conceptions to inhibit the tendency of the idea of an acquired "grace" to realize itself in action, is secured by the complete unanimity of public opinion, dominated as it is by an inveterate custom. To appreciate the consecrating effect of religion on primitive life we have only to look to the *churinga*-worship of the Central Australians (as described by Spencer and Gillen in *The Native Tribes of Central Australia* and *The Northern Tribes of Central Australia*). Contact with these repositories of mystic influence "makes them glad" (*Nat. Tr.* 163); it likewise makes them "good," so that they are no longer greedy or selfish (*North. Tr.* 266); it endows them with second sight (*ibid.*); it gives them confidence and success in war (*Nat. Tr.* 135); in fact, there is no end to its "strengthening" effects (*ibid. n.*). Or, again, we may note the earnestness and solemnity that characterize all their sacred ceremonies. The inwardness of primitive religion is, however, non-existent for those who observe it as uninitiated strangers; whilst, again, it evaporates as soon as native custom breaks down under pressure of civilization, when only fragments of meaningless superstition survive: wherefore do travesties of primitive religion abound.

It remains to consider shortly the consecration of life in relation to particular categories and departments. (1) *Education*. Almost every tribe has its initiation ceremonies, and in many tribes adult life may almost be described as a continuous initiation. The object of these rites is primarily to impart mystic virtue to the novice, such virtue, in the eyes of the primitive man, being always something more than social usefulness, amounting as it does to a share in the tribal luck by means of association with all it holds sacred. Incidentally the candidate is trained to perform his duties as a tribesman, but religion presides over the course, demanding earnest endeavour of an impressionable age. (2) *Government*. Where society is most primitive it is most democratic, as in Australia, and magico-religious powers are possessed by the whole body of fully initiated males, age, however, conferring increase of sacred lore and consequently of authority; whilst even at this stage the experts tend to form an inner circle of rulers. The man with *mana* is bound to come to the top, both because his gifts give him a start and because his success is taken as a sign that he has the gift. A decisive "moment" in the evolution of chiefship is the recognition of hereditary *mana*, bound up as this is with the handing on of ceremonies and cult-objects. Invested, as society grows more complex, with a sanctity increasingly superior to that of the layman, the priest-king becomes the representative of the community as repository of its luck, whilst, as controller of all sacred forces that bear thereon, he is, as Dr Frazer puts it, "dynamical centre of the universe" (*The Golden Bough* (2nd ed.), i. 233). Only when the holy man's duty to preserve his holiness binds him hand and foot in a network of taboos does his temporal power tend to devolve on a deputy. (3) *Food-supply*. In accordance with the principle of Renovation (see above), the root-idea of the application of religion to economics is not the extorting of boons from an unwilling nature, but rather the stimulation of the sources of life, so that all beings alike may increase and multiply. (4) *Food-taking*. Meanwhile, the primitive meal is always more or less of a sacrament, and there are many food-taboos, the significance of which is, however, not so much that certain foods are unclean and poisonous as that they are of special virtue and must be partaken of solemnly and with circumspection. (5) *Kinship*. It is hard to say whether the unit of primitive society is the tribe or the group of kinsmen. Both are forms of union that are consolidated by means of religious usages. Thus in Australia the initiation ceremonies, concerned as they partly are with marriage, always an affair between the kin-groups, are tribal, whilst the totemic rites are the prime concern of the members of the totem clans. The significance of a common name and a common blood is immensely enhanced by its association with mystic rights and duties, and the pulse of brotherhood beats faster. (6) *The Family*. Side by side with the kin there is always found the domestic group, but

the latter institution develops fully only as the former weakens, so that the one comes largely to inherit the functions of the other, whilst the tribe too in its turn hands over certain interests. Thus in process of time birth-rites, marriage-rites, funeral-rites, not to mention subordinate ceremonies such as those of name-giving and food-taking, become domestic sacraments. (7) *Sex*. Woman, for certain physiological reasons, is always for primitive peoples hedged round with sanctity, whilst man does all he can to inspire awe of his powers in woman by keeping religion largely in his own hands. The result, so far as woman is concerned, is that, in company with those males who are endowed with sacredness in a more than ordinary degree, she tends as a sex to lose in freedom as much as she gains in respect. (8) *Personality*. Every one has his modicum of innate *mana*, or at least may develop it in himself by communicating with powers that can be brought into answering relation by the proper means. Nigualism, or the acquisition of a mystic guardian, is a widely distributed custom, the essence of which probably consists in the procuring of a personal name having potency. The exceptional man is recognized as having *mana* in a special degree, and a belief thus held at once by others and by himself is bound to stimulate his individuality. The primitive community is not so custom-bound that personality has no chance to make itself felt, and the leader of men possessed of an inner fund of inspiration is the wonder-worker who encourages all forms of social advance.

Psychology of the Primitive Attitude towards the Sacred.—We are on firmer ground when simply describing the phenomena of primitive religion than when seeking to account for these in terms of natural law—in whatever sense the conception of natural law be applicable to the facts of the mental life of man. One thing is certain, namely, that savages stand on virtually one footing with the civilized as regards the type of explanation appropriate to their beliefs and practices. We have no right to refer to "instincts" in the case of primitive man, any more at any rate than we have in our own case. A child of civilized parents brought up from the first amongst savages is a savage, neither more nor less. Though race may count for something in the matter of mental endowment—and at least it would seem to involve differences in weight of brain—it clearly counts for much less than does *milieu*, to wit, that social environment of ideas and institutions which depends so largely for its effectiveness on mechanical means of tradition, such as the art of writing. The outstanding feature of the mental life of savages known to psychologists as "primitive credulity" is doubtless chiefly due to sheer want of diversity of suggestiveness in their intellectual surroundings. Their notions stick fast because there are no competing notions to dislodge them. Society suffers a sort of perpetual obsession, and remains self-hypnotized as it were within a magic circle of traditional views. A rigid orthodoxy is sustained by means of purblind imitation assisted by no little persecution. Such changes as occur come about, not in consequence of a new direction taken by conscious policy, but rather in the way that fashions in dress alter amongst ourselves, by subconscious, hardly purposive drifting. The crowd rather than the individual is the thinking unit. A proof is the mysterious rapid extinction of savages the moment that their group-life is broken up; they are individually so many lost sheep, without self-reliance or initiative. And the thinking power of a crowd—is it, a mob, not a deliberative assembly—is of a very low order, emotion of a "panicky" type driving it hither and thither like a rudderless ship. However, as the students of mob-psychology have shown, every crowd tends to have its *meneur*, its mob-leader, the man who sets the cheering or starts the running-away. So too, then, with the primitive society. Grossly ignorant of all that fails outside "the daily round, the common task," they are full of panicky fears in regard to this unknown, and the primary attitude of society towards it is sheer avoidance, taboo. But the mysterious has another face. To the mob the mob-leader is mysterious in his power of bringing luck and salvation; to himself also he is a wonder, since he wills, and lo! things happen accordingly. He has

mana, power, and by means of this *mana*, felt inwardly by himself, acknowledged by his fellows, he stems the social impulse to run away from a mystery. Not without nervous dread—witness the special taboo to which the leader of society is subject—he draws near and strives to constrain, conciliate or cajole the awful forces with which the life of the group is set about. He enters the Holy of Holies; the rest remain without, and are more than half afraid of their mediator. In short, from the standpoint of lay society, the manipulator of the sacred is himself sacred, and shares in all the associations of sacredness. An anthropomorphism which is specifically a "magomorphism" renders the sacred powers increasingly one with the governing element in society, and religion assumes an ethico-political character, whilst correspondingly authority and law are invested with a deeper meaning.

The Abuse of the Sacred.—Lest our picture of primitive religion appear too brightly coloured, a word must be said on the perversions to which the exploitation of the sacred is liable. Envy, malice and uncharitableness are found in primitive society, as elsewhere, and in their behoof the mystic forces are not infrequently unloosed by those who know how to do so. To use the sacred to the detriment of the community, as does, for instance, the expert who casts a spell, or utters a prayer, to his neighbour's hurt, is what primitive society understands by magic (cf. *arunquilha*, above), and anthropology has no business to attach any other meaning to the word if it undertakes to interpret the primitive point of view. On the other hand, if those in authority perpetrate in the name of what their society holds sacred, and therefore with its full approval, acts that to the modern mind are cruel, silly or revolting, it is bad science and bad ethics to speak of vice and degradation, unless it can be shown that the community in which these things occur is thereby brought nearer to elimination in the struggle for existence. As a matter of fact, the earlier and more democratic types of primitive society, uncontaminated by our civilization, do not present many features to which the modern conscience can take exception, but display rather the edifying spectacle of religious brotherhoods encouraging themselves by mystical communion to common effort. With the evolution of rank, however, and the concentration of magico-religious power in the hands of certain orders, there is less solidarity and more individualism, or at all events more opportunity for sectional interests to be pursued at other than critical times; whereupon fraud and violence are apt to infect religion. Indeed, as the history of the higher religions shows, religion tends in the end to break away from secular government with its aristocratic traditions, and to revert to the more democratic spirit of the primitive age, having by now obtained a clearer consciousness of its purpose, yet nevertheless clinging to the inveterate forms of human ritual as still adequate to symbolize the consecration of life—the quickening of the will to face life earnestly.

BIBLIOGRAPHY.—The number of works dealing with primitive religion is endless. The English reader who is more or less new to the subject is recommended to begin with E. B. Tylor, *Primitive Culture* (4th ed., Lond. 1903), and then to proceed to J. G. Frazer, *The Golden Bough* (2nd ed., Lond. 1906). The later author's *Lectures on the Early History of the Kingship* (Lond. 1905) may also be consulted. Only second in importance to the above are W. Robertson Smith, *Lectures on the Religion of the Semites* (2nd ed., Lond. 1904); A. Lang, *Myth, Ritual and Religion* (2nd ed., Lond. 1899), and *Magic and Religion* (Lond. 1902); E. S. Hartland, *The Legend of Perseus* (Lond. 1894-1896); F. B. Jevons, *An Introduction to the History of Religion* (2nd ed., 1902); E. Crawley, *The Mystic Rose* (Lond. 1902), and *The Tree of Life* (Lond. 1905). The two last-mentioned works perhaps most nearly represent the views taken in the text, which are also developed by the present writer in "Pre-Animistic Religion," *Folk-Lore* xi. (1900), "From Spell to Prayer," *Folk-Lore*, xv. (1904), and "Is Taboo a Negative Magic?" *Anthropological Essays presented to E. B. Tylor* (1907); L. R. Farnell, *The Evolution of the Early History of the Kingship* (Lond. 1905). Other writers owe something to Goulet d'Alviella, *Hibbert Lectures* (Lond. 1891), and more to H. Hubert and M. Mauss, "Essai sur la nature et la fonction du sacrifice," *L'Année sociologique*, ii., and "Esquisse d'une théorie générale de la magie," *ibid.* vii. If the reader wish to keep pace with the output of literature on this vast subject, he will find *L'Année sociologique* (1896 onwards) a wonderfully complete bibliographical guide.

Side by side with works of general theory, first-hand authorities should be freely used. To make a selection from these is not easy, but the following at least are very important: R. H. Codrington, *The Melanesians* (Oxford, 1891); W. B. Spencer and F. J. Gillen, *The Native Tribes of Central Australia* (Lond. 1899); *The Northern Tribes of Central Australia* (Lond. 1904); A. W. Howitt, *The Native Tribes of South-Eastern Australia* (Lond. 1924); A. C. Haddon, *Reports of the Cambridge Anthropological Expedition to Torres Straits* (Cambridge, 1904, vol. v.); A. B. Ellis, *The Tshi-Speaking Peoples of the Gold Coast* (Lond. 1897); *The Ewe-Speaking Peoples of the Slave Coast* (Lond. 1890); *The Yoruba-Speaking Peoples of the Slave Coast* (Lond. 1894); Miss M. H. Kingsley, *Travels in West Africa* (Lond. 1898), and *West African Studies* (Lond. 1899); A. C. Hollis, *The Masai* (1908); W. Crooke, *The North-West Provinces of India* (Lond. 1897); W. H. R. Rivers, *The Todas* (1906). An immense amount of valuable evidence is to be obtained in the *Reports of the Bureau of Ethnology*, Smithsonian Institution, Washington. See Nos. 2, 5, 6, 7, 8, 9, 11, 13, 14, 15, 16, 18, 19, 21, 22, 23, and specially J. O. Dorsey, *A Study of Siouan Cults*, in No. 11; A. C. Fletcher, *The Hako*, in No. 22; and M. C. Stevenson, *The Zuñi Indians*, in No. 23. Though dealing primarily with a more advanced culture, J. J. M. de Groot, *The Religious System of China* (1892-1901), will be found to throw much light on primitive ideas. Finally let it be repeated that there is offered here no more than an introductory course of standard authorities suitable for the English reader. (R. R. M.)

B. THE HIGHER RELIGIONS

Various phenomena associated with the religions of the lower culture will be found discussed in the articles on ANIMISM; FETISHISM; MAGIC; MYTHOLOGY; PRAYER; RITUAL; SACRIFICE; and TOTEMISM. In this article religions are treated from the point of view of morphology, and no attempt can be made in the allotted limits to connect them with the phases of ritual, sociological or ethical development. See the separate articles on each religious system, and the separate headings for different forms of ritual.

1. *Developments of Animism.*—Animism is not, indeed, itself a religion; it is rather a primitive kind of philosophy which provides the intellectual form for the interpretation alike of Man and of Nature. It implies that the first great step has been taken for distinguishing between the material objects—whether the conscious body, or the rocks, trees and animals—and the powers that act in or through them. The Zuñis of New Mexico, U.S.A., supposed "the sun, moon and stars, the sky, earth and sea, in all their phenomena and elements, and all inanimate objects as well as plants, animals and men, to belong to one great system of all-conscious and interrelated life, in which the degrees of relationship seem to be determined largely, if not wholly, by the degrees of resemblance."¹ If the earliest conception is that of an obscure undifferentiated animation (*panvitalism*), the analysis of the human person into body and spirit with the corresponding doctrine of "object-souls" (e.g. the *torñai* or "invisible rulers" of every object among the Eskimo)² constitutes an important development. Matter is no longer animated or self-acting; it is subject to the will of an agent which can enter or quit it, perhaps at its own pleasure, perhaps at the compulsion of another. The transition has usually been effected ages before the higher religions come into view; but it has left innumerable traces in language and custom. Thus the Vedic hymns, which exhibit the deposits of so many stages of thought, are founded ultimately on the conception of the animation of nature. The objects of the visible world are themselves mighty to hurt or help. The springs and rivers, the wind, the sun, fire, the Earth-Mother, the Sky-Father, are all active powers. The animals, domesticated or wild, like the horse or cow, the guardian dog, the bird of omen, naturally share the same life, and are approached with the same invocation. The sacred energy is also discerned in the ritual implements, in the stones for squeezing the soma-juice, and the sacrificial post to which animals were bound; nay, it was even recognized in fabricated products like the plough (the "tearer" or "divider"), the

¹ F. H. Cushing, on "Zuñi Fetiches" in *Second Annual Report of the Bureau of Ethnology*, Washington, 1883, p. 9.

² Dr. Franz Boas, in the *Sixth Annual Report of the Bureau of Ethnology*, 1888, p. 591.

war-car, the drum, quiver, bow and axe. The Earth-Mother and Sky-Father are to be found again and again in religions, at various stages of development, as co-ordinating conceptions which comprehend the universe.¹ Sometimes one is more prominent, sometimes the other. In many cases the Sky has been already resolved into the visible firmament and its lord and owner, like the Yoruban Olurun or the Finnic Ukko. The consort of Ukko is *Maan-emi*, "mother of the earth," or *maan emäntä*, "mistress of the earth." But the rare expression *maan-emi*, "Mother-earth," still used in the ancient lays,² points to the older type of belief in the animation of the productive soil. So the Peruvians designated the Earth as Pachamama, "mother of (all) things." In Egypt the relation was curiously reversed; the earth-god Keb was the husband of Nut, the sky, represented sometimes as a woman, overarching the earth and supported on hands and feet, sometimes as a gigantic cow, upheld on the outstretched hands of Shu, the atmosphere.³ When earth and sky were still unseparated, Shu thrust himself between them and raised Nut to the heights. So in the New Zealand myth, Rangī and Papa, Sky and Earth, who once clave together in the darkness, were rent asunder by the forest-god Tane-mahuta, who forced up the sky far above him.⁴ The most elaborate presentment of this mode of thought is to be seen in the organized animism of the ancient state religion of China, where the supreme power is lodged in the living sky (Tien).⁵ Tien was originally the actual firmament. In the *Shi-King* it is addressed in prayer as "great and wide," as "vast and distant"; it is even "blue" (Pt. II, v. 6, 5). So it is the ancestor of all things; and Heaven and Earth are the father and mother of the world. From the imperial point of view the sky bore the name of Ti, "ruler," or Shang Ti, "supreme ruler" (emperor); and later commentators readily took advantage of this to discriminate between the visible expanse and the indwelling spirit, producing a kind of Theism. But the older conception still holds its own. "Why" (says Edkins, *Religion in China*, 95), "they have been often asked, should you speak of those things which are dead matter, fashioned from nothing by the hand of God, as living beings? And why not? they have replied. The Sky pours down rain and sunshine; the Earth produces corn and grass. We see them in perpetual movement, and we therefore say that they are living." *Tien Ti, Fu Mu*, "Heaven and Earth, Father and Mother," are conjoined in common speech, and are the supreme objects of imperial worship. The great altar to Heaven, round in shape like the circuit of the sky, and white as the symbol of the light principle (Yang), stands in the southern suburb of Peking in the direction of light and heat. The altar to the Earth is dark and square, on the north side of the city, the region of *yin*, the principle of cold and gloom. Associated with the Sky are tablets to the sun and moon, the seven stars of the Great Bear, the five planets, the twenty-eight constellations, and all the stars of heaven; tablets to clouds, rain, wind and thunder being placed next to that of the moon. With the Earth are grouped the tablets to the five lofty Mountains, the three Hills of perpetual peace and the four Seas, the five celebrated Mountains and the four great Rivers.⁶ The ancient ritual (*Chow Li*) carefully graded the right of sacrifice from the viceroys of provinces down to the humblest district-superintendent who offered to the spirits of his district, the hills, lakes and grains. With these spirits ranged in feudal order in two vast groups beneath Heaven and Earth is associated a third class, those of human beings. They are designated by the same name, *shin*; and they are in-

extricably mingled with the operations of nature. So in the Vedic hymns the departed "Fathers" inhabit the three zones of earth, air and sky; they are invoked with the streams and mountains of this lower earth, as well as with the dawns and the sky itself; even cosmic functions are ascribed to them; and they adorn the heaven with stars. The Chinese conception of the *Shin* under the name of *Skin-to* (Chinese *tao*) or "spirits'-way" profoundly influenced Japanese thought from the 6th century A.D. onwards; and the great Shinto revival of the 18th century brought the doctrine again into prominence. The Japanese *Kami* are the "higher" powers, the *superi*, conceived as acting through nature on the one hand and government on the other. Just as the emperor is *kami*, and provincial officers of rank, so also mountains, rivers, the sea, thunder, winds, and even animals like the tiger, wolf or fox, are all *kami*.⁷ The spirits of the dead also become *kami*, of varying character and position; some reside in the temples built in their honour; some hover near their tombs; but they are constantly active, mingling in the vast multitude of agencies which makes every event in the universe, in the language of Motowori (1730-1801), the act of the *Kami*. They direct the changing seasons, the wind and the rain; and the good and bad fortunes of individuals, families and states are due to them.⁸ Everywhere from birth to death the entire life of man is encompassed and guided by the *Kami*, which are sometimes reckoned at 8,000,000 in number.

2. *Transition to Polytheism*.—In such ways does the Polydaemonism of early faith survive in the modern practice of religion. The process of enrolling the spirits of the dead in the ranks of what may be more or less definitely called "gods" may be seen in the popular usages of India at the present day, or traced in the pages of the *Peking Gazette* under the direction of the Board of Rites, one of the most ancient branches of Chinese administration. Whether the higher polytheisms were produced in this fashion out of the cultus of the dead, may, however, be doubted. Many influences have doubtless contributed, and different races have followed different lines of development. No definite succession like the series of ages marked by the use of stone, bronze and iron can be clearly marked. But there must always have been some correspondence between the stages of social advance (or, in certain cases, of degeneration) and the religious interpretation of the world. The formation of clans and tribes, the transitions from the hunting to the pastoral life, and from the pastoral to the agricultural—the struggle with forest and swamp, the clearings for settlement, the protection of the dwelling-place, the safety of flocks and herds, the production of corn,—the migration of peoples, the founding of colonies, the processes of conquest, fusion, and political union—have all reacted on the elaboration of the higher polytheisms, before bards and poets, priesthoods and theological speculators, began to systematize and regulate the relations of the gods. Certain phases of thought may be more or less clearly indicated; certain elements of race, of local condition, of foreign contact, may be distinguished with more or less historic probability; but no single key can explain all the wide diversity of phenomena. Broadly speaking it may be said that a distinction may be drawn between "spirits" and "gods," but it is a distinction of degree rather than of kind, obvious enough at the upper end, yet shading off into manifold varieties of resemblance in the lower forms. Some writers only recognize friendly agencies as gods; but destructive powers like the volcano, or the lords of the underworld, cannot be regarded as the protectors of the life of man, yet they seem in many mythologies to attain the full personalised stature of gods with definite names. Early Greek religion recognized a class of gods of Aversion and Riddance, *ἀποτροφαὶ* and *ἀπορομαῖα*. Neither the spirit nor the god is conceived as

¹ The Japanese name is *Ame-tsuchi*, "heaven and earth," a translation of the Chinese *ten-chi*, Aston, *Shinto* (1905), p. 35.

² Castrén, *Finnische Mythologie*, p. 86.

³ Erman, *Handbook of Egyptian Religion* (1907), pp. 8, 12.

⁴ Sir George Grey, *Polynesian Mythology* (1855), pp. 1-4.

⁵ The English "Heaven" has acquired a quasi-personal meaning, and is usually employed as its equivalent, but, like the Jewish use (e.g. Luke xv. 18), tends to carry too definite religious associations with it.

⁶ Blodget, on "The Chinese Worship of Heaven and Earth," *Journ. of the American Oriental Society*, xx, p. 58 ff.

⁷ So the epithet 'El might be applied in Hebrew to men of might, to lofty cedars, or mountains of unusual height, as well as to the Supreme Being.

⁸ See E. M. Satow, "Revival of Pure Shinto," *Trans. As. Soc. of Japan*, vol. iii, pt. 1 (1875), Appendix, p. 26.

immaterial. They can take food, though the crudest form of this belief soon passes into the more refined notion that they consume the impalpable essence of the meals provided for them. The ancient Indian ritual for the sacrifice to the Fathers required the officiating priest to turn away with bated breath that he might not see the spirits engaged upon the rice-balls laid out for them. The elastic impalpable stuff of the spirit-body is apparently capable of compression or expansion, just as Athena can transform herself into a bird. The spirits can pass swiftly through the air or the water; they can enter the stone or the tree, the animal or the man. The spirit-land of the Ibo on the Lower Niger had its rivers, forests or hills, its towns and roads, as upon earth; the spirits of the Mordvinian mythology, created by Chkai, not only resembled men, they even possessed the faculty of reproduction by multiplication.² The Finns ascribed a *haltia* or genius to each object, which could, however, guard other individuals of the same species. This is the beginning of the species-god, and implies a step of thought comparable to the production in language of general terms. These protecting spirits were free beings, having form and shape, but not individualized; while above them rose the higher deities like the forest-god Tapio and his maiden Hillervo, protectress of heads, or Ahto the water-god who gradually took the place of Vesi, the actual element originally conceived as itself divine, and ruled over the spirits of lakes and rivers, wells and springs.³ The Finns came to apply to the upper gods the term *Yumala* which originally denoted the living sky; the Samoyedes made the same use of Num, and the Mongols of Tengri.⁴ Above the innumerable *wongs* of the Gold Coast rose Nyongmo, the Sky-god, giver of the sunshine and the rain. The Yoruba-speaking peoples generalized the spirits of mountain and land into *Oke*, god of heights; and the multitude of local sea-gods on the western half of the slave coast was fused into one god of the Ocean, *Olokun*.⁵ The Babylonian theology recognized a *Zi* or "spirit" in both men and gods, somewhat resembling the Egyptian "double" or *ka*; spirits are classed as spirits of heaven and spirits of earth; but the original identity of gods and spirits may be inferred from the fact that the same sign stands before the names of both.⁶ Out of the vast mass of undifferentiated powers certain functional deities appear; and the Kami of Japan to-day who preside over the guilds and crafts of industry and agriculture, over the trees and grasses of the field, the operations of the household, and even the kitchen-range, the sauceman, the rice-pot, the well, the garden, the scarecrow and the privy, have their counterparts in the lists of ancient Rome, the *indigumenta* over whose contents Tertullian and Augustine made merry. The child was reared under the superintendence of *Educa* and *Patina*. *Aheona* and *Adeona* taught him to go out and in. *Cuba* guarded him when he was old enough to exchange a cradle for a bed. *Ossi-paga* strengthened his bones; *Levāna* helped him to get up, and *Statina* to stand.⁷ There were powers protecting the threshold, the door and the hinge; and the duties of the house, the farm, the mill, had each its appointed guardian. But such powers were hardly persons. The settler who went into the woods might know neither the name nor the sex of the indwelling *numen*; "si deus si dea," "sive mas sive femina," ran the old formulae.⁸ So the Baals

of the Semitic peoples constituted a group of powers fertilizing the land with water-springs, the givers of corn and wine and oil, out of which under conditions of superior political development a high-god like the Tyrian Baal, the majestic City-King, might be evolved. The Celts who saw the world peopled with the spirits of trees and animals, rocks, mountains, springs and rivers, grouped them in classes like the *Dervonnae* (oak-spirits), the *Niskai* (water-spirits), the *Proximae*, the *Matronae* (earth-goddesses)⁹ and the like. Below the small band of Teutonic divinities were the elves of forest and field, the water-elves or nixes and spirits of house and home. The Vedic deities of the nobler sort, the shining *devas*, the *asuras* (the "breathers" or living, perhaps to be identified with the Scandinavian *asir*) rose above a vast multitude of demonic powers, many of them doubtless derived from the local customs and beliefs of the native races whom the immigrant Aryans subdued. In the earliest literary record of Greek religion Homer distinguishes between the *θεός* and the *δαίμων*, the personalized god and the *numen* or divine power. In Homer the element of time is definitely recognized. The gods are the "Immortals." They are born, and their parentage is known, but they do not die. Zeus is not self-existent in the sense in which the Indian *Brahmā* is *svayambhū*, but certain questions have been by implication asked and answered, which the demonology of the savage has not yet raised. But behind Homer stretches the dim scene of pre-Hellenic religion, and the conflict of elements "Pelagic," oriental and Hellenic, out of which the Homeric religion emerged; and beneath the Homeric religion how many features of the religion of ghosts and nature-spirits survived in popular usage and the lower cults!¹⁰ When Herodotus (ii. 53) tried to trace the origin of the beliefs around him, he found his way back to an age before Hesiod or Homer, when the gods were nameless. To that age the traditions preserved at Dodona bore witness; and the designations of special groups like the *θεοί μέγιστοι*, *θεοί μελλίχιοι*, *θεοί πραξίδικαι*, or, possibly, the *Υεράσιοι*, *Γοδασίαι* (*θεοί σεμναί*) of Athens, point to a mode of thought when the divine Powers were not definitely individualized. They are just at the point of transition from the ranks of spirits to the higher classes of the gods. As they had no names, they had no relations. Nor had any images yet been made of them. They were associated with hallowed trees, with sacred stones and pillars, out of which came the square rough-hewn *Hermæ* which were anointed with oil like the sacred stone attributed by legend to Jacob at Bethel.¹¹ By what processes the Hellenic immigration introduced new deities and the Greek pantheon was slowly formed, can only be conjecturally traced with the help of archaeology. But Herodotus and Aeschylus were well aware that the religion of Greece had not been uniformly the same; and the gods whom they knew had been developed out of intercourse with other peoples and the succession of races in the obscure and distant past.

3. *Polytheism*.—The lower and unprogressive religions practically remain in the polydeistic stage, though not without occasionally feeling the stimulus of contact with higher faiths, like some of the West African peoples in the presence of the Mahomedan advance. Among the more progressive races, on the other hand, continual processes of elevation and decline may be observed, and the activities of the greater gods are constantly being enriched with new functions. Personal or social experiences of the satisfaction of some desire or escape from some danger are referred to some particular deity. Elements of race-consciousness help to shape the outlook on nature or life; and slight differences of linguistic use in the coining of descriptive terms sometimes lead to the multiplication of divine forms. Exacter observation of nature; closer attention to its contrasts of life and death, or light and darkness, or male and

⁹ Cf. the groups of "Mothers" in modern India, of various origins, Crooke, *Popular Religion and Folklore* (2), I, 111.

¹⁰ Cf. Andrew Lang, *Myth, Ritual and Religion*; and Miss Harrison, *Prolegomena to the Study of Greek Religion*.

¹¹ Cf. A. J. Evans, on *The Mesopotamian Tree and Pillar Cult* (1901), and Sir W. M. Ramsay, "Religion of Greece and Asia Minor," in Hastings' *Dict. of the Bible*, extra vol.

¹ Leonard, *The Lower Niger and its Tribes* (1906), p. 186.

² Mainot, "Les Restes de la mythologie mordvine," *Journal de la Soc. Finno-Ougrienne*, v. (1889), p. 102.

³ Castrén, *Finn. Mythol.*, pp. 92 ff., 72.

⁴ *Ibid.*, pp. 7, 14, 17, 24.

⁵ A. B. Ellis, *The Yoruba-speaking Peoples* (1894), p. 289.

⁶ Jastrow, *Religion of Babylonia and Assyria* (1898), p. 181. The Zulus applied the term *á-há* "All-Life" or "the Beings" to all supernatural beings, men, animals, plants, and many objects in nature regarded as personal existences, as well as to the higher anthropomorphic powers known as "Finishers or Makers of the Paths of Life," *Report of Bureau of Ethnol.* (1883), p. 11. On the distinction between "gods" and "spirits," cf. Ed. Meyer, *Gesch. d. Aethiopiens*, 2nd ed., Band I, erste Hefte (1907), p. 97 ff.

⁷ Tert. *De Anima*, 39 Aug. *De Civ. Dei*, iv. 11, 8c.

⁸ On the *Dei Certi* and the *Dei Incerti*, see von Domaszewski in the *Archiv für Religionswiss.*, x. (1907), pp. 1-17.

female; the distinction between its permanent objects, and its occasional or recurring operations; the recognition that behind sudden manifestations of power, like the thunder-storm, there are steady forces and continuous cosmic agencies at work—lead to the gradual rise of the higher deities. And from the social side the development of law, the influence of city life, the formation of priesthoods, the connexion of particular deities with the fortunes of dynasties or the vicissitudes of nations, the processes of migration, of conquest and political fusion, the deportations of vanquished peoples, even the sale of slaves to distant lands and the growth of trade and travel, all contribute to the processes which expand and modify different pantheons, and determine the importance of particular deities. In the midst of the bewildering variety, where all types co-exist together and act and react on each other, it is impossible to do more than point out some obvious groups receiving their special forms chiefly from the side (1) of nature, (2) of human life, and (3) from moral or theological speculation. Divine persons, objects or powers, connected with ritual, are not here considered, such as the Brahman priests who claimed to be *manushyadevoh* (human-gods), or the sacred soma-juice which grew by strange analogies into a mysterious element, linking together heaven and earth.

I. On the side of Nature the lowest rank (1) seems to belong to what Usener has designated "momentary" or "occasional" gods.¹ They embody for the time being a vague consciousness of the divine, which is concentrated for some single act into an outward object, like a warrior's spear or the thunderbolt,² or the last sheaf of corn into which the Corn-Mother has been driven.³ (2) Above these, to use again Usener's nomenclature,⁴ are the "special" or "functional" gods, "departmental gods," as Mr Lang has called them. Such were some of the deities of the *Indigumenta* already compared with the Japanese Kami. Among them, for example, were twelve deities of ploughing and harvest operations, who were invoked with Tellus and Ceres. (3) Another class may be seen in the species-deities previously named; the Samoan gods which could become incarnate as a heron or an owl, did not die with particular birds. A dead owl was not a dead god; he yet lived in all other owls.⁵ (4) The worship of trees, plants and animals is a particular phase of the wider series of nature-cults, only named here because of its frequency and its obvious survivals in some of the higher polytheisms, where, as in Egypt, the Apis bulls were worshipped; or where, as in Mesopotamia, the great gods are partly symbolized by animal forms; or where, as in Israel, Yahweh might be represented as a bull; or where, as in Greece, such epithets as Dendrites and Endendros preserved traces of the association of Dionysus and Zeus with vegetation; while sacred animals like the serpents of Aesculapius were preserved in the temples.⁶ (5) The higher elemental gods sometimes, like the sun, as the Indian Sūrya, the Egyptian Rē, the Babylonian Shamash (Samas), the Greek Helios, retain their distinct connexion with the visible object. It was naturally more easy for a relatively spiritual worship to gather round a god whose name did not immediately suggest a familiar body. No one ever thought of confessing sin, for instance, to a river. But the daily survey of the sun (occasionally also the function of the moon as measurer of time), together with his importance for life, secured him a high moral rank; and Rē, united with the Theban Ammon, became (under the New Empire) the leading god of Egypt for a thousand years. "He who hath made all, the sole One with many hands." Other deities, like Zeus, rise to the head of a monarchical polytheism, in which their physical base is almost,

if not quite, forgotten in cosmic and moral grandeur. The gods are often arranged in groups, three, seven and twelve being frequent numbers. Egyptian summaries recognized gods in the sky, on earth and in the water; gods of the north and south, the east and west, gods of the field and the cities. Indian theologians classified them in three zones, earth, air and sky. Babylonian speculation embraced the world in a triad of divine powers. Anu the god of heaven, Bel of earth and Ea of the deep; and these became the symbols of the order of nature, the divine embodiments of physical law.⁷ Sometimes the number three is reached by the distribution of the universe into sky, earth and underworld, and the gods of death claim their place as the rulers of the world to come. Among these deities all kinds of relationships are displayed; consorts must be provided for the unwedded, and the family conception, as distinct from the regal, presents a divine father, mother and child. The Ibani in Southern Nigeria recognized Adum the father-god, Okoba the mother-god and Eberobo the son-god.⁸ In Egypt, Osiris, Isis and Horus proved an influential type. Perhaps at a relatively earlier stage maternity alone is emphatically asserted, as in the figure of the Cretan Mother, productive without distinctly sexual character.⁹ Or, again, maternity disappears, while parenthood survives, and causation is embodied in a universal "Father of all that are and are to be," like the Indian Brahmā in the days of Gotama the Buddha.¹⁰

II. On the human side polytheism receives fresh groups in connexion with the development of social institutions and national feeling. (1) In the family the hearth-fire is the scene of the protecting care of deity; the gods of the household watch over its welfare. Each Roman householder had his *Genius*, the women their *Juvenes*. These stood at a higher level than the "occasional gods," having permanent functions of supervision. (2) From the household a series of steps embodied the divine power in higher forms for social and political ends. Hestia presided over cities; there was even a common Hestia for all Greece. The *fravashi* or ideal type, the genius of both men and gods in the Zend Avesta (possibly connected originally with the cultus of the dead¹¹), rises in successive ranks from the worshipper's own person through the household, the village, the district and the province, up to the throne of Ahura himself.¹² The Chinese Shin were similarly organized; so (less elaborately) were the Japanese *Kami*; and the Roman *lares*, the old local land-gods, found their highest co-ordinating term in the *Lares Augusti*, just as the Genius was extended to the legion and the colony, and finally to Rome itself. (3) In the case of national deities the tie between god and people is peculiarly close, as when Yahweh of Israel is pitted against Chemosh of Ammon (Judges xi. 24). The great gods of Greece, in their functions as "saviours" and city-guardians, acquire new moral characters, and become really different gods, though they retain the old names. Ashur rises into majestic sovereignty as the "Ruler of all the gods," the supreme religious form of Assyrian sway: when the empire falls beneath the revived power of Babylon, he fades away and disappears. (4) The earthly counterpart of the heavenly monarch is the divine king, who may be traced back in Egypt, for example, to the remotest antiquity,¹³ and who survives to-day among the civilized powers in the emperor of Japan (anciently *Arahitō-gami*, "incarnate Kami"). "To the end of time,"

¹ Jastrow, *Rel. of Babylonia*, p. 432.

² Leonard, *The Lower Niger and its Tribes*, p. 354.

³ Cf. Farnell, *Cults of Greece*, iii. 295.

⁴ *Digba Nibāya*, i. 18.

⁵ This is denied by Tiele, *Religion in Altarium*, tr. Gehrlich, ii. (1898), p. 259.

⁶ Cf. *Yasna*, lxxi. 18; *S.B.E.* xxxi. p. 331; and Söderblom's essay in the *Rev. de Théol. des religions*, xxxix. (1899), pp. 229, 373.

⁷ Hirata's morning prayer in the last century included 800 myriads of celestial *kami*, 800 myriads of ancestral *kami*, the 1500 myriads to whom are consecrated the great and small temples in all provinces, all islands, and all places of the great land of eight islands, &c.

⁸ Moret, *Du caractère religieux de la royauté pharaonique* (1902). For instances in the lower culture see Frazer, *Golden Bough* (2), i. 140 ff.

¹ *Götternamen*, Bonn, 1896, p. 279 ff. But cp. Dr Farnell's essay "On the Place of the Sonder-Götter in Greek Polytheism," in *Anthropological Essays presented to Edward Burnett Tylor* (1907), p. 81.

² *Ibid.* pp. 285, 286.

³ Frazer, *The Golden Bough* (2), ii. 170-1.

⁴ *Götternamen*, p. 75.

⁵ Turner, *Samoā*, 1884, p. 21.

⁶ Cf. de Visser, *Die nicht Menschen-Gestaltigen Götter der Griechen* (Leiden, 1903).

said Motowori (18th century), "the Mikado is the child of the Sun-goddess." (5) The dead hero (historical or mythic) signalizes his power by gracious saving acts; and Heracles, Asclepius, Amphiraraus, and others pass into the ranks of the gods, which are thus continually recruited from below.

III. A third great group rises out of the sentiments and affections of man, or the moral energies which he sees working in human life. (1) The Vedic *Craddhā*, "faith," the Greek *Metameleia*, "repentance,"¹ the Latin *Spes*, and a band of other figures, represent the dispositions of the heart; Nemesis and Nikē and Concordia and their kin belong to a somewhat different sphere, the divine powers avenging, conquering, harmonizing the counterparts of the "departmental" gods in the field of moral agencies. (2) Over these theological speculation erects a few lofty and impressive forms; sometimes below the highest, like Vohu Mano, "the Good Mind" of Ahura Mazda; or the Bodhisattva Avalokiteśvara, who vowed not to enter into final peace till every creature had received the saving truth; sometimes supreme, like Brahmā or Prajāpati ("lord of creatures") in the early Brahmanic theology; or Ādi Buddha, or the Zervan Akarana, "boundless time," of a kind of Persian gnosticism; or the *Θεός ἄβυσσος* whose worship appears among other syncretistic cults of the Roman empire.

4. *The Order of Nature.*—Polytheism is here on the way to monotheism, and this tendency receives significant support from the recognition of an order in nature which is the ground and framework of social ethics. Not only does a sky-god like Varuna, or a sun-god like the Babylonian Shamash, survey all human things, and take cognizance of the evil-doer, but the daily course of the world is itself the expression of an intellectual and moral power. In the Chinese combination of Heaven and Earth as the parents and nourishers of all things, the energy and action lie with Tien, Earth being docile and receptive. Tien is intelligent and all-observing, and its "sincerity" or steadfastness, displayed in the courses of the sun and moon and the succession of the seasons, becomes the basis of right human conduct, personal and social. The "way" of Heaven, the "course" of Heaven, the "lessons" of Heaven, the law or "decree" (*ming*) of Heaven, are constantly cited as the pattern for the emperor and his subjects. This conception is even reflected in human nature: "Heaven in giving birth to the multitude of the people, to every faculty and relationship affixed its laws" (*Shi King*, III. iii. 6; cf. IV. iii. 2, tr. Legge), and the "Grand Unity" forms the source of all moral order (*Li Ki*, in *Sacred Books of the East*, xxvii. p. 387). Indian thought presented this Order in a semi-personal form. The great elemental gods imposed their laws (*dhāman*, *dharman*, *vṛata*) on the visible objects of nature, the flow of rivers, the march of the heavenly bodies across the sky. But the idea of Law was generalized in the figure of *Rita* (what is "fitted" or "fixed"; or the "course" or "path" which is traversed), whose Zend equivalent *asha* shows that the conception had been reached before the separation of the Eastern Aryans produced the migrations into India and Iran.² In the *Rig Veda* the gods (even those of storm) are again and again described as "born from the *Rita*," or born in it, according to it, or of it. Even Heaven and Earth rejoice in the womb or lap of the *Rita*. In virtue of the mystic identity between the cosmic phenomena and sacrifice, *Rita* may be also viewed as the principle of the cultus; and from that sphere it passes into conduct and acquires the meaning of morality and is equated with what is "true." The fundamental idea remains the same in the Zend *Asha*, its philological counterpart, but it is applied with a difference. Its form is more personal, for *Asha* is one of the six Holy Immortals round the throne of Ahura Mazda (Auramazda). In the primeval conflict between the powers of good and evil, the Bounteous Spirit chose *Asha*, the Righteous Order which

knit the world together and maintained the stars.³ The intermediacy of the relation between Ahura and Asha is implied in the statements that Ahura created Asha and that he dwells in the paths which proceed from Asha; and when he created the inspired word of Reason, Asha consented with him in his deed. In its ritual form Asha becomes the principle of sacrifice, and hence of holiness, first ritual and then moral. Like *Rita*, it rises into an object of worship, and in its most exalted aspect (*Asha vahista*, the "best" Asha, most excellent righteousness) it is identified with Ahura himself, being fourth among his sacred names (*Ormazd Yashit*, § 7; *S.B.E.* xxiii. p. 25). Egyptian speculation, in like manner, impersonated the conceptions of physical and moral order as two sides of a fundamental unity in the goddess Maät. Derived from the verb *mā*, "to stretch out," her name denoted the ideas of right and rule, and covered the notions of order, law, justice and truth, which remained steadfast and unalterable. Mythologically she was the daughter (or the eye) of the sun-god Rē; but she became Lady of Heaven and Queen of Earth, and even Lady of the land of the West, the mysterious habitation of the dead. Each of the great gods was said to be lord or master of Maät; but from another point of view she "knew no lord or master," and the particular quality of deity was expressed in the phrase *anx em maät*, "living by Maät," which was applied to the gods of the physical world, the sun and moon, the days and hours, as well as to the divine king. She was solemnly offered by the sovereign to his god; and the deity replied by laying her within the heart of his worshipper "to manifest her everlastingly before the gods." So in the famous scene of the weighing of the soul, which first appears pictorially under the New Empire, she introduces the deceased before the forty-two assessors of the heavenly judge, Osiris, and presides over the scale in which his actions and life are weighed. From the zenith to the realm of the departed she is the "queen of all gods and goddesses."⁴ The Hellenic polytheism of Homer and Hesiod is already at work upon similar ideas, and a whole group of mythic personifications slowly rises into view representing different phases of the same fundamental conception. Themis (root *thē*=Sanskrit *dha*, as in *dhāman*) appears in Homer as the embodiment of what is fit or right;⁵ she convenes or dismisses assemblies, she even keeps order at the banquet of the gods. Next, Hesiod supplies a significant biography. She is the daughter of Ouranos and Gaia; and after Metis she becomes the bride of Zeus.⁶ Pindar describes her as born in a golden car from the primeval Oceanus, source of all things, to the sacred height of Olympus to be the consort of Zeus the saviour; and she bears the same august epithet, as the symbol of social justice and the refuge for the oppressed.⁷ Law was thus the spouse of the sovereign of the sky, but Aeschylus identified her with the Earth (worshipped at Athens as Gē-Themis), not only the kindly Mother, but the goddess who bound herself by fixed rules or laws of nature and life.⁸ For the cultus of the earth as the source of fertility was associated with the maintenance of the family, with the operations of agriculture and the social order of marriage. So Themis became the mother of the seasons; the regular sequence of blossom and fruit was her work; and Good Order, Justice and Peace were her offspring.⁹ By such conceptions the Hellenic polytheism was moralized; the physical character of the greater gods fell into the background, and the sculptor's art came to the aid of the poet by completely ending them with personality.

¹ *Yasna*, xxx. 5; *Sacred Books of the East*, xxxi. p. 30; cf. pp. 44, 51, 248.

² Cf. Renouf, *Hibbert Lectures*, p. 119; Brugsch, *Rel. und Mythol.*, p. 477; Wiedemann, *Ann. du Musée Guimet*, x. p. 561; Budge, *Gods of Egypt*, i. p. 416.

³ Cf. *Diōs Ōiawares*, Od. xvi. 403; cf. Apollo, *Hom. Hymn.* 394.

⁴ *Theog.* 135, 901.

⁵ *Fr.* 6, 7; *Ōl.* xviii. 29.

⁶ Farnell, however, supposes that Gē acquired the cult-appellative through her prophetic character (*Cults of the Greek States*, ii. p. 12). The union of Zeus and Themis is, then, a later equivalent of the marriage of Zeus and Earth (*ibid.*, p. 14).

⁷ Paus. v. 17; *Hes. Theog.* 901; Pindar, *Ōl.* xiii. 6; ix. 26.

¹ Worshipped at Argos. Usener, *Götternamen*, p. 366.

² Cf. Max Müller, *Lectures on the Origin and Growth of Religion* (Hibbert Lect., 1878), v., and the Vedic treatises of Ludwig, Bergaigne and Wallis.

5. *Transition to Monotheism.*—From the higher Polytheism an easy step leads to some form of Monotheism. The transition may be effected in various ways. Max Müller observed the Vedic poets addressing themselves to the several objects of their devotion; as if each occupied the field alone. Varuna or Indra was for the time being the only god within the worshipper's view; and to this mode of thought he gave the name Henotheism.¹ It obviously reappears elsewhere, as it is the natural attitude of prayer, and may be seen in the pious homage of the pilgrims to the Virgin of Loretto or Einsiedeln. Pfeleiderer employed the word to denote a relative monotheism like that of the early religion of Israel, whose teachers demanded that the nation should worship but one god, Yahweh, but did not deny the existence of other gods for other peoples. Yet once again the term has been applied to characterize a whole group of religions, like the Indo-Germanic, which are ultimately founded on the unity of the divine nature in a plurality of divine persons. A designation of such doubtful meaning it seems better (with Chantepie de la Saussaye) to abandon. But the unifying process may advance along different lines. The deities of different local centres may be identified; many such combinations took place in Egypt, and Isis in late days served to her votaries as the unitary principle which appeared in one figure after another of whole pantheons. Again, the gods may be viewed as a collective totality, like the "All-gods" of the Vedic poets, or as at Olympia where there was a "common altar for all the gods" (cf. the frequent Roman dedication in later days, "Jovi optimo maximo caeterisque dis immortalibus"). Or the relation between the inferior deities and the most exalted may be conceived politically and explained by Tertullian's formula, "Imperium penes unum, officia penes multos." One particular god may be eminent enough, like Zeus, to rise above all others, and supply cultivated thought with a name for the supreme power; and this may be strengthened by the national motive as in the case of Israel. Or philosophic theology may penetrate to an abstract conception of deity, like the Babylonian *'iluth*, or the Vedic *devatva* and *asuratva*; and some seer may have the courage and insight to formulate the principle that "the great *asuratva* of the *devas* is one" (R.V. iii. 55. 1). "The One with many names" was recognized alike in India and in Greece; "πολλῶν ὀνομάτων μορφή μία," says Aeschylus, almost in the words of the Vedic poet.² Historians have usually recognized only three monotheistic religions, Judaism, Christianity and Islam. The Christian apologists of the 2nd century, however, found plenty of testimony to their doctrine of the unity of God in the writings of Greek poets and philosophers; it was a commonplace in the revival under the Empire; and among the group of religions embraced under the name Buddhism more than one form must be ranked as monotheistic. The idealist philosophy of the Prajñā Paramitā in the system of the "Great Vehicle" declared that "every phenomenon is the manifestation of mind" (Beal, *Catena*, p. 303). In the "Lotus of the Good Law" (S.B.E. xxi.) the Buddha is the "Father of the World," "Self-born" or Uncreate (like the eternal Brahmā of the Hindu theology), the protector of all creatures, the Healer (Saviour) of the sickness of their sins. These types have reappeared in Japan. Nichiren taught a philosophical monism in the 13th century and this is the basis of a vigorous sect at the present day; and the "True Sect of the Pure Land," founded by his older contemporary Shinran, and now the most numerous, wealthy and powerful of the Buddhist denominations, has dropped the original Gotama altogether out of sight, and permits worship to Amida alone, the sublime figure of "Boundless Light," whose saving power is appropriated by faith. Here is a monotheism of a definite and clear-cut type, arising apparently by spontaneous development apart from any external impulse.³ On the other hand, the mono-

¹ Or Kathenotheism, a term which did not succeed in gaining permanent support. *Hibbert Lect.*, p. 271.

² R.V. i. 164. 46, "Men call him Indra, Mitra, Varuna, Agni. . . . Poets name variously, what is but one."

³ Cf. Carpenter, "Japanese Buddhism," in *Hibbert Journal*, April 1906, p. 522.

theism of Judaism was subject to serious qualifications. An exuberant demonology admitted all kinds of interfering causes in the field of human life. Above man on earth rose rank after rank of angels in the seven heavens. These were of course created, but they were in their turn the agents of the phenomena of nature, "the angels of the spirit of fire and the angels of the spirit of the winds, and the angels of the spirits of the clouds and of darkness and of snow and of hail and of hoarfrost, and the angels of the voices and of the thunder and of the lightning, and the angels of the spirits of cold and of heat, and of winter and of spring and of autumn and of summer" (*Jubilees*, tr. R. H. Charles, ii. 2). These powers are of a well-marked animistic type, and correspond to the Chinese Shin, save that they were not incorporated in the cultus. Higher in rank came various mediating forms, like Wisdom, Memra (the Word) or Shekinah (the Presence), more or less definitely personalized. Mahomedanism still recognizes innumerable *jinn* peopling the solitudes of the desert, and over the grave of the deceased saint a little mosque is built, and prayers are offered and miracles performed.⁴ Christianity has, in like manner, in the course of its long and eventful history, admitted numerous agencies within the sphere of superhuman causation. The Virgin, the angelic hierarchy, the saints, have received the believer's homage, and answered his petitions. Theology might draw subtle distinctions between different forms of devotion; but, tried by the comparisons of the anthropologist, the monotheism even of historical Christianity cannot be strictly maintained.

6. *Classification.*—In the panorama of religious development thus briefly sketched, the different stages constantly appear to shade off into one another, and any one of the higher seems to contain elements of all the rest. This is the great difficulty of classification. All religions, even the most conservative and traditional, are in constant flux, they either advance or decay. In these processes, which do not take place at equal rates in different cases, all kinds of survivals remain lodged, and embarrass every attempt to fix the place of specific religions in any general course of development. The theologian, the philosopher, the historian, have all tried their hands at distribution. (i.) The 18th-century divine who divided religions into True and False grimly remarked that the second chapter was much the longer of the two.⁵ The corresponding distinction into Natural and Revealed breaks down in view of the fact that revelation by dream and oracle, by inspired seer or divine teacher and law-giver, is a practically universal phenomenon in more or less distinctly defined forms. (ii.) Philosophy, in the person of Hegel, classified religion in a threefold form: (a) the religion of Nature, (b) the religion of Spiritual Individuality, (c) the Absolute Religion (Christianity).⁶ The subdivisions of this scheme have been long since abandoned, as the progress of knowledge rendered them untenable. K. F. A. Wuttke, however, adopted its fundamental idea⁷ and distinguished three periods or phases: (1) the objective, producing the religions of nature; (2) the subjective, God as comprehended in the individual mind; (3) God as Absolute Spirit. In the same way Dr Edward Caird⁸ recognizes three similar stages: (1) objective consciousness, the divine in nature; (2) self-consciousness, the divine in man (e.g. Judaism, Stoicism, and modern philosophy of the type of Kant); (3) God-consciousness, where God is above the contrast of subject and object, yet is revealed in both (Christianity). (iii.) On the historical side numerous bases have been suggested. (1) Max Müller proposed to group religions ethnologically by tests of language. This had the obvious advantage of lifting two great families into prominence, the Semitic and the Indo-Germanic. The Semitic peoples were closely bound together by common types of thought and civilization, and produced three of the leading religions of the world, Judaism, Christianity and Islam. But a glance at the table of Indo-Germanic religions

⁴ Cf. Goldziner, *Rev. de l'Hist. des Rel.* ii. 257; Weir, *The Shaikhs of Morocco* (1904).

⁵ Broughton, *Dict. of all Religions* (1745), preface.

⁶ *Philosophy of Religion* (Eng. trans.), i. p. 266.

⁷ *Geschichte des Heidenthums* (1852), i. p. 95.

⁸ *Evolution of Religion* (1893), lect. vii.

drawn up by Tiele (*Ency. Brit.*, 9th ed., vol. xx. p. 360) will show what diversified products are blended together. Why should philosophical Brahmanism, or the Buddhism which reacted against it, be associated with so undeveloped a form as the religion of the ancient Latin settlers in mid-Italy? And why, on the other hand, should the religions of the lower culture, which are practically of a common type, be separated genealogically into numerous independent families? (2) Whitney¹ found the most important distinction to lie between religions which were the collective product of the wisdom of the community, race-religions as they might be called, and those which proceeded from individual founders. But, as Tiele pointed out, the "individual" element cannot be eliminated from the "race-religion," where each myth has been first uttered, each rite first performed, by some single person. And the founder who enters history with an impressive personality can only do his work through the response made to him by the insight and feeling of his time. (3) Kuennen disengaged another characteristic, the scope and aim of any given religion; was it limited to a particular people, or could it be thrown open to the world? On this foundation the higher religions were classed as national or universal, the latter group being formerly supposed to include Buddhism, Christianity and Mahomedanism. Here, once more, the student is confronted with many qualifications. A missionary religion like Mithraism, which established itself all the way from Western Asia to the borders of Scotland, was certainly not "national." Judaism and Brahmanism both passed beyond the confines of race. The Confucian morality could be adopted without difficulty in Japan. In other words, there was either a definite tendency to expansion, or there was no impediment in the religion itself when circumstances promoted its transplantation. Further, there are elements of Islam, like the usages of the *hajj* (or pilgrimage to the sacred places at Mecca), the dryness of its official doctrine and the limitations of its real character as indicated in the Wahhabi revival, which so impair its apparent universalism that Kuennen found himself obliged to withdraw it from the highest rank of religions.² (4) Professor M. Jastrow, jun., starting from the relation of religion to life, distinguishes four groups, the religions of savages, the religions of primitive culture, the religions of advanced culture and the religions which emphasize as an ideal the coextensiveness of religion with life. It may, however, be doubted whether the fundamental assumption of such a scheme, viz. that in the life of the savage religion plays a comparatively small part, can be satisfactorily established. The evidence rather implies that, so far as the sanctions of religion affect the savage at all, they affect him with unusual force. In the absence of other competing interests his religious beliefs and duties occupy a much larger share of his attention than the votaries of many higher faiths bestow on theirs; and though his ethical range may be very limited, yet the total influence of his religion in determining for him what he may do and what he may not, brings the greater part of conduct under its control. The savage who finds himself encompassed by taboos which he dare not break, lives up to his religion with a faithfulness which many professing Christians fail to reach. (5) There remains a broad distinction between religions that are in the main founded on the relation of man to the powers of Nature, and those based on ethical ideas, which partly corresponds to the philosophical division already cited. This enabled Professor Tiele to arrange the chief religions in certain groups, starting from the primitive conception of the common life of the objects of the surrounding scene.³

¹ *Princeton Review*, May 1881, quoted by Tiele, *Elements of the Science of Religion* (1897), i. p. 42.

² *National Religions and Universal Religions* (Hibbert Lectures, 1882).

³ *Ency. Brit.*, 9th ed., art. "Religions"; *Elements of the Science of Religion*, vol. i. (1897), with some corrections communicated by letter to Professor Chantepie de la Saussaye, *Religionsgesch.* (3rd ed., 1905), vol. i. p. 11.

⁴ For a long series of suggested bases of classification see Raoul de la Grasserie, *Des Religions Comparées au Point de Vue Sociologique* (1899), chap. xii.; cf. further E. von Hartmann, *Religionsphilosophie*

I. Nature Religions—

1. Polyzoic Naturalism (hypothetical).
2. Polydemonistic-magical religions under the control of Animism (religions of savages).
3. Purified or organized magical religions. Therianthrope Polytheism.
 - (a) Unorganized (religions of the Japanese, Dravidians, Finns, Esths, the ancient Arabs, the ancient Pelagi, the Old-Italian peoples, the Etruscans (?), the Old-Slavs).
 - (b) Organized (religions of the half-civilized peoples of America, ancient Chinese state-religion, religion of the Egyptians).

4. Worship of beings in human form, but of superhuman power and half-ethical nature. Anthropomorphic polytheism (religions of the Vedic Indians, the ancient Persians, the later Babylonians and Assyrians, the advanced Semites, the Kelts, Germans, Hellenes, Greeks and Romans).

II. Ethical Religions (spiritualistic ethical religions of Revelation)—

1. National Nomicist (nomothetic) Religious Communions (Taoism and Confucianism, Brahmanism, Jainism, Mazdeism, Mosaism and Judaism, the two last already passing into 2).
2. Universalistic Religious Communions (Buddhism, Christianity: Islam with its particularistic and nomicist elements only partially belongs to this group).⁴

7. *Revelation*.—The second group in this division practically corresponds to the second stage recognized by Caird; but it rests upon a somewhat different basis, the conception of revelation addressed to the conscience in the form of religious law. Neither Taoism nor Confucianism, indeed, makes this claim. The *Tao-teh-king*, or book of aphorisms on "the Tao and virtue" ascribed to Lao Tsze, is wholly unlike such a composition as Deuteronomy; and the disciples of Confucius carefully refrained from attributing to him any kind of supernatural inspiration in his conversations about social and personal morality. The sacred literatures of India and Israel, however, present many analogies, and emerge out of a wide range of phenomena which have their roots in the practices of the lower culture. The belief that the Powers controlling man's life are willing upon occasion to disclose something of their purpose, has led to widespread rites of divination, which Plato described as the "art of fellowship between gods and men," and the Stoics defended on grounds of a priori religious expectation as well as of universal experience. Through the dream the living was put into communication with the dead, which sometimes embodied itself in peculiar and pathetic literary forms, such as the Icelandic dream-verses imparted by the spirits of those who had been lost at sea or overwhelmed by the snow; and a whole series of steps leads up from necromancy to prophecy and oracle, as the higher gods become the teachers of men. The gods of revelation are naturally not the highest, since they appear as the interpreters of one superior to themselves. The revealing agency may be only a voice like Aius Locutius, to which the Romans raised a temple; or, like Hermes, he may be the messenger of the gods; or, like Marduk, pre-eminently the god of oracles in Babylonia, he may be the son of Ea, the mighty deep encompassing the earth, source of all wisdom and culture. To Marduk the prophet-god Nabu in his turn became son, and his consort Tashmit ("causing to hear") was the personification of Revelation. Egyptian thought ascribed this function to Thoth, who played somewhat different parts in different systems, but emerges as the representative of the immanent intelligence

(1888); Siebeck, *Lehrbuch der Religionsphilosophie* (1893); Dörner, *Grundriss der Religionsphilosophie* (1903). Siebeck proposed to distribute religions in three grades: (1) Nature-Religions, i.e. those of the lower culture; (2) Morality-Religions in various grades and stages, e.g. Mexicans and Peruvians, Arcadians, Chinese, Egyptians, Hindus, Persians, Germans, Romans, with the Greek religion in the highest rank; (3) Religions of Redemption (Judaism forming the transition from the second group), Buddhism in the sense of world-negation, and, positively, Christianity. Bousset, *What is Religion?* (1907) reckons Platonism along with Buddhism. For criticism of Siebeck's scheme see Tiele, *Elements of the Science of Religion*, vol. i. (1897), pp. 62, 65. Pfeifferer, *Religion and Historic Faiths* (1907), p. 88, recognizes more clearly the difficulty of carrying almost any division through the whole field, without frequent breach of historical connexions.

of the world, brother of Maât and the giver of laws and culture to man.¹ Thoth "the thrice-great" passed into Hermes Trismegistus whom Christian fathers could recognize,² when the supremely beautiful figure of Greek theology, Apollo, had lost his dignity and ceased to be desired. Thoth was a voluminous author, and the collection of forty-two books which bore his name was a kind of primitive cyclopædia of theology, astronomy, geography and physiology. Apollo proclaims at his birth that he will declare the counsel of Father Zeus to men.³ But his utterances have been only casually preserved. A special literature of oracles did indeed arise; the divine words were collected and the circumstances which produced them were recorded; and had Delphi become in fact the centre of Greece, as Plato conceived it, here might have been the nucleus of a scripture. Theories of inspiration lurk behind the rich vocabulary of Greek prophecy; the seer is *ἐνθεος*, *θεόληπτος*, *θεόπνευστος*, *θεόφορτος*, and Bakis and Musæus give their names to sacred verses. The story of the Sibylline books in Rome, on the other hand, shows the growth of the idea of authority. They are deposited in a temple, in charge of a small sacred college; new deities and rites are introduced under their sanction; when they are accidentally destroyed, envoys are sent to the East and fresh collections are made; these are in their turn purged, the false are discarded and the true reverently preserved. By what method the books were consulted is not known; but they exhibit the idea of a sacred canon in process of formation. The theologians of India guarded their ancient hymns with the utmost care. A vast literary apparatus was devised for their protection. The famous Purusha-hymn (*R.V.* x. 90) already claimed a divine origin for the three Vedas, the Rik, the Sāman and the Yajush. The "triple knowledge" was sometimes derived from the "Lord of Creatures" Prajāpati—one of the unifying forms of Brahmanic theology—through Vāc or "speech." The Veda, that is to say, had existed in the divine mind ere it was made known to men, and as such it belonged to the realm of the deathless and the infinite. The tribal poets were supposed to have "seen" the heavenly originals; elaborate arguments were devised to explain how the names of particular objects like rivers and mountains could have existed in the Eternal; while the grounds of belief in the infallibility of the sacred verses were enforced with the double weight of philosophy and tradition. Buddhism repudiated the authority of the Veda, but found it needful to supply its place; and the word of the omniscient Teacher, faithfully reported by his disciples and guaranteed by concurrent traditions, became the rule of belief for the new Order. Nor were the authors of the scriptures whose fragments are preserved in the Zend Avesta less conscious of their divine value. The ancient Gāthās, which were supposed to be the composition of Zarathustra himself, received the homage of later worshippers.⁴ Daena, the ideal personification of law and religion, is the object of praise and sacrifice. She dwells on high in the Heavenly Home, the radiant "Abode of song," but Zarathustra summons her thence, begs for her fellowship, and prays her for righteousness of thought, speech and deed.⁵ She is produced by Vohu Mano, the "Good Thought" of Ahura, one of the six Holy Immortals; she thus belongs to the ideal creation before the earth and its inhabitants;⁶ but how the heavenly Daena was wrought by Zarathustra into written form is nowhere stated. This conception of pre-existent spiritual counterparts was not without influence on the later theology of Israel. The sacred law (Torah) was the earthly reproduction of a heavenly Torah which had no origin in time, and constituted the sum of ideal wisdom in which God looked when he would create the world.⁷

¹ Cf. Maspero, *Dawn of Civilization*, p. 294; Wiedemann, *Religion of the Ancient Egyptians*, p. 227; *Burdge, Gods of Egypt*, i. p. 415.

² *Aug. De Civ. Dei*, xviii. 39, attributes the origin of philosophy to his era.

³ *Hom. Hymn*, i.

⁴ *Yasna*, lv.; *S.B.E.* xxxi. p. 294.

⁵ *S.B.E.* xxiii. p. 264.

⁶ *Bundahis*, i. 25; *S.B.E.* v. p. 9.

⁷ *Midrash Bereshith Rabba*, tr. Wünsche, I. i. ver. i.

Even Mahomedanism felt the spell of the same modes of thought. The idea of revelation was expressed by "sending down" (from *mazala*, to descend); that which passed from heaven to earth was a pre-existent word, eternal as God Himself. Allusions in particular passages of the Koran to the "mother of the scripture," the invisible originals of the prophet's speech, led to the doctrine of its uncreated being. The whole history of religion presents perhaps no more singular spectacle than the mosques of Bagdad in the middle of the 9th century filled with vast crowds of twenty and thirty thousand of the faithful, assembled to discuss the dogmas of the created and the uncreated Koran.⁸

8. *Ethics and Eschatology*.—The second distinguishing mark in Tiele's higher group is implied in the term "Ethical." By this it is not intended to assert that moral ideas are wanting in the so-called "naturist" religions. Anthropologists have, it is true, taken widely different views of the relation of ethics and religion, and the stage at which an effective alliance between them might be recognized. Like all problems of origins, the question is necessarily extremely obscure, and cannot be definitely settled by historical evidence. Broadly speaking, however, it may be said that the attempt to show that certain savages are destitute of moral feeling cannot be sustained;⁹ and evidence has already cited above (in the section on PRIMITIVE RELIGION) proving the varied and immediate effects of religion on the life of the lowest tribes. Continuous interaction marks the slow courses of advance. At a very early period in social development the rules of conduct are referred to some higher source. Thus among the tribes of south-eastern Australia described by Mr Howitt,¹⁰ the native rites and laws handed down from generation to generation were supposed to have been first imparted by some higher being such as Nurrundere, who made all things on the earth; or Nurelli, who created the whole country, with the rivers, trees and animals; or Daramulun, who (like Nurrundere) bestowed weapons on the men, and instituted the rites and ceremonies connected with life and death. As religion advances with improved social organization, a series of figures, partly human, partly divine, embodies the idea that the command of nature implied in the progress of the arts is due to some kind of instruction from above, and that the obligations of law are of more than human origin. The Algonquin, Manibozho and Quetzalcoatl of Mexico stand for a whole group of typical personalities in North and Central America. The mysterious fish-man Oannes, who taught the primitive inhabitants of Babylonia, according to Alexander Polyhistor, has been identified with Ea, god of the deep, the source of wisdom, culture and social order. Zeus gave laws to Minos; Apollo revealed the Spartan constitution to Lycurgus; Zaleucus received the laws for the Locrians from Athena in a dream; Vishnu and Manu condescended to draw up law-books in India. The worship of ancestors has again and again gathered around it powerful and ethical influences, emphasizing the parental and filial relations, and strengthening the mutual obligations of communal life. Hirata answered by anticipation the modern reproach against Shinto, founded on the absence of any definite morality connected with it, by laying down the simple rule, "Act so that you need not be ashamed before the Kami of the unseen."¹¹ The mythological embodiments of the connexion of law in nature with the social and moral order have already been briefly noted: a few words may be said in conclusion on another product of the union of religion and ethics, viz. the doctrine of judgment after death. That this doctrine is not essential to a highly moralized religion is clear from the fact that it formed no part of the earlier Hebrew prophecy. Judgment, indeed, was an inevitable outcome of the sovereignty of Yahweh, but it would be passed upon the nation in the immediate scene of its misdoings; and even when the scope of the divine doom

⁸ Von Kretzer, *Die Herrschenden Ideen des Islams*, p. 233 ff.

⁹ See Westermarck, *Origin and Development of Moral Ideas*, vol. i. (1906), p. 125, on Lord Avebury's conclusions.

¹⁰ *Native Tribes of S.E. Australia* (1904), p. 488, 489, 495, 543.

¹¹ Satow, "Revival of Pure Shinto," *Trans. As. Soc. Japan*, vol. iii. Appendix, p. 87.

was extended to include the nations of the world, it was still upon the living that it would alight. The seers of Israel were content to dismiss their dead to a land of silence and darkness, the vast hollow gloom of the subterranean Sheol.¹ A far ruder outlook on life, however, which has again and again appealed to some form of the divine cognizance by means of the ordeal and the oath, frequently supplements the moral issues of this world by the judicial award of the next. Assuming the proper fulfilment of the ritual of death, ethics gradually extends its control over the future. At first the social distinctions of this life are simply continued hereafter: the chief remains a chief, the slave a slave; and the conditions of the future only prolong those of the present. In so far as tribal eminence depends on superior skill or courage or wisdom, the germs of ethical differentiation may be discovered even here. The process is carried further (1) in individual cases of retribution, when (as among the Kaupis) crime within the tribe was punished, and a murderer becomes in the next life his victim's slave;² or (2) when service to the community received special reward, and warriors who had fallen in battle, women who had died in childbirth and merchants who had perished on a journey were sent in Mexico to the house of the sun.³ As the social order acquires more definiteness and stability, the control of life by the gods tends to become more clearly moralized. This brings with it new standards independent of clan-customs or tribe-usage. Only the worst offences, however, at first draw down post-mortem punishment. The Homeric Erinyes chastise outrages on the poor, injuries to guests, failure to show the respect due to parents or to recognize the rights of age, in this life; only on perjury does the divine doom extend to the next.⁴ On the other hand, the Egyptian version of "the whole duty of man" in the famous 125th chapter of the *Book of the Dead* embraces a singular complex of ritual, social and personal sins, in which the inward states of lying, anger and ill-will are condemned along with murder, theft and adultery, beside violation of the times of offerings to the gods, or interference with the food of the blessed dead. The great judgment of Osiris formulates with the utmost precision the alliance between morals and religion. The doctrine established itself in Greek theology under the influence of Orphism, and supplied Plato with mythic forms for his "criticism of life." In India the true of morality and religion was effected in another manner. True, Yama, first of men to enter the world beyond, became the "King of Righteousness" before whose tribunal the dead must appear. But a new agency began to engage the speculations of thinkers, the moral values of action embodied in the Deed. "The deed does not perish," ran an early formula.⁵ "A man is born into the world that he has made," said another;⁶ and what was laid down first as a ritual principle survived as an ethical. Buddhism conceived men as constantly making their own world for good and ill; it took over from Brahmanism a whole series of heavens and hells to provide an exact adjustment in the future for the virtue or vice of the present; and its eschatological confidence was one of the potent instruments of its success in countries which, like China and Japan, had developed no theories of retribution or reward beyond the grave. Along a different line of thought the Iranian teachers, beholding the world divided between hostile powers, demanded, as the fundamental postulate of religion, the victory of the good. The conflict must end with the triumph of light, truth and right. The details of this remarkable scheme must be studied elsewhere (see ZOROASTER). The award of the angel-judges at the Bridge of Assembly, soon after death, despatched the individual to his appropriate lot in the homes of Good or Evil Thought, Word

and Deed. But at length the long struggle would draw to an end. The great "divine event," the *frasho-kereti*, the renovation, would set in. A new heaven and a new earth would be created: a general resurrection should take place; the powers of evil should be overthrown and extinguished; and hell should be brought back for the enlargement of the world. Eschatology has again and again expressed the alliance between ethics and religion. It remains for the future to show how long that alliance will require its support.

BIBLIOGRAPHY.—(For primitive religion see preceding section.) Only a selection of the copious and ever-increasing literature can here be named. Monographs on the separate religions are named in their respective articles.

1. After Hume's *Natural Hist. of Religions* (1757) earlier surveys will be found in Meiners, *Allgem. Krit. Gesch. der Religionen* (2 vols., 1806-7); Constant, *De la religion* (5 vols., 1824-31); Baur, *Symbolik und Mythologie* (3 vols., 1825); Cruzer, *Symbolik und Mythol. der alten Völker* (1837); F. D. Maurice, *The Religions of the World* (1846); Hardwick, *Christ and other Masters* (4 vols., 1855-59); Dollinger, *The Gentile and the Jew* (2 vols., 1863). On Mythology and Religion English study was chiefly influenced by F. Max Müller, *Essay on Comparative Mythology* (1856); *Chips from a German Workshop* (1867 onwards); *Lectures on the Science of Language* (2 vols., 1861-64); *Contributions to the Science of Mythology* (2 vols., 1894); *Modern Mythology* (1897); *Essays on Early Anthropology*, Bastian, *Der Mensch in der Gesch.* (3 vols., Leipzig, 1860); Waitz-Gerland, *Anthropologie* (6 vols., Leipzig, 1877).

2. Translations from the Scriptures of various religions.—*Sacred Books of the East* (49 vols., 1879 and onwards); *Annales du Musée Guimet* (1880 and onwards).

3. Manuals, treatises and series in single or collective authorship.—C. P. Tiele, *Outlines of the History of Religion*, tr. Carpenter (London, 1877); *Gesch. der Religion im Alterthum*, tr. Gehrich (2 vols., Gotha, 1895-98); *Kompandium der Religionsgesch.*, tr. Weber (Breslau, 1903); G. Rawlinson, *Religions of the Ancient World* (London, 1882); *Religious Systems of the World*, by various authors (London, 1890); Menzies, *Hist. of Religion* (1895); Orrell, *Allgemeine Religionsgesch.* (Bonn, 1894); *Great Religions of the World*, by various authors (1901); Boussset, *Das Wesen der Religion* (Halle, 1903); Eng. trans., *What is Religion?* (London, 1907); Chantepie de la Saussaye, *Religionswissenschaft* (2 vols., 1905); Achelis, *Abriß der Vergleichenden Religionswissenschaft* (Sammlung Göschens); (i) Die Orientalischen Religionen" (in *Die Kultur der Gegenwart*), by various authors (1906); Pfeiderer, *Religion und Religionsen* (Berlin, 1906); Eng. trans., *Religion and Historic Faiths* (London, 1907); Haarlem Series, *Die Voornaamste Godsdiensten*, beginning with Islam, by Dozy (1863 onwards); Soc. for Promotion of Christian Knowledge, *Non-Christian Religions*; Hibbert Lectures on *The Origin and Growth of Religion* (15 vols., beginning with F. Max Müller, 1878); Ascendorff's series, *Darstellungen aus dem Gebiete der Nichtchristl. Religionsgesch.* (14 vols., Münster s.w., beginning 1890); *Handbooks on the History of Religions*, ed. Jastrow, beginning with Hopkins on India (1895); *American Lectures on the History of Religions*, beginning with Rhys Davids on Buddhism (1896); Constable's series, *Religions, Ancient and Modern* (London, beginning 1905), brief and popular; J. Freeman Clarke, *Ten Great Religions* (Boston, 1871); S. Johnson, *Oriental Religions*, &c. (3 vols.); *India*² (London, 1873); *China* (Boston, 1877); *Persia* (1885); Lippert, *Die Religionen der Europäischen Cultur-Völker* (Berlin, 1881); A. Réville, *Prolegom. de l'hist. des rel.* (Paris, 1881; Eng. trans., 1884); *Les Rel. des peuples non-civilisés* (2 vols., Paris, 1883); *Rel. du Mexique* (1885); *Rel. chinoise* (1886); Letourneau, *L'Evolution religieuse* (Paris, 1898); Publications of the *rele des sciences et des sectes et des sciences religieuses*, ed. *Annales du Musée Guimet*, "Bibliothèque de Vulgarisation."

4. Works bearing on history.—Fustel de Coulanges, *La Cité antique* (Paris, 1864); Lubbock, *Origin of Civilization* (1870); Whitney, *Oriental and Linguistic Studies* (New York, 1872 and 1874); Brinton, *The Religious Sentiment* (1876); *Myths of the New World*² (New York, 1876); *Essays of an Americanist* (1890); *Religions of Primitive Peoples* (1897); Keary, *Outlines of Primitive Belief* (London, 1882); Leblou, *Les Bibles et les initiateurs de l'humanité* (4 vols. in 7 parts, Paris, 1883); Goblet d'Alviella, *Introd. à l'hist. générale des religions* (Brussels, 1887); *La Migration des symboles* (Paris, 1891); Hartland, *The Legend of Perseus* (3 vols., London, 1894); Ratzel, *The History of Mankind*, tr. Butler (3 vols., London, 1896); Usener, *Götternamen* (Bonn, 1896); Grant Allen, *The Evolution of the Idea of God* (London, 1897); Forlong, *Short Studies in the Science of Comp. Religions* (London, 1897); Lang, *The Making of Religion* (1898); Lyall, *Asiatic Studies*² (2 vols., London, 1899); Baisac, *Les Origines de la religion*² (Paris, 1899); Marillier, "Religion," *Grande Encyclop.* xviii. (Paris, 1900); Maculloch, *Comparative Theol.* (1902); Dieterich, *Myster Erde* (Leipzig, 1905); S. Reinach, *Cultes, mythes et religions* (2 vols., Paris, 1905-6); Frazer, *Adonis, Attis and Osiris* (1906); Ed. Meyer, *Gesch. des Alterthums*², I. 1. "Einleitung; Elementarer Anthropologie" (1907).

5. Psychology, Philosophy and History.—Hegel, *Philosophy of*

¹ Cf. Ezek. xxxiii. 17-32; Ps. lxxxviii 3-4, 10, 11; Job x. 21-22, and many other passages.

² Watt, *Journ. Anthropol. Institute*, xvi p. 356. Cf. Cordington, *The Melanesians* (1891), p. 274.

³ Bancroft, *Native Races of the Pacific States of N. America*, iii. p. 532.

⁴ *Il.* iii. 278-79; *xix.* 258-60.

⁵ *S.B.E.* ii. p. 271; *xiv.* pp. 116, 310.

⁶ *Ibid.* xli. p. 181.

Religion (Eng. trans., 3 vols., 1895); Pfeleider, *Die Religion* (2 vols., Berlin, 1869); *Philos. of Religion*, vol. iii. (Engl. trans., London, 1888); *Religionsphilosophie*¹ (Berlin, 1896); F. Max Müller, *Introd. to the Science of Religion* (1873); *Hibbert Lectures* (1878); *Gifford Lectures* (4 vols., 1889-93); Spencer, *Principles of Sociology*, i. (1876); Fairbairn, *Studies in the Philosophy of Religion and History* (1876); E. von Hartmann, *Das Religi. Bewusstsein der Menschheit* (Berlin, 1882); Rauwenhoff, *Weisheitslehre van den Godsdienst* (Leiden, 1887); E. Caird, *The Evolution of Religion* (2 vols., 1893); Siebeck, *Lehrbuch der Religionsphilosophie* (Freiburg i. B., 1893); Tiele, *Elements of the Science of Religion* (2 vols., 1897); Raoul de la Grasserie, *Des religions comparées au point de vue sociologique*, and *De la psychologie des religions* (Paris, 1895); Starbuck, *Psychology of Religion* (London, 1900); Jastrow, *The Study of Religion* (London, 1901); W. James, *The Varieties of Religious Experience* (1903); Dörner, *Grundriss der Religionsphilosophie* (Leipzig, 1903); Girsensohn, *Die Religion, ihre Psychischen Formen und ihre Zentralidee* (Leipzig, 1903); Wundt, *Völkerpsychologie*, Bd. ii. *Mythos und Religion* (1905-6); Ladd, *The Philosophy of Religion* (2 vols., London, 1906); Hoffding, *The Philosophy of Religion* (Engl. trans., 1906); Westermarck, *The Origin and Development of the Moral Ideas*, i. (London, 1906); Hobhouse, *Morals in Evolution* (2 vols., London, 1906).

6. Periodicals, &c.—*Revue de l'hist. des religions* (Paris, 1880 onwards); *Folk-Lore* (London, 1890 onwards); *Archiv. für Religionswissenschaft* (Freiburg i. B., 1898 onwards); *L'Année sociologique* (Paris, 1898 onwards); *Actes du premier congrès international d'histoire des religions* (Paris, 1900); *Verhandlungen des II. internationalen Kongresses für Allgemeine Religionsgeschichte in Basel* (1904).

Much information on the growth and present condition of the study has been collected by Jordan, *Comparative Religion, its Genesis and Growth* (Edinburgh, 1905). (J. E. C.)

REMAGEN, a town of Germany, in the Prussian Rhine Province, on the left bank of the Rhine, 12 m. above Bonn, by the railway from Cologne to Coblenz, and at the junction of the Ahr valley railway to Adenau. Pop. (1900) 3534. The (Roman Catholic) parish church is remarkable for a gate (Römertor) with grotesque sculptures of animals, dating from the 12th century. Archaeologists have variously interpreted its original purpose, whether as church door, city gate or palace gate. The industry of the place is almost wholly concerned with the preparation of wine, in which a large export trade is done. Just below the town, on a height overlooking the Rhine, stands the Apollinaris church, built 1839-53 on the site of a chapel formerly dedicated to St Martin, and containing the relics of St Apollinaris. It is a frequent place of pilgrimage from all parts of the lower Rhine. According to legend, the ship conveying the relics of the three kings and of Bishop Apollinaris from Milan to Cologne in 1164 could not be got to move away from the spot until the bones of St Apollinaris had been interred in St Martin's chapel.

Remagen (the *Rigomagus* of the Romans) originally belonged to the duchy of Jülich. Many Roman antiquities have been discovered here. In 1857 a votive altar dedicated to Jupiter, Mars and Mercury was unearthed, and is now in the Provincial Museum at Bonn.

See Kinkel, *Der Führer durch das Ahrthal nebst Beschreibung der Stadt Remagen* (2nd ed., Bonn, 1854).

REMAINDER, REVERSION. In the view of English law a remainder or reversion is classed either as an incorporeal hereditament or, with greater correctness, as an estate in expectancy. That is to say, it is a present interest subject to an existing estate in possession called the particular estate, which must determine before the estate in expectancy can become an estate in possession. A remainder or reversion is in strictness confined to real estate, whether legal or equitable, though a similar interest may exist in personalty. The particular estate and the remainder or reversion together make up the whole estate over which the grantor has power of disposition.¹ Accordingly a remainder or reversion limited on an estate in fee simple is void. The difference between a remainder and a reversion, stated as simply as possible, is that the latter is that undisposed-of part of the estate which after the determination of the particular estate will fall into the possession of the original grantor or his representative, while a remainder is that part of the estate which under the same circumstances will fall into the possession of a person other than the original grantor or his

¹ Compare the life-rent and fee of Scots law.

representative. A reversion, in fact, is a special instance of a remainder, distinguishable from it in two important respects: (1) a reversion arises by operation of law on every grant of an estate where the whole interest is not parted with, whereas a remainder is created by express words; (2) tenure exists between the reversioner and the tenant of the particular estate, but not between the latter and the remainderman. Accordingly rent service is said to be an incident of a reversion but not of a remainder, and a reversioner could distrain for it at common law. A reversion may be limited upon any number of remainders each of them as it falls into possession becoming itself a particular estate. A remainder or reversion may be alienated either by deed or by will. A conveyance by the tenant of a particular estate to the remainderman or reversioner is called a surrender; a conveyance by the remainderman or reversioner to the tenant is a release.

Remainder.—Remainders are either vested or contingent. "An estate is vested in interest when there is a present fixed right of future enjoyment. An estate is contingent when a right of enjoyment is to accrue on an event which is dubious and uncertain. A contingent remainder is a remainder limited so as to depend on an event or condition which may never happen or be performed, or which may not happen or be performed till after the determination of the preceding estate" (Fearne, *Contingent Remainders*, 2, 3). Contingent remainders are of two kinds, those limited to uncertain persons and those limited on uncertain events. A grant by A to B for life, followed by a remainder in fee to the heir of C is an example of a contingent remainder.² Until the death of C he can have no heir. If C die during the lifetime of B, the contingent remainder of his heir becomes vested; if C survive B, the remainder is at common law destroyed owing to the determination of the particular estate, for every remainder must have a particular estate to support it. In the case of a contingent remainder, it must become vested during the continuance of the particular estate or at the instant of its determination. This rule, which no doubt arose from the disfavour shown by the law to contingent remainders on their first introduction. They were not firmly established even when Littleton wrote in the reign of Edward IV. (see Williams *Real Property*). The inconveniences resulting from this liability of contingent remainders to destruction were formerly overcome by the device of appointing trustees to preserve contingent remainders. At law. Equitable contingent remainders, it should be noticed, were indestructible, for they were supported by the legal estate. In modern times the matter has been dealt with by act of Parliament. By the Real Property Act 1845, § 8, a contingent remainder is rendered capable of taking effect notwithstanding the determination by forfeiture, surrender or merger of any preceding estate of freehold in the same manner as if such determination had not happened. The case of determination by any other means is met by the Contingent Remainders Act 1877. The act provides that a contingent remainder which would have been valid as a springing or shifting use or executory devise or other limitation had it not had a sufficient estate to support it as a contingent remainder is, in the event of the particular estate determining before the contingent remainder vests, to be capable of taking effect as though the contingent remainder had originally been created as a springing or shifting use or executory devise or other executory limitation. It will accordingly only be good if the springing use, &c. (for which see TRUST), would be good. If the springing use be void as a breach of the rule against perpetuities (see PERPETUITY), the remainder will likewise be void. Apart from this act, there is some uncertainty as to the application of the rule against perpetuities to remainders. The better opinion is that it applies to equitable remainders and to legal remainders expectant upon an estate for life limited to an unborn person. In the latter case the rule as applied to contingent remainders is somewhat different from that affecting executory interests. The period is different, the remainder allowing the tying up of property for a longer time than the executory interest. There is also the further difference that the rule does not affect a contingent remainder if it become vested before the determination of the particular estate. An executory interest is void if it may transgress the rule, even though it do not actually do so. For the rule in Shelley's case, important in connexion with remainders, see that title.

The state laws of the United States affecting remainders will be found in Washburn, *Real Property*, ii. bk. ii. As a general rule contingent remainders have been rendered of little practical importance by enactments that they shall take effect as executory devises or shall not determine on determination of the particular estate.

Reversion.—Unlike remainders, all reversions are present or vested estates. The law of reversion, like that of remainder, has been considerably modified by statute. It was formerly considered

² A contingent remainder amounting to a freehold cannot be limited on a particular estate less than a freehold.

that on the grant of the reversion the tenant should have the opportunity of objecting to the substitution of a new landlord. It was therefore necessary that he should attorn tenant to the purchaser. Without such attornment the grant was void, unless indeed attornment were compelled by levying a fine. The necessity of attornment was abolished by 4 & 5 Anne c. 16. Its only use at present seems to be in the case of mortgage. A mortgagor in possession sometimes attorns tenant to the mortgagee in order that the latter may treat him as his tenant and distrain for his interest as rent. The legal view that rent was incident to the reversion led at common law to a destruction of the rent by destruction of the reversion. This would chiefly happen in the case of an under-tenant and his immediate reversioner, if the intermediate became merged in the superior reversion. To obviate this difficulty it was provided by the Real Property Act 1845, § 9, that, on a surrender or merger of a reversion expectant on a lease, the rights under it should subsist to the reversion conferring the next vested right. The question as to what covenants run with the reversion is one of the most difficult in law. The rule of common law seems to have been that covenants ran with the land but not with the reversion, that is to say, the benefit of them survived to a new tenant but not to a new landlord. The effect of the act of 32 Hen. VIII. c. 34, and of the Conveyancing Act 1881, has been to annex to the reversion as a general rule the benefit of the rent and the lessee's covenants and the burden of the lessor's covenant. Merely collateral covenants, however, do not run with the reversion, but are regarded as personal contracts between lessor and lessee. At common law on the severance of a reversion a grantee of part of the reversion could not take advantage of any condition for re-entry, on the ground that the condition was entire and not severable. This doctrine was abolished by one of Lord St. Leonard's Acts in 1859. The Conveyancing Act 1881, § 12, now provides in wider terms than those of the act of 1859 that on severance of the reversion every condition capable of apportionment is to be apportioned. In order to guard against fraudulent concealment of the death of a *cestui que vie*, or person for whose life any lands are held by another, it was provided by 6 Anne c. 18 that on application to the court of chancery by the person entitled in remainder, reversion or expectancy, the *cestui que vie* should be produced to the court or its commissioners, or in default should be taken to be dead. In Scotland reversion is generally used in a sense approaching that of the equity of redemption of English law. A reversion is either legal, as in an adjudication, or conventional, as in a wadset. Reversions are registered under the system established by the Act 1617 c. 16.

In the United States the act of 32 Hen. VIII. c. 34 "is held to be in force in Massachusetts, Pennsylvania, Illinois, and Connecticut, but was never in force in New York till re-enacted" (Washington, *Real Property*, l.).

REMAND (Lat. *remandare*), a term of English law meaning the return of a prisoner by order of a court to the custody from which he came to the court. Thus where an application for release is unsuccessfully made by means of *habeas corpus*, the applicant is remanded to the custody which he has challenged as illegal. Where trials or indictments are not concluded at a single sitting the court of trial has power to remand the accused into proper custody during any necessary adjournment. Where a preliminary inquiry into an indictable offence is not completed at a single sitting, the prisoner, if not released on bail, may be remanded to prison or some other lawful place of custody for a period not exceeding eight days, and so on by further remands till the inquiry is completed and the accused is discharged, or committed to prison to await his trial, or released on bail to take his trial. If the remand is for more than three days the order must be in writing (Indictable Offences Act 1848, 11 & 12 Vict. c. 42, s. 21). Similar powers of remand or committal to prison during adjournments are given to justices in the exercise of their summary criminal jurisdiction, whether as to offences punishable only on summary conviction, or as to indictable offences with which it is proposed to deal summarily (Summary Jurisdiction Acts 1848, s. 16, and 1879, s. 24).

In the case of charges against children or young persons, where the justices commit for trial or order a remand pending inquiry, or with a view to sending a child to an industrial school or a reformatory, they may remand to the workhouse or to some fit custody instead of remanding to prison (Youthful Offenders Act 1901, s. 4). For this purpose remand homes have been established.

REMBRANDT (1606-1669). **REMBRANDT HARMENS VAN RIJN**, Dutch painter, was born in Leiden on the 15th of July 1606. It is only within the past fifty years that we have come

to know anything of his real history. A tissue of fables formerly represented him as ignorant, boorish and avaricious. These fictions, resting on the loose assertions of Houbraken (*De Grote Schouburgh*, 1718), have been cleared away by the untiring researches of Scheltema and other Dutchmen, notably by C. Vosmaer, whose elaborate work (*Rembrandt, sa vie et ses œuvres*, 1868, 2nd ed., 1877) is the basis of our knowledge of the man and of the chronological development of the artist.¹ Rembrandt's high position in European art rests on the originality of his mind, the power of his imagination, his profound sympathy with his subjects, the boldness of his system of light and shade, the thoroughness of his modelling, his subtle colour, and above all on his intense humanity. He was great in conception and in execution, a poet as well as a painter, an idealist and also a realist; and this rare union is the secret of his power. From his dramatic action and mastery of expression Rembrandt has been well called "the Shakespeare of Holland."

In the beginning of the 17th century Holland had entered on her grand career of national enterprise. Science and literature flourished in her universities, poetry and the stage were favoured by her citizens, and art found a home not only in the capital but in the provincial towns. It was a time also of new ideas. Old conventional forms in religion, philosophy and art had fallen away, and liberty was inspiring new conceptions. There were no church influences at work to fetter the painter in the choice and treatment of his subject, no academies to prescribe rules. Left to himself, therefore, the artist painted the life of the people among whom he lived and the subjects which interested them. It was thus a living history that he painted—scenes from the everyday life and amusements of the people, as well as the civic rulers, the "regents" or governors of the hospitals and the heads of the guilds, and the civic guards who defended their towns. So also with religious pictures. The dogmas and legends of the Church of Rome were no longer of interest to such a nation; but the Bible was read and studied with avidity, and from its page the artist drew directly the scenes of the simple narrative. Perhaps the earliest trace of this new aspect of Bible story is to be found in the pictures painted in Rome about the beginning of the 17th century by Adam Elsheimer of Frankfort, who had undoubtedly a great influence on the Dutch painters studying in Italy. These in their turn carried back to Holland the simplicity and the picturesque effect which they found in Elsheimer's work. Among these, the precursors of Rembrandt, may be mentioned Moeyaert, Ravesteyn, Lastman, Pinas, Honthorst and Bramer. Influenced doubtless by these painters, Rembrandt determined to work out his own ideas of art on Dutch soil, resisting apparently every inducement to visit Italy. Though an admirer of the great Italian masters, he yet maintained his own individuality.

Rembrandt was born at No. 3 Weddesteg, on the rampart at Leiden overlooking the Rhine. He was the fourth son of Gerrit Harmens van Rijn, a well-to-do miller. As the older boys had been sent to trade, his parents resolved that he should enter a learned profession. With this view he was sent to the High School at Leiden; but the boy soon manifested his dislike of the prospect, and determined to be a painter. Accordingly he was placed for three years under Swaenburgh, a painter of no great merit, who enjoyed some reputation for his having studied in Italy. His next master was Lastman of Amsterdam, a painter of very considerable power. In Lastman's works we can trace the germs of the colour and sentiment of his greater pupil, though his direct influence cannot have been great, as it is said by Orlers that Rembrandt remained with him only six months, after which time he returned to Leiden, about 1623. During the early years of his life at Leiden Rembrandt seems to have devoted himself entirely to studies, painting and etching the people around him, the beggars and cripples, every picturesque face and form he could get hold of. Life, character,

¹ Vosmaer's first volume, on the precursors and apprenticeship of Rembrandt, was published in 1863. New light has since been thrown on important points by Dr Bode (*Holländische Malerei*, 1883), De Roever, De Vries and others.

and above all light were the aims of these studies. His mother was a frequent model, and we can trace in her features the strong likeness to her son, especially in the portraits of himself at an advanced age. In the collection of Rembrandt's works at Amsterdam in 1898 were shown three portraits of his father, who died about 1632; nine are catalogued altogether. The last portrait of his mother is that of the Vienna Museum, painted the year before her death in 1640. One of his sisters also frequently sat to him, and Bode suggests that she must have accompanied him to Amsterdam and kept house for him till he married. This conjecture rests on the number of portraits of the same young woman painted in the early years of his stay in Amsterdam and before he met his bride. Then, again, in the many portraits of himself painted in his early life we can see with what zeal he set himself to master every form of expression, now grave, now gay—how thoroughly he learned to model the human face not from the outside but from the inner man. Dr Bode gives fifty as the number of the portraits of himself (perhaps sixty is nearer the actual number), most of them painted in youth and in old age, the times when he had leisure for such work.

Rembrandt's earliest pictures were painted at Leiden, from 1627 to 1631. Bode mentions about nine pictures as known to belong to these years, chiefly paintings of single figures, as "St Paul in Prison" and "St Jerome"; but now and then compositions of several, as "Samson in Prison" and "Presentation in the Temple." The prevailing tone of all these pictures is a greenish grey, the effect being somewhat cold and heavy. The gallery at Cassel gives us a typical example of his studies of the heads of old men, firm and hard in workmanship and full of detail, the effects of light and shade being carefully thought out. His work was now attracting the attention of lovers of art in the great city of Amsterdam; and, urged by their calls, he removed about 1631 to live and die there. At one bound he leaped into the position of the first portrait painter of the city, and received numerous commissions. During the early years of his residence there are at least forty known portraits from his hand, firm and solid in manner and staid in expression. It has been remarked that the fantasy in which he indulged through life was reserved only for the portraits of himself and his immediate connexions. The excellent painter Thomas de Keyser was then in the height of his power, and his influence is to be traced in some of Rembrandt's smaller portraits. Pupils also now flocked to his house in the Bloemgracht, among them Gerard Douw, who was nearly of his own age. The first important work executed by Rembrandt in Amsterdam is "Simeon in the Temple," of the Hague Museum, a fine early example of his treatment of light and shade and of his subtle colour. The concentrated light falls on the principal figure, while the background is full of mystery. The surface is smooth and enamel-like, and all the details are carefully wrought out, while the action of light on the mantle of Simeon shows how soon he had felt the magical effect of the play of colour. In the life-sized "Lesson in Anatomy" of 1632 we have the first of the great portrait subjects—Tulp the anatomist, the early friend of Rembrandt, discoursing to his seven associates, who are ranged with eager heads round the foreshortened body. The subject had been treated in former years by the Mierevelt, A. Pietersen and others, for the Hall of the Surgeons. But it was reserved for Rembrandt to make it a great picture by the grouping of the expressive portraits and by the completeness of the conception. The colour is quiet and the handling of the brush timid and precise, while the light and shade are somewhat harsh and abrupt. But it is a marvellous picture for a young man of twenty-five, and it is generally accepted as marking a new departure in the career of the painter.

About 700 pictures are known to have come from Rembrandt's own hand. It is impossible to notice more than the prominent works. Besides the Pellionne family portraits of 1632 now in the Wallace Collection, we have the calligraphist Coppelon of the Cassel Gallery, interesting in the first place as an early example of Rembrandt's method of rivine permanent interest to a portrait by converting it into a picture. He invests it with a sense of life by a momentary expression as Coppelon raises his head towards the

spectator while he is mending a quill. The same motive is to be found in the "Shipbuilder," 1633 (Buckingham Palace), who looks up from his work with a sense of interruption at the approach of his wife. Coppelon was painted thrice and etched twice by the artist, the last of whose portrait etchings (1661) was the Coppelon of large size. The two small pictures of "The Philosopher" of the Louvre date from 1633, especially in execution and full of mysterious effect.

The year 1634 is especially remarkable as that of Rembrandt's marriage with Saskia van Uylenborch, a beautiful, fair-haired Frisian maiden of good connexions. Till her death in 1642 she was the centre of his life and art, and lives for us in many a canvas as well as in her own portraits. On her the painter lavished his magical power, painting her as the Queen Artemisia or Bathsheba, and as the wife of Samson—always proud of her long fair locks, and covering her with pearls and gold as precious in their play of colour as those of the Indies. A joyous pair we see them in the Dresden Gallery, Saskia sitting on his knee while he laughs gaily, or promenading together in a fine picture of 1636, or putting the last touches of ornament to her toilette, for thus Bode interprets the so-called "Burgomaster Pancras and his Wife." These were his happy days when he painted himself in his exuberant fantasy, and adorned himself, at least in his portraits, in scarfs and feathers and gold chains. Saskia brought him a marriage portion of forty thousand guilders, a large sum for those times, and she brought him also a large circle of good friends in Amsterdam. She bore him four children, Rumbartus and two girls, successively named Cornelia after his beloved mother, all of whom died in infancy, and Titus, named after Titia a sister of Saskia. We have several noble portraits of Saskia, a good type of the beauty of Holland, all painted with the utmost love and care, at Cassel (1633), at Dresden (1641), and a posthumous one (1643) at Berlin. But the greatest in workmanship and most pathetic in expression seems to us, though it is decried by Bode, that of Antwerp (1641), in which it is impossible not to trace declining health and to find a melancholy presage of her death.

One of Rembrandt's greatest portraits of 1634 is the superb full-length of Martin Daey, which, with that of Madame Daey, painted according to Vosmaer some years later, formed one of the ornaments of the Van Loon collection at Amsterdam. Both now belong to Baron Gustave de Rothschild. From the firm detailed execution of this portrait one turns with wonder to the broader handling of the "Old Woman" (Françoise van Wasserhoven), aged eighty-three, in the National Gallery, of the same year, remarkable for the effect of reflected light and still more for the sympathetic rendering of character.

The life of Samson supplied many subjects in these early days. The so-called "Count of Guedres threatening his Father-in-law" of the Berlin Gallery has been restored to its proper signification by M. Kolloff, who finds it to be Samson. It is forced and violent in its action. The greatest of this series, and one of the prominent pictures of Rembrandt's work, is the "Marriage of Samson," of the Dresden Gallery, painted in 1638. Here Rembrandt gives the rein to his imagination and makes the scene live before us. Except the bride (Saskia), who sits calm and grand on a dais in the centre of the feast, with the full light again playing on her flowing locks and wealth of jewels, all is animated and full of bustle. Samson, evidently a Rembrandt of fantasy, leans over a chair propounding his riddle to the Philistine lords. In execution it is a good advance on former subject pictures; it is bolder in manner, and we have here signs of his approaching love of warmer tones of red and yellow.

The story of Susannah also occupied him in these early years, and he returned to the subject in 1641 and 1653. "The Bather" of the National Gallery may be another interpretation of the same theme. In all of these pictures the woman is coarse in type and lumpy in form, though the modelling is soft and round, the effect which Rembrandt always strove to gain. Beauty of form was outside his art. But the so-called "Danae" (1636) at St Petersburg is a sufficient reply to those who deny his ability ever to appreciate the beauty of the nude female form. It glows with colour and life, and the blood seems to pulsate under the warm skin. In the picturesque story of Tobit Rembrandt found much to interest him, as we see in the beautiful small picture of the aged Aremberg Collection at Brussels. Sight is being restored to the aged Tobias, while with infinite tenderness his wife holds the old man's hand caressingly. The momentary action is complete, and the picture goes straight to the heart. In the Berlin Gallery he paints the anxiety of the parents as they wait the return of their son. In 1637 he painted the fine picture now in the Louvre of the "Flight of the Angel"; and the same subject is grandly treated by him.

apparently about 1645, in the picture exhibited in the winter exhibition at Burlington House in 1885. Reverence and awe are shown in every attitude of the Tobit family. A similar lofty treatment is to be found in the "Christ as the Gardener," appearing to Mary, of 1638 (Buckingham Palace).

We have now arrived at the year 1640, the threshold of his second manner, which extended to 1654, the middle age of Rembrandt. During the latter part of the previous decade we find the shadows more transparent and the blending of light and shade more perfect. There is a growing power in every part of his art. The coldness of his first manner had disappeared, and the tones were gradually changing into golden-brown. He had passed through what Bode calls his "Sturm-und-Drang" period of exaggerated expression, as in the Berlin Samson, and had attained to a truer, calmer form of dramatic expression, of which the "Menoah" of Dresden is a good example (1641). The portraits painted "to order" became more rare about this time, and those which we have are chiefly friends of his circle, such as the "Mennonite Preacher" (C. C. Anslou) and the "Gilder," a fine example of his golden tone, formerly in the Morny collection and now in America. His own splendid portrait (1640) in the National Gallery illustrates the change in his work. It describes the man well—strong and robust, with powerful head, firm and compressed lips and determined chin, with heavy eyebrows, separated by a deep vertical furrow, and with eyes of deep penetrating glance—altogether a self-reliant man that would carry out his own ideas, careless whether his popularity waxed or waned. The fantastic rendering of himself has disappeared; he seems more conscious of his dignity and position. He has now many friends and pupils, and numerous commissions, even from the stadtholder; he has bought a large house in the Breedstraat, in which during the next sixteen years of his life he gathers his large collection of paintings, engravings, armour and costume which figure afterwards in his inventory. His taste was wide and his purchases large, for he was joint owner with picture-dealers of paintings by Giorgione and Palma Vecchio, while for a high-price Marcantonio Raimondi print he gave in exchange a fine impression of his "Christ Healing the Sick," which has since been known as the "Hundred Guilder Print." The stadtholder was not a prompt payer, and an interesting correspondence took place between Rembrandt and Constantijn Huygens, the poet and secretary of the prince. The Rembrandt letters which have come down to us are few, and these are therefore of importance. Rembrandt puts a high value on the picture, which he says had been painted "with much care and zeal," but he is willing to take what the prince thinks proper; while to Huygens he sends a large picture as a present for his trouble in carrying through the business. There is here no sign of the grasping greed with which he has been charged, while his unselfish conduct is seen in the settlement of the family affairs at the death of his mother in 1640.

The year 1642 is remarkable for the great picture formerly known as the "Night Watch," but now more correctly as the "Sortie of the Banning Cock Company," another of the landmarks of Rembrandt's career, in which twenty-nine life-sized civic guards are introduced issuing pell-mell from their club house. Such guilds of arquebusers had been painted admirably before by Ravestyn and notably by Frans Hals, but Rembrandt determined to throw life and animation into the scene, which is full of bustle and movement. The dominant colour is the citron yellow uniform of the lieutenant, wearing a blue sash, while a Titan-like red dress of a musketeer, the black velvet dress of the captain, and the varied green of the girl and drummer, all produce a rich and harmonious effect. The background has become dark and heavy by accident or neglect, and the scutcheon on which the names are painted is scarcely to be seen. It is to be observed that, as proved by the copy by Gerrit Lundens in the National Gallery, it represents not a "night watch," except in name, but a day watch.

But this year of great achievement was also the year of his great loss, for Saskia died in 1642, leaving Rembrandt her sole trustee for her son Titus, but with full use of the money; till he should marry again or till the marriage of Titus. The words of the will express her love for her husband, and her confidence in him. With her death his life was changed. Bode has remarked that there is a pathetic sadness in his pictures of the Holy Family—a favourite subject at this period of his life. All of these he treats with the naive simplicity of Reformed Holland, giving us the real carpenter's

shop and the mother watching over the Infant reverently and lovingly, with a fine union of realism and idealism.

The street in which he lived was full of Dutch and Portuguese Jews, and many a Jewish rabbi sat to him. He accepted or invented their turbans and local dress as characteristic of the people. But in his religious pictures it is not the costume we look at; what strikes us is the profound perception of the sentiment of the story, making them true to all time and independent of local circumstance. A notable example of this feeling is to be found in the "Woman Taken in Adultery" of the National Gallery, painted in 1644 in the manner of the "Simoon" of the Hague. Beyond the ordinary claims of art, it commands our attention from the grand conception of the painter who here, as in other pictures and etchings, has invested Christ with a majestic dignity which recalls Lionardo and no other. A similar lofty ideal is to be found in his various renderings of the "Pilgrims at Emmaus," notably in the Louvre picture of 1648, in which, as Mrs Jameson says, "he returns to those first spiritual principles which were always the dowry of ancient art." From the same year we have the "Good Samaritan" of the Louvre, the story of which is told with intense pathos. The helpless suffering of the wounded man, the curiosity of the boy on tiptoe, the excited faces at the upper window, are all conveyed with masterly skill. In the last two pictures we find a broader touch and freer handling, while the tones pass into a dull yellow and brown with a marked predilection for deep rich red. Whether it was that this scheme of colour found no favour with the Amsterdammers, who, as Hoogstraten tells us, could not understand the "Sortie," it seems certain that Rembrandt was not invited to take any leading part in the celebration of the congress of Westphalia (1648).

Rembrandt touched no side of art without setting his mark on it; whether in still life, as in his dead birds or the "Slaughtered Ox" of the Louvre (with its repetitions at Glasgow and Budapest), or in his drawing of elephants and lions, all of which are distinct with life. But at this period of his career we come upon a branch of his art on which he left, both in etching and in painting, the stamp of his genius, viz. landscape. Roeland Rghman, but ten years his senior, evidently influenced his style, for the resemblance between their works is so great that, as at Cassel, there has been confusion of authorship. Hercules Seghers also was much appreciated by Rembrandt, for at his sale eight pictures by this master figure in the inventory, and Vosmaer discovered that Rembrandt had worked on a plate by Seghers and had added figures to an etched "Flight into Egypt." The earliest pure landscape known to us from Rembrandt's hand is that of the Elysian Museum (1637-8), followed in the latter year by those at Brunswick, Cracow and Boston (U.S.A.), and that dated 1638 and belonging to Mr G. Rath in Budapest. Better known is the "Winter Scene" of Cassel (1646), silvery and delicate. As a rule in his painted landscape he aims at grandeur and poetical effect, as in the "Repose of the Holy Family" of 1647 (formerly called the "Gipsies"), a moonlight effect, clear even in the shadows. The "Canal" of Lord Lansdowne, and the "Mountain Landscape with Approaching Storm," the sun shining out behind the heavy clouds, are both conceived and executed in this spirit. A similar poetical vein runs through the "Castle on the Hill" of Cassel, in which the beams of the setting sun strike on the castle while the valley is sunk in the shades of approaching night. More powerful still is the weird effect of Lord Lansdowne's "Windmill," with its glow of light and darkening shadows. In all these pictures light with its magical influences is the theme of the poet-painter. From the number of landscapes by himself in the inventory of his sale, it would appear that these grand works were not appreciated by his contemporaries. The last of the landscape series dates from 1655 or 1656, the close of the middle age or manhood of Rembrandt, a period of splendid power. In the "Joseph Accused by Potiphar's wife" of 1654 we have great dramatic vigour and a perfect mastery of expression, with its brilliant colour and glowing effect of light and shade at rest in its strength. To this period also belongs the great portrait of himself in the Fitzwilliam Museum at Cambridge.

But evil days were at hand. The long-continued wars and civil troubles had worn out the country, and money was scarce. Rembrandt's and doubtless Saskia's means were tied up in his house and in his large collection of valuable pictures, and we find Rembrandt borrowing considerable sums of money on the security of his house to keep things going. Perhaps, as Bode suggests, this was the reason of his extraordinary activity at this time. Then, unfortunately, in this year of 1654, we find Rembrandt involved in the scandal of having a child by his servant Hendrickje Jaghers or Stoffels, as appears by the books of the Reformed Church at Amsterdam. He recognized the child and gave it the name of Cornelia, after his much-loved mother, but there is no proof that he married the mother, and the probability is against such a marriage, as the provisions of Saskia's will would in that case have come into force, and her fortune would have passed at once to her son Titus. Hendrickje seems to have continued

to live with him, for we find her claiming a chest as her property at his sale in 1658. Doubtless she is the peasant girl of Rasdorf to whom Houbraken says Rembrandt was married. Sad as the story is, Hendrickje has an interest for us. Bode asserts that in his art there was always a woman in close relationship to Rembrandt and appearing in his work—his mother, his sister and then Saskia.

He also suggests that the beautiful portrait of the "Lady" in the Salon Carré of the Louvre and the "Venus and Cupid" of the same gallery may represent Hendrickje and her child. Both pictures belong to this date, and by their treatment are removed from the category of Rembrandt's usual portraits. But if this is conjecture, we get nearer to fact when we look at the picture exhibited at Burlington House in 1883 to which tradition has attached the name of "Rembrandt's Mistress," now in the Edinburgh National Gallery. At a glance one can see that it is not the mere head of a model, as she lies in bed raising herself to put aside a curtain as if she heard a well-known footstep. It is clearly a woman in whom Rembrandt had a personal interest. The date is clearly 165— the fourth figure being illegible; but the brilliant carnations and masterly touch connect it with the "Potiphar's Wife" of 1654 and the Jaghers period. In 1656 Rembrandt's financial affairs became more involved, and the Orphans' Chamber transferred the house and ground to Titus, though Rembrandt was still allowed to take charge of Saskia's estate. Nothing, however, could avert the ruin of the painter, who was declared bankrupt in July 1656, an inventory of all his property being ordered by the Insolvency Chamber. The first sale took place in 1657 in the Keizerskroon hotel; and the second in 1658, when the larger part of the etchings and drawings were disposed of—"collected by Rembrandt himself with much love and care," says the catalogue. The sum realized, under 5000 guilders, was but a fraction of their value. The time was unfavourable over the whole of Europe for such sales, the renowned collection of Charles I. of England having brought but a comparatively small sum in 1653. Driven thus from his house, stripped of everything he possessed, even to his table linen, Rembrandt took a modest lodging in the same Keizerskroon hostelry (the amounts of his bills are on record), apparently without friends and thrown entirely on himself.

But this dark year of 1656 stands out prominently as one in which some of his greatest works were produced, as, for example, "John the Baptist preaching in the Wilderness," of the Berlin Gallery, and "Jacob blessing the Sons of Joseph," of the Cassel Gallery. It is impossible not to respect the man who, amid the utter ruin of his affairs, could calmly conceive and carry out such noble work. Yet even in his art one can see that the tone of his mind was sombre. Instead of the brilliancy of 1654 we have for two or three years a preference for dull yellows, reds and greys, with a certain uniformity of tone. The handling is broad and rapid, as if in utterance to the ideas which crowded on his mind. There is less caressing of colour for its own sake, even less straining after vigorous effect of light and shade. Still the two pictures just named are among the greatest works of the master. To the same year belongs the "Lesson in Anatomy of Johann Deyman." The subject is similar to the great Tulp of 1632, but his manner and power of colour had advanced so much that Sir Joshua Reynolds, in his visit to Holland in 1781, was reminded by it of Michelangelo and Titian.¹ Vosmaer ascribes to the same year, though Bode places it later, the famous "Portrait of Jan Six," the future burgo-master, consummate in its ease and character, as Six descends the steps of his house drawing on his glove. The connexion between Rembrandt and the great family of Six was long and close. In 1661 the mother of Six Anna Wyber, had been painted by the consummate skill by Rembrandt, who also executed in 1647 the beautiful etching of Six standing by a window reading his tragedy of *Medea*, afterwards illustrated by his friend. Now he paints his portrait in the prime of manhood, and in the same year of gloom paints for him the masterly "John the Baptist." Six, if he could not avert the disaster of Rembrandt's life, at least stood by him in the darkest hour, when certainly the creative energy of Rembrandt

was in full play. The same period gives us the "Master of the Vineyard," and the "Adoration of the Magi" of Buckingham Palace.

After the sale of the house in the Breedstraat, Rembrandt retired to the Rosengracht, an obscure quarter at the west end of the city. We are now drawing to the splendid close of his career in his third manner, in which his touch became broader, his impasto more solid and his knowledge more complete. We may mention the "Old Man with the Grey Beard" of the National Gallery (1657) and the "Bruynling, the Secretary of the Insolvents' Chamber," of Cassel (1658), both leading up to the great portraits of the "Syndics of the Cloth Hall" of 1661. Nearly thirty years separate us from the "Lesson in Anatomy," years of long-continued observation and labour. The knowledge thus gathered, the problems solved, the mastery attained, are shown here in abundance. Rembrandt returns to the simplest gamut of colour, but shows his skill in the use of it, leaving on the spectator an impression of absolute enjoyment of the result, unconscious of the means. The plain burghers dealing with the simple concerns of their glad arrest our attention as if they were the makers of history. They live for ever; and we close our eyes to the strange perspective of the table.

In his old age Rembrandt continued to paint his own portrait as assiduously as in his youthful and happy days. About twenty of these portraits are known; a typical one is to be found in the National Gallery. All show the same self-reliant expression, though broken down indeed by age and the cares of a hard life.

About the year 1663 Rembrandt painted the (so-called) "Jewish Bride" of the Ryks Museum in Amsterdam, and the "Family Group" of Brunswick, the last and perhaps the most brilliant works of his life, bold and rapid in execution and marvellous in the subtle mixture and play of colours in which he seems to revel. The woman and children are painted with such love that the impression is conveyed that they represent a fancy family group of the painter in his old age. This idea received some confirmation from the supposed discovery that he left a widow Catherine Van Wyck and two children, but this theory falls to the ground, for de Roever has shown (*Oud Holland*, 1883) that Catherine was the widow of a marine painter Theunisz Blanckerhoff, who died about the same time as Rembrandt. The mistake arose from a miscopying of the register. The subject of these pictures is thus more mysterious than ever.

In 1668 Titus, the only son of Rembrandt, died, leaving one child, and on the 8th of October 1669 the great painter himself passed away, leaving two children, and was buried in the Wester Kerk. He had outlived his popularity, for his manner of painting, as we know from contemporaries, was no longer in favour with a people who preferred the smooth trivialities of Van der Werff and the younger Mieris, the leaders of an expiring school.

We must give but a short notice of Rembrandt's achievements in etching. Here he stands out by universal confession as first, excellent in his unrivalled technical skill, his mastery of expression, and the lofty conceptions of many of his great pieces, as in the "Death of the Virgin," the "Christ Preaching," the "Christ Healing the Sick" (the "Hundred Guilder Print"), the "Presentation to the People," the "Crucifixion" and others. So great is his skill simply as an etcher that one is apt to overlook the nobleness of the etcher's ideas and the depth of his nature, and this tendency has been doubtless confirmed by the enormous difference in money value between "states" of the same plate, rarity giving in many cases a factitious worth in the eyes of collectors. A single impression of one of his etchings—the Rembrandt of Cassel—realized £2000 at the Halford sale in 1893, the "Ephraim Bonus, with black ring," fetched 1950, and the "Hundred Guilder Print," 1750. The points of difference between these states arise from the additional changes made by Rembrandt on the plate, and the prints taken off by him have been subjected to the closest inspection by Bartsch, Gersaint, Wilson, Dauby, De Clausin, C. Blanc, Willshire, Seymour Haden, Middleton and others, who have described them at great length, and to whom the reader is referred. The classification of Rembrandt's etchings adopted till lately was according to the subject, as Biblical, portrait, landscape, and so on; until Vosmaer attempted the more scientific and interesting line of chronology. This method has been developed by Sir F. Seymour Haden and Middleton. But even in 1873 C. Blanc, in his fine work *L'Œuvre complet de Rembrandt*, still adheres to the older and less intelligent arrangement, resting his preference on the frequent absence of dates on the etchings and more strangely still on the equality of the work. Sir Seymour Haden's reply is that the more important etchings which may be taken in types are dated, and that, the style of the etchings at different periods of Rembrandt's career being fully as marked as that of his paintings, no more

¹ This picture has had a strange history. It had suffered by fire and was sent to a Mr. Chaplin of London in 1841, was exhibited in Leeds in 1868, and again disappeared, ultimately to be found in the storeroom of the South Kensington Museum as a doubtful Rembrandt. The patriotism of some Dutch lovers of art restored it to its native country; and it now hangs, a magnificent fragment, in the museum of Amsterdam.

difficulty attends the classification of one than of the other." Indeed Vosmaer points out in his Life of Rembrandt that there is a marked parallelism between Rembrandt's painted and etched work, his early work in both cases being timid and tentative, while he gradually gains strength and character both with the brush and the graver's tools.

In his *L'Œuvre complet de Rembrandt* (Paris, 1885), Eugène Dutilleul rejects the classification of C. Blanc as dubious and unwarranted, dismisses the chronological arrangement proposed by Vosmaer and adopted by Seymour Haden and Middleton as open to discussion and lacking in possibility of proof, and reverts to the order established by Gersaint, ranging his materials under twelve heads: Portraits (real and supposed), Old Testament and New Testament subjects, histories, landscapes, &c. Sir Seymour Haden originated the theory that many of the etchings ascribed to Rembrandt up to 1640 were the work of his pupils, and seems to make out his case, though it may be carried too far. He argues (in his monograph on the *Etched Work of Rembrandt*, 1877) that Rembrandt's real work in etching began after Saskia's death, when he assumes that Rembrandt betook himself to Elsbroek, the country house of his "powerful friend" Jan Six. But it must be remembered that the future burgomaster was then but a student of twenty-four, a member of a great family it is true, but unmarried and taking as yet no share in public life. That Rembrandt was a frequent visitor at Elsbroek, and that the "Three Trees" and other etchings may have been produced there, may be admitted without requiring us to believe that he had left Amsterdam as his place of abode. The great period of his etching lies between 1639 and 1661, after which the old painter seems to have renounced the needle. In these twenty years were produced his greatest works in portraiture, landscape and Bible story. They bear the impress of the genius of the man.

In addition to the authors named, the reader is referred to W. Bürger, (*the nom de plume of T. Thoré*), *Musées de la Hollande* (1858-60); E. Fromentin, *Maîtres d'autrefois*; H. Havard, *L'École Hollandaise*; Scheltens, *Rembrandt, discours sur sa vie* (1866); Ath. Coquerel fils, *Rembrandt, son individualisme dans l'art* (Paris, 1869); Dr Langbehn, *Rembrandt als Ersieher* (Leipzig, 1890); Emile Michel, *Rembrandt, sa vie, son œuvre, et son temps* (Paris, 1893); P. G. Hamerton, *Rembrandt's Etchings* (London, 1894); Malcolm Bell, *Rembrandt van Rijn and his Work* (London, 1899); Adolf Rosenberg, *Rembrandt, des Meisters Gemälde* (Stuttgart and Leipzig, 1906), a useful work, admirably reproducing 565 of the artist's pictures, and its companion volume, Hans Wolfgang Singer, *Rembrandt, des Meisters Radierungen* (Stuttgart and Leipzig, 1906), reproducing 402 etchings. The chronological, geographical and classifying indexes in both books are of particular utility.

(J. F. W.; P. G. K.)

REMEDIOS, or SAN JUAN DE LOS REMEDIOS, town of Santa Clara province, Cuba, in the municipality of San Juan de Los Remedios. Pop. of the town (1907), 6988; of the municipality, 21,573. The town is served by a branch of the Cuban Central railway, extending from Caibarién to Camajuani, where it connects with the main line. The site is low and flat, and unhealthy wet in the rainy season. The port of Remedios is Caibarién (pop. in 1907, 8333), on the N. coast, about 5 m. E. Both are in the sugar country, and sugar is the base of their economic interests. The first settlement on the site of the present town was made in 1515-16, and in 1545 Remedios was created a *villa* with an ayuntamiento (council).

REMEMBRANCER, the name originally of certain subordinate officers of the English Exchequer. The office itself is of great antiquity, the holder having been termed remembrancer, memorator, rememorator, registrar, keeper of the register, despatcher of business (Maddox, *History of the Exchequer*). There were at one time three clerks of the remembrancer, styled king's remembrancer, lord treasurer's remembrancer and remembrancer of first-fruits. The latter two offices have become extinct, that of remembrancer of first-fruits by the diversion of the fund (Queen Anne's Bounty Act 1838), and that of lord treasurer's remembrancer on being merged in the office of king's remembrancer (1833). By the Queen's Remembrancer Act 1859 the office ceased to exist separately, and the queen's remembrancer was required to be a master of the court of exchequer. The Judicature Act 1873, s. 77, attached the office to the Supreme Court, and the Supreme Court of Judicature (Officers) Act 1879 transferred it to the central office of the Supreme Court. By s. 8 the king's remembrancer is a master of the Supreme Court, and the office is usually filled by the senior master. The king's remembrancer department of the central office is now amalgamated with the judgments and married women's acknowledgments department. The king's

remembrancer still assists at certain ceremonial functions—relics of the former importance of the office—such as the nomination of sheriffs, the swearing-in of the lord mayor of London, the trial of the pyx and the acknowledgments of homage for crown lands. Other duties are set out in the *Second Report of the Legal Departments Commission*, 1874.

"Remembrancer" is also the title of an official of the corporation of the city of London, whose principal duty is to represent that body before parliamentary committees and at council and jury boards.

REMIGIUS, ST (c. 437-533), bishop of Reims and the friend of Clovis, whom he converted to Christianity. According to Gregory of Tours, 3000 Franks were baptized with Clovis by Remigius on Christmas Day, 496, after the defeat of the Alamanni. With the growing power of the papacy a good many fictions grew up around his name, e.g. that he anointed Clovis with oil from the sacred ampulla, and that Pope Hormisdas had recognized him as primate of France. The *Commentary on the Pauline Epistles* (ed. Villalpandus, 1699) is not his work, but that of Remigius of Auxerre.

For authorities see H. Jadart, *Bibliographie des ouvrages cons. la vie et le culte de S. Remi* . . . (Reims, 1891), which contains 126 references.

REMINGTON, FREDERICK (1861-1909), American artist, was born at Canton, New York, on the 4th of October 1861. He was a pupil of the Yale Art School, and of the Art Students' League, New York, and became known as an illustrator, painter and sculptor. Having spent much time in the West, whither he went for his health, and having been with the United States troops in actual warfare, he made a specialty of rendering the North American Indian and the United States soldier as seen on the western plains. In the Spanish-American War he was with the army under General Shafter as war correspondent. He died on the 26th of December 1909, near Ridgefield, Connecticut. His statuettes of soldiers, Indians, cowboys and trappers are full of character, while his paintings have been largely reproduced. He wrote several volumes of stories, including *Pony Tracks* (1895), *Crooked Trails* (1898), *Sundown Leflare* (1899), and *John Ermine of the Yellowstone* (1902).

REMINISCENCE (from Lat. *reminisci*, to remember), the recognized translation of the Greek *ἀνάμνησις*, which is used technically by Plato in his doctrine that the soul recovers knowledge of which it had direct intuition in a former incorporeal existence. The doctrine may be regarded as the poetical precursor of modern a priori theories of knowledge and of "race-memory" and the like. In common language "reminiscence" is synonymous with "recollection."

REMIREMONT, a town of eastern France, capital of an arrondissement in the department of Vosges, 17 m. S.S.E. of Épinal by rail, on the Moselle, a mile below its confluence with the Moselotte. Pop. town, 8782; commune, 10,548. Remiremont is surrounded by forest-clad mountains, and commanded by Fort Parmont, one of the Moselle line of defensive works. The abbey church, consecrated in 1051, has a crypt of the 11th century in which are the tombs of some of the abbesses, but as a whole belongs to the late 13th century. The abbatial residence (which now contains the mairie, the court-house and the public library) has been twice rebuilt in modern times (in 1750 and again after a fire in 1871), but the original plan and style have been preserved in the imposing front, the vestibule and the grand staircase. Some of the houses of the canonesses dating from the 17th and 18th centuries also remain. Remiremont is the seat of a sub-prefect and has a tribunal of first instance, a communal college, a board of trade-arbitration and a chamber of arts and manufactures. Its industries include cotton-spinning and weaving, the manufacture of hosiery and embroidery, iron and copper founding and the manufacture of boots and shoes and brushes.

Remiremont (*Romarici Mons*) derives its name from St Romaric, one of the companions of St Columban of Luxeuil, who in the 7th century founded a monastery and a convent on the hills above the present town. In 910 the nuns, menaced

by the invasion of the Hungarians, took refuge at Remiremont, which had grown up round a villa of the Frankish kings, and in the 11th century they permanently settled there. Enriched by dukes of Lorraine, kings of France and emperors of Germany, the ladies of Remiremont attained great power. The abbess was a princess of the empire, and received consecration at the hands of the pope. The fifty canonesses were selected from those who could give proof of noble descent. On Whit-Monday the neighbouring parishes paid homage to the chapter in a ceremony called the "Kyrioles"; and on their accession the dukes of Lorraine, the immediate suzerains of the abbey, had to come to Remiremont to swear to continue their protection. The "War of the Scutcheons" (Panoceaux) in 1566 between the duke and the abbess ended in favour of the duke; and the abbess never recovered her former position. In the 17th century the ladies of Remiremont fell away so much from the original monastic rule as to take the title of countesses, renounce their vows and marry. The town was attacked by the French in 1638 and ruined by the earthquake of 1682. With the rest of Lorraine it was joined to France in 1766. The monastery on the hill and the nunnery in the town were both suppressed in the Revolution.

REMONSTRANTS, the name given to those Dutch Protestants who, after the death of Arminius (*q.v.*), maintained the views associated with his name, and in 1610 presented to the states of Holland and Friesland a "remonstrance" in five articles formulating their points of departure from stricter Calvinism. These were: (1) that the divine decree of predestination is conditional, not absolute; (2) that the Atonement is in intention universal; (3) that man cannot of himself exercise a saving faith; (4) that though the grace of God is a necessary condition of human effort it does not act irresistibly in man; (5) that believers are able to resist sin but are not beyond the possibility of falling from grace. Their adversaries (the Gomarists) met them with a "counter-remonstrance," and so were known as the Counter-Reonstrants. Although the states-general issued an edict tolerating both parties and forbidding further dispute, the conflict continued, and the Remonstrants were assailed both by personal enemies and by the political weapons of Maurice of Orange, who executed and imprisoned their leaders for holding republican views. In 1618-19 the synod of Dort (see DORT; SYNOD OF), the thirteen Arminian pastors headed by Simon Episcopius (*q.v.*) being shut out, established the victory of the Calvinist school, drew up ninety-three canonical rules, and confirmed the authority of the Belgic Confession and the Heidelberg Catechism. The judgment of the synod was enforced by the deposition and in some cases the banishment of Remonstrant ministers; but the government soon became convinced that their party was not dangerous to the state, and in 1630 they were formally allowed liberty to reside in all parts of Holland and build churches and schools. In 1621 they had already received liberty to make a settlement in Schleswig, where they built the town of Friedrichstadt. This colony still exists. The doctrine of the Remonstrants was embodied in 1621 in a *confessio* written by Episcopius, their great theologian, while J. Uytenbogaert gave them a catechism and regulated their churchly order. The Remonstrants adopted a simple synodical constitution; but their importance was henceforth more theological than ecclesiastical. Their seminary in Amsterdam had boasted of many distinguished names—Curcellaeus, Limborch, Wetstein, Le Clerc; and their liberal school of theology, which naturally grew more liberal and even rationalistic, reacted powerfully on the state church and on other Christian denominations. The Remonstrants first received official recognition in 1795. As a church they now number 27 communities with about 12,500 members, in a flourishing condition and respected for their traditions of scholarship and liberal thought. Their chief congregation is in Rotterdam.

REMPHAN, the Authorized Version's rendering of the Greek word variously appearing in Acts vii. 48 as Ῥεμφά, Ῥεμφάρ, Ῥεμφάμ, Ῥαίφάρ, Ῥεφάρ. It is part of a quotation from Amos v. 26, where the Septuagint Ῥαυφάρ or Ῥεφάρ stands

for the Hebrew כִּי חַיִּין or Kewan. The Greek forms are probably simple mistakes for the Hebrew, k (?) having been replaced by r (?) and ph (φ) substituted for v (?). Kewan is probably the old Babylonian *Ka(v)awanu*, the planet Saturn, another (the Akkadian) name for which is *Sakkut*, which appears as *Siccuth* in the earlier part of the verse.

REMSCHIED, a town of Germany, in the Prussian Rhine Province, situated on an elevated plateau, 1100 ft. above sea-level, 6 m. by rail S. of Barmen and 20 m. N.E. of Cologne. Pop. (1905) 64,340. Remscheid is a centre of the hardware industry, and large quantities of tools, scythes, skates and other small articles in iron, steel and brass are made for export to all parts of Europe, the East, and North and South America. The name of Remscheid occurs in a document of 1132, and the town received the first impulse to its industrial importance through the immigration of Protestant refugees from France and Holland.

RÉMUSAT, CHARLES FRANÇOIS MARIE, COMTE DE (1797-1875), French politician and man of letters, was born in Paris on the 13th of March 1797. His father, Auguste Laurent, Comte de Rémusat, of a good family of Toulouse, was chamberlain to Napoleon, but acquiesced in the restoration and became prefect first of Haute Garonne, and then of Nord. His mother's maiden name was Claire Élisabeth Jeanne Gravier de Vergennes, born in 1780. She married at sixteen, and was attached to Josephine as *dame du palais* in 1802. Talleyrand was among her admirers, and she was generally recognized as a woman of great intellectual capacity and personal grace. After her death (1824) an *Essai sur l'éducation des femmes* was published and received an *académic couronne*. But it was not until her grandson Paul de Rémusat published her *Mémoires* (3 vols., Paris, 1879-80), which have since been followed by some correspondence with her son (2 vols., 1881), that justice could be done to her literary talent. Much light was thrown on the Napoleonic court by this book, and on the youth and education of her son Charles. He early developed political views more liberal than those of his parents, and, being bred to the bar, published in 1820 a pamphlet on trial by jury. He was an active journalist, showing in philosophy and literature the influence of Cousin, and is said to have furnished to no small extent the original of Balzac's brilliant egoist Henri de Marsay. He signed the journalists' protest against the Ordinances of July 1830, and in the following October was elected deputy for Haute Garonne. He then ranked himself with the *doctrinaires*, and supported most of those measures of restriction on popular liberty which made the July monarchy unpopular with French Radicals. In 1836 he became for a short time under-secretary of state for the interior. He then became an ally of Thiers, and in 1840 held the ministry of the interior for a brief period. In the same year he became an Academician. For the rest of Louis Philippe's reign he was in opposition till he joined Thiers in his attempt at a ministry in the spring of 1848. During this time Rémusat constantly spoke in the chamber, but was still more active in literature, especially on philosophical subjects, the most remarkable of his works being his book on *Abélard* (2 vols., 1843). In 1848 he was elected, and in 1849 re-elected, for Haute Garonne, and voted with the Conservative side. He had to leave France after the *coup d'état*; nor did he re-enter political life during the Second Empire until 1869, when he founded a moderate opposition journal at Toulouse. In 1871 he refused the Vienna embassy offered him by Thiers, but in August he was appointed minister of foreign affairs in succession to M. Jules Favre. Although minister he was not a deputy, and on standing for Paris in September 1873 he was beaten by Désiré Barodet. A month later he was elected (having already resigned with Thiers) for Haute Garonne by a great majority. He died in Paris on the 6th of January 1875.

During his abstinence from politics Rémusat continued to write on philosophical history, especially English. *Saint Anselme de Cantorbéry* appeared in 1854; *L'Angleterre au XVIIIème siècle* in 1856 (2nd ed. enlarged, 1865); *Bacon, sa vie,*

son temps, &c., in 1858; *Channing, sa vie et ses œuvres*, in 1862; *John Wesley* in 1870; *Lord Herbert de Cherbury* in 1874; *Histoire de la philosophie en Angleterre depuis Bacon jusqu'à Locke* in 1875; besides other and minor works. He wrote well, was a forcible speaker and an acute critic; but his adoption of the indeterminate eclecticism of Cousin in philosophy and of the somewhat similarly indeterminate liberalism of Thiers in politics probably limited his powers, though both no doubt accorded with his critical and unenthusiastic turn of mind.

His son PAUL DE RÉMUSAT (1831-1897) became a distinguished journalist and writer. He was for many years a regular contributor to the *Revue des deux mondes*. He stood for election in Haute-Garonne in 1869 in opposition to the imperial policy and failed, but was elected to the National Assembly in 1871 and later. In 1890 he entered the Académie des sciences morales et politiques.

RÉMUSAT, JEAN PIERRE ABEL (1788-1832), French Chinese scholar, was born in Paris on the 5th of September 1788. He was educated for the medical profession, but a Chinese herbal in the collection of the Abbé Tersan attracted his attention, and he taught himself to read it by great perseverance and with imperfect help. At the end of five years' study he produced in 1811 an *Essai sur la langue et la littérature chinoises*, and a paper on foreign languages among the Chinese, which procured him the patronage of Silvestre de Sacy. In 1814 a chair of Chinese was founded at the Collège de France, and Rémusat was placed in it. From this time he gave himself wholly to the languages of the Far East, and published a series of useful works, among which his contributions from Chinese sources to the history of the Tatar nations claim special notice. Rémusat became an editor of the *Journal de savants* in 1818, and founder and first secretary of the Paris Asiatic Society in 1822; he also held various Government appointments. He died at Paris on the 4th of June 1832. A list of his works is given in Quérard's *France littéraire* s.v. *Rémusat*.

RENAISSANCE, THE.—The "Renaissance" or "Renascence" is a term used to indicate a well-known but indefinite space of time and a certain phase in the development of Europe.¹ On the one hand it denotes the transition from that period of history which we call the middle ages (*q.v.*) to that which we call modern. On the other hand it implies those changes in the intellectual and moral attitude of the Western nations by which the transition was characterized. If we insist upon the literal and etymological meaning of the word, the Renaissance was a re-birth; and it is needful to inquire of what it was the re-birth. The metaphor of Renaissance may signify the entrance of the European nations upon a fresh stage of vital energy in general, implying a fuller consciousness and a freer exercise of faculties than had belonged to the medieval period. Or it may mean the resuscitation of simply intellectual activities, stimulated by the revival of antique learning and its application to the arts and literatures of modern peoples. Upon our choice between these two interpretations of the word depend important differences in any treatment of the subject. The former has the disadvantage of making it difficult to separate the Renaissance from other historical phases—the Reformation, for example—with which it ought not to be confounded. The latter has the merit of assigning a specific name to a limited series of events and group of facts, which can be distinguished for the purpose of analysis from other events and facts with which they are intimately but not indissolubly connected. In other words, the one definition of Renaissance makes it denote the whole change which came over Europe at the close of the middle ages. The other confines it to what was known by our ancestors as the Revival of Learning. Yet, when we concentrate attention on the recovery of antique culture, we become aware that this was only one phenomenon or symptom of a far wider and more comprehensive alteration in the conditions of the European races. We find it needful to retain both terms, Renaissance and Revival of Learning, and

¹ For a somewhat different view of the parcelling out into such periods, see the article *MIDDLE AGES*.

to show the relations between the series of events and facts which they severally imply. The Revival of Learning must be regarded as a function of that vital energy, an organ of that mental evolution, which brought into existence the modern world, with its new conceptions of philosophy and religion, its reawakened arts and sciences, its firmer grasp on the realities of human nature and the world, its manifold inventions and discoveries, its altered political systems, its expansive and progressive forces. Important as the Revival of Learning undoubtedly was, there are essential factors in the complex called the Renaissance with which it can but remotely be connected. When we analyse the whole group of phenomena which have to be considered, we perceive that some of the most essential have nothing or little to do with the recovery of the classics. These are, briefly speaking, the decay of those great fabrics, church and empire, which ruled the middle ages both as ideas and as realities; the development of nationalities and languages; the enfeeblement of the feudal system throughout Europe; the invention and application of paper, the mariner's compass, gunpowder, and printing; the exploration of continents beyond the ocean; and the substitution of the Copernican for the Ptolemaic system of astronomy. Europe in fact had been prepared for a thoroughgoing metamorphosis before that new ideal of human life and culture which the Revival of Learning brought to light had been made manifest. It had recovered from the confusion consequent upon the dissolution of the ancient Roman empire. The Teutonic tribes had been Christianized, civilized and assimilated to the previously Latinized races over whom they exercised the authority of conquerors. Comparative tranquillity and material comfort had succeeded to discord and rough living. Modern nationalities, defined as separate factors in a common system, were ready to co-operate upon the basis of European federation. The ideas of universal monarchy and of indivisible Christendom, incorporated in the Holy Roman Empire and the Roman Church, had so far lost their hold that scope was offered for the introduction of new theories both of state and church which would have seemed visionary or impious to the medieval mind. It is therefore obvious that some term, wider than Revival of Learning, descriptive of the change which began to pass over Europe in the 14th and 15th centuries, has to be adopted. That of Renaissance, Rinascimento, or Renascence is sufficient for the purpose, though we have to guard against the tyranny of what is after all a metaphor. We must not suffer it to lead us into rhetoric about the deadness and the darkness of the middle ages, or hamper our inquiry with preconceived assumptions that the re-birth in question was in any true sense a return to the irrecoverable pagan past. Nor must we imagine that there was any abrupt break with the middle ages. On the contrary, the Renaissance was rather the last stage of the middle ages, emerging from ecclesiastical and feudal despotism, developing what was original in medieval ideas by the light of classic arts and letters, holding in itself the promise of the modern world. It was therefore a period and a process of transition, fusion, preparation, tentative endeavour. And just at this point the real importance of the Revival of Learning may be indicated. That rediscovery of the classic past restored the confidence in their own faculties to men striving after spiritual freedom; revealed the continuity of history and the identity of human nature in spite of diverse creeds and different customs; held up for emulation masterworks of literature, philosophy and art; provoked inquiry; encouraged criticism; shattered the narrow mental barriers imposed by medieval orthodoxy. Humanism, a word which will often recur in the ensuing paragraphs, denotes a specific bias which the forces liberated in the Renaissance took from contact with the ancient world,—the particular form assumed by human self-esteem at that epoch,—the ideal of life and civilization evolved by the modern nations. It indicates the endeavour of man to reconstitute himself as a free being, not as the thrall of theological despotism, and the peculiar assistance he derived in this effort from Greek and Roman literature, the *litterae humaniores*, letters leaning rather to the side of man than of divinity.

In this article the Renaissance will be considered as implying a comprehensive movement of the European intellect and will toward self-emancipation, toward reassertion of the natural rights of the reason and the senses, toward the conquest of this planet as a place of human occupation, and toward the formation of regulative theories both for states and individuals differing from those of medieval times. The Revival of Learning will be treated as a decisive factor in this process of evolution on a new plan. To exclude the Reformation and the Counter-Reformation wholly from the survey is impossible. These terms indicate moments in the whole process of modern history which were opposed, each to the other, and both to the Renaissance; and it is needful to bear in mind that they have, scientifically speaking, a quite separate existence. Yet if the history of Europe in the 16th century of our era came to be written with the brevity with which we write the history of Europe in the 6th century A.C., it would be difficult at the distance of time implied by that supposition to distinguish the Italian movement of the Renaissance in its origin from the German movement of the Reformation. Both would be seen to have a common starting-point in the reaction against long dominant ideas which were becoming obsolete, and also in the excitation of faculties which had during the same period been accumulating energy.

The Renaissance, if we try to regard it as a period, was essentially the transition from one historical stage to another. It cannot therefore be confined within strict chronological limits. There is one date, however, which may be remembered with advantage as the starting-point in time of the Renaissance, after the departure from the middle ages had been definitely and consciously made by the Italians. This is the year 1453, when Constantinople, chosen for his capital by the first Christian emperor of Rome, fell into the hands of the Turk. One of the survivals of the old world, the shadow of what had been the Eastern Empire, now passed suddenly away. Almost at the same date that visionary revival of the Western Empire, which had imposed for six centuries upon the imagination of medieval Europe, hampering Italy and impeding the consolidation of Germany, ceased to reckon among political actualities; while, more robust a rival, the Roman Church, seemed likely to sink into the rank of a petty Italian principality. It was demonstrated by the destruction of the Eastern Empire, the dotage of the Western Empire, and by the new papal policy which Nicholas V. inaugurated, that the old order of society was about to be superseded. Nothing remained to check those centrifugal forces in state and church, which substituted a confederation of rival European powers for the earlier ideal of universal monarchy, and separate religious constitutions for the previous Catholic unity. At the same time the new learning introduced by the earlier humanists awakened free thought, encouraged curiosity, and prepared the best minds of Europe for speculative audacities from which the schoolmen were averse, and which soon expressed themselves in acts of cosmopolitan importance. If we look a little forward to the years 1492-1500, we obtain a second date of great importance. In these years the expedition of Charles VIII. to Naples opened Italy to French, Spanish and German interference. The leading nations of Europe began to compete for the prize of the peninsula, and learned meanwhile that culture which the Italians had perfected. In these years the secularization of the papacy was carried to its final point by Alexander VI., and the Reformation became inevitable. The same period was marked by the discovery of America, the exploration of the Indian seas, and the consolidation of the Spanish nationality. It also witnessed the application of printing to the diffusion of knowledge. Thus, speaking roughly, the half-century between 1450 and 1500 may be termed the culminating point of the Renaissance. The transition from the medieval to the modern order was now secured if not accomplished, and a Rubicon had been crossed from which no retrogression to the past was possible. Looking yet a little farther, to the years 1527 and 1530, a third decisive date is reached. In the first of these years happened the sack of Rome, in the second the pacification of Italy by Charles V. under a Spanish hegemony. The age of the Renaissance was now closed for the land which gave it birth. The Reformation had taken firm hold on northern Europe. The Counter-Reformation was already imminent.

It must not be imagined that so great a change as that implied by the Renaissance was accomplished without premonitory symptoms and previous endeavours. In the main we mean by it the recovery of freedom for the human spirit after a long period of bondage to oppressive ecclesiastical and political orthodoxy—a return to the liberal and practical conceptions of the world which

the nations of antiquity had enjoyed, but upon a new and enlarged platform. This being so, it was inevitable that the finally successful efforts after self-emancipation should have been anticipated from time to time by strivings within the ages that are known as dark and medieval. It is therefore part of the present inquiry to pass in review some of the claimants to be considered precursors of the Renaissance.

First of all must be named the Frank in whose lifetime the dual conception of universal empire and universal church, divinely appointed, and inviolable, began to control the order of European society. Charles the Great (Charlemagne) lent his forces to the plan of resuscitating the Roman empire at a moment when his own power made him the arbiter of western Europe, when the papacy needed his alliance, and when the Eastern Empire had passed under the usurped regency of a female. He modelled an empire, Roman in name but essentially Teutonic, since it owed such substance as its fabric possessed to Frankish armies and the sinews of the German people. As a structure composed of divers ill-connected parts it fell to pieces at its builder's death, leaving little but the incubus of a memory, the fascination of a mighty name, to dominate the mind of medieval Europe. As at the empire grew in visionary power, and remained one of the chief obstacles in the way of both Italian and German national coherence. Real force was not in it, but rather in that counterpart to its unlimited pretensions, the church, which had evolved it from barbarian night, and which used her own more vital energies for undermining the rival of her creation. Charles the Great, having proclaimed himself successor of the Caesars, was obscurely ambitious of imitating the Augusti also in the sphere of letters. He caused a scheme of humanistic education to be formulated, and gave employment at his court to rhetoricians, of whom Alcuin was the most considerable. But very little came of the revival of learning which Charles is supposed to have encouraged; and the empire he restored was accepted by the medieval intellect in a crudely theological and vaguely mystical spirit. We should, however, here remember that the study of Roman law, which was one important precursory symptom of the Renaissance, owed much to medieval respect for the empire as a divine institution. This, together with the municipal Italian intolerance of the Lombard and Frankish codes, kept alive the practice and revived the science of Latin jurisprudence at an early period.

Philosophy had attempted to free itself from the trammels of theological orthodoxy in the hardy speculations of some schoolmen, notably of Scotus Erigena and Abelard. These innovators found, however, small support, and were defeated by opponents who used the same logical weapons with authority and success. Nor were the rationalistic opinions of the Averroists without their value, though the church condemned these deviators from her discipline as heretics. Such medieval materialists, moreover, had but feeble hold upon the substance of real knowledge. Imperfect acquaintance with authors whom they studied in Latin translations made by Jews from Arabic commentaries on Greek texts, together with almost total ignorance of natural laws, condemned them to sterility. Like the other scholasticists of their epoch, they fought with phantoms in a visionary realm. A similar judgment may be passed upon those Paulician, Albigensian, Paterine and Epicurean dissenters from the Catholic creed who opposed the phantasies of orthodoxy with frail imaginative weapons, and alarmed established orders in the state by the audacity of their communistic opinions. Physical science struggled into feeble life in the cells of Gerbert and Roger Bacon. But these men were accounted magicians by the vulgar; and, while the one eventually assumed the tiara, the other was incarcerated in a dungeon. The schools meanwhile resounded still to the interminable dispute upon abstractions. Are only universals real, or has each name a corresponding entity? From the midst of the Franciscans who had persecuted Roger Bacon because he presumed to know more than was consistent with human humility arose John of Parma, adopting and popularizing the mystic prophecy of Joachim of Flora. The reign of the Father is past; the reign of the Son is passing; the reign of the Spirit is at hand. Such was the formula of the Eternal Gospel, which, as an unconscious forecast of the Renaissance, has attracted retrospective students by its felicity of adaptation to their historical method. Yet we must remember that this bold intuition of the abbot Joachim indicated a monastic reaction against the tyrannies and corruptions of the church, rather than a fertile philosophical conception. The Fratelli spiritualists, and similar sects who fed their imagination with his doctrine, expired in the flames to which Fra Dolcino Longino and Margherita were consigned. To what extent the accusations of profane morals brought against these reforming sectarians were justified remains doubtful; and the same uncertainty rests upon the alleged iniquities of the Templars. It is only certain that at this epoch the fabric of Catholicism was threatened with various forms of prophetic and Oriental mysticism, symptomatic of a widespread desire to grasp at something simpler, purer and less rigid than Latin theology afforded. Devoid of criticism, devoid of sound learning, devoid of a firm hold on the realities of life, these heresies passed away without solid results and were forgotten.

Speculation and heresy in the middle ages.

We are too apt to take for granted that the men of the middle ages were immersed in meditations on the other world, and that their intellectual exercises were confined to abstractions of the schools, hallucinations of the fancy, allegories, visions. This assumption applies indeed in a broad sense to that period which was dominated by intolerant theology and deprived of positive knowledge. Yet there are abundant signs that the native human instincts, the natural human appetites, revolted unaltered and alive beneath the crust of orthodoxy.

In the person of a pope like Boniface VIII, those ineradicable forces of the natural man assumed, if we may trust the depositions of ecclesiastics well acquainted with his life, a form of brutal atheistic cynicism. In the person of an emperor, Frederick II, they emerged under the more agreeable garb of liberal culture and Epicurean scepticism. Frederick dreamed of remodelling society upon a mundane type, which anticipated the large toleration and cosmopolitan enlightenment of the actual Renaissance. But his efforts were defeated by the unrelenting hostility of the church, and by the incapacity of his contemporaries to understand his aims. After being forced in his lifetime to submit to authority, he was consigned by Dante to hell. Frederick's ideal of civilization was derived in a large measure from Provence, where a beautiful culture had prematurely bloomed, filling southern Europe with the perfume of poetry and gentle living. Here, if anywhere, it seemed as though the ecclesiastical and feudal fetters of the middle ages might be broken, and humanity might enter on a new stage of joyous unimpeded evolution. This was, however, not to be. The church preached Simon de Montfort's crusade, and organized Dominic'squisition; while Quine, east of the Renaissance, crucified the world's Amour was extinguished by sword, fire, famine and pestilence. Meanwhile the Provençal poets had developed their modern language with incomparable richness and dexterity, creating forms of verse and modes of emotional expression which determined the latest medieval phase of literature in Europe. The naturalism of which we have been speaking found free utterance now in the fabliaux of jongleurs, lyrics of minnesingers, tales of trouvères, romances of Arthur and his knights—compositions varied in type and tone, but in all of which sincere passion and real enjoyment of life pierce through the veil of chivalric mysticism or of allegory, with which they were sometimes conventionally clothed. The tales of Lancelot and Tristan, the lives of the troubadours and the Wachtlied of the minnesingers, sufficiently prove with what sensual freedom a knight loved the lady whom custom and art made him profess to worship as a saint. We do not need to be reminded that Beatrice's adorer had a wife and children, or that Laura's poet owned a son and daughter by a concubine, in order to perceive that the mystic passion of chivalry was compatible in the middle ages with commonplace matrimony or vulgar illegitimate connexions. But perhaps the most convincing proof of the presence of this ineradicable naturalism is afforded by the Latin songs of wandering students, known as *Carmina Burana*, written by the self-styled Goliardi. In these compositions, remarkable for their facile handling of medieval Latin rhymes and rhythms, the allegorizing mysticism which envelops chivalrous poetry is discarded. Love is treated from a frankly carnal point of view. Bacchus and Venus go hand in hand, as in the ancient ante-Christian age. The open-air enjoyments of the wood, the field, the dance upon the village green, are sung with juvenile lightheartedness. No grave note warns that the pleasures of the earth are fleeting, that the visible world but a bubble of the invisible, that human life is a probation for the life beyond, interrupts the tinkling music as of castanets and tripping feet which gives a novel charm to these unique relics of the 13th century. Goliardi poetry is further curious as showing how the classics even at that early period were a fountain-head of pagan inspiration. In the taverns and low places of amusement haunted by those lettered songsters, on the open road and in the forests trodden by their vagrant feet, the deities of Greece and Rome were not in exile, but at home within the hearts of living men. Thus, while Christendom was still preoccupied with the Crusades, two main forces of the Renaissance, naturalism and enthusiasm for antique modes of feeling, already brought their latent potency to light, prematurely indeed and precociously, yet with a promise that was destined to be kept.

When due regard is paid to these miscellaneous evidences of intellectual and sensual freedom during the middle ages, it will be seen that there were by no means lacking elements of native vigour ready to burst forth. What was wanting was not vitality and licence, not audacity of speculation, nor the least insatiable and rebellious impulse. It was rather the right touch on life, the right feeling for human independence, the right way of approaching the materials of philosophy, religion, scholarship and literature, that failed. The courage that is born of knowledge, the calm strength begotten by a positive attitude of mind, face to face with the dominant over-shadowing Sphinx of theology, were lacking. We may fairly say that natural and untaught people had more of the just intuition that was needed than learned folk trained in the schools. But these people were rendered licentious in revolt or impotent for salutary action by ignorance, by terror, by uneasy dread of the doom declared for heretics and rebels. The

Naturalism in medieval life and literature.

massive vengeance of the church hung over them, like a heavy sword suspended in the cloudy air. Superstition and stupidity hedged them in on every side, so that sorcery and magic seemed the only means of winning power over nature or insight into mysteries surrounding human life. The path from darkness to light was lost; thought was involved in allegory; the study of nature had been perverted into an inept system of grotesque and pious parable-mongering; the pursuit of truth had become a game of wordy dialectics. The other world, with its imagined heaven and hell, haunted the conscience like a nightmare. However sweet this world seemed, however fair the flesh, both world and flesh were theoretically given over to the devil. It was not worth while to master and economize the resources of this earth, to utilize the good and ameliorate the evils of this life, while every one agreed, in theory at any rate, that the present was but a bad prelude to an infinitely worse or infinitely better future. To escape from these preoccupations and prejudices except upon the path of conscious and deliberate sin was impossible for all but minds of rarest quality and courage; and these were too often reduced to the recantation of their supposed errors no less by some secret clinging sense of guilt than by the church's iron hand. Man and the actual universe kept on reasserting their rights and claims, announcing their goodness and delightfulness, in one way or another; but they were always being thrust back again into Cimmerian regions of abstractions, fictions, visions, spectral hopes and fears, in the midst of which the intellect somnambulistically moved upon an unknown way.

At this point the Revival of Learning intervened to determine the course of the Renaissance. Medieval students possessed a considerable portion of the Latin classics, though *Italy—the Greek had become in the fullest sense of the phrase Revival of Learning* a dead language. But what they retained of ancient literature they could not comprehend in the right spirit. Between them and the text of poet or historian hung a veil of mysticism, a vapour of misapprehension. The odour of unsanctity clung around those relics of the pagan past. Men bred in the cloister and the lecture-room of the logicians, trained in scholastic disputations, versed in allegorical interpretations of the plainest words and most apparent facts, could not find the key which might unlock those stores of wisdom and of beauty. Petrarch first opened a new method in scholarship, and revealed what we denote as humanism. In his teaching lay the twofold discovery of man and of the world. For humanism, which was the vital element in the Revival of Learning, consists mainly of a just perception of the dignity of man as a rational, volitional and sentient being, born upon this earth with a right to use it and enjoy it. Humanism implied the rejection of those visions of a future and imagined state of souls as the only absolute reality, which had fascinated the imagination of the middle ages. It involved a vivid recognition of the goodness of man and nature, displayed in the great monuments of human power recovered from the past. It stimulated the curiosity of latent sensibilities, provoked fresh inquisition into the groundwork of existence, and strengthened man's self-esteem by knowledge of what men had thought and felt and done in ages when Christianity was not. It roused a desire to reappropriate the whole abandoned provinces of mundane energy, and a hope to emulate antiquity in works of living loveliness and vigour. The Italians of the 14th century, more precocious than the other European races, were ripe for this emancipation of enslaved intelligence. In the classics they found the food which was required to nourish the new spirit; and a variety of circumstances, among which must be reckoned the pride of a nation boasting of its descent from the Populus Romanus, rendered them apt to fling aside the obstacles that had impeded the free action of the mind through many centuries. Petrarch not only set his countrymen upon the right method of studying the Latin classics, but he also divined the importance of recovering a knowledge of Greek literature. To this task Boccaccio addressed himself; and he was followed by numerous Italian enthusiasts, who visited Byzantium before its fall as the sacred city of a new revelation. The next step was to collect MSS., to hunt out, copy and preserve the precious relics of the past. In this work of accumulation Guarino and Filelfo, Aurispa and Poggio, took the chief part, aided by the wealth of Italian patricians, merchant-princes and despots, who were inspired by the sacred thirst for learning. Learning was then

Italy—the Revival of Learning.

no mere pursuit of a special and recluse class. It was fashionable and it was passionate, pervading all society with the fervour of romance. For a generation nursed in decadent scholasticism and stereotyped theological formulae it was the fountain of renaissance youth, beauty and freedom, the shape in which the Helen of art and poetry appeared to the ravished eyes of medieval Faustus. It was the resurrection of the mightiest spirits of the past. "I go," said Cyriac of Ancona, the indefatigable though uncritical explorer of antiquities, "I go to awake the dead!" This was the enthusiasm, this the vitalizing faith, which made the work of scholarship in the 15th century so highly strung and ardent. The men who followed it knew that they were restoring humanity to its birthright after the expatriation of ten centuries. They were instinctively aware that the effort was for liberty of action, thought and conscience in the future. This conviction made young men leave their loves and pleasures, grave men quit their counting-houses, churchmen desert their missals, to crowd the lecture-rooms of philologists and rhetoricians. When Greek had been acquired, MSS. accumulated, libraries and museums formed, came the age of printers and expositors. Aldus Manutius in Italy, Froben in Basel, the Étiennees in Paris, committed to the press what the investigators had recovered. Nor were there wanting men who dedicated their powers to Hebrew and Oriental erudition, laying, together with the Grecians, a basis for those Biblical studies which advanced the Reformation. Meanwhile the languages of Greece and Rome had been so thoroughly appropriated that a final race of scholars, headed by Politian, Pontano, Valla, handled once again in verse and prose both antique dialects, and thrilled the ears of Europe with new-made pagan melodies. The church itself at this epoch lent its influence to the prevalent enthusiasm. Nicholas V. and Leo X., not to mention intervening popes who showed themselves tolerant of humanistic culture, were heroes of the classical revival. Scholarship became the surest path of advancement to ecclesiastical and political honours. Italy was one great school of the new learning at the moment when the German, French and Spanish nations were invited to her feast.

It will be well to describe briefly, but in detail, what this meeting of the modern with the ancient mind effected over the whole field of intellectual interests. In doing so, we must be careful to remember that the study of the classics did but give a special impulse to pent-up energies which were bound in one way or another to assert their independence. Without the Revival of Learning the direction of those forces would have been different; but that novel intuition into the nature of the world and man which constitutes what we describe as Renaissance must have emerged. As the facts, however, stand before us, it is impossible to dissociate the rejection of the other world as the sole reality, the joyous acceptance of this world as a place to live and act in, the conviction that "the proper study of mankind is man," from humanism. Humanism, as it actually appeared in Italy, was positive in its conception of the problems to be solved, pagan in its contempt for medieval mysticism, invigorated for sensuous enjoyment by contact with antiquity, yet holding in itself the germ of new religious aspirations, profounder science and sterner probings of the mysteries of life than had been attempted even by the ancients. The operation of this humanistic spirit has now to be traced.

It is obvious that Italian literature owed little at the outset to the Revival of Learning. The *Divine Comedy*, the *Canzoniere* and the *Decameron* were works of monumental art, deriving neither form nor inspiration immediately from the classics, but applying the originality of Italian genius to matter drawn from previous medieval sources. Dante showed both in his epic poem and in his lyrics that he had not abandoned the sphere of contemporary thought. Allegory and theology, the vision and the symbol, still determine the form of masterpieces which for perfection of workmanship and for emancipated force of intellect rank among the highest products of the human mind. Yet they are not medieval in the same sense as the song of Roland or the

Arthurian cycle. They proved that, though Italy came late into the realm of literature, her action was destined to be decisive and alterative by the introduction of a new spirit, a firmer and more positive grasp on life and art. These qualities she owed to her material prosperity, to her freedom from feudalism, to her secularized church, her commercial nobility, her political independence in a federation of small states. Petrarck and Boccaccio, though they both held the medieval doctrine that literature should teach some abstract truth beneath a veil of fiction, differed from Dante in this that their poetry and prose in the vernacular abandoned both allegory and symbol. In their practice they ignored their theory. Petrarck's lyrics continue the Provençal tradition as it had been reformed in Tuscany, with a subtler and more modern analysis of emotion, a purer and more chastened style, than his masters could boast. Boccaccio's tales, in like manner, continue the tradition of the fabliaux, raising that literary species to the rank of finished art, enriching it with humour and strengthening its substance by keen insight into all varieties of character. The *Canzoniere* and the *Decameron* distinguish themselves from medieval literature, not by any return to classical precedents, but by free self-conscious handling of human nature. So much had to be premised in order to make it clear in what relation humanism stood to the Renaissance, since the Italian work of Dante, Petrarck and Boccaccio is sufficient to indicate the re-birth of the spirit after ages of apparent deadness. Had the Revival of Learning not intervened it is probable that the vigorous efforts of these writers alone would have inaugurated a new age of European culture. Yet, while noting this reservation of judgment, it must also be remarked that all three felt themselves under some peculiar obligation to the classics. Dante, medieval as his temper seems to us, chose Virgil for his guide, and ascribed his mastery of style to the study of Virgilian poetry. Petrarck and Boccaccio were, as we have seen, the pioneers of the new learning. They held their writings in the vernacular cheap, and initiated that contempt for the mother tongue which was a note of the earlier Renaissance. Giovanni Villani, the first chronicler who used Italian for the compilation of a methodical history, tells us how he was impelled to write by musing on the ruins of Rome and thinking of the vanished greatness of the Latin race. We have therefore to recognize that the four greatest writers of the 14th century, while the Revival of Learning was yet in its cradle, each after his own fashion acknowledged a certain reverence for the spirit of the antique genius. They seem to have been conscious that they could not give the desired impulse to modern literature and art without contact with the classics; and, in spite of the splendour of their achievements in Italian, they found no immediate followers upon that path.

The fascination of pure study was so powerful, the Italians at that epoch were so eager to recover the past, that during the 15th century we have before our eyes the spectacle of this great nation deviating from the course of development begun in poetry by Dante and Petrarck, in prose by Boccaccio and Villani, into the channels of scholarship and antiquarian research. The language of the *Canzoniere* and *Decameron* was abandoned for revived Latin and discovered Greek. Acquisition supplanted invention; imitation of classical authors suppressed originality of style. The energies of the Italian people were devoted to transcribing codices, setting texts, translating Greek books into Latin, compiling grammars, commentaries, encyclopaedias, dictionaries, epitomes and ephemerides. During this century the best histories—Bruno's and Poggio's annals of Florence, for example—were composed in Latin after the manner of Livy. The best dissertations, Landino's *Comediarum*, Valla's *De Voluptate*, were laboured imitations of *Frontinus*. The language of the best Pontano elegies, Politian's hexameters, were in like manner Latin; public orations upon ceremonial occasions were delivered in the Latin tongue; correspondence, official and familiar, was carried on in the same language; even the fabliaux received, in Poggio's *Facetae*, a dress of elegant Latinity. The noticeable barrenness of Italian literature at this period is referable to the fact that men of genius and talent devoted themselves to erudition and struggled to express their thoughts and feelings in a speech which was not natural. Yet they were engaged in a work of incalculable importance. At the close of the 15th century the knowledge of Greece and Rome had been reappropriated and placed beyond the possibility of destruction; the chasm between the old and new world had been bridged; medieval modes of thinking and discussing had been superseded; the staple of education, the common culture which has brought all Europe into intellectual agreement, was already in existence. Humanism was now an actuality. Owing to the uncritical veneration for antiquity which then prevailed, it had received a strong tincture of pedantry. Its professors, in their revolt against the middle ages, made light of Christianity and paraded paganism. What was worse from an artistic point of view, they had contracted pedantic style, varieties of rhetorical stupidities, wearisome citation. Still, at the opening of the 16th century, it became manifest what fruits of noble quality the Revival of Letters was about to bring forth for modern literature. Two great scholars, Lorenzo de' Medici and Politian, had already returned to the

Relation
of human-
ism to
scholar-
ship
and
literature.

practice of Italian poetry. Their work is the first absolutely modern work,—modern in the sense of having absorbed the stores of classic learning and reproduced those treasures in forms of simple, natural, native beauty. Boiardo occupies a similar position by the fusion of classic mythology with chivalrous romance in his *Orlando Innamorato*. But the victor's laurels were reserved for Ariosto, whose *Orlando Furioso* is the purest and most perfect extant example of Renaissance poetry. It was not merely in what they had added and assimilated to the classic that these poets showed the transformation effected in the field of literature by humanism. The whole method and spirit of medieval art had been abandoned. That of the Cinque Cento is positive, defined, mundane. The deity, if deity there be, that rules in it, is beauty. Interest is confined to the actions, passions, sufferings and joys of human life, to its pathetic, tragic, humorous and sentimental incidents. Of the state of souls beyond the grave we hear and are supposed to care nothing. In the drama the pedantry of the Revival, which had not injured romantic literature, made itself perniciously felt. Rules were collected from Horace and Aristotle. Seneca was chosen as the model of tragedy; Plautus and Terence supplied the groundwork of comedy. Thus in the plays of Uccellini, Trissino, Sperone and other tragic poets the nobler elements of humanism, considered as a revelation of the world and man, obtained no free development. Even the comedies of the best authors are too observant of Latin precedents, although some pieces of Machiavelli, Ariosto, Arcinno, Cecchi and Gelli are admirable for vivid delineation of contemporary manners.

The relation of the plastic arts to the revival of learning is similar to that which has been sketched in the case of poetry. Cimabue started with work which owed nothing directly to antiquity. *Fine arts.* At about the same time Nicola Pisano (d. 1278) studied the style of sculpture in fragments of Graeco-Roman marbles. His manner influenced Giotto, who set painting on a forward path. Fortunately for the unimpeded expansion of Italian art, little was brought to light of antique workmanship during the 14th and 15th centuries. The classical stimulus came to painters, sculptors and architects chiefly through literature. Therefore there was narrow scope for imitation, and the right spirit of humanism displayed itself in a passionate study of perspective, nature and the nude. At the same time the works of Ghiberti and Alberti we notice in the masterpieces of these men and their compere Brunelleschi and Donatello, how even in the 15th century the minds of artists were fascinated by what survived of classic grace and science. Gradually, as the race became penetrated with antique thought, the earlier Christian motives of the arts yielded to pagan subjects. Gothic architecture, which had always flourished feebly on Italian soil, was supplanted by a hybrid Roman style. The study of Vitruvius gave strong support to that pseudo-classic manner which, when it had reached its final point in Palladio's work, overspread the whole of Europe and dominated taste during two centuries. But the perfect plastic art of Italy, the pure art of the Cinque Cento, the painting of Raphael, Da Vinci, Titian and Correggio, the sculpture of Donatello, Michelangelo and Sansovino, the architecture of Bramante, Omodeo and the Venetian Lombardi, however much imbued with the spirit of the classical revival, takes rank beside the poetry of Ariosto as a free intelligent product of the Renaissance. That is to say, it is not so much an outcome of studies in antiquity as an exhibition of emancipated modern genius freed and illuminated by the masterpieces of the past. It indicates a separation from the middle ages, inasmuch as it is a distinctly modern nature. Its religion is joyous, sentiment dramatic, terrible, but in each and all of its many-sided manifestations strictly human. Its touch on classical mythology is original, rarely imitative or pedantic. The art of the Renaissance was an apocalypse of the beauty of the world and man in unaffected spontaneity, without side thoughts for piety or erudition, inspired by pure delight in loveliness and harmony for their own sakes.

In the fields of science and philosophy humanism wrought similar important changes. Petrarch began by waging relentless war against the logicians and materialists of his own day. *Science and philosophy.* With the advance made in Greek studies, scholastic methods of thinking fell into contemptuous oblivion. The newly aroused curiosity for nature encouraged men like Alberti. Da Vinci, Toscanelli and Da Porta to make practical experiments, penetrate the working of physical forces, and invent scientific instruments. Anatomy began to be studied, and the time was not far distant when Titian should lend his pencil to the epoch-making treatise of Vesalius. The middle ages had been satisfied with absurd and visionary notions about the world around them, while the body of man was regarded with too much suspicion to be studied. Not the right method of investigation, but the patience and loving admiration was instituted. At the same time the texts of ancient authors supplied hints which led to discoveries so far-reaching in their results as those of Copernicus, Columbus and Galileo. In philosophy, properly so called, the humanistic scorn for medieval dullness and obscurity swept away theological metaphysics as valueless. But at first little beyond empty rhetoric and clumsy compilation was substituted. The ethical treatises of the scholars are deficient in substance, while Ficino's attempts

to revive Platonism betrays an uncritical conception of his master's drift. It was something, however, to have shaken off the shackles of ecclesiastical authority; and, even if a new authority, that of the ancients, was accepted in its stead, still progress was being made toward sounder methods of analysis. This is noticeable in Pomponazzi's system of materialism, based on the interpretation of Aristotle, but revealing a virile spirit of disinterested and unprejudiced research. The thinkers of southern Italy, Telesio, Campanella, and Cassanella, at last opened the closed world of modern speculation has since moved. Telesio and Campanella may be termed the predecessors of Bacon. Bruno was the precursor of the idealistic schools. All three alike strove to disengage their minds from classical as well as ecclesiastical authority, proving that the emancipation of the will had been accomplished. It must be added that their writings, like every other product of the Renaissance, except its purest poetry and art, exhibit a hybrid between medieval and modern tendencies. Childish ineptitudes are mingled with intuitions of matured wisdom, and seeds of future thought germinate in the decaying refuse of past systems.

Humanism in its earliest stages was uncritical. It absorbed the relics of antiquity with omnivorous appetite, and with very imperfect sense of the distinction between worse and better work. Yet it led in process of time to criticism. *Criticism.* Critique of literature began in the lecture-room of Politian, in the printing-house of Aldus, and in the school of Vittorino. The critique of Roman law started, under Politian's auspices, upon a more liberal course than that which had been followed by the powerful but narrow-sighted glossators of Bologna. Finally, in the court of Naples arose that formidable array of critical engines, the critique of established ecclesiastical traditions and spurious historical documents. Valla by one vigorous effort destroyed the False Decretals and exposed the Donation of Constantine to ridicule, paving the way for the polemic carried on against the dubious pretensions of the papal throne by scholars of the Reformation. A similar criticism, conducted less on lines of erudition than of persiflage and irony, ransacked the moral abuses of the church and played around the very foundations of Christianity. This was tolerated with approval by men who repeated Leo X.'s witty epigram: "What profit has men that fable of Christ brought us!" The same critical and philological spirit working upon the materials of history produced a new science, the history of the books which belong to Machiavelli. He showed, on the one side, how the history of a people can be written with a recognition of fixed principles, and at the same time with an artistic feeling for personal and dramatic episodes. On the other side, he addressed himself to the analysis of man considered as a political being, to the anatomy of constitutions and the classification of governments, to the study of motives underlying public action, the secrets of success and the causes of failure in the conduct of affairs. The unscrupulous rigour with which he applied the scientific method, and the sinister deductions he thought himself justified in drawing from the results yielded, excited terror and repulsion. Nevertheless, a department had been added to the intellectual empire of mankind, in which fellow-workers, like Guicciardini at Florence, and subsequently Sarpi at Venice, were not slow to follow the path traced by Machiavelli.

The object of the foregoing paragraphs has been to show in what way the positive, inquisitive, secular, exploratory spirit of the Renaissance, when toned and controlled by humanism, penetrated the various regions of literature, art, and science. *Education.* It becomes at this point of much moment to consider how social manners in Italy were modified by the same causes, since the type developed there was in large measure communicated together with the new culture to the rest of Europe. The first subject to be noticed under this heading is education. What has come to be called a classical education was the immediate product of the Italian Renaissance. The universities of Bologna, Padua and Salerno had been famous through the middle ages for the study of law, physics and medicine; and during the 15th and 16th centuries the first two still enjoyed celebrity in these faculties. But at this period no lecture-rooms were so crowded as those in which professors of antique literature and language read passages from the poets and orators, taught Greek, and commented upon the systems of philosophers. The medieval curriculum offered no defined place for the new learning of the Revival, which had indeed no recognized name. Chairs had therefore to be founded under the title of rhetoric, from which men like Chrysoloras and Guarino, Filelfo and Politian expounded orally to hundreds of eager students from every town of Italy and every nation in Europe, their accumulated knowledge of antiquity. On a mass of Greek and Latin erudition, including the right method of metaphysics, law and science, civic institutions and the art of war, mythology and magistracies, metrical systems and oratory, agriculture and astronomy, domestic manners and religious rites, grammar and philology, biography and numismatics, formed the miscellaneous subject-matter of this so-styled rhetoric. Notes taken at these lectures supplied young scholars with hints for further exploration; and a certain tradition of treating antique authors for the display of general learning, as well as for the elucidation of their texts, came into vogue, which has

determined the method of scholarship for the last three centuries in Europe. The lack of printed books in the first period of the Revival, and the comparative rarity of Greek erudition among students, combined with the intense enthusiasm aroused for the new gospel of the classics, gave special value to the personal teaching of these professors. They journeyed from city to city, attracted by promises of higher pay, and allured by ever-growing laurels of popular fame. Each large town established its public study, academy or university, similar institutions under varying designations, for the exposition of the *literæ humaniores*. The humanists, or professors of that branch of knowledge, became a class of the highest dignity. They were found in the chambers of the republics, in the papal curia, in the council chambers of princes, at the headquarters of condottieri, wherever business had to be transacted, speeches to be made and the work of secretaries to be performed. Furthermore, they undertook the charge of private education, opening schools which displaced the medieval system of instruction, and taking engagements as tutors in the families of despots, noblemen and wealthy merchants. The academy established by Vittorino da Feltra at Mantua under the protection of Gian Francesco Gonzaga for the training of pupils of both sexes, might be chosen as the type of this Italian method. His scholars, who were lodged in appropriate buildings, met daily to hear the master read and comment on the classics. They learned portions of the best authors by heart, exercised themselves in translation from one language to another, and practised composition in prose and verse. It was Vittorino's care to see that, while their memories were duly stored with words and facts, their judgment should be formed by critical analysis, attention to style, and comparison of the authors of a decadent age with those who were acknowledged classics. During the hours of recreation suitable physical exercises, as fencing, riding and gymnastics, were conducted under qualified trainers. From this sketch it will be seen how closely the educational system which came into England during the reigns of the Tudors, and which has prevailed until the present time, was modelled upon the Italian type. English youths who spend their time at Eton between athletic sports and Latin verses, and who take an Ireland with a first class in "Greats" at Oxford, are pursuing the same course of physical and mental discipline as the princes of Gonzaga or Montefelro in the 15th century.

The humanists effected a deeply penetrating change in social manners. Through their influence as tutors, professors, orators and courtiers, society was permeated by a fresh ideal of culture. To be a gentleman in Italy meant at this epoch to be a man acquainted with the rudiments at least of scholarship, refined in diction, capable of corresponding or of speaking in choice phrases, open to the beauty of the arts, intelligently interested in archaeology, taking for his models of conduct the great men of antiquity rather than the saints of the church. He was also expected to prove himself an adept in the same course of physical and courteous observances which survived from chivalry. The type is set before us by Castiglione in that book upon the courtier which went the round of Europe in the 16th century. It is further emphasized in a famous passage of the *Orlando Innamorato* where Boiardo compares the Italian ideal of an accomplished gentleman with the coarser type admired by nations of the north. To this point the awakened intelligence of the Renaissance, instructed by humanism, polished by the fine arts, expanding in genial conditions of diffused wealth, had brought the Italians at a period when the rest of Europe was comparatively barbarous.

This picture has undoubtedly a darker side. Humanism, in its revolt against the middle ages, was, as we have seen already, a non-dance, a non-dance, a non-dance, a non-dance, a non-dance. The moral defects of the Italian Renaissance, as after all, be regarded only as a period of transition in which much of the good of the past was sacrificed while some of the evil was retained, and neither the bad nor the good of the future was brought clearly into fact. Beneath the surface of brilliant social culture lurked gross appetites and savage passions, unrestrained by medieval piety, untutored by modern experience. Italian society exhibited an almost unexampled spectacle of literary, artistic and courtly refinement crossed by brutalities of lust, treasons, poisonings, assassinations, violence. A succession of worldly pontiffs brought the church into flagrant discord with the principles of Christianity. Steeped in pagan learning, emulous of imitating the manners of the ancients, used to think and feel in harmony with Ovid and Theocritus, and at the same time rendered cynical by the corruption of papal Rome, the educated classes lost their grasp upon morality. Political honesty ceased almost to have a name in Italy. The Christian virtues were scorned by the foremost actors and the ablest thinkers of the time, while the antique virtues were themes for rhetoric rather than moving-springs of conduct. This is apparent to all students of Machiavelli and Guicciardini, the profoundest analysts of their age, the bitterest satirists of its vices, but themselves infected with its incapacity for moral goodness. Not only were the Italians vitiated; but they had also become impotent for action and resistance. At the height of the Renaissance the five great powers in the peninsula formed a confederation of independent but mutually attractive and repellent states. Equilibrium was

maintained by diplomacy, in which the humanists played a foremost part, casting a network of intrigue over the nation which helped in no small measure to stimulate intelligence and create a common medium of culture, but which accustomed statesmen to believe that everything could be achieved by wire-pulling. Wars were conducted on a showy system by means of mercenaries, who played a safe game in the field and developed a system of bloodless campaigns. Meanwhile the people grew up unused to arms. When Italy between the years 1494 and 1530 became the battlefield of French, German and Spanish forces, it was seen to what a point of helplessness the political, moral and social conditions of the Renaissance had brought the nation.

It was needful to study at some length the main phenomena of the Renaissance in Italy, because the history of that phase of evolution in the other Western races turns almost entirely upon points in which they either adhered to or diverged from the type established there. Speaking broadly, what France, Germany, Spain and England assimilated from Italy at this epoch was in the first place the new learning, as it was then called. This implied the new conception of human life, the new interest in the material universe, the new method of education, and the new manners, which we have seen to be inseparable from Italian humanism. Under these forms of intellectual enlightenment and polite culture the renaissance of the human spirit had appeared in Italy, where it was more than elsewhere connected with the study of classical antiquity. But that audacious exploratory energy which formed the motive force of the Renaissance as distinguished from the Revival of Learning took, as we shall see, very different directions in the several nations who now were sending the flower of their youth to study at the feet of Italian rhetoricians.

The Renaissance ran its course in Italy with strange indifference to consequences. The five great powers, held in equilibrium by Lorenzo de' Medici, dreamed that the peninsula could be maintained in *statu quo* by diplomacy. The church saw no danger in encouraging a pseudo-pagan ideal of life, violating its own principle of existence by assuming the policy of an aggrandizing secular state, and outraging Christendom openly by its acts and utterances. Society at large was hardly aware that an intellectual force of stupendous magnitude and incalculably explosive power had been created by the new learning. Why should not established institutions proceed upon the customary and convenient methods of routine, while the delights of existence were augmented, manners polished, arts developed, and a golden age of epicurean ease made decent by a state religion which no one cared to break with because no one was left to regard it seriously? This was the attitude of the Italians when the Renaissance, which they had initiated as a thing of beauty, began to operate as a thing of power beyond the Alps.

Germany was already provided with universities, seven of which had been founded between 1348 and 1400. In these haunts of learning the new studies took root after the year 1440, chiefly through the influence of travelling professors, Peter Luder and Samuel Karoch. German scholars made their way to Lombard and Tuscan lecture-rooms, bringing back the methods of the humanists. Greek, Latin and Hebrew erudition soon found itself at home on Teutonic soil. Like Italian men of letters, these pioneers of humanism gave a classic turn to their patronymics; unfamiliar names, Crotus Rubeanus and Ferius Graecus, Capnio and Lupambulus Ganymedes, Oecolampadius and Melanchthon, resounded on the Rhine. A few of the German princes, among whom Maximilian, the prince cardinal Albert of Mainz, Frederick the Wise of Saxony, and Eberhard of Württemberg deserve mention, exercised a not insignificant influence on letters by the foundation of new universities and the patronage of learned men. The cities of Strassburg, Nuremberg, Augsburg, Basel, became centres of learned coteries, which gathered round scholars like Wimpfeling, Brant, Peuting, Schedel, and Pirckheimer, artists like Dürer and Holbein, printers of the eminence of Froben. Academies in imitation of Italian institutions came into existence, the two most conspicuous, named after the Rhine and the Danube, holding their headquarters respectively at Heidelberg and Vienna. Crowned poets, of whom the most eminent was Conrad Celtes Procius (Pickel), emulated the fame of Politian and Pontano. Yet, though the Renaissance was thus widely communicated to the centres of German intelligence, it displayed a different character from that which it assumed in Italy. Gothic art, which was indigenous in Germany, yielded but little to southern influences. Such

Diffusion of the new learning from Italy throughout Europe.

Revival of Learning in Germany.

work as that of Dürer, Vischer, Cranach, Schöngauer, Holbein, consummate as it was in technical excellence, did not assume Italian forms of loveliness, did not display the paganism of the Latin races. The modification of Gothic architecture by pseudo-Roman elements of style was incomplete. What Germany afterwards took of the Palladian manner was destined to reach it on a circuitous route from France. In like manner the new learning failed to penetrate all classes of society with the rapidity of its expansion in Italy, nor was the new ideal of life and customs so easily substituted for the medieval. The German clergy, as Aeneas Sylvius had noticed, remained for the most part barbarous, addicted to gross pleasures, contemptuous of culture. The German dialects were too rough to receive that artistic elaboration under antique influences which had been so facile in Tuscany. The doctors of the universities were too wedded to their antiquated manuals and methods, too satisfied with dullness, too proud of titles and diplomas, too anxious to preserve ecclesiastical discipline and to repress mental activity, for a general spirit of humanism to spread freely. Not in Cologne or Tübingen but in Padua and Florence did the German pioneers of the Renaissance acquire their sense of liberal studies. And when they returned, they found themselves encumbered with stupidities, jealousies and rancours. Moreover, the temper of these more enlightened men was itself opposed to Italian indifference and immorality; it was pugnacious and polemical, eager to beat down the arrogance of monks and theologians rather than to pursue an ideal of aesthetical self-culture. To a student of the origins of German humanism it is clear that something very different from the Renaissance of Lorenzo de' Medici and Leo X. was in preparation from the first upon Teutonic soil. Far less plastic and form-loving than the Italian, the German intelligence was more penetrative, earnest, and more occupied with substantial principles. Starting with theological questions, proceeding to the stage of solid studies in the three learned languages, German humanism occupied the attention of a widely scattered sect of erudite scholars; but it did not arouse the interest of the whole nation until it was forced into a violently militant attitude by Pfefferkorn's attack on Reuchlin. That attempt to extinguish honest thought prepared the Reformation; and humanism after 1518 was absorbed in politico-religious warfare.

The point of contact between humanism and the Reformation in Germany has to be insisted on; for it is just here that the relation of the Reformation to the Renaissance in general becomes clearer. At the Renaissance had its precursive movements in the medieval period, so the German Reformation was preceded by Wickliffe and Huss, by the discontents of the Great Schism and by the councils of Constance and Basel. These two main streams of modern progress had been proceeding upon different tracks to diverse issues, but they touched in the studies stimulated by the Revival, and they had a common origin in the struggle of the lecture-room of Argyropoulos at Rome in 1482. Erasmus of Rotterdam, who once dwelt at Venice as the house-guest of the Aldi, applied their critical knowledge of Hebrew and of Greek to the elucidation and diffusion of the Bible. To the Germans, as to all nations of that epoch, the Bible came as a new book, because they now read it for the first time with eyes opened by humanism. The touch of the new spirit which had evolved literature, art and culture in Italy sufficed in Germany to recreate Christianity. This new spirit in Italy emancipated human intelligence by the classics; in Germany it emancipated the human conscience by the Bible. The indignation excited by Leo X.'s sale of indulgences, the moral rage stirred in Northern hearts by papal excommunication in Ponty, was serious causes which precipitated the schism between Teutonic and Latin Christianity. The Reformation, inspired by the same energy of resuscitated life as the Renaissance, assisted by the same engines of the printing-press and paper, using the same apparatus of scholarship, criticism, literary skill, being in truth another manifestation of the same world-movement under a diverse form, now posed itself as an irreconcilable antagonist to Renaissance Italy. It would be difficult to draw any comparison between German and Italian humanists to the disparagement of the former. Reuchlin was no less learned than Pico; Melancthon no less humanist than Ficino; Erasmus no less far from the east than Plerich; Ulrich von Hutten no less humorous than Folengo; Paracelsus no less fantastically learned than Cardano. But the cause in which German intellect and will were enlisted was so different that it is difficult not to make a formal separation between that movement which evolved culture in Italy and that which restored religion in Germany, establishing the freedom of intelligence in the one sphere and the freedom of the conscience in the other. The truth is that the Reformation was the Teutonic Renaissance. It was the emancipation of the reason on a line neglected by the Italians, more important indeed in its political consequences, more weighty in its bearing on rationalistic developments than the Italian Renaissance, but none the less an outcome of the same ground-influences. We have already in this century reached a point at which, in spite of stubborn Protestant dogmatism and bitter Catholic reaction, we can perceive how the ultimate affricamentation of man will be the work of both.

The German Reformation was incapable of propagating itself in Italy, chiefly for the reason that the intellectual forces which it represented and employed had already found specific outlet in that country. It was not in the nature of the Italians, sceptical and paganized by the Revival, to be keenly interested about questions which seemed to revive the scholastic disputes of the middle ages. It was not in their external conditions, suffering as they were from invasions, enthralled by despots, to use the Reformation as a lever for political revolution. Yet when a tumultuary army of so-called Lutherans sacked Rome in 1527 no sober thinker doubted that a new agent had appeared in Europe which would alter the destinies of the peninsula. The Renaissance was virtually closed, so far as it concerned Italy, when Clement VII. and Charles V. struck their compact at Bologna in 1530. This compact proclaimed the principle of monarchical absolutism, supported by papal authority, itself monarchically absolute, which influenced Europe until the outbreak of the Revolution. A reaction immediately set in both against the Renaissance and the Reformation. The council of Trent, opened in 1545 and dissolved in 1563 decreed a formal purgation of the church, affirmed the fundamental doctrines of Catholicism, strengthened the papal supremacy, and inaugurated that movement of resistance which is known as the Counter-Reformation. The complex onward effort of the modern nations, expressing itself in Italy as Renaissance, in Germany as Reformation, had aroused the forces of conservatism. The four main instruments of the reaction were the papacy, which had done so much by its sympathy with the revival to promote the humanistic spirit it now dreaded, the strength of Spain, and two Spanish institutions planted on Roman soil—the Inquisition and the Order of St. Dominic. The principle of freedom and established by this reaction was absolutism as opposed to freedom—monarchical absolutism, papal absolutism, the suppression of energies liberated by the Renaissance and the Reformation. The partial triumph of this principle was secure, inasmuch as the majority of established powers in church and state felt threatened by the revolutionary opinions afloat in Europe. Renaissance and Reformation were, moreover, already at strife. Both, too, were spiritual and elastic tendencies toward progress, ideals rather than solid organisms.

The part played by Spain in this period of history was determined in large measure by the formal circumstances. The Spaniards became a nation by the conquest of Granada and the union of the crowns of Castile and Aragon. The war of national aggrandizement, being in its nature a crusade, inflamed the religious enthusiasm of the people. It was followed by the expulsion of Jews and Moors, and by the establishment of the Inquisition on a solid basis, with powers formidable to the freedom of all Spaniards from the peasant to the throne. These facts explain the decisive action of the Spanish nation on the side of Catholic conservatism, and help us to understand why their brilliant achievements in the field of culture during the Renaissance were not so fully followed by innovation. It will be well, in dealing with the Renaissance in Spain, to touch first upon the arts and literature, and then to consider those qualities of character in action whereby the nation most distinguished itself from the rest of Europe. Architecture in Spain, emerging from the Gothic stage, developed an Early Renaissance style of bewildering richness by adopting elements of Arabic and Moorish decoration. Sculpture exhibited realistic vigour of indubitably native stamp; and the minor plastic crafts were cultivated with success on lines of striking originality. Painting grew from a homely stock, until the work of Velazquez opened the Spanish manner, and the brushwork was fully abreast of their Italian contemporaries. To dwell here upon the Italianizing versifiers, moralists and pastoral romancers who attempted to refine the vernacular of the *Romancero* would be superfluous. They are mainly noticeable as proving that certain coteries in Spain were willing to accept the Italian Renaissance. But the real force of the people was not in this courtly literary style. It expressed itself at last in the monumental work of *Don Quixote*, which places Cervantes beside Rabelais, Ariosto and Shakespeare as one of the four supreme exponents of the Renaissance. The affections of delicacy and breath were before the dawn of the modern elements of a noble nation, animated by the youth of modern Europe emerging from the middle ages, were portrayed in its enduring pictures of human experience. The Spanish drama, meanwhile, untrammelled by those false canons of pseudo-classic taste which fettered the theatre in Italy and afterwards in France, rose to an eminence in the hands of Lope de Vega and Calderon which only the English, and the English only in the masterpieces of three or four playwrights, can rival. Camoens, in the *Lusiad*, if we may here group Portugal with Spain, was the first modern poet to compose an epic on a purely modern theme, and, as Virgil, but not bending to poetic rules, and breathing the spirit of the age of heroic adventures, and almost fabulous discoveries into his melodious numbers. What has chiefly to be noted regarding the achievements of the Spanish race in arts and letters at this epoch is their potent national originality. The revival of learning produced in Spain no slavish imitation as it did in Italy, no formal humanism, and it may be added, very little of fruitful scholarship. The Renaissance here, as in England,

Relation of humanism to the German Reformation.

Spain in the Renaissance period—arts and letters.

displayed essential qualities of intellectual freedom, delight in life, exultation over rediscovered earth and man. The note of Renaissance work in Germany was still Gothic. This we feel in the penetrative earnestness of Dürer, in the homeliness of Hans Sachs, in the grotesque humour of *Eulenspiegel* and the *Narrenschiff*, the sombre pregnancy of the Faust legend, the almost stolid mastery of Holbein. It lay not in the German genius to escape from the preoccupations and the limitations of the middle ages, for this reason mainly that what we call medieval was to a very large extent Teutonic. But on the Spanish peninsula, in the masterpieces of Velazquez, Cervantes, Camoens, Calderon, we emerge into an atmosphere of art, definitely national, distinctly modern, where solid natural forms stand before us realistically modelled, with light and shadow on their rounded outlines, and where the airiest creatures of the fancy take shape and weave a dance of rhythmic, light, incomparable intricacy. The Spanish Renaissance would in itself suffice, if other witnesses were wanting, to prove how inaccurate is the theory that limits this movement to the revival of learning. Touched by Italian influences, enriched and fortified by the new learning, Spanish genius walked firmly forward on its own path. It was only crushed by forces generated in the nation that produced it, by the Inquisition and by despotic Catholic absolutism.

In the history of the Renaissance, Spain and Portugal represent the exploration of the ocean and the colonization of the other hemisphere. The voyages of Columbus and Vespucci to America, the rounding of the Cape by Diaz and the discovery of the sea road to India by Vasco da Gama, Cortes's conquest of Mexico and Pizarro's conquest of Peru, marked a new era for the human race and inaugurated the modern age more decisively than any other series of events has done. It has recently been maintained that modern European history is chiefly an affair of competition between confederated states for the possession of lands revealed by Columbus and Da Gama. Without challenging or adopting this speculation, it may be safely affirmed that nothing so pregnant of results has happened as this exploration of the globe. To say that it displaced the centre of gravity in politics and commerce, substituting the ocean for the Mediterranean, dethroning Italy from her seat of central importance in traffic, depressing the eastern and elevating the western powers of Europe, opening a path for Anglo-Saxon expansiveness, forcing philosophers and statesmen to regard the Occidental nations as a single group in counterpoise to other groups of nations, the European community as one unit correlated to other units of humanity upon this planet, is truth enough to vindicate the vast significance of these discoveries. The Renaissance, far from being the re-birth of antiquity with its civilization confined to the Mediterranean, with its Hercules' Pillars beyond which lay Cimmerian darkness, was thus effectively the entrance upon a quite incalculably wider stage of life, on which mankind at large has since enacted one great drama.

While Spanish navies were exploring the ocean, and Spanish paladins were overturning empires, Charles V. headed the reaction of Catholicism against reform. Stronger as king of Spain than as emperor, for the Empire was little but a name, he lent the weight of his authority to that system of coercion and repression which enslaved Italy, desolated Germany with war, and drowned the Low Countries in blood. Philip II., with full approval of the Spanish nation, pursued the same policy in an even stricter spirit. He was powerfully assisted by two institutions, in which the national character of Spain expressed itself, the Inquisition and the Society of Jesus. The former need not be spoken here. But we have to observe that the last great phenomenon of the Spanish Renaissance was Ignatius Loyola, who organized the militia by means of which the church worked her Counter-Reformation. His motto, *Perinde ac cadaver*, expressed that recognition of absolutism which papacy and monarchy demanded for their consolidation (see JESUITS and LOYOLA).

The logical order of an essay which attempts to show how Renaissance was correlated to Reformation and Counter-Reformation has necessitated the treatment of Italy, Germany and Spain in succession; for these three nations were the three main agents in the triple process to be analysed. It was due to their specific qualities, and to the diverse circumstances of their external development, that the re-birth of Europe took this form of duplex action on the lines of intellectual and moral progress, followed by reaction against mental freedom. We have now to speak of France, which earliest absorbed the influence of the Italian revival, and of England, which received it latest. The Renaissance may be said to have begun in France with Charles VIII.'s expedition to Naples, and to have continued until the extinction of the house of Valois. Louis XII. and Francis I. spent a considerable portion of their reigns in the attempt to

secure possession of the Italian provinces they claimed. Henry II.'s queen was Catherine of the Medicean family; and her children, Charles IX. and Henry III., were Italianated Frenchmen. Thus the connexion between France and Italy during the period 1494-1589 was continuous. The French passed to and fro across the Alps on military and peaceful expeditions. Italians came to France as courtiers, ambassadors, men of business, captains and artists. French society assumed a strong Italian colouring, nor were the manners of the court very different from those of an Italian city, except that externally they remained ruder and less polished. The relation between the crown and its great feudatories, the military bias of the aristocracy, and the marked distinction between classes which survived from the middle ages, rendered France in many vital points unlike Italy. Yet the annals of that age, and the anecdotes retailed by Brantôme, prove that the royalty and nobility of France had been largely Italianized.

It is said that Louis XII. brought Fra Giocondo of Verona back with him to France, and founded a school of architects. But we need not have recourse to this legend for the explanation of such Italian influences as were already noticeable in the Renaissance buildings on the Loire. Without determining the French style, Italian intercourse helped to stimulate its formation and development. There are students of the 15th century in France who resent this intrusion of the Italian Renaissance. But they forget that France was bound by inexorable laws of human evolution to obey the impulse which communicated itself to every form of art in Europe. In the school of Fontainebleau, under the patronage of Francis I., that Italian influence made itself distinctly felt; yet a true French manner had been already formed, which, when it was subsequently applied at Paris, preserved a marked national quality. The characteristic of the style developed by Bullant, De l'Orme and Lesot, in the royal or princely palaces of Chenonceaux, Chambord, Anet, Écouen, Fontainebleau, the Louvre and elsewhere, is a blending of capricious fancy and inventive richness of decoration with purity of outline and a large sense of the beauty of extended masses. Beginning with the older castles of Touraine, and passing onward to the Tuileries, we trace the passage from the medieval fortress to the modern pleasure-house, and note how architecture obeyed the special demands of that new phenomenon of Renaissance civilization, the court. In the general distribution of parts these monumental buildings express the peculiar conditions which French society assumed under the influence of Francis I. and Diane de Poitiers. In details of execution and harmonic combinations they illustrate the precision, logic, lucidity and cheerful spirit of the national genius. Here, as in Lombardy, a feeling for serene beauty derived from study of the antique has not interrupted the evolution of a style indigenous to France and eminently characteristic of the French temperament.

During the reign of Francis I. several Italian painters of eminence visited France. Among these, Del Rosso, Primaticcio, Del Sarto and Da Vinci are the most famous. But their example was not productive of a really great school of French painting. It was left for the Poussins and Claude Lorraine in the next century, acting under mingled Italian and Flemish influences, to embody the still active spirit of the classical revival. These three masters were the contemporaries of Corneille, and do not belong to the Renaissance period. Sculpture, on the contrary, in which art, as in architecture, the medieval French had been surpassed by no other people of Europe, was practised with originality and power in the reigns of Henry II. and Francis I. Pontio and Cellini, who quitted Italy for France, found themselves out rivalled in their own sphere by Jean Goujon, Cousin and Pilon. The decorative sculpture of this epoch, whether combined with architecture or isolated in monumental statuary, ranks for grace and suavity with the best of Sansovino's. At the same time it is unmistakably inspired by a sense of beauty different from the Italian—more piquant and pointed, less languorous, more mannered perhaps, but with less of empty rhythmical effect. All this while, the minor arts of enamelling, miniature, glass-painting, goldsmith's work, jewellery, engraving, tapestry, wood-carving, pottery, &c., were cultivated with a spontaneity and freedom which proved that France, in the middle point between Flanders and Italy, was able to absorb influences without sacrifice of native taste. It may indeed be said in general that what is true of France is likewise true of all countries which felt the artistic impulses of the Renaissance. Whether we regard Spain, the Netherlands, or Germany at this epoch, we find a national impress stamped upon the products of the plastic and the decorative arts, notwithstanding the prevalence of certain forms derived from the antique and Italy. It was only at a later period that the formalism of pseudo-classic pedantry reduced natural and national originality to a dead unanimité.

Exploration of the ocean.

French architecture.

Dogmatic Catholicism.

French painting sculpture.

France in the Renaissance period.

French literature was quick to respond to Renaissance influences. De Comines, the historian of Charles VIII.'s expedition to Naples, differs from the earlier French chroniclers in his way of regarding the world of men and affairs. He has the perspicuity and analytical penetration of a Venetian ambassador. Villon, his contemporary, may rather be ranked, so far as artistic form and use of knowledge are concerned, with poets of the middle ages, and in particular with the Goliards. But he is essentially modern in the vividness of his self-portraiture, and in what we are wont to term *Realism*. Both De Comines and Villon indicate the entrance of a new quality into literature. The Rhetoriciens, while protracting medieval traditions by their use of allegory and complicated metrical systems, sought to improve the French language by introducing Latinisms. Thus the Revival of Learning began to affect the vernacular in the last years of the 15th century. Marot and his school reacted against this pedantry. The Renaissance displayed itself in their effort to purify the form and diction of poetry. But the decisive revolution was effected by Ronsard and his comrades of the *Pléiade*. It was their professed object to raise French to a level with the classics, and to acclimatise Italian species of verse. The humanistic movement led these learned writers to engraft the genius of the antique upon the native literature, and to refine it by emulating the lucidity of Petrarch. The result of their endeavour was immediately apparent in the new force added to French rhythm, the new pomp, richness, colouring and polish conferred upon poetic diction. French style gradually attained to fixity, and the alexandrine came to be recognized as the standard line in poetry. D'Aubigné's invective and Regnier's satire, at the close of the 16th century, are as modern as Voltaire's. Meanwhile the drama was emerging from the mediæval mysteries; and the classical type, made popular by Garnier's genius, was elaborated, as in Italy, upon the model of Seneca and the canons of the three unities. The tradition thus formed was continued and fortified by the illustrious playwrights of the 17th century. Translation from Greek and Latin into French progressed rapidly at the commencement of this period. It was a marked characteristic of the Renaissance in France to appropriate the spoils of Greece and Rome for the profit of the mother tongue. Amyot's *Plutarch* and his *Daphnis and Chloë* rank among the most exquisite examples of beautiful French prose. Prose had now the charm of simplicity combined with grace. To mention Brantôme is to mention the most entertaining of gossips. To speak of Montaigne is to speak of the best as well as the first of essayists. All the literary works which have been mentioned, the originality and freshness of the French genius are no less conspicuous than its saturation with the new learning and with Italian studies. But the greatest name of the epoch, the name which is synonymous with the Renaissance in France, has yet to be uttered. That, of course, is Rabelais. His incommensurable and indescrivable masterpiece of mingled humour, wisdom, satire, erudition, indecency, profundity, levity, imagination, realism, reflects the whole age in its mirror of hyper-Aristophanic farce. What Aristotle is for Italy, Cervantes for Spain, Erasmus for Holland, Luther for Germany, Shakespeare for England, that is Rabelais for France. The Renaissance cannot be comprehended in its true character without familiarity with these six representatives of its manifold and many-sided inspiration.

French scholarship. The Reformation in France.

The French Renaissance, so rich on the side of arts and letters, was hardly less rich on the side of classical studies. The revival of learning has a noble muster-roll of names in France: Turnebus, the patriarch of Hellenistic studies; the Étienneux of Paris, equalling in numbers, industry and learning their Venetian rivals; the two Scaligers; impassioned Dolet; eloquent Muret; learned Cujas; terrible Calvin; Ramus; the intrepid antagonist of Aristotle; Des Thou and De Béze; potent and noble plumed by brilliant young Saumaise. The distinguishing characteristics of French humanism are vivid intelligence, critical audacity and polemical acumen, perspicuity of exposition, learning directed in its applications by logical sense rather than by artistic ideals of taste. Some of the names just mentioned remind us that in France, as in Germany and Holland, the Reformation was closely connected with the revival of learning. Humanism has never been in the narrow sense of that term Protestant; still less has it been strictly Catholic. In Italy it fostered a temper of mind decidedly averse to theological speculation and religious earnestness. In Holland and Germany, with Erasmus, Reuchlin and Melancthon, it developed types of character, serene, reflective, pointedly or gently critical, which, left to themselves, would not have plunged the world of Europe into the whirlpool of belligerent reform. Yet none the less was the new learning, through the open spirit of inquiry it nourished, its vindication of the private reason, its enthusiasm for republican antiquity, and its proud assertion of the rights of human independence, linked by a strong and subtle chain to that turbid revolt of the individual consciousness against spiritual despotism draped in fallacies and throned upon abuses. To this rebellion we give the name of Reformation. But, while the necessities of antagonism to papal Rome made it assume at first the form of

narrow and sectarian opposition, it marked in fact a vital struggle of the intellect towards truth and freedom, involving future results of scepticism and rationalistic audacity from which its earlier champions would have shrunk. It marked, moreover, in the condition of armed resistance against established authority which was forced upon it by the Counter-Reformation, a firm resolve to assert political liberty, leading in the course of time to a revolution with which the rebellious spirit of the Revival was sympathetic. This being the relation of humanism in general to reform, French learning in particular displayed such innovating boldness as three main of its most conspicuous professors into the camp of war with Rome. Calvin, a French student of Picard origin, created the type of Protestantism to which the majority of French Huguenots adhered. This too was a moment at which philosophical speculation was hardly possible. In a nation so tumultuously agitated one side or the other had to be adopted. Those of the French humanists who did not proclaim Huguenot opinions found themselves obliged with Muretus to lend their talents to the Counter-Reformation, or to suffer persecution for heterodoxy, like Dolet. The church, terrified and infuriated by the progress of reform, suspected learning on its own account. To be an eminent scholar was to be accused of immorality; heretics were persecuted as well as dissentients; and the defence of weaker minds lay in joining the Jesuits, as Helmsius was fain to do. France had already absorbed the earlier Renaissance in an Italianizing spirit before the Reformation made itself felt as a political actuality. This fact, together with the strong Italian bias of the Valois, serves to explain in some degree the reason why the Counter-Reformation entailed those fierce entangled civil wars, massacres of St Bartholomew, murders of the Guises, regicides, treasons and empoisonments that terminated with the compromise of Henry IV. It is no part of the present subject to analyse the political, religious and social interests of that struggle. The upshot was the triumph of the Counter-Reformation, and the establishment of its principle, absolutism, as the basis of French government. It was a French king who, when the nation had been reduced to order, uttered the famous word of absolutism, "L'Etat, c'est moi."

The Renaissance in the Low Countries, as elsewhere, had its brilliant age of arts and letters. During the middle ages the wealthy free towns of Flanders flourished under conditions not dissimilar to those of the Italian republics. They raised miracles of architectural beauty, which were modified in the 15th and 16th centuries by characteristic elements of the new style. The Van Eycks, followed by Memling, Metsys, Mabuse, Lucas van Leyden, struck out a new path in the revival of painting and taught Europe the secret of oil-colouring. But it was reserved for the 17th century to witness the flower and fruit time of this powerful art in the work of Porbus, Rubens and Vandyck, in the Dutch schools of landscape and home-life, and in the unique masterpieces of Rembrandt. We have a right to connect this later period with the Renaissance, because the distracted state of the Netherlands during the 16th century suspended, while it could not extinguish, their æsthetic development. The various schools of the 17th century, moreover, are animated with the Renaissance spirit no less surely than the Florentine school of the 15th or the Venetian of the 16th. The animal vigour and carnal enjoyment of Rubens, the refined Italianizing beauty of Vandyck, the mystery of light and gloom on Rembrandt's panels, the love of nature in Ruysdael, Cuyp and Van Hooghe, with their luminously misty skies, silvery daylight and broad expanse of landscape, the interest in common life displayed by Ter Borch, Van Steen, Douw, Ostade and Teniers, the instinct for the beauty of animals in Potter, the vast sea spaces of Vanderveldt, the grasp on reality, the acute intuition into character in portraits, the scientific study of the world and man, the robust sympathy with natural appetites, which distinguish the whole art of the Low Countries, are a direct emanation from the Renaissance.

The Netherlands—Flemish and Dutch painting.

The vernacular in the Netherlands profited at first but little by the impulse which raised Italian, Spanish, French and English to the rank of classic languages. But humanism, first of all in its protagonist Erasmus, afterwards in the long list of critical scholars and editors, Lipsius, Heinsius and Grotius, in the printers Elzevir and Plantin, developed itself from the centre of the Leiden university with massive energy, and proved that it was still a motive force of intellectual progress. In the fields of classical learning the students of the Low Countries broke new ground chiefly by methodical collection, classification and comprehensive criticism of previously accumulated stores. Their works were solid and substantial edifices, forming the substratum for future scholarship. In addition to this they brought philosophy and scientific thoroughness to bear on studies which had been pursued in a more literary spirit. It would, however, be uncritical to pursue this subject further; for the encyclopaedic labours of the Dutch philologists belong to a period when the Renaissance was overpast. For the same reason it is inadmissible to do more than mention the name of Spinoza here.

Flemish and Dutch scholarship.

The Netherlands became the battlefield of Reformation and Counter-Reformation in even a stricter sense than France. In the antagonistic principles were plainly posed in the course of struggle against foreign despotism. The conflict ended in the assertion of political independence as opposed to absolute dominion. Europe in large measure owes the modern ideal of political liberty to that spirit of stubborn resistance which broke the power of Spain. Recent history, and in particular the history of democracy, claims for its province the several stages whereby this principle was developed in England and America, and its outburst in the frenzy of the French Revolution. It is enough here to have alluded to the part played by the Low Countries in the genesis of a motive force which may be described as the last manifestation of the Renaissance striving after self-emancipation.

The insular position of England, combined with the nature of the English people, has allowed us to feel the vibration of European movements later and with less of shock than any of the continental nations. Before a wave of progress has reached our shores we have had the opportunity of watching it as spectators, and of considering how we shall receive it. Revolutions have passed from the tumultuous stages of their origin into some settled and recognizable state before we have been called upon to cope with them. It was thus that England took the influences of the Renaissance and Reformation simultaneously, and almost at the same time found herself engaged in that struggle with the Counter-Reformation which, crowned by the defeat of the Spanish Armada, stimulated the sense of nationality and developed the naval forces of the race. Both Renaissance and Reformation had been anticipated by at least a century in England. Chaucer's poetry, which owed so much to Italian examples, gave an early foretaste of the former. Wicliffe's teaching was a vital moment in the latter. But the French wars, the Wars of the Roses and the persecution of the Lollards deferred the coming of the new age; and the year 1536, when Henry VIII. passed the Act of Supremacy through parliament, may be fixed as the date when England entered definitely upon a career of intellectual development abreast with the foremost nations of the continent. The circumstances just now insisted on explain the specific character of the English Renaissance. The Reformation had been adopted by consent of the king, lords and commons; and this change in the state religion, though it was not confirmed without reaction, agitation and bloodshed, cost the nation comparatively little disturbance. Humanism, before it affected the bulk of the English people, had already permeated Italian and French literature. Classical erudition had been adapted to the needs of modern thought.

The hard work of collecting, printing, annotating and translating Greek and Latin authors had been accomplished. The masterpieces of antiquity had been interpreted and made intelligible. Much of the learning popularized by our poets and dramatists was derived at second hand from modern literature. This does not mean that England was deficient in ripe and sound scholars. More, Colet, Ascham, Cheke, Camden were men whose familiarity with the classics was both intimate and easy. Public schools and universities conformed to the modern methods of study; nor were there wanting opportunities for youths of humble origin to obtain an education which placed them on a level with Italian scholars. The single case of Ben Jonson sufficiently proves this. Yet learning did not at this epoch become a marked speciality in England. There was no class corresponding to the humanists. It should also be remembered that the best works of Italian literature were introduced into Great Britain together with the classics. Phœbus's *Virgil*, Chapman's *Homer*, Harrington's *Orlando*, Marlowe's *Hero and Leander*, Fairfax's *Jerusalem Delivered*, North's *Plutarch*, Hoby's *Courtier*—to mention only a few examples—placed English readers simultaneously in possession of the most eminent and representative works of Greece, Rome and Italy. At the same time Spanish influences reached them through the imitators of Guevara and the dramatists; French influences in the versions of romances; German in-

fluences in popular translations of the Faust legend, *Eisen-spiegel* and similar productions. The authorized version of the Bible had also been recently given to the people—so that almost at the same period of time England obtained in the vernacular an extensive library of ancient and modern authors. This was a privilege enjoyed in like measure by no other nation. It sufficiently accounts for the richness and variety of Elizabethan literature, and for the enthusiasm with which the English language was cultivated.

Speaking strictly, England borrowed little in the region of the arts from other nations, and developed still less that was original. What is called Jacobean architecture marks indeed an interesting stage in the transition from the gothic style. But, compared with Italian, French, Spanish, German and Flemish work of a like period, it is both timid and dry. Sculpture was represented in London for a brief space by Torrigiani; painting by Holbein and Antonio More; music by Italians and Frenchmen of the Chapel Royal. But no Englishmen rose to European eminence in these departments. With literature the case was very different. Wyatt and Surrey began by engraving the forms and graces of Italian poetry upon the native stock. They introduced the sonnet and blank verse. Sidney followed with the *pastoral* and *terza rima* and with various experiments in classic metres, none of which took root on English soil. The translators handled the octave stanza and Marlowe gave new vigour to the couplet. The first period of the English Renaissance was one of imitation and assimilation. Academies after the Italian type were founded. Tragedies in the style of Seneca, rivaling Italian and French dramas of the epoch, were produced. Attempts to Latinize ancestral rhythms, similar to those which had failed in Italy and France, were made. Tentative essays in criticism and dissertations on the art of poetry abounded. It seemed as though the Renaissance ran a risk of being throttled in its cradle by superfluity of foreign and pelagian nutriment. But the natural vigour of the English genius resisted, and the alien took itself, and showed a robust capacity for digesting the varied diet offered to it. Spenser was nothing despotic in the temper of the ruling classes, nothing oppressive to a English culture, the literature of that age evolved itself freely from the people. It was under these conditions that Spenser gave his romantic epic to the world, a poem which derived its allegory from the middle ages, its decorative richness from the Italian Renaissance, its sweetness, purity, harmony and imaginative splendour from the most poetic nation of the modern world. Under the same conditions the Elizabethan drama, which in its totality is the real exponent of the English Renaissance, came into existence. This drama very early freed itself from the pseudo-classic mannerism which imposed on taste in Italy and France. Depicting feudalism in the vivid colours of an age at war with feudal institutions, breathing into antique histories the breath of actual life, embracing the romance of Italy and Spain, the mysteries of German legend, the fictions of poetic fancy and the facts of daily life, humours of the moment and abstractions of philosophical speculation, in one homogeneous amalgam instinct with intense vitality, this extraordinary birth of time, with Shakespeare for the master of all ages, left a monument of the Renaissance unrivalled for pure creative power by any other product of that epoch. To complete the sketch, we must set Bacon, the expounder of modern scientific method, beside Spenser and Shakespeare, as the third representative of the Renaissance in England. Nor should Raleigh, Drake, Hawkins, the semi-buccaner explorers of the ocean, be omitted. They, following the lead of Portuguese and Spaniards, combating the Counter-Reformation on the seas, opened for England her career of colonization and plantation. All this while the political policy of Tudors and Stewarts tended towards monarchical absolutism, while the Reformation in England, modified by contact with the Low Countries during their struggles, was narrowing into strict reactionary intolerance. Puritanism indicated a revolt of the religious conscience of the nation against the arts and manners of the Renaissance, against the encroachments of belligerent Catholicism, against the corrupt and Italianated court of James I., against the absolutist pretensions of his son Charles. In its final manifestation during the Commonwealth, Puritanism won a transient victory over the mundane forces of both Reformation and Renaissance, as these had taken shape in England. It also secured the eventual triumph of constitutional independence. Milton, the greatest humanistic poet of the English race, lent his pen and moral energies during the twenty years of his life to securing that principle which modern political systems at present rest. Thus the geographical isolation of England, and the comparatively late adoption by the English of matured Italian and German influences, give peculiar complexity to the phenomena of Reformation and Renaissance simultaneously developed on our island. The period of our history between 1536 and 1642 shows how difficult it is to separate these two factors in the re-birth of Europe, both of which contributed so powerfully to the formation of modern English nationality.

Arts,
letters
and the
drama.

English
reaction
against
Catholicism,
monarchical
absolutism,
and Renaissance
culture.

It has been impossible to avoid an air of superficiality, and the repetition of facts known to every schoolboy, in this sketch of so complicated a subject as the Renaissance,—embracing many nations, a great variety of topics and an indefinite period of time. Yet no other treatment was possible upon the lines laid down at the outset, where it was explained why the term Renaissance cannot now be confined to the Revival of Learning and the effect of antique studies upon literary and artistic ideals. The purpose of this article has been to show that, while the Renaissance implied a new way of regarding the material world and human nature, a new conception of man's destiny and duties on this planet, a new culture and new intellectual perceptions penetrating every sphere of thought and energy, it also involved new reciprocal relations between the members of the European group of nations. The Renaissance closed the middle ages and opened the modern era,—not merely because the mental and moral ideas which then sprang into activity and owed their force in large measure to the revival of classical learning were opposed to medieval modes of thinking and feeling, but also because the political and international relations specific to it as an age were at variance with fundamental theories of the past. Instead of empire and church, the sun and moon of the medieval system, a federation of peoples, separate in type and divergent in interests, yet bound together by common tendencies, common culture and common efforts, came into existence. For obedience to central authority was substituted balance of power. Henceforth the hegemony of Europe attached to no crown, imperial or papal, but to the nation which was capable of winning it, in the spiritual region by mental ascendancy, and in the temporal by force.

That this is the right way of regarding the subject appears from the events of the first two decades of the 19th century, those years in which the humanistic revival attained its highest point in Italy. Luther published his theses in 1517, sixty-four years after the fall of Constantinople, twenty-three years after the expedition of Charles VIII. to Naples, ten years before the sack of Rome, at a moment when France, Spain and England had only felt the influences of Italian culture but feebly. From that date forward two parties wrestled for supremacy in Europe, to which may be given the familiar names of Liberalism and Conservatism, the party of progress and the party of established institutions. The triumph of the former was most signal among the Teutonic peoples. The Latin races, championed by Spain and supported by the papacy, fought the battle of the latter, and succeeded for a time in rolling back the tide of revolutionary conquest. Meanwhile that liberal culture which had been created for Europe by the Italians before the contest of the Reformation began continued to spread, although it was stifled in Italy and Spain, retarded in France and the Low Countries, well-nigh extirpated by wars in Germany, and diverted from its course in England by the counter-movement of Puritanism. The *autos da fé* of Seville and Madrid, the flames to which Bruno, Dolet and Paleario were flung, the dungeon of Campanella and the seclusion of Galileo, the massacre of St Bartholomew and the faggots of Smithfield, the desolated plains of Germany and the crucifixes of Alva in the Netherlands, disillusioned Europe of those golden dreams which had arisen in the earlier days of humanism, and which had been so pleasantly indulged by Rabelais. In truth the Renaissance was ruled by no *Astræa redus*, but rather by a severe spirit which brought no peace but a sword, reminding men of sternest duties, testing what of moral force and tenacity was in them, compelling them to strike for the old order or the new, suffering no lukewarm halting between two opinions. That, in spite of retardation and retrogression, the old order of ideas should have yielded to the new all over Europe,—that science should have won firm standing-ground, and political liberty should have struggled through those birth-throes of its origin,—was in the nature of things. Had this not been, the

Renaissance or re-birth of Europe would be a term without a meaning.

(J. A. S.)

LITERATURE.—The special articles on the several arts and the literatures of modern Europe, and on the biographies of great men mentioned in this essay, will give details of necessity here omitted. Of works on the Renaissance in general may be mentioned Jacob Burckhardt, *Die Cultur der Renaissance in Italien* (Eng. trans., 1878); G. Voigt, *Wiederbelebung des Classischen Alterthums* (2 vols. 3rd ed., by M. Lehnerdt, 1893); J. A. Symonds, *Renaissance in Italy*; Marc Monnier, *Renaissance de Dante à Luther*; Eugène Müntz, *Précurseurs de la Renaissance* (1882), *Renaissance en Italie et en France* (1885), and *Hist. de l'art pendant la Renaissance* (1889-95); Ludwig Geiger, *Humanismus und Renaissance in Italien und Deutschland* (1882), and *Cambridge Modern History*, vol. 1., "The Renaissance" (Cambridge, 1903), where full bibliographies will be found.

RENAIX, a town of Belgium in the province of East Flanders, 8 m. S. of Oudenarde. It has extensive dyeworks, bleaching grounds and manufactories for linen and woollen goods. Pop. (1904) 20,760.

RENAN, ERNEST (1823-1892), French philosopher and Orientalist, was born on the 27th of February 1823 at Tréguier. His father's people were of the fisher-clan of Renans or Ronans; his grandfather, having made a small fortune by his fishing smack, bought a house at Tréguier and settled there, and his father, captain of a small cutter and an ardent Republican, married the daughter of Royalist trading-folk from the neighbouring town of Lannion. All his life Renan was divided between his father's and his mother's political beliefs. He was only five years old when his father died, and his sister Henriette, twelve years older than Ernest, a girl of remarkable character, was henceforth morally the head of the household. Having in vain attempted to keep a school for girls at Tréguier, she left her native place and went to Paris as teacher in a young ladies' boarding-school. Ernest meanwhile was educated in the ecclesiastical seminary of his native place. His good-conduct notes for this period describe him as "docile, patient, diligent, painstaking, thorough." We do not hear that he was brilliant, but the priests cared little for such qualities. While the priests were grounding him in mathematics and Latin, his mother completed his education. She was only half a Breton. Her paternal ancestors came from Bordeaux, and Renan used to say that in his own nature the Gascon and the Breton were constantly at odds.

In the summer of 1838 Renan carried off all the prizes at the college of Tréguier. His sister in Paris told the doctor of the school in which she taught about the success of her brother, and he carried the news to F. A. P. Dupanloup, then engaged in organizing the ecclesiastical college of St Nicholas du Chardonnet, a school in which the young Catholic nobility and the most gifted pupils of the Catholic seminaries were to be educated together, with a view to cementing the bond between the aristocracy and the priesthood. Dupanloup sent for Renan at once. He was fifteen and a half. He had never been outside his Breton province. "I learned with stupor that knowledge was not a privilege of the church. . . I awoke to the meaning of the words talent, fame, celebrity." Above all, religion seemed to him wholly different in Tréguier and in Paris. The superficial, brilliant, pseudo-scientific Catholicism of the capital did not satisfy Renan, who had accepted the austere faith of his Breton masters.

In 1840 Renan left St Nicholas to study philosophy at the seminary of Issy. He entered with a passion for Catholic scholasticism. The rhetoric of St Nicholas had wearied him, and his serious intelligence hoped to satisfy itself with the vast and solid material of Catholic theology. Reid and Malebranche first attracted him among the philosophers, and after these he turned to Hegel, Kant and Herder. Renan began to perceive the essential contradiction between the metaphysics which he studied and the faith that he professed, but an appetite for truths that can be verified restrained his scepticism. "Philosophy excites and only half satisfies the appetite for truth; I am eager for mathematics," he wrote to his sister Henriette. Henriette had accepted in the family of Count Zamoyksi an engagement more lucrative than her former place. She exercised

the strongest influence over her brother, and her published letters reveal a mind almost equal, a moral nature superior, to his own.

It was not mathematics but philology which was to settle the gathering doubts of Ernest Renan. His course completed at Issy, he entered the college of St Sulpice in order to take his degree in philology prior to entering the church; and here he began the study of Hebrew. He saw that the second part of Isaiah differs from the first not only in style but in date; that the grammar and the history of the Pentateuch are posterior to the time of Moses; that the book of Daniel is clearly apocryphal. It followed from his training that, if you admit one error in a revealed text, you incriminate the whole. Secretly, Renan felt himself cut off from the communion of saints, and yet with his whole heart he desired to live the life of a Catholic priest. Hence a struggle between vocation and conviction; owing to Henriette, conviction gained the day. In October 1845 Renan left the seminary of St Sulpice for Stavistas, a lay college of the Oratorians. Finding himself even there too much under the domination of the church, a few weeks later he reluctantly broke the last tie which bound him to the religious life and entered M. Crouzet's school for boys as an usher.

It is always dangerous to educate a really great mind in only one order of truth. Renan, brought up by priests in a world ruled by authority and curious only of feeling and opinion, was to accept the scientific ideal with an extraordinary expansion of all his faculties. He was henceforth ravished by the splendour of the cosmos. At the end of his life he wrote of Amiel, "The man who has time to keep a private diary has never understood the immensity of the universe." The certitudes of physical and natural science were revealed to Renan in 1846 by the chemist Marcellin Berthelot, then a boy of eighteen, his pupil at M. Crouzet's school. To the day of Renan's death their friendship continued. Renan was occupied as usher only in the evenings. In the daytime he continued his researches in Semitic philology. In 1847 he obtained the Prix Volney—one of the principal distinctions awarded by the Academy of Inscriptions—for the manuscript of his "General History of Semitic Languages." In 1847 he took his degree as Agrégé de Philosophie; that is to say, fellow of the university, and was offered a place as master in the lycée of Vendôme. In 1848 a small temporary appointment to the lycée of Versailles permitted him to return to the capital and resume his studies.

The revolution of 1848 aroused in Renan that side of him which loved the priesthood because "the priest lives for his fellows." He for the first time confronted the problems of Democracy. The result was an immense volume, *The Future of Science*, which remained in manuscript until 1890. *L'Avenir de la science* is an attempt to conciliate the privileges of a necessary élite with the diffusion of the greatest good of the greatest number. The difficulty haunted Renan throughout his life. By the time he had finished his elaborate scheme for regenerating society by means of a devoted aristocracy of knowledge, and the diffusion of culture, the year 1848 was past, and with it his fever of Democracy. In 1849 the French government sent him to Italy on a scientific mission. He remained eight months abroad, during which he forgot his anxiety about the toilers' lot. Hitherto he had known nothing of art. In Italy the artist in him awoke and triumphed over the savant and the reformer. On his return to Paris Renan lived with his sister Henriette. A small post at the National Library, together with his sister's savings, furnished him with the means of livelihood. In the evenings he wrote for the *Revue des deux mondes* and the *Débats* the exquisite essays which appeared in 1857 and 1859 under the titles *Études d'histoire religieuse* and *Essais de morale et de critique*. In 1852 his book on *Averroës* had brought him not only his doctor's degree, but his first reputation as a thinker. In his two volumes of essays Renan shows himself a Liberal, but no longer a Democrat. That nothing, according to his philosophy, is less important than prosperity. The greatest good of the greatest number is a theory as dangerous as it is illusory. Man is not born to be prosperous, but to realize, in a little vanguard of

chosen spirits, an ideal superior to the ideal of yesterday. Only the few can attain a complete development. Yet there is a solidarity between the chosen few and the masses which produce them; each has a duty to the other. The acceptance of this duty is the only foundation for a moral and just society. The aristocratic ideal has seldom been better stated.

The success of the *Études d'histoire religieuse* and the *Essais de morale* had made the name of Renan known to a cultivated public. While Mademoiselle Renan remained shut up at home copying her brother's manuscripts or compiling material for his work, the young philosopher began to frequent more than one Parisian salon, and especially the studio of Ary Scheffer, at that time a noted social centre. In 1856 he proposed to marry Cornélie Scheffer, the niece and adopted daughter of the great Dutch painter. Not without a struggle Henriette consented not only to the marriage, but to make her home with the young couple, whose housekeeping depended on the sum that she could contribute. The history of this romance has been told by Renan in the memorial essay which he wrote some six years later, entitled *Ma Sœur Henriette*. His marriage brought much brightness into his life, a naturalness into his style and a greater attention to the picturesque. He did not forsake his studies in Semitic philology, and in 1859 appeared his translation of the *Book of Job* with an introductory essay, followed in 1859 by the *Song of Songs*.

Renan was now a candidate for the chair of Hebrew and Chaldaic languages at the Collège de France, which he had desired since first he studied Hebrew at the seminary of St Sulpice. The death of the scholar Quatremère had left this post vacant in 1857. No one in France save Renan was capable of filling it. The Catholic party, upheld by the empress, would not appoint an unfrocked seminarist, a notorious heretic, to a chair of Biblical exegesis. Yet the emperor wished to conciliate Ernest Renan. He offered to send the young scholar on an archaeological mission to Phœnicia. Renan immediately accepted. Leaving his wife at home with their baby son, Renan left France, accompanied by his sister, in the summer of 1860. Madame Renan joined them in January 1861, returning to France in July. The mission proved fruitful in Phœnician inscriptions which Renan published in his *Mission de Phénicie*. They form the base of that *Corpus Inscriptionum Semiticarum* on which he used in later years to declare that he founded his claim to remembrance. He wished to complete his exploration of the upper range of Lebanon; he remained, therefore, with Henriette to affront the dangerous miasma of a Syrian autumn. At Amshit, near Byblos, Henriette Renan died of intermittent fever on the 24th of September 1861. Her brother, himself at death's door, was carried unconscious on board a ship waiting in harbour and bound for France. The sea air revived him, but he reached France broken apparently in heart and health. His sister in her last days had entreated him not to give up his candidature for the chair of Hebrew, and on the 11th of January 1862 the Minister of Public Instruction ratified Renan's election to the post. But his opening lecture, in which, amid the applause of the students, Renan declared Jesus Christ "an incomparable Man," alarmed the Catholic party. Renan's lectures were pronounced a disturbance of the public peace, and he was suspended. On the 2nd of June 1864, on opening the newspaper, Renan saw that he had been transferred from the chair of Hebrew at the Collège de France to the post of sub-librarian at the National Library. He wrote to the Minister of Public Instruction: "Pecunia tua tecum sit!" He refused the new position, was deprived of his chair, and henceforth depended solely upon his pen.

Henriette had told him to write the life of Jesus. They had begun it together in Syria, she copying the pages as he wrote them, with a New Testament and a *Josephus* for all his library. The book bears the mark of its origin—it is filled with the atmosphere of the East. It is the work of a man familiar with the Bible and theology, and no less acquainted with the inscriptions, monuments, types and landscapes of Syria. But it is scarcely the work of a great scholar: Renan's debt to the school

of Tübingen has been exaggerated, in so far as regards the *Life of Jesus*. The book appeared on the 23rd of June 1863; before November sixty thousand copies of it were in circulation. Renan still used his literary gifts to pursue a scientific ideal. In the days when he had composed his huge, immature treatise on the *Future of Science*, he had written: "I envy the man who shall evoke from the past the origins of Christianity. Such a writer would compose the most important book of the century." He set to work to realize this project, and produced the *Apostles* in 1866, and *St Paul* in 1869, after having visited Asia Minor with his wife, where he studied the scenes of the labours of St Paul as minutely as in 1861 he had observed the material surroundings of the life of Jesus.

Renan was not only a scholar. In *St Paul*, as in the *Apostles*, he shows his concern with the larger social life, his sense of fraternity, and a revival of the democratic sentiment which had inspired *L'Avenir de la science*. In 1869 he presented himself as the candidate of the liberal opposition at the parliamentary election for Meaux. While his temper had become less aristocratic, his Liberalism had grown more tolerant. On the eve of its dissolution Renan was half prepared to accept the Empire, and, had he been elected to the Chamber of Deputies, he would have joined the group of *l'Empire libéral*. But he was not elected. A year later war was declared with Germany, the Empire fell, and Napoleon III. went into exile. The Franco-German War was a turning-point in Renan's history. Germany had always been to him the asylum of thought and disinterested science. Now he saw the land of his ideal destroy and ruin the land of his birth; he beheld the German no longer as a priest, but as an invader. His heart turned to France. In *La Réforme intellectuelle et morale* (1871) he endeavoured at least to bind her wounds, to safeguard her future. Yet he was still under the influence of Germany. The ideal and the discipline which he proposed to his defeated country were those of her conqueror—a feudal society, a monarchical government, an *élite*, which the rest of the nation exists merely to support and nourish; an ideal of honour and duty imposed by a chosen few on the recalcitrant and subject multitude. The errors of the Commune confirmed Renan in this reaction. At the same time the irony always perceptible in his work grows more bitter. His *Dialogues philosophiques*, written in 1871, his *Ecclesiastes* (1882) and his *Antichrist* (1876) (the fourth volume of the *Origins of Christianity*, dealing with the reign of Nero) are incomparable in their literary genius, but they are examples of a disenchanting and sceptical temper. He had vainly tried to make his country follow his precepts. He resigned himself to watch her drift towards perdition. The progress of events showed him, on the contrary, a France which every day left a little stronger, and he aroused himself from his disbelieving, disillusioned mood, and observed with genuine interest the struggle for justice and liberty of a democratic society. For his mind was the broadest of the age. The fifth and sixth volumes of the *Origins of Christianity* (the *Christian Church* and *Marcus Aurelius*) show him reconciled with democracy, confident in the gradual ascent of man, aware that the greatest catastrophes do not really interrupt the sure if imperceptible progress of the world—reconciled also in some measure, if not with the truths, at least with the moral beauties of Catholicism, and with the remembrance of his pious youth.

On the threshold of old age the philosopher cast a glance at the days of his childhood. He was nearly sixty when, in 1883, he published those *Souvenirs d'enfance et de jeunesse* which, after the *Life of Jesus*, are the work by which he is chiefly known. They possess that lyric note of personal utterance which the public prizes in a man already famous. They showed the *Masé* modern reader that a world no less poetic, no less primitive than that of the *Origins of Christianity* exists, or still existed within living memory, on the north-western coast of France. They have the Celtic magic of ancient romance and the simplicity, the naturalness, the veracity which the 19th century prized so highly. But his *Ecclesiastes*, published a few months earlier, his *Drames philosophiques*, collected in 1888,

give a more adequate image of his fastidious critical, disenchanting, yet not unhopeful spirit. These books are often bitter and melancholy, yet not destitute of optimism. They show the attitude towards uncultured Socialism of a philosopher liberal by conviction, by temperament an aristocrat. We learn in them how Caliban (democracy), the mindless brute, educated to his own responsibility, makes after all an adequate ruler; how Prospero (the aristocratic principle, or, if we will, the mind) accepts his dethronement for the sake of greater liberty in the intellectual world, since Caliban proves an effective policeman, and leaves his superiors a free hand in the laboratory; how Ariel (the religious principle) acquires a firmer hold on life, and no longer gives up the ghost at the faintest hint of change. Indeed, Ariel flourishes in the service of Prospero under the external government of the many-headed brute. For the one thing needful is not destined to succumb. Religion and knowledge are as imperishable as the world they dignify. Thus out of the depths rises unvanquished the essential idealism of Ernest Renan.

Renan was a great worker. At sixty years of age, having finished the *Origins of Christianity*, he began his *History of Israel*, based on a lifelong study of the Old Testament and on the *Corpus Inscriptionum Semiticarum*, published by the Académie des Inscriptions under Renan's direction from the year 1881 till the end of his life. The first volume of the *History of Israel* appeared in 1887, the third and finest volume in 1891, the last two only after the historian's decease. As a history of facts and theories the book has many faults; as an essay on the evolution of the religious idea it is (despite some passages of frivolity, irony, or incoherence) of extraordinary importance; as a reflection of the mind of Ernest Renan it is the most lifelike of images. In a volume of collected essays, *Feuilles détachées*, published also in 1891, we find the same mental attitude, an affirmation of the necessity of piety independent of dogma. On the 12th of October 1892 he died after a few days' illness. In his last years he received many marks of honour, being made an administrator of the Collège de France and grand officer of the Legion of Honour. Two volumes of the *History of Israel*, his correspondence with his sister Henriette, his *Letters to M. Berthelot*, and the *History of the Religious Policy of Philippe-le-Bel*, which he wrote in the years immediately before his marriage, all appeared during the last eight years of the 19th century.

See Desportes and Bournand, *E. Renan, sa vie et son œuvre* (1892); E. Grant Duff, *Ernest Renan, in memoriam* (1893); Scailles, *E. Renan, essai de biographie psychologique* (1894); G. Monod, *Les lettres de l'histoire* (1894); Allier, *Le Philosophe d'E. Renan* (1895); M. J. Darmesteter, *La vie de E. R.* (1898); Platzhoff, *E. Renan, ein Lebensbild* (1900); Brauer, *Philosophy of Ernest Renan* (1904); W. Barry, *Renan* (1905); Sorel, *Le Système historique de R.* (1905-1906).
(A. M. F. D.; X.)

RENARD, ALPHONSE FRANÇOIS (1842-1903), Belgian geologist and petrographer, was born at Renaix, in Eastern Flanders, on the 27th of September 1842. He was educated for the church of Rome, and from 1866 to 1869 he was superintendent at the Collège de la Paix, Namur. In 1870 he entered the Jesuit Training College at the old abbey of Maria Laach in the Eifel, and there, while engaged in studying philosophy and science, he became interested in the geology of the district, and especially in the volcanic rocks. Thenceforth he worked at chemistry and mineralogy, and qualified himself for those petrographical researches for which he was distinguished. In 1874 he became professor of chemistry and geology in the college of the Belgian Jesuits at Louvain, a few years later he was appointed one of the curators of the Royal Natural History Museum at Brussels, and in 1882 he relinquished his post at Louvain. In 1888 he was chosen professor of geology at the university of Ghent, and retained the post until the close of his life. Meanwhile he had been ordained priest in 1877, and had intended to enter the Society of Jesus. He was known as the Abbé Renard; but, as remarked by Sir A. Geikie, "As years passed, the longing for mental freedom grew ever stronger, until at last it overmastered all the traditions and associations of a lifetime, and he finally separated himself from the church of Rome." His first work,

written in conjunction with Charles de la Vallée-Poussin (1827-1904), was the *Mémoire sur les caractères minéralogiques et stratigraphiques des roches diées pléistocènes de la Belgique et de l'Ardenne française* (1876). In later essays and papers he dealt with the structure and mineral composition of many igneous and sedimentary rocks, and with the phenomena of metamorphism in Belgium and other countries. In acknowledgment of his work the Bigsby Medal was in 1885 awarded to him by the Geological Society of London. Still more important were his later researches connected with the Challenger Expedition. The various rock specimens and oceanic deposits were submitted to him for examination in association with Sir John Murray, and their detailed observations were embodied in the *Report on the Scientific Results of the Voyage of H.M.S. "Challenger." Deep Sea Deposits* (1891). The more striking additions to our knowledge included "the detection and description of cosmic dust, which as fine rain slowly accumulates on the ocean floor; the development of zeolitic crystals on the sea-bottom at temperatures of 32° and under; and the distribution and mode of occurrence of manganiferous concretions and of phosphatic and glauconitic deposits on the bed of the ocean" (Geikie). Renaud died at Brussels on the 9th of July 1903.

Obituaries by Sir A. Geikie in *Quart. Journ. Geol. Soc.*, lx, 1904, and in *Geol. Mag.*, Nov. 1903.

RENAUD DE MONTAUBAN (Rinaldo di Montalbano), one of the most famous figures of French and Italian romance. His story was attached to the *geste* of Doon of Mayence by the 13th-century *trouvère* who wrote the *chanson de geste* of *Reinaud de Montauban*, better known perhaps as *Les quatre fils Aymon*. The four sons of Aymon give their name to inns and streets in nearly every town of France, and the numerous prose versions show what a hold the story gained on the popular imagination. Renaud's sword Floberge, and his horse Bayard passed with him into popular legend. The poem of *Reinaud de Montauban* opens with the story of the dissensions between Charlemagne and the sons of Doon of Mayence, Beuves d'Aigremont, Doon de Nanteuil and Aymon de Dordone. The rebellious vassals are defeated by the imperial army near Troyes, and, peace established, Aymon rises in favour at court, and supports the emperor, even in his persecution of his four sons, Renaud, Alard, Guichard and Richard. A second feud arises from a quarrel between Renaud and Bertolai, Charlemagne's nephew, over a game of chess, in the course of which Renaud kills Bertolai with the chess-board. The hero then mounts his steed Bayard, and escapes with his brothers to the Ardennes, where they build the castle of Montessor overlooking the Meuse. At Château Renaud, near Séclan, there existed in the 18th century a ruined castle with a tower called the "tour Maugis" and the reputed stable of Bayard. The outlaws are eventually persuaded to seek their fortune outside Charlemagne's kingdom, and cross the Loire to take service with King Yon of Gascony against the Saracens, accompanied by their cousin, the enchanter Maugis. Yon, however, is compelled by Charlemagne to withdraw his protection, and the castle of Montauban, which the brothers have built on the Dordogne, is besieged by the emperor. They next seek refuge beyond the Rhine, and sustain a third siege at Trémoigne (Dortmund), after which the emperor is persuaded by the barons to make peace. Bayard is abandoned to Charlemagne, and thrown into the Meuse, only to rise again. He still gallops over the hills of the Ardennes on St John's Eve. Renaud, who throughout the story is a type of the Christian and chivalric virtues, makes a pilgrimage to the Holy Land and is invested with some of the exploits of Godfrey de Bouillon. On his return he gives himself up to religion, working as a mason on the church of St Peter at Cologne, where he receives martyrdom at the hands of his jealous fellow-labourers.

The story is closely connected with the legend of Girard de Roussillon. The *chanson de geste* of *Reinaud de Montauban* falls into sections which had probably been originally the subject of separate recitals. These may have arisen at different dates, and were not necessarily told in the first instance of the same person, the account of Renaud on the crusade being

obviously a late interpolation. The outlaw life of the brothers in the Ardennes bears the marks of trustworthy popular tradition, and it was even at one time suggested that the Gascon and Rhenish episodes were reduplications of the story of Montessor. The connexion of the four brothers with Montessor, Dortmund, Mayence and Cologne, and the abundant local tradition, mark the heroes as originating from the region between the Rhine and the Meuse. Nevertheless, their adventures in Gascony are corroborated by historical evidence, and this section of the poem is the oldest. The enemy of Renaud was Charles Martel, not Charlemagne; Yon was Odo of Gascony, known indifferently as duke, prince, or king; the victory over the Saracens at Toulouse, in which the brothers are alleged to have taken part, was won by him in 721, and in 719 he sheltered refugees from the dominions of Charles Martel, Childeric II., king of Neustria, and his mayor of the palace, Raginfred, whom he was compelled to abandon. In a local chronicle of Cologne it is stated that Saint Reinoldus died in 607, and in the Latin rhythmical *Vita* his martyrdom is said to have taken place under Bishop Agilolf (d. 717). Thus the romance was evidently composite before it took its place in the Carolingian cycle.

In Italy Renaud had his greatest vogue. His connexion with the treacherous family of Mayence was thrust into the background, and many episodes were added, as well as the personage of the hero's sister, Bradamante. Rinaldo di Montalbano had been the subject of many Italian poems before *Il Rinaldo* of Tasso.

BIBLIOGRAPHY.—The *chanson* of *Maugis d'Aigremont* and the prose romance of the *Conquête de Trebizonde* belong to the same cycle. The prose *Ystoire de Regnault de Montauban* (Lyons, c. 1480) had a great vogue. It was generally printed as *Les quatre fils Aymon*, and was published in English, *The Four Sonnes of Aymon*, by William Caxton, and subsequently by Wynkyn de Worde and William Copland. See *Hist. litt. de la France*, xxii., analysis by Paulin Paris; *Reinaud de Montauban* (Stuttgart, 1862), edited by F. Wülff; *Michelant; F. Wülff; Recherches sur les sagas de Magus et de Geirard* (Lund, 1873); *Maugis saga*, ed. C. Cederschiöld (Lund, 1876); *Reinaud von Montauban*, ed. J. C. Matthis (Groningen, 1873); A. Longnon, in *Revue des questions historiques* (1879); R. Zick, *Über die Sprache des Reinaud von Montauban* (Halle, 1884); F. Pfaff, *Das deutsche Volksbuch von den Heymonskindern* (Freiburg in Breisgau, 1887), with a general introduction to the study of the saga; *The Four Sonnes of Aimon* (E. E. Text. Soc., ed. Octavia Richardson, 1884); a special bibliography of the printed editions of the prose romance in L. Gautier's *Bibl. des chansons de geste* (1897); rejuvenations of the story by Karl Simrock (Frankfurt, 1845), and by Richard Steel (London, 1897); *Storia di Rinaldo*, ed. C. Minutoli (Bologna, 1865). Stage versions are: *Reinaud de Montauban*, a play translated from Lope de Vega was played at the Théâtre italien, Paris, in 1717; *Les quatre fils Aymon*, opéra comique by MM. de Leuven and Brunswick, music by Balfe, in 1884.

RENAUDOT, EUSÈBE (1646-1720), French theologian and Orientalist, was born in Paris in 1646, and educated for the church. Notwithstanding his taste for theology and his title of abbé, much of his life was spent at the French court, where he attracted the notice of Colbert and was often employed in confidential affairs. The unusual learning in Eastern tongues which he acquired in his youth and maintained amid the distractions of court life did not bear fruit till he was sixty-two. His best-known books are *Historia Patriarcharum Alexandrinorum* (Paris, 1713) and *Liturgiarum orientalium collectio* (2 vols., 1715-16). The latter was designed to supply proofs of the "perpetuity of the faith" of the church on the subject of the sacraments, the topic on which most of his theological writings turned, and which was then, in consequence of the controversies attaching to Arnauld's *Perpétuité de la foi*, a burning one between French Catholics and Protestants. Renaudot was not a fair controversialist, but his learning and industry are unquestionable. He died in 1720.

RENAUDOT, THÉOPHRASTE (1586-1653), French physician and philanthropist, was born at Loudun (Vienna), and studied surgery in Paris. He was only nineteen when he received, by favour apparently, the degree of doctor at Montpellier. After some time spent in travel he began to practise in his native town. In 1612 he was summoned to Paris by

Richelieu, partly because of his medical reputation, but more because of his philanthropy. He received the titles of physician and councillor to the king, and was desired to organize a scheme of public assistance. Many difficulties were put in his way, however, and he therefore returned until 1624 to Poitou, where Richelieu made him "commissary general of the poor." It was six years before he was able to begin his work in Paris by opening an information bureau at the sign of the Grand Coq near the Pont Saint-Michel. This *bureau d'adresse* was labour bureau, intelligence department, exchange and charity organization in one; and the sick were directed to doctors prepared to give them free treatment. Presently he established a free dispensary in the teeth of the opposition of the faculty in Paris. The Paris faculty refused to accept the new medicaments proposed by the heretic from Montpellier, restricting themselves to the old prescriptions of blood-letting and purgation. In addition to his *bureau d'adresse* Renaud established a system of lectures and debates on scientific subjects, the reports of which from 1633 to 1642 were published in 1651 with the title *Recueil des conférences publiques*. Under the protection of Richelieu he started the first French newspaper, the *Gazette* (1631), which appeared weekly and contained political and foreign news. He also edited the *Mercur françois* and published all manner of reports and pamphlets. In 1637 he opened in Paris the first Mont de Piété, an institution of which he had seen the advantages in Italy. In 1640 the medical faculty, headed by Guy Patin, started a campaign against the innovator of the Grand Coq. After the death of Richelieu and of Louis XIII. the victory of Renaudot's enemies was practically certain. The parlement of Paris ordered him to return the letters patent for the establishment of his bureau and his Mont de Piété, and refused to allow him to practise medicine in Paris. The *Gazette* remained, and in 1646 Renaudot was appointed by Mazarin historiographer to the king. During the first Fronde he had his printing presses at Saint-Germain. He died on the 25th of October 1653. His difficulties had been increased by his Protestant opinions. His sons Isaac (d. 1688) and Eusebe (d. 1679) were students for ten years before they could obtain their doctorates from the faculty. They carried on their father's work, and defended the virtues of antimony, laudanum and quinine against the schools.

See E. Hatin, *Théodore Renaudot* (Poitiers, 1883), and *La Maison du Coq* (Paris, 1885); Michel Emery, *Renaudot et l'introduction de la médication chimique* (Paris, 1889); G. Bonnetont, *Un Oublié. Théophraste Renaudot* (Limoges, n.d.).

RENDEZVOUS, a place of meeting appointed or arranged for the assembling of troops, ships or persons. The word was adopted in English at the end of the 16th century from the French substantival use of the imperative *rendez vous*, i.e. "render or betake yourselves."

RENDSBURG, a town of Germany, in the Prussian province of Schleswig-Holstein, situated on the Eider and on the Kaiser Wilhelm canal, in a flat and sandy district, 20 m. W. of Kiel, on the Altona-Vamdrup railway. Pop. (1905) 15,577. It consists of three parts—the crowded Altstadt, on an island in the Eider; the Neuwerk, on the south bank of the river; and the Kronwerk, on the north bank. Rendsburg is the chief place in the basin of the Eider, and when in the possession of Denmark was maintained as a fortress. Its present importance, however, rests on the commercial facilities afforded by its connexion with the North Sea and the Baltic through the Kaiser Wilhelm canal, by which transit trade is carried on in grain, timber, Swedish iron and coals. The principal industries are cotton-weaving, tanning and the manufacture of artificial manures.

Rendsburg came into existence under the shelter of a castle founded by the Danes about the year 1100 on an island of the Eider, and was an object of dispute between the Danish kings and the counts of Holstein. In 1252 it was adjudged to the latter. The town was surrounded with ramparts in 1539, but the fortifications of the Kronwerk were not constructed till the end of the 17th century. During the Thirty Years' War Rendsburg was taken both by the Imperialists and the Swedes, but in 1645 it successfully resisted a second siege by the latter.

The war of 1848-50 began with the capture of Rendsburg by the Holsteiners by a *coup de main*, and it formed the centre of the German operations. On the departure of the German troops in 1852 the Danes demolished the fortifications on the north side. Immediately after the death of King Frederick VII. (15th of November 1863) the town was occupied by the Saxon troops acting as the executive of the German Confederation, and it was the base of the operations of the Austrians and Prussians against Schleswig in the spring of the following year. On the termination of the Danish war in 1864 Rendsburg was jointly occupied by Austrian and Prussian military until 1866, when it fell to Prussia.

See Warmstedt, *Rendsburg* (Kiel, 1850).

RENÉ I. (1409-1480), duke of Anjou, of Lorraine and Bar, count of Provence and of Piedmont, king of Naples, Sicily and Jerusalem, was born at Angers on the 16th of January 1409, the second son of Louis II., king of Sicily, duke of Anjou, count of Provence, and of Yolande of Aragon. Louis II. died in 1417, and his sons, together with their brother-in-law, afterwards Charles VII. of France, were brought up under the guardianship of their mother. The elder, Louis III., succeeded to the crown of Sicily and to the duchy of Anjou, René being known as the count of Guise. By his marriage treaty (1419) with Isabel, elder daughter of Charles II., duke of Lorraine, he became heir to the duchy of Bar, which was claimed as the inheritance of his mother Yolande, and, in right of his wife, heir to the duchy of Lorraine. René, then only ten, was to be brought up in Lorraine under the guardianship of Charles II. and Louis, cardinal of Bar, both of whom were attached to the Burgundian party, but he retained the right to bear the arms of Anjou. He was far from sympathizing with the Burgundians, and, joining the French army at Reims in 1429, was present at the coronation of Charles VII. When Louis of Bar died in 1430 René came into sole possession of his duchy, and in the next year, on his father-in-law's death, he succeeded to the duchy of Lorraine. But the inheritance was claimed by the heir-male, Antoine de Vaudémont, who with Burgundian help defeated René at Bulgnéville in July 1431. The Duchess Isabel effected a truce with Antoine de Vaudémont, but the duke remained a prisoner of the Burgundians until April 1432, when he recovered his liberty on parole on yielding up as hostages his two sons, Jean and Louis of Anjou. His title as duke of Lorraine was confirmed by his suzerain, the Emperor Sigismund, at Basel in 1434. This proceeding roused the anger of the Burgundian duke, Philip the Good, who required him early in the next year to return to his prison, from which he was released two years later on payment of a heavy ransom. He had succeeded to the kingdom of Naples through the deaths of his brother Louis III. and of Jeanne II. de Durac, queen of Naples, the last heir of the earlier dynasty. Louis had been adopted by her in 1431, and she now left her inheritance to René. The marriage of Marie de Bourbon, niece of Philip of Burgundy, with John, duke of Calabria, René's eldest son, cemented peace between the two princes. After appointing a regency in Bar and Lorraine, he visited his provinces of Anjou and Provence, and in 1438 set sail for Naples, which had been held for him by the Duchess Isabel. René's captivity, and the poverty of the Angevin resources due to his ransom, enabled Alphonso of Aragon, who had been first adopted and then repudiated by Jeanne II., to make some headway in the kingdom of Naples, especially as he was already in possession of the island of Sicily. In 1441 Alphonso laid siege to Naples, which he sacked after a six months' siege. René returned to France in the same year, and though he retained the title of king of Naples his effective rule was never recovered. Later efforts to recover his rights in Italy failed. His mother Yolande, who had governed Anjou in his absence, died in 1442. René took part in the negotiations with the English at Tours in 1444, and peace was consolidated by the marriage of his younger daughter, Margaret, with Henry VI. at Nancy. René now made over the government of Lorraine to John, duke of Calabria, who was, however, only formally installed as duke of Lorraine on the death of Queen Isabel in

1453. René had the confidence of Charles VII., and is said to have initiated the reduction of the men-at-arms set on foot by the king, with whose military operations against the English he was closely associated. He entered Rouen with him in November 1449, and was also with him at Formigny and Caen. After his second marriage with Jeanne de Laval, daughter of Guy XIV., count of Laval, and Isabel of Brittany, René took a less active part in public affairs, and devoted himself more to artistic and literary pursuits. The fortunes of his house declined in his old age. The duke of Calabria, after repeated misfortunes in Italy, was offered the crown of Aragon in 1467, but died, apparently by poison, at Barcelona on the 16th of December 1470; the duke's eldest son Nicholas perished in 1473, also under suspicion of poisoning; René's daughter Margaret was a refugee from England, her son Prince Edward was murdered in 1471, and she herself became a prisoner, to be rescued by Louis XI. in 1476. His only surviving male descendant was then René II., duke of Lorraine, son of his daughter Yolande, comtesse de Vaudémont, who was gained over to the party of Louis XI., who suspected the king of Sicily of complicity with his enemies, the duke of Brittany and the Constable Saint-Pol. René retired to Provence, and in 1474 made a will by which he left Bar to his grandson René II., duke of Lorraine; Anjou and Provence to his nephew Charles, count of Le Maine. Louis seized Anjou and Bar, and two years later sought to compel the king of Sicily to exchange the two duchies for a pension. The offer was rejected, but further negotiations assured the lapse to the crown of the duchy of Anjou, and the annexation of Provence was only postponed until the death of the count of Le Maine. René died on the 10th of July 1480, his charities having earned for him the title of "the good." He founded an order of chivalry, the *Ordre du Croissant*, which was anterior to the royal foundation of St Michael, but did not survive René.

The king of Sicily's fame as an amateur of painting has led to the attribution to him of many old paintings in Anjou and Provence, in many cases simply because they bear his arms. These works are generally in the Flemish style, and were probably executed under his patronage and direction, so that he may be said to have formed a school of the fine arts in sculpture, painting, gold work and tapestry. Two of the most famous works formerly attributed to René are the triptych, the "Burning Bush," in the cathedral of Aix, showing portraits of René and his second wife, Jeanne de Laval, and an illuminated Book of Hours in the Bibliothèque nationale, Paris. The "Burning Bush" was in fact the work of Nicolas Froment, a painter of Avignon. Among the men of letters attached to his court was Antoine de la Sale, whom he made tutor to his son, the duke of Calabria. He encouraged the performance of mystery plays; on the performance of a mystery of the Passion at Saumur in 1462 he remitted four years of taxes to the town, and the representations of the Passion at Angers were carried out under his auspices. He exchanged verses with his kinsman, the poet Charles of Orleans. The best of his poems is the idyl of Regnard and Jeanneton, representing his own courtship of Jeanne de Laval. *Le Livre des tournois*, a book of ceremonial, and the allegorical romance, *Conqueste qu'un chevalier nommé le Cœur d'amour espris feist d'une dame appelée Douce Mercy*, with other works ascribed to him, were perhaps dictated to his secretaries, or at least compiled under his direction. His *Œuvres* were published by the comte de Quatrebarbes (4 vols., Paris and Angers, 1845-46).

See A. Lecoy de la Marche, *Le Roi René* (2 vols., 1875); A. Vallet de Viriville, in the *Nouvelle Biographie générale*, where there is some account of the MSS. of his works; and J. Renouvier, *Les Peintres et écrivains du roi René* (Montpellier, 1857).

RENÉE OF FRANCE (1510-1575), second daughter of Louis XII. and Anne of Brittany, was born at Blois on the 25th of October 1510. After being betrothed successively to Gaston de Foix, Charles of Austria (the future emperor Charles V.), his brother Ferdinand, Henry VIII. of England, and the elector Joachim II. of Brandenburg, she married in 1528

Hercules of Este, son of the duke of Ferrara, who succeeded his father six years later. René's court became a rendezvous of men of letters and a refuge for the persecuted French Calvinists. She received Clément Marot and Calvin at her court, and finally embraced the reformed religion. Her husband, however, who viewed these proceedings with disfavour, banished her friends, took her children from her, threw her into prison, and eventually made her abandon at any rate the outward forms of Calvinism. After his death in 1559, René returned to France and turned her duchy of Montargis into a centre of Protestant propaganda. During the wars of religion she was several times molested by the Catholic troops, and in 1562 her château was besieged by her son-in-law, the duke of Guise. She died at Montargis.

See B. Fontana, *Renata di Francia* (Rome, 1889 seq.); and E. Rodocanachi, *Renée de France* (Paris, 1896).

RENEVIER, EUGÈNE (1831-), Swiss geologist, was born at Lausanne on the 26th of March 1831. In 1857 he became professor of geology and palaeontology in the university at Lausanne. He is distinguished for his researches on the geology and palaeontology of the Alps, on which subjects he published numerous papers in the proceedings of the scientific societies in Switzerland and France. With F. J. Pictet he wrote a memoir on the *Fossiles du terrain aptien de la Perte-du-Rhone* (1854). In 1894 he was appointed president of the Swiss Geological Commission, and also of the International Geological Congress held that year at Zürich, in the previous meetings of which he had taken a prominent part. He published a noteworthy *Tableau des terrains sédimentaires* (1874); and a second more elaborate edition, accompanied by an explanatory article *Chronographie géologique*, was issued in 1897 as a supplement to the Report of the Zürich Congress. This new table was printed on coloured sheets, the colours for each geological system corresponding with those adopted on the International geological map of Europe.

RENFREW, a royal, municipal and police burgh and county town of Renfrewshire, Scotland, near the southern bank of the Clyde, 7 m. W. by N. of Glasgow, via Cardonald, by the Glasgow & South-Western and Caledonian railways (5 m. by road). Pop. (1891) 6777; (1901) 9206. Industries include ship-building (the construction of dredgers and floating docks is a speciality), engineering, dyeing, weaving, chemicals and cabinet-making. The Clyde trust has constructed a large dock here. Renfrew belongs to the Kilmarnock district group of parliamentary burghs (with Kilmarnock, Dumbarton, Rutherglen and Port Glasgow). Robert III. gave a charter in 1396, but it was a burgh (Renifry) at least 250 years earlier. About 1160 Walter Fitzalan, the first high steward of Scotland, built a castle on an eminence by the side of the Clyde (still called Castle Hill), the original seat of the royal house of Stewart. Close to the town, on the site of Elderslie House, Somerled, lord of the Isles, was defeated and slain in 1164 by the forces of Malcolm IV., against whom he had rebelled. In 1404 Robert II. bestowed upon his son James (afterwards James I.) the title of Baron of Renfrew, still borne by the prince of Wales.

RENFREWSHIRE, a south-western county of Scotland, bounded N. by the river and firth of Clyde, E. by Lanarkshire, S. and S.W. by Ayrshire and W. by the firth of Clyde. A small detached portion of the parish of Renfrew, situated on the northern bank of the Clyde, is surrounded on the landward side by Dumbartonshire. The county has an area of 153,332 acres, or 239.6 sq. m. Excepting towards the Ayrshire border on the south-west, where the principal heights are Hill of Stake (1711 ft.), East Girt Hill (1673), Misty Law (1663) and Creuch Hill (1446), and the confines of Lanarkshire on the south-east, where a few points attain an altitude of 1200 ft.—the surface is undulating rather than rugged. Much of the higher land in the centre is well wooded. The Clyde forms part of the northern boundary of the shire. In the N.W. Loch Thom and Gryfe Reservoir provide Greenock with water, and Balgray Reservoir and Glen Reservoir reinforce the water-supply of a portion of the Glasgow area. The other lakes are situated in the S. and S.E. and

include Castle Semple Loch, Long Loch, Brothar Loch, Black Loch, Binend Loch and Dunwan Dam. The Glasgow, Paisley and Johnstone canal has been converted since 1882 into the track of the Glasgow & South-Western railway. Strathgryfe is the only considerable vale in the shire. It extends from the reservoir to below Bridge of Weir, a distance of 10 m. The scenery at its head is somewhat wild and bleak, but the lower reaches are pasture land. The wooded ravine of Glenkillock, to the south of Paisley, is watered by Killock Burn, on which are three falls.

Geology.—Carboniferous rocks form the substratum of this county. The hilly ground from the neighbourhood of Eaglesham north-westward is formed of volcanic rocks, basalts, porphyrites, tuffs and agglomerates of the age of the Cementstone group of the Califerous Sandstone series. Here and there the sites of the volcanic cones are distinguishable, the best being those between Misty Law and Queenside Muir. Beneath the volcanic rocks are some red sandstones and conglomerates which occupy a small tract between Loch Thom and the neighbourhood of Inverkip. Resting upon the volcanic rocks is the Carboniferous Limestone series which at the base consists of ashy sandstones and grits followed by the three subdivisions prevalent in southern Scotland. With unimportant exceptions, all a north of the volcanic rocks is occupied by the Carboniferous Limestone series. The beds lie in a faulted basin around Linwood, and the following strata may be distinguished from below upwards: the Hurlet coal and limestone, Lillies oil shale, Hosié limestone, Johnstone clay ironstone and Cowglass limestone along with other beds of ironstone and coal. The sandstone of Giffnock, used for building; the limestone and coal of Orchard with a very fossiliferous shale bed; and the limestone and coal of Arden all belong to the same series. Besides the contemporaneous volcanic rocks numerous intrusive sheets are found in the Carboniferous rocks such as the large mass of basalt south of Johnstone; and a doleritic sheet of Quarrelton and the similar sheets N.E. of Paisley. In the eastern part of the county near the border the coals and ironstones of this series near Shawlands and Crossmyloof are faulted directly against the coal measures of Rutherglen. Tertiary basalt dikes cut the older rocks in a S.E.-N.W. direction, for example those on Misty Law. Glacial striae abound on the hilly ground, those in the north indicating that the ice took a south-easterly direction which farther south became south-westerly. Boulder clays, gravels and sands also cover considerable areas. Copper ore has been worked in the volcanic rocks near Lochwinnoch and in the grey sandstones near Gourock.

Climate and Agriculture.—The climate is variable. As the prevailing west and south-west winds come in from the Atlantic warm and full of moisture, contact with the land causes heavy rains, and the western area of the shire is one of the wettest districts in Scotland, the mean annual rainfall exceeding 60 in. The temperature for the year averages about 48° F., for January 38°·5 F., and for July 58°·5 F. The hilly tract contains much peat-moss and moorland, but over those areas which are not thus covered the soil, which is a light earth on a substratum of gravel, is deep enough to produce good pasture. In the undulating central region the soil is better, particularly in the basins of the streams, while on the flat lands adjoining the Clyde there is a rich alluvium which, except when sown by excessive rain, yields heavy crops. Of the total area three-fifths is under cultivation, more than half of this being permanent pasture. Oats are grown extensively, and wheat and barley are also cultivated. Potatoes, turnips and swedes, and beans are the leading green crops. Near the populous centres orchards and market gardens are found, and an increasing acreage is under wood. Horses are kept mostly for farming operations, and the bulk of the cattle are maintained in connexion with dairying. Sheep-farming, though on the increase, is not prosecuted so vigorously as in the other southern counties of Scotland, and pig-rearing is on the decline.

Other Industries.—Coal, iron, oil-shale and freclay are the principal minerals. Limestone is largely quarried for smelting purposes, and for the manufacture of lime. Sandstone is also quarried. The thread industry at Paisley is the most important in the world. Cotton spinning, printing, bleaching and dyeing are carried on at Paisley, Pollokshaws, Renfrew, Barrhead and elsewhere; woollens and worsteds are produced at Paisley, Greenock and Renfrew. Engineering works and iron and brass foundries are found at Greenock, Port-Glasgow, Paisley, Renfrew, Barrhead and Johnstone. Sugar is a staple article of trade in Greenock and there are chemical works at Hurlet, Nitshill and Renfrew. Brewing and distilling are carried on at Greenock, Paisley and other places. Shipbuilding is especially important at Greenock and Port-Glasgow. Paper mills are established in Greenock, Cathcart and Johnstone, and tanneries in Paisley and Kilbarchan. Numerous miscellaneous industries—such as the making of starch, cornflour and preserves—have also grown up in Paisley and elsewhere. The sea and river ports are Greenock, Port-Glasgow and Renfrew.

Railway communication is ample in the north, the centre and towards the south-west. The Caledonian railway runs westwards

from Glasgow by Paisley to Greenock, Gourock and Wemyss Bay; south-westwards to Barrhead and other stations; and southwards to Busby. The Glasgow & South-Western railway runs to Greenock by Paisley, Johnstone and Kilmacolm; to Nitshill and other places south-westwards; by Lochwinnoch (for Dalry and Ardrossan in Ayrshire); and to Renfrew jointly with the Caledonian. The Clyde and the railway steamers call at Renfrew, Prince's Pier (Greenock), Gourock and Wemyss Bay.

Population and Administration.—In 1891 the population numbered 230,812, and in 1901 it was 268,980, or 123 to the sq. m. In 1901 there were 40 persons who spoke Gaelic only and 5585 Gaelic and English. Thus though the shire is but twenty-seventh in point of size of the 33 Scottish counties, it is fifth in respect of population, and only Lanarkshire and Mid Lothian are more densely populated. The county is divided into the upper ward, embracing the easterly two-thirds, with Paisley as district centre, and the lower ward, consisting of the parishes of Inverkip, Greenock, Port-Glasgow and Kilmacolm, with Greenock as district centre. The chief towns are Paisley (pop. 79,363), Greenock (68,142), Port-Glasgow (16,857), Pollokshaws (11,369), Johnstone (11,331), Barrhead (9,855), Renfrew (9,266), Gourock (5,261), Cathcart (5,808). The shire returns one member to parliament for the eastern, and another for the western division. Paisley and Greenock return each one member, and Renfrew and Port-Glasgow belong to the Kilmarnock district group of parliamentary burghs. Renfrewshire forms a sheriffdom with Bute, and there is a resident sheriff-substitute at Paisley and one at Greenock. The county is under school-board jurisdiction. For secondary and specialized education there are an academy at Greenock and a grammar school and technical school at Paisley, while some of the schools in the county earn grants for higher education. The county secondary committee also makes provision for the free education of Renfrewshire children in Glasgow High School and the Spier School at Beith. The Paisley Technical School and the Glasgow and West of Scotland Technical College are subsidized out of the "residue" grant, part of which also defrays the travelling expenses of students and supports science and art and technological classes in the burghs and towns in the county.

History.—At the time of the Roman advance from the Solway the land was peopled by the British tribe of Damnonii. To hold the natives in check the conquerors built in 84, the fort of Vanduara on high ground now covered by houses and streets in Paisley; but after the Romans retired (410) the territory was overrun by Cumbrian Britons and formed part of the kingdom of Strathclyde, the capital of which was situated at Alclyde, the modern Dumbarton. In the 7th and 8th centuries the region practically passed under the supremacy of Northumbria, but in the reign of Malcolm Canmore became incorporated with the rest of Scotland. During the first half of the 12th century, Walter Fitzalan, high steward of Scotland, ancestor of the royal house of Stuart, settled in Renfrewshire on an estate granted to him by David I. Till their accession to the throne the Stuarts identified themselves with the district, which, however, was only disjoined from Lanarkshire in 1404. In that year Robert III. erected the barony of Renfrew and the Stuart estates into a separate county, which, along with the earldom of Carrick and the barony of King's Kyle (both in Ayrshire), was bestowed upon his son, afterwards James I. From their grant are derived the titles of earl of Carrick and baron of Renfrew, borne by the eldest son of the sovereign. Apart from such isolated incidents as the defeat of Somerled near Renfrew in 1164, the battle of Langside in 1568 and the capture of the 9th earl of Argyll at Inchinnan in 1685, the history of the shire is scarcely separable from that of Paisley or the neighbouring county of Lanark.

BIBLIOGRAPHY.—*Description of the Sheriffdom of Lanark and Renfrew* (Maitland Club, 1831); W. Hector, *Lichens from an Old Abbey* (Paisley, 1876); *Vanduara* (Paisley, 1881); Gilmour, *Paisley, Weavers of Other Days* (Paisley, 1879); D. Campbell, *Historical Sketches of the Town and Harbours of Greenock* (1879-81); *Old Greenock* (Greenock, 1888); Craig, *Historical Notes on Paisley* (Paisley, 1881); A. H. Millar, *Castles and Mansions of Renfrew* (Glasgow, 1889).

RENNELL, JAMES (1742–1830), British geographer, was born on the 3rd of December 1742, near Chudleigh in Devonshire. His father, an officer in the Artillery, was killed in action shortly after the birth of his son. He entered the navy as a midshipman in 1756, and was present at the attack on Cherbourg (1758), and the disastrous action of St Cast in the same year. At the end of the Seven Years' War, seeing no chance of promotion, he entered the service of the East India Company, and was appointed surveyor of the Company's dominions in Bengal (1764), with the rank of captain in the Bengal Engineers. To this work he devoted the next thirteen years. In 1766 he received a severe wound in an encounter with some Sannyasis, or religious fanatics, from which he never thoroughly recovered; and in 1777 he retired as major on a pension of £600 a year. The remaining fifty-three years of his life were spent in London, and were devoted to geographical research chiefly among the materials in the East India House. His most valuable works include the *Bengal Atlas* (1779), the first approximately correct map of India (1783), the *Geographical System of Herodotus* (1800), the *Comparative Geography of Western Asia* (1831), and important studies on the geography of northern Africa—in introductions to the *Travels of Mungo Park and Hornemann*—and the currents of the Atlantic and Indian Oceans. He also contributed papers to *Archæologia* on the site of Babylon, the island of St Paul's shipwreck, and the landing-place of Caesar in Britain. He was elected F.R.S. in 1781; and he received the Copley medal of the Royal Society in 1791, and the gold medal of the Royal Society of Literature in 1825. While in India he had married (1772) Jane Thackeray, a great-aunt of the novelist. He died on the 29th of March 1830, and was buried in the nave of Westminster Abbey.

See Sir Clements Markham *Major James Rennell and the Rise of Modern English Geography* (London, 1895).

RENNES, a town of western France, formerly the capital of Brittany and now the chief town of the department of Ille-et-Vilaine. Pop. town, 62,024; commune, 75,640. Rennes is situated at the meeting of the Ille and the Vilaine and at the junction of several lines of railway connecting it with Paris (232 m. E.N.E.), St Malo (51 m. N.N.W.), Brest (155 m. W.N.W.). A few narrow winding streets with old houses are left in the vicinity of the cathedral, but the town was for the most part rebuilt on a regular plan after the seven days' fire of 1720. Dark granite was used as building material. The old town or Ville-Haute, where the chief buildings are situated, occupies a hill bounded on the south by the Vilaine, on the west by the canalized Ille. The Vilaine flows in a deep hollow bordered with quays and crossed by six bridges leading to the new town or Ville-Basse on its left bank. The cathedral of Rennes was rebuilt in a pseudo-Ionic style between 1787 and 1844 on the site of two churches dating originally from the 4th century. The west facade with its twin towers was finished in 1700 and is in the Renaissance style. The interior is richly decorated, a German altar-piece of the 15th century being conspicuous for its carving and gilding. The archbishop's palace occupies in part the site of the abbey dedicated to St Melaine, whose church is the sole specimen of 11–13th century architecture among the numerous churches in the town. A colossal statue of the Virgin was placed above its dome in 1867. The Mordelaise Gate, by which the dukes and bishops used to make their state entry into the town, is a curious example of 15th-century architecture, and preserves a Latin inscription of the 3rd century, a dedication by the Redones to the emperor Gordianus. The finest building in Rennes is the old parliament house (now the law-court), designed by Jacques Debrosse in the 17th century, and decorated with statues of legal celebrities, carving, and paintings by Jean Jouvenet and other well-known artists. The town hall was erected in the first half of the 18th century. It contains the library and the municipal archives, which are of great importance for the history of Brittany. In the Palais Universitaire, a modern building occupied by the university, there are scientific collections and important galleries of painting and sculpture, the chief work being the "Perseus

delivering Andromeda" of Paul Veronese. About 2 m. from the town is the castle (16th century) of La Prévelaye, a hamlet famous for its butter.

Rennes is the seat of an archbishop and a prefect, headquarters of the X. army corps and centre of an *académie* (educational division). Its university has faculties of law, science and letters, and a preparatory school of medicine and pharmacy, and there are training colleges, a *lycée* and schools of agriculture, dairying, music, art, architecture and industry (*Ecole pratique*). The town is also the seat of a court of appeal, of a court of assizes, of tribunals of first instance and commerce, and of a chamber of commerce, and has a branch of the Bank of France. Tanning, iron-founding, timber-sawing and the production of furniture and wooden goods, flour-milling, flax-spinning and the manufacture of tenting and other coarse fabrics, bleaching and various smaller industries are carried on. Trade is chiefly in butter made in the neighbourhood, and in grain, flour, leather, poultry, eggs and honey.

Rennes, the chief city of the Redones, was formerly (like some other places in Gaul) called *Condate* (hence *Condat*, *Condé*), probably from its position at the confluence of two streams. Under the Roman empire it was included in *Lugdunensis Tertia*, and became the centre of various Roman roads still recognizable in the vicinity. The name *Urbs Rubra* given to it on the oldest chronicles is explained by the bands of red brick in the foundations of its first circuit of walls. About the close of the 10th century Conan le Tort, count of Rennes, subdued the whole province, and his son and successor Geoffrey first took the title duke of Brittany. The dukes were crowned at Rennes, and before entering the city by the Mordelaise Gate they had to swear to preserve the privileges of the church, the nobles and the commons of Brittany. During the War of Succession the city more than once suffered siege, notably in 1356–57, when Bertrand du Guesclin saved it from capture by the English under Henry, first duke of Lancaster. The parlement of Brittany, founded in 1551, held its sessions at Rennes from 1561, they having been previously shared with Nantes. During the troubles of the League Philip Emmanuel, duke of Mercœur, attempted to make himself independent at Rennes (1589), but his scheme was defeated by the loyalty of the parlement. Henry IV. entered the city in state on the 9th of May 1598. In 1675 an insurrection at Rennes, caused by the taxes imposed by Louis XIV. in spite of the advice of the parlement, was cruelly suppressed by Charles, duke of Chaulnes, governor of the province. The parlement was banished to Vannes till 1689, and the inhabitants crushed with forfeits and put to death in great numbers. The fire of 1720, which destroyed eight hundred houses, completed the ruin of the town. At the beginning of the Revolution Rennes was again the scene of bloodshed, caused by the discussion about doubling the third estate for the convocation of the states-general. In January 1789, Jean Victor Moreau (afterwards general) led the law-students in their demonstrations on behalf of the parlement against the royal government. During the Reign of Terror Rennes suffered less than Nantes, partly through the courage and uprightness of the mayor, Jean Laperdit. It was soon afterwards the centre of the operations of the Republican army against the Vendéans. The bishopric, founded in the 5th century, in 1859 became an archbishopric, a rank to which it had previously been raised from 1790 to 1802. In 1809 the revision of the sentence of Captain Alfred Dreyfus was carried out at Rennes.

See Orain, *Rennes et ses environs* (Reims, 1904).

RENNEVILLE, RENÉ AUGUSTE CONSTANTIN DE (1650–1723), French writer, was born at Caen in 1650. In consequence of his Protestant principles, he left France for Holland in 1699, and on his return three years later he was denounced as a spy and imprisoned in the Bastille, where he remained until 1713. During his imprisonment he wrote on the margins of a copy of *Auteurs déguisez* (Paris, 1690) poems which he called *Olia bastiliaca*. These were rediscovered by Mr James Tregaski in 1906. Renneville was set at liberty through the intercession of Queen Anne, and made his way to England, where he published

his *Histoire de la Bastille* (7 vols., 1713-24), dedicated to George I. At the time of his death in 1723 he was a major of artillery in the service of the elector of Hesse. His other important work is a *Recueil des voyages qui ont servi à l'établissement de la Compagnie des Indes Orientales aux Provinces Unies* (10 vols., new ed., Rouen, 1725).

RENNIE, JOHN (1761-1821), British engineer, was the youngest son of James Rennie, a farmer at Phantassie, Haddingtonshire, where he was born on the 7th of June 1761. On his way to the parish school at East Linton he used to pass the workshop of Andrew Meikle (1710-1800), the inventor of the threshing machine, and its attractions were such that he spent there much of the time that was supposed to be spent at school. In his twelfth year he was placed under Meikle, but after two years he was sent to Dunbar High School, where he showed marked aptitude for mathematics. On his return to Phantassie he occasionally assisted Meikle, and soon began to erect corn mills on his own account. In 1780, while continuing his millwright's business, he began to attend the classes on physical science at Edinburgh University. Four years later he was commissioned by Boulton and Watt, to whom he was introduced by Professor John Robison (1739-1805), his teacher at Edinburgh, to superintend the construction of the machinery for the Albion flour mills, which they were building at the south end of Blackfriars Bridge, London, and a feature of his work there was the use of iron for many portions of the machines which had formerly been made of wood. The completion of these mills established his reputation as a mechanical engineer, and soon secured him a large business as a maker of millwork of all descriptions. But his fame chiefly rests on his achievements in civil engineering. As a canal engineer his services began to be in request about 1790, and the Avon and Kennet, the Rochdale and the Lancaster canals may be mentioned among his numerous works in England. His skill solved the problem of draining and reclaiming extensive tracts of marsh in the eastern counties and on the Solway Firth. As a bridge engineer he was responsible for many structures in England and Scotland, among the most conspicuous being three over the Thames—Waterloo Bridge, Southwark Bridge and London Bridge—the last of which he did not live to see completed. A noteworthy feature in many of his designs was the flat roadway. Among the harbours and docks in the construction of which he was concerned may be mentioned those at Wick, Torquay, Grimsby, Holyhead, Howth, Kingstown and Hull, together with the London dock and the East India dock on the Thames, and he was consulted by the government in respect of improvements at the dockyards of Portsmouth, Sheerness, Chatham and Plymouth, where the breaker was built from his plans. He died in London on the 4th of October 1821, and was buried in St Paul's. In person he was of great stature and strength, and a bust of him by Chantrey (now in the National Gallery), when exhibited at Somerset House, obtained the name of Jupiter Tonans. Of his family, the eldest son George, who was born in London on the 3rd of September 1791 and died there on the 30th of March 1866, carried on his father's business in partnership with the second son John, who was born in London on the 30th of August 1794 and died near Hertford on the 3rd of September 1874. George devoted himself especially to the mechanical side of the business. John completed the construction of London Bridge, and at its opening in 1831 was made a knight. He succeeded his father as engineer to the Admiralty, and finished the Plymouth breaker, of which he published an account in 1848. He was also the author of a book on the *Theory, Formation and Construction of British and Foreign Harbours* (1851-54), and his *Autobiography* appeared in 1875. He was elected president of the Institution of Civil Engineers in 1845, and held the office for three years.

RENO, a city and the county-seat of Washoe county, Nevada, U.S.A., in the W. part of the state, on the Truckee river, and about 244 m. E. of San Francisco. Pop. (1890) 3563; (1900) 4500 (215 foreign-born); (1910 census) 10,867. It is served by the Southern Pacific, the Virginia & Truckee and the Nevada-California-Oregon railways. The city lies near the foot of the

Sierra Nevada Mountains, 4484 ft. above the sea, and is in the most humid district of a state which has little rainfall. Among the public institutions are the university of Nevada (see NEVADA), a United States Agricultural Experiment Station, a public library (1903), the Nevada Hospital for Mental Diseases (1882), the City and County Hospital and the People's Hospital. At Reno are railway shops (of the Nevada-California-Oregon railway) and reduction works, and the manufactures include flour, foundry and machine-shop products, lumber, beer, plaster and packed meats. Farming and stock-raising are carried on extensively in the vicinity. On the site of the present city a road house was erected in 1859 for the accommodation of travellers and freight teams on their way to and from California. By 1863 this place had become known as Lake's Crossing, and five years later it was chosen as a site for a station by the Central (now the Southern) Pacific railway, then building through the Truckee Valley. The new station was then named Reno, in honour of Gen. Jesse Lee Reno (1823-1862), a Federal officer during the Civil War, who was commissioned brigadier-general of volunteers in November 1861 and major-general of volunteers in July 1862, and led the Ninth Corps at South Mountain, where he was killed. The city twice suffered from destructive fires, in 1873 and 1879. Reno was incorporated as a town in 1879 and chartered as a city in 1899. Its city charter was withdrawn in 1901, but it was rechartered in 1903.

RENOUF, FIRMIN AUGUSTE (1841-), French painter, was born at Limoges in 1841. In his early work he followed, with pronounced modern modifications, certain traditions of the French 18th-century school, more particularly of Boucher, of whom we are reminded by the decorative tendency, the pink and ivory flesh tints and the facile technique of Renoir. In the 'seventies he threw himself into the impressionist movement and became one of its leaders. In some of his paintings he carried the new principle of the division of tones to its extreme, but in his best work, notably in some of his paintings of the nude, he retained much of the refined sense of beauty of colour of the 18th century. Renoir has tried his skill almost in every genre—in portraiture, landscape, flower-painting, scenes of modern life and figure subject; and though he is perhaps the most unequal of the great impressionists, his finest works rank among the masterpieces of the modern French school. Among these are some of his nude "Bathers," the "Rowers' Luncheon," the "Ball at the Moulin de la Galette," "The Box," "The Terrace," "La Pensée," and the portrait of "Jeanne Samary." He is represented in the Caillebotte room at the Luxembourg, in the collection of M. Durand-Ruel, and in most of the collections of impressionist paintings in France and in the United States. Comparatively few of his works have come to England, but the full range of his capacity was seen at the exhibition of impressionist art held at the Grafton Galleries in London in 1905. At the Viau sale in Paris in 1907, a garden scene by Renoir, "La Tonnelle," realized 26,000 frs., and a little head, "Ingenue," 25,100 frs.

RENOUF, SIR PETER LE PAGE (1822-1897), Egyptologist, was born in Guernsey, on the 23rd of August 1822. He was educated at Elizabeth College there, and proceeded to Oxford, which, upon his becoming a Roman Catholic, under the influence of Dr Newman, he quitted without taking a degree. Like many other Anglican converts, he proved a thorn in the side of the Ultramontane party in the Roman Church, though he did not, like some of them, return to the communion of the Church of England. He opposed the promulgation of the dogma of Papal Infallibility, and his treatise (1868) upon the condemnation of Pope Honorius for heresy by the council of Constantinople in A.D. 680 was placed upon the index of prohibited books. He had been from 1855 to 1864 professor of ancient history and Oriental languages in the Roman Catholic university which Newman vainly strove to establish in Dublin, and during part of this period edited the *Atlantis* and the *Home and Foreign Review*, which latter had to be discontinued on account of the hostility of the Roman Catholic hierarchy. In 1864 he was appointed a government inspector of schools, which position he

held until 1886, when his growing celebrity as an Egyptologist procured him the appointment of Keeper of Oriental Antiquities in the British Museum, in succession to Dr Samuel Birch. He was also elected in 1887 president of the Society of Biblical Archaeology, to whose *Proceedings* he was a constant contributor. The most important of his contributions to Egyptology are his Hibbert Lectures on "The Religion of the Egyptians," delivered in 1879; and the translation of *The Book of the Dead*, with an ample commentary, published in the *Transactions* of the society over which he presided. He retired from the Museum under the superannuation rule in 1891, and died in London on the 14th of October 1897. He had been knighted the year before his death. He married in 1857 Ludovica von Brentano, member of a well-known German literary family.

RENOUVIER, CHARLES BERNARD (1815-1903), French philosopher, was born at Montpellier on the 1st of January 1818, and educated in Paris at the *École Polytechnique*. In early life he took an interest in politics, and the approval extended by Hippolyte Carnot to his *Manuel républicain de l'homme et du citoyen* (1848) was the occasion of that minister's fall. He never held public employment, but spent his life writing, retired from the world. He died on the 1st of September 1903. Renouvier was the first Frenchman after Malebranche to formulate a complete idealistic system, and had a vast influence on the development of French thought. His system is based on Kant's, as his chosen term "Néo-criticisme" indicates; but it is a transformation rather than a continuation of Kantianism. The two leading ideas are a dislike to the Unknowable in all its forms, and a reliance on the validity of our personal experience. The former accounts for his acceptance of Kant's phenomenalism, combined with rejection of the thing in itself. It accounts, too, for his polemic on the one hand against a Substantial Soul, a Buddhist Absolute, an Infinite Spiritual Substance; on the other hand against the no less mysterious material or dynamic substratum by which naturalistic Monism explains the world. He holds that nothing exists except presentations, which are not merely sensational, and have an objective aspect no less than a subjective. To explain the formal organization of our experience he adopts a modified version of the Kantian categories. The insistence on the validity of personal experience leads Renouvier to a yet more important divergence from Kant in his treatment of volition. Liberty, he says, in a much wider sense than Kant, is man's fundamental characteristic. Human freedom acts in the phenomenal, not in an imaginary noumenal sphere. Belief is not intellectual merely, but is determined by an act of will affirming what we hold to be morally good. In his religious views Renouvier makes a considerable approximation to Leibnitz. He holds that we are rationally justified in affirming human immortality and the existence of a finite God who is to be a constitutional ruler, but not a despot, over the souls of men. He would, however, regard atheism as preferable to a belief in an infinite Deity.

His chief works are: *Essai de critique générale* (1854-64), *Science de la morale* (1869), *Uchronie* (1876), *Esquisse d'une classification systématique des doctrines philosophiques* (1885-86), *Philosophie analytique de l'histoire* (1896-97), *Histoire et solution des problèmes métaphysiques* (1901); *Victor Hugo: Le Poète* (1893), *Le Philosophe* (1900); *Les Dilemmes de la métaphysique pure* (1901); *Le Personnalisme* (1903); *Critique de la doctrine de Kant* (1906, published by L. Prat).

See L. Prat, *Les Derniers entretiens de Charles Renouvier* (1904); M. Ascher, *Renouvier et der französische Neu-Kriticisme* (1900); E. Janssens, *Le Néocriticisme de C. R.* (1904); A. Darlu, *La Morale de Renouvier* (1904); G. Scailles, *La Philosophie de C. R.* (1905); A. Arnal, *La Philosophie religieuse de C. R.* (1907).

RENSELAEER, a city of Rensselaer county, New York, U.S.A., in the eastern part of the state, on the E. bank of the Hudson river, opposite Albany. Pop. (1900) 7466, of whom 1089 were foreign-born; (1910 census) 10,711. It is served by the New York Central and the Boston & Albany railways, which have shops here, and is connected with Albany by three bridges across the Hudson. Rensselaer, originally called Greenbush, was first settled in 1631, and the site formed part of the large tract bought from the Indians by the agents

of Killian van Rensselaer and known as Rensselaerwyck. In 1810 a square mile of land within the present city limits was acquired by a land speculator, was divided into lots and offered for sale. Development followed, and five years later the village was incorporated. In 1897 Greenbush was chartered as a city, and its name was changed to Rensselaer. Its limits were extended in 1902 by the annexation of the village of Bath (pop. in 1900, 2504) and the western part of the township of East Greenbush. Rensselaer manufactures knit-goods, wool shoddy, felt, &c.

RENT. Various species of rent appear in Roman Law: rent (*canon*) under the long leasehold tenure of Emphyteusis; rent (*reditus*) of a farm; ground-rent (*solarium*); rent of state lands (*pecunia*); and the annual rent (*prensio*) payable for the *ius superficiesarum* or right to the perpetual enjoyment of anything built on the surface of land. (See ROMAN LAW.)

ENGLISH LAW. (As to the rent of apartments, &c., see LODGER and LODGINGS.)—Rent is a certain and periodical payment or service made or rendered by the tenant of a corporeal hereditament and issuing out of (the property of) such hereditament. Its characteristics, therefore, are (1) certainty in amount; (2) periodicity in payment or rendering; (3) the fact that rent is yielded and is, therefore, said "to lie in render," as distinguished from *profits à prendre* in general, which are taken, and are, therefore, said to lie in *prendre*; (4) that it must issue out of (the profits of) a corporeal hereditament. A rent cannot be reserved out of incorporeal hereditaments such as advowsons (Co. Litt. 47a, 142a). But rent may be reserved out of estates in reversion or remainder (see REAL PROPERTY) which are not purely incorporeal. It is not essential that rent should consist in a payment of money. Apart from the rendering of services, the delivery of hens, horses, wheat, &c., may constitute a rent. But, at the present day, rent is generally a sum of money paid for the occupation of land. It is important to notice that this conception of rent was attained at a comparatively late period in the history of the law. The earliest rent seems to have been a form of personal service, generally labour on land, and was fixed by custom. The exaction of a competition or rack rent beyond that limited by custom was, if one may judge from the old Brehon law of Ireland, due to the presence upon the land of strangers in blood, probably at first outcasts from some other group.¹ The strict feudal theory of rent admitted labour on the lord's land as a lower form, and developed the military service due to the crown or a lord as a higher form. Rent service is the oldest and most dignified kind of existing rent. It is the only one to which the power of distress attaches at common law, giving the landlord a preferential right over other creditors exercisable without the intervention of judicial authority (see DISTRESS). The increasing importance of socage tenure, arising in part from the convenience of paying a certain amount, whether in money or kind, rather than comparatively uncertain services, led to the gradual evolution of the modern view of rent as a sum due by contract between two independent persons. At the same time the primitive feeling which regarded the position of landlord and tenant from a social rather than a commercial point of view is still of importance.

Rents, as they now exist in England, are divided Classes of Rents. into two great classes—rent service and rent charge.

Rent Service.—A rent service is so called because by it a tenure by means of service is created between the landlord and the tenant. The service is now represented by fealty, and is nothing more than nominal. Rent service is said to be incident to the reversion—that is, a grant of the reversion carries the rent with it (see REMAINDER). A power of distress is incident

¹ "The three rents are: rack rent from a person of a strange tribe, a fair rent from one of the tribe, and the stipulated rent which is paid equally by the tribe and the strange tribe."—*Senchus Mor*, p. 159, cited by Maine, *Village Communities*, p. 187. See also Vinogradoff, *Village in England* (Oxford, 1892), pp. 181, 188, 215; *The Growth of the Manor* (by the same author) (London, 1905), pp. 230, 328; Pollock and Maitland, *Hist. Eng. Law* (Cambridge, 1895), ii. 128-134.

at common law to this form of rent. Copyhold rents and rents reserved on lease fall into this class.

Rent Charge.—A rent charge is a grant of an annual sum payable out of lands in which the grantor has an estate. It may be in fee, in tail, for life—the most common form—or for years. It must be created by deed or will, and may be either at common law or under the Statute of Uses (1536). The grantor has no reversion, and the grantee has at common law no power of distress, though such power may be given him by the instrument creating the rent charge. The Statute of Uses (1536) gave a power of distress for a rent charge created under the statute. The Conveyancing Act 1881, § 44, has given a power of distress for a sum due on any rent charge which is twenty-one days in arrear. By § 45 a power of redemption of certain perpetual rents in the nature of rent charges is given to the owner of the land out of which the rent issues. Rent charges granted since April 26th, 1855, otherwise than by marriage settlement or will for a life or lives or for any estate determinable on a life or lives must, in order to bind lands against purchasers, mortgagees or creditors, be registered in the Land Registry in Lincoln's Inn Fields (Judgments Act 1855 and Land Charges Act 1900). In certain other cases it is also necessary to register rent charges, for instance, under the Improvement of Land Act 1864 and the Land Transfer Acts 1875 and 1897. Rent charges are barred by non-payment or non-acknowledgment for twelve years. The period of limitation for the arrears of such rent is six years.

Various Forms of Rent Charge.—Forms of rent charge of special interest are *tithe rent charge* (see *TITHES*), and the rent charges formerly used for the purpose of creating "faggot votes." The device was adopted of creating parliamentary voters by splitting up freehold interests into a number of rent-charges of the annual value of 40s., so as to satisfy the freeholders' franchise. But such rent charges are now rendered ineffective by the Representation of the People Act 1884, § 4, which enacts (subject to a saving for existing rights and an exception in favour of owners of tithe rent charge) that a man shall not be entitled to be registered as a voter in respect of the ownership of any rent charge.

A rent charge reserved without power of distress is termed a *rent-seck* (*reditus siccus*) or "dry rent," from the absence of the power of distress. But, as power of distress for rents-seck was given by the Landlord and Tenant Act 1736, the legal effect of such rents has been since the act the same as that of a rent charge.

Other Varieties of Rent.—Rents of *assise* or *Quit rents* are a relic of the old customary rents. They are presumed to have been established by usage, and cannot be increased or diminished. A *Quit rent* (*quietus redditus*) is a yearly payment made from time immemorial by freeholders or copyholders of a manor to the lord. The term implies that the tenant thereby becomes free and quit from all other services. Owing to the change in the value of money, these rents are now of little value. Under the Conveyancing Act 1881 (s. 45) they may be compulsorily redeemed by the freehold tenant; and the Copyhold Act 1894 provides similarly for their extinction in the case of manors. *Quit rents*, like ordinary rent charges, are barred by non-payment, or non-acknowledgment, for twelve years. Those paid by freeholders are called *chief rents*. *Fee farm rents* are rents reserved on grants in fee. According to some authorities, they must be at least one-fourth of the value of the lands. They, like quit rents, now occur only in manors, unless existing before the Statute of *Quia Emptores* or created by the crown (see *REAL PROPERTY*). A rent which is equivalent or nearly equivalent in amount to the full annual value of the land is a *rack rent*. A rent which falls appreciably short of a rack rent is usually styled a *ground rent* (*g.r.*). It is generally reserved on land which the lessee agrees to cover with buildings, and is calculated on the value of the land, though the buildings to be erected increase the security for the rent and revert to the lessor at the end of the term. A *dead rent* is a fixed annual sum paid by a person working a mine or quarry, in addition to royalties varying according to the amount of minerals taken.

The object of a dead rent is twofold—first, to provide a specified income on which the lessor can rely; secondly (and this is the more important reason), as a security that the mine will be worked, and worked with reasonable rapidity. *Rents in kind* still exist to a limited extent; thus the corporation of London is tenant of some lands in Shropshire by payment to the crown of an annual

rent of a fagot. All *peppercorn*, or nominal, rents seem to fall under this head.¹ The object of the peppercorn rent is to secure the acknowledgment by the tenant of the landlord's right. In modern building leases a peppercorn rent is sometimes reserved as the rent for the first few years. Services rendered in lieu of payment by tenants in *grand* and *petit* serjeanty may also be regarded as examples of rents in kind. Grand serjeanty is a form of tenure in chivalry under which the king's tenants (*serjeants*) in chief owed special military or personal services to the king; e.g. carrying his banner. Petit serjeanty—a form of tenure in socage—was usually applied to tenure of the king or a mesne lord by some fixed service of trivial value, e.g. feeding his hounds. These forms of tenure were abolished in 1660. *Labour rents* are represented by those cases, not unrequited in agricultural leases, where the tenant is bound to render the landlord a certain amount of team work or other labour as a part of his rent. It was held in the court of queen's bench in 1845 that tenants who occupied houses on the terms of sweeping the parish church and of ringing the church bell paid rent within the meaning of the Limitation Act of 1833 (see *Doe v. Benham* (1845), 7 Q.B. 976).

As to the apportionment of rents, see *APPORTIONMENT*.

Payment of Rent.—Rent is due in the morning of the day appointed for payment, but a tenant is not in arrears until after midnight on that day. Rent made payable in advance by agreement between a landlord and his tenant is called *forehand rent*. It is not uncommon in letting a furnished house, or as to the last quarter of the term of a lease of unfurnished premises, to stipulate that the rent shall be paid in advance. As soon as such rent is payable under the agreement the landlord has the same rights in regard to it as he has in the case of ordinary rent. If a tenant pays his rent before the day on which it is due, he runs the risk of being called upon in certain circumstances to pay it over again. Such a payment is an advance to the landlord, subject to an agreement that, when the rent becomes due, the advance shall be treated as a fulfilment of the tenant's obligation to pay rent. The payment is, therefore, generally speaking, a defence to an action by the landlord or his heirs. But if the landlord mortgages his reversion, either before or after the advance, the assignee will, by giving notice to the tenant, before the proper rent-day, to pay rent to him, become entitled to the rent then falling due. Payment by cheque is conditional payment only, and if the cheque is dishonoured the original obligation revives. Where a cheque in payment of rent is lost in the course of transmission through the post, the loss falls on the tenant, unless the landlord has expressly or impliedly authorized it to be forwarded in that way; and the landlord's consent to take the risk of such transmission will not be inferred from the fact that payments were ordinarily made in this manner in the dealings between the parties. A tenant may deduct from his rent (i) the "landlord's property tax" (on the annual value of the premises for income tax purposes), which is paid by the tenant, if the statute imposing the tax authorizes the deduction (which should be made from the rent next due after the payment); (ii) taxes or rates which the landlord had undertaken to pay but had not paid, payment having thereupon been made by the tenant; (iii) payments made by the tenant which ought to have been made by the landlord, e.g. rent due to a superior landlord; (iv) compensation under the Agricultural Holdings Acts 1883-1900.

Remedies for Non-payment of Rent.—A landlord's main remedy for non-payment of rent is *distress* (Lat. *distringere*, to draw asunder, detain, occupy), i.e. the right to seize all goods found upon the demised premises, whether those of the tenant or of a stranger, except goods specially privileged, and to detain and, if need be, to sell them, in satisfaction of his claim. The requisites of a valid distress are these: (a) There must be "a certain and proper rent," i.e. rent due in respect of an actual tenancy of corporeal hereditaments; (b) the rent must be in arrear; (c) there must be a reversion in the person distraining; and (d) there must be goods on the premises liable to be distrained.

¹ When peppercorn rents were instituted, in the middle ages, they were not, however, nominal, the cost of spices being then very great. A peppercorn rent, generally an obligation to pay 1 lb of pepper at the usual rent days, constituted a substantial impost even as late as the 18th century.

Laws
as to
payment.

All personal chattels are distrainable with the following exceptions: (i) Goods absolutely privileged—(a) fixtures (*q.v.*); (b) goods sent to the tenant in the way of trade; (c) things which cannot be restored, e.g. meat and milk; growing corn and corn in sheaves formerly fell within this category, but the Distress for Rent Act 1737 (s. 8) abolished this exemption in the case of the farmer, and a statute of 1690 abolished it in that of the latter; (d) things in actual use, e.g. a horse while it is drawing a cart; (e) animals *feræ naturæ* (wolves and tame deer or deer in an enclosure park may be distrained); (f) things in the custody of the law, e.g. in the possession of a sheriff under an execution (*q.v.*); (g) straying cattle; (h) in the case of agricultural holdings under the Agricultural Holdings Acts 1883-1900 hired agricultural machinery and breeding stock; (i) the wearing apparel and "bedding"—a term which includes "bedstead"—of tenant and his family, and the tools and implements of his trade to the value of £5 (Law of Distress Amendment Act 1888); (j) the goods of ambassadors and their suites (Diplomatic Privileges Act 1708). (ii) Goods conditionally privileged, i.e. privileged if there are sufficient goods of other kinds on the premises to satisfy the distress—(a) implements of trade not in actual use; (b) beasts of the plough and sheep; (c) agisted cattle; (d) growing crops sold under an execution (Landlord and Tenant Act 1851, s. 2); (e) lodgers' goods. The Lodgers' Goods Protection Act 1871 provides that where a lodger's goods have been seized by the superior landlord the lodger may serve him with a notice stating that the intermediate landlord had no interest in the property seized, but that it is the property, or in the lawful possession, of the lodger, and setting forth the amount of the rent due by the lodger to his immediate landlord. On payment or tender of such rent the landlord cannot proceed with the distress against the goods in question.

In general, a landlord cannot distrain except upon the premises demised, but he has a statutory right to follow things clandestinely or fraudulently removed from the premises within 30 days after their removal, unless they have been in the meantime sold *bona fide* and for valuable consideration. A landlord may, by statute (Landlord and Tenant Act 1709, s. 6), distrain within six months after the determination of the lease provided that the tenant has remained in possession. A distress must be made in the daytime, i.e. not before sunrise or after sunset. Six years' arrears of rent only are recoverable by distress (Real Property Limitation Act 1833, s. 12); the Real Property Limitation Act 1874, which abolished distress for rent after twelve years, applies to rent-charges and not to rent under a lease, and the six years' arrears may be recovered in spite of the lapse of time. In the case of agricultural tenancies falling within the Agricultural Holdings Acts 1883-1900, the right of distress is confined to one year's arrears of rent. Where the tenant is bankrupt, a distress levied after the bankruptcy is limited to six months' rent accrued due prior to the date of adjudication; see Bankruptcy Act 1883 (s. 42) and 1890 (s. 28). Where a company is being wound up, the landlord may not distrain without the leave of the court. An extension of time is allowed in cases where, in the ordinary course of dealing between landlord and tenant the payment of rent has been allowed to be deferred for a quarter or half year after the rent became legally due (act of 1883, s. 4). The landlord may distrain in person or may employ a certificated bailiff (Law of Distress Amendment Act 1888, s. 7). An uncertificated person levying a distress is liable to a fine of £10, without prejudice to his civil liability (Law of Distress Amendment Act 1895, s. 2). The seizure must not be excessive (statute of Henry III, 1267); but enough must be taken to satisfy the claim, for the landlord cannot distrain twice for the same rent where he could have taken sufficient at the first instance. After being seized, the goods must be impounded (Distress for Rent Act 1707, s. 10; and see the statute of 1690, s. 3, on impounding of corn, straw, hay; the Distress for Rent Act 1737, s. 8, on impounding of growing crops; and the statute of 1554 and the Cruelty to Animals Act 1849, s. 5, on impounding of cattle); and the landlord has a statutory power of sale (statute of 1690, s. 5). It is illegal to proceed with a distress if the tenant tenders the rent before the impounding; and a tenant has, by statute (1690, c. 5), five clear days' grace, excluding the date of seizure, between impounding and sale. On the written request of the tenant, the impounding will be extended to fifteen days (Law of Distress Amendment Act 1888, s. 6). A tenant may, before sale, recover goods illegally distrained by an action of *replevin* (L. Lat. *replegiare*, to redeem a thing taken by another). Where no rent was due to the distrainer the tenant may recover by action double the value of the goods sold (statute 1690, s. 5); and summary remedies for the recovery of the property have been created by modern enactments (Law of Distress Amendment Act 1895, s. 4, on distress of privileged goods; Agricultural Holdings Act 1883, s. 46). Where rent was due, but the distress was irregular, the tenant can only recover special damage (Distress for Rent Act 1737, s. 10).

Goods taken under an execution (*q.v.*) are not removable till one year's rent has been paid to the landlord (Landlord and Tenant Act 1709).

The landlord has, besides distress, his ordinary remedy by action. In addition, special statutory remedies are given in the case of tenants

holding over after the expiration of their tenancy. By the Distress for Rent Act 1737 any tenant giving notice to quit, and holding over, is liable to pay double rent for such time as he continues in possession (see further under EJECTMENT).

Ireland.—The main differences between Irish and English law have been caused by legislation (see EJECTMENT; LANDLORD AND TENANT).

Scotland.—Rent is properly the payment made by tenant to landlord for the use of lands held under lease (see LANDLORD AND TENANT). In agricultural tenancies the legal terms for the payment of rent are at Whitsunday after the crop has been shown, and at Martinmas after it has been reaped. But a landlord and tenant may substitute conventional terms of payment, either anticipating (*fore*, or *forhand rent*) or postponing (*back*, or *backhand rent*) the legal term. The rent paid by vassal to superior is called *feu-duty* (see FEU). Its nearest English equivalent is the *fee farm rent*. The remedy of distress does not exist in Scots law. Rents are recovered (i) by summary diligence, proceeding on a clause, in the lease, of consent to registration for execution; (ii) by an ordinary petitory action; (iii) by an action of "maills and duties" (the rents of an estate in money or grain; "maills" was a coin at one time current in Scotland) in the Sheriff Court or the Court of Session; and (iv) in non-agricultural tenancies by procedure under the right of hypothec, where that still exists; the right of hypothec over land exceeding 2 acres in extent let for agriculture or pasture was abolished as from November 11, 1881 (see HYPOTHEC); (v) by action of removing (see EJECTMENT). Arrears of rent prescribe in five years from the time of the tenant's removal from the land.

Labour or service rents were at one time very frequent in Scotland. The events of 1715 and 1745 showed the vast influence over the tenantry that the great proprietors acquired by such means. Accordingly acts of 1716 and 1746 provided for the commutation of services into money rents. Such services may still be created by agreement, subject to the summary power of commutation by the sheriff given by the Conveyancing Act 1874 (§§ 20, 21). "In the more remote parts of Scotland it is understood that there still exist customary returns in produce of various kinds, which being regulated by the usage of the district or of the barony or estate cannot be comprehended under any general rule" (Hunter, *Landlord and Tenant*, ii. 298). Up to 1848 or 1850 there existed in Scotland "steelbow leases—analogue to the *chêtel de fer* of French law (see LANDLORD AND TENANT)—by which the landlord stocked the farm with corn, cattle, implements, &c., the tenant returning similar articles at the expiration of his tenancy and paying in addition to the ordinary rent a steelbow rent of 5% on the value of the stock.

As to the rent of apartments, &c., see LODGER AND LODGINGS.

United States.—The law is in general accordance with that of England. The tendency of modern state legislation is unfavourable to the continuance of distress as a remedy. In the New England states, attachment on mesne process has, to a large extent, superseded it. In New York and Missouri it has been abolished by statute; in Mississippi the landlord has a claim for one year's rent on goods seized under an execution and a lien on the growing crop. In Ohio, Tennessee and Alabama it is not recognized, but in Ohio the landlord has a share in the growing crops in preference to the execution creditor. The legislatures of nearly all the states agree with the law of England as to the exemption from distress of household goods, wearing apparel, &c. (see Dillon's *Laws and Jurisprudence of England and America*, pp. 360, 361; also HOMESTEAD). As to the rent of apartments, &c., see LODGER AND LODGINGS. Fee farm rents exist in some states, like Pennsylvania, which have not adopted the statute of *Quia Emptores* as a part of their common law (Washburn's *Real Property*, ii. 252).

Other Laws.—Under the French Code Civil (art. 2102) the landlord is a privileged creditor for his rent. If the lease is by authentic act, or under private signature for a fixed term, he has a right over the year's harvest and produce, the furniture of the house and everything employed to keep it up, and (if a farm) to work it, in order to satisfy all rent due up to the end of the term. If the lease is not by authentic act nor for a specified term, the landlord's claim is limited to the current year and the year next following (see law of 12th Feb. 1872). The goods of a sub-lessee are protected; and goods bailed or deposited with the tenant are in general not

liable to be seized. The French law is in force in Mauritius, and has been reproduced in substance in the Civil Codes of Quebec (arts. 2005 et seq.) and St Lucia (arts. 1888 et seq.). There are analogous provisions in the Spanish Civil Code (art. 1922). The subject of privileges and hypothecs is regulated in Belgium by a special law of the 16th Dec. 1851; and in Germany by ss. 1113 et seq. of the Civil Code. The law of British India as to rent (Transfer and Property Act 1882) and distress (cf., e.g., Act 15 of 1882) is similar to English law. The British dominions generally tend in the same direction. See, e.g., New South Wales (the consolidating Landlord and Tenant Act 1899); Newfoundland (Act 4 of 1899); Ontario (Act 1 of 1902, s. 22, giving a tenant five days for tender of rent and expenses after distress); Jamaica (Law 17 of 1900, certification of landlord's bailiffs); Queensland (Act 15 of 1904).

AUTHORITIES.—English Law: Woodfall, *Landlord and Tenant* (18th ed., London, 1907); Foa, *Landlord and Tenant* (4th ed., London, 1907); Fawcett, *Landlord and Tenant* (3rd ed., London, 1905); Gilbert on *Distress and Replevin* (London, 1823); Bullen, *Law of Distress* (2nd ed., London, 1896); Oldham and Foster, *Law of Distress* (2nd ed., London, 1889). Scots Law: Hunter on *Landlord and Tenant* (4th ed., Edin., 1876); Erskine's *Principles* (20th ed., by Rankine, Edin., 1903); Rankine's *Law of Landownership in Scotland* (3rd ed., Edin., 1891); Rankine's *Law of Leases in Scotland* (2nd ed., Edin., 1893). American Law: McAdam, *Law of Landlord and Tenant* (New York, 1900); Bouvier's *Law Dictionary* (ed. G. Rawle) (London and Boston, 1897), tit. "Distress" in "Ruling Cases"; *Landlord and Tenant* (American Notes) (London and Boston, 1894-1901). (A. W. R.)

RENTON, a manufacturing town of Dumbarshire, Scotland. Pop. (1901) 5067. It is situated on the Leven, 2 m. N.N.W. of Dumbarton by the North British and Caledonian railways. The leading industry is Turkey red dyeing, and calico-printing and bleaching are also carried on. A parish church stands on the site of Dalquhurn House, the birthplace of Tobias Smollett the novelist, to whose memory a Tuscan column was erected in 1774, the inscription for which was revised by Dr Johnson when he visited Bonhill in that year with Boswell. The town was founded in 1782 by Mrs Smollett—previously Mrs Telfer—of Bonhill (sister of Tobias Smollett), who resumed her maiden name when she succeeded to the Smollett estates; it was named after Cecilia Renton, daughter of John Renton of Blackadder, who had married Mrs Smollett's son, Alexander Telfer.

RENWICK, JAMES (1662-1688), Scottish covenanting leader, was born at Moniaive in Dumfriesshire on the 15th of February 1662, being the son of a weaver, Andrew Renwick. Educated at Edinburgh University, he joined the section of the Covenanters known as the Cameronians about 1681 and soon became prominent among them. Afterwards he studied theology at the university of Groningen and was ordained a minister in 1683. Returning to Scotland "full of zeal and breathing forth threats of organized assassination," says Mr Andrew Lang, he became one of the field-preachers and was declared a rebel by the privy council. He was largely responsible for the "apologetic declaration" of 1684 by which he and his followers disowned the authority of Charles II.; the privy council replied by ordering every one to abjure this declaration on pain of death. Unlike some of his associates, Renwick refused to join the rising under the earl of Argyll in 1685; in 1687, when the declarations of indulgence allowed some liberty of worship to the Presbyterians, he and his followers, often called Renwickites, continued to hold meetings in the fields, which were still illegal. A reward was offered for his capture, and early in 1688 he was seized in Edinburgh. Tried and found guilty of disowning the royal authority and other offences, he refused to apply for a pardon and was hanged on the 17th of February 1688. Renwick was the last of the covenanting martyrs.

See R. Wodrow, *History of the Sufferings of the Church of Scotland*, vol. iv. (Glasgow, 1838); and A. Smellie, *Men of the Covenant* (1904); also Renwick's life by Alexander Shields in the *Biographia Presbyteriana* (1827).

REP, REPP, or REPS, a cloth made of silk, wool or cotton. The name is said to have been adapted from the French *reps*, a word of unknown origin; it has also been suggested that it is a corruption of "rib." It is woven in fine cords or ribs across the width of the piece. In silk it is used for dresses, and to some extent for ecclesiastical vestments, &c. In wool and cotton it is used for various upholstery purposes.

REPAIRS (from Lat. *reparare*, to make ready again), acts necessary to restore things to a sound state after damage; the question of repairs is important in the relations between landlord and tenant. (See the articles **FLAT**; **LANDLORD AND TENANT**.)

REPEAL (O.F. *rapel*, modern *rappel*, from *rapeler*, *rappeler*, revoke, re and *appeler*, appeal), the abrogation, revocation or annulling of a law (see **ABROGATION** and **STATUTE**). The word is particularly used in English history of the movement led by Daniel O'Connell (q.v.) for the repeal of the act of Union between Great Britain and Ireland in 1830 and 1841-46, which in its later development became known as the Nationalist or Home Rule movement (see **IRELAND, History**).

REPIN, ILJA JEFIMOVICH (1844-), Russian painter, was born in 1844 at Tschuguev in the department of Charkov, the son of parents in straitened circumstances. He learned the rudiments of art under a painter of saints named Bunakov, for three years gaining his living at this humble craft. In 1863 he obtained a studentship at the Academy of Fine Arts of St Petersburg, where he remained for six years, winning the gold medal and a travelling scholarship which enabled him to visit France and Italy. He returned to Russia after a short absence, and devoted himself exclusively to subjects having strong national characteristics. In 1864 he became professor of historical painting at the St Petersburg Academy. Repin's paintings are powerfully drawn, with not a little imagination and with strong dramatic force and characterization. A brilliant colourist, and a portrait-painter of the first rank, he also became known as a sculptor and etcher of ability. His chief pictures are "Procession in the Government of Kiev," "Home-coming," "The Arrest," "Ivan the Terrible's murder of his Son," and, best known of all, "The Reply of the Cossacks to Sultan Mahmud IV." The portraits of the Baroness V. I. Ūlskŭl, of Anton Rubinstein and of Count Leo Tolstoy are among his best achievements in this class. The Tretyakov gallery at Moscow contains a very large collection of his work.

See "Professor Repin," by Prince Bojidar Karageorgevich, in the *Magazine of Art*, xxiii. p. 783 (1899); "Russian Art," a paper by E. Brayley Hodgkiss in the *Proceedings of the Anglo-Russian Literary Society* (5th of May 1896); "Ilja Jefimovitch Repin," by Julius Norden, in *Velhagen and Klasing's Monatshefte*, xx. p. 1 (1905); also R. Muther, *History of Modern Painting* (ed. 1907), iv. 272. (E. F. S.)

REPINGTON (or **REPYNGDON**), **PHILIP** (d. 1424), English bishop and cardinal, was educated at Oxford and became an Augustinian canon at Leicester before 1382. A man of some learning, he came to the front as a defender of the doctrines taught by John Wycliffe; for this he was suspended and afterwards excommunicated, but in a short time he was pardoned and restored by Archbishop William Courtenay, and he appears to have completely abandoned his unorthodox opinions. In 1394 he was made abbot of St Mary de Pré at Leicester, and after the accession of Henry IV. to the English throne in 1399 he became chaplain and confessor to this king, being described as "clericus specialissimus domini regis Henrici." In 1404 he was chosen bishop of Lincoln, and in 1408 Pope Gregory XII. made him a cardinal. He resigned his bishopric in 1419. Some of Repington's sermons are in manuscript at Oxford and at Cambridge.

REPLEVIN, an Anglo-French law term (derived from *replevin*, to replevy; see **PLEDGE** for further etymology) signifying the recovery by a person of goods unlawfully taken out of his possession by means of a special form of legal process; this falls into two divisions—(1) the "replevy," the steps which the owner takes to secure the physical possession of the goods, by giving security for prosecuting the action and for the return of the goods if the case goes against him, and (2) the "action of replevin" itself. The jurisdiction in the first case is in the County Court; in the second case the Supreme Court has also jurisdiction in certain circumstances. The proceedings are now regulated by the County Courts Act 1888. At common law, the ordinary action for the recovery of goods wrongfully taken would be one of detinue; but no means of immediate recovery

was possible till the action was tried, and until the Common Law Procedure Act 1854 the defendant might exercise an option of paying damages instead of restoring the actual goods. The earliest regulations with regard to the action of replevin are to be found in the Statute of Marlborough (Marlebridge), 1267, cap. 21. For the early history, see Blackstone's *Commentaries*, iii. 145 seq. Only goods and cattle can be the subjects of an action for replevin. Although the action can be brought for the wrongful taking of goods generally, as long as the initial taking was wrongful and it was from the possession of the owner, it is practically confined to goods taken by an illegal as opposed to an excessive distress (see DISTRESS and RENT, § Legal).

REPNIN, the name of an old Russian princely family, the first of whom to gain distinction was

PRINCE ANIKITA IVANOVICH REPNIN (1668-1726), Russian general, and one of the collaborators of Peter the Great, with whom he grew up. On the occasion of the Sophian insurrection of 1689, he carefully guarded Peter in the Troitsa monastery, and subsequently took part in the Azov expedition, during which he was raised to the grade of general. He took part in all the principal engagements of the Great Northern War. Defeated by Charles XII. at Holowczyn, he was degraded to the ranks, but was pardoned as a reward for his valour at Lyesna and recovered all his lost dignities. At Poltava he commanded the centre. From the Ukraine he was transferred to the Baltic Provinces and was made the first governor-general of Riga after its capture in 1710. In 1724 he succeeded the temporarily disgraced favourite, Menshikov, as war minister. Catherine I. created him a field-marshal.

See A. Bauman, *Russian Statesmen of the Olden Time* (Rus.), vol. i. (Petersburg, 1877).

His grandson, PRINCE NIKOLAI VASILEVICH REPNIN (1734-1801), Russian statesman and general, served under his father, Prince Vasily Anikitovich, during the Rhenish campaign of 1748 and subsequently resided for some time abroad, where he acquired "a thoroughly sound German education." He also participated in the Seven Years' War in a subordinate capacity. Peter III. sent him as ambassador in 1763 to Berlin. The same year Catherine transferred him to Warsaw as minister plenipotentiary, with especial instructions to form a Russian party in Poland from among the dissidents, who were to receive equal rights with the Catholics. Repnin convinced himself that the dissidents were too poor and insignificant to be of any real support to Russia, and that the whole agitation in their favour was factitious. At last, indeed, the dissidents themselves even petitioned the empress to leave them alone. It is clear from his correspondence that Repnin, a singularly proud and high-spirited man, much disliked the very dirty work he was called upon to do. Nevertheless he faithfully obeyed his instructions, and, by means more or less violent or discreditable, forced the diet of 1768 to concede everything. The immediate result was the Confederation of Bar, which practically destroyed the ambassador's handiwork. Repnin resigned his post for the more congenial occupation of fighting the Turks. At the head of an independent command in Moldavia and Walachia, he prevented a large Turkish army from crossing the Pruth (1770); distinguished himself at the actions of Larga and Kagula; and captured Izmail and Kilia. In 1771 he received the supreme command in Walachia and routed the Turks at Bucharest. A quarrel with the commander-in-chief, Rumyantsev, then induced him to send in his resignation, but in 1774 he participated in the capture of Silistria and in the negotiations which led to the peace of Kuchuk-Kainarji. In 1775-76 he was ambassador at the Porte. On the outbreak of the war of the Bavarian Succession he led 30,000 men to Breslau, and at the subsequent congress of Teschen, where he was Russian plenipotentiary, compelled Austria to make peace with Prussia. During the second Turkish war (1787-92) Repnin was, after Suvorov, the most successful of the Russian commanders. He defeated the Turks at Salcha, captured the whole camp of the *seraskier*, Hassan Pasha, shut him up in Izmail, and was preparing to reduce

the place when he was forbidden to do so by Potemkin (1789). On the retirement of Potemkin (*q.v.*) in 1791, Repnin succeeded him as commander-in-chief, and immediately routed the grand vizier at Machin, a victory which compelled the Turks to accept the truce of Galatz (31st of July 1791). In 1794 he was made governor-general of the newly acquired Lithuanian provinces. The emperor Paul raised him to the rank of field-marshal (1796), and, in 1798, sent him on a diplomatic mission to Berlin and Vienna in order to detach Prussia from France and unite both Austria and Prussia against the Jacobins. On his return unsuccessful, he was dismissed the service.

See A. Kraushar, *Prince Repnin in Poland, 1764-8* (Pol.) (Warsaw, 1900); "Correspondence with Frederick the Great and others" (Rus. and Fr.), in *Russky Arkhiv* (1865, 1869, 1874, Petersburg); M. Longinov, *True Anecdotes of Prince Repnin* (Rus.) (Petersburg, 1865). (R. N. B.)

REPORT (O.Fr. *reporti* or *raporti*, modern *rapport*, from O.Fr. *reporter*, mod. *rapporteur*, Lat. *reportare*, to bring back, in poetical use only, of bringing back an account, news, &c.), an account or statement of events, speeches, proceedings, the results of investigations, &c., "brought back" by one who was present either casually or sent for the specific purpose, hence reputation, rumour. A special sense, that of a loud noise, as of the explosion of firearms, appears as early as the end of the 16th century. For the reports of speeches, parliamentary debates, &c., in the daily press see **REPORTING** below, and for the particular form of law reporting see **ENGLISH LAW**; **AMERICAN LAW**.

REPORTING, the art or business of reproducing in readable form, mainly for newspapers, but also for such publications as the *Parliamentary* or *Law Reports*, the words of speeches, or describing in narrative form the events, in contemporary history, by means of the notes made by persons known generally as reporters. The special business of reporting is a comparatively modern one, since it must not be confounded with the general practice of quoting, or of mere narrative, which is as old as writing. There was no truly systematic reporting until the beginning of the 19th century, though there was parliamentary reporting of a kind almost from the time when parliaments began, just as law reporting (which goes back to 1292) began in the form of notes taken by lawyers of discussions in court. The first attempts at parliamentary reporting, in the sense of seeking to make known to the public what was done and said in parliament, began in a pamphlet published monthly in Queen Anne's time called *The Political State*. Its reports were mere indications of speeches. Later, the *Gentleman's Magazine* began to publish reports of parliamentary debates. Access to the Houses of Parliament was obtained by Edward Cave (*q.v.*), the publisher of this magazine, and some of his friends, and they took surreptitiously what notes they could. These were subsequently transcribed and brought into shape for publication by another hand. Dr Johnson for some years wrote the speeches, and he took care, as he admitted, not to let the "Whig dogs" get the best of it; the days of verbatim reporting were not yet come, and it was considered legitimate to make people say in print what substantially was supposed to represent their opinions. There was a strict parliamentary prohibition of all public reporting; but the *Gentleman's Magazine* appears to have continued its reports for some time without attracting the attention or rousing the jealousy of the House of Commons. The publisher, encouraged by immunity from prosecution by parliament, grew bolder, and began in his reports to give the names of the speakers. Then he was called to account. A standing order was passed in 1728, which declared "that it is an indignity to, and a breach of, the privilege of this House for any person to presume to give, in written or printed newspapers, any account or minute of the debates or other proceedings; that upon discovery of the authors, printers or publishers of any such newspaper this House will proceed against the offenders with the utmost severity." Under this and other standing orders, Cave's reports were challenged, with the result that they appeared without the proper names of the speakers, and under the guise of "Debates in the Senate of Lilliput,"

or some other like title. France was Blefuscu; London was Mildendo; pounds were sprugs; the duke of Newcastle was the Nardac secretary of state; Lord Hardwicke was the Hurgo Hickrad; and William Pulteney was Wingul Pulnub.

In the latter half of the century the newspapers began to report parliamentary debates more fully, with the result that, in 1771, several printers, including those of the *Morning Chronicle* and the *London Evening Post*, were ordered into custody for publishing debates of the House of Commons. A long and bitter struggle between the House and the public ensued. John Wilkes took part in it. The lord mayor of London and an alderman were sent to the Tower for refusing to recognize the Speaker's warrant for the arrest of certain printers of parliamentary reports. But the House of Commons was beaten. In 1772 the newspapers published the reports as usual; and their right to do so has never since been really questioned. Both Houses of Parliament, indeed, now show as much anxiety to have their debates fully reported as aforesaid they showed resentment at the intrusion of the reporter. Elaborate provision is made in the House of Lords and in the House of Commons for reporters. They have a Press Gallery in which they may take notes, writing rooms in which those notes may be extended, and a special dining-room. Reporting is nowhere carried to such an extent as in the United Kingdom, since in most other countries the newspapers do not find it sufficiently interesting "copy" for their readers to justify the amount of space required. Consequently the verbatim reports, though now no longer hindered by law, and made possible by shorthand (which was first employed in the service of parliament in 1802) and by all the arts of communication and reproduction, are considerably restricted.

But parliamentary work is only a small part of newspaper reporting. The newspapers in the beginning of the 19th century rarely contained more than the barest outline of any speech or public address delivered in or in the neighbourhood of the towns where they were published. After the peace of 1815 a period of much political fermentation set in, and the newspapers began to report the speeches of public men at greater length. It was not, however, until well into what may be called the railway era that any frequent effort was made by English newspapers to go out of their own district for the work of reporting. The London newspapers had before this led the way. Early in the 19th century, greater freedom of access to both Houses was given, and the manager of the *Morning Chronicle* established a staff of reporters. Each reporter took his "turn"—that is, he took notes of the proceedings for a certain time, and then gave place to a colleague. The reporter who was relieved at once extended his notes, and thus prompt publication of the debates was made possible. The practice grew until there was a good deal of competition among the papers as to which should first issue a report of any speech of note in the country. Reporters had frequently to ride long distances in post-chaises, doing their best as they jolted along the roads to transcribe their notes, so that they might be ready for the printer on arrival at their destination. Charles Dickens, whose efforts in the way of reporting were celebrated, used to tell several stories of his adventures of this kind while he held an engagement on the *Morning Chronicle*. One result was that the provincial newspapers were stimulated to greater efforts, and as daily newspapers sprang up in all directions, and the electric telegraph provided greater facilities for reporting, the old supremacy of the London journals in this department of newspaper work gradually disappeared. No public man made a speech but it was faithfully reproduced in print. Local governing bodies, charitable institutions, political associations, public companies—all these came in a short time to furnish work for the reporter, and had full attention paid to them. By the second half of the 19th century, parliamentary reporting was a leading feature of the London newspapers. They had a monopoly of it. All the reporting arrangements in the House of Lords and in the House of Commons were made with sole regard to their requirements. There had indeed been a long battle between *The*

Times and some of the other London newspapers as to which should have the best parliamentary report, and *The Times* had established its supremacy, which has never been shaken. The provincial newspapers were in the main obliged to copy the London reports, and rarely made any attempt to get reports of their own. When the electric telegraph came into use for commercial purposes a change began. The company which first carried wires from London to the principal towns in the country started a reporting service for the country newspapers. In addition, it procured admission to the parliamentary galleries for reporters in its employment, and began to send short accounts of the debates to the newspapers in the country. These newspapers were thus enabled to publish in the morning some account of the parliamentary proceedings of the previous night, instead of having to take like reports a day later from the London journals. The telegraph companies (not yet taken over by the state) for a long time could or would do no more than they had begun by doing; and they offered no inducements to the provincial newspapers to telegraph speeches. The public meanwhile wanted to know more fully what their representatives were saying in parliament, and gradually the leading provincial newspapers adopted the practice of employing reporters in the service of the London journals to report debates on subjects of special interest in localities; and these reports, forwarded by train or by post, were printed in full, but of course a day late. The London papers paid little attention to debates of local interest, and thus the provincial papers had parliamentary reporting which was not to be found elsewhere. Bit by bit this feature was developed. It was greatly accelerated by a movement which the *Scotsman* was the first to bring about. About 1865, a new company having come into existence, it was agreed that wires from London should be put at the disposal of such newspapers as desired them. Each newspaper was to have the use of a wire—of course on payment of a large subscription—from six o'clock at night till three o'clock in the morning. This was the beginning of the "special wire" which now plays so important a part in the production of almost all newspapers. The arrangement was first made by the *Scotsman* and by other newspapers in Scotland. The special wires were used to their utmost capacity to convey reports of the speeches of leading statesmen and politicians; and, instead of bare summaries of what had been done, the newspapers contained pretty full reports.

When the telegraphs were taken over by the state in 1870 the facilities for reporting were increased in every direction. The London papers, with the exception of *The Times*, had given less and less attention to parliamentary debates, while on the other hand several of the provincial newspapers were giving more space than ever to the debates. These newspapers had to get their reports as best they could. The demand for such reporting had led, on the passing of the telegraphs into the hands of the state, to the formation of news agencies, which undertook to supply the provincial papers. These agencies were admitted to the reporters' galleries in the Houses of Parliament, but the reports which any agency supplied were identical; that is to say, all the newspapers taking a particular class of report had exactly the same material supplied to them—the reporter producing the number of copies required by means of manifold copying paper. Accordingly attempts were made to get separate reports by engaging the services of some of the reporters employed by the London papers. The "gallery" was shut to all save the London papers and the news agencies. The *Scotsman* sought in vain to break through this exclusiveness. The line, it was said, must be drawn somewhere, and the proper place to draw it was at the London Press. Once that line was departed from every newspaper in the kingdom must have admission. But in 1880 a select committee of the House of Commons was appointed to consider the question. It took evidence, and it reported in favour of the extension of the gallery and of the admission of provincial papers. The result was that three or four papers which would be satisfied with the same report joined in providing the necessary reporting

staff. In other cases individual newspapers put themselves on the same footing as the London newspapers by engaging separate staffs of reporters.

The effect of telegraphic improvements may be partially gauged by the fact that in 1871 the number of words handed in for transmission through the British Post Office for Press purposes (special rates being allowed) was 22,000,000, and that in 1900 it had risen to 835,000,000. Meanwhile the evolution of the modern newspaper had brought many other kinds of reporting, besides parliamentary, into play.

What is commonly called "descriptive reporting" has in some cases nearly supplanted the reporting of speeches out of newspapers. The special correspondent or the war correspondent is a "descriptive reporter." The "interviewer" came into great prominence during the "eighties" and "nineties," and the influence of American journalistic methods, which made smart reporting the most valuable commercial asset of the popular newspaper, and the reporter correspondingly important, spread to other countries. No daily newspaper now confines its reporting to the affairs of the part of the country in which it is published. The electric telegraph has made the work of the reporter more arduous and his responsibility greater. The variety of work open to reporting causes considerable difference, of course, in the professional status of the journalists who do such work. This subject generally is discussed in the article NEWSPAPERS, but one instance of the recognition of the modern reporter's responsibility is worth special mention. In the year 1900, in the English case of *Walter v. Lane* (see COPYRIGHT), it was decided, on the final appeal to the House of Lords, that the reporter of a speech, printed verbatim in a newspaper, was under the Copyright Act of 1842 to be considered the "author." Absurd as it might seem to call the reporter the author of another man's speech, the decision gave effect to the fact that it is his labour and skill which bring into existence the "copy" to which alone can right of property attach. Strictly speaking, he is the author of the report of the speech; but for literary purposes the report is the speech. It must, however, be borne in mind that there may be more than one verbatim report, and therefore more than one "author."

See ALSO NEWSPAPERS; SHORTHAND; PRESS LAWS; TELEGRAPH.

REPOUSSÉ (Fr. "driven back"), the art of raising designs upon metal by hammering from the back, while the "ground" is left relatively untouched (see METAL WORK and PLATE). The term is often loosely used, being applied indifferently to "embossing." Embossing is also called "*repoussé sur coquille*" and "estampage," but the latter consists of embossing by mechanical means and is therefore not to be considered as an art process. Moreover, it reverses the method of repoussé, the work being done from the front, and by driving down the ground leaving the design in relief. Gold, silver, bronze, brass, etc., being easily malleable metals, are specially suitable to repoussé, which at the present day, in its finer forms, is mainly employed for silver-plate and jewelry. The silver-plate in repoussé of Gilbert Marks (d. 1905) in England, and the portrait-plaques from life by Stephan Schwartz (b. in Hungary, 1851) in Austria, are noteworthy modern examples of the art.

Repoussé—a term of relatively recent adoption, employed to differentiate the process from embossing—has been known from remote antiquity. Nothing has ever excelled, and little has ever approached, the perfection of the bronzes of Siris (4th century B.C., in the British Museum), of which the armour-plate—especially the shoulder-pieces—presents heroic figure-groups beaten up from behind with punches from the flat plate until the heads and other portions are wholly detached—that is to say, in high relief from the ground of which they form a part. Yet the metal, almost as thin as paper, is practically of constant thickness, and nowhere is there any sign of puncture. The "Bernay treasure," in the Bibliothèque Nationale, Paris, discovered in 1830, belongs to the 2nd century B.C., and includes silver vases of Roman execution decorated with groups in mezzò-relief, beaten up in sections and soldered together. The best of these, of which perhaps the finest is that known from its subject as "La nymphe de la fontaine Pirène et Pégase," belong to the noblest period of Roman art. The Hildesheim treasure (discovered 1868) comprises a *patena* on the ground of which is a superb *emblemata* representing Minerva in high relief. These repoussé *emblemata* were usually of another metal and applied to the vase which they decorated; indeed repoussé was of leading importance in *caelatura*, or the metallic art (statuary

excepted) of classic times. Thus the *patena* of Hildesheim, the *patena* of Rennes, and the earlier shoulder-plate of the Siris bronze may be accepted as illustrative of the highest development of repoussé.

The art was not only Greek and Graeco-Roman in its early practice; it was pursued also by the Assyrians, the Phoenicians, and other oriental peoples, as well as in Cyprus and elsewhere, and was carried forward, almost without a break, although with much depreciation of style and execution, into medieval times. In the 11th century the emperor Henry II. presented as a thank-offering to the Basel cathedral the altar-piece, in the Byzantine style, decorated with fine repoussé panels of gold (representing Jesus Christ with two angels and two saints), which is now in the Cluny Museum in Paris. Up to this time, also, repoussé instead of casting in metal was practised for large work, and Linoges became a centre for the manufacture and exportation of sepulchral figures in repoussé bronze. These were affixed to wooden cores. By the time of Benvenuto Cellini the art was confined almost entirely to goldsmiths and silversmiths (who, except Cellini himself, rarely cast their work); and to them the sculptors and artists of to-day are still content to relegate it.

The elementary principle of the method, after the due preparation and annealing of the plate, was to trace on the back of it the design to be beaten up, and to place it face downwards upon a stiff yet not entirely unresisting ground (in the primitive stage of development this was wood), and then with hammers and punches to beat up the design into relief. According to Cellini, his master Carosso da Milano would beat up his plate on a metal casting obtained from a pattern he had previously modelled in wax; but he is not sufficiently explicit to enable us to judge whether this casting was hollow mould, which would result in true repoussé, or in the round, which is tantamount to *repoussé sur coquille*, or embossing.

Nowadays the plate is laid upon and affixed to a "pitch-block," a resinous ground docile to heat, usually composed of pitch mixed with pounded fire-brick, or, for coarser work such as brass, with white sand, with a little tallow and resin. This compound, while being sufficiently hard, is elastic, solid, adhesive and easy to apply and remove. Gold and silver are not only the densest and most workable but the most ductile metals, admitting of great expansion without cracking if properly annealed. The tools include hammers, punches (in numerous shapes for tracing, raising, grounding, chasing and texturing the surfaces), together with a special anvil called in French a *recingle* or *ressing*, in English "snarl." The *recingle*, or small anvil with projecting upturned point, was known in the 16th century. This point is introduced into the hollow of the vase or other vessel such as punch and hammer cannot freely enter, which it is desired to ornament with reliefs. A blow of a hammer on that part of the anvil where the prolongation first projects from it, produces, by the return spring, a corresponding blow at the point which the operator desires to apply within the vase. The same effect is produced by the modern "snarl" or "snarling iron"—a bar of steel, with an inch or two of the smaller end upturned and ending in a knob—held firmly in a tightly screwed-up vice, whereby the blow is similarly repeated or echoed by vibration. The repoussé work, when complete, is afterwards finished at the front and chased up. The same vase, to be worked up by embossing, would be filled with "cement" and laid on a sand-bag, and finally the whole would be heated and the cement run out. In the case of repoussé the vase itself may be beaten up out of the metal on the pitch-block. It must be understood that in order to obtain a result not merely excellent in technique but artistic and unmechanical in effect, the blows of the hammer must be made with feeling and "sentiment," otherwise the result cannot be a work of art.

See C. G. Leland, *Repoussé Work* (New York, 1885); and Gawthorp, *A Manual of Instruction in the Art of Repoussé* (London, 2nd ed., 1899). (M. H. S.)

REPRESENTATION, a term used in various senses in different connexions, but particularly in a political meaning, which has developed out of the others.

The word "represent" comes from Lat. *re-praesentare*, to "make present again," or "bring back into presence," and its history in English may be traced fairly well by the citations given in the *New English Dictionary* of its earliest uses in literature in senses which are still common. Thus we find the verb meaning (1380) simply to "bring into presence," and Barbour uses it (1375) in the sense of bringing clearly before the mind, whence the common sense of "explain," "exhibit," "portray." In 1513 it is used as synonymous with "describe," or "allege to be." In 1460 we find it employed for the performance of a play or a part in a play, whence comes the sense of symbolizing, standing in the place of some one, or corresponding to something; and in 1655 for acting as authorized agent or deputy of some one. This is a notable point in the development of the word. In Cromwell's speech to the parliament, January 22, 1655, he says: "I have been careful of your safety, and the safety of those you represented." This strictly political use of the verb developed, it will be seen, comparatively late.

The noun "representation" passed through similar stages. In 1425 we find it equivalent to "image," "likeness," "reproduction," "picture," from which is derived a meaning hardly distinguishable from "pretence." In 1533 it means a "statement" or "account," a sense which leads later (1679) to that of a formal and serious plea or remonstrance. In 1580 it occurs for a performance of a play. In 1647 it is used in psychology for the action of mental reproduction, a technical sense which applies especially to the "immediate object of imagination" (Sir W. Hamilton), and in Kantian language becomes the generic term for percepts, concepts and ideas. In 1624 it comes to mean "substitution of one thing or person for another," "substituted presence" as opposed to "actual presence," or "the fact of standing for, or in place of, some other thing or person," especially with a right or authority to act on their account. Its application to a political assembly then becomes natural, but for some time it is not so found in literature, the sense remaining rather formal. Good instances of this use are: Gataker, *Transubst.* 4: "The Rocke was Christ onely symbolically and sacramentally, by representation or resemblance"; and R. Coke, *Power and Subj.* iii.: "So cannot these members be formed into one body but by the king, either by his Royal Presence or representation." Thus "presence" and "representation" are used in distinctive meanings. In Scots law (1693) it obtains the technical meaning of the assumption by an heir of his predecessor's rights and obligations.

The term "representative," now specially applied to an elected member of a national or other assembly, deriving his authority from the constituency which returns him, appears to have been first used to denote not the member but the assembly itself. In the act abolishing the office of king, after Charles I.'s execution, 1649, section iv. runs: "And whereas by the abolition of the kingly office provided for in this Act, a most happy way is made for this nation (if God see it good) to return to its just and ancient right of being governed by its own Representatives or national meetings in council, from time to time chosen and entrusted for that purpose by the people, it is therefore resolved and declared by the Commons assembled in Parliament," &c., "and that they will carefully provide for the certain choosing, meeting and sitting of the next and future Representatives," &c. But the application of the term to the persons who sat in parliament was at all events very soon made, for in 1651 Isaac Penington the younger published a pamphlet entitled "The fundamental right, safety and liberty of the People; which is radically in themselves, derivatively in the Parliament, their substitutes or representatives."

It is worth while to dwell on the historical evolution of the various meanings of "represent," "representation" and "representative," because it is at least curious that it was not till the 17th century that the modern political or parliamentary sense became attached to them; and it is well to remember that though the idea of political representation is older and thus afterwards is expressed by the later meaning of the word, the

actual use of "representation" in such a sense is as modern as that. In Burke's speeches of 1769¹ and 1774-1775, relating to taxation, we find the word in this sense already in common use, but the familiar modern doctrine of "no taxation without representation," however far back the idea may be traced, is not to be found in Burke in those very words. The "originator of that immortal dogma of our (*i.e.* American) national greatness" was, according to the American writer M. C. Tyler (*Amer. Lit.* i. 154), the politician and philanthropist Daniel Gookin (1612-1687), an Irish settler in Virginia, who, moving to Boston and becoming speaker of the Massachusetts legislature, became prominent in standing up for popular rights in the agitation which resulted in the withdrawal of the colonial charter (1686). But it was the vogue of the "dogma" in America, not its phrase, that he seems to have originated; and while the precise form of the phrase does not appear to be attributable to any single author, the principle itself was asserted in England long before the word "representation," in a political sense, was current. In English constitutional history the principle was substantially established in 1297 by the declaration *De Tallagio non concedendo*,² confirmed by the Petition of Right in 1628.

The growth of the parliamentary system in England is traced in the article PARLIAMENT, but the account there given may be supplemented here by a more precise reference to the evolution of the idea of political "representation" as such, and of its embodiment in the word now employed to express it. The simple idea of the *substitution* of one person for another, in some connexion, *e.g.* hostage, pledge, victim, is so old as to be only describable as primitive; it is found in the proxy system, *e.g.* in marriage, and in diplomacy, the legate or ambassador being the *alter ego* of his sovereign; but, so far as general political legislative action, by one man in an assembly on behalf of others, is concerned, no systematic employment of a "deputy" (the word still used both in a general sense and in politics as a synonym for "representative") is known among the ancients. So long as political power rests in a small privileged class, such an idea must be slow to develop; and the primitive notion of a law-making body is that of all the members present in person, as in ancient Greece. But, as Stubbs (*Const. Hist.* i. 586) points out, the early English jury system (see *JURY*) shows the germ of the true idea of representation in England; it was the established practice of electing or selecting juries to present criminal matters before the king's judges, and assessors to levy taxes on the county, that suggested the introduction of popular representation in the English political system, and thus brought "the commons" into play in addition to the Crown and the nobles. Under Henry III., in 1254, we have the writ (see PARLIAMENT) requiring the sheriff of each county to "cause to come" before the King's Council two good and discreet Knights of the Shire, whom the men of the county shall have chosen for this purpose in the stead of all and of each of them, to consider along with knights of other shires what aid they will grant the king." But the definite establishment of the principle of political representation, in a shape from which the later English system of representation lineally descended, may be traced rather to the year 1295, in Edward I.'s famous writ of summons to parliament, of which the following is the important part. In the volume of *Select Documents of English Constitutional History* (1901), selected by G. B. Adams and H. M. Stephens, whose version from the Latin we quote, the section is headed (ante-dating the use of the vital word), "Summons of representatives of the counties and boroughs"—

"The king to the sheriff of Northamptonshire. Since we intend to have a consultation and meeting with the earls, barons and other principal men of our kingdom with regard to providing remedies

¹ The *New English Dictionary*, for its first citation of "representation" in an assembly, quotes Burke, *Late St Nat.*, Works, ii. 138, *l.c.* in 1769.

² "No tallage or aid shall be laid or levied by us or our heirs in our realm, without the goodwill and assent of the archbishops, bishops, earls, barons, knights, burgesses and other freemen of our realm."

³ "Venire facias," not "elegi facias."

against the dangers which are in these days threatening the same kingdom: and on that account have commanded them to be with us on the Lord's Day next after the feast of St Martin in the approaching winter, at Westminster, to consider, ordain and do as may be necessary for the avoidance of these dangers: we strictly require you to cause two knights from the aforesaid county, two citizens from each city in the same county and two burgesses from each borough, of those who are especially discreet and capable of labouring, to be elected without delay, and to cause them to come to us at the aforesaid time and place. Moreover, the said knights are to have full and sufficient power for themselves and for the community of the aforesaid county, and the said citizens and burgesses for themselves and the communities of the aforesaid cities and boroughs separately, then and there, for doing what shall then be ordained according to the Common Council in the premises, so that the aforesaid business shall not remain unfinished in any way for defect of this power. And you shall have the names of the knights, citizens and burgesses, and this writ."

The words "Elegi facias," instead of "venire facias" (which were retained in 1275; see PARLIAMENT), still appear to make the parliament of 1295 the model, rather than that of 1275, though in other respects the latter appears now to have established the summoning of county and borough representatives.

In this summoning by the king of the two knights and two burgesses with full and sufficient power for themselves and for the community, we find therefore the origin of political representation of the commons, as opposed to the actual presence and personal attendance of the peers.

The older English national assemblies had consisted of the privileged class fully summoned as individuals.

The change involved has been well explained by E. A. Freeman (*Ency. Brit.*, 9th ed., viii. 297), when he says: "The national assemblies changed their character . . . by no cause so much as by the growth of the practice of summons. . . . In the great assembly at Salisbury (1086), where all the land-owners of England became the men of the king (William the Conqueror), we see the first germs of Lords and Commons. The Witan are distinguished from the 'land-sitting men.' By the Witan, so called long after the Conquest, we are doubtless to understand those great men of the realm who were usually summoned to every assembly. The vast multitude who came to do their homage to the king were summoned only for that particular occasion. The personal right of summons is the essence of the peerage. . . . The earls and bishops of England, by never losing their right to the personal summons, have kept that right to personal attendance in the national assembly which was once common to all freemen, but which other freemen have lost. The House of Lords represents¹ by unbroken succession the Witan of the assembly of Salisbury; that is, it represents by unbroken succession the old assemblies of the Teutonic democracy. . . . The 'land-sitting men,' on the other hand, not summoned personally or regularly, but summoned in a mass when their attendance was specially needed, gradually lost the right of personal attendance, till in the end they gained the more practical right of appearing by their representatives."

From the same authority the account of the intermediate stages in the adoption of the representative principle may be further quoted:—

"By the time of Henry II. the force of circumstances, especially the working of the practice of summons, had gradually changed the ancient assembly of the whole nation into a mere gathering of the great men of the realm. . . . It is in the reign of Richard I. that we begin to see the first faint glimmerings of parliamentary representation. . . . The object of his wise ministers, of Archbishop Hubert among the first, was to gain the greatest amount of money for their master with the least amount of oppression towards the nation. Under Hubert's administration, chosen bodies of knights or other lawful men, acting in characters which became more and more distinctly representative, were summoned for every kind of purpose. How far they were nominated, how far freely elected, is not always clear. It seems most likely that in one stage they were nominated by the sheriff in the county court, while at a later stage they were chosen by the county court itself. In other words, the principle of representation was first established, and then the next stage naturally

was that the representatives should be freely chosen. Summoned bodies of knights appear in characters which are the forerunners of grand jurors and of justices of the peace. They appear also in a character which makes them distinctly forerunners of the knights of the shire which were soon to come. A chosen body of knights have to assess the imposts on each shire. From assessing the taxes the next stage was to vote or to refuse them. In 1213 the sheriffs are called on to summon four discreet men from each shire, to come and speak with the king about the affairs of the realm. When we have reached this stage, we have come very near to a *parliament*, name and thing. The reign of John, in short, is marked by common consent as the time from which Englishmen date the birth of their national freedom in its later form. . . . The (Great) Charter (1215) is the first solemn act of the united English nation after Norman conquerors and Norman settlers had become naturalized Englishmen. . . . Representation was already fast growing up; but it had hardly yet reached such a stage that it could be ordained in legal form. But rules are laid down out of which, even if it had not begun already, representation in the strictest sense could not fail, shortly to arise. The distinction which had been growing up ever since the Conquest, and indeed before, between the *Witan* and the *land-sitting men*, now receives a legal sanction. The practice of summons makes the distinction. Certain great men, prelates, earls and greater barons, are to receive the personal summons. The rest of the king's tenants-in-chief are to be summoned only in a body. Here we have almost come to a separation of Lords and Commons. But in modern ideas those names imply two distinct houses; and it was not yet settled, it had not yet come into men's minds to consider, whether the national council should consist of one house or a dozen. But it is decided in so many words that the acts of those who came would bind those who stayed away. The king's provision, representation, and not only representation but election of the commons, follows almost as a matter of course. The mass stay away; a few appear, specially commissioned to act in the name of the rest. The Charter mentions only the king's tenants-in-chief; so far had things been marred or feudalized by the influence of the Conquest. But as the election could only be made in the ancient county court, every freeholder at least, if not every freeman, won back his ancient right. If he could not come himself to say Yea or Nay, he at least had a voice in choosing those who could do so with greater effect."

(*Ibid.*, pp. 307, 308.)

"The constitution of the (national) assembly, by the Great Charter, did not absolutely imply representation; but it showed that the full establishment of representation could not be long delayed. The work of the period 1217-1340 was to call up, alongside of the gathering of prelates, earls and other great men specially summoned, into which the ancient Witanagenot had shrunk up, another assembly directly representing all other classes of the nation which enjoyed political rights. This assembly, chosen by various local bodies, *communitates* or *universitates*, having a quasi corporate being, came gradually to bear the name of the commons. The knights of the shire, the barons, citizens and burgesses of the towns, were severally chosen by the *communitates* or *universitates* of that part of the people which they represented."

"The notion of local representation, by which shires and boroughs chose representatives of their own communities, had to some extent to strive with another doctrine, that of the representation of *estates* or classes of men. The 13th century was the age when the national assemblies, not only of England but of most other European countries, were putting on their definite shape. And in most of them the system of *estates* prevailed. These in most countries were three—clergy, nobles and commons. By these last were commonly meant only the communities of the chartered towns, while the *noblesse* of foreign countries answered to the lesser barons and knights, who in England were reckoned among the commons. The English system thus went far to take in the whole free population, while the estates of other countries, the commons no less than the clergy and nobles, must be looked on as privileged bodies. In England we had in truth no estates: we had no nobility in the foreign sense. . . . Yet the continental theory of estates so far worked in the development of our parliamentary system that the 'The Estates of England' became a familiar phrase. It was meant to denote the Lords, and the clergy, in their parliamentary character. For it is plain that it was the intention of Edward I. to organize the clergy as a parliamentary estate, alongside of the lords and commons. This scheme failed, mainly through the unwillingness of the clergy themselves to attend in a secular assembly. This left, so far as there were any estates at all, two estates only,—lords and commons. This led to the common

¹ Professor Masterman, lecturing (1908) on the House of Commons, has pointed out how fortunate it was that this beginning of the organization of the commons into a central body did not come earlier than it did. Had there been one assembly representing the local *communitates* at any earlier time it would have been far too sectional in character and far too little conscious of any common interest. The organization did not begin till England had become a self-conscious body, realizing its common interests and the common destiny that belonged to it as a nation.

¹ The inevitable use of the word "represent" in its wider sense ("corresponds to"), is worth noting in this passage from Freeman, side by side with the more technical one in "representative" ("chosen delegate").

mistake of fancying the three estates to be king, lords and commons. The ecclesiastical members of the House of Lords kept their seats there; but the parliamentary representation of the clergy as an estate came to nothing. So far as the clergy kept any parliamentary powers, they exercised them in the two provincial convocations. These anomalous assemblies, fluctuating between the character of an ecclesiastical synod and of a parliamentary estate, kept, from Edward I. to Charles II., the parliamentary power of self-taxation. For a long time lords and commons taxed themselves separately. So did the clergy; so sometimes did other bodies.

"During the reign of Henry III. assemblies were constantly held, and their constitution is often vaguely described. But in a great many cases phrases are used which, however vague, imply a popular element. We read of knights, of tenants in chief, of freemen, sometimes even of freemen and villeins, sometimes, more vaguely still, of 'universi,' 'universitas Angliæ,' and the like. In some cases we are able better to interpret these vague phrases. For instance, in 1224 each shire sends four knights chosen by the 'milites et probi homines.' Whether these knights were or were not to vote along with the magnates, they were at all events to transact business with them. We must always remember that in these times formal voting in the modern sense is not to be looked for."¹

(Ibid. pp. 314, 315.)

This summary shows clearly how the idea of "representation" as opposed to "presence in person" was applied to the English parliament, so as to give the commons a proper voice in it as well as the lords. It is unnecessary here to trace further the gradual increase in power of the House of Commons till it became the predominant partner in the English bicameral constitution (see PARLIAMENT). But from the point of view of historical theory it is important to note that its representative character does not essentially depend upon the particular method (election *by vote*) by which its members have for so long been chosen. It is a common error to regard the House of Commons as having a national authority higher than that of the House of Lords merely on the ground that it is composed of elected members, and to stigmatize the House of Lords as "unrepresentative" because it is not elected. But in strictness the question of election, as such, has nothing to do with the matter.² The proper distinction (ignoring for the moment the later inclusion in the House of Lords of a certain representative element—strictly so regarded—in the Scotch and Irish peers) is that the House of Lords, as still constituted in 1910, remained a *presentative* chamber, while the House of Commons was essentially a *representative* one; in the former the members, summoned personally as individuals, were entitled to speak in the great council of the nation, while in the latter the members were returned as the mouthpieces of whole *communitates*, to whom, in the person of the sheriffs, the summons had been directed to send persons to speak for them.³ The preponderant authority of the House of Commons is due not to its members being elected—that is only one way of settling who the mouthpieces of the commons shall be—but to the progress of

popular government. The two British houses have historically existed as assemblies of the separate estates of the realm—the House of Lords of the two estates of lords spiritual and temporal, and the House of Commons of the commons. The third estate has so increased in power as to become predominant in the country; but the authority of its own assembly simply depends on the powers of those it represents. If the balance of political power had not been shifted in the country itself, the authority and competence of the peers, speaking for themselves in a primary assembly, would in theory actually appear higher, so far as their order is concerned, than that of members of the House of Commons, who can only "represent" the popular constituencies. Moreover, the fact that most members of the House of Commons are elected by a party vote is apt to make them very often even less authoritative spokesmen of their constituencies—the *communitates*—than if they were selected by some method which would indicate that they had the full confidence of the whole body they "represent." It is notorious that many members of a modern House of Commons, or of any other "representative" assembly, have only been elected by the votes of a minority of their constituency, or (where there have been more than two candidates) a minority even of those who voted; and there always comes a time when it is certain that if a representative has to come again before the electorate for their votes he will be defeated; he, in fact, no longer reflects their views, while he still sits and legislates. The real desires of the commons in a certain British constituency may even be more faithfully, even if only accidentally, reflected by a local peer whose only right to speak in parliament is technically presentative. In his *Vindication of the British Constitution* (1835), Disraeli, writing of the Reform Bill of 1832, observed that "in the effort to get rid of representation without election, it will be well if eventually we do not discover that we have only obtained election without representation." A truer word was never spoken. A man may be representative, practically *consensus omnium*, although no vote, resulting from a division of opinion, has been taken for the purpose of selecting him. The vote is merely a method of selection when there is a definite division of opinion involving an uncertainty; and even in the modern House of Commons many members are returned "unopposed," no actual voting taking place. A well-recognized representative character (as regards the functions involved) attaches, for instance, in British public life to other persons in whose selection the method of popular voting has had no place; such as the king himself, the Cabinet (in relation to the political party in power), or the bishops (as regards the Church of England).

The question of remodelling the constitution of the British House of Lords was prominently before the country in 1910; and a large number even of those who were prepared to defend its actions in the past were ready to accept changes which would make it in form and composition a Second Chamber representative of the nation rather than presentative of its historic order. But it is important to remember, in connexion with the House of Lords question, that, in a country like England, where the constitution has provided for a Second Chamber which is composed of members of an estate or estates distinct in the nation from the estate of the commons, these persons may to a predominant degree nevertheless be really representative men by common consent; while their being so, though not theoretically the reason for their legislative power, is substantially the reason why it has so long persisted. In the absence of a written constitution, theoretical considerations have in England always been second to the force of circumstances. Most people regarded the House of Lords, as still unreformed in 1910, as purely a *hereditary* body; its members had been summoned to parliament as peers (the important question of their right to a summons need not here be discussed), and most peers enjoyed their titles by hereditary succession. But the constant creation of peers by both political parties had in fact introduced even into the constitution of the House of Lords

The British Houses of Parliament.

¹ "Election" in these early times has its simple meaning of "choice." "We must guard ourselves from supposing that the citizens and burghers, who were summoned to Parliament, were absolutely elected by the inhabitants of the towns as their representatives. Their presence in Parliament is another instance of representation without election. They were often nominated by the sheriff of the county, and even when that great officer, from negligence or favour, permitted the return to be made by those interested in the transaction, the nomination was confined to the small governing body, who returned two of their members, in general very unwilling missionaries, to the great council" (Disraeli, *Vindication of the British Constitution*, 1835).

² In the American federal system the bicameral legislature is divided into a "House of Representatives," composed of members elected by popular vote in each state, and a "Senate," composed of members elected by the legislature in each state. In spite of the nomenclature, both houses are really composed of "representatives." But under a republican system there is no room for a purely presentative assembly, and the term "representative" comes to imply a more direct choice by the "commons."

³ There was at one time, it may be noted, a sort of "representative" element even in the case of the House of Lords, in so far as peers (including peeresses in their own right, abbesses, &c.) could send deputies or proxies. But we must be reminded that the privilege flowed directly from the personal and presentative character of the summons to a peer, who as such could name a deputy. It is quite illegitimate to strain from it an analogy with the election of a representative by the commons, who had no personal right to a summons.

an essentially representative element (though not resulting from direct election), apart altogether from the fact that heredity maintained there a number of persons whose title had descended from men who were originally representative Englishmen, and whose successors, on the whole, were no less so. In the days when kings really governed in England, the most powerful check on the king, in the interest of the nation at large, was the peerage; the earls and barons, in parliament, were the chief bulwark of the people against tyranny. It was they who stood for the nation in extorting Magna Carta from King John; and as time went on, the representation of the commons in parliament was largely due, not to any direct popular pressure, but to the desire of the kings to influence the lower ranks of society independently of the nobles. Up to the reign of Charles I., at all events, the House of Lords was actually the predominant partner in parliament; the House of Commons was recruited from and returned by only a small section of the commons as now understood; and Oliver Cromwell—certainly a "popular" leader in the ordinary sense—made as short work of it as he did of the king himself. Up to 1832, when the first modern Reform Act was passed, the House of Commons was an oligarchical body, and the electors themselves were a small and privileged class. It is only since then—except in the granting of supplies—that first equality, and then predominance, in respect of the House of Lords, has been asserted by the House of Commons, owing to the fact that an extended suffrage has made the estate of the commons more adequately coincident with the nation as a whole. Prior to 1832 it was the king who directly made and unmade ministries; in 1835 for the first time the result of a general election caused a change of ministry; and the modern view of the House of Lords as purely a revising chamber dates only from then. But the very fact that the responsibility for creating new peerages now passed to ministers dependent on popular suffrage may well justify the contention that henceforth it indirectly included a select number of representative men of the nation, holding their seats in virtue of authoritative nomination and not by heredity. In the sixty years preceding 1906 no fewer than 419 new peerages were created, 238 by the Liberal party, 181 by the Conservative, or a balance of 57 creations on the Liberal side.¹ It is fair to assume that all these new peers were created as being representative men in the nation for one reason or another. And an analysis of the composition of the House of Lords in 1906 would have led an unprejudiced outside observer to suppose that its competence to speak on national affairs had not been weakened by any dependence on the hereditary title. It included 166 men who had been M.P.'s (*i.e.* had been elected by popular vote to the House of Commons), 172 who had held government office, 140 who had been mayors of county councils, 207 who had served in the army or navy, 40 who had been judges or lawyers, 7 ex-viceroy, 16 ex-governors of colonies, 50 who had been eminent in art, letters, manufactures or trade, and 21 archbishops or bishops (appointed by ministerial recommendation, but only after they had worked up to eminence from being curates, and therefore had wide experience of the social life of the people).

It is possible to compare a chamber so composed somewhat favourably with a modern House of Commons, if the point at issue—the provision of "representative men" (*i.e.* men generally accepted as national spokesmen)—be strictly considered, apart from the method of selecting them by direct popular vote.² In the House of Lords the method is heredity plus selection by the political party which the popular vote has put in power; while in the election of members of the House

of Commons the popular choice is doubly limited—first, by the fact that only the enfranchised commons can vote (in 1910 about 7½ millions out of 43); and secondly, because the choice must be made from among candidates who are themselves not disqualified for various reasons (for instance they must not be clergymen, nor entitled to seats in the House of Lords). Now, to carry out the real "will of the nation" in parliament must require (1) a reasonable knowledge of the wishes of the nation, and (2) an understanding of the best ways of expressing those wishes in legislation and administration. In the case of the peers, those who sit as having been originally created and therefore selected for the purpose—a considerable section of those actively attending—the qualifications are obvious; and it is only necessary to deal with those qualified by inheritance of title. Here too, in a number of cases, preceding experience in the House of Commons, to which the popular vote has returned them while they were only in the succession to a peerage, is a frequent factor; but, apart from that, the art of legislation is one which may well be considered to require a certain special disposition and mental equipment. Though allowance must be made for exceptional cases, it is obvious that the son of a man who has been responsible for legislating, who has himself been brought up as one who will have to take his part in legislating, is most likely, in any society, to have qualified himself for the business, as in the case of any profession or trade. He has been accustomed to breathe the parliamentary atmosphere, and as one of a leisured class has had the opportunity to study the subject of legislation, and to obtain experience of its conditions. This is so generally accepted that, in fact, the same theory is commonly applied to candidates for the House of Commons, and predominantly to members of that House who are given office. The names of more than one generation are writ large in English history in the case of the Pitts, Foxes, Grenvilles, Cannings, Cecilis, Stanleys and Cavendishes. The sons of famous political commoners, a Gladstone, a Harcourt, a Churchill, a Primrose, a Chamberlain, have by consent a superior claim, even within the radical or popular party, by no means resting originally or primarily on known personal merit or proved experience, for selection as candidates and then for preferment to office; and it is a very common occurrence for younger sons of peers to be selected as candidates (liberal as much as conservative) for parliament, even though from general intellectual considerations they may appear in no way the equals of other men. They have been brought up to the business; and they are therefore adapted for it by heredity. If the House of Commons were deprived of those members who obtained their seats or their offices primarily for reasons of heredity, it would lose many of its best men—as indeed it occasionally does, to its disadvantage and possibly to the chagrin of the individuals themselves, when succession to a peerage forces a prominent parliamentarian to relinquish his seat in the Lower House and to take his place in the "unrepresentative" chamber.

It remains nevertheless the fact that, in politics, "representative" government means not so much government by men really representative of the nation as government in the name of the whole body of citizens (and predominantly the estate of the commons) through a chamber or chambers composed of elected deputies. The object in view is the expression of the "will of the people"—the people, that is, who are sovereign. Clearly the only pure case of such government can be in a republic, where there is only one "estate," the free citizens. The home and historical type of representative government, the United Kingdom, is strictly no such case, since the monarchy and the House of Lords exist and work on lines constitutionally independent of any direct contact with the electorate. British practice, however, is of vital importance for the theory of representative institutions, and it is worth while to point out that the "will of the people" may even so be effectively expressed—some people may think even more effectively expressed than in a pure republic. The king and the House of Lords, *quod*

Expression of the "Will of the People."

¹ Between January 1906 and January 1910 thirty-five more new peers were created by Liberal premiers, and seven more in June 1910.

² Speaking at Oldham on December 15, 1909, Lord Curzon said: "I have taken out the figures of the past 200 years, and I tell you this, that during that time 41 of our prime ministers have sat in the Lords and only 17 in the Commons; of our foreign secretaries, 56 in the Lords and only 8 in the Commons; of our colonial secretaries, 46 in the Lords and 25 in the Commons; of our war ministers, 29 in the Lords and 31 in the Commons; of first lords of the Admiralty, 48 in the Lords and 28 in the Commons."

estates of the realm, are just as much part of "the people," in the widest sense, as "the commons" are; they are an integral part of the nation. In a republic they would as individuals be equal citizens, able to become candidates for the representative chamber or chambers; but as it is, since they are expressly debarred from taking part in elections to the House of Commons, they remain entitled and expected to use their historic method of playing a part in the government of the state. They assist to constitute "the people" in the wider sense, and in the narrower sense "the people" (*i.e.* the commons) know it and rely on it. Under the British constitution the commons have habitually relied on the monarchy and the House of Lords to play their part in the state, and on many occasions it has been proved, by various methods by which it is open to the commons themselves to show their real feeling, that action on the part of the monarch (*e.g.* in foreign affairs) or the House of Lords (in rejecting or modifying bills sent up by the House of Commons), in which a popular vote has played no initiating or controlling part, is welcomed and ratified, by consent of a large majority, on the part of the nation at large. So much is this so that it is notorious, in the case of the House of Lords, that elected members of the House of Commons, tied by purely party allegiance and pledges, have constantly voted for a measure they did not want to see passed, relying on the House of Lords to throw it out. Ultimately, no doubt, the reconciliation of this "presentative" element in the British form of constitution with the growth of democracy and the predominance of the "representative" system depends purely on the waiving of historical theory both by king and peers, and its adaptation to the fact of popular government through the recognition that their action rests for its efficient authority upon conformity with the "will of the people." Thus it has become an established maxim in England that while it is the proper function of the House of Lords to reject a measure which in their opinion is not in accordance with the wishes of the nation, they could not repeat such a rejection after a general election had shown that its authors in the House of Commons were supported by the country. The experience of politics from 1832 to 1910 gave abundant justification to the House of Lords for supposing that in such cases they were interpreting the desire of the country better than the House of Commons; the case of the Irish Home Rule bill of 1893 is, of course, the classical example.¹ So that in practice the House of Lords only acts in opposition to the House of Commons, subject to the remedy of a dissolution of parliament (which depends strictly on the prerogative of the Crown, but in practice on the advice of the leader of the majority in the House of Commons), at which the view of the House of Commons might be confirmed and reasserted, and in that case would prevail. The violent attacks made on the House of Lords by the Liberal party, on occasions when that party has had a majority in the commons and has had its measures rejected or distastefully amended, have always been open to the criticism that if the majority in the House of Commons were really supported by the electorate in the country they had the remedy in their own hands. If it were shown by the result of a general election that their defeated measure were the "will of the people," the House of Lords, as was generally understood, must give way. Such a position, though naturally objectionable to a party in power in the House of Commons (because general elections are uncertain things in every respect but that of trouble and expense), could clearly be strong only in view of the confidence of the House of Lords in its action being more truly representative of public opinion. It therefore must be said to have acted, however clumsily and indirectly—and no direct way would be feasible except that of the Referendum—as a "representative" body, *i.e.* as carrying out what it judged to be the national will and not merely the will of the peers, although not constituted as

¹ The result of the general election of January 1910, following on the rejection of the Budget by the House of Lords, cannot properly be said to show anything to the contrary. It was notorious that there was no genuine majority in the new House of Commons for the Budget, and that the Irish Nationalists only voted for it as part of an arrangement for ulterior purposes.

such in the narrower sense. In practice, and in accordance with this view, it has on more than one occasion (*e.g.* in the case of the Trades Disputes Act of 1906) accepted and passed measures which it was notorious, and indeed avowed, that the peers themselves regarded as bad.

The immense extension of the "representative principle" in government, by means of popular election, and its adaptation to municipal as well as national councils, has in recent times resulted in attracting much attention to the problem of making such elected bodies more accurately representative of public opinion than they frequently are. There are three distinct problems involved—(1) that of making the number of enfranchised citizens correspond to a real embodiment of the nation; (2) that of getting candidates to stand for the office of representative who are competent and incorruptible exponents of the national will, and (3) that of adopting a system of voting which shall result in the elected representatives forming an assembly which shall adequately reflect the balance of opinion in the electorate.

(1) The history of the gradual extension of the franchise in the United Kingdom is given under PARLIAMENT, and the conditions for other countries under their respective headings. But while, in countries with a representative system at all, the question as to the extent to which the male citizens shall have the vote is mainly one of degree—as to property or other qualification, up to the inclusion of all adults (see VOTE AND VOTING)—the question of the incapacity of women, as a sex, raises a distinction which is more radical. The facts as to the progress of the movement for women's suffrage are given in the article WOMEN. It is only necessary to say here that, where the franchise is limited to the male sex, the theory of "no taxation without representation" is under modern conditions of life carried out in a decidedly one-sided way. The question of women's suffrage is, however, one of public policy, in whatever state it is raised; and even where, as in Great Britain, it has been adopted for municipal affairs, a distinction is commonly made as regards the national assembly. So far as the historical facts as to the disability of women are concerned, it has been unanimously decided in England by the highest law-court of the realm (judgment of the House of Lords in the Edinburgh University case, December 1908), presided over on this occasion by a Liberal Lord Chancellor (Lord Loreburn), that, according to their authoritative statement of the common law, women never had in earlier times any legal right to vote for members of parliament; this judgment is therefore entirely adverse to such ingenious arguments to the contrary as are ably exposed in Mrs Charlotte Carmichael Stopes's *British Free-women* (1907).

Sex, however, apart, there are various interesting questions as to the principles which should govern the extension of the suffrage and its limitations, to which a brief reference may here be made. It is noteworthy that John Stuart Mill, the philosophical radical whose work on *Representative Government* (first published in 1861) is a classic on the subject, and who regarded the representative system as the highest ideal of polity, made a good many reservations which have been ignored by those who frequently quote him. Mill's ideal was by no means that popular government should involve a mere counting of heads, or absolute equality of value among the citizens. While holding that "no arrangement of the suffrage can be permanently satisfactory in which any person or class is peremptorily excluded, or in which the electoral privilege is not open to all persons of full age who desire to obtain it," he insisted on "certain exclusions." Thus he demanded that universal education should precede universal enfranchisement, and laid it down that if education to the required amount had not become universally accessible and thus a hardship arose, this was "a hardship that had to be borne." He would not grant the suffrage to any one who could not read, write and perform a sum in the rule of three. Further, he insisted on the electors being taxpayers, and emphasized the view that, as a condition annexed to representation, such taxation should descend to the poorest class

Difficulties in obtaining Representation by Election.

The Suffrage.

"in a visible shape," by which he explained that he did not mean "indirect taxes," a "mode of defraying a share of the public expenses which is hardly felt." He advocated for this purpose "a direct tax, in the simple form of a capitation" on every grown person. But even more than this, he was in favour of a form of plural voting, so that the intellectual classes of the community should have more proportionate weight than the numerically larger working-classes: "though every one ought to have a voice, that every one should have an equal voice is a totally different proposition." The well-informed and capable man's opinion being more valuable than that of the barely qualified elector, it should be given more effect by a system of plural voting, which should give him more votes than one. As to the test of value of opinion, Mill was careful to say he did not mean property—though the principle was so important that he would not abolish such a test where it existed—but individual mental superiority, which he would gauge by the rough indication afforded by occupation in the higher forms of business or profession, or by such a criterion as a university degree or the passing of an examination of a fairly high standard.

"Until there shall have been devised some mode of plural voting, which may assign to education as such the degree of superior influence due to it, and sufficient as a counterpoise to the numerical weight of the least educated class, for so long the benefits of completely universal suffrage cannot be obtained without bringing with them, as it appears to me, more than equivalent evils." "Equal voting," he repeated, "is in principle wrong, because recognizing a wrong standard, and exercising a bad influence on the voter's mind. It is not useful, but hurtful, that the constitution of the country should declare ignorance to be entitled to as much political power as knowledge."

Modern democracy may ignore Mill's emphatic plea for plural voting, as it ignores his equally strong arguments against the ballot¹—his contention being that secret voting violated the spirit of the suffrage, according to which the voter was a trustee for the public, whose acts should be publicly known—but Mill's discussion of the whole subject proceeds on high grounds which are still worth careful consideration. Where a representative system, as such, is extolled as the ideal polity, the reservations made by Mill, a liberal thinker who cannot be dismissed as a prejudiced reactionary, should be remembered. Mill postulated, in any event, a state of society which was worthy of such a system, no less than the necessary checks and balances which should make it correspond to the real conditions of rational government. "Representative institutions," he pointed out, "are of little value, and may be a mere instrument of tyranny or intrigue, when the generality of electors are not sufficiently interested in their own government to give their vote, or, if they vote at all, do not bestow their suffrages on public grounds, but sell them for money, or vote at the beck of some one who has control over them, or whom for private reasons they desire to propitiate. Popular election, as thus practised, instead of a security against misgovernment, is but an additional wheel in its machinery." When, in modern days, advocates of representative institutions seem ready to extend them to all countries, they become doctrinaires who depart widely from the standpoint of Mill, and forget that democracy is itself only a "form of government," as Sir Henry Maine insisted, for which all communities may not be ripe or fitted. The ideal form of government must be relative to a certain state of civilization and certain conditions of national life, and its advantages can only be tested by results and practical working.

(2) As regards the important question of the selection of candidates (which depends partly on their willingness to stand, and partly on the means available for discovering suitable persons), modern practice is entirely dominated by the organization of political parties and the requirements of party allegiance. Though much has been said as to the desirability or not of paying members for their services (see PAYMENT OF MEMBERS), this is certainly overshadowed by the question of the availability of really capable men at all to the number required, for all candidates become "professional"

politicians, whether paid or not. The ideal of having a "representative man" in the broader sense as a "representative" in the narrower is only very roughly attained where the conditions of public life make a capacity for electioneering a necessity. To a large extent the political candidate depends purely upon the support of a party organization. His choice rests with party wire-pullers, and the average individual elector is confronted with the task of voting for some one of whom he may personally know very little, except that, if returned, the candidate will in parliament vote for measures embodying certain general principles as indicated in some vague party programme. Since the elector as a rule himself supports a party, he votes accordingly, but there are always a good many electors who under such a system fail to get a chance of voting for a candidate who fully represents their views. The supremacy of party interests, resulting from the difficulty of having any other form of electoral organization, is apt to bring many evils in its train, including the corruption of the electorate, and the practice of "lobbying," i.e. the pressure upon members in parliament of important "interests" whose electoral assistance is indispensable.

(3) The more important point to be considered here is the third. When a representative assembly is to be elected by a direct popular vote, it is obviously necessary (a) that *Systems of Voting* either there should be some system by which the whole of *Voting* body as a unit should elect all the members *en bloc*, or, as this usually appears impracticable, that the mass of electors should be divided within defined areas, or "constituencies"; and (b) that in the latter case voting shall take place for the purpose of electing one or more representatives of each such area according to some method by which due effect shall be given to the preferences of the electors. In theory there can be no perfectly fair arrangement as between constituency and constituency, where a single representative is to be returned, except on the terms that they are exactly equal in the number of electors; each elector's voice would then count equally with that of any other in the nation (or *multis in multis* in the municipality, &c.). But in practice it is difficult to the point of impossibility to attempt more than an arbitrary distribution of electoral areas, more or less approximating to equality; and recourse is had to the formation of constituencies out of geographical districts taken as units for historical or practical reasons, and necessarily fluctuating from time to time in population or influence. It may become necessary periodically to revise these areas by what in England are called Redistribution Acts, but it has to be admitted that any perfect system of representation is always stultified by the necessary inequalities involved; and what is known as "gerrymandering" is sometimes the result, when a party in power so recasts the electoral districts as to give more opportunity for its own candidates to be returned than for those of its opponents. This flaw is particularly noticeable when the arrangement for the method of voting is that which allots only one member or representative to each district (*scrutin d'arrondissement*). The essential vice of this single-member system, which prevails in the United Kingdom² and the United States, is the lack of correspondence between the proportions in which the elected members of each party stand to one another and the proportions in which the numbers of the electors who returned them similarly stand; and it may well be that the minority party in the country obtains a majority of representatives in the assembly, or at any rate that a substantial minority obtains an absurdly small representation. "As a result of the district system," writes Professor J. R. Commons of Wisconsin (*Proportional Representation*, 1907), "the national House of Representatives (in America) is scarcely a representative body. In the Fifty-first Congress, a majority of representatives were elected by a minority of the voters"; the figures being 5,348,379 Republican votes with 164 electors, and 5,502,581 Democratic votes with 161 elected. In

² The House of Commons in 1910 was elected by 643 constituencies, of which 27 (including three universities) returned 650 members each, and the rest one; and the Royal Commission, which reported in that year, recommended the abandonment of the existing two member constituencies "at the earliest convenient opportunity."

¹ Before 1872, when the Ballot Act was passed, voting was public.

the case of the Fifty-second Congress, the Democrats, with 50.6% of the votes, returned 71.1% of the representatives; the Republicans, with 42.9% of the votes, returned 26.5% of the representatives. Lord Avebury (*Proportional Representation*, 1890; new ed. 1906) has given various similar experiences in England; thus, at the general election of 1886, the Liberals, with 1,333,400 votes, only obtained 176 seats, while the Unionists, with 1,423,500, obtained 283 (not counting 99 unopposed returns on the Liberal side, and 111 on the Unionist). In the general election of 1895, at which 132 Unionist seats and 57 Liberal were unopposed, the result in the 481 seats contested was the return of 279 Unionists and 202 Liberals; yet the actual votes given were 1,800,000 for the Liberals, and 1,775,000 for the Unionists. Again, in 1906, the Unionist vote, though 44% of the total cast, returned only 28% of the members, and the Liberal majority, which in strict proportion would have been 68, actually was 256.

The establishment of mere party majority rule, which is characteristic of a representative system, is a necessity, no doubt, in popular government; but the way in which a substantial minority of voters may only obtain a contemptible minority of members, and may in practice be tyrannized over in consequence, somewhat detracts from its blessings, and leads to extreme party measures. The division of the whole electoral body into constituencies is, after all, only a device for getting over the difficulty of the electors voting *en bloc*, and it does not seem to justify the conversion of a real majority in the country into a minority as represented in parliament, nor the complete exclusion of a substantial number of the electorate from parliamentary representation—so far as their views are concerned—at all. Yet under the English system such results are possible as the capture of every seat in Wales (34), in 1906, by the Liberal party, with 217,462 votes, the 100,547 Unionist voters having no representation in parliament; while in Warwickshire, though 22,490 votes were given to the Unionist candidates against 22,021 for the Liberal, three Liberals were returned against one Unionist.

The attempt to rectify this flaw in the representative method has led to the suggestion of various devices by the adoption of which the elected members may correspond more equally to the divisions of opinion in the electorate. Under the plan of *scrutin de liste* (or "general ticket") larger districts are created, each returning several members, and each voter has as many votes as there are members to elect; but while this system apparently provides the opportunity for the return of candidates with different views, it only requires a solid party vote to capture the whole of the representation for a majority. What is known as the "limited vote" is a form of *scrutin de liste* by which the elector has less votes than there are seats to be filled; with (say) three to be elected, the elector has only two votes. Systems of "limited vote" are in force in Portugal, Spain and Japan. A somewhat better plan is the "cumulative vote," which gives each elector as many votes as there are members to be elected, but allows him to divide them as he pleases (instead of giving only one vote to any one candidate). This enables an organized minority, by concentrating their votes, to elect at all events some representative; but the "cumulative vote" works rather capriciously, and is commonly defeated by careful party organization.

A more elaborate plan, but depending like the "limited" vote and the "cumulative" vote on the formation of constituencies returning three or more members each, is that of the "transferable vote." By this device an elector can indicate on his ballot paper not only his first choice, but also his second or third, &c. To ensure election a candidate need not obtain a majority of the votes polled, but only a certain number, so fixed that it can be obtained by a number of candidates equal to the number of seats to be filled, but by no more; this number of votes is called the "quota." At the first count first choices only are reckoned, and those candidates who have received a "quota" or more are declared duly elected. If all the seats

have not then been filled up, the surplus votes of those candidates who have received more than the "quota" are transferred according to the names marked (2) on them. If these transfers still do not bring the requisite number of candidates up to the "quota," the lowest candidate is eliminated and his votes transferred according to the next preferences, and so on till the seats are filled. This system, which is the one usually associated with the term "proportional representation" was first suggested by Thomas Hare, who published in 1857 a pamphlet on *The Machinery of Representation*, and in 1859 a more complete scheme in his treatise on *The Election of Representatives*. John Stuart Mill, in *Representative Government* (1861) warmly endorsed Hare's proposal. Hare wished to treat the whole country as one constituency, but by later supporters of the "transferable vote" that plan was abandoned as impracticable; and the principle will work so long as the constituencies adopted each return several members. Lord Courtney, in his evidence before the British Royal Commission in 1909, said that his *minimum* constituency would be a three-membered one, but he would create a fifteen-membered constituency without hesitation. The simple "transferable vote" has been adopted in Tasmania for all elections (1907), after experimental adoption in the constituencies of Hobart and Launceston in 1896-1901, and in the election of the Tasmanian members of the Commonwealth legislature in 1900. It was proposed in the draft of the South African constitution, but abandoned. The principle has also been adopted in the "list systems" of Belgium, some Swiss cantons, Sweden, Finland and parts of Denmark, Württemberg and Servia, where candidates are grouped in lists and all votes given to individual candidates on the list count first as votes for the list itself, the seats being divided among the lists in proportion to the total number of votes obtained by the list. The use of the general term "proportional representation" for all of these is, however, somewhat misleading; people often suppose that only one identical system of voting is meant, whereas in fact some 300 possible varieties have been proposed, and each of the states mentioned has a different one from all the others. The only common element is the device of the "transferable vote," i.e. the method of having an "electoral quota," and the filling up of seats, where a quota is not provided by the first choices, by votes transferred from the second choices, and so on. It may be noted here that the "transferable vote" is calculated to multiply candidates to a point at which the minds of the electorate may well be embarrassed as to their preferences (the largest Belgian constituency returns 22 members), and, while undoubtedly providing for "minority representation," to encourage what may be called "minority thinking" and particularist politics. The "transferable vote" is commonly objected to as puzzling to the electors and too complicated for the scrutineers, while it is not much favoured by "machine" party organizations, which generally prefer the simpler plan of rough-and-ready majorities; but it has received a growing amount of theoretical support, as well as success in practical experiment, in recent years.

The "second ballot" is a device for securing absolute majority, instead of relative majority, representation. Where the two-party system prevails, it is usual for only two candidates, one for each party, to stand for each single-member constituency. But there is nothing to prevent a third or even a fourth candidate standing, and this multiplication of candidates becomes the more common in proportion as parliamentary organization is split up into groups. The consequence is that the candidate who heads the poll may well have only a relative, not an absolute, majority of votes, and to meet this objection the "second ballot" has been introduced, and is in operation in Austria-Hungary, France, Germany, Italy and Russia. Under this system, if no candidate receives an absolute majority of all the votes, a second election is held, at which, as a rule, only the two candidates compete who received most; or in cases where more than one seat is to be filled, twice as many candidates compete as there

Proportional representation.

The second ballot.

are seats. In principle the second ballot has much in its favour, though it does not necessarily reflect the real opinion of the electorate, but only what is practicable; and while leading to political bargaining it does nothing for minority representation.

In England the importance of the whole subject of the method of elections was recognized at the end of 1908 by the appointment of a Royal Commission to inquire and report. Its conclusions were published in 1910, after much interesting evidence had been taken, but they attracted little attention, being in the main adverse to innovation. The one positive recommendation was for the adoption of the "alternative vote" (already in use in Queensland and Western Australia) by which the electors might mark their choices 1, 2, 3, &c.; this would not be for the purpose already discussed as part of the method of the "transferable vote," but the indications of preference would only be used for the same purpose as the "second ballot," while saving the voters the trouble of further elections. One objection to this "alternative vote," however, as compared with the "second ballot," is that it does not allow the voter to change his mind as to his preference, as he well might do after he knew the result of the original voting.

It may be said broadly that all the devices which have been proposed for mitigating or redressing the defects of electoral methods ignore the essential fact that in any case a representative system can only result in a rather arbitrary approximation to correspondence with the opinions of the electorate. It is by no means certain even that "proportional representation" in any of its forms would always result in the return of a representative assembly reflecting with mathematical accuracy the balance of opinion in the electorate; and even if it did, the electors have a way of changing their opinions long before their representatives come up for re-election. It was stated before the British Royal Commission that in Belgium, in spite of "proportional representation," both in 1900 and in 1902 a majority of members was returned by a minority of votes. While under majority rule, as Mr Augustine Birrell once remarked, "minorities must suffer"—even large minorities—it is on the other hand not likely to conduce to the popularity of representative government that minorities should obtain too great a share of political power. The fact is that no "representation" can reflect the views of those "represented" as accurately as "presentation" by those entitled personally to speak. This conclusion, while in no necessary degree qualifying the importance of "popular government," undoubtedly detracts from the value of the representative method. The result is seen in the increasing desire in really democratic countries to supplement representative government by some form of Referendum, or direct appeal to the electors for their own personal opinion on a distinct issue—a method which involves fundamentally the addition of a "presentative" element to the representative system.

LITERATURE.—The number of separate works on various aspects of the theory, history and practice of political representation—a much wider subject than representative government—is too large for detailed mention. A general reference can only be made here to the standard treatises on constitutional law. The chapter in Sir G. Cornewall Lewis's *Remarks on the Use and Abuse of some Political Terms* (Sir T. Raleigh's edition, 1898) should also be noted. In addition to works cited above, a valuable account of all parts of the electoral "machine" is given in M. Ostrogorski's *Democracy and the Organization of Political Parties* (1902). The Congressional Library, Washington, U.S.A., issued in 1904 a "List of Books relating to Proportional Representation," which constitutes a complete bibliography of that subject up to that date. The best discussion of the various methods for securing adequate representation is, however, now to be found in the *Report* (1910) of the British Royal Commission on Systems of Election (Parliamentary Paper, Cd. 5163). It is chiefly valuable for its description of the devices in use in different countries and for its weighty criticism of the proposals for minority representation. (H. CH.)

REPRIEVE (*reprise*, from Fr. *reprendre*), in English law, a term which originally meant remand to prison: later and more usually, the suspension for a time of the execution of a sentence passed on conviction of crime. The term is now seldom or never used except with reference to sentences of death. In

the case of capital felonies other than murder the recording of sentence of death has the effect of a reprieve by the court. The court which can award a sentence is said to possess as of common right a discretionary power of granting a reprieve. Courts of justice, however, do not grant reprieves by way of dispensation from the penalties of the law, which is not for the judicial department, but for temporary purposes, e.g. of appeal or inquiry as to the state of mind or health of the convict, or to enable him to apply for a pardon. Under the old system of transportation it was a common practice to reprieve convicted felons as a step to induce them to consent to transportation to the American colonies (see the *Old Bailey Regulations of 1662*, J. Kelyng, ed. 1873, p. 1). In cases of conviction of wilful murder the reprieve, if any, is granted by the home secretary on behalf of the crown, and on convictions of murder the court seems now to have no power to reprieve except in the case of a pregnant woman.

—See Hawkins, *P.C.* bk. 2, c. 51; Blackstone, *Commentaries*.

REPRISALS (Fr. *représailles*, from *reprendre*; Lat. *reprehendere*, to take back), properly speaking, the act of forcibly seizing something belonging to another state by way of retaliation, but currently used for the retaliation itself. They are acts of violence which are a *casus belli* according to the manner in which the state against which they are exercised regards them and is able to resist or resent them. Two comparatively recent cases have occurred in which this form of redress was resorted to. In the one case a demand by the British government for an indemnity for injuries inflicted on the British vice-consul and certain other British subjects by Nicaraguan authorities in the Mosquito reserve not having been complied with, British naval forces were landed on April 27th, 1895, at Corinto, where they occupied the customs house and other public buildings till an agreement was arrived at. In the other case the French government in November 1901 ordered the occupation by French naval forces of the customs house at Mytilene until redress was obtained for divers claims of French citizens. A Hague Convention of 1907 now places limitations on the employment of force for the recovery of contract debts, and forbids recourse to armed force unless "the debtor state refuses or neglects to reply to an offer of arbitration, or after accepting the offer prevents any compromise from being agreed on, or after arbitration fails to submit to the award" (art. 1). (T. BA.)

REPRODUCTION, in biology, the generation of new organisms from existing organisms more or less similar. It is a special case of growth, and consists of an increase of living substance in such fashion that the new substance is either set free as a new individual, or, whilst remaining attached to the parent organism, separated by some sort of partition so as to have a subordinate individuality. Y. Delage has distinguished as *multiplication* those cases in which the new individual arises from a mass of cells which remain a part of the maternal tissues during differentiation, reserving the term *reproduction* for those cases in which the spore or cell which is the starting-point of the new individual begins by separating from the maternal tissues; but the distinction is inconvenient in practice and does not appear to carry with it any fundamental biological significance. The general relation between parent and filial organisms is discussed under HEREDITY and EMBRYOLOGY; many of the details of the cellular processes are dealt with under CYTOLOGY, and the modes of reproduction exhibited by different kinds of animals and plants are treated of in the various articles describing individual groups. Finally, some of the special problems involved are discussed under the heading SEX. As reproduction is a general biological phenomenon, its manifestations should be dealt with simultaneously in the case of animals and plants, but many of the special details differ so much that it is practically convenient to make two headings.

REPRODUCTION OF ANIMALS

A. Asexual.—Many animals possess a more or less limited capacity to repair portions of the body that have been accidentally removed (see REGENERATION), and this capacity may be so

extensive that, if the whole body be cut in pieces, each portion may grow into a new organism. Such a mode of artificial propagation, familiar in horticultural operations, has been made use of in such animals as sponges, and has been performed experimentally in hydroids and some worms. In many Protozoa asexual reproduction by simple division is a normal event. In Coelentera it is common, the plane of division usually passing through the long axis of the body, as in Actinians and many Hydroids, or being horizontal, as in the repeated divisions by which medusae are produced from an asexual polyp; the new individual may separate completely, or serve to build up a colonial or compound organism. In some Tubellarians (*Microstomum*) and Chaetopods (*Syllis*, *Myrianida*, *Nereis*, *Eunice viridis* (the palolo-worm of Samoa)), asexual reproduction occurs in a form that is partly fission and partly budding; portions are constricted transversely or laterally, very much smaller than the whole animal, and these grow out into new animals which may separate or remain attached in chains. In Salps, chains are formed sometimes by transverse constriction, sometimes by budding. True budding is much more common than fission; it occurs in Protozoa, Coelentera, Sponges, Polyzoa, Tunicates and some Flatworms and Chaetopods, the bud being a multicellular portion of the tissues which is partly or completely separated from the parent before it proliferates into the new form. In various larval stages of many animals, asexual reproduction by fission or budding may be produced experimentally or may occur naturally. It has been suggested that cases of identical twins in vertebrates and many monstrous forms, including even dermoid cysts, are due to embryonic asexual fission or budding. The artificial subdivision of young embryos has been performed successfully by several investigators (see HEREDITY). In *Lumbricus trapezoides* the gastrula stage of the embryo divides and each half produces a complete individual; and multiplication by budding is common at various stages of the life-history of many parasitic worms. Spore formation, or cellular budding, appears to be limited to the Protozoa amongst animals.

B. Sexual.—Apart from the special and probably secondary cases presently to be considered under the subheading *parthenogenesis*, sexual reproduction or amphimixis may be defined as the production of a new organism from a zygote, and a zygote may be defined as the cell resulting from the conjugation of two gametes or sexual cells derived from the specialized reproductive tissue of the parent or parents. In asexual reproduction by spore formation, the spore proliferates without the aid of another spore; in true sexual reproduction the gametes may be regarded as special kinds of spores which appear in two forms, the egg-cell, ovum or female gamete not proceeding to proliferate into a new organism until it has been stimulated by partial or complete fusion with the other form, the spermatozoon or male gamete. The act of fusion or conjugation in question is usually spoken of as fertilization, and the zygote, or starting-point of the new organism, is the fertilized egg-cell. Among protozoa and the lower plants there occur a series of forms of conjugation leading towards the specialized form characteristic of the sexual reproduction of higher animals. The conjugation may be *isogamous*, that is to say the conjugating cells may be actually or at least apparently indistinguishable. The fusion between the cells may be complete, or may concern only the nuclei. The conjugation may be followed by reproduction, or may apparently have no relation to reproduction. In true sexual reproduction the conjugation is *heterogamous*, i.e. the gametes are unlike; the fusion is chiefly nuclear, and the process is the prelude of the development of the zygote into the new organism.

In all the Metazoa the gametes arise from special reproductive tissues which are supposed to contain (see HEREDITY) the reproductive material or germ-plasm. In the lower (or simpler and possibly degenerate Metazoa) the reproductive or germinal tissue consists of a few cells, sometimes in a group, sometimes scattered and sometimes migratory; in the vast majority of the Metazoa the germinal tissue becomes aggregated in distinct organs, of which those that give rise to ova or female gametes

are known as the ovaries, and those that give rise to the spermatozoa or male gametes are known as the testes. The ovary and the testis are the primary reproductive organs; the details of their anatomy and position in the various groups need not be discussed here (see REPRODUCTIVE SYSTEM).

The male gamete or spermatozoon was first seen in 1677 by Ludwig van Hammen, a pupil of A. Leeuwenhoek, with the microscope that had been constructed by his master. Leeuwenhoek, under the influence of the current preformationist ideas, interpreted these actively moving bodies in the seminal fluids as preformed germs and described them as animalculae spermatica or spermatozoa. Throughout the 18th century the general tendency was to regard them as parasites of no consequence in fertilization. In 1837 R. Wagner established that they were present in all sexually mature males and absent in infertile male hybrids, and in 1841 A. Kölliker showed that they were cells proliferated in the testes. The spermatozoon is one of the smallest of known cells, frequently being no more than one hundred thousandth of the size of the ovum, although the extraordinary case of a small *Cypris* has been recorded in which the spermatozoa are longer than the animal. It is produced in enormous quantities and relatively to other minute cells is extremely tenacious of life. It may retain its vitality in the male organism for a long time after it has become a separate cell, and may exist for lengthy periods in the female organism. The queen-bee is impregnated only once, and the spermatozoa may remain functional within her body for three years. Lord Avebury (Sir J. Lubbock) has described the case of a female ant which laid fertile eggs thirteen years after she had been impregnated. It is undoubted that in snakes, birds and many mammals, fertilization may not take place for many days after impregnation. The spermatozoa, with a few exceptions, are actively motile, being elongated in shape, with a vibratile tail sometimes provided with a swimming membrane. In a few cases, chiefly of crustaceans, the spermatozoa are spherical with radiating processes, but are capable of amoeboid movements. The cell nucleus is generally situated near the rounded or pointed extremity, with a centrosome immediately behind it, whilst the scanty protoplasm forms the body and vibratile tail; but there appears to be no general significance in the various configurations that occur amongst different animals. The process of spermatogenesis, or production of spermatozoa from the permanent cells of the testis, varies extremely amongst different animals and has been the subject of many elaborate investigations and much confusing nomenclature. Two factors are involved: first, the arrangements to produce a very large crop of cells so to provide for the enormous numbers of spermatozoa produced by most animals; and second, the final changes of shape and of nucleus by which the ripe spermatozoa arise from the indifferent testis-cells, and these processes may to a certain extent overlap. The point of general significance relates to the nuclear changes. The nuclear matter that occurs in the tissue cells of animals, when these cells divide, breaks up into a number of chromosomes constant for each kind of animal, and the final stage of cell division is such that each chromosome splits and contributes a half to each daughter cell, so that the latter come to contain the number of chromosomes peculiar to the animal in which they occur. In the case of spermatozoa, however, a "reducing" division occurs, in which the chromosomes instead of dividing distribute themselves equally between the two daughter cells, with the result that each of the latter contains only half the number peculiar to the species. In its simplest form, what occurs in the last stage of spermatogenesis is that one cell breaks up into four spermatozoa by two successive divisions, the first of which is normal and the second reducing. The nuclear matter of spermatozoa, therefore, contains half the number of chromosomes normal to the tissue cells of the species, and we shall see later that a similar reduction takes place in the formation of the egg. Further complications, however, exist, at least in certain forms. In 1891 H. Henking showed that in a Hemipteran insect of the genus *Pyrrochoris*, two kinds of spermatozoa are produced in equal numbers, and F. C. Paulmier

confirmed the observation in the case of some other insects a few years later, whilst other observers have extended the observation to over a hundred species. In all these cases half the spermatozoa differ from the other half by the presence of what E. B. Wilson calls the "X-element," and which, in the simplest cases, occurs as an unpaired chromosome of the mother cell which passes into one and not the other of the two spermatozoa formed from that mother cell. The matter is still obscure, and it is not certain whether the facts are peculiar to insects or have a parallel in spermatogenesis universally. According to E. B. Wilson, the facts demonstrate that eggs fertilized by spermatozoa with the X-element invariably produce females (see Sex). The female gamete or ovum is in a large number of cases expanded by the presence of food-yolk and protective swathings to form the visible mass known as an egg, and the production of embryos from eggs has been studied from the time of Aristotle and Pliny. Galen had described the human ovaries as *testes muliebres*, and W. Harvey in 1651 showed that the chick arose from the cicatrula of the yolk of the egg, compared these early stages with corresponding stages in the uterus of mammals, and laid down the general proposition—*ovum esse primordium commune omnibus animalibus*—that the ovum is a starting-point common to all animals. In 1664 N. Steno identified the sexual organ of the mammalian female with that of sharks, and first named it the ovary. In 1672 R. De Graaf described the structure of the ovary in birds and mammals, observed the ovum in the oviduct of the rabbit, and repeated Harvey's statement as to the universal occurrence of ova, although he mistook for ova the follicles that now bear his name. In 1825 J. E. Purkyně described the germinal vesicle in the chick, thus distinguishing between the structure of the egg as a whole and the essential germinal area, and in 1827 K. E. von Baer definitely traced the ovum back from the uterus to the oviduct and thence to its origin within the Graafian follicle in the ovary, and thus paved the way for identification of the ovum as a distinct cell arising from the germinal tissue of the ovary. The ovum or female gamete, unlike the spermatozoon, is a large cell, in most cases visible to the naked eye even in the ovary. Also, in definite contrast with the spermatozoon, it is a passive non-motile cell, although in certain cases it is capable of protruding pseudopodia. It is usually spherical, contains a large nucleus, a centrosome and abundant protoplasm, and is generally enclosed in a stout membrane which may or may not have a special aperture known as the micropyle. The protoplasm of all eggs contains nutritive material for the nourishment of the future embryo, and this material may be sufficient in quantity to make the whole cell, although remaining microscopic, conspicuously large, or to expand it to the relatively enormous mass of the yellow yolk of a fowl's egg. Finally, the cellular nature of the ovum is frequently further disguised by its being enclosed in a series of membranes such as the albumen and shell of the fowl's egg. Such complexities are ancillary to the growth or protection of the future embryo, and from the general biological point of view the ovum is to be regarded as a specialized cell derived from the germinal tissue of the ovary, just as the spermatozoon is a specialized cell derived from the corresponding stock of germinal material in the testis. The number of ova produced varies from a very few, as in mammals and birds, to a very large number, as in the herring and many invertebrates, but in all cases the number is relatively small compared with that of the spermatozoa produced by the male of the same species. The details of oögenesis are more sharply divided than in the case of spermatogenesis into processes connected with the production of a crop of large cells bloated with food-yolk, and the peculiar nuclear changes. The latter changes are generally spoken of as the maturation of the ovum, and in most cases do not begin until the full size has been attained. As in the nuclear changes of spermatogenesis, the details differ in different animals, but the salient feature is that the mature ovum contains, like the ripe spermatozoon, half the number of chromosomes normal to the tissue cells of the animal to which it belongs. The simplest form in which the reduction takes place is that the nucleus of the ovum divides by an ordinary

division, each chromosome splitting and sharing itself between the daughter nuclei. Of these nuclei one is extruded from the egg, forming what is called a polar body, and this polar body may again divide by a reducing division, so as to form two polar bodies, each with half the normal number of chromosomes. Finally, the daughter nucleus, remaining in the ovum, also divides by a reducing division, and one of the segments remains to form the nucleus of the ripe ovum, with half the normal number of chromosomes, whilst the other is extruded as a polar body. Very many suggestions as to the meaning of the extrusion of the polar bodies have been made, but the least fanciful of these is to regard the ovum ready for maturation as homologous with the cell about to divide into four spermatozoa; in each case the nucleus divides twice and one of the divisions is a reducing division, so that four daughter nuclei are formed each with half the normal number of chromosomes. Many spermatozoa are required, and each of the four becomes the nucleus of a complete active cell; relatively few ova are required, but each has a large protoplasmic body, and only one of the four becomes a functional mature egg, the other three being simply extruded and so to say wasted. It must be remembered, however, that there is no inherent probability in favour of the apparently simplest explanation of a very complex biological process. It is also to be noted that in many cases the first polar body does not divide, and it is not clearly established that when the first polar body remains single, it is always the result of a normal nuclear division.

When the mature ova and spermatozoa come together in one of the various ways to be discussed later, fertilization, the conjugation of the gametes to form the zygote, occurs. Alcaemon (580 B.C.) is believed first to have laid down that fertilization in animals and plants consisted in the material union of the sexual products from both sexes, but it was not until 1761 that it was established experimentally by J. T. Kölreuter's work on the hybridization of plants. In 1780 L. Spallanzani artificially fertilized the eggs of the frog and tortoise, and successfully introduced seminal fluid into the uterus of the bitch, but came to the erroneous conclusion that it was the fluid medium and not the spermatozoa that caused fertilization. This error was corrected in 1824 by J. L. Prevost and J. B. Dumas, who showed that filtration destroyed the fertilizing power of the fluid. In 1843 M. Barry observed spermatozoa within the egg of the rabbit, whilst in 1849 R. Leuckart observed the fertilization of the frog's egg, and in 1851 H. Nelson noticed the entrance of spermatozoa to the egg of *Ascaris*, whilst in 1854 a series of observations published independently by T. L. W. Bischoff and Allen Thomson finally and definitely established the fact that ova were fertilized by the actual entrance of spermatozoa. Further advances in microscopical methods enabled a series of observers, of whom the most notable were E. van Beneden, H. Fol and O. Hertwig, to follow and record the details of the process. They made it clear that the chief event in fertilization was entrance into the ovum of the nucleus or head of the spermatozoon where it formed the "male pronucleus," which gradually approached and fused with the female pronucleus or residual nucleus of the ovum. Still later observers, of whom E. B. Wilson is the most conspicuous, have studied the details of the process in many different animals and have shown that the nucleus of the spermatozoon invariably enters the ovum, that the centrosome generally does so, and that the cytoplasm usually plays no part. The nucleus of the zygote or fertilized ovum, then, possesses the number of chromosomes normal in the tissue cells of the animal to which it belongs, but of these half belong to the female gamete and are derived from the germ plasma of the parental ovary, and half to the male gamete or spermatozoon, derived from the germ plasma of the parental testis. The stimulus which leads to and induces the conjugation of the gametes appears to be chemotactic and to consist of some substance positively attractive to the male gamete, liberated by the mature female gamete, but the attraction is mutual, and in the final stages of approach a protoplasmic outgrowth of the ovum towards the spermatozoon frequently occurs. The

fertilized zygote proceeds to form the embryo (see EMBRYOLOGY).

Parthenogenesis is the production of the new organism from the female gamete without previous conjugation with the male gamete, and is to be regarded as secondary to and degenerate from true sexual reproduction. Aristotle recognized that it occurred in the bee. In 1745 C. Bonnet showed that it must occur in the case of Aphides or plant-lice, in which throughout the summer there were developed a series of generations consisting entirely of females. R. A. F. de Réaumur repeated the observations, but evaded the difficulty by suggesting that the Aphides were hermaphrodite, an explanation soon afterwards disproved by L. Dufour. In 1849 (Sir) R. Owen brought together the facts as they were, then known and made a remarkable suggestion regarding them. "Not all the progeny of the primary impregnated germ cell are required for the formation of the body in all animals; and certain of the derivative germ cells may remain unchanged and become included in that body which has been composed of their metamorphosed and diversely combined or confluent brethren; so included, any derivative germ cell or the nucleus of such may begin and repeat the same processes of growth by imbibition, and of propagation by spontaneous fission, as those to which itself owed its origin." Taking hold of the recently published views of J. J. S. Steenstrup on alternation of generations, he correlated the sexual and asexual alternation in hydroids and so forth with the virgin births of insects and Crustacea, and regarded the one and the other as instances of the subsequent proliferation of included germ cells, applying the word parthenogenesis to the phenomenon. His theory was a very remarkable anticipation of the germ-plasm theory of A. Weismann, but further knowledge showed that there was an important distinction between the reproduction of the asexual generations described by Steenstrup and the cases of Aphides and Crustacea, the germinal cells in the latter instances being true ova produced from the ovaries of true females, but capable of development without fertilization. In 1856 C. T. E. von Siebold established this fact and limited Owen's term parthenogenesis to the sense in which it is now used, the development without fertilization of ova produced in ovaries. True parthenogenesis occurs frequently amongst Rotifers, and in certain cases (Philodinadae) males either do not exist or are so rare that they have not been discovered. Amongst Crustaceans it is common in Branchiopods and Ostracods; in the case of Daphnids, large thick-shelled ova are produced towards winter, which develop only after fertilization and produce females; the latter, throughout summer, produce thin-shelled ova which do not require fertilization, and from which towards autumn both males and females are produced. Amongst insects it occurs in many forms in many different groups, sometimes occasional, sometimes as a regular occurrence. Apart from Aphides the classical instance is that of the bee, where eggs that are not fertilized develop parthenogenetically and produce only drones. What is known as pathological parthenogenesis has been observed occasionally in higher animals, e.g. the frog, the fowl and certain mammals, whilst in the case of human beings, ovarian cysts in which hair and other structures are produced have been attributed to the incomplete development of parthenogenetic ova. Finally, it has been shown in a number of different instances, notably by J. Loeb, that artificial parthenogenesis may be induced by various mechanical and chemical stimulations. It has been shown that ova may be induced to segment by the presence of spermatozoa belonging even to different classes of the animal kingdom—as, for instance, the ova of echinoderms by the spermatozoa of molluscs. In such cases the resulting embryos have purely maternal characters. A possible interpretation is that spermatozoa have two functions which may be exercised independently; they may act as stimulants to the ovum to segment, and they may convey the paternal qualities. The former function may be replaced by the chemical substances employed in producing artificial parthenogenesis. Juvenile or precocious parthenogenesis, in which there takes place reproduction without fer-

tilization in immature larvae, has been observed chiefly in insects (Dipterous midges), and to this the term *paedogenesis* has been applied.

The theory of parthenogenesis remains doubtful. When Weismann and others began to study the polar bodies, they made the remarkable discovery that in some parthenogenetic eggs only one polar body was extruded, but the meaning of this distinction was blurred when other cases were described in which two polar bodies were formed. Later on, Weismann drew attention to the difference between normal and reducing divisions, and it now appears to be clear that, with one set of exceptions, ova which develop without fertilization are those in which no reducing division takes place and which, accordingly, contain the number of chromosomes normal to the tissue cells of the species. Such eggs, in fact, resemble the zygote except that all their chromosomes are of maternal origin and the centrosome which becomes active in the first segmentation is that of the ovum and not, as in normal fertilized eggs, that which came in with the spermatozoon. The case of the bee and other insects in which parthenogenetic development results in the production of males, is doubtful; it appears to be the case that a reducing division has taken place in the maturation of the egg. A. Petrunkevitch has made the ingenious suggestion, that after the reducing division the normal number of chromosomes is restored by the splitting of each into two. Cases of pathological and artificial parthenogenesis would fall into line, on the supposition that the stimulus acted by preventing the occurrence of a reducing division in an ovum otherwise mature. It is to be noticed, however, that such explanations of parthenogenesis are not much more than a formal harmonizing of the behaviour of the chromosomes in the respective cases of fertilized and parthenogenetic development; they do not provide a theory as to why the process occurs.

Accessory Reproductive Organs and Processes.—It has been already stated that the primary organs of reproduction in animals are the germinal tissues producing respectively spermatozoa and ova, and that in most cases these are aggregated to form testes and ovaries. In certain animals there are no accessory organs, and when the reproductive products are ripe, they are discharged directly to the exterior if the gonads are external, as in some Coelentera, or if they are internal, break through into some cavity of the body and escape by rupture of the body-wall or through some natural aperture. In a majority of cases, however, special ducts are developed, which in the male serve primarily for the escape of the spermatozoa, but secondarily may be associated with intromittent organs. Similarly, in the female, the primary function of the gonad ducts is to provide a passage for the ova, but in many cases they serve also for the reception of spermatozoa, for the development of embryos and for the subsequent exit of the young. Associated with the ovary and the oviducts are many kinds of yolk-glands and shell-glands, the function of which is to form nutritive material for the future embryo, to discharge this into or around the ovum, and to provide protective wrappings. Although, in the last resort, fertilization depends on impulses attracting the spermatozoa to the ova, probably chemical in their nature, the necessary proximity is secured in a number of ways. In many simple cases the ripe products are discharged directly into the surrounding water, and impregnation is a matter of accident highly probable because such animals discharge enormous quantities of ova and spermatozoa, are frequently sessile and live in colonies, and are mature about the same time. In other cases, as, for instance, Tunicates and many Molluscs, the spermatozoa are discharged, and, being drawn into the body of the female with the inhalant currents, there fertilize the ova. In yet a number of other cases, there is sexual congress without intromittence. The males of many fish, such as salmon, attend the females about to discharge their ova, and afterwards pour the male fluid over the liberated eggs; whilst amongst other fish the males seek out a suitable locality and prepare some kind of nest to which the female is enticed and which receives first the ova and then the milt. In many other animals, again, as for instance the frog, the male grasps the ripe female, embracing

her firmly for a prolonged period, during which ova and spermatozoa are discharged simultaneously. Where internal fertilization occurs, there are usually special accessory organs. In the female, the terminal portion of the gonad-duct, or of the cloaca, is modified to receive the intromittent organ of the male, or to retain and preserve the seminal fluid. In the male, the terminal portion of the gonad-duct may be modified into an intromittent organ or penis, grooved or pierced to serve as a channel by which the semen is passed into the female. In arthropods, ordinary limbs may be modified for this purpose, or special appendages developed; in spiders, the terminal joints of the pedipalps, or second pair of appendages, are enlarged, and are dipped into the semen, which is sometimes shed into a special web, and are used as intromittent organs; in cuttlefish, one of the "arms" is charged with spermatozoa, is inserted into the mantle cavity of the female and there broken off. In many cases there is a temporary apposition of the apertures of the male and female, with an injection from the male without a special intromittent organ. The females are usually passive during coitus, and there are innumerable varieties of clasping organs developed by the male to retain hold of the female. Finally, the various secondary sexual characters which are developed in males and females and induce association between them by appeals to the senses, must be regarded as accessory reproductive organs and processes (see SEX).

Another set of accessory organs and processes are concerned with what may be termed in the widest sense of the phrase "brood-care." In many cases the relation between parent and offspring ceases with the extrusion of the fertilized ovum, whilst others display every possible grade of parental care. Many of the lower invertebrates choose special localities in which to deposit the ova or embryos, and glands, the viscid secretion of which serves to bind the ova together or to attach them to some external object, are frequently present. In many insects, elaborate preparations are made; special food-plants are selected, cocoons are woven, or, by means of the special organ known as the ovipositor, the eggs are inserted in the tissues of a living or dead host, or in other cases a supply of food is prepared and stored with the young larvae. The eggs or larvae may be attached to the parent and carried about with it, as in the gills of bivalves, the brood-pouches of the smaller Crustacea, the back of the Surinam toad, the vocal sacs of the frog *Rhinoderma*, the expanded ends of the oviducts or the marsupial pouch. In a large number of cases the young are nourished directly from the blood of the mother by some kind of placental connexion, as in some of the sharks, in *Anablebs*, a bony fish, in some lizards and in mammals. In other cases, the young after birth or hatching are fed by the parents, by the special secretion of the mammary glands in the case of mammals, by regurgitated food in many birds and mammals, by salivary secretions or by food obtained and brought to the young by the parents.

Reproductive Period.—In a general way, reproduction begins when the limit of growth has been nearly attained, and the instances of paedogenesis, whether that be parthenogenetic as in mides, or sexual as in the axolotl, must be regarded as an exceptional and special adaptation. In lower animals, where the period of growth is short or indefinite, reproduction begins earlier and is more variable. But, in all cases, surrounding conditions play a great part in hastening or retarding the onset of reproduction. Increased temperature generally accelerates reproductive maturity, excess of food retards it, and sudden privation favours it. In a majority of cases it endures to the end of life, but in some of the higher forms, such as birds and mammals, there is a marked decrease or a cessation of reproductive activity, especially in the case of females, as life advances. In most animals, moreover, periods of reproductive activity alternate with periods of quiescence in a rhythmical series. In its simplest form, the rhythm is seasonal; but although at first associated with actual seasonal changes, it persists in the absence or alteration of these. Many animals brought to Europe from the southern hemisphere come

into reproductive activity at the time of year corresponding to the spring or summer of their native home. "Heat," menstruation and ovulation in the higher mammals, including man, are rhythmical, and probably physiologically linked, but the ancestral meaning of the periodicity is unknown.

Reproduction and Increase of the Race.—Two distinct factors are involved in this question—the potential fecundity of organisms, and the chances of the young reaching maturity. The first varies with the actual output of zygotes, and is determined partly by the reproductive drain on the individual, and especially the female in cases where the ova are provided with much food-yolk, partly on the duration of reproductive maturity, and partly on the various adaptive and environmental conditions which regulate the chances of the gametes meeting for fertilization. It is to be noted that as the gametes are simply cells proliferating from the germinal tissue, the potential number that can be produced is almost indefinite; and as it is found that in very closely allied forms the actual number produced varies within very wide limits, it may be assumed that potential fecundity is indefinite. The possibility of zygotes reaching maturity varies first with the individuation of the organism concerned—that is to say, the degree of complexity of its structure—and the duration of the period of its growth; and secondly, with the incidence of mortality on the eggs and immature young. It is plain that a parasite capable of living only on a particular host may give rise to myriads of progeny, and yet, from the difficulty of these reaching the only environment in which they can become mature, might not increase more rapidly than an elephant which carries a single foetus for about two years, and guards it for many years after birth. The probable adaptation of the variable reproductive processes to the average conditions of the race is discussed under the heading LONGEVITY. It may be added here that the adaptation, in all successful cases, appears to be in excess of what would be required merely to replace the losses caused by death, and that there is ample scope for the Malthusian and Darwinian factors. The rate of reproduction tends to outrun the food-supply.

LITERATURE.—Almost any zoological publication may contain matter relating to reproduction, but text-books on Embryology must be specially consulted. The annual volumes of the *Zoological Record*, under the heading "General Subject" until 1906, and thereafter under "Comprehensive Zoology," give a classified subject-index of the literature of the year in which references to the separate parts of the subject are given. Amongst the older memoirs referred to in this article the following are the most important: A. Leeuwenhoek, *Epistolae ad societatem regiam Angliam* (1719); R. A. F. de Réaumur, *Mémoires pour servir à l'histoire des insectes* (Paris, 1734-1742); C. Bonnet, *Œuvres d'histoire naturelle et de philosophie* (Neuchâtel, 1779-1783); L. Spallanzani, *Dissertationes relative to the Natural History of Animals and Vegetables* (Eng. trans., 2nd ed., London, 1789); J. L. Prevost et J. B. Dumas, "Observations relatives à l'appareil générateur des animaux mâles," *Ann. Sci. Nat.* i. (1824); K. E. von Baer, *Epistola ad Academiæ Scient. Petropolitaniæ*; Heusinger, *Zeitschrift*, ii. (1828); Léon Dufour, *Recherches anatomiques et physiologiques sur les Hémiptères* (Paris 1833); R. Wagner, "Recherches sur la génération," *Ann. Sci. Nat.* viii. (1837); A. Kölliker, *Über das Wesen der sogenannten Saamenhülle*, *Froprie*, *Notizen* xix. (1841); M. Barry, "Spermatozoa observed within the Mammiferous Ovary," *Phil. Trans.* (1743); J. S. Steenstrup, *On the Alteration of Generations* (Eng. trans., Ray Society, London, 1845); R. Leuckart, *Beiträge zur Lehre der Befruchtung* (Göttingen Nachrichten, 1849); (Sir) R. Owen, *On Parthenogenesis* (London, 1849); H. Nelson, "The Reproduction of *Ascaris mystax*," *Phil. Trans.* (1852); C. T. E. von Siebold, *On a True Parthenogenesis in Moths and Bees* (Eng. trans., London, 1857); E. van Beneden, "Recherches sur la maturation de l'œuf et la fécondation," *Arch. de biol.* (1883); O. Hertwig, "Das Problem der Befruchtung," *Jen. Zeitsch.* xviii. (1885). (P. C. M.)

REPRODUCTION OF PLANTS

The various modes in which plants reproduce their species may be conveniently classified into two groups, namely, *vegetative propagation* and *true reproduction*, the distinction between them being roughly this, that whereas in the former the production of the new individual may be effected by the most various parts of the body, in the latter it is always effected by means of a specialised reproductive cell.

I. Vegetative Propagation.

The simplest case of vegetative multiplication is afforded by unicellular plants. When the cell which constitutes the body of the plant has attained its limit of size it gives rise to two either by division or gemmation; the two cells then grow, and at the same time become separated from each other, so that eventually two new distinct individuals are produced, each of which precisely resembles the original organism. A good example of this is to be found in the germination of the yeast plant. This mode of multiplication is simply the result of the ordinary processes of growth. All plant-cells grow and divide at some time or other of their life; but whereas in a multicellular plant the products of division remain coherent, and add to the number of the cells of which the plant consists, in a unicellular plant they separate and constitute new individuals. In more highly organized plants vegetative propagation may be effected by the separation of the different parts of the body from each other, each such part developing the missing members and thus constituting a new individual. This takes place spontaneously in rhizomatous plants, in which the main stem gradually dies away from behind forwards; the lateral branches thus become isolated and constitute new individuals.

The remarkable regenerative capacity of plant-members is largely made use of for the artificial propagation of plants. A branch removed from a parent-plant will, under appropriate conditions, develop roots, and so constitute a new plant; this is the theory of propagation by "cuttings." A portion of a root will similarly develop one or more shoots, and thus give rise to a new plant. An isolated leaf will, in many cases, produce a shoot and a root, that is, a new plant; it is in this way that new begonias, for instance, are propagated. The production of plants from leaves occurs also in nature, as, for instance, in certain so-called "viviparous" plants, of which *Bryophyllum calycinum* (Crassulaceae) and many ferns [*Nephradium* (Lastraea) *Filix-mas*, *Asplenium* (*Athyrium*) *Filix-foemina* and other species of *Asplenium*] are examples. But it is in the mosses, of all plants, that the capacity for vegetative propagation is most widely diffused. Any part of a moss, whether it be the stem, the leaves, the rhizoids, or the sporogonium, is capable, under appropriate conditions, of giving rise to filamentous protonema, on which new moss-plants are then developed as lateral buds.

In a large number of plants provision is made for vegetative propagation by the development of more or less highly specialized organs. In lichens, for instance, there are the *soredia*, which are minute buds of the thallus containing both algal and fungal elements; these are set free on the surface in large numbers, and each grows into a thallus. In the Characeae there are the *bulbils* or "starch-stars" of *Chara stelligera*, which are underground nodes, and the branches with naked base and the pro-embryonic branches found by Pringsheim on old nodes of *Chara fragilis*. In the mosses small tuberous bulbils frequently occur on the rhizoids, and in many instances (*Bryum annotinum*, *Aulacomnium androgynum*, *Tetraphis pellucida*, &c.) stalked fusiform or lenticular multicellular bodies containing chlorophyll, termed *gemmae*, are produced on the shoots, either in the axils of the leaves or in special receptacles at the summit of the stem. Gemmae of this kind are produced in vast numbers in *Marchantia* and *Lunularia* among the liverworts. Similar gemmae are also produced by the prothallia of ferns. In some ferns (e.g. *Nephrolepis tuberosa* and *undulata*) the buds borne on the leaves or in their axils become swollen and filled with nutritive materials, constituting *bulbils* which fall off and give rise to new plants. This conversion of buds into bulbils, which subserve vegetative multiplication, occurs also occasionally among Phanerogams, as for instance in *Lilium bulbiferum*, species of *Poa*, *Polygonum viviparum*, &c. But many other adaptations of the same kind occur among Phanerogams. Bulbous plants, for instance, produce each year at least one bulb or corm from which a new plant is produced in the succeeding year. In the potato, tubers are developed from subterranean shoots, each of which in the

following year gives rise to a new individual. In the dahlia, *Thladiantha dubia*, &c., tuberous swellings are found on the roots, from each of which a new individual may spring.

II. True Reproduction.

This is effected by cells formed by the proper reproductive organs. These cells are of two principal kinds. There are, first, those cells each of which is capable of developing by itself into a new organism: these are the *asexual* reproductive cells, known generally as *spores*. Secondly, there are the cells which are incapable of independent germination; it is not until these cells have fused together in pairs that a new organism can be developed: these are the *sexual* reproductive cells or *gametes*.

In some exceptional cases the normal mode of reproduction, sexual or asexual, does not take place: instead, the new organism is developed vegetatively from the parent. When sexual reproduction is suppressed the case is one of *apogamy*; when asexual reproduction by spores is suppressed the case is one of *apospory*. (Apogamy and apospory are discussed below in the section on *Abnormalities of Reproduction*.)

Asexual Reproduction.—Reproduction by means of some kind of spore (using the term in its widest sense, so as to include all asexually produced reproductive cells) is common to nearly all families of plants; it is wanting in certain Algae (Conjugatae, Fucaceae, Characeae), and in certain fungi (e.g. some Peronosporae). The structure of a spore is essentially this: it consists of a nucleated mass of protoplasm, enclosing starch or oil as reserve nutritive material, usually invested by a cell-wall. In those cases in which the spore is capable of germinating immediately on its development the cell-wall is a single delicate membrane consisting of cellulose; but in those cases in which the spore may or must pass through a period of quiescence before germination the wall becomes thickened and may consist of two layers, an inner, the *endospore*, which is delicate and consists of cellulose, and an outer, the *exospore*, which is thick and rigid, frequently darkly coloured and beset externally with spines or bosses, and which consists of cutin. In some few cases among the fungi, multicellular or septate spores are produced; these approximate somewhat to the gemmae mentioned above as highly specialized organs for vegetative propagation. In some cases, particularly among the algae, and also in some fungi (Peronosporae, Saprolegniae, Chytridiaceae, and the Myxomycetes), spores are produced which are usually destitute of any cell-wall, and are further peculiar in that they are motile, and are therefore termed *zoospores*; they move sometimes in an amoeboid manner by the protrusion of pseudopodia, but more frequently they are provided with one, two, or many delicate vibratile protoplasmic filaments, termed *cilia*, by the lashing of which the spore is propelled through the water. The zoospore eventually comes to rest, withdraws its cilia, surrounds itself with a cell-wall, and then germinates.

In the simplest case a single spore is developed from the cell of the unicellular plant, the protoplasm of which surrounds itself with the characteristic thick wall. This occurs only in plants of low organization such as the Schizophyta.

In other cases the contents of the cell undergo division, each portion of the protoplasm constituting a spore. Examples of this are afforded, among unicellular plants, by yeast and the Protococcaceae; and in multicellular plants by the Pandorineae, Confervaceae, Ulvaceae, &c., where any cell of the body may produce spores.

In such cases the spore-producing cell may be regarded as a rudimentary reproductive organ of the nature of a *sporangium*. In more highly organized plants special organs are differentiated for the production of spores. In the majority of cases the special organ is a sporangium, that is, a capsule in the interior of which the spores are developed; but in many fungi the spores are formed by abstriction from an organ termed a *sporophore*. In the Thallophyta the sporangium is commonly a single cell. In the Bryophyta it is a multicellular capsule. In the Pteridophyta the sporangium is multicellular, but simple in structure, and this is true also of the Phanerogams.

It is important to note that in all the Bryophyta and in some of the Pteridophyta (most of the Filicinae, all existing Equisetinae, and the Lycopodiaceae and Psilotaceae) there is but one kind of sporangium and spore, the plants being *homosporous* or *isosporous*, whereas the rest of the Pteridophyta (Hydropteridae, Selaginellaceae) and the Phanerogams are *heterosporous*, having sporangia of two kinds; some produce one or a few large spores (*megaspores*), and are hence termed *megasporengia*, while others give rise to a larger number of small spores (*microspores*) and are hence termed *microsporengia*. In the Phanerogams the two kinds of sporangia have received special names: the megasporangium, which produces as a rule only one mature spore (*embryo-sac*), is termed the *ovule*; the microsporangium, which produces a large number of microspores (*pollen-grains*), is termed the *pollen-sac*.

The development of spores, except in the simpler Thallophyta, is more or less restricted to definite parts of the body. Thus in the Red Algae (Florideae) there are the organs known as *stichidia*, *nemathecia*. In the fungi the number and variety of such organs is very great; they may be described generally as simple and compound *sporophores*: but for a description the article FUNGI should be consulted. In the higher plants the organs are less various. In the Bryophyta the production of spores is restricted to the sporogonium. In the vascular plants (Pteridophyta, Phanerogams) the development of sporangia, speaking generally, is confined to the leaves. In most ferns the sporangiferous leaves (*sporophylls*) do not differ in appearance from the foliage leaves; but in other Pteridophyta (Equisetaceae, Marsiliaceae, some species of *Lycopodium* and *Selaginella*) they present considerable adaptation, and notably in the Phanerogams. In the Phanerogams the specialization is so great that the sporophylls have received special names; those which bear the microsporangia (pollen-sacs) are termed the *stamens*, and those which bear the megasporangia (ovules) are termed the *carpels*. The sporophylls are usually aggregated together on a short stem, forming a shoot that constitutes a flower.

Many terms are employed to indicate the nature of the various kinds of spores, especially among the fungi, but the endless varieties of asexual (and asexually produced) reproductive cells may be grouped under two heads—(1) *Gonidia*, (2) *Spores proper*.

The distinction between these two kinds of asexual reproductive cells is as follows.

The *gonidium* is a reproductive cell that gives rise, on germination, to an organism resembling the parent. For instance, among the algae, the "zoospore" of *Vaucheria* develops into a *Vaucheria*-plant. There is thus a close connexion between vegetative multiplication and multiplication by means of gonidia. The production of gonidia is entirely limited to the Thallophyta, and is especially marked in the fungi, though the nature of all the many kinds of reproductive cells formed in this group has not yet been fully investigated. It is, however, wanting in certain algae (Conjugatae, Fucaeeae, Characeae) and fungi (some Peronosporae and Ascomycetes).

The *spore proper* is a reproductive cell that as a rule gives rise, on germination, to an organism unlike that which produced it. For instance, the spore of a fern when it germinates gives rise, not to a fern-plant, but to a prothallium. The apparent exceptions to this rule occur only among the Thallophyta, and are explained below in the section on *Life-history*.

The true spore is developed, usually in a sporangium, after a process of division which presents certain features that call for special notice.

Observation of the process of division of the nucleus (*karyokinesis*) in plants generally has shown (for details see CYTOLOGY) that the linin-reticulum of the resting nucleus breaks up into a definite number of segments, the *chromosomes*, each of which bears a series of minute bodies, the *chromatin-disks* or *chromomeres*, consisting largely of a substance termed *chromatin*. In the ordinary *homotype* divisions of the nuclei the characteristic number of chromosomes is always observable: but when the spore-mother-cells are being formed the number of chromosomes

is reduced to one-half. This, if the number of chromosomes of the parent plant be expressed as $2x$ the number in the spore will be x . To take a concrete case: it has been observed by Guignard and others that in the early divisions taking place in the developing anther and ovule of the lily the number of chromosomes is 24 ; whereas in the later divisions which give rise to the pollen-mother-cells in the one case and to the mother-cell of the embryo-sac in the other, the number of chromosomes is only 12 . Thus the development of a spore (as distinguished from a gonidium) is always preceded by a *reducing- or heterotype-division*, a process now more generally termed *meiosis* (Farmer). The reduced number of chromosomes in the nucleus of the spore-mother-cell persists in the spore, and in all the cells of the organism to which the spore may give rise. (Meiosis is discussed below in the section on *Sexual Reproduction*.)

It should be explained that cells, to which the name "spore" has also been applied, are formed as the result of a sexual act: such are *zygospores*, *oospores*, and some *carpospores*. But these cells differ from spores proper not only in their mode of origin but also in that their nuclei contain the full double number ($2x$) of chromosomes; hence they may be distinguished as *diplospores*.

Sexual Reproduction.—Sexual reproduction involves the development of sexual organs (*gametangia*) and sexual cells (*gametes*). When the organism is unicellular, as in the lower Green Algae (e.g. Protococcaceae, Conjugatae), the cell becomes a sexual organ and its whole protoplasm gives rise to one or more sexual cells: in the higher forms certain parts of the body are specialized as sexual organs. In many of the lower plants the organs present no external distinction of sex (e.g. lower Green Algae: the Chytridiaceae, Mucorinae, and some Ascomycetes among the fungi): it is impossible to distinguish between the male and female organs, although it cannot be doubted that the essential physiological difference exists; consequently the organs are merely described as *gametangia*. The gap between these plants and those with differentiated sexual organs is, however, bridged over by intermediate forms, as explained in the article ALGAE.

When the sexual organs are more or less obviously differentiated into male and female, they present considerable variety of form in different groups of plants, and accordingly bear different names. Thus the male organ is a *pollinodium* in most of the fungi, a *spermatogonium* in others (certain Ascomycetes, Uredineae); in all other plants it is an *antheridium*. Similarly the female organ is an *oogonium* in various Thallophyta (Green and Brown Algae: Oomycetous Fungi); a *procarp* in the Red Algae; an *archicarp* in certain Ascomycetous Fungi and in the Uredineae; an *archegonium* in all the higher plants.

It is generally the case that the protoplasm of the sexual organ is differentiated into one or more sexual cells. Thus, the gametangium usually gives rise to cells which, as they are externally similar, are termed *isogametes* or simply *gametes*. Certain forms of the male organ, the spermatogonium and the antheridium, give rise to male cells which are termed *spermata* when they are non-ciliated, *spermatozooids* when they are ciliated and free-swimming. Again, the female organs termed oogonia and archegonia produce one or more female cells called *oospheres*. But there are important exceptions to this rule. Thus the protoplasm is not differentiated into cells in the gametangium of the Mucorinae; in the male organ (pollinodium), of fungi generally; and in the female organ (procarp) of the Red Algae and (archicarp) of the Ascomycetes and Uredineae.

The immediate product of the fusion of cells, or of undifferentiated protoplasm, derived from sexual organs of opposite sex may be generally termed the *zygote*; but it is not always of the same kind. Thus when two isogametes, or the undifferentiated contents of two gametangia, fuse together, the process is designated *conjugation*, and the product is usually a single cell termed *zygospore*. When an oosphere fuses with a male cell, or with the undifferentiated contents of a male organ, the process is *fertilization*, and the product is a single cell termed *oospore*. When, finally, a female organ with undifferentiated contents receives a male cell, the process again is fertilization; here the

product is not a single cell, but a fructification termed *cystocarp* (Red Algae), or *ascocarp* (Ascomycetes) or *accedium* (Uredineae), containing many spores (*carpospores*).

As a consequence of the diversity in the sexual organs and cells, in the details of the sexual act, and in the product of it, several modes of the sexual process have to be distinguished, which may be conveniently summarized as follows:—

I. *Iso gamy*: the sexual process consists in the fusion of either two similar sexual cells (*isogametes*), or two similar sexual organs (*gametangia*): it is termed conjugation, and the product is a *zygospore*. Its varieties are:—

(a) Gametes ciliated and free-swimming (*planogametes*), set free into the water where they meet and fuse: lower Green Algae (Protococaceae, Pandorineae, most Siphonaceae and Confervaceae); some Brown Algae (Phaeosporaceae);

(b) Gametangia fuse in pairs, and a gamete is differentiated in each: the gametes of each pair fuse, but are not set free and are not ciliated (the Conjugate Green Algae); or, no gametes are differentiated, the undifferentiated contents of the gametangia fusing (Mucorinaceae among the Fungi).

II. *Oogamy*: male and female organs distinct: the protoplasm of the female organ is differentiated into one (or rarely) more oospheres which usually remain enclosed in the female organ: the contents of the male organ are usually differentiated into one or more male cells: the process is fertilization, the product is an *oospore*.

(A) The sexual organs are unicellular (or coenocytic as in certain Siphonaceous Green Algae and in the Oomycetous Fungi); the female organ is an *oogonium*.

(a) The male organ is an *antheridium* giving rise to one or more free-swimming ciliated spermatozooids:

(1) The oogonium contains a single oosphere which is fertilized *in situ*: higher Green Algae (*Volvox*, *Vascheria*, *Oodogonium*, *Coleochaete*, Characeae); some Brown Algae (*Tilopteris*); among the Fungi, *Monoblepharum*, the only fungus known to have spermatozooids;

(2) The oogonium produces a single oosphere which is extruded and is fertilized in the water: *Dictyota* and some Fucaaceae (Brown Algae);

(3) The oogonium contains several oospheres which are fertilized *in situ*: *Sphaerocapsa* (Siphonaceous Green Alga);

(4) The oogonium produces more than one oosphere (2-8) which are extruded and are fertilized in the water: certain Brown Algae (*Pelvetia*, *Ascophyllum*, *Fucus*);

(β) The male organ is a *polysidium* which applies itself closely to the oogonium: the amphorous male cell is not ciliated and is not set free:

(1) The oogonium contains a single oosphere which is fertilized *in situ*: Peronosporaceae (Oomycetes);

(2) The oogonium contains several oospheres; Saprolegniaceae: but it is debated whether or not fertilization actually takes place.

(B) The male and female organs are (as a rule) multicellular; the male organ is an *antheridium*, the female an *archegonium*: the archegonium always contains a single oosphere which is fertilized *in situ*.

(a) The male cell is a free-swimming ciliated spermatozoid: the antheridium produces more than one (usually very many) spermatozooids, each of which is developed in a single cell: all Bryophyta (mosses, &c.) and Pteridophyta (ferns, &c.); the only Phanerogams in which spermatozooids have been observed are the gamospermous species *Ginkgo biloba*, *Cycas revoluta*, *Zamia integrifolia*.

(β) The male cell is amphorous and passes directly from the pollen-tube into the oosphere (*siphogamy*): all Phanerogams except the species just mentioned.

It must be explained that in the angiospermous Phanerogams, the male and female organs are so reduced that each is represented by only a single cell: the male, by the *generative cell*, formed in the pollen-grain, which usually divides into two male cells: the female, by the oosphere. The gradual reduction can be traced through the Gymnosperms.

Attention may here be drawn to the fact (see ANGIOSPERMS) that, in several cases, the second male cell has been seen to enter the embryo-sac from the pollen-tube, and its nucleus to fuse with the definitive nucleus (endosperm-nucleus) or with one of the polar nuclei. The significance of this remarkable observation is discussed in the section on the *Physiology of Reproduction*.

III. *Carpogamy*: the sexual organs are (as a rule) differentiated into male and female: the protoplasm of the unicellular or multicellular female organ (*archicarp*, *procarp*) is never differentiated into an oosphere: in many cases definite male cells, *spermatia*, are produced and are set free, but they are not ciliated, and frequently have a cell-wall: the process is *fertilization*: the product is a fructification derived essentially from the female organ con-

taining several (sometimes very many) spores (*carpospores*): characteristic of the Red Algae and of the Ascomycetous Fungi.

(A) There are definite male cells (*spermatia*):

(a) The female organ is a *procarp*, consisting of an elongated, closed, receptive filament, the *trichogyne*, and of a basal fertile portion, the *carpogonium*: on fertilization the latter grows and gives rise directly or indirectly to a *cystocarp*: the spermatia are each formed in a unicellular antheridium and have no cell-wall at first: they fuse with the tip of the trichogyne: Red Algae (Rhodophyceae or Florideae);

(β) The female organ (*archicarp*) resembles the preceding: in fertilization the fertile portion (*ascogonium*) develops into an *ascocarp* containing one or more asci (sporangia) each containing usually eight *ascospores*: the spermatia are formed by abstriction from the filaments (*sterigmata*) lining special receptacles, the *spermatogonia*, which are the male organs: certain Ascomycetous Fungi (e.g. Laboulbeniaceae, some Lichen-Fungi, *Polystigma*). For the Uredineae, see *Abnormalities of Reproduction*, below.

(B) There are no definite male cells: the more or less distinct male and female organs come into contact, and their undifferentiated contents fuse: the product is an *ascocarp*:

(a) The male and female organs are obviously distinct: the female organ is an *ascogonium*, the male a *pollinodium*: e.g. *Pyronema*, *Sphaerotheca* (Ascomycetes);

(β) The male and female organs are quite similar: e.g. *Eremascus*, *Dipodascus* (Ascomycetes).

It may be explained that carpogamy is the expression of sexual degeneration. In the cases last mentioned, when the sexual organs are quite similar, it has reverted to the condition of gametangia. Still further reduction is observable in other Ascomycetes in which one of the sexual organs, presumably the male, is either much reduced or is altogether wanting. Again in the rusts (Uredineae), there are spermatia, but they are functionless (see section on *Abnormalities of Reproduction*). In the highest Fungi, the Autobasidiomycetes, no sexual organs have been discovered.

Details of the Sexual Act.—It has been already stated that the sexual act consists in the fusion of two masses of protoplasm, commonly cells, derived from two organs of opposite sex: but this is only the first stage in the process. The second stage is the fusion of the nuclei, which usually follows quickly upon the fusion of the cells; but nuclear fusion may be postponed so that the two sexual nuclei may be observed in the zygote, as "conjugate" nuclei, and even in the cells of the organism developed from the zygote (e.g. Uredineae). The result of nuclear fusion is that the nucleus of the zygote contains the double number of chromosomes—that is, if the number of chromosomes in each of the fusing sexual nuclei be x , the number in the nucleus of the zygote will be $2x$. Moreover, this double number persists in all the cells of the organism developed from the zygote, until it is reduced to one-half by meiosis preceding either the development of the spores, or, less commonly, the development of the sexual cells. But there is yet a third stage, which consists in the temporary fusion of the chromosomes belonging to the two sexual nuclei. This always takes place as a preliminary to meiosis; it may be in the germinating zygote, or after many generations of cells have been formed from it. At the onset of meiosis the ($2x$) chromosomes are seen to be double, one of each pair having been derived from the male and the female cell respectively: the chromosomes of each pair then fuse so that their chromomeres unite along their length, constituting the *pseudo-chromosomes*. The paired chromosomes separate and eventually go to form the two daughter-nuclei, one to each, which thus have half (x) the original number of chromosomes. The daughter-nuclei at once divide homotypically, retaining the reduced (x) number of chromosomes to form the four nuclei of a tetrad of spores (more rarely, e.g. *Fucus*, of sexual cells).

III. Life-history.

It will have been gathered from the foregoing sections that plants generally are capable of both sexual and asexual reproduction; and, further, that in different stages of their life-history they possess the diploid ($2x$) number of chromosomes in their nuclei, or the haploid (x) number. It may be at once stated that, in all plants in which sexual reproduction and true meiotic spore-formation exist, these two modes of reproduction are restricted to distinct forms of the plant; the sexual form bears only the sexual organs and is haploid; the asexual form only

produces spores and is diploid. Hence all such plants are to this extent *polymorphic*—that is, the plant assumes these two forms in the course of its life-history. When, as in many Thallophyta, one or other of these forms can reproduce itself by means of gonidia, additional forms may be introduced into the life-history, which becomes the more complicated the more pronounced the polymorphism.

The most straightforward life-histories are those presented by the Bryophyta and the Pteridophyta, where there are but the two forms, the sexual and the asexual. In the life-history of a moss, the plant itself bears only sexual organs: it is the sexual form, and is distinguished as the *gametophyte*. The zygote (oospore) formed in the sexual act develops into an organism, the *sporogonium*, which is entirely asexual, producing only spores: it is distinguished as the *sporophyte*. When these spores germinate, they give rise to moss-plants. Thus the two forms, the sexual and the asexual, regularly alternate with each other—that is, the life-history presents that simple form of polymorphism which is known as *alternation of generations*. Similarly, in the life-history of a fern, there is a regular alternation of a sporophyte, which is the fern-plant itself, with a gametophyte, which is the fern-prothallium.

It is pointed out in the preceding section that, as the result of the sexual act, the nucleus of the zygote contains twice as many chromosomes as those of the fusing sexual cells. This $2x$ number of chromosomes persists throughout all the cell-generations derived from the zygote, that is, in the cells constituting the sporophyte, up to the time that it begins to produce spores, when meiosis takes place. Again, the cell-generations derived from the spore, that is, the cells constituting the gametophyte, all have the reduced x number of chromosomes in their nuclei up to the sexual act. Hence the sporophyte may also be designated the *diplophyte* and the gametophyte the *haplophyte* (Strasburger): in other words, the sporophyte is the *pre-meiotic*, the gametophyte the *post-meiotic* generation. Twice in its life-history the plant is represented by a single cell: by the spore and by the zygote. The turning-points in the life-history, the transitions from the one generation to the other, are (1) meiosis, (2) the sexual act.

The course of the life-history in Phanerogams and in those Thallophyta which have been adequately investigated is essentially the same as that of the Bryophyta and of the Pteridophyta as described above, though it is less easy to trace on account of the peculiar relation of the two generations to each other in the Phanerogams and on account of various irregularities that present themselves in the Thallophyta.

In the Phanerogams, as in the Pteridophyta, the preponderating generation is the sporophyte, the plant itself. Inasmuch as they are heterosporous, the gametophyte is represented by a male and a female organism or prothallium, both rudimentary. The male prothallium consists of the few cells formed by the germinating pollen-grain (microspore); and though it is quite independent, since the microspores are shed, it grows parasitically in the tissues upon which the microspore has been deposited in pollination. The female prothallium may consist of many cells with well-developed archegonia, as in the Gymnosperms, or of only a few cells with the female organs reduced to the oosphere, as in the Angiosperms. In either case it is the product of the germination of a megaspore (embryo-sac) which is not shed from its sporangium (ovule): hence it never becomes an independent plant, and was long regarded as merely a part of the sporophyte until its true nature was ascertained, chiefly by the researches of Hofmeister, who first explained the alternation of generations in plants. This intimate and persistent connexion between the two generations affords the explanation of the characteristic features of the Phanerogams, the seed and the flower. The ovule containing the embryo-sac, which eventually contains the embryo, persists as the seed—a structure that is distinctive of Phanerogams, which have, in fact, on this account been also termed Spermatophyta. With regard to the flower, it has been already mentioned that it is, like the cone of an Equisetum or a Lyco-

podium, a shoot adapted to the production of spores. But it is something more than this: for whereas in Equisetum or Lycopodium the function of the cone comes to an end when the spores are shed, the flower of the Phanerogam has still various functions to perform after the maturation of the spores. It is the seat of the process of *pollination*—that is, the bringing of the pollen-grain by one of various agencies into such a position that a part (the pollen-tube) of the male prothallium developed from it may reach and fertilize the oosphere in the embryo-sac. Thus the flower of Phanerogams is a reproductive shoot adapted not only for spore-production, but also for pollination, for fertilization, and for the consequences of fertilization, the production of seed and fruit. However, in spite of these complications, it is possible to determine accurately the limits of the two generations by the observation of the nuclei. The meiosis preceding the formation of the spores marks the beginning of the (haploid) gametophyte, male and female; and the sexual act marks that of the (diploid) sporophyte.

The difficult task of elucidating the life-histories of the Thallophyta has been successfully performed in certain cases by the application of the method of chromosome-counting, with the result that alternation of generations has been found to be of general occurrence. To begin with the Algae. In the Dictyotaceae (Brown Algae) there are two very similar forms in the life-history, the one bearing asexual reproductive organs (tetrasporangia), the other bearing sexual organs (oogonia and antheridia). It has been shown (Lloyd Williams) that the former is undoubtedly the sporophyte and the latter the gametophyte, since the nuclei of the former contain 32 chromosomes, and those of the latter 16. Meiosis takes place in the mother-cell of the tetraspores, which, on germination, give rise to the sexual form. Quite a different life-history has been traced in *Fucus*, another Brown Alga. Here no spores are produced: there is but one form in the life-history, the *Fucus*-plant, which bears sexual organs and has, on that account, been regarded as a gametophyte. The investigation of the nuclei has, however, shown (Farmer) that the *Fucus*-plant is actually diploid, that it is, in fact, a sporophyte; but since there is no spore-formation, meiosis immediately precedes the development of the sexual cells, which alone represent the gametophyte (see below, *Apospory*).

Similarly, two types of life-history have been discovered in the Red Algae. In *Polysiphonia violacea*, a species in which the tetraspores and the sexual organs are borne by similar but distinct individuals, it has been ascertained (Yamanouchi) that, as in *Dictyota*, meiosis takes place in the mother-cell of the tetraspores, so that the nuclei of these spores, as also those of the sexual plants to which they give rise, contain 20 chromosomes: and further, that the nuclei of the carpospores (diplospores) produced in the cystocarp as the result of fertilization, contain 40 chromosomes, as do also those of the asexual plant to which the carpospores give rise. Hence the sporophyte is represented by the cystocarp and the resulting tetrasporangiate plants: the gametophyte, by the sexual plants. Though it is the rule in the Red Algae that the tetrasporangia and the sexual organs are borne on distinct individuals, yet cases are known in which both kinds of reproductive organs are borne upon the same plant; and to those the above conclusions obviously cannot apply. They have yet to be investigated.

The second type of life-history has been traced in *Nemalion*. Here there is no tetrasporangiate form, consequently meiosis takes place at a different stage in the life-history. It has been observed (Wolfe) that the nuclei of the sexual plant contain 8 chromosomes; those of the gonimoblast-filaments of the developing cystocarp contain 16, whilst those of the carpospores contain 8: hence meiosis takes place in the carposporangia. Here the plant is the gametophyte; the sporophyte is only represented by the cystocarp. The carpospores here are true spores (haplospores).

Among the Green Algae, *Coleochaete* is the only form that has been fully investigated (Allen). Here meiosis takes place in the germinating oospore: consequently the plant is the

gametophyte, and the sporophyte is represented only by the oospore, so that the life-history resembles that of *Nemalion*. It is probable that this conclusion is generally true of the whole group; at any rate of those forms (*Desmids*, *Spirogyra*, *Oedogonium*, *Chara*) which have been more or less investigated.

Turning to the Fungi, somewhat similar results have been obtained in the few forms that have been studied from this point of view. In the sexual Ascomycetes it appears (Harper) that meiosis takes place in the Ascospore just before the development of the spores, so that the life-history essentially resembles that of *Nemalion*. Again, in certain Uredineae, having an acidium-stage and a teleutospore-stage, which is apparently a sexual process has been observed (Blackman, Christman) which is described in the section on *Abnormalities of Reproduction*, and the life-history is as follows. The sexual act having taken place, a row of acidiospores is developed in the acidium, each of which contains two conjugate nuclei derived from the sexual nuclei. The mycelium developed from the acidiospore, as well as the uredospores and the teleutospores that it bears, shows two conjugate nuclei. When, however, the teleutospore is about to germinate, the two nuclei fuse (thus completing the sexual act) and meiosis takes place. As a result the promycelium developed from the teleutospore, and the sporidia that it produces, are uninucleate: so are also the mycelium developed from the sporidium, and the female organs (archicarp) borne upon it. Hence the limits of the sporophyte are the acidiospore and the teleutospore: those of the gametophyte, the teleutospore and the acidiospore.

Similar observations have been made upon other Uredineae with a more contracted life-history. *Phragmidium Potentillae-canadensis* is a rust that has no acidium-stage: consequently the primary uredospores are borne by the mycelium produced on infection of the host by a sporidium. It has been observed (Christman) that the sporogenous hyphae fuse in pairs, suggesting a sexual act; then the primary uredospores are developed in rows from the fused pairs of hyphae which thus behave as sexual organs (archicarp), and each such uredospore contains two conjugate nuclei. Although the research has not been carried beyond this point, it may be inferred that in this case, as in the preceding, nuclear fusion and meiosis take place in the teleutospore. Here the sporophyte is represented by the uredo-form.

Finally, in some of the fungi in which no sexual organs have yet been discovered, this method of investigation has made it probable that some kind of sexual act takes place nevertheless. Thus in the Uredine *Puccinia malvacearum*, which has only teleutospore- and sporidium-stages, it has been observed (Blackman) that the formation of the teleutospores is preceded by a binucleate condition of the hyphae. The same idea is suggested by the binucleate basidia of the Basidiomycetes, which correspond to the teleutospores of the Uredineae.

The life-histories sketched in the preceding paragraphs show that one of the complexities met with in the Thallophyta is that meiosis does not always take place at the same point in the life-history. In the higher plants the incidence of meiosis is generally, though not absolutely, constant: it may be stated as a rule that in the Bryophyta, Pteridophyta and Phanerogams it takes place in the spore-mother-cells. In the Thallophyta this rule does not hold. In some of them, it is true, meiosis immediately precedes, as in the higher plants, the formation of certain spores, the tetraspores (*Dictyotaceae*, *Polysiphonia*), the teleutospores (Uredineae): but in others it immediately precedes the development of the sexual organs (*Fucaeae*), or follows more or less directly upon the sexual act (*Green Algae*, *Nemalion*, *Ascomycetes*).

The life-history of most Thallophyta is further complicated by the capacity of the gametophyte of the sporophyte to reproduce themselves by cells termed gonidia, a capacity that is wholly lacking in the higher plants. The karyology of gonidia has not yet been sufficiently investigated: but when, as in the *Green Algae* and the *Oomycetous Fungi*, the gonidia are developed

by and reproduce the gametophyte, it may be inferred that they, like the gametophyte, are haploid. One case, at any rate, of the reproduction of the sporophyte by gonidia is fully known, that of the Uredineae just described, in which the uredo-form, which is a phase of the sporophyte, is reproduced by the uredo-spores which are binucleate, that is diploid, and may be distinguished as *diplogonidia*. In any case the result is that whereas in the higher plants each of the alternating generations occurs but once in the life-history, in these Thallophyta the life-history may include a succession of gametophytic or of sporophytic forms. This is, in fact, a distinguishing feature of the group. The higher plants present a regular alternation of generations: whereas, in the Thallophyta, though they probably all present some kind of alternation of generations, yet it is irregular in the various ways and for the various reasons mentioned above.

Sufficient information has been given in the preceding pages to render possible the consideration of the origin of alternation of generations. To begin quite at the beginning, it may be assumed that the primitive form of reproduction was purely vegetative, merely division of the unicellular organism when it had attained the limits of its own growth. Following on this came reproduction by a gonidium: that is, the protoplasm of the cell, at the end of its vegetative life, became quiescent, surrounded itself with a proper wall, or was set free as a motile ciliated cell, having in some unexplained way become capable of originating a new course of life (*rejuvenescence*) on germination. Then, as can be well traced in the Brown and Green Algae (see ALGAE), these primitive reproductive cells (gonidia) began to fuse in pairs: in other words, they gradually became sexual. This stage can still be observed in some of these Algae (*e.g.* *Ulothrix*, *Ectocarpus*) where the zoospores (gonidia) may either germinate independently, or fuse in pairs to form a zygote. Gradually the sexuality of these cells became more pronounced: losing the capacity for independent germination, they acquired the external characters of more or less differentiated sexual cells, and the gametangia producing them developed into male and female sexual organs. But this advancing sexual differentiation did not necessarily deprive the plant of the primitive mode of propagation: the sexual organism still retained the faculty of reproduction by gonidia. The loss of this faculty only came with higher development: it is entirely wanting in some of the higher Thallophyta (*e.g.* *Fucaeae*, *Characeae*), and in all plants above them in the evolutionary series.

With the introduction of the sexual act, a new kind of reproductive cell made its appearance, the zygote. This cell, as already explained, differs from other kinds of spores and from the sexual cells, in that its nucleus is diploid; and with it the sporophyte (diplophyte) was introduced into the life-history. It has been mentioned that in some plants (*e.g.* *Green Algae*) the zygote is all that there is to represent the sporophyte, giving rise, or germination and after meiosis, to one or more spores. Passing to the Bryophyta, in the simpler forms (*e.g.* *Riccia*), the zygote develops into a multicellular capsule (sporogonium); and in the higher forms into a more elaborate sporogonium, producing many spores. In the Pteridophyta and the Phanerogams, the zygote gives rise to the highly developed sporophytic plant.

Thus the evolution of the sporophyte can be traced from the unicellular zygote, gradually increasing in bulk and in independence until it becomes the equal of the gametophyte (*e.g.* in *Dictyota* and *Polysiphonia*), and eventually far surpasses it (Pteridophyta, Phanerogams). Moreover, the increase in size was attended by the gradual limitation of spore-production to certain parts only, the rest of the tissues being vegetative, assuming the form of stems, leaves, &c. These facts have been formulated in the theory of "progressive sterilization" (Bower), which states that the sporophytic form of the higher plants has been evolved from the simple, entirely fertile, sporophyte of the lower, by the gradually increasing development of the sterile vegetative tissue at the expense of the sporogenous, accompanied by increase in total bulk and in morphological and histological differentiation.

In connexion with the study of the evolution of the sporophyte,

the question arose as to its morphological significance; whether it is to be regarded as a modified form of the gametophyte, or as an altogether new form intercalated in the life-history: in other words, whether the alternation is "homologous" or "antithetic." In certain plants there is a succession of forms which are undoubtedly homologous: for instance, in *Coleochaete* where a succession of individuals without sexual organs is produced by zoospores (gonidia). The main fact that has been established is that the sporophyte, from the simple zygote of the Thallophyta to the spore-bearing plant of the Phanerogams, is characterized by its diploid nuclei; that it is a diplophyte, in contrast to the haplophytic gametophyte. Were these nuclear characters absolutely universal, there could be no question but that the sporophyte is an altogether new antithetic form, and not an homologous generation. But certain exceptions to the rule have been detected, which are described under *Abnormalities of Reproduction*: at present it will suffice to say that such things as a diploid gametophyte and a haploid sporophyte have been observed in certain ferns. It can only be inferred that alternation of generations is not absolutely dependent upon the periodic halving in meiosis and the subsequent doubling by a sexual act, of the number of chromosomes in the nuclei, though the two sets of phenomena usually coincide. It must not, however, be overlooked that these exceptional cases occur in plants presenting an abnormal life-history: the fact remains that where there is both normal spore-formation with meiosis, and a subsequent sexual act, the haploid form is the gametophyte, the diploid the sporophyte. But the actual observation of a haploid sporophyte and of a diploid gametophyte makes it clear that however generally useful the nuclear characters may be in the distinction of sporophyte and gametophyte, they do not afford an absolute criterion, and therefore their value in determining homologies is debatable.

IV. Abnormalities of Reproduction.

In what may be regarded as the type of normal life-history, the transition from the one generation to the other is marked by definite processes: there is the meiotic development of spores by the sporophyte, and the sexual production of a zygote, or something analogous to it, by the gametophyte. But it has been mentioned in the preceding pages that the transition may, in certain cases, be effected in other ways, which may be regarded as abnormal, though they are constant enough in the plants in which they occur, in fact as manifestations of reproductive degeneration.

In the first place, the sporophyte may be developed either after an abnormal sexual act, or without any preceding sexual act at all, a condition known as *apogamy*. In the second, the gametophyte may be developed otherwise than from a post-meiotic spore, a condition known as *apospory*.

APOGAMY.—The cases to be considered under this head may be arranged in two groups:—

1. *Pseudapogamy: sexual act abnormal.*—The following abnormalities have been observed:—

- Fusion of two female organs: observed (Christman) in certain Uredineae (*Caecoma nitens*, *Phragmidium speciosum*, *Uromyces Caladii*) where adjacent archicarpus fuse: male cells (spermatia) are present, but functionless.
- Fusion between nuclei of the same female organ: observed in the ascogonium of certain Ascomycetes, *Humaria granulata* (Blackman), where there is no male organ; *Lachnea stercorea* (Fraser), where the male organ (pollinodium) is present but is apparently functionless.
- Fusion of a female organ with an adjacent tissue-cell: observed (Blackman) in the archicarp of some Uredineae (*Phragmidium violaceum*, *Uromyces Poae*, *Puccinia Poarum*): male cells (spermatia) present but functionless.
- There is no female organ: fusion takes place between two adjacent tissue-cells of the gametophyte; the sporophyte is developed from diploid cells thus produced, but there is no proper zygote as there is *a, b, and c*: observed (Farmer) in the prothallium of certain ferns (*Lastraea pseudo-mas*, var. *polydactyla*): male organs (and sometimes female) present but functionless. Another such case is that of *Humaria rutilans* (Ascomycete), in which nuclear fusion has been observed (Fraser) in hyphae of the hypothecium: the asci are developed from these hyphae, and in them meiosis takes place; there are no sexual organs.

2. *Eu-apogamy: no kind of sexual act*—

- The gametophyte is haploid:
 - The sporophyte is developed from the unfertilized oosphere: no such case of *true parthenogenesis* has yet been observed.
 - The sporophyte is developed vegetatively from the gametophyte and is haploid: observed in the prothallium of certain ferns, *Lastraea pseudo-mas*, var. *crisitata-apospora* (Farmer and Digby), and *Nephrodium molle* (Yamanouchi).
- The gametophyte is diploid (see under *Apogamy*):
 - The sporophyte is developed from the diploid oosphere: observed in some Pteridophyta, viz. certain ferns (Farmer), *Athyrium Filix-foemina*, var. *clarissima*, *Scolopendrium vulgare*, var. *crispum-Drummondiae*, and *Marsilia* (Strasburger); also in some Phanerogams, viz. Compositae (*Taraxacum*, Murbeck; *Antennaria alpina*, Juel; sp. of *Hieracium* (Rosenberg); Rosaceae; *Eu-Alchemilla* sp., Murbeck, Strasburger); Ranunculaceae (*Thalictrum purpurascens*, Overton).
 - The sporophyte is developed vegetatively from the gametophyte: observed (Farmer) in the fern *Athyrium Filix-foemina*, var. *clarissima*.

In all the cases enumerated under *Eu-apogamy*, apogamy is associated with some form of apospory except *Nephrodium molle*, full details of which have not yet been published.

Many other ferns are known to be apogamous, but they are not included here because the details of their nuclear structure have not been investigated.

APOSPORY.—The known modes of apospory may be arranged as follows:—

- Pseudapospory: a spore is formed but without meiosis, so that it is diploid*—observed only in heterosporous plants, viz. certain species of *Marsilia* (e.g. *Marsilia Drummondii*) where the megaspore has a diploid nucleus (32 chromosomes) and the resulting prothallium and female organs are also diploid (Strasburger); and in various Phanerogams, some Compositae (*Taraxacum* and *Antennaria alpina*, Juel), some Rosaceae (*Eu-Alchemilla*, Strasburger), and occasionally in *Thalictrum purpurascens* (Overton), where the megaspore (embryosac) is diploid; in some species of *Hieracium* it has been found (Rosenberg) that adventitious diploid embryo-sacs are developed in the nucellus: these plants are also apogamous.
- Eu-apospory: no spore is formed*—of this there are two varieties:—

(a) With meiosis: this occurs in some Thallophyta which form no spores; the sporophyte of the Fucaceae bears no spores, consequently meiosis takes place in the developing sexual organs; the Conjugate Green Algae also have no spores, meiosis taking place in the germinating zygospore which develops directly into the sexual plant.

(b) Without meiosis: the gametophyte is developed upon the sporophyte by budding; that is, spore-reproduction is replaced by a vegetative process: for instance, in mosses it has been found possible to induce the development of protonema, the first stage of the gametophyte, from tissue-cells of the sporogonium: similarly in certain ferns (varieties of *Athyrium Filix-foemina*, *Scolopendrium vulgare*, *Lastraea pseudo-mas*, *Polystichum angulare*, and in the species *Pteris aquilina* and *Asplenium dimorphum*), the gametophyte (prothallium) is developed by budding on the leaf of the sporophyte, and in some of these cases it has been ascertained that the gametophyte so developed has the same number (2x) of chromosomes in its nuclei as the sporophyte that bears it—that is, it is diploid.

Apogamy has been found to be frequently associated with apogamy; in fact, in the absence of meiosis, this association would appear to be inevitable.

Combined Apogamy and Apogamy.—Instances have been given of the occurrence of both apogamy and apogamy in the same life-history; but in all of them there is a regular succession of sporophyte and gametophyte. The cases now to be considered are those in which one or other of the generations gives rise directly to its like, sporophyte to sporophyte, gametophyte to gametophyte, the normally intervening generation being omitted.

It is possible to conceive of this abbreviation of the life-history taking place in various ways. Thus, a sporophyte might be developed from a haploid spore instead of a gametophyte as is the normal case, but this has not been observed: again, a sporophyte might be developed from a diploid spore (as distinguished from a zygote or a diploid oosphere), a possibility that is to some extent realized in the life-history of some Uredineae in which successive forms of the polymorphic sporophyte are developed from diplogonia. Similarly a gametophyte might be developed from a fertilized or an unfertilized

female cell: the latter possibility is to some extent realized in those Algae (e.g. *Ulothrix*, *Ectocarpus*) in which the sexual cells (isogametes), if they fail to conjugate, germinate independently as gonidia, giving rise to gametophytes.

The more familiar mode is that of vegetative budding, as already mentioned. When a "viviparous" fern or Phanerogam reproduces itself by a bud or a bulbil, both spore-formation and the sexual act are passed over: sporophyte springs from sporophyte. Remarkable cases of this have been observed in certain Phanerogams (*Coleobogyne ikeifolia*, *Funkia ovata*, *Nothoscordum fragrans*, *Citrus*, sp. of *Eunymus*, *Opuntia vulgaris*) in the ovule of which adventitious embryos are formed by budding from cells of the nucellus: with the exception of *Coleobogyne*, it appears that this only takes place after the oosphere has been fertilized. In other plants it is the gametophyte that reproduces itself by means of gemmae or bulbils, as commonly in the Bryophyta, the prothallia of ferns, &c.

The abnormalities described are all traceable to reproductive degeneration; the final result of which is that true reproduction is replaced more or less completely by vegetative propagation. It may be inquired whether degeneration may have proceeded so far in any plant of sufficiently high organization to present spore-formation, or sexual reproduction, or both, as to cause the plant to reproduce itself entirely and exclusively by the vegetative method. The only such case that suggests itself is that of *Caulerpa* and possibly some other Siphonocera Green Algae. In this plant no special reproductive organs have yet been discovered, and it certainly reproduces itself by the breaking off of portions of the body which become complete plants: but it is quite possible that reproductive organs may yet be discovered.

V. Physiology of Reproduction.

The reproductive capacity of plants, as of animals, depends upon the fact that the whole or part of the protoplasm of the individual can develop into one or more new organisms in one or other of several possible ways. Thus, in the case of unicellular plants, the whole of the protoplasm of the parent gives rise, whether by simple division or otherwise, to one or more new plants. Reproduction necessarily closes the life of the individual: here, as August Weismann long ago pointed out, there is no natural death, for the whole of the protoplasm of the parent continues to live in the progeny. In multicellular plants, on the contrary, the reproductive function is mainly discharged by certain parts of the body, the reproductive organs, the remainder of the body being essentially vegetative—that is, concerned with the maintenance of the individual. In these plants it is only a part of the protoplasm that continues to live in their progeny; the remainder, the vegetative part, eventually dies. It is therefore possible to distinguish in them, on the one hand, the essentially reproductive protoplasm, which may be designated by Weismann's term *germ-plasm*, though without necessarily adopting all that his use of it implies, and the essentially vegetative, mortal protoplasm, the *somatoplasm*, on the other. In the unicellular plant no such distinction can be drawn, for the whole of the protoplasm is concerned in reproduction. But even in the most highly organized multicellular plant this distinction is not absolute: for, as already explained, plants can, in general, be propagated by the isolation of almost any part of the body, that is vegetatively, and this implies the presence of germ-plasm elsewhere than in the special reproductive organs.

If the attempt be made to distinguish between the organs of vegetative propagation and those of true reproduction, the nearest approach would be the statement that the former contain both germ-plasm and somatoplasm, whereas the latter, or at least the reproductive cells, consist entirely of germ-plasm.

The question now arises as to the exact seat of the germ-plasm, and the answer is to be looked for in the results of the numerous researches into the structure and development of the reproductive cells that form so large a part of the biological work of recent years. The various facts already mentioned suffice to prove

that the nucleus plays the leading part in the reproductive processes of whatever kind: the general conclusion is justified that no reproductive cell can develop into a new organism if deprived of its nucleus. It may be inferred that the nucleus either actually contains the germ-plasm, or that it controls and directs the activities of the germ-plasm present in the cell. It is not improbable that both these inferences may be true. At any rate there is no sufficient ground for excluding the co-operation of the cytoplasm, especially of that part of it distinguished as *kinoplasm*, in the reproductive processes.

Pursuing the ascertained facts with regard to the nucleus, it is established that the part of it especially concerned is the linin-network which consists of the chromosomes. The behaviour, as already described, of the chromosomes in the various reproductive processes has led to the conclusion that the hereditary characters of the parent or parents are transmitted in and by them to the progeny: that they constitute, in fact, the material basis of heredity (see HEREDITY). They can hardly, however, be regarded as the ultimate structural units, for the simple reason that their number is far too small in relation to the transmissible characters. It has been suggested (Farmer) that the chromomeres are the units, but the number of these would seem to be hardly sufficient. It seems necessary to fall back upon hypothetical ultimate particles, as suggested by Darwin, de Vries and Weismann, which may be generally termed *pangens*. The chromomeres may be regarded as aggregates of such particles, the "ids" of Weismann.

The foregoing considerations make it possible to attempt an explanation of the various reproductive processes.

Vegetative Propagation.—It is easily intelligible that the two individuals produced by the division of a unicellular plant should resemble the parent and each other; for, the division of the parent-nucleus being homotypic, the chromosomes which go to constitute the nucleus of each daughter-cell are alike both in number and in nature, and exactly repeat the constitution of the parent-nucleus.

In the more complicated cases of propagation by bulbils, cuttings, &c., the development of the new individual, or of the missing parts of the individual (roots, &c.), may be ascribed to the presence in the bulbil or cutting of the necessary pangens.

Reproduction by Gonidia.—In this case a single cell gives rise to a complete new organism resembling the parent. The inference is that the gonidium is a portion of the parental germ-plasm, in which all the necessary pangens have been accumulated.

Reproduction by Spores.—In this case, also, an entire organism is developed from a single cell, but with this peculiarity that the resulting organism is unlike that which bore the spore, a peculiarity which has not yet been explained. It has been already stated that the development of true spores involves meiosis, and this process is no doubt related to the behaviour of the spore on germination; but the nature of this relation remains obscure. It might be assumed that, as the result of meiosis, the nucleus of the spore receives only gametophytic pangens. But the assumption is rendered impossible by the fact that the spore gives rise to a sexual organism, the reproductive cells of which, after the sexual act, produce a sporophyte. Clearly sporophytic pangens must be present as well in the spore as in the gametophyte and in its sexual cells. It can only be surmised that they exist there in a latent condition, dominated, as it were, by the gametophytic pangens.

Sexual Reproduction.—Here, again, as yet unanswered questions present themselves. The essence of a sexual cell is that it cannot give rise by itself to a new organism, it is only truly reproductive after the sexual act; this peculiarity is just what constitutes its *sexuality*. Minute investigation has not yet detected any essential structural difference between a sexual cell and a spore; on the contrary, the results so far obtained have established that they essentially agree in being post-meiotic (haploid). Why then do they differ so fundamentally in their reproductive capacities? Again, sexual cells differ in sex; but there are as yet no facts to demonstrate any essential structural difference between male

and female cells. What is known about them tends to prove their structural similarity rather than their difference. But it is possible that their difference may be chemical, and so not to be detected by the microscope.

The normal *sexual act* has been described as consisting in the fusion, first, of two cells, then of their nuclei, and finally, often after a long interval, of their chromosomes and of their chromeres in meiosis. What causes determined these fusions is a question that is only partly answered. It is known in certain cases (e.g. ferns and mosses) that the male cell is attracted to the female by chemical substances secreted for the purpose by the female organ; that it is a case of *chemiotaxis*. Probably this is more common than experiment has yet shown it to be. It is quite conceivable that the consequent cell-fusion, as also the subsequent fusions of nuclei and of chromosomes, are likewise cases of chemiotaxis, depending upon chemical differences between the fusing structures.

The sexual process can only take place between cells which are related to each other in a certain degree (see *HYBRIDISM*); that is, it depends upon *sexual affinity*. It is the general rule that it takes place between cells derived from different individuals of the same species; that is, *cross-fertilization* is the rule. This is necessarily the case when the male and female organs are developed upon different individuals, when the plant is said to be *dioecious*. When both kinds of organs are developed upon the same individual (*monoecious*), self-fertilization may and often does occur; but it is commonly hindered by various special arrangements, of which *dichogamy* is the most common; that is, that the male and female organs are not mature at the same time. But though these arrangements favour cross-fertilization, they do not absolutely prevent self-fertilization. In some cases, *cleistogamic* flowers, for instance, self-fertilization alone is possible (see *ANGIOSPERMS*). The general conclusion is that though cross-fertilization is the more advantageous form of sexual reproduction, still self-fertilization is more advantageous to the species than no fertilization at all.

In considering this subject, it must be borne in mind that the terms used have different meanings when applied to certain heterosporous plants from those which they convey when applied to isosporous plants. In the latter cases their meaning is direct and simple: in the former it is indirect and somewhat complicated. In heterosporous plants generally the actual sexual organs are never borne upon the same individual, there is always necessarily a male and a female gametophyte; so that, strictly speaking, self-fertilization is impossible. But in the Phanerogams, where there is a process preliminary to fertilization, that of *pollination*, which is unknown in other plants, the terms and the conceptions expressed by them are applied, not to the real sexual organs, but to the spores. Thus a dioecious Phanerogam is one in which the microspores are developed by one individual, the megaspores by another; and again, self-fertilization is said to occur when the microspores (pollen) fall upon the stigma of the same flower (see *ANGIOSPERMS*); but this is really only *self-pollination*.

To return to the sexual process itself. Whatever its nature, two sets of results follow upon the sexual act—(1) a zygote is formed, which is capable of developing into a new organism; from two cells, neither of which could so develop; (2) the hereditary sporophytic characters of the two parents are possessed by the organism so developed. These two results will now be considered in some detail.

(1) *The Relation between the Sexual Act and Reproductive Capacity*.—In the early days of the discovery of the sexual process, it was thought that the capacity for development imparted to the female cell was to be attributed to the doubling of its nuclear substance by the fusion with the male cell. Reproductive capacity does not, however, depend upon the bulk of the nuclear substance, for a spore, like an unfertilized female cell, contains but the x number of chromosomes, and yet it can give rise to a new organism. Again, it has been observed (Winkler) that a non-nucleated fragment of an oosphere of *Cystoseira* (Fucaeeae) can be "fertilized" by a spermatozoid and will then grow and

divide to form a small embryo, though it necessarily contains only the x number of chromosomes. From this it would appear that some stimulating influence had been exerted by the male cell, and it is probably in this direction that the desired explanation is to be sought. Some important confirmatory facts have been recorded with regard to certain animals (sea-urchins). It has been observed (Loeb) that treatment with magnesium chloride will cause the ova to grow and segment; and similar results have been obtained (Winkler) by treating the ova with a watery extract of the male cells. Hence it may be inferred that the male cell carries with it, either in its cytoplasm (kinoplasm), or in its nucleus, extractable substances, perhaps of the nature of enzymes, that stimulate the female cell to growth.

It may be mentioned that the stimulating effect of fertilization is not necessarily confined to the female cell; very frequently adjacent tissues are stimulated to growth and structural change. In a Phanerogam, for instance, the whole ovule grows and develops into the seed: the development of endosperm in the embryo-sac is initiated by another nuclear fusion, taking place between the second male nucleus and the endosperm-nucleus: the ovary, too, grows to form the fruit, which may be dry and hard or more or less succulent: the stimulating effect may extend to other parts of the flower; to the perianth, as in the mulberry; to the receptacle, as in the strawberry and the apple; or even beyond the flower to the axis of the inflorescence, as in the fig and the pine-apple. Analogous developments in other groups are the calyptra of the Bryophyta, the cystocarps of the Red Algae, the ascocarps of the Ascomycetes, the aecidia of the Uredineae, &c.

(2) *The Relation of the Sexual Act to Heredity*.—The product of the sexual act is essentially a diploid cell, the zygote, which actually is or gives rise to a sporophyte. The sexual heredity of plants consequently presents the peculiar feature that the organism resulting from the sexual act is quite unlike its immediate parents, which are both gametophytes. But it is clear that the sporophytic characters must have persisted, though in a latent condition, through the gametophyte, to manifest themselves in the organism developed from the zygote.

The real question at issue is as to the exact means by which these characters are transmitted and combined in the sexual act. There is a considerable amount of evidence that the hereditary characters are associated with the chromeres, and that it is rather their linin-constituent than their chromatin which is functional (Strasburger): that they constitute, in fact, the material basis of heredity. From this point of view it is probable that the last phase of the sexual act, the fusion of the chromeres in meiosis, represents the combination of the two sets of parental characters. What exactly happens in the pseudo-chromosome stage is not known; at any rate this stage offers an opportunity for a complete redistribution of the substance of the chromeres—in other words, of the parental pangens. It is a striking fact that, in the subsequent nuclear division, the distribution of the chromosomes derived from the male and female parents (when they can be distinguished) seems to be a matter of indifference: they are not equally distributed to the two daughter-nuclei. The explanation would appear to be this, that they are not any longer male and female as they were before meiotic fusion; and that it is because they now contain both male and female nuclear substance that their equal distribution to the daughter-nuclei is unimportant.

The nature of this redistribution of the substance of the chromeres is still under discussion. Some regard it as essentially a chemical process, resulting in the formation of new compounds: others consider it to be rather a physical process, a new material system being formed in the rearrangement of the pangens; here it must be left for the present.

The various ways in which the parental characters manifest themselves in the progeny are fully dealt with in the articles *HEREDITY*, *HYBRIDISM*, *MENDELISM*. It will suffice to say that the progeny, though maintaining generally the characters of the species, do not necessarily exactly resemble either of the parents, nor do they necessarily present exactly intermediate characters:

they may vary more or less from the type. It is an interesting fact, the full significance of which has not yet been worked out, that, as a rule, plants that vary profusely are those in which the characteristic $2x$ number of chromosomes is high (60-100).

Brief reference may be made to the cases of abnormal sexual or pseudo-sexual reproduction described above under *Apogamy*. Taking first the cases of true apogamy, there is clearly no need for any sexual process, for, since no meiotic division has taken place, the gametophyte is diploid; its cells, whether vegetative or contained in female organs, possess the capacity for both development and the transmission of the sporophytic characters. It is not remarkable that such a gametophyte should be able to give rise directly to a sporophyte; it is remarkable, in the converse case of apospory, that a sporophyte should give rise to a diploid gametophyte rather than to another sporophyte. In the latter case the tendency to the regular development of the alternate form appears to override the influence of the diploid nucleus.

Turning to the various forms of pseudo-apogamy, there are first those in which fusion takes place between two apparently female organs (some Uredineae; Christman), and those in which it takes place between nuclei within the same female organ (*Humaria*; Blackman). If these are to be regarded physiologically as sexual acts, it must be inferred that the fusing organs or nuclei have come to differ from each other to some extent; for it is unthinkable that equivalent female organs or cells should be able to fertilize, or to be fertilized by, one another. There are finally those cases in which apparently vegetative cells take part in the sexual act, as in *Phragmidium* (Blackman), where the female organ fuses with an adjacent vegetative cell, and in the fern-prothallium (Farmer), where the nuclei of two vegetative cells fuse. They would seem to indicate that vegetative cells may, in certain circumstances, contain sufficient germ-plasm to act as sexual organs without being differentiated as such.

An interesting question is that of the origin of apogamy. It is no doubt the outcome of sexual degeneration; but this general statement requires some explanation. In certain cases apogamy seems to be the result of the degeneration of the male organ; as in *Humaria*, where there is no male organ, and in *Lachnea*, where the male organ is rudimentary. In others, as in the Uredineae, it is apparently the female organ that has degenerated, losing its receptive part, the trichogyne; the male cells (spermatia) are developed normally, and there is no reason to believe that they might not fertilize the female organ were there the means of penetrating it. In yet other cases the degeneration occurs at a different stage in the life-history, in the development of the spores. In the apogamous ferns investigated, meiosis is suppressed and apogamy results. In the heterosporous plants which have been investigated (e.g. *Marsilia*, *Eu-Alchemilla*) it has been observed that the microspores are so imperfectly developed as to be incapable of germinating, so that fertilization is impossible; and it is perhaps to this that the occurrence of apogamy is to be attributed. This abnormal development of the spores may be regarded as a variation; and in most cases it occurs in plants that are highly variable and often have a high $2x$ number of chromosomes.

It will be observed that such physiological explanation as can be given of the phenomena of reproduction is based upon the results of the minute investigation of the changes in nuclear structure associated with them. The explanation is often rather suggested than proved, and some fundamental facts still remain altogether unexplained. But it may be anticipated that a method of research which has already so successfully justified itself will not fail in the future to elucidate what still remains obscure.

BIBLIOGRAPHY.—This article should be read in connexion with the following: ALGAE, ANGIOSPERMS, BRYOPHYTES, CYTOLOGY, FUNGI, GYMNO-SPERMS, HEREDIT, HYBRIDISM, MENDELISM, PLANTS, FRUITBODIES.

As the bibliographies for these articles include all the publications containing the facts and theories mentioned here, it will suffice to append only a few papers of general importance: Blackman and

Fraser. "Further Studies on the Sexuality of the Uredineae," *Ann. Bot.* (1906) vol. xx.; Farmer, "On the Structural Constituents of the Nucleus, and their Relation to the Organization of the Individual" (Croonian Lecture), *Proc. Roy. Soc.* (1907) vol. 79, series B.; Farmer and Digby, "Studies in Apospory and Apogamy in Ferns," *Ann. Bot.* (1907) vol. xxi.; Strasburger, *Die Stofflichen Grundlagen der Vererbung* (1905); "Apogamie bei *Marsilia*," *Flora* (1907), vol. 97; D. M. Mottier, *Fecundation in Plants* (1904), Carnegie Institution, Washington. (S. H. V.*)

REPRODUCTIVE SYSTEM, IN ANATOMY.—The reproductive system in some parts of its course shares structures in common with the urinary system (*q.v.*). In this article the following structures will be dealt with. In the male the testes, epididymis, vasa deferentia, vesiculae seminales, prostate, penis and urethra. In the female the ovaries, Fallopian tubes, uterus, vagina and vulva.

Male Reproductive Organs.

The *testes* or *testicles* are the glands in which the male reproductive cells are formed. They lie, one on each side, in the scrotum surrounded by the tunica vaginalis (see COELOM and SEROUS MEMBRANES). Each is an oval gland about one and a half inches long with its long axis directed downward, backward and inward. There is a strong fibrous coat called the *tunica albuginea*, from which vertical and horizontal septa penetrate into the substance, thus dividing it into compartments or lobules in which the seminiferous tubes are coiled. It is estimated that the total length of these seminiferous tubes in the two glands is little short of a mile. (See fig. 1.)

At the posterior part of the testis the fibrous sheath is greatly thickened to form the *mediastinum testis*, and contains a plexus of tubules called the *rete testis* (see fig. 1), into which the seminiferous tubes open. In this way the secretion of the gland is carried to its upper and back part, whence from fifteen to twenty small tubes (*vasa efferentia*) pass to the epididymis. Each of these is convoluted before opening, and forms what is known as a *conus vasculosus*.

Under the microscope the seminiferous tubules are seen to consist of a basement membrane surrounding several layers of epithelial cells, some of which are constantly being transformed into spermatozoa or male sexual cells.

The *epididymis* (see fig. 1) is a soft body lying behind the testis; it is enlarged above to form the *globus major* or head, while below is a lesser swelling, the *globus minor* or tail. The whole epididymis is made up of a convoluted tube about 20 ft. long, from which one long diverticulum (*vas aberrans*) comes off. Between the *globus major* and the testis two small vesicles called the *hydatis of Morgagni* are often found.

The *vas deferens* is the continuation of the tube of the epididymis and starts at the *globus minor*; at first it is convoluted, but soon becomes straight, and runs up on the inner (mesial) side of the epididymis to the external abdominal ring in the abdominal wall. On its way up it is joined by several other structures, to form the *spermatic cord*; these are the artery (spermatic) and veins (*pampiniform plexus*) of the testis, the artery of the vas, the ilio-inguinal, genito-crural and sympathetic nerves, and the testicular lymphatics. After entering the external abdominal ring, these structures pass obliquely through the abdominal wall, lying in the inguinal canal for an inch and a half, until the internal abdominal ring is reached. Here they separate and the vas passes down the side of the pelvis and turns

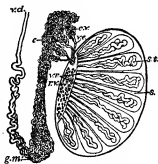

From A. F. Dixon, Cunningham's *Test-book of Anatomy*.

FIG. 1.—Diagram to illustrate the structure of the testis and epididymis.

c.v. Conus vasculosus. s.s. Seminiferous tubule.
g.m. Globus major. v.d. Vas deferens.
g.m. Globus minor. v.e. Vas efferens.
r. Rete testis. t.t. Tubuli recti.
s. Septula testis.

inward to meet its fellow at the back of the bladder, just above the prostate. The whole length of the vas is 12 to 18 in. and it is remarkable for the great thickness of its muscular walls, which gives it the feeling of a piece of whipcord when rolled between the finger and thumb.

A little above the globus major a few scattered tubules are found in children in front of the cord; these form the rudimentary structure known as the *organ of Giraldo* or *paradidymis*. As the vas deferens approaches the prostate it enlarges and becomes slightly sacculated to act as a reservoir for the secretion of the testis; this part is the *ampulla* (see fig. 2).

and run, side by side, through the prostate to open into the floor of the prostatic urethra.

The *prostate* is partly a muscular and partly a glandular structure, situated just below the bladder and traversed by the urethra; it is of a somewhat conical form with the base upward in contact with the bladder. Both vertically and transversely it measures about an inch and a quarter, while antero-posteriorly it is only about three-quarters of an inch, though its size is liable to great variation. It is enclosed in a fibrous capsule from which it is separated by the *prostatic plexus of veins* anteriorly. It is often described as formed of three lobes two lateral and a median or posterior, but careful sections and recent research throw doubt on the existence of the last.

Microscopically the prostate consists of masses of long, slender, slightly branching glands, embedded in unstripped muscle and fibrous tissue; these glands open by delicate ducts (about twenty in number) into the prostatic urethra, which will be described later. In the anterior part of the gland are seen bundles of striped muscle fibres, which are of interest when the comparative anatomy of the gland is studied; they are better seen in young than in old prostates.

The *male urethra* begins at the bladder and runs through the prostate and perineum to the penis, which it traverses as far as the tip. It is divided into a prostatic, membranous and spongy part, and is altogether about 8 inches in length.

The *prostatic urethra* runs downward through the prostate rather nearer the anterior than the posterior part. It is about an inch and a quarter long, and in the middle of the gland it bends forward forming an angle (see fig. 5); here it is from a third to half an inch wide, though at the base and apex of the prostate it is narrower. When it is slit open from in front a longitudinal ridge is seen in its posterior wall, which is called the *verumontanum* or *crista urethra*, and on each side of this is a longitudinal depression, the *prostatic sinus*, into which numerous ducts of the prostate open, though some of them open on to the antero-lateral surface. Near the lower part of the verumontanum is a little pouch, the *utriculus masculinus*, about one-eighth of an inch deep, the opening of which is guarded by a delicate membranous circular fold, the *male hymen*. Close to the opening of the utriculus the ejaculatory ducts, already mentioned, open into the urethra by very small apertures. The part of the urethra above the openings of these ducts really belongs to the urinary system only, though it is convenient to describe it here. After leaving

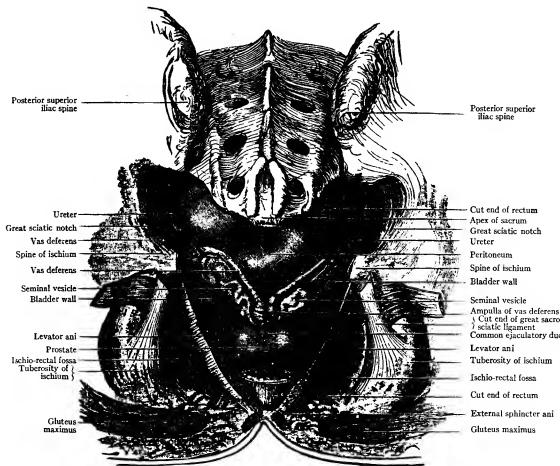

From A. F. Dixon, Cunningham's *Text-book of Anatomy*.

FIG. 2.—View of the Base of the Bladder, Prostate, Seminal Vesicles and Vasa Deferentia from behind.

The coccyx and the sacro-sciatic ligaments, together with the muscles attached to them, have been removed. The levatores ani have been separated along the median raphe, and drawn outwards. A considerable portion of the rectum and the upper part of the right seminal vesicle have been taken away.

The *vesiculae seminales* are sac-like diverticula, one on each side, from the lower part of the ampullae of the vasa deferentia. They are about 2 in. long and run outward behind the bladder and parallel to the upper margin of the prostate for some little distance, but usually turn upward near their blind extremity. When carefully dissected and unravelled each is found to consist of a thick tube, about 5 in. long, which is sharply bent upon itself two or three times, and also has several short, sac-like pouches or diverticula. The *vesiculae seminales* are muscular sacs with a mucous lining which is thrown into a series of delicate net-like folds. The convolutions are held together by the pelvic cellular tissue, and by involuntary muscle continuous with that of the bladder. It is probable that these vesicles are not reservoirs, as was at one time thought, but form some special secretion which mixes with that of the testes. Where the vesiculae join the ampullae of the vasa deferentia the *ejaculatory ducts* are formed; these are narrow and thin-walled,

the prostate the urethra runs more forward for about three-quarters of an inch, lying between the two layers of the triangular

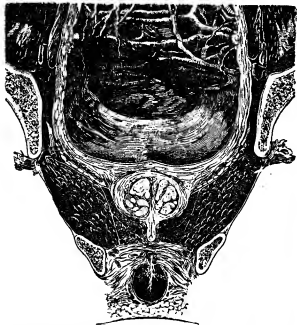

From C. S. Wallace's *Prostatic Enlargement*.¹

FIG. 3.—Coronal Section through the Pelvis, showing the relations of the bladder above, prostate and bulb below.

ligament, both of which it pierces. This is known as the *membranous urethra*, and is very narrow, being gripped by the compressor urethrae muscle.

The *spongy urethra* is that part which is enclosed in the penis after piercing the anterior layer of the triangular ligament. At first it lies in the substance of the bulb and, later, of the corpus spongiosum, while finally it passes through the glans. In the greater part of its course it is a transverse slit, but in traversing the glans it enlarges considerably to form the *fossa navicularis*, and here, in transverse section, it looks like an inverted T (L), then an inverted Y (A), and finally at its opening

the fossa navicularis the mouth of one of these is sometimes so large that it may engage the point of a small catheter and is known as the *lacuna magna*. As a rule the meatus is the narrowest part of the whole canal.

Opening into the spongy urethra where it passes through the bulb are the ducts of two small glands known as Cowper's glands, which lie on each side of the membranous urethra and are best seen in childhood.

The *penis* is the intromittent organ of generation, and is made up of three cylinders of erectile tissue, covered by skin and subcutaneous tissue without fat. In a transverse section two of these cylinders (the *corpora cavernosa*) are placed above, side by side, while one, the *corpus spongiosum*, is below. Posteriorly, at what is known as the root of the penis, the two corpora cavernosa diverge, become more and more fibrous in structure, and are attached on each side to the rami of the ischium, while the corpus spongiosum becomes more vascular and enlarges to form the bulb. It has already been pointed out that the whole length of the corpus spongiosum is traversed by the urethra. The anterior part of the penis is formed by the *glans*, a bell-shaped structure, apparently continuous with the corpus spongiosum, and having the conical ends of the corpora cavernosa fitted into depressions on its posterior surface. On the dorsum of the penis the rim of the bell-shaped glans projects beyond the level of the corpora cavernosa, and is

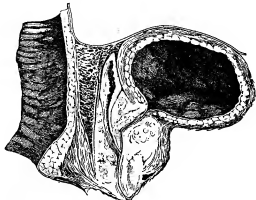

From C. S. Wallace's *Prostatic Enlargement*.

FIG. 5.—Sagittal Median Section of Bladder, Prostate and Rectum, showing one of the ejaculatory ducts.

known as the *corona glandis*. The skin of the penis forms a fold which covers the glans and is known as the *prepuce* or *foreskin*; when this is drawn back a median fold, the *frenulum praepucii*, is seen running to just below the meatus. After forming the prepuce the skin is reflected over the glans and here looks like mucous membrane. The structure of the corpora cavernosa consists of a strong fibrous coat, the *tunica albuginea*, from the deep surface of which numerous fibrous trabeculae penetrate the interior and divide it into a number of spaces which are lined with endothelium and communicate with the veins. Between the two corpora cavernosa the sheath is not complete and, having a comb-like appearance, is known as the *septum pectinatum*. The structure of the corpus spongiosum and glans resembles that of the corpora cavernosa, but the trabeculae are finer and the network closer.

Female Reproductive Organs.

The *ovary* is an organ which in shape and size somewhat resembles a large almond, though its appearance varies considerably in different individuals, and at different times of life. It lies in the side wall of the pelvis with its long axis nearly vertical and having its blunt end (tubal pole) upward. Its more pointed lower end is attached to the uterus by the ligament of the ovary, while its anterior border has a short reflection of peritoneum, known as the *mesovarium*, running forward to the broad ligament of the uterus. It is through this anterior border that the vessels and nerves enter and leave the gland.

Under the microscope the ovary is seen to be covered by a

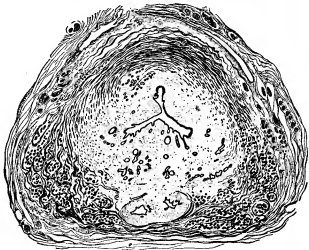

From C. S. Wallace's *Prostatic Enlargement*.

FIG. 4.—Transverse Section of a young Prostate, showing wavy striped muscle in front, urethra in the middle, and the two ejaculatory ducts behind.

(external meatus) a vertical slit. Into the whole length of the urethra mucous glands (*glands of Littre*) open, and in the roof of

¹ Figs. 3, 4, 5 and 9 of this article are redrawn from Cuthbert S. Wallace's *Prostatic Enlargement* by permission of the managers of The Oxford Medical Publications.

layer of cubical cells, which are continuous near the anterior border with the cells of the peritoneum. Deep to these is the ovarian stroma, composed of fibrous tissue, and embedded in it are numerous nests of epithelial cells, the *Graafian follicles*, in various stages of development. During the child-bearing period of life some of these will be nearing the ripe condition, and if one such be looked at it will be seen to contain one large cell, the *ovum*, surrounded by a mass of small cells forming the *discus proligerus*. At one point this is continuous with a layer of cells called the *stratum granulosum* which lines the outer wall of the follicle, but elsewhere the two layers are separated by fluid, the *liquor folliculi*. When the follicle bursts, as it does in time, the ovum escapes to the surface of the ovary.

The Fallopian tubes receive the ova and carry them to the uterus. That end of each which lies in front of the ovary is called the fimbriated extremity, and has a number of fringes (*fimbriae*) hanging from it; one of the largest of these is the ovarian fimbria and is attached to the upper or tubal pole of the ovary. The small opening among the fimbriae by which the tube communicates with the peritoneal cavity is known as the *ostium abdominale*, and from this the lumen of the tube runs from four to four and a half inches, until it opens into the cavity of the uterus by an extremely small opening. In the accompanying figure (fig. 6) the Fallopian tube and ovary

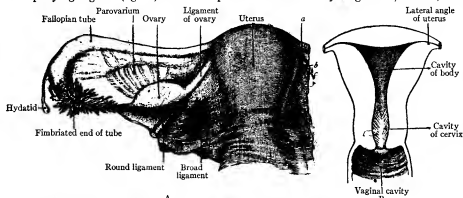

A. F. Dixon, Cunningham's Text-Book of Anatomy.

FIG. 6.—A. The Uterus and Broad Ligament seen from behind (the broad ligament has been spread out).

a, b and c, the isthmus tubae, the ligament of the ovary, and the round ligament of the right side cut short.

B. Diagrammatic Representation of the Uterine Cavity opened up from in front.

are pulled out from the uterus; this, as has been explained, is not the position of the ovary in the living body, nor is it of the tube, the outer half of which lies folded on the front and inner surface of the ovary. The Fallopian tubes, like many other tubes in the body, are made chiefly of unstripped muscle, the outer layer of which is longitudinal and the inner circular; deep to this are the submucous and mucous coats, the latter being lined with ciliated epithelium (see EPITHELIAL TISSUES), and thrown into longitudinal pleats. Superficially the tube is covered by a serous coat of peritoneum. The calibre gradually contracts from the peritoneal to the uterine opening.

The uterus or womb is a pear-shaped, very thick-walled, muscular bag, lying in the pelvis between the bladder and rectum. In the non-pregnant condition it is about three inches long and two in its broadest part, which is above. The upper half or body of the uterus is somewhat triangular with its base upward, and has an anterior surface which is moderately flat, and a posterior convex. The lower half is the neck or cervix and is cylindrical; it projects into the anterior wall of the vagina, into the cavity of which it opens by the *os uteri externum*. This opening in a uterus which has never been pregnant is a narrow transverse slit, rarely a circular aperture, but in those uteri in which pregnancy has occurred the slit is much wider and its lips are thickened and gaping and often

scarred. The interior of the body of the uterus shows a comparatively small triangular cavity (see fig. 6, B), the anterior and posterior walls of which are in contact. The base of the triangle is upward, and at each lateral angle one of the Fallopian tubes opens. The apex leads into the canal of the cervix, but between the two there is a slight constriction known as the *os uteri internum*. The canal of the cervix is about an inch long, and is spindle-shaped when looked at from in front; its anterior and posterior walls are in contact, and its lining mucous membrane is raised into a pattern which, from its likeness to a cypress twig, is called the *arbor vitae*. This arrangement is obliterated after the first pregnancy. On making a mesial vertical section of the uterus the cavity is seen as a mere slit which is bent about its middle to form an angle the opening of which is forward. A normal uterus is therefore bent forward on itself, or anteflexed. In addition to this, its long axis forms a marked angle with that of the vagina, so that the whole uterus is bent forward or anteverted. As a rule, in adults the uterus is more or less on one side of the mesial plane of the body. From each side of the uterus the peritoneum is reflected outward, as a two-layered sheet, to the side wall of the pelvis; this is the *broad ligament*, and between its layers lie several structures of importance. Above, there is the Fallopian tube, already described; below and in front is the round ligament; behind, the ovary projects backward, and just above

this, when the broad ligament is stretched out as in fig. 6, are the epoöphoron and paroöphoron with the duct of Gärtner.

The *round ligament* is a cord of unstripped muscle which runs from the lateral angle of its own side of the uterus forward to the internal abdominal ring, and so through the inguinal canal to the upper part of the labium majus.

The *epoöphoron* or *parovarium* is a collection of short tubes which radiate from the upper border of the ovary when the broad ligament is pulled out as in fig. 6. It is best seen in very young children and represents the vasa efferentia in the male. Near the ovary the tubes are closed, but nearer the Fallopian tube they open into another tube which is nearly at right angles to them, and which runs toward the uterus, though in the human subject

it is generally lost before reaching that organ. It is known as the duct of Gärtner, and is the homologue of the male epididymis and vas deferens. Some of the outermost tubules of the epoöphoron are sometimes distended to form hydatis. Nearer the uterus than the epoöphoron a few scattered tubules are occasionally found which are looked upon as the homologue of the organ of Giraldès in the male, and are known as the *paroöphoron*.

The *vagina* is a dilatate muscular passage, lined with mucous membrane, which leads from the uterus to the external generative organs; its direction is, from the uterus, downward and forward, and its anterior and posterior walls are in contact, so that in a horizontal section it appears as a transverse slit. As the orifice is neared the slit becomes H-shaped. Owing to the fact that the neck of the uterus enters the vagina from in front, the anterior wall of that tube is only about $2\frac{1}{2}$ in., while the posterior is 3 $\frac{1}{2}$. The mucous membrane is raised into a series of transverse folds or rugae, and between it and the muscular wall are plexuses of veins forming erectile tissue. The relation of the vagina to the peritoneum is noticed under COELUM and SEROUS MEMBRANES.

The *vulva* or *puendum* comprises all the female external generative organs, and consists of the mons Veneris, labia majora and minora, clitoris, urethral orifice, hymen, bulbs of the vestibule, and glands of Bartholin. The *mons Veneris* is the

elevation in front of the pubic bones caused by a mass of fibro-fatty tissue; the skin over it is covered by hair in the adult. The *labia majora* are two folds of skin, also containing fibro-fatty tissue and covered on their outer surfaces by hair, running down from the mons Veneris to within an inch of the anus and touching one another by their internal surfaces. They are the homologues of the scrotum in the male. The *labia minora* are two folds of skin containing no fat, which are usually hidden by the labia majora and above enclose the clitoris, they are of a pinkish colour and look like mucous membrane.

The *clitoris* is the representative of the penis, and consists of two corpora cavernosa which posteriorly diverge to form the crura clitoridis, and are attached to the ischium; the organ is about an inch and a half long, and ends anteriorly in a rudimentary glans which is covered by the junction of the labia minora; this junction forms the prepuce of the clitoris.

The *orifice of the urethra* is about an inch below the glans clitoridis and is slightly puckered.

The *hymen* is a fold of mucous membrane which surrounds the orifice of the vagina and is usually only seen in the virgin. As has been pointed out above, it is represented in the male by the fold at the opening of the uterus masculinus. Occasionally the hymen is imperforate and then gives rise to trouble in menstruation.

The *bulbs of the vestibule* are two masses of erectile tissue situated one on each side of the vaginal orifice; above they are continued up to the clitoris; they represent the bulb and the corpus spongiosum of the male, split into two, and the fact that they are so divided accounts for the urethra failing to be enclosed in the clitoris as it is in the penis.

The *glands of Bartholin* are two oval bodies about half an inch long, lying on each side of the vagina close to its opening; they represent Cowper's glands in the male, and their ducts open by minute orifices between the hymen and the labia minora.

From the above description it will be seen that all the parts of the male external genital organs are represented in the female, though usually in a less developed condition, and that, owing to the orifice of the vagina, they retain their original bi-lateral form.

For further details see Quain's *Anatomy* (London: Longmans, Green & Co.); Gray's *Anatomy* (London: Longmans, Green & Co.); Cunningham's *Text-Book of Anatomy* (Edinburgh: Young J. Pentland), or Macalister's *Anatomy* (London: Griffin & Co.).

Embryology.

The development of the reproductive organs is so closely interwoven with that of the urinary that some reference from this article to that on the URINARY SYSTEM is necessary. It will here be convenient to take up the development at the stage depicted in the accompanying figure (fig. 7), in which the genital ridge (a) is seen on each side of the attachment of the mesentery; external to this, and forming another slight ridge of its own, is the Wolffian duct, while a little later the Müllerian duct is formed and lies ventral to the Wolffian. The early history of these ducts is indicated in the article on the URINARY SYSTEM. Until the fifth or sixth week the development of the genital ridge is very much the same in the two sexes, and consists of cords of cells growing from the epithelium-covered surface into the mesenchyme, which forms the interior of the ridge. In these cords are some large germ cells which are distinguishable at a very early stage of development. It must, of course, be understood that the germinal epithelium covering the ridge, and the mesenchyme inside it, are both derived from the mesoderm or middle layer of the embryo. About the fifth week of human embryonic life the tunica albuginea appears in the male, from which septa grow to divide the testis into lobules, while the epithelial cords form the seminiferous tubes, though these do not gain a lumen until just before puberty. From the adjacent mesonephros cords of cells grow into the attached part of the genital ridge, or testis, as it now is, and from these the rete testis is developed. Recent research, however, points to these cords of the rete testis et ovarii as being derived from the coelomic epithelium instead of from the mesonephros.

In the female the same growth of epithelial cords into the mesenchyme of the genital ridge takes place, but each one is

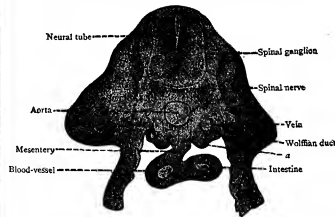

From A. F. Dixon, Cunningham's *Text-Book of Anatomy*.
FIG. 7.—Transverse Section through a Rat Embryo
a. shows position of germinal epithelium.

distinguished by a bulging toward its middle, in which alone the large germ cells are found. Eventually this bulging part is broken up into a series of small portions, each of which contains one germ cell or ovum, and gives rise to a Graafian follicle. Mesonephric cords appear as in the male; they do not enter the ovary, however, but form a transitory network (*rete ovarii*) in the mesovarium. As each genital gland enlarges it remains attached to the rest of the intermediate cell mass by a constricted fold of the coelomic membrane, known as the *mesorchium* in the male, and the *mesovarium* in the female. Lying dorsal to the genital ridge in the intermediate cell mass is the *mesonephros*, consisting

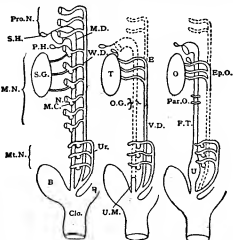

FIG. 8.—Diagram of the Formation of the Genito-Urinary Apparatus. The first figure is the generalized type, the second the male and the third the female specialized arrangements. Suppressed parts are dotted.

Pro. N.	Pronephros.	N.	Nephrostome.
M. N.	Mesonephros.	M. C.	Malpighian corpuscle.
M. N.	Metanephros.	T.	Testis.
B.	Bladder.	E.	Epididymis.
Clo.	Cloaca.	O. G.	Organ of Giraldb.
R.	Rectum.	V. D.	Vas deferens.
M. D.	Müllerian duct.	U. M.	Uterus masculinus.
W. D.	Wolffian duct.	O.	Ovary.
U.	Ureter.	E. P. O.	Epoöphoron.
S. H.	Sessile hydatid.	Par. O.	Paröphoron.
P. H.	Pedunculated hydatid.	F. T.	Fallopian tube.
S. G.	Sexual gland.	U.	Uterus.

of numerous tubules which open into the Wolffian duct. This at first is an important excretory organ, but during development becomes used for other purposes. In the male, as has been shown, it may form the rete testis, and certainly forms the vasa deferentia and globus major of the epididymis; in addition to these, some of its separate tubes probably account for the vas aberrans and the organ of Giraldbes (see fig. 8, E. and O. G.). In the female the tubules of the epoöphoron represent the main part,

while the paroöphoron, like the organ of Giraldès in the male, is probably formed from some separate tubes (see fig. 8, Ep. O. and Par. O.).

The Wolffian duct, which, in the early embryo, carries the excretion of the mesonephros to the cloaca, forms eventually the body and tail of the epididymis, the vas deferens, and ejaculatory duct in the male, the vesicula seminalis being developed as a pouch in its course. In the female this duct is largely done away with, but remains as the collecting tube of the epoöphoron, and in some mammals as the duct of Gärtner, which runs down the side of the vagina to open into the vestibule.

The Müllerian duct, as it approaches the cloaca, joins its fellow of the opposite side, so that there is only one opening into the ventral cloacal wall. In the male the lower part only of it remains as the uterus masculinus (fig. 8, U.M.), but in the female the Fallopian tubes, uterus, and probably the vagina, are all formed from it (fig. 8, F.T. and U.). In both sexes a small hydatid or vesicle is liable to be formed at the beginning of both the Wolffian and Müllerian duct (fig. 8, P.H. and S.H.); in the male these are close together in front of the globus major of the epididymis, and are known as the sessile and pedunculated hydatids of Morgagni. In the female there is a hydatid among the fimbriae of the Fallopian tube which of course is Müllerian and corresponds to the sessile hydatid in the male, while another is often found at the beginning of the collecting tube of the epoöphoron and is probably formed by a blocked mesonephric tubule. This is the pedunculated hydatid of the male. The development of the vagina, as Berry Hart (*Journ. Anat. and Phys.* xxxv. 330) has pointed out, is peculiar. Instead of the two Müllerian ducts joining to form the lumen of its lower third, as they do in the case of the uterus and its upper two-thirds, they become obliterated, and their place is taken by two solid cords of cells, which Hart thinks are derived from the Wolffian ducts and are therefore probably of ectodermal origin, though this is open to doubt. These cords later become canalized and the septum between them is obliterated.

The common chamber, or cloaca, into which the alimentary, urinary and reproductive tubes open in the foetus, has the urinary bladder (the remains of the allantois) opening from its ventral wall (see PLACENTA and URINARY SYSTEM).

During development the alimentary or anal part of the cloaca is separated from the urogenital, and in the article ALIMENTARY SYSTEM the hitherto accepted method of this separation is described. The question has, however, lately been reinvestigated by F. Wood Jones, who says that the anal part is completely shut off from the urogenital and ends in a blind pouch which grows toward the surface and meets a new ectodermal depression, the main point being that the permanent anus is not, according to him, any part of the original cloacal aperture, but a new perforation. This description is certainly more in harmony with the malformations occurring in this region than the old one, and only awaits confirmatory evidence to be generally accepted.

The external generative organs have at first the same appearance in the two sexes, and consist of a swelling, the genital eminence, in the ventral wall of the cloaca. This in the male becomes the penis and in the female the clitoris. Throughout the generative system the male organs depart most from the undifferentiated type, and in the case of the genital eminence two folds grow together and enclose the urogenital passage, thus making the urethra perforate the penis, while in the female these two folds remain separate as the labia minora or nymphae. Sometimes in the male the folds fail to unite completely, and then there is an opening into the urethra on the under surface of the penis—a condition known as hypospadias.

In the undifferentiated condition the integument surrounding the genital opening is raised into a horseshoelike swelling with its convexity over the pubic symphysis and its concavity toward the anus; the lateral parts of this remain separate in the female and form the labia majora, but in the male they unite to form the scrotum. The median part forms the mons Veneris or mons Jovis.

The Descent of the Testis.—It has been shown that the testis is formed in the loin region of the embryo close to the kidney, and it is only in the later months of foetal life that it changes this position for that of the scrotum. In the lower part of the genital ridge a fibro-muscular cord is formed which stretches from the lower part of the testis to the bottom of the scrotum; it is known as the gubernaculum testis, and by its means the testis is directed into the scrotum. Before the testis descends, a pouch of peritoneum called the processus vaginalis passes down in front of the gubernaculum through the opening in the abdominal wall, which afterwards becomes the inguinal canal, into the scrotum, and behind this the testis descends, carrying with it the mesonephros and mesonephric duct. These, as has already been pointed out, form the epididymis and vas deferens. At the sixth month the testis lies opposite the abdominal ring, and at the eighth reaches the bottom of the scrotum and invaginates the processus vaginalis from behind. Soon after birth the communication between that part of the processus vaginalis which now surrounds the testis and the general cavity of the peritoneum disappears, and the part which remains forms the tunica vaginalis. Sometimes the testis fails to pass beyond the inguinal canal, and the term "cryptorchism" is used for such cases.

In the female the ovary undergoes a descent like that of the testis, but it is less marked owing to the fact that the gubernaculum becomes attached to the Müllerian duct where that duct joins its fellow to form the uterus; hence the ovary does not descend lower than the level of the top of the uterus, and the part of the gubernaculum running between it and the uterus remains as the ligament of the ovary, while the part running from the uterus to the labium is the round ligament. In rare cases the ovary may be drawn into the labium just as the testis is drawn into the scrotum.

Comparative Anatomy.—In the Urochorda, the class to which Salpa, Pyrosoma and the sea squirts (Ascidians) belong, male and female generative glands (*gonads*) are present in the same individual; they are therefore hermaphrodite.

In the Acrania (Amphioxus) there are some twenty-six pairs of gonads arranged segmentally along the side of the pharynx and intestine and bulging into the atrium. Between them and the atrial wall, however, is a rudimentary remnant of the coelom, through which the spermatozoa or ova (for the sexes are distinct) burst into the atrial cavity. There are no genital ducts.

In the Cyclostomata (lampreys and hags) only one median gonad is found, and its contents (spermatozoa or ova) burst into the coelom and then pass through the genital pores into the urogenital sinus and so to the exterior. It is probable that the single gonad is accounted for by the fact that its fellow has been suppressed.

In the Elasmobranchs or cartilaginous fishes there are usually two testes or two ovaries, though in the dogfish one of the latter is suppressed. From each testis, which in fish is popularly known as the soft roe, vasa efferentia lead into the mesonephros, and the semen is conducted down the vas deferens or mesonephric duct into the urogenital sinus, into which also the ureters open. Sometimes one or more thin-walled diverticula—the sperm sacs—open close to the aperture of the vas deferens. In the female the ova are large, on account of the quantity of yolk, and they burst into the coelom, from which they pass into the large Müllerian ducts or oviducts. In the oviparous forms, such as the common dogfish (*Scyllium*), there is an oviducal gland which secretes a horny case for the egg after it is fertilized, and these cases have various shapes in different species. Some of the Elasmobranchs, e.g., the spiny dogfish (*Acanthias*), are viviparous, and in these the lower part of the oviduct is enlarged and acts as a uterus. In male elasmobranchs the anterior part of the Müllerian duct persists. Paired intromittent organs (claspers) are developed on the pelvic fins of the males; these conduct the semen into the cloaca of the female.

In the teleostean and ganoid fishes (Teleostomi) the nephridial

ducts are not always used as genital ducts, but special coelomic ducts are formed (see COELOM and SEROUS MEMBRANES).

In the Dipnoi or mudfish long coiled Müllerian ducts are present, but the testes either pour their secretion directly into the coelom or, as in Protoperus, have ducts which are probably coelomic in origin.

In both the Teleostomi and Dipnoi the testes and ovaries are paired.

True hermaphroditism is known among fishes, the hag (Myxine) and the sea perch (Serranus) being examples. In many others it occurs as an abnormality.

In the Amphibia both ovaries and testes are symmetrical. In the snake-like forms which are found in the order Gymnophiona the testes are a series of separate lobules extending for a long distance, one behind the other, and joined by a connecting duct from which vasa efferentia pass into the Malpighian capsules of the kidneys, and so the sperm is conducted to the mesonephric duct, which acts both as vas deferens and ureter. The Müllerian ducts or oviducts are long and often coiled in Amphibia, and usually open separately into the cloaca. There is no penis, but in certain forms, especially the Gymnophiona, the cloaca is protrusible in the male and acts as an intromittent organ. Corpora adiposa or fat bodies are present in all Amphibians, and probably nourish the sexual cells during the hibernating period.

In Reptilia two testes and ovaries are developed, though they are often asymmetrical in position. In Lizards the vas deferens and ureter open into the cloaca by a common orifice; as they do in the human embryo. In these animals there are two penes, which can be protruded and retracted through the vent; but in the higher reptiles (Chelonia and Crocodilia) there is a single median penis arising from the ventral wall of the cloaca, composed of erectile tissue and deeply grooved on its dorsal surface for the passage of the sperm.

In birds the right ovary and oviduct degenerates, and the left alone is functional. In the male the ureter and vas deferens open separately into the cloaca, and in the Ratitae (ostriches) and Anseres (ducks and geese) a well-developed penis is present in the male. In the ostrich this is fibrous, and bifurcated at its base, suggesting the crura penis of higher forms.

Among the Mammalia the Monotremata (Ornithorhynchus and Echinida) have bird-like affinities. The left ovary is larger than the right, and the oviducts open separately into the cloaca and do not fuse to form a uterus. The testes retain their abdominal position; and the vasa deferentia open into the base of the penis, which lies in a separate sheath in the ventral wall of the cloaca, and shows an advance on that of the reptiles and birds in that the groove is now converted into a complete tunnel. In the female there is a well-developed ditioris, having the same relations as the penis.

In the marsupials the cloaca is very short, and the vagina and rectum open separately into it. The two uteri open separately and three vaginæ are formed, two lateral and one median. The two lateral join together below to form a single median lower vagina, and it is by means of these that the spermatozoa pass up into the oviducts. The upper median vagina at first does not open into the lower one, but during parturition a communication is established which in some animals remains permanent (see J. P. Hill, *Proc. Linn. Soc. N.S. Wales*, 1899 and 1900). This tripartite arrangement of the upper part of the marsupial vagina is of especial interest in connexion with the views of the embryology of the canal detailed by Berry Hart and already referred to.

When, as in marsupials, the two uteri open separately into the vagina by two ora, the arrangement is spoken of as uterus duplex. When the two uteri join below and open by one os externum, it is known as uterus bipartitus. When the uterus bifurcates above and has two horns for the reception of the Fallopian tubes (oviducts), but is otherwise single, the term uterus bicornis is given to it, while the single uterus of man and other Primates is called uterus simplex. From the marsupials upward the

ovarian end of the Fallopian tube has the characteristic fimbriated appearance noticed in human anatomy.

In some mammals, such as the sow and the cow, the Wolffian duct is persistent in the female and runs along the side of the vagina as the duct of Gärtner. It is possible that the lateral vaginæ of the marsupials are of Wolffian origin.

In marsupials the testes descend into the scrotum, which lies in these animals in front of instead of behind the penis. In some mammals, such as the elephant, they never reach the scrotum at all; while in others, e.g. many rodents, they can be drawn up into the abdomen or lowered into the scrotum. The subject of the descent of the testicles has been very fully treated by H. Klaatsche, "Ueber den Descensus testicularum," *Morph. Jahrb.*, Bd. xvi.

The prostate is met with in its most simple forms in marsupials, in which it is a mere thickening of the mucous membrane of the urethra; in the sheep it forms a bilateral elongated mass of gland tissue lying behind the urethra and surrounded by a well-developed layer of striped muscle. In the sloth it is said to be altogether absent, while in many of the insectivores and rodents it consists of many lobes which usually show a bilateral arrangement. The vesiculæ seminales are usually present in the Eutheria or higher mammals, and sometimes, as in the hedgehog, are very large, though they are absent in the Carnivora. Cowper's glands are usually present and functional throughout

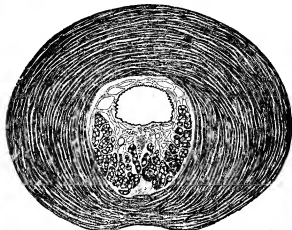

From C. S. Wallace's *Prostatic Enlargement*.

FIG. 9.—Transverse Section of Sheep's Prostate.

life. The uterus masculinus is also usually present, but there is grave doubt whether the large organ called by this name in the rabbit should not rather be regarded as homologous with part of the vesiculæ seminales. The penis shows many diversities of arrangement; above the marsupials its two crura obtain an attachment to the ischium. In many mammals it is quite hidden by the skin in the flaccid condition, and its external orifice may range from the perineum in the marsupials to the middle of the ventral wall of the abdomen in the ruminants. In the Marsupialia, Rodentia, Chiroptera, Carnivora and some Primates an os penis is developed in connexion with the corpora cavernosa.

The clitoris is present in all mammals; sometimes, as in the female hyena, it is very large, and at others, as in the lemur, it is perforated by the urethra.

For further details and literature, see Oppel's *Lehrbuch der vergleich. mikroskop. Anatomie der Wirbelthiere*, Bd. iv. (Jena, 1904); also Gegenbaur's *Vergleich. Anat. der Wirbelthiere*, and Wiedersheim's *Comparative Anatomy of Vertebrates*, translated by W. N. Parker (London, 1907). (F. G. P.)

REPSOLD, JOHANN GEORG (1771-1830), German instrument maker, was born at Wremen in Hanover on the 23rd of September 1771, and became an engineer and afterwards chief of the fire brigade in Hamburg, where he started business as an instrument maker early in the 19th century. He was killed by the fall of a wall during a fire at Hamburg on the 14th of January 1830. The business was continued by his sons Georg (1804-1884)

and Adolf (1806-1871), and his grandsons Johann Adolf and Oskar Philipp.

J. G. Repsold introduced essential improvements in the meridian circles by substituting microscopes (on Jesse Ramsden's plan) for the verniers to read the circles, and by making the various parts perfectly symmetrical. For a number of years the firm furnished meridian circles to the observatories at Hamburg, Königsberg, Pulkova, &c.; later on its activity declined, while Pistor and Martins of Berlin rose to eminence. But after the discontinuance of this firm that of Repsold again came to the front, not only in the construction of transit circles, but also of equatorial mountings and more especially of heliometers (see MICROMETER).

REPTILES (Lat. *Reptilia*, creeping things, from *reptilis*; *refere*, to creep; Gr. ἑρπεῖν, whence the term "herpetology," for the science dealing with them). In the days before Linnaeus, writers comprised the animals which popularly are known as tortoises and turtles, crocodiles, lizards and snakes, frogs and toads, newts and salamanders, under the name of oviparous quadrupeds or four-limbed animals which lay eggs. Linnaeus, desirous of giving expression to the extraordinary fact that many of these animals pass part of their life in the water and part on land,¹ substituted the name of Amphibia for the ancient term. Subsequent French naturalists (Lyonnét² and Brisson³) considered that the creeping mode of locomotion was a more general characteristic of the class than their amphibious habits, and consequently proposed the scarcely more appropriate name of *Reptiles*.

As naturalists gradually comprehended the wide gap existing between frogs, toads, &c., on the one hand, and the other oviparous quadrupeds on the other, they either adopted the name of Batrachia for the former and that of Amphibia for the latter, or they restricted the term Amphibia to Batrachians, calling the remainder of these creatures reptiles. Thus the term Amphibia, as used by various authors, may apply (1) to all the various animals mentioned, or (2) to Batrachians only (see BATRACHIA). The term Reptiles (*Reptilia*) is used (1) by some for all the animals mentioned above, and (2) by others, as in the present article, for the same assemblage of animals after the exclusion of Batrachians.

Equally varying are the limits of the term Saurians, which occurs so frequently in every scientific treatise on this subject. At first it comprised living crocodiles and lizards only, with which a number of fossil forms were gradually associated. As the characters and affinities of the latter became better known, some of them were withdrawn from the Saurians, and at present it is best to abandon the term altogether.

I. HISTORY OF HERPETOLOGY

Certain kinds of reptiles are mentioned in the earliest written records or have found a place among the fragments of the oldest relics of human art. Such evidences, however, form no part of a succinct review of the literature of the subject such as it is proposed to give here. We distinguish in it six periods: (1) the Aristotelian; (2) the Linnaean (formation of a class Amphibia, in which reptiles and Batrachians are mixed); (3) the period of the elimination of Batrachians as one of the reptilian orders (Brongniart); (4) that of the separation of reptiles and Batrachians as distinct subclasses; (5) that of the recognition of a class Reptilia as part of the Sauropsida (Huxley); (6) that of the discovery of fossil skeletons sufficiently well preserved to reveal, in its general outlines, the past history of the class.

1. *The Aristotelian Period.*—Aristotle was the first to deal with the reptiles known to him as members of a distinct portion of the animal kingdom, and to point out the characteristics by which they resemble each other and differ from other vertebrate and invertebrate animals. The plan of his

work, however, was rather that of a comparative treatise of the anatomical and physiological characters of animals than their systematic arrangement and definition, and his ideas about the various groups of reptiles are not distinctly expressed, but must be gleaned from the terms which he employs. Moreover, he paid less attention to the study of reptiles than to that of other classes. This is probably due to the limited number of kinds he could be acquainted with, to which only very few extra-European forms, like the crocodile, were added from other sources. But while we find in some respects a most remarkable accuracy of knowledge, there is sufficient evidence that he neglected everyday opportunities of information. Thus, he has not a single word about the metamorphoses of Batrachians, which he treats of in connexion with reptiles.

Aristotle makes a clear distinction between the scute or scale of a reptile, which he describes as *φολίς*, and that of a fish, which he designates as *λεπίς*. He mentions reptiles (1) as oviparous quadrupeds with scutes, viz. Saurians and Chelonians; (2) as oviparous apodals, viz. Snakes; (3) as oviparous quadrupeds without scutes, viz. Batrachians. He considered the first and second of these three groups as much more nearly related to each other than to the third. Accurate statements and descriptions are sadly mixed with errors and stories of, to our eyes, the most absurd and fabulous kind. The most complete accounts are those of the crocodile (chiefly borrowed from Herodotus) and of the chameleon, which Aristotle evidently knew from personal observation, and had dissected himself. The other lizards mentioned by him are the common lizards (*σαύρα*), the common seps (*χαλκίς* or *ζυγνίς*) and the gecko (*ἀσκαλαβώτης* or *κορδύλος*). Of snakes (of which he generally speaks as *όφεις*) he knew the vipers (*έξις* or *έχιδνα*), the common snake (*ίδρος*), and the blindworm (*τυφλόληϊς όφεις*), which he regards as a snake; he further mentions the Egyptian cobra and dragons (*δράκων*)—North-African serpents of fabulous size. Of Chelonians he describes in a perfectly recognizable manner land tortoises (*χελώνη*), freshwater turtles (*έμύς*) and marine turtles (*χελώνη ή θαλάσση*).

Passing over eighteen centuries, we find the knowledge of reptiles to have remained as stationary as other branches of natural history, perhaps even more so. The reptile fauna of Europe was not extensive enough to attract the energy of a Belon or Rondelet; popular prejudice and the difficulty of preserving these animals deterred from their study; nor was man sufficiently educated not to give implicit credence to the fabulous tales of reptiles in the 15th and 16th centuries. The art of healing, however, was developing into a science based upon rational principles, and consequently not only those reptiles which formed part of the *materia medica* but also the venomous snakes became objects of study to the physician, though the majority of the writers were ignorant of the structure of the venom-apparatus, and of the distinction between non-venomous and venomous snakes.

Nothing can show more clearly the small advance made by herpetology in this long post-Aristotelian period than a glance at the celebrated work, *De Differentiis Animalium* Wotton, *Libri decem* (Paris, 1552), by Edward Wotton (1492-1555). Wotton treats of the reptiles which he designates as *Quadrupedes oviparæ et Serpentes* in the sixth book of his work. They form the second division of the *Quadrupedes quæ sanguinem habent*, and are subdivided in the following "genera":—

Crocodilus et scincus (cap. cv.); *Testudinum genera* (cvi.); *Ranarum genera* (cvii.); *Lacertæ* (cviii.); *Salamandra et seps quadrupes* (cix.); *Stellio* (cx.); *Chamaeleo* (cx.); *Serpentes* (cxii.). A general account, the following being different kinds of serpents: *Hydrus et alii quidam serpentes aquatiles* (cxiii.); *Serpentes terrestres et primo aspidum genera* (cxiv.); *Vipera, dipsas, cerastes, et hammodyles* (cxv.); *Haemorrhus, sepebon, seps, cenchrus, et cenchriles* (cxvi.); *Basilius et alii quidam serpentes quorum venenum medicis caret* (cxvii.); *Draco, amphibioena, et alii quidam serpentes quorum morsus minus affert periculi* (cxviii.).

Wotton's work might with propriety be termed "Aristoteles redivivus." The plan is the same, and the observations of the Greek naturalist are faithfully, sometimes literally, reproduced.

¹ "Polymorpha in his amphibibus natura duplicem vitam plerisque concessit."

² *Théologie des insectes de Lesser* (Paris, 1745), i. 91, note 5.

³ *Règne animal divisé en neuf classes* (Paris, 1756).

It is surprising that even the reptiles of his native country were most imperfectly known to the author.

With the enlargement of geographical knowledge that of reptiles was also advanced, as is sufficiently apparent from the *Johnston*. large encyclopaedic works of Gesner, Aldrovandi and Johnston. The last-named author especially, who published the various portions of his Natural History in the middle of the 17th century, was able to embody in his compilations notices of numerous reptiles observed by Francisco Hernandez in Mexico and by Marcgrave and Piso in Brazil. As the author had no definite idea of the Ray-Linnaean term "species," it is not possible to give the exact number of reptiles mentioned in his work. But it may be estimated at about fifty, not including some marine fishes and fabulous creatures. He figures (or rather reproduces the figures of) about forty—some species being represented by several figures.

2. *Linnaean Period: Formation of a Class Amphibia.*—Within the century which succeeded these compilatory works *Predecessors of Linnaeus* (1650-1750) fall the labours which prepared the way for and exerted the greatest influence on Ray and Linnaeus. Although original researches in the field of herpetology were limited in extent and in number, the authors had freed themselves from the purely literary or scholastic tendency. Men were no longer satisfied with reproducing and commenting on the writings of their predecessors; the pen was superseded by the eye, the microscope and the knife, and statements were tested by experiment. This spirit of the age manifested itself, so far as the reptiles are concerned, in Chara's and Redi's admirable observations on the viper, in Major's and Vallisneri's detailed accounts of the anatomy of the chameleon, in the researches of Jacobaeus into the metamorphoses of the Batrachians and the structure of lizards, in Dufay's history of the development of the salamander (for Batrachians are invariably associated with reptiles proper); in Tyson's description of the anatomy of the rattlesnake, &c. The natural history collections formed by institutions and wealthy individuals now contained not merely skins of crocodiles or serpents stuffed and transformed into a shape to correspond with the fabulous descriptions of the ancient dragons, but, with the discovery of alcohol as a means of preserving animals, reptiles entire or dissected were exhibited for study; and no opportunity was lost of obtaining them from travellers or residents in foreign countries. Fossils also were now acknowledged to be remains of animals which had lived before the Flood, and some of them were recognized as those of reptiles.

The contributions to a positive knowledge of the animal kingdom became so numerous as to render the need of a methodical arrangement of the abundance of new facts more and more pressing. Of the two principal systematic attempts made in this period the first ranks as one of the most remarkable steps of the progress of natural history, whilst the second can only be designated as a signal failure, which ought to have been a warning to all those who in after years classified animals in what is called an, "artificial system." As the latter attempt, originating with Klein (1685-1750), did not exercise any further influence on herpetology, it will be sufficient to have merely mentioned it. John Ray (1628-1705) had recognized the necessity of introducing exact definitions for the several categories into which the animals had to be divided, and he maintained that these categories ought to be characterized by the structure of animals, and that all zoological knowledge had to start from the "species" as its basis. His definition of reptiles as "animalia sanguinea pulmones respirantia cor unico tantum ventriculo instructum habentia ovipara" fixed the class in a manner which was adopted by the naturalists of the succeeding hundred and fifty years. Nevertheless, Ray was not a herpetologist; his knowledge of reptiles is chiefly derived from the researches of others, from whose accounts, however, everything not based upon reliable demonstration is critically excluded. He begins with a chapter treating of frogs (*Rana*, with two species), toads (*Bufo*, with one species) and

tortoises¹ (*Testudo*, with fourteen species). The second group comprises the *Lacertae*, twenty-five in number, and includes the salamander and newts; and the third the *Serpentes*, nine species, among which the limbless lizards are enumerated.

Except in so far as he made known and briefly characterized a number of reptiles, our knowledge of this class was not advanced by Linnaeus. That he associated in the 12th edition cartilaginous and other fishes with the reptiles under the name of *Amphibia Nantes* was the result of some misunderstanding of an observation by Garden, and is not to be taken as a premonitory token of the recent discoveries of the relation between Batrachians and fishes. Linnaeus places reptiles, which he calls Amphibia, as the third class of the animal kingdom; he divides the genera thus:—

ORDER I. REPTILES.—*Testudo* (15 species); *Rana* (17 sp.); *Draco* (2 sp.); *Lacerta* (48 sp., including 6 Batrachians).

ORDER 2. SERPENTES.—*Crotalus* (5 species); *Boa* (10 sp.); *Coluber* (96 sp.); *Anguis* (15 sp.); *Amphisbaena* (2 sp.); *Cacilia* (2 sp.).

None of the naturalists who under the direction or influence of Linnaeus visited foreign countries possessed any special knowledge of or predilection for the study of reptiles; all, however, contributed to our acquaintance with tropical forms, or transmitted well-preserved specimens to the collections at home, so that Gmelin, in the 13th edition of the *Systema Naturae*, was able to enumerate three hundred and seventy-one species.

The man who, with the advantage of the Linnaean method, first treated of reptiles monographically, was Laurenti. In a small book² he proposed a new division of these *Laurenti* animals, of which some ideas and terms have survived into our times, characterizing the orders, genera and species in a much more precise manner than Linnaeus, giving, for his time, excellent descriptions and figures of the species of his native country. Laurenti might have become for herpetology what Ardeti was for ichthyology, but his resources were extremely limited.

The circumstance that Chelonians are entirely omitted from his *Synopsis* seems due rather to the main object with which he engaged in the study of herpetology, viz. that of examining and distinguishing reptiles reputed to be poisonous, and to want of material, than to his conviction that tortoises should be relegated to another class. He divides the class into three orders:—

1. SALIENTIA, with the genera *Pipa*, *Bufo*, *Rana*, *Hyla*, and one species of "*Proteus*," viz. the larva of *Pseudis paradoxa*.
2. GRADIENTIA, the three first genera of which are Tailed Batrachians, viz. two species of *Proteus* (one being the *P. anguinus*), *Triton* and *Salamandra*; followed by true Saurians—*Caudiverbera*, *Gecko*, *Chamaeleo*, *Iguana*, *Basiliscus*, *Draco*, *Cordylus*, *Crocodylus*, *Scincus*, *Stellio*, *Seps*.
3. SERPENTIA, among which he continues to keep *Amphisbaena*, *Cacilia* and *Anguis*, but the large Linnaean genus *Coluber* is divided into twelve, chiefly from the scutellation of the head and form of the body.

The work concludes with an account of the experiments made by Laurenti to prove the poisonous or innocuous nature of those reptiles of which he could obtain living specimens.

The next general work on reptiles is by Lacépède. It appeared in the years 1788 and 1790 under the title *Histoire naturelle des quadrupèdes ovipares et des serpents* (Paris, Lacépède, 2 vols. 4to). Although as regards treatment of details and amount of information this work far surpasses the modest attempt of Laurenti, it shows no advance towards a more natural division and arrangement of the genera. The author depends entirely on conspicuous external characters, and classifies the reptiles into (1) oviparous quadrupeds with a tail, (2) oviparous quadrupeds without a tail, (3) oviparous

¹In associating tortoises with toads, Ray could not disengage himself from the general popular view as to the nature of these animals, which found expression in the German *Schildkröte* ("Shield-toad").

²*Specimen medicum exhibens Synopsis Reptilium emendatam cum experimentis circa venena et antidota Reptilium Austriacorum* (Vienna, 1768, 8vo, pp. 214, with 5 plates).

bipeds (*Chirotes* and *Pseudopus*), (4) serpents,—an arrangement in which the old confusion of Batrachians and reptiles and the imperfect definition of lizards and snakes are continued, and which it is worthy of remark we find also adopted in Cuvier's *Tableau élémentaire de l'histoire naturelle des animaux* (1798), and nearly so by Latreille in his *Histoire naturelle des reptiles* (Paris, 1801, 4 vols. 12 mo). Lacépède's monograph, however, remained for many years deservedly the standard work on reptiles. The numerous plates with which the work is illustrated, are, for the time, well drawn, and the majority readily recognizable.

3. *The Period of Elimination of Batrachians as one of the Reptilian Orders.*—A new period for herpetology commences with Alex. Brongniart,¹ who in 1799 first recognized the characters by which Batrachians differ from the other reptiles, and by which they form a natural passage to the class of fishes. *Cacilia* (as also *Langaha* and *Acrochordus*) is left by Brongniart with hesitation in the order of snakes, but newts and salamanders henceforth are no more classed with lizards. He leaves the Batrachians, however, in the class of reptiles, as the fourth order. The first order comprises the Chelonians, the second the Saurians (including crocodiles and lizards), the third the Ophidians—terms which have been adopted by all succeeding naturalists. Here, however, Brongniart's merit on the classification of reptiles ends, the definition and disposition of the genera remaining much the same as in the works of his predecessors.

The activity in France in the field of natural science was at this period, in spite of the political disturbances, so great that only a few years after Lacépède's work another, almost identical in scope and of the same extent, appeared, viz. the *Histoire naturelle générale et particulière des reptiles* of F. M. Daudin (Paris, 1802-3, 8 vols. 8vo). Written and illustrated with less care than that by Lacépède, it is of greater importance to the herpetologists of the present day, as it contains a considerable number of generic and specific forms described for the first time. Indeed, at the end of the work, the author states that he has examined more than eleven hundred specimens, belonging to five hundred and seventeen species, all of which he has described from nature. The system adopted is that of Brongniart, the genera are well defined, but ill arranged; it is, however, noteworthy that *Cacilia* takes now its place at the end of the Ophidians, and nearest to the succeeding order of Batrachians.

The next step in the development of the herpetological system was the natural arrangement of the genera. This involved a stupendous amount of labour. Although many isolated contributions were made by various workers, this task could be successfully undertaken and completed in the Paris Museum only, in which, besides Seba's and Lacépède's collections, many other herpetological treasures from other museums had been deposited by the victorious generals of the empire, and to which, through Cuvier's reputation, objects from every part of the world were attracted in a voluntary manner. The men who devoted themselves to this task were A. M. C. Duméril, Oppel and Cuvier himself. Oppel was a German who, during his visit to Paris (1807-1808), attended the lectures of Duméril and Cuvier, and at the same time studied the materials to which access was given to him by the latter in the most liberal manner. Duméril² maintains that Oppel's ideas and information were entirely derived from his lectures, and that Oppel himself avows this to be the case. The passage,³ however, to which he refers is somewhat ambiguous,

and it is certain that there is the greatest possible difference between the arrangement published by Duméril in 1806 (*Zoologie Analytique*, Paris, 8vo) and that proposed by Oppel in his *Ordnungen, Familien, und Gattungen der Reptilien* (Munich, 1811, 4to). There is no doubt that Oppel profited largely by the teaching of Duméril; but, on the other hand, there is sufficient internal evidence in the works of both authors, not only that Oppel worked independently, but also that Duméril and Cuvier owed much to their younger fellow-labourer, as Cuvier himself indeed acknowledges more than once.

Oppel's classification may be shortly indicated thus:—

- ORDER I. TESTUDINATA OR CHÉLONIENS.
 Fam. 1. CHÉLONII (gen. *Mydas*, *Coriacea*).
 Fam. 2. AMYDÆ (gen. *Trionyx*, *Chelys*, *Testudo*, *Emys*).
 ORDER 2. SQUAMATA.
 Sect. A. SAURII.
 Fam. 1. CROCODILINI (gen. *Crocodylus*, *Gavialis*, *Alligator*).
 Fam. 2. GECKONES (gen. *Gecko*, *Stellio*, *Agama*).
 Fam. 3. IGUANOIDES (gen. *Camaeole*, *Draco*, *Iguana*, *Basiliscus*, *Lophyrus*, *Anolis*).
 Fam. 4. LACERTINI (gen. *Tupinambis*, *Dracaena*, *Lacerta*, *Tachydromus*).
 Fam. 5. SCINCODINI (gen. *Scincus*, *Septs*, *Scheloposich*, *Anguis*).
 Fam. 6. CHALCIDICI (gen. *Chalcides*, *Bimanus*, *Bipes*, *Ophisaurus*).
 Sect. B. OPHIDI.
 Fam. 1. ANGIULIFORMES (gen. *Tortrix*, *Amphisbaena*, *Typhlops*).
 Fam. 2. CONSTRUCTORUM (gen. *Boa*, *Eryx*).
 Fam. 3. HYDRI (gen. *Platurus*, *Hydrophis*).
 Fam. 4. PSEUDO-VIPERÆ (gen. *Acrochordus*, *Erepeton*).
 Fam. 5. CROTALINI (gen. *Crotalus*, *Trigonocephalus*).
 Fam. 6. VIPERINI (gen. *Vipera*, *Pseudoboa*).
 Fam. 7. COLUBRINI (gen. *Coluber*, *Bungarus*).
 ORDER 3. NUDA OR BATRACII.

In this classification we notice three points, which indicate a decided progress towards a natural system. (1) The four orders proposed by Brongniart are no more considered co-subordinate in the class, but the Saurians and Ophidians are associated as sections of the same order, a view held by Aristotle but abandoned by all following naturalists. The distinction between lizards and snakes is carried out in so precise a manner that one genus only, *Amphisbaena*, is wrongly placed. (2) The true reptiles have now been entirely divested of all heterogeneous elements by relegating positively *Cacilia* to the Batrachians, a view for which Oppel had been fully prepared by Duméril, who pointed out in 1807 that "les céclies se rapprochent considérablement des batraciens auxquels elles semblent lier l'ordre entier des serpents."⁴ (3) An attempt is made at arranging the genera into families, some of which are still retained at the present day.

In thus giving a well-merited prominence to Oppel's labours we are far from wishing to detract from the influence exercised by the master spirit of this period, Cuvier. Without his guidance Oppel probably never would have found a place among the promoters of herpetological science. But Cuvier's principal researches on reptiles were incidental or formed part of some more general plan; Oppel concentrated his on this class only. Cuvier adopts the four orders of reptiles proposed by Brongniart as equivalent elements of the class, and restores the blind-worms and allied lizards and, what is worse, also the *Cacilia*, to the Ophidians. The chameleons and geckos are placed in separate groups, and the mode of dividing the latter has been retained to the present day. Also a natural division of the snakes, although the foreign elements mentioned are admitted into the order, is sufficiently indicated by his arrangement of the "vrais serpents proprement dits" as (1) non-venomous snakes, (2) venomous snakes with several maxillary teeth, and (3) venomous snakes with isolated poison-fangs. He distinguishes the species of reptiles with a precision not attained in any previous work.

Cuvier's researches into the osteology of reptiles had also the object of discovering the means of understanding the fossil remains which now claimed the attention of French, English and German naturalists. Extinct Chelonian and Crocodylian

⁴ *Mémoires de zoologie et d'anatomie comparée* (Paris, 1807, 8vo), p. 45.

¹ *Bull. Acad. Sci.* (1800), Nos. 35, 36.

² *Expét. génér.*, i. p. 259.

³ "Wäre es nicht die Ermunterung . . . dieser Freunde gewesen, so würde ich überzeugt von den Mängeln, denen eine solche Arbeit bei aller möglichen Vorsicht doch unterworfen ist, es nie gewagt haben, meine Eintheilung bekannt zu machen, obwohl selbe Herr Duméril in seinen Lectiōnen vom Jahre 1809 schon vorgetragen, und die Thiere im Cabinet darnach bezeichnet hat" (preface, p. viii). A few lines further on he emphatically declares that the classification is based upon his own researches.

remains, *Pterodactylus*, *Mosasauros*, *Iguanodon*, *Ichthyosaurus*, *Teleosaurus*, became the subjects of Cuvier's classical treatises, which form the contents of the 5th volume (part 2) of his *Recherches sur les ossements fossiles, où l'on rétablit les caractères de plusieurs animaux dont les révolutions du globe ont détruit les espèces* (new ed., Paris, 1824, 4to).

All the succeeding herpetologists adopted either Oppel's or Cuvier's view as to the number of orders of reptiles, or as to the position Batrachians ought to take in their relation to reptiles proper, with the single exception of D. DE BLAINVILLE. He divided the "oviparous subtype" of Vertebrates into four classes, Birds, Reptiles, Amphibians and Fishes,¹ a modification of the system which is all the more significant as he designates the reptiles "*Squamifères Ornithoides, écailleux*," and the amphibians "*Nudipellifères, Ichthyoides nus*." In these terms we perceive clear indications of the relations which exist to the class of birds on the one hand, and to that of fishes on the other; but, unfortunately, Blainville himself did not follow up the ideas thus expressed, and abandoned even the terms in a later edition of his systematic tables.

The direct or indirect influence of the work of French anatomists manifested itself in the systems of the other herpetologists of this period. The Crocodiles, especially, which hitherto (strange to say, even in Cuvier's classification) had been placed as one of the families of Saurians, now commence to be separated from them. MERREM (*Versuch eines Systems der Amphibien*, Marburg, 1820, 8vo) distinguishes two classes of "Amphibians," Pholidota and Batrachia.

The Pholidota (or Reptiles) are divided into three orders, distinguished chiefly by osteological and splanchnological characters:—

1. TESTUDINATA.
 2. LORICATA (=Crocodiles).
 3. SQUAMATA (=Oppel's *Squamata*, excluding Crocodiles).
- Merrem's subdivision of the *Squamata* into (1) *Gradientia* (=limbed *Lacertilia*), (2) *Repentia* (=limbless *Lacertilia*), (3) *Serpentia* (=Snakes and *Amphisbaena*), (4) *Incedentia* (=Chirotes), and (5) *Predentia* (=Chamaeleons) was based chiefly on the modifications of the limbs, and not adopted by his successors. The greater part of his work is occupied with a synopsis of all the species of Reptiles known, each being shortly characterized by a diagnosis; but, as only a small proportion (about one hundred and seventy) were known to him from autopsy, this synopsis has all the faults of a compilation.

LATREILLE, who commenced the study of reptiles as early as 1801, had kept pace with the progress of science when he published, in 1825, his *Familles naturelles du règne animal* (Paris, 1825, 8vo). He separated the Batrachians as a class from the Reptiles, and the latter he divides into two sections only, Cataphracta and Squamata—in the former Crocodiles being associated with the Chelonians. He bases this view on the development of a carapace in both, on the structure of the feet, on the fixed quadrate bone, on the single organ of copulation. None of the succeeding herpetologists adopted a combination founded on such important characters except J. E. GRAY, who, however, destroyed Latreille's idea of Cataphracta by adding the *Amphisbaenians*² as a third order.

A mass of new materials now began to accumulate from all parts of the world in European museums. Among others, Spix had brought from Brazil a rich spoil to the Munich Museum, and the Bavarian Academy charged JOH. WAGLER to prepare a general system of reptiles and batrachians. His work,³ the result of ten years' labour, is a simple but lasting monument to a young naturalist,⁴ who, endowed with an ardent imagination, only too frequently misinterpreted the evidence of facts, or forced it into the service of preconceived ideas. Cuvier had drawn attention to certain resemblances in

some parts of the osseous structure of *Ichthyosaurus* and *Pterodactylus* to dolphins, birds, crocodiles, &c. Wagler, seizing upon such analogical resemblances, separated those extinct Saurians from the class of Reptiles, and formed of them and the Monotremes a distinct class of Vertebrates, intermediate between mammals and birds, which he called Gryphi. We must admit that he made free use of his imagination by defining his class of Gryphi as "vertebrates with lungs lying free in the pectoral cavity; oviparous development of the embryo (within or) without the parent; the young fed (or suckled?) by the parents." By the last character this Waglerian class is distinguished from the reptiles.

Reptiles (in which Wagler includes Batrachians) are divided into eight orders: Testudines, Crocodilli, Lacertae, Serpentes, Angues, Caeciliae, Ranae and Ichthyoidi. He has great merit in having employed, for the subdivision of the families of lizards, the structure of the tongue and the mode of insertion of the teeth in the jaws. On the other hand, Wagler entirely failed in arranging snakes in natural families, venomous and non-venomous types being mixed in the majority of his groups.

L. FITZINGER was Wagler's contemporary; his first work⁵ preceded Wagler's system by four years. As he says in the preface, his object was to arrange the reptiles in *Fitzinger's* "a natural system." Unfortunately, in order to attain this object, Fitzinger paid regard to the most superficial points of resemblance; and in the *tabula affinitatum generum* which he constructed to demonstrate "the progress of nature" he has been much more successful in placing closely allied generic forms in contiguity than in tracing the relationships of the higher groups. That table is prepared in the form of a genealogical tree, but Fitzinger wished to express thereby merely the amount of morphological resemblance, and there is no evidence whatever in the text that he had a clear idea of genetic affinity. The Batrachians are placed at the bottom of the scheme, leading through Hyla to the Geckos (clearly on account of the digital dilatations) and through Caecilia to *Amphisbaena*. At the top Draco leads through *Pterodactylus* to the Bats (*Pteropus*), *Ichthyosaurus* to the Cetaceans (*Delphinus*), Emys to the Monotremes, Testudo to Manis, and the Marine Turtles to the Divers and Penguins.

In Fitzinger's system the higher groups are, in fact, identical with those proposed by Merrem, while greater originality is shown in the subdivision of the orders. He differed also widely from Wagler in his views as to the relations of the extinct forms. The order of Loricata consists of two families, the *Ichthyosaurioides* and *Crocodyloidea*, the former comprising *Iguanodon*, *Plesiosauros*, *Saurocephalus* and *Ichthyosaurus*. In the order *Squamata* *Lacertilians* and *Ophidians* are combined and divided into twenty-two families, almost all based on the most conspicuous external characters: the first two, viz. the Geckos and Chamaeleons, are natural enough, but in the three following *Iguanoids* and *Agamoids* are sadly mixed, *Pterodactyles* and *Draco* forming one family; *Megalosaurus*, *Mosasauros*, *Varanus*, *Tejus*, &c., are associated in another named *Amisbaenidae*; the *Amphisbaenidae* are correctly defined; the *Colubroidea* are a heterogeneous assemblage of thirty genera; but with his family of *Bungaroides* Fitzinger makes an attempt to separate at least a part of the venomous *Colubrine* Snakes from the *Viperines*, which again are differentiated from the last family, that of *Crotaloidea*.

If this little work had been his only performance in the field of herpetology his name would have been honourably mentioned among his fellow-workers. But the promise of his early labours was not justified by his later work, and if we take notice of the latter here it is only because his name has become attached to many a reptile through the pedantic rules of zoological nomenclature. The labours of Wiegmann, Müller, Duméril and Bibron exercised no influence on him, and when he commenced to publish a new system of reptiles in 1843,⁶ of which fortunately one fasciculus only appeared, he exhibited a classification in which morphological facts are entirely superseded by fanciful ideas of the vaguest kind of phyllosophy, each class of vertebrates being divided

⁵ *Neue Classification der Reptilien nach ihren natürlichen Verwandtschaften* (Vienna, 1826, 4to).

⁶ *Systema Reptilium* (Vienna, 1843, 8vo).

¹ *Bull. Sci. Soc. Philomat.*, July 1816.

² *Catalogue of the Tortoises, Crocodiles and Amphisbaenians in the Collection of the British Museum* (London, 1844, 16mo), p. 2.

³ *Natürliches System der Amphibien mit vorangehender Classification der Säugethiere und Vögel—ein Beitrag zur vergleichenden Zoologie* (Munich, 1830, 8vo).

⁴ Wagler was accidentally killed three years after the publication of his *System*.

into five "sense" series, and each series into three orders, one comprising forms of superior, the second of medium and the third of inferior development. In the generic arrangement of the species, to which Fitzinger devoted himself especially in this work, he equally failed to advance science.

We have now arrived at a period distinguished by the appearance of a work which superseded all its predecessors, which formed the basis for the labours of many succeeding years, and which will always remain one of the classical monuments of descriptive zoology—the *Erpétologie générale ou histoire Duméril naturelle complète des reptiles* of A. M. C. DUMÉRIL and G. BIBRON (Paris, 8vo). The first volume appeared in 1834, and the ninth and last in 1854. No naturalist of that time could have been better qualified for the tremendous undertaking than C. Duméril, who almost from the first year of half a century's connexion with the then largest collection of Reptilia had chiefly devoted himself to their study. The task would have been too great for the energy of a single man; it was, therefore, fortunate for Duméril that he found a most devoted fellow-labourer in one of his assistants, G. Bibron, whose abilities equalled those of the master, but who, to the great loss of science, died (in 1848) before the completion of the work. Duméril had the full benefit of Bibron's knowledge for the volumes containing the Snakes, but the last volume, which treats of the Tailed Batrachians, had to be prepared by Duméril alone.

The work is the first which gives a comprehensive scientific account of reptiles generally, their structure, physiology and literature, and again each of the four orders admitted by the authors is introduced by a similar general account. In the body of the work 121 Chelonians, 468 Saurians, 586 Ophidians and 218 Batrachians are described in detail and with the greatest precision. Singularly enough, the authors revert to Bronn's arrangement, in which the Batrachians are co-ordinate with the other three orders of reptiles. This must appear all the more strange as Von Baer¹ in 1828, and J. Müller² in 1831, had urged, besides other essential differences, the important fact that no Batrachian embryo possesses either an amnion or an allantois, like a reptile.

4. *Period of the Separation of Reptiles and Batrachians as Distinct Classes or Subclasses.*—In the chronological order which we have adopted for these historical notes, we had to refer in their proper places to two herpetologists, Blainville and Latreille, who advocated a deeper than merely ordinal separation of Reptiles from Batrachians, and who were followed by J. Müller and F. S. Leuckart. But this view only now began to find more general acceptance. J. MÜLLER and STANNIUS were guided in their classification entirely by anatomical characters, and consequently recognized the wide gap which separates the Batrachians from the Reptiles; yet they considered them merely as subclasses of the class Amphibia. The former directed his attention particularly to those forms which seemed to occupy an intermediate position between Lacertilians and Ophidians, and definitely relegated Anguis, Pseudopus, Acontias to the former, and Typhlops, Rhinophis, Torrix, but also the Amphibaenoids to the latter. Stannius interpreted the characteristics of the Amphibaenoids differently, as will be seen from the following abstract of his classification:³

SUBCLASSIS: AMPHIBIA MONOPNOA (Leuckart).

SECT. 1. STREPTOSTYLICA (Stann.). Quadrate bone articulated to the skull; copulatory organs paired, placed outside the cloacal cavity.

ORDO 1. OPHIDIA.

Subordo 1. EURYSTOMATA of MACROSTOMATA (Müll.).

The facial bones are loosely connected to admit of great extension of the wide mouth.

Subordo 2. ANGIOSTOMATA of MICROSTOMATA (Müll.).

Mouth narrow, not extensible; quadrate bone attached to the skull and not to a mastoid.

ORDO 2. SAURIA.

Subordo 1. AMPHRISBAENOIDEA.

Subordo 2. KIONOCRANIA (Stann.) = Lizards.

Subordo 3. CHAMAELONIDEA.

SECT. 2. MONIMOSTYLICA (Stann.). Quadrate bone suturally united with the skull; copulatory organ simple, placed within the cloaca.

ORDO 1. CHELONIA.

ORDO 2. CROCODILLA.

This classification received the addition of a fifth Reptilian order which with many Lacertilian characters combined important Crocodilian affinities, and in certain other respects differed from both, viz. the New Zealand Hatteria, which by its first describers had been placed to the Agamoid Lizards. A. GÜNTHER,⁴ who pointed out the characteristics of this reptile, considered it to be co-ordinate with the other four orders of reptiles, and characterizes it thus:—

Rhynchocephalia.—Quadrate bone suturally and immovably united with the skull and pterygoid; columella present. Rami of the mandible united as in Lacertilians. Temporal region with two horizontal bars. Vertebrae amphicoelian. Copulatory organs, none.

5. *Period of the Recognition of a Class of Reptilia as Part of the Sauropsida.*—Although so far the discovery of every new morphological and developmental fact had prepared naturalists for a class separation of Reptiles and Batrachians, it was left to T. H. Huxley to demonstrate, not merely that the weight of facts demanded such a class separation, but that the reptiles hold the same relation to birds as the fishes to Batrachians. In his *Hunterian Lectures* (1863) he divided the vertebrates into Mammals, Sauroids and Ichthyoids, subsequently substituting for the last two the terms Sauropsida and Ichthyopsida.⁵ The Sauropsida contain the two classes of birds and reptiles, the Ichthyopsida those of Batrachians and fishes.

6. *Period of the Consideration of Skeletons of Extinct Reptiles.*—SIR R. OWEN, while fully appreciating the value of the osteological characters on which Huxley based his division, yet admitted into his consideration those taken from the organs of circulation and respiration, and reverted to Latreille's division of warm- and cold-blooded (haematothoracal and haematocryal) vertebrates, thus approximating the Batrachians to reptiles, and separating them from birds.⁶ The reptiles (or Monopnoa, Leuck.) thus form the highest of the five subclasses into which, after several previous classifications, Owen⁷ finally divided the Haematocrya. His division of this subclass, however, into nine orders, makes a considerable step in the progress of herpetology, since it takes into consideration for the first time the many extinct groups whose skeletons are found fossil. He shows that the number of living reptilian types bears but a small proportion to that of extinct forms, and therefore that a systematic arrangement of the entire class must be based chiefly upon osteological characters. His nine orders are the following:

a. ICHTHYOPTERYGIA (extinct)—*Ichthyosaurus*.

b. SAUROPTERYGIA (extinct)—*Plesiosaurus*, *Pliosaurus*, *Nothosaurus*, *Placodus*.

c. ANOMODONTIA (extinct)—*Dicynodon*, *Rhynchosaurus*, *Oudenodon*.

d. CHELONIA.

e. LACERTILIA (with the extinct *Mosasaurus*).

f. OPHIDIA.

g. CROCODILIA (with the extinct *Telosaurus* and *Streptospondylus*).

h. DINOSAURIA (extinct)—*Iguanodon*, *Scelidosaurus* and *Megalosaurus*.

i. PTEROSAURIA (extinct)—*Dimorphodon*, *Rhamphorhynchus* and *Pterodactylus*.

Owen was followed by Huxley and E. D. Cope, who, however, restricted still more the selection of classificatory characters by relying for the purposes of arrangement on a few parts of the

¹ Contribution to the Anatomy of Hatteria (*Rhynchocephalus*, Owen), in *Phil. Trans.* (1867), part ii.

² An Introduction to the Classification of Animals (London, 1869, 8vo), pp. 104 seq.

³ Anatomy of Vertebrates (London, 1866, 8vo), vol. i. p. 6.

⁴ *Op. cit.* p. 16.

¹ *Entwicklungsgeschichte der Thiere*, p. 262.

² Tiedemann's *Zeitschrift für Physiologie*, vol. iv. p. 200.

³ Siebold and Stannius, *Handbuch der Zoologie—Zootomie der Amphibien* (2nd ed., Berlin, 1856, 8vo).

skeleton only. They attempted a further grouping of the orders which in Owen's system were merely serially enumerated as cosubordinate groups. HUXLEY used for this purpose almost exclusively the position and character of the rib-articulations to the vertebral canal, the orders themselves being the same as in Owen's system:—

A. *PLEUROSPONDYLIA*. Dorsal vertebrae devoid of transverse processes and not movable upon one another, nor are the ribs movable upon the vertebrae. A plastron. Order 1, CHELONIA.

B. The dorsal vertebrae (which have either complete or rudimentary transverse processes) are movable upon one another, and the ribs upon them. No plastron.

a. The dorsal vertebrae have transverse processes which are either entire or very imperfectly divided into terminal facets (*EXPLETOSPONDYLIA*).

α. Transverse processes long; limbs well developed, paddles; sternum and sternal ribs absent or rudimentary. Order 2, PLESIOSAURIA (= *Sauropterygia*, Ow.).

β. Transverse processes short.

aa. A pectoral arch and urinary bladder. Order 3, LACERTILIA.

bb. No pectoral arch and no urinary bladder. Order 4, OPHIDIA.

b. The dorsal vertebrae have double tubercles in place of transverse processes (*PEROSPONDYLIA*). Limbs paddle-shaped. Order 5, ICHTHYOSAURIA (= *Ichthyopterygia*, Ow.).

c. The anterior dorsal vertebrae have elongated and divided transverse processes, the tubercular being longer than the capular division (*SUCHOSPONDYLIA*).

α. Only two vertebrae in the sacrum. Order 6, CROCODYLIA.

β. More than two vertebrae in the sacrum.

aa. Manus without a prolonged ulnar digit.

αα. Hind limb Saurian. Order 7, DICYNODONTIA (= *Anodontia*, Ow.).

ββ. Hind limb Ornithic. Order 8, ORNITHOSCELIDA (= *Dinosauria*, Ow.).

bb. Manus with an extremely long ulnar digit. Order 9, PTEROSAURIA.

COPE,¹ by combining the modifications of the quadrate and supporting bones with the characters used by Huxley, further developed Owen's classification, separating the

Cope. *Pythonomorphs* and *Rhynchocephalia* as distinct orders from the Lacertilia. He eventually² elaborated the following classification, based entirely on osteological characters:—

I. The quadrate bone immovably fixed to the adjacent elements by suture.

A. Scapular arch external to ribs; temporal region with a complex bony roof; no longitudinal postorbital bars.

A tabular and supramastoid bones and a presternum; limbs ambulatory; vertebrae amphicoelous. Order 1, COTYLOSAURIA.

AA. Scapular arch internal to ribs; temporal region with complex roof and no longitudinal bars.

A presternum; limbs ambulatory. Order 2, CHELYDOSAURIA.

AAA. Scapular arch internal to ribs; sternum extending below coracoids and pelvis; one postorbital bar.

No supramastoid; a paroccipital; clavicle not articulating with scapula. Order 3, TESTUDINATA.

AAAA. Scapular arch external to ribs; one longitudinal postorbital bar (*Synopsosauria*).

A supramastoid and paroccipital bones; ribs two-headed on centrum; carpal and tarsal not distinct in form from metapodials; vertebrae amphicoelous. Order 4, ICHTHYOPTERYGIA.

A supramastoid; paroccipital not distinct; a postorbito-quadrosal arch; ribs two-headed; a clavicle; obturator foramen small or none; vertebrae amphicoelous. Order 5, THEROMORA.

No supramastoid; paroccipital not distinct; a quadrato-glyphic arch; scapula triadriate; no clavicle; ribs one-headed. Order 6, PLESIOSAURIA.

AAAAA. Scapular arch external to ribs; two longitudinal postorbital bars (paroccipital arch distinct) (*Archosauria*).

a. A supramastoid bone.

Ribs two-headed; a clavicle and interclavicle; acetabulum closed; no obturator foramen; ambulatory; vertebrae amphicoelous. Order 7, PELYCOSAURIA.

aa. No supramastoid.

Ribs two-headed; interclavicle not distinct; external digits greatly elongated to support a patagium for flight. Order 8, ORNITHOSAURIA.

Ribs two-headed; no interclavicle; acetabulum open; ambulatory. Order 9, DINOSAURIA.

Ribs two-headed; an interclavicle; acetabulum closed; ambulatory. Order 10, LORICATA.

Ribs one-headed; an interclavicle; acetabulum closed, a large obturator foramen; ambulatory. Order 11, RHYNCHOCEPHALIA.

II. The quadrate bone loosely articulated to the cranium and at the proximal end only (*Streptosylva*).

No distinct supramastoid, nor opisthotic; one or no postorbital bar; scapular arch, when present, external to ribs; ribs one-headed. Order 12, SQAMATA.

While this classification was being considered and prepared, both Cope and G. Baur made a special study of the bones which surround the quadrate and arch over the biting muscles in the various groups of reptiles. This led to a series of discussions which ended in the idea, that the class could be most naturally divided into two great subclasses, the one culminating in tortoises and mammals, the other in crocodiles, lizards, snakes and birds. Professor H. F. OSBORN in 1903³ therefore proposed the following classification:—

Subclass SYNAPSIDA. Primarily with single or undivided temporal arches. Giving rise to the mammals through some unknown member of the *Anomodontia*.

Orders *Cotylosauria*, *Anomodontia*, *Testudinata* and *Sauropterygia*. Subclass DIAPSIDA. Primarily with double or divided temporal arches. Giving rise to the birds through some unknown type transitional between *Protosauria* and *Dinosauria*.

Orders *Diapsosauria* (= *Protosauria*, *Pelycosauria* and *Rhynchocephalia*), *Flylosauria* (= *Belodon*, &c.), *Ichthyosauria*, *Crocodylia*, *Dinosauria*, *Synapsida* and *Pterosauria*.

The most exhaustive and modern general work on reptiles is by Dr C. K. HOFFMANN in *Brünn's Klassen und Ordnungen des Tierreichs* (1879-90). A most useful and less technical treatise is the volume on Amphibia and Reptiles contributed by Dr H. Gadow to the *Cambridge Natural History* (London, 1902). Hoffmann
(A. C. G.; A. S. Wo.)

II. GENERAL CHARACTERS OF THE CLASS REPTILIA

Reptiles, as known in the existing world, are the modified, and in many respects degenerate, representatives of a group of lung-breathing vertebrate animals which attained its maximum development in the Mesozoic period. So far as can be judged from the skeleton, some of the members of this group then living might have become mammals by very slight change, while others might as readily have evolved into birds. It is therefore probable that the class Reptilia, as now understood, comprises the direct ancestors both of the Mammalia and Aves. Assuming that its extinct members, which are known only by skeletons, were organized essentially like its existing representatives, the class ranks higher than that of the lowest five-toed vertebrates (class Batrachia) in the investment of the foetus by two membranous envelopes (the amnion and allantois), and in the total absence of gills even in the earliest embryos. It ranks below both the Mammalia and Aves in the partial mixture of the arterial blood with the venous blood as it leaves the heart, thus causing the organism to be cold-blooded; it also differs both from Mammalia and Aves in retaining a pair of aortic arches, of which only the left remains in the former, while the right one is retained in the latter. No feature in the endoskeleton is absolutely distinctive, except possibly the degeneration of the parapsphenoid bone, which separates the Reptilia from the Amphibia. In the exoskeleton, however, the epidermis forms horny scales, such as never occur in Amphibia, while there are no traces of any structures resembling either hairs or feathers, which respectively characterize Mammalia and Aves.

There is little doubt that true reptiles date back to the latter part of the Palaeozoic period, but at that epoch the Amphibia approached them so closely in the characters of the skeleton that it is difficult to distinguish the members of the two classes among the fossils. Some of the Palaeozoic Amphibia—a few of the so-called Labyrinthodonts—are proved to have had well-developed gill-arches in their immature state, while there are conspicuous marks of slime-canals on their skulls. Others are

¹ *Proc. Amer. Assoc. for the Advancement of Science*, 10th meeting (Cambridge, 1871, 8vo), pp. 230 sq.; *Amer. Naturalist* (1889), vol. xxxii, p. 863.

² *Syllabus of Lectures on the Vertebrata* (Philadelphia, 1898, 8vo), p. 54.

³ *Mem. American Mus. Nat. Hist.* (November 1903), vol. i. art. viii.

merely regarded as Amphibia because they closely resemble the genera which are proved to have been gill-breathers when immature. All these genera, however, so far as known, agree with the existing Amphibia in the production of their large parasphenoid bone as far forwards as the vomers to form a rigid and complete basicranial axis (fig. 1, A). Those genera

of the upper, bar, some members of this series eventually pass into the order Squamata (Lacertilia+Ophidia), in which the quadrate bone is completely exposed and loosely attached to the skull (fig. 2, E); other reptiles exhibiting a similar modification may readily have acquired the typical Avian skull (fig. 2, F) by the loss of the upper and the retention of the lower temporal bar in question.

In view of these and other palaeontological considerations, the Reptilia may be classified into orders as follows:—

ORDERS OF CLASS REPTILIA

1. **Anomodontia.**—Bones of postero-lateral region of skull forming a complete roof over the temporal and masseter muscles, or contracted into a single broad zygomatic arch, leaving a superior-temporal vacuity. Pinal foramen present. Ribs completely or imperfectly double-headed. No abdominal ribs. A large separately ossified epicoracoid. Limbs for support as well as progression; third and fourth digits with not more than three phalanges. Dermal armour feeble or absent. *Range.*—Permian and Triassic.

2. **Chelonia.**—Postero-lateral region of skull as in Anomodontia, except bones of ear-capsule more modified. No pinal foramen. Ribs single-headed. No sternum. Pectoral and pelvic arches unique in being situated completely inside the ribs. No epicoracoid. Abdominal ribs replaced by three or four pairs of large plates, which, with the clavicles and interclavicle, form a plastron. Limbs only for progression; third and fourth digits with not more than three phalanges. A regular dorsal carapace of bony plates intimately connected with the neural spines, and ribs of seven to nine dorsal vertebrae. *Range.*—Upper Triassic to Recent.

3. **Sauroptrygia.**—Bones of postero-lateral region of skull contracted into a single broad zygomatic arch, leaving a superior-temporal vacuity. Pinal foramen present. No fused sacral vertebrae. All dorsal ribs single-headed, articulating with transverse processes of the neural arches.

Abdominal ribs forming dense plastron. Apparently no sternum. Coracoid, pubis and ischium in form of much-expanded plates. Limbs modified as paddles, with not more than five digits, of which the third and fourth always have more than three phalanges; all digits usually consisting of numerous phalanges. No dermal armour. *Range.*—Upper Triassic to Cretaceous.

4. **Ichthyopterygia.**—Bones of postero-lateral region of skull contracted into a single broad zygomatic arch, leaving a superior-temporal vacuity. Pinal foramen present. Vertebral centra short and deeply biconcave, with feeble neural arches which are almost or completely destitute of zygophyses. No fused sacral vertebrae. Cervical and dorsal ribs double-headed, articulating with tubercles on the vertebral centra. Abdominal ribs forming dense plastron. Apparently no sternum. Coracoid an expanded plate, probably with cartilaginous epicoracoid. Pelvis very small, not connected with vertebrae. Limbs modified as paddles, with digits of very numerous short phalanges, which are closely pressed together, sometimes with supplementary rows of similar ossicles. No dermal armour. A vertical triangular caudal fin, not supported by skeletal rays. *Range.*—Triassic to Cretaceous.

5. **Rhynchocephalia.**—Bones of postero-lateral region of skull contracted into two slender zygomatic bars, leaving a superior-temporal and a lateral-temporal vacuity, and partly exposing the quadrate bone from the side. Pinal foramen present or absent. Ribs single-headed. Abdominal ribs present. Sternum present. Epicoracoid cartilaginous. Limbs only for progression; third and fourth digits with four or five phalanges. Dermal armour feeble or absent. *Range.*—Lower Permian to Recent.

6. **Dinosauria.**—Postero-lateral region of skull as in Rhynchocephalia. No pinal foramen. Cervical and dorsal ribs double-headed. Rarely abdominal ribs. Sternum present, but apparently no clavicular arch. Limbs for support as well as progression; third and fourth digits with four and five phalanges respectively. Dermal armour variable. *Range.*—Triassic to Cretaceous.

7. **Crocodylia.**—Postero-lateral region of skull as in Rhynchocephalia. No pinal foramen. Cervical and dorsal ribs double-headed. Abdominal ribs present. Sternum present; also interclavicle, but no clavicles. Limbs only for progression on land or swimming; third and fourth digits with four or five phalanges. Dermal armour variable. *Range.*—Lower Jurassic to Recent.

8. **Ornithosauria.**—All bones extremely dense, light and hollow, the organism being adapted for flight. Postero-lateral region of skull as in Rhynchocephalia. No pinal foramen. Cervical and dorsal ribs double-headed. Abdominal ribs present. Sternum present, and healed for attachment of pectoral muscles; no clavicular arch. Fifth digit of hand much elongated to support a wing-membrane, but with only four phalanges. Hind limb feeble. No dermal armour. *Range.*—Lower Jurassic to Cretaceous.

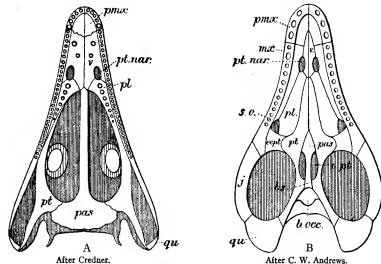

FIG. 1.—A, Palate of Palaeozoic Amphibian (*Archegosaurus decheni*).

B, Palate of Mesozoic Reptile (*Plesiosaurus macrocephalus*).

b.occ, basioccipital; bs, basisphenoid; cept, ectopterygoid; i.pt, interpterygoid vacuity; j, jugal; mx, maxilla; pas, parasphenoid; pt, palatine; pmx, premaxilla; pt, pterygoid; pt. nar, posterior nares; qu, quadrate; v, vomer.

which less resemble the typical Labyrinthodonts are characterized by the reduction of the parasphenoid bone so that it no longer reaches the vomers; in these animals the weakened skull exhibits a secondary basicranial axis formed by the approximation of the pterygoids to the median line (fig. 1, B). The latter condition is universal in existing reptiles, and may therefore perhaps be regarded as a diagnostic feature. If so, the oldest known undoubted reptile is *Palaeohatteria*, from the Lower Permian of Saxony.

In the structure of the skull *Palaeohatteria* is much like the existing *Sphenodon*, the cheek-plates which cover the temporal and masseter muscles on each side being pierced by two great vacuities, one superior-temporal, the other lateral-temporal. The majority of the earliest reptiles, however, either resemble the Labyrinthodonts in having the biting muscles completely covered with a roof of bony plates, or exhibit a slight shrinkage of this investment so that a superior-temporal vacuity appears. As the various groups or orders become differentiated, this shrinkage or reduction continues, while the shape of the ossifying ear-capsule changes, and the squamosal bone, which covers the organ of hearing in the fishes, and presumably also in the Palaeozoic Batrachia, is gradually thrust outwards from all connexion with this capsule except at its hinder angle. The resultant modifications are diagrammatically represented in fig. 2. In one series of orders, comprising the Anomodontia, Chelonia, Sauroptrygia and Ichthyopterygia (fig. 2, B, C), the superior-temporal vacuity (s) first appears, and the cheek-plates in the broad temporal arch thus formed may be variously fused together, sometimes even irregularly perforated—showing at first, indeed, the usual inconsistency of a new and not completely established feature. From the earliest members of this series of reptiles, palaeontology seems to demonstrate that the Mammalia (with one robust temporal arcade or zygomatic arch) arose. In a second series, comprising the orders Rhynchocephalia, Dinosauria, Crocodylia and Ornithosauria (fig. 2, D), the broad arch of cheek-plates is regularly pierced by a lateral-temporal vacuity, which leaves a narrow bar above, another narrow bar below, and uncovers the middle part of the quadrate bone. By the constant loss of the lower, and the frequent loss

9. *Squamata*.—Bones of postero-lateral region of skull much reduced and partly absent, never forming more than a slender superior-temporal bar, thus completely exposing the quadrate, which is only loosely attached to the cranium at its upper end. Pineal foramen present. Ribs single-headed. No abdominal ribs. Sternum present when there are limbs. Limbs, when present, only for progression; third and fourth digits at least with more than three phalanges. Dermal armour feeble or absent. *Range*.—Cretaceous to Recent.

Order 1. ANOMODONTIA.—The Anomodonts are so named in allusion to the peculiar and unique dentition of the first-discovered genera. They are precisely intermediate between the

and India, but they are best represented in the Karoo formation (Permian and Triassic) of South Africa. The *Pariasauria* most closely resemble the *Labyrinthodont* Amphibia, but have a single occipital condyle. *Pariasauria* itself is a massive herbivorous reptile, with a short tail, and the limbs adapted for excavating in the ground. It is known by several nearly complete skeletons, about 3 metres in length, from South Africa and northern Russia. *Elginia*, found in the Elgin sandstones of Morayshire, Scotland, is provided with horn-like bony bosses on the skull. Another apparently allied genus (*Otocaelus*) has a carapace suggesting that it may be an ancestral Chelonian. The Therio-

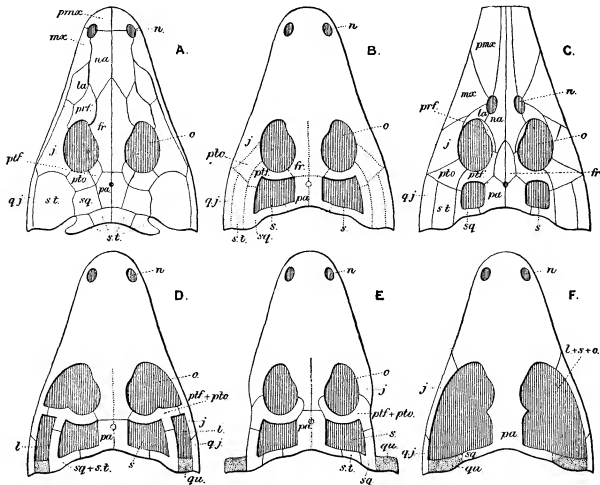

From A. S. Woodward, *Outlines of Vertebrate Palaeontology*.

FIG. 2.—Diagram of the Cranial Roof in a Labyrinthodont Amphibian, various types of Reptiles, and a Bird. A, Labyrinthodont Amphibian (*Mastodonsaurus giganteus*). B, Generalized Anomodont or Sauropterygian, passing with slight modification into the Chelonian (sutures dotted to denote inconstancy in fusion of elements). C, *Ichthyosaurus*. D, Generalized Rhynchocephalian, Dinosaurian, Crocodylian, or Ornithosaurian. E, Generalized Lacertilian, often losing even the arcade here indicated. F, Generalized Bird.

fr, frontal; j, jugal; l, lateral temporal vacuity; la, lachrymal; mx, maxilla; n, narial opening; na, nasal; o, orbit; pa, parietal; pmx, premaxilla; prf, prefrontal; ptf, postfrontal; pto, postorbital; qj, quadrato-jugal; qu, quadrate; s, supratermporal vacuity; s.t., supratemporal and proquadrate; sq, squamosal. Vacuities shaded with vertical lines, cartilage bones dotted.

Labyrinthodont Batrachia and the lowest or Monotreme Mammalia. They flourished at the period when the former are known to have reached their culmination, and when the latter almost certainly began to appear. Many of them would, indeed, be regarded as primitive Mammalia, if they did not retain a pineal foramen, a free quadrate bone, and a complex mandible. The term Theromorpha or Theromorpha is thus sometimes applied to the order they represent. So far as known, they are all land-reptiles, with limbs adapted for habitual support of the body, and their feet are essentially identical with those of primitive mammals. Most of them are small, and none attain a gigantic size. They first appear in the Permian of Europe and North America, and also occur in the Triassic both of Europe

and India, but they are best represented in the Karoo formation (Permian and Triassic) of South Africa. The *Pariasauria* most closely resemble the *Labyrinthodont* Amphibia, but have a single occipital condyle. *Pariasauria* itself is a massive herbivorous reptile, with a short tail, and the limbs adapted for excavating in the ground. It is known by several nearly complete skeletons, about 3 metres in length, from South Africa and northern Russia. *Elginia*, found in the Elgin sandstones of Morayshire, Scotland, is provided with horn-like bony bosses on the skull. Another apparently allied genus (*Otocaelus*) has a carapace suggesting that it may be an ancestral Chelonian. The Therio-

Order 2. CHELONIA.—This order occurs first in the Upper Triassic of Württemberg, where a complete "shell" has been

found (*Proganochelys*). Its members are proved to have been toothless since the Jurassic period, and have only changed very

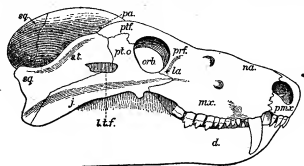

From A. S. Woodward, *Outlines of Vertebrate Palaeontology*.

FIG. 3.—Skull of an Anomodont (Theriodont) Reptile (*Cynognathus crateronotus*), about $\frac{1}{10}$ natural size.—Karoo formation (Permian or Triassic), South Africa.

d., dentary; *j.*, jugal; *l.t.f.*, incipient lateral temporal vacuity; *la.*, lachrymal; *mx.*, maxilla; *na.*, nasal; *orb.*, orbit; *pa.*, parietal; *pmx.*, premaxilla; *pr.f.*, prefrontal; *pt.o.*, postorbital; *pr.f.*, prefrontal; *s.t.*, supratemporal (prosquamosal); *sq.*, squamosal.

slightly since their first appearance. The marine turtles seem to have first acquired elongated paddles and vacuities in the shell during the Cretaceous period, and the Trionychia, destitute of epidermal shields, apparently arose at the same time.

Order 3. SAUROPTERYGIA.—These are amphibious or aquatic reptiles (fig. 4). The head is comparatively small in most

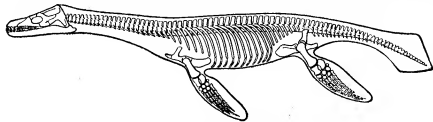

FIG. 4.—*Plesiosaurus rostratus*: restoration of skeleton by W. G. Ridewood.—Lower Lias, Dorsetshire.

genera, and the neck is usually elongated though not flexible. The tail is insignificant, generally short, and both pairs of paddles seem to have been concerned in progression. The order appears to have arisen from a group of land-reptiles, for its earliest members, from the Triassic of Europe (*Lariosaurus*) and from the Permo-Carboniferous of S. Africa (*Mesosaurus*) and Brazil (*Stereosternum*), are all amphibious animals. They are comparatively small, and their limbs are only just becoming paddle-like. The skull suggests affinities with the terrestrial

effective paddles with elongated digits, and as the genera are traced upwards in the geological formations it is possible to observe how the arches supporting the limbs become more rigid until the maximum of strength is reached. A few genera, such as *Pliosaurus* from the Jurassic and *Polyptychodon* from the Cretaceous of Europe, are distinguished by their relatively large head and stout neck. Some of the largest Upper Jurassic and Cretaceous species must have been 10 metres in length. They were cosmopolitan in their distribution, but became extinct before the dawn of the Tertiary period.

Order 4. ICHTHYOPTERYGIA.—The Ichthyosaurians are all fish-shaped, with a relatively large head and very short neck. Both pairs of paddles are retained, but the hinder pair is usually very small, and locomotion seems to have been chiefly effected by a large caudal fin. This fin, as shown in impression by certain fossils from Württemberg and Bavaria, is a vertical, triangular, dermal expansion, without any skeletal support except the hindmost part of the attenuated vertebral column, which extends along the border of its lower lobe (fig. 5). Another triangular fin, without skeletal support, is known to occur on the back, at least in one species (fig. 5). Some of the genera are proved to have been viviparous. Like the Sauropterygia, the Ichthyopterygia appear to have originated from terrestrial ancestors, for their earliest Triassic representatives (*Mixosaurus*) have the teeth less uniform and the limbs slightly less paddle-shaped than the latter genera. In this connexion it is noteworthy that their hollow conical teeth exhibit curious infoldings of the wall, like those observed in many Labyrinthodonts, while their short, biconcave vertebrae almost exactly resemble those of the Labyrinthodont *Mastodonsaurus* and its allies. As the Ichthyosaurs are traced upwards in geological time, some genera become almost, or quite, toothless, while the paddles grow wider, and are rendered more flexible by the persistence of cartilage round their constituent bones (*Ophthalmosaurus*). They were cosmopolitan in distribution, but disappeared from all seas at the close of the Cretaceous period. The largest forms, with a skull 2 metres in length, occur in the Lower Lias.

Order 5. RHYNCHOCEPHALIA.—These are small lizard-shaped reptiles, which have scarcely changed since the Triassic period. Though now represented only by *Sphenodon* or *Hatteria*, which survives in certain islands off New Zealand, in the Mesozoic epoch they ranged at least over Europe, Asia and North America. They comprise the earliest known reptile, *Palaeohatteria*, from the Lower Permian of Saxony, which differs from the Triassic and later genera in having an imperfectly ossified pubis and ischium, more numerous abdominal ribs, and the fifth metatarsal

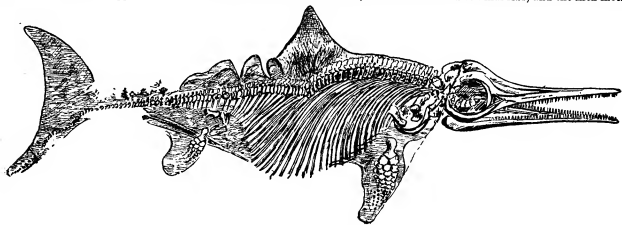
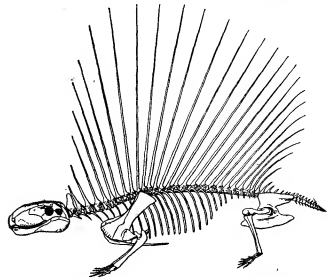

FIG. 5.—*Ichthyosaurus quadriscissus*: outline of specimen showing dorsal and caudal fins, about one-sixth natural size.—Upper Lias, Württemberg. (After E. Fraas.) The irregularities behind the triangular dorsal fin are torn pieces of skin.

Anomodontia, and the shape of the scapula seems to show some connexion with the Chelonina. The truly aquatic Sauropterygians of the Jurassic (fig. 4) and Cretaceous periods possess most

bone normal. They are also represented in the Permian, chiefly of North America, by the so-called Pelycosauria, which have sharp teeth in sockets, and are remarkable for the extreme

elongation of the spines of their cervical and dorsal vertebrae (*Dimetrodon*, fig. 6). They seem to include various Triassic



From Prof. E. C. Case's *Revision of the Paleozooids of North America*, by permission of the Carnegie Institution of Washington.

FIG. 6.—*Dimetrodon incisivus*: restoration of skeleton by E. C. Case, about one-eighteenth natural size.

genera (e.g. *Actosaurus*, *Belodon*), which may perhaps belong to the ancestral stock of the Dinosauria and Crocodylia. Other Triassic genera (*Hyperodapedon*, *Rhynchosaurus*) scarcely differ from *Sphenodon*, except in the dentition and in the absence of the pineal foramen in the skull. In the late Cretaceous and early Eocene periods one genus (*Champsosaurus*) was truly aquatic, with gavial-shaped head.

Order 6. DINOSAURIA.—The dinosaurs are land reptiles which flourished on all the continents during the Jurassic and Cretaceous periods, in the interval between the decline of the Anomodontia and the dominance of the Mammalia. They first appeared as carnivorous reptiles in the Triassic period in Europe, India, S. Africa, and N. America, but afterwards comprised numerous massive herbivores in nearly all parts of the world except the Australian and New Zealand regions. The skeleton in the carnivorous dinosaurs, or Theropoda, is of very light construction, the vertebrae and limb bones being hollow, with thin, dense walls and often perfectly fitting joints. The fore limbs are small, and the hind limbs are adapted for running, jumping or hopping on the toes. The sabre-shaped cutting teeth are fixed in sockets, and all the claws are sharp. *Anchisaurus* and *Hallopus*, from the Trias of N. America, and *Scleromochlus* from the Elgin sandstones of Scotland, are comparatively small animals. *Ceratopsaurus* and *Megalosaurus*, from the Jurassic of North America and western Europe respectively, must have attained a length of from 5 to 6 metres. *Tyrannosaurus*, from the Cretaceous of Montana, U.S.A., has a skull more than a metre in length. The herbivorous Dinosaurs of the suborder Ornithopoda resemble the Theropoda in general shape, but are heavier in build, with a pelvis constructed more nearly on the plan of that of a running bird. It has, indeed, been suggested that certain arboreal Dinosaurs of bipedal gait may have been the ancestors of the class Aves. The best-known Ornithopod is *Iguanodon* (fig. 7), from the Wealden of W. Europe, with species from 5 to 10 metres in length. *Cloosaurus*, from the Cretaceous of N. America, is

nearly similar, and is represented by at least one complete skeleton in the Yale University Museum. There are also members of the same group with a heavy armour of bony plates and spines, sometimes termed Stegosauria. *Siegosaurus* itself occurs in the Upper Jurassic of Colorado, and *Omosaurus*, from the Kimmeridge and Oxford clays of England, is a nearly similar reptile. *Polacanthus*, from the Wealden of the Isle of Wight, has the hip-region armoured with a continuous bony shield. *Triceratops* (fig. 8) and its allies, from the Upper Cretaceous (Laramie) of western N. America, are the latest members of the group, with a bony frill over the neck, a pair of bony horns above the eyes, and a median bony horn-core on the nose. The skull with the bony frill sometimes measures nearly two metres in length. Another suborder of herbivorous Dinosaurs, that of Sauropoda, comprises the largest known land animals of any age, some measuring from 17 to 25 metres in total length. They have a small head, long neck, and long tail, and must have been quadrupedal in gait. Their teeth are adapted for feeding on succulent water weeds, perhaps with an admixture of small animals living among these; and their vertebrae are of very light construction, while the ribs are raised high on the neural arches to increase the size of the body cavity, perhaps for unusually large lungs or air sacs. Their massive limbs have five toes, of which the three inner alone bear outwardly curved claws. *Diplodocus* and *Brontosaurus*, from the Jurassic of Wyoming and Colorado, U.S.A., are the best-known genera. *Atlantosaurus*, from the same formation, is usually noteworthy for size. *Cetiosaurus*, from the Jurassic of England, is also known by large parts of the skeleton in the British Museum and the Oxford Museum, indicating species nearly 20 metres in length.

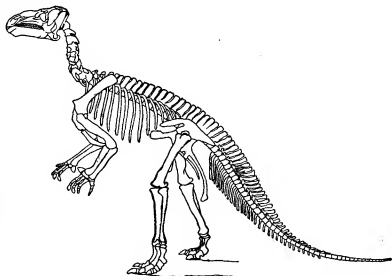

FIG. 7.—*Iguanodon bernissartensis*: restoration of skeleton by O. C. Marsh, about one-eightieth natural size.—Wealden, Bernissart, Belgium.

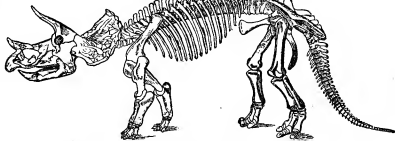

FIG. 8.—*Triceratops prorsus*: restoration of skeleton by O. C. Marsh, about one-eightieth natural size.—Cretaceous, Wyoming.

Order 7. CROCODYLIA.—Typical crocodiles can be traced downwards to the Lower Lias at the base of the Jurassic

formations, but all the Jurassic and some of the Cretaceous genera have the secondary bony plate less extended backwards than that in the Tertiary and existing genera, while their vertebrae have flattened or concave ends, instead of exhibiting a ball-and-socket articulation. Some of the Upper Jurassic crocodiles (*Metricorhynchus*) were more truly aquatic than any now living, with the fore limbs degenerate, the hind limbs much enlarged for swimming, and the dermal armour lacking. The end of the vertebral column is bent downwards, as in *Ichthyosaurus*, so they doubtless possessed a similar triangular tail-fin. Typical crocodiles and alligators date back to the close of the Cretaceous period, and they did not become extinct in Europe until the beginning of the Miocene period. Remains of an extinct alligator (*Diplocynodon*) are common in the Upper Eocene sands of the Hordwell cliffs, Hampshire.

Order 8. ORNITHOSAURIA.—The flying reptiles or Pterodactyls (fig. 9) are completely evolved at their earliest known



FIG. 9.—*Pterodactylus spectabilis*, natural size, from the Lithographic Stone. *h*, humerus; *ru*, radius and ulna; *mc*, metacarpals; *pt*, pteroid bone; 2, 3, 4, digits with claws; 5, elongated digit for support of wing-membrane; *st*, sternum, crest not shown; *is*, ischium; *pp*, prepubis. The teeth are not shown. (After H. von Meyer.)

appearance in the Lower Lias (*Dimorphodon*), and exhibit little essential change as they are traced upwards through the Mesozoic formations. The latest Cretaceous genera, however, comprise the largest species, which have been found in Europe, N. America and Brazil. Some of these (*Pteranodon*) are toothless, and their wings are so large that for adequate support the pectoral arch is fixed to the vertebrae like a pelvis. The wings occasionally have a span of from 5 to 6 metres. The wing-membranes are only known in the European Jurassic genus, *Rhamphorhynchus* (fig. 10), found well preserved in the fine-grained lithographic stone of Bavaria. In this genus there is also a rhomboidal flap of membrane at the end of the tail.

Order 9. SQUAMATA.—The ancestors of the lizards and snakes can only be traced back definitely to the latter part of the Cretaceous period. They were then represented by two suborders of aquatic reptiles, the Dolichosauria and Pythonomorpha (or Mosasauria), which are in many respects intermediate between the existing Lacertilia and Ophidia. The Dolichosauria, from the Upper Cretaceous of Europe, are small and snake-like

in shape, but with completely formed limbs. The Pythonomorpha are known from Europe, N. and S. America and New Zealand, and sometimes attained a very large size, the typical *Mosasaurus camperi* from Maastricht being about 15 metres in length. Their limbs are powerful paddles. Their trunk and

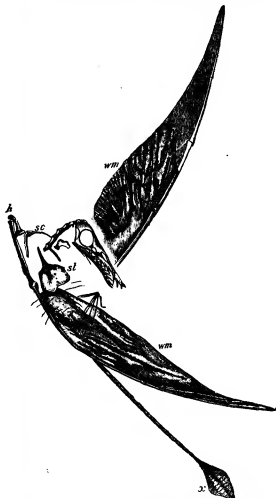

FIG. 10.—*Rhamphorhynchus phyllurus*, from the Solenhofen Lithographic Stone, about $\frac{1}{2}$ natural size, with the greater part of the wing-membranes preserved. *x*, caudal membrane; *st*, sternum; *h*, humerus; *sc*, scapula and coracoid; *wm*, wing-membrane. (After O. C. Marsh.)

tail are often much elongated, so that their shape is snake-like, as shown by *Clidastes* (fig. 11), from the Chalk of Kansas, U.S.A. The Lacertilia and Ophidia, so far as known, are exclusively Tertiary and Recent reptiles. Marine snakes (*Palaeophis*) occur in the Eocene of the London and Hampshire basins.

AUTHORITIES.—General Works on Extinct Reptiles.—K. A. v. Zittel, *Handbuch der Palaeontologie*, vol. iii. (Munich, 1887-1889).—H. A. Nicholson and R. Lydekker, *Manual of Palaeontology*, vol. ii. (Edinburgh, 1889).—R. Lydekker, *Catalogue of the Fossil Reptilia and Amphibia in the British Museum*, vols. i-iv. (London, 1888-90).—A. S. Woodward, *Outlines of Vertebrate Palaeontology* (Cambridge, 1898).—K. A. v. Zittel, *Text-book of Palaeontology*, ed. C. R. Eastman, vol. ii. (London, 1902). *Anomodontia*: R. Owen, *Catalogue of the Fossil Reptilia of South Africa in the Collection of the British Museum* (London, 1876).—E. D. Cope, "The Reptilian Order Cotylosauria," *Proc. Amer. Phil. Soc.* vol. xxvii. (1896), p. 436, and vol. xxxv. (1896), p. 122.—E. T. Newton, "Some New Reptiles from the Elgin Sandstones," *Phil. Trans.*, vol. 184B (1893), p. 431.—Various papers by R. Owen in *Quart. Journ. Geol. Soc.*, 1879-1884, by H. G. Seeley in *Phil. Trans.* (1889-1895), and by R. Broom in *Proc. Zool. Soc. Ann. S. African Museum and Trans. S. African Phil. Soc.* (from 1900 onwards). *Chelonia*: G. Baur, "Bemerkungen über die Phylogenie der Schildkröten," *Anat. Anzeiger*, vol. xii. (1896), p. 561.—Technical papers by F. A. Quenstedt in *Württ. Jahresh. vol. xiv.* (1889), p. 120 (*Proganochelys*).—G. R. Wieland in *Amer. Journ. Sci. ser. 4*, vol. ii. (1896), p. 399 (gigantic Cretaceous leathery turtle), and E. C. Case, *Journ. Morphol.* vol. xiv. (1897),

p. 21 (ditto). **Sauropyrgia:** G. A. Boulenger, "On a Nothosaurian Reptile from the Trias of Lombardy, apparently referable to *Lariosaurus*," *Trans. Zool. Soc. vol. xiv.* (1896), p. 1.—H. G. Seeley, "The Nature of the Shoulder Girdle and Clavicular Arch in Sauropyrgia," *Proc. Roy. Soc. vol. li.* (1892), p. 119,

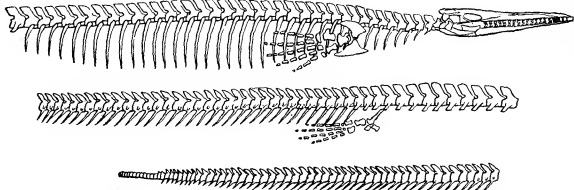

FIG. 11.—Skeleton of *Clidastes*. (After Cope.)

and vol. liv. (1893), p. 160. **Ichthyopterygia:** E. Fraas, *Die Ichthyosaurier der süddeutschen Trias- und Jura-Ab Lagerungen* (Tübingen, 1891).—J. C. Merriam, "Triassic Ichthyosauria," *Mem. Univ. California*, vol. i. No. 1 (1908).—Also technical papers by E. Fraas on fins in *Würt. Jahresh.* (1894), p. 493, and *Földtani Közlemény*, vol. xxviii. (Budapest, 1898), p. 169. **Rhynchocephalia:** G. A. Boulenger, "On British Remains of *Homosaurus*, with Remarks on the Classification of the Rhynchocephalia," *Proc. Zool. Soc.* (1891), p. 167.—J. H. McGregor, "The Phytosauria," *Mem. Amer. Mus. Nat. Hist.*, vol. ix. pt. ii. (1906).—E. C. Case, *Revision of the Polycosauria of North America* (Carnegie Institution, Washington, 1907).—Technical papers by H. Credner in *Zeitschr. deutsch. geol. Ges.* vol. xl. (1888), p. 488 (*Palaeohatteria*), T. H. Huxley in *Quart. Journ. Geol. Soc.* vol. xliii. (1887), p. 675 (*Hyperodapedon*), and L. Dollo in *Bull. Soc. Belg. Géol.* vol. v. (1891), *Mém.* p. 151 (*Champsosaurus*). **Dinosauria:** O. C. Marsh, "The Dinosaurs of North America," *Sixth Ann. Rept. U.S. Geol. Survey* (1866).—Technical papers by L. Dollo in *Bull. mus. roy. d'hist. nat. Belg.* vols. i-iii. (1882-84) (*Iguanodon*), O. C. Marsh in *Amer. Journ. Sci.* ser. 3, vol. i. (1895), pl. viii. (restorations), J. B. Hatcher in *Mem. Carnegie Museum*, vol. i. No. 1 (1901), and W. J. Holland in *Mem. Carnegie Museum*, vol. ii. No. 6 (1906). **Crocodylia:** T. H. Huxley, "On *Stagonolepis robertsoni*, and on the Evolution of the Crocodylia," *Quart. Journ. Geol. Soc.* vol. xxxi. (1875), p. 423.—E. Koken, "Thoracosaurus macrorhynchus, Bl. aus der Tuffkreide von Maas-tricht," *Zeitschr. deutsch. geol. Ges.* (1888), p. 754.—E. Fraas, "Thattosuchia," *Palaeontogr.* vol. xlix. (1902), p. 1.—L. Dollo, "Première note sur les crocodiliens de Bernissart," *Bull. mus. roy. d'hist. nat. Belg.* vol. ii. (1883), p. 309.—G. A. Boulenger, *Catalogue of the Chelonians, Rhynchocephalians and Crocodyles in the British Museum* (London, 1889). **Ornithosauria:** K. A. von Zittel, "Ueber Flugsaurier aus dem lithographischen Schiefer," *Palaeontogr.* vol. xxix. (1882), p. 49.—E. T. Newton, "On the Skull, Brain and Auditory Organ of a New Species of Pterosaurian," *Phil. Trans.* vol. 179b (1888), p. 503.—H. G. Seeley, *Dragons of the Air* (London, 1901).—Technical papers by O. C. Marsh in *Amer. Journ. Sci.* ser. 3, vol. xxiii. (1882), p. 251 (wing-membranes), S. W. Williston in *Kansas Univ. Quarterly*, vol. vi. (1897), p. 35 (restoration of *Pteranodon*), and G. F. Eaton in *Amer. Journ. Sci.* ser. 4, vols. xvi., xvii. (1903-4). **Squamata:** R. Owen, "On the Rank and Affinities of the Reptilian Class of the Mosasauridae, Gervais," *Quart. Journ. Geol. Soc.* vol. xxxiii. (1877), p. 682, and vol. xxxiv. (1878), p. 748.—G. A. Boulenger, *Catalogue of the Lizards in the British Museum*, vols. i-iii. (London, 1885-87); *Catalogue of the Snakes in the British Museum*, vols. i., ii. (London, 1893-94).—Technical papers by A. Kornhuber in *Abh. k. k. geol. Reichsanst. Wien.* vol. v. (1873), No. 4, and vol. xvii. (1893), No. 3 (*Dolicho-sauria*), F. Noposa in *Beitr. Paläont. Oesterr.-Ungars.* vol. xxi. (1908), and S. W. Williston in *Kansas Univ. Quarterly*, vols. i., ii., vi. (1892-1897) (*Mosasauria*). (A. S. Wo.)

III. ANATOMY OF REPTILES The Skull.

Sphenodon has the most primitive and still most complex skull, the salient features of which it is easy to derive from Stegocephalian and early, generalized reptilian conditions; whilst in other directions, mostly by reduction, the skull of this "living fossil" affords the key to that of all the other groups of at least recent reptiles. The main features are the following. There are, in the temporal region, three complete bony arches,

the supra-, infra-, and post-temporal, which subdivide the whole temporal fossa into four foramina. The supratemporal bridge is formed by the squamosal and post-orbital, the latter (*jin* fig. 12) being continued forwards and fused with the post-frontal.

These three bones, with the parietal, enclose the supratemporal foramen. The postorbital joins an ascending branch of the jugal, both together forming the hinder border of the orbit, and this is bordered below chiefly by the maxillary. The posterior temporal bridge is formed by the parietal and squamosal, extends laterally over the

quadrate and encloses a wide space between itself and the buttress-like transverse expansion of the lateral occipital

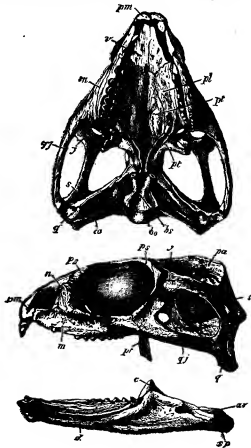

After Günther. FIG. 12.—Skull of *Sphenodon*.

1, Ventral aspect; 2, lateral aspect; 3, lateral aspect of mandible. ar, articular; bo, basioccipital; bs, basisphenoid; c, coronoid; ca, columella auris; d, dentary; j, postorbital; m, maxilla; n, nasal; pa, parietal; pl, palatine; pm, premaxilla; pr, prefrontal; ps, postfrontal; pt, pterygoid; q, quadrate in the upper figure, quadrato-jugal in the middle figure; gj, jugal; s, squamosal; sp, splenial; v, vomer.

bone (these "parotic processes" are made up of the lat. occipital, parotic and opisthotic bones); this is the post-temporal foramen. The space enclosed between this occipital buttress, the quadrate and the pterygoid support of the latter represents the wide and large cavity of the middle ear,

and as such is crossed by the auditory columellar chain. The infra-temporal bridge or jugal arch is formed by the jugal (*qj* in fig. 12), which joins the descending process of the squamosal, and the quadrato-jugal, which is very small and partly fused with the lateral side of the quadrate. Now, between the quadrate on the one side and the squamoso+quadrato-jugal+jugal on the other, is enclosed a gap, met with only in *Sphenodon* of recent reptiles. This fourth, or quadrato-squamosal foramen, with its squamoso-quadrato-jugal bridge, is, as a rule, not mentioned, being too small to be obvious. The quadrate is very firmly fixed. On the ventral side of the cranium we notice the broad and long bony palate, the large vomers, and the pterygoids meeting in the middle line; aside of the vomers are the long posterior nares; posteriorly the pterygoids diverge to rest upon short basi-sphenoid processes, and they articulate by short flanges with the quadrates.

The occipital condyle is kidney-shaped, triple, composed of the basi and the lateral occipitals. The dorsal median roof of the cranium is formed by the paired parietals, near their anterior symphysis with the large pineal foramen, the paired frontals, nasals and premaxillaries. The outer nares are surrounded by the premaxillaries, maxillaries and nasals. Prefrontals and postfrontals exist. There is a complete cartilaginous, inter-orbital septum, and a cranial columella, a pair of upright buttresses arising in the alisphenoidal walls, connecting the parietals with the pterygoids. The hyoid apparatus consists of a narrow base, with three pairs of arches; of these the first or hyoid arch is variously connected with the cranium near the paroccipital process, or with the extracolumella (see *Middle Ear*, below); the others are a long and stout pair of first and a smaller pair of second branchial arches.

Crocodylians.—The temporal region is still bridged over by three arches, dividing the whole fossa into three, very much as in *Sphenodon*. The supratemporal foramen is bordered by the parietal, postfrontal (postorbital absent) and squamosal. The posttemporal foramen is very much reduced, sometimes to a narrow passage between the parietal, occipitals and squamosal, because the latter bone forms an extensive suture with the paroccipital process. The infratemporal or lateral fossa is wide and rather shallow, bordered above by the postfrontal and squamosal, in front by the postfrontal and jugal, below by the jugal and quadrato-jugal, behind by the latter, the quadrate, tip of the paroccipital and the squamosal. The quadrato-jugal being long and in an almost horizontal position, being wedged in between the jugal and nearly the whole length of the lateral edge of the quadrate, and there being no squamoso-quadrato-jugal bridge, the fourth foramen of *Sphenodon* is absent. The middle-ear cavity is reduced to a complicated system of narrow passages; one for the passage of the extra-columellar-mandibular string of the auditory chain (see *Ear*, below), between the quadrate, paroccipital and lateral occipital bones; another passage (*Eustachian*) opens in the roof of the mouth, between basioccipital and basisphenoid; a third joins that of the other side and forms with it a median opening between the same bones, just behind the posterior pterygoid border of the choanae. These nares, being in the recent crocodylians shifted as far back as possible, communicate with the outer nostrils by very long passages, formed by the whole length of the pterygoids, palatines, maxillaries, vomers and pre-maxillaries, all of which form a long median suture. But this long bony palatal roof is interrupted by a pair of large palatal foramina, bordered usually by palatine, pterygoid, ectopterygoid, or transverse bone and maxillary. On the dorsal side of the cranium we notice the parietals fused into an unpaired bone, without a pineal hole and the likewise unpaired frontal. There are a pair of postfrontals, prefrontals and lacrymals perforated by the naso-lacrymal duct. The nasals vary much in length, mostly in conformity with that of the maxillaries; as a rule they reach the short premaxillaries, but not always the nasal groove. (For taxonomic detail see under CROCODYLE.)

The occipital condyle is formed mainly by the basioccipital, which always borders part of the foramen magnum, but the

lateral occipitals each send a flange to it, which in immature specimens still partakes of the articulation with the atlas. The opisthotic and epiotic bones fuse early with the lateral and with supraoccipital bones; only the prootic remains longer as a separate element, anteriorly with a large hole for the exit of the third branch of the trigeminal nerve. The basisphenoid is scarcely visible, being overlaid by the pterygoids. The pre-sphenoid is larger, continued forwards and upwards into the inter-orbital septum, which remains mostly cartilaginous. Near the anterior and upper margin of the pre-sphenoid is a large notch on either side for the passage of the optic nerve, the three eye-muscle nerves and the first branch of the trigeminal. The place of the orbitosphenoids is taken by membrane or cartilaginous continuations of the interorbital septum, but the alisphenoids are large and abut upwards against the frontals and with a lateral flange against the postfrontals. These send down a conspicuous process which forms sutures with an upward process of the jugal and another of the ectopterygoid; it is this compound pillar which partly divides the orbit from the infratemporal or lateral fossa. The size of these and the upper temporal fossae stand in an inverse ratio to each other. The upper fossae are still comparatively large in the long-snouted *Gavialis* and *Tomistoma*, whilst these holes almost completely disappear in the alligators, namely, in the broad- and short-snouted members of the order, which chew their prey. In extinct Crocodylians the upper fossae were the larger. The temporo-mandibular muscle which lifts or shuts the lower jaw arises from the walls of the upper fossa, passes beneath the jugal-arch and is inserted upon the supra-angular portion of the lower jaw. In the more recent crocodylians this muscle is more and more superseded by the pterygo-mandibular muscle, which, arising chiefly from the dorsal surface of the much-broadened pterygoid, fills the widened space between the latter and the quadrate, and is inserted into the outer surface of the angular bone. The arrangement of this muscle secures a more advantageous leverage of the jaw, and is capable of more powerful work than the other, which is consequently on the wane—a nice illustration of onward, orthogenetic evolution. The dentary bones of the under jaw form a suture, later a symphysis; this is very long in the long-snouted genera, in which the splenials likewise form a long symphysis; in the others the mandibular symphysis is much shorter and the splenials remain widely separated. The articular bone is short, forms a transverse cup for the quadrate, or a saddle-shaped cup, and is perforated by the *Siphonium* (see below under *Ear*). The angle is upturned, formed by the articular, angular and, laterally, by the supra-angular bone; the opercular or counter-part of the splenial lies on the outer side, forming part of the anterior border of the oval foramen in the jaw.

The Chelonian skull agrees in many important features with that of *Sphenodon* and of the crocodylians, but it is composed of fewer bones, the ectopterygoids, lacrymals and postorbitals being absent, often also the nasals, unless they are fused with the prefrontals. The vomer is unpaired and forms a septum between the nasal passages, which, except in *Sphargis*, are ventrally roofed over to a variable extent by wings sent out by the palatines, joining the sides of the vomer. Most of the configurations of the other cranial bones are well represented in the accompanying figures. The palatines form a continuous broad floor with the pterygoids, which are extensively and firmly joined to the quadrates and to the basisphenoid. There are no Eustachian tubes. The occipital condyle is distinctly triple and the basioccipital is frequently excluded from the foramen magnum. The lateral occipitals early send out a pair of stout wings, the ventral of which joins a stout ventrolateral process of the basioccipital, both forming a thick knob especially in *Chelone*, and a dorsolateral wing, which broadly joins the large opisthotic bone. This connects the lateral occipital and the supraoccipital with the upper portion of the quadrate. On the top of the quadrate and upon the lateral dorsal portion of this compound transverse process (which of course corresponds to the paroccipital process of crocodylians, &c.) lies the squamosal, about which more presently. The two wings of the lateral

occipital, part of the opisthotic, the quadrate, and part of the pterygoids, form the bony borders of the middle ear-cavity, the parietals. They represent of course the columellae cranii or pterygoidal columellae; if they are of alisphenoidal origin the term epipterygoids is a misnomer; the same applies to these structures in other reptiles. Through the space enclosed by the pterygoid, basioccipital, opisthotic and quadrate, enters the cranial carotid artery, sometimes piercing the posterior rim of the pterygoid; then the canal runs along the dorsal side of this bone and opens near the cranial columella. The arcades over the temporal region are most variable. Potentially Chelonians possess all the three arcades of the crocodiles, but it so happens that never more than one fenestra is present. The false roof over the temporal region is most complete in *Sphargis* and in the *Chelonidae*. Excepting *Sphargis* the supraoccipital extends far beyond the back of the cranium in shape of a long unpaired crest, which never diverges, or sends out lateral processes, but it is joined, and partly overlaid for a great part of its length, by the parietals in *Chelonidae* and *Sphargis*. In these genera the much-enlarged parietal, the equally large postfrontal, with the squamosal behind, the jugal below, and a large quadrato-jugal, form one continuous bony roof over the whole temporal fossa, which is widely open behind, the space being bordered by supraoccipital, opisthotic, squamosal and parietal. All other Chelonians show a great reduction of this roof. The parietal does not send out dorsolateral expansions; and the postfrontal likewise forms no expansions. It joins the rather short malar, forming the posterior orbital bridge, which posteriorly is connected by the quadrato-jugal with the upper

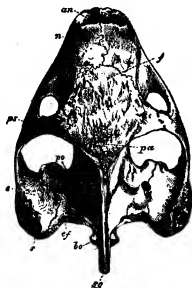

FIG. 13.—Dorsal aspect of skull of *Testudo tabulata* (from nature). *an*, anterior nares; *f*, frontal, on either side of which are the orbits, bounded behind by *ps*, the postfrontal; *bo*, basioccipital; *ep*, epiotic; *so*, supraoccipital; *q*, quadrate; *s*, squamosal; *pa*, parietal; *jo*, petiotic bones.

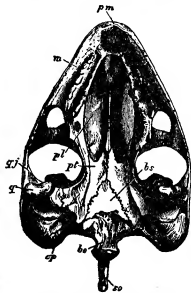

FIG. 14.—Ventral surface of skull of *Testudo tabulata* (from nature). *bo*, basioccipital; *bs*, basisphenoid; *ep*, epiotic; *m*, maxilla; *pl*, palatine; *pm*, premaxilla; *pt*, pterygoid; *q*, quadrate; *qj*, quadrato-jugal; *so*, supraoccipital.

which is open behind; through it extends horizontally the columellar rod, received with its outer portion by a notch on the posterior side of the quadrate. This is of very complicated shape. Its outer margins form most of the tympanic frame; the posterior margins being curved backwards leave a wide notch behind in the *Cryptodira* and in *Sphargis*, but in the *Pleurodira* this part of the quadrate is transformed into a trumpet, the rim of which, forming a complete ring, carries the tympanic membrane. The tympanic cavity thus formed often leads into a deep recess which extends into the hollowed-out squamosal (e.g. in *Testudo*) towards the opisthotic and bears some resemblance to the intricate tympanic recesses which pervade that region of the crocodile's skull. With its upper anterior and

portion of the quadrate and with the squamosal. The latter rests upon the quadrate and is in no connexion with the parietal. Consequently the whole temporal fossa is quite open. The horizontal bridge or arcade is to a certain extent homologous with the infra-temporal arcade. All the bones which border the temporal fossa vary much in extent. The greatest reduction has taken place in *Cistudo* and in *Geoemyda*, the latter an Indian genus of *Testudinidae*, in which the quadrato-jugal is lost, leaving a wide gap in the horizontal arcade.—The Chelonians form an instructive parallel to mammalian conditions by the broad contact of the squamosal with the malar, e.g. in *Chelone*, whilst the quad-

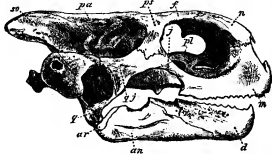

FIG. 15.—Side view of skull of *Testudo tabulata* (from nature). *an*, angular; *ar*, articular; *d*, dentary; *f*, frontal; *j*, jugal; *m*, mandible; *n*, naso-prefrontal; *pa*, parietal; *pl*, palatine; *ps*, postfrontal; *q*, quadrate; *qj*, quadrato-jugal.

inner portion the quadrate joins the large proötic bone which is usually completely fused with the rest of the opisthotic, but in *Sphargis* it remains separate, and in this turtle the sutures between the otic bones and the supraoccipital also persist. In front of the proötics the bony lateral walls of the brain-case end in *Sphargis*, but in most of the other Chelonians bony alisphenoids are represented by a pair of epipterygoids which rest upon short upward processes of the pterygoids and are joined by much longer, rather thin, but broad descending lamellae from

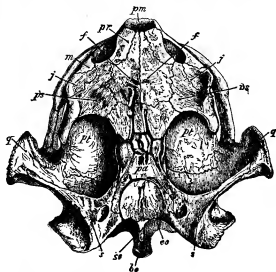

FIG. 16.—Dorsal Aspect of Skull of *Chelys matamata*. *bo*, basioccipital; *eo*, supraoccipital; *f*, frontal; *j*, jugal; *m*, maxilla; *pm*, premaxilla; *pa*, parietal; *pr*, prefrontal; *ps*, postfrontal; *pt*, pterygoid; *q*, quadrate; *s*, squamosal; *so*, supraoccipital.

rato-jugal, having in all Chelonians lost its original ventral connexion with the jugal, may actually get lost as in all the

Lacertilia. The zygomatic arch of the Mammalia is formed (cf. also Agamidae) out of the supratemporal arch of *Sphenodon*,

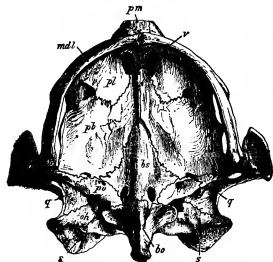

FIG. 17.—Ventral Aspect of Skull of *Chelys matamata*. *bo*, basioccipital; *bs*, basisphenoid; *mdl*, mandible; *oh*, opisthotic; *pl*, palatine; *pm*, premaxilla; *po*, prootic; *pb*, pterygoid; *q*, quadrate; *s*, squamosal; *v*, vomere.

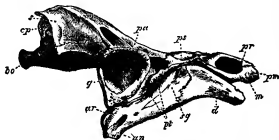

FIG. 18.—Lateral Aspect of Skull of *Chelys matamata*. *an*, angular; *ar*, articular; *bo*, basioccipital; *d*, dentary; *op*, opisthotic; *m*, maxilla; *pa*, parietal; *pm*, premaxilla; *ps*, postfrontal; *pt*, pterygoid; *q*, quadrate; *s*, squamosal; *sg*, supra-angular.

after the loss of the postorbital element and of the quadrato-jugal, the squamosal gaining connexion with the upper, not posterior and ventral, branch of the jugal or malar bone.

The mandibular halves form a complete osseous symphysis, the only instance in reptiles; all the other elements retain their sutures. The articular portion of the articular bone forms several shallow cups and a slight anterior knob, best developed in *Chelone*. The angular bone does not help to form the posterior upper angle. The coronoid, or complementary element, is often small; the supra-angular and the splenial or opercular are always present, mostly also a pre-splenial wanting in Testudinidae (cf. G. Baur).

The hyoid apparatus is well developed, and sometimes assumes large dimensions, especially in *Chelys*. The two pairs of "horns" are the first and second branchial arches, whilst the hyoid arches are reduced to a pair of small, frequently only cartilaginous nodules, attached near the anterior corners of the basis linguae, which generally fuses with the os entoglossum in the tip of the tongue. In Chelydidae the long median basal or copular piece forms a semi-canal for the reception of the trachea.

In the skull of the Lacertilia the arcades over the temporal region vary much in composition and numbers. There are at most two arcades and two windows. First the posttemporal arcade, enclosing the posttemporal fenestra, which is framed mainly by the large paroccipital process below and the long parietal process above, both meeting distally, and the quadrate is carried by the paroccipital process. In the corner, in front, where the three bones meet, lies the squamosal, connecting parietal and quadrate. This squamosal, when not too much

reduced, has an upper parietal and an anterior horizontal arm; the latter is essential for the formation of the second horizontal arcade, which makes the lower border of the supra-temporal window. The infra-temporal arcade, namely a quadrato-jugal + jugal arch, is absent in all Lacertilians owing to the complete absence of the quadrato-jugal element.

In *Heloderma* and Geckos the posttemporal is the only arcade. In the Amphisbaenids and in *Aniella*, practically also in *Anelytropsis*, all the arcades are lost. All the other families

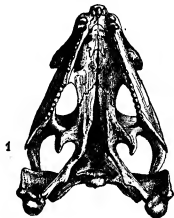

FIG. 19.—Skull of *Chlamydosaurus kingii* (old male), showing much differentiated teeth. 1, ventral aspect; 2, posterior; 3, profile, showing the enormous process at the hinder end of the lower jaw.

of lizards and the chameleons have two arcades. We begin the description of the horizontal arcade with those families in which it is most complete, and most like that of *Sphenodon*. In *Varanus* it is formed by four bones. The postfrontal is short; it is attached the postorbital, which sends a long horizontal process to join the squamosal¹ splint, and this connects with the

¹ There is a much-debated question of the homologies of the one or two elements, both apparently membrane bones, which connect the upper end of the quadrate with the parietal and with the supra-temporal arch. The question becomes acute in the snakes, whether the single element connecting skull and quadrate has to be called squamosal or supra-temporal. Space forbids here to expound the matter, which has been very ably reviewed by S. W. Williston ("Temporal Arches in the Reptilia," *Biolog. Bulletin*, vii. No. 4, 1904, pp. 175-192; cf. also F. W. Thyngh, *Tufts College Studies*, II. 2, 1906). About ten different names have been applied to these two elements, and two, namely, squamosal and supra-temporal, are being used quite promiscuously. When only one element is present, the present writer uses the term squamosal, and there are reasons making it probable that this element is the squamosum of mammals. When both elements are present, the more ventral or lateral of the two is termed squamosal, that which always helps to form the

upper anterior end of the quadrate; between the quadrate, the squamosal and the long parietal process lies the likewise splint-like supratemporal, attached by most of its length to the parietal process. The jugal has only one arm, and this connects the maxilla with the postorbital, completing the posterior orbital border. There is a wide gap between jugal and quadrate. In *Tejidae* the arcade is the same, but the squamosal reaches the jugal, both meeting the postorbital. In *Lacerta* the arcade is essentially the same, but the window is completely filled up by the postfrontal, which extends so far back as to reach the supra-

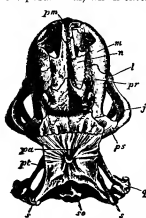

FIG. 20.—Dorsal aspect of skull of *Heloderma horridum*. *f*, frontal; *j*, jugal; *l*, lachrymal; *m*, maxilla; *na*, nasal; *pa*, parietal; *pm*, premaxilla; *pr*, postfrontal; *ps*, postfrontal; *pt*, pterygoid; *q*, quadrate; *s*, squamosal; *so*, supraoccipital.

The chameleons are peculiar. The posttemporal arcade, spanning a wide space, is formed by a long process of the supra-

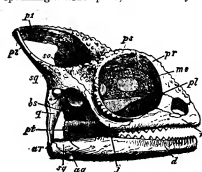

FIG. 21.—Skull of *Chamaeleon vulgaris*. *ag*, angular; *ar*, articular; *bs*, basisphenoid; *d*, dentary; *j*, jugal; *m*, maxilla; *me*, median ethmoid; *pt* and *ps*, parietals; *pl*, palatine; *pr*, postfrontal; *pt*, pterygoid; *q*, quadrate; *sg*, supra-angular; *so*, supraoccipital; *sg*, squamosal.

temporal parts of the skull, are firmly joined to lateral processes of the pterygoids by the ectopterygoids; further forwards they are extensively connected with the maxillaries. These rest against strong transverse palatine processes. The palatines form a medium symphysis; posteriorly they diverge together with the pterygoids, which articulate with the quadrate. Both elements are present in Labyrinthodonts and in most of the extinct groups of reptiles; among recent forms in *Lacertidae*, *Varanidae*, *Tejidae*; one three-armed piece in *Sphenodon*, chameleons and crocodyles, without, in *Sphenodon* at least, any trace of a compound nature; one piece, forked, in *Agamidae*; one simple piece in most of the other *Lacertilia*, and in snakes.

rates and with the basisphenoid by a pair of strong basiptyergoid processes. A slender vertical rod of bone, the columella cranii, arises from the dorsal surface of each pterygoid and, passing at a distance from the cranial capsule, is sutured to a short lateroventral process of the parietals. Such a pair of columellae exists in nearly all *Lacertilia* (distinguished by many systematists as *Komocronania*) with the exception of the chameleons and the *Amphisbaenidae*. In many lizards, however, this columella, or epipterygoid, does not quite reach the parietal, leaning instead against the prootic; possibly it has been evolved out of the alisphenoid, and Chelonians seem to support this view. The premaxillary bone is single, except in the *Skins* and in some *Geckos*; ventrally it touches the vomers which vary much in size; they are always paired although suturely connected; posteriorly they pass into, and fuse with, the palatines before these send off their maxillary processes. Between the vomer and its maxillary is a longitudinal hole. Often, e.g. in *Lacerta*, the vomers enclose a median hole near their anterior end, for Jacobson's organ. Dorsally the premaxilla sends a median process backwards to the nasals. These are paired, and fuse together only in *Uroplates* and in *Varanus*. The external nasal fossae are sometimes very large, and their anterior half appears blocked by the ossified turbinals, e.g. in *Varanus* and *Tejus*. Prefrontals are always present, often fused with the lacrymals; in *Heloderma*, in *Aniella* and in chameleons the prefrontals extend so far back as to meet the postfrontals, excluding thereby the frontals from the orbital rim. The frontals are either paired, as in *Varanus*, *Lacertidae*, *Heloderma*, *Anguidae*, *Scincidae*, *Anelytropsidae*, *Aniella*, *Amphisbaenidae*, and in some *Geckoninae*; or they are fused into one bone, as in the *Eublepharinae*, chameleons, *Tejidae*, *Iguanidae*, *Agamidae*, *Xenosaurus*. The parietals are double in the *Geckos*, in *Uroplates* and *Xantusia*; in all the others they form one coëssified mass, generally with a pineal foramen, except in *Eublepharinae*, *Amphisbaenidae*, *Tejidae*, and *Aniella* and other degraded forms. In the majority the pineal foramen lies in the middle of the parietal, but in the *Iguanidae* it is near the frontal, and actually in the frontal in chameleons.

As regards the brain-case, there is a cartilaginous interorbital septum, connected posteriorly with the slender, bony presphenoid; ventrally on this is fused a vestige of the parasphenoid, a narrow and thin splint which sometimes can be dislodged. The whole of the anterior wall of the brain-case is membranous, excepting a pair of separate ossifications, which do but rarely touch any of the cranial bones, as frontal, parietal or prootics. The ossifications are irregular in shape, each sending out a downward process which curves inwards almost to meet its fellow; between these issue the olfactory lobes. W. K. Parker recognized them as the alisphenoids; E. D. Cope named them postotics, and remarked that in *Sphenodon* they coexist with an orbitosphenoid bone. The prootic has a notch in its anterior lateral margin for the passage of the trigeminal nerve. The opisthotic portion of the petrosal mass is intimately fused with the lateral occipital bones and their paroccipital process, and sometimes, e.g. *Tejus*, encloses with them many intricate recesses of the middle ear-chamber, which extend also into hollow and swollen thick downward processes of the basioccipital. These cavities of both sides communicate with each other through the cancellous substance of the basioccipital and basisphenoid. There are no Eustachian tubes opening into the mouth through the base of the skull.

The occipital condyle is tripartite, the lateral occipitals partaking of the articulation; very rarely, e.g. in *Amphisbaenidae* (see fig. 22), the basioccipital portion is so much reduced that the skull articulates by two very broad condyles.

The halves of the under jaw are but loosely united, either by ligament only or by an at least very movable suture. The jaw is compound and the numerous constituent bones mostly retain their sutures. Besides the dentary and articular, angular and supra-angular on the lateral side, and the opercular or splenial on the inner side, there lies on the dorsal side the coronoid, six pairs in all. The posterior angle of the jaw

is always formed by the articular bone, not by the angular which lies on the ventral side, about the middle of the jaw; it is fused with the articular in Geckos, some Tejidae, Amphisbaenidae, and some other burrowing kinds. The splenial is absent in chameleons; near the vanishing point in some of the Agamidae. The coronoid is always present, for the insertion of masseter muscles. In the pleurodont lizards the outer wall of the dentary forms a ledge, against the inner side of which are fixed the teeth with cementum.

The snakes' skull shows many peculiarities, and most of the bones of the cranial capsule fuse together without sutures. The occipital condyle is triple, the lateral occipitals and the basioccipital taking equal share in its composition; the basioccipital is excluded from the foramen magnum; frequently one common epiphysal pad covers this tripartite condyle. The supraoccipital is likewise excluded from the margin of the foramen magnum by the lateral occipitals. The basisphenoid is prolonged forwards into a long sphenoidal rostrum, on the upper surface of which the trabeculae cranii, which persist as cartilages, extend forwards to blend with the median ethmoidal cartilage. There are no ali- and no orbitosphenoids, their places being taken by downward extensions of the frontal bones, which descend to this sphenoidal rostrum and then turn inwards to meet together on the floor of the cranial cavity. There is consequently no interorbital septum. The parietals also descend laterally, but unite with the basisphenoid by suture. On

which projects a little beyond the occiput; there is no parietal or pineal foramen. There are paired frontals, postfrontals, prefrontals and nasals; the latter are said to coössify in *Charina* only.

The position of the prefrontals is variable. In the boas, for instance, they meet, separating the nasals from the frontals; they are in contact with the nasals in the boas, burrowing snakes and in *Xenopeltis*, but more or less widely separated from them, and often from each other, in the Colubridae and Viperidae. The premaxillary is single, and only in Glauconidae connected with the maxillaries; in the others it is but loosely connected with the ethmoidal end of the skull, for instance, with the turbinals, which are osseous and well developed in pythons.

The whole appendicular apparatus is most loosely attached to the skull, at least in the typical snakes, and since they do not chew their prey but only hook it in, so to speak, during the act of swallowing, the whole apparatus is as movable as possible.

The whole palatal apparatus shows many modifications, but the maxillaries, palatines and pterygoids always remain widely asunder, and from the mid-line. Some of the modifications, so far as they are used for taxonomic purposes, are mentioned in the article SNAKES: *Classification*. In the majority of snakes the maxillaries form the borders of the mouth, and they are but loosely attached to the other bones, to their palatine processes, to the palatines, and with their posterior ends, by the ectopterygoids to the pterygoids. In the Viperidae the maxillaries are much shortened and articulate extensively with the prefrontals; they can be erected, or rather pushed forwards, by the ectopterygoids (see SNAKES); they are not connected with the palatines. The pterygoids diverge posteriorly and articulate loosely with the quadrate; in the original condition the articulation is near the distal end of the quadrate, e.g. in Boidae, and the pterygoids may form an additional attachment with the mandibles; in the Viperidae the pterygoids are somewhat shortened and are attached to about the middle of the quadrate shaft; in the Amblycephalidae they are still shorter and do not reach these bones. The ectopterygoids are lost by the burrowing Typhlopidae and Glauconidae. The quadrate is always extremely movable; besides being in a most curious way connected with the outer end of the columellar rod (see below, *Ear*), it is suspended from the skull by the squamosal. The squamoso-quadrate connexion is very loose; that of the squamosal with the skull varies much. In the majority of snakes it slides quite freely on the parietal; it is much longer than the quadrate in the boas, much shorter than the elongated and slender quadrate in most of the poisonous snakes. Lastly, in most of the ancient burrowing snakes, e.g. *Typhlops*, *Glauconia*, *Ilysia* and *Uropeltis*, the squamosal has worked its way into the cranial wall so that the quadrate, itself also much shortened, rests directly upon the cranium.

The Vertebral Column.

The vertebrae of all reptiles are gastrocentrous, that is to say, the centra or bodies of the vertebrae are formed by the originally paired, intervertebral cartilages, while the basiventrals are reduced, persisting either as so-called intercentra or wedge-bones, or as intervertebral pads, or disappearing altogether; the basidual elements form the neural arch. At the earlier stages of development the gastrocentrous vertebrae behave in the same way as in the Urochela, except that the interdorsal pair of elements is suppressed from the beginning (the very elements which in

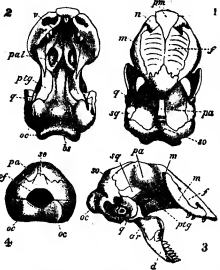

FIG. 22.—Skull of *Monopeltis sphenorhynchus*. 1, dorsal aspect; 2, ventral aspect; 3, lateral aspect; 4, posterior aspect. *ar* articular; *bs*, basisphenoid; *d*, dentary; *f*, frontal; *m*, maxilla; *n*, nasal; *oc*, occipital condyles; *of*, occipital foramen; *pal*, palatine; *pa*, parietal; *pm*, premaxilla; *ptg*, pterygoid; *q*, quadrate; *sq*, supraoccipital; *sg*, squamosal; *v*, vertebra.

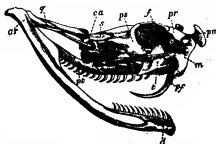

FIG. 24.—Skull of *Viper nasicornis*. *ar*, articular; *ca*, columella auris; *d*, dentary; *f*, frontal; *m*, maxilla; *pm*, premaxilla; *pr*, prefrontal; *ps*, postfrontal; *pt*, pterygoid; *q*, quadrate; *s*, squamosal; *t*, transversum or ectopterygoid.

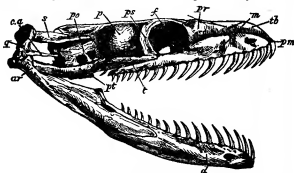

FIG. 23.—Skull of *Python sebae*. *ar*, articular; *ca*, columella auris; *d*, dentary; *f*, frontal; *m*, maxilla; *p*, parietal; *pm*, premaxilla; *q*, quadrate; *pr*, prefrontal; *ps*, postfrontal; *pt*, pterygoid; *q*, quadrate; *s*, squamosal; *t*, transversum; *tb*, turbinal.

the base of the skull we note various processes for the insertion of ventral cervicocapital muscles, much used during the act of vigorous striking. Boidae have a long sphenoidal ridge and thick basipterygoid processes; others have one or more median knobs or crests, and the Viperidae have a very prominent and large ridge. The parietals fuse together into an unpaired mass whence arises mostly a strong median crest

Stegocephali and most Anura form the centre), therefore the typical batrachian vertebrae are notocentrous. If the remaining three pairs of constituent elements of each vertebra (the neural arch, the centrum and the intercentra) remain separate, the vertebrae are called temnospondylous (*τέμνω*, I cut, *σπόνδυλος*, a vertebra). If the neural arches and the centra are suturedly united, or are fused with each other, the vertebrae are called stereospondylous (*στερεός*, solid). In many fossil reptiles most or many of the vertebrae are temnospondylous; in most of the recent Amniota¹ they are consolidated, but the atlas or first vertebra remains usually in a relatively primitive condition, and is temnospondylous but for the usual modification that its centrum becomes attached to that of the second vertebra and forms its odontoid process. The composition of gastrocervical vertebrae is best illustrated by the first and second cervical vertebrae of crocodiles, whence by reduction and fusion the structure of every other vertebra can be explained. We have only to add that the ribs are genetically derived from lateral outgrowths of the basiventral elements, whilst the chevron bones are mere ventral outgrowths from the same basal cartilages. The most primitive vertebral column is that of the Geckos. The

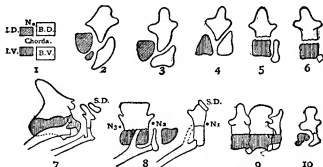

FIG. 25.—Composition of Vertebrae of Reptiles. In all the figures the right side looks towards the head.

1. Diagram showing the relative position of the four pairs of arcualia which constitute a complete quadripartite vertebra. B.D., Basiodorsal; B.V., basiventral; I.D., interdorsal; L.V., interventral, shaded vertically in all figures; N., position of axil of the spinal nerve, i.e. behind the neural arch of its vertebra. 2, 3. Side views of the constituent cartilaginous blocks of a caudal vertebra (2) and a trunk vertebra (3) of *Archegosaurus*, as typical examples of temnospondylous quadripartite and tripartite vertebrae. For comparison with Reptilian vertebrae. 4. Temnospondylous tripartite vertebra of the trunk of *Eryops*, a Permian reptile. 5. Composition of the second vertebra of a crocodile. 6. A vertebra of which the ventrals are reduced to an "interventrum." 7. Side view of the first and second cervical vertebra of a crocodile. 8. The same analysed. N₁, N₂ and N₃, position of the first, second and third spinal nerves; S.D., occasionally called Proatlans, the detached spinous process, or supradorsal, of the atlas or first vertebra. 9. The first three vertebrae of *Sphenodon*. 10. The complete atlas vertebra of an adult *Trionyx*, still typically temnospondylous.

vertebra consists chiefly of a large neural arch which rests broadly upon the centrum; this is a tube, more or less calcified and ossified, with a narrow waist in the middle, widening head- and tailwards. The tube is hollow, the chorda dorsalis passing through the whole column, and there are no proper joints between the centra, which are amphiocelous. Between the centra lies a separate element, the so-called intercentrum, which is ring-shaped and acts as an interarticular pad instead of a joint. The first of these rings forms the ventral half of the atlas ring; the second is attached to the cranial surface of the second centrum, and produces, like some of the next following ones, a vertical median blade of bone, a true hypapophysis. Such intercentra exist throughout the length of the vertebral column; in the tail they are enlarged and carry a pair of chevrons, which are cartilaginous and have the tendency of fusing by superficial

¹ There remained a flaw in the correctness of the view that the bodies of the amniotic vertebrae are formed by the paired intervertebral pieces, since the bodies were known always to appear from the first as unpaired, cartilaginous masses, until G. B. Howes found them to consist of a right and left pair in the embryos of *Sphenodon*.

ossification on to the caudal ends of the centrum next in front, to which they do not belong genetically. Exactly in the middle of each vertebra the thin shell of the centrum forms a cartilaginous septum, of what is often wrongly called chordal cartilage. When this septum is complete, and this seems to be the normal condition in the tail, the chorda is here rent asunder, otherwise it is only constricted. This septum is but slightly invaded by ossification, and consists of large cells which retain the appearance of young or embryonic cartilage. It coincides exactly with the line of transverse division of most of the caudal vertebrae into an anterior and a posterior half, the division gradually extending right through the bone of the neural arch. The same kind of division, and from the same causes, exists in *Sphenodon* and in many lizards, in fact in all those reptiles which can reproduce their broken-off tail. It is from the septal cartilage that the regeneration starts² (fig. 26).



FIG. 26.—Vertical section of four (7th to 10th) caudal vertebrae of *Sphenodon*. a, line passing through the middle of centrum and through part of the neural arch, where the vertebrae break off. (After Günther.)

Sphenodon also has biconcave vertebrae owing to the persistence of the chorda dorsalis in the intervertebral region; otherwise the vertebrae are solid. Intercentra occur from the atlas regularly into the tail, where they carry chevron bones. The atlas-ring (fig. 25, 9) is composed of the first intercentrum and a pair of neural arches which remain quite separate and carry on the dorsal side a pair of ossicles, the disconnected supradorsal elements of the atlas, erroneously supposed to be the remnants of the "proatlans."

Crocodyles.—Remnants of the chorda persist in the middle of the centra, which, in recent species, are mostly proocelous, and with a convex knob behind, but the first caudal is strongly biconvex. Cartilaginous intercentral rings, pads or menisci, occur throughout the column; in the tail they carry chevrons. For the instructive detail of the composition of the first and second cervical vertebrae see fig. 25, 7 and 8. Some of the posterior neck and anterior thoracic vertebrae have an unpaired hypapophysis arising from the centrum. The vertebrae have the usual processes, viz. spinous process, a pair of anterior and posterior zygapophyses arising from the neural arch, diapophyses likewise from this arch for the articulation with the tubercular portion of the rib; short parapophyses from the centra for the caputal ends of the ribs; the transverse processes of the 12th vertebra, and following, carry the whole rib, and are like the processes of the lumbar vertebrae diapophyses; the so-called transverse processes of the tail are mainly the ankylosed or fused ribs themselves.

Chelonians.—The vertebrae are sometimes in the various regions of the same column opistho-pro- or amphiocelous, or even biconvex. Intercentra occur regularly on the first two or three cervicals, and on the tail as paired or unpaired nodules, or as chevrons, which articulate mostly with the previous centra and occasionally fuse with them. Intercentral, fibrocartilaginous disks occur regularly, mostly in the shape of rings; the first is the transverse ligament of the atlas-ring. In the *Trionychidae* (fig. 25, 10), but also in some other tortoises, the various pieces of the atlas do not ankylose, and the first centrum remains also movably attached to the second, although it sometimes carries,

² Regeneration of the tail can take place in *Sphenodon*, all Geckos, *Anguidae*, *Gerrhosauridae*, *Lacertidae*, most *Scincidae*, and in many *Tejidae* and *Iguanidae*; certainly not in chameleons, *Varenius*, *Agamidae*, snakes, crocodiles and tortoises. Often the tail is so brittle and the muscular cones are so loosely connected that part can be thrown off by the muscular exertion of the creature itself. The reproduced tail is, however, only a sham tail, since neither centra nor arches, but only a non-segmented rod or tube of fibrocartilage is produced. It is, however, invested with new muscles and with skin, but the scales often differ considerably from those of the normal organ, sometimes showing reversion to an ancestral form. For further detail see G. A. Boulenger, *P.Z.S.* (1888), p. 351, and (1891), p. 466.

and fuses with, the second intercentral piece. The entire atlas remains in a primitive, typically temnospondylous condition. On the other hand, in some Pleurodira, e.g. *Platemys* and *Chelys*, all the constituent parts of the atlas coössify and form a complete, solid vertebra, which articulates by a concave-convex joint with the true centrum of the second vertebra. The normal number of cervical vertebrae is eight in all Chelonians. The last cervical has sometimes, e.g. *Chelydra*, a very peculiar shape with strangely modified articular facets, in correlation with the retractile neck. The neural spines of the trunk vertebrae broaden out and fuse with the neural plates of the carapace. A tertiary modification takes place in many Pleurodira with the reduction of the neurals by the costal plates, which then meet in the dorsal line and cover the neural spinal processes. The caudal vertebrae are often much reduced in size, although not always in numbers, when the tail is very short, as in the marine turtles. In various species of *Testudo* about half a dozen of the last caudal vertebrae fuse together into a veritable urostyle, which is covered with a claw- or nail-shaped sheath of horn. In some of the gigantic tortoises of Mauritius this caudal vertebral complex is fully 3 in. long and 2 in. broad, of an extraordinary appearance.

The vertebrae of the *Lacertae*, or Lizards proper, are a direct further development of those of *Sphenodon*. The chorda disappears; the vertebrae are procoelous, with an articulating knob behind. Intercentrals, in the shape of osseous, unpaired nodules or wedges, persist on most of the cervical vertebrae; they are absent in the trunk and reappear in the tail, either as wedges or with chevrons. The first intercentral forms the central half of the atlas, with the neural half of which it is connected by suture. The second fuses mostly with the cranial end of the second centre and with the caudal and ventral surface of the odontoid, forming a downward-directed hook. Frequently the fusion remains incomplete, or the wedges may completely merge into the epistropheal mass without leaving any outward traces. Boulenger has made the important observation that the intercentra of the tail are sometimes paired, e.g. in *Heloderma*. When the caudal vertebrae are strongly procoelous, the knob is very long and the chevrons are attached to its neck, having shifted on to the vertebra in front, while their basal intercentral piece, or pieces, remain in the original position. In *Opisaurus* the chevrons are absolutely fused with the caudal ends of the centra and thus assume a superficial resemblance to the vertebrae of Urodela. The splitting of the tail-vertebrae and regeneration have been described on a previous page. The trunk-vertebrae of the Tejidae and the larger Iguanidae possess additional articulating processes and facets, besides the usual processes. The *Zygosphenes* is a wedge-shaped process with two articular facets, which projects forward from the anterior side of each neural arch. The *Zygantrum* forms a corresponding excavation with a pair of articular surfaces on the hinder side of the arch. The crests on the tail and trunk of many lizards, e.g. Iguanidae, are entirely tegumentary structures and not supported by the axial skeleton, except in some chameleons, e.g. *Ch. cristatus*, and in the peculiar genus *Brookesia*; in these the accessory much-complicated processes are enormously elongated and support the high cutaneous crest which arises from the back, especially in *B. ebenaua*.

The vertebrae of the snakes are procoelous (figs. 27, 28, 29). Besides the zygapophyses, they have zygosphenes on the neural arches; the ribs articulate with the parapophyses. Long, unpaired hypapophyses arise from the centre of the anterior neck and trunk vertebrae to a variable extent. In *Dasyplepis* and *Rhachiodon* a considerable number of these processes perforate the oesophagus and act as crushers of the shell of the eggs which these snakes swallow. The often-repeated statement that these processes are capped with enamel is erroneous. The caudal vertebrae are devoid of chevron bones, but they carry paired hypapophyses, and they have transverse processes which also are generally bent downwards.

Lastly, the numbers of vertebrae composing the whole column and its various regions. In the snakes we can distinguish only

between atlas and epistropheus, trunk and tail. The numbers vary exceedingly, in the trunk up to several hundred.



FIG. 27.—Lateral aspect of two trunk vertebrae of *Python*. a, articular processes of the zygapophyses; na, neural arches; ns, neural spines; t, parapophyses. zs, zygosphenes.



FIG. 28.—Posterior aspect of a trunk vertebra of *Python* (from nature). a, zygapophyses; b, ball on the surface of the centrum; t, parapophysis; zg, zygantrum.

The tail may contain only a few, e.g. in the burrowing *Typhlops*, *Glaucania*, *Uroplepis*; or it may be very long, as for instance in *Boa*. There is no obvious reciprocal correlation between the length of the trunk and the tail. In the other orders of reptiles the neck is well marked, except in the snake-shaped lizards. If we define as first thoracic vertebra that which is the first connected with the sternum, all those anterior being cervical, the neck-vertebrae number 5 in chameleons, 7 in *Sphenodon*, 8 in the Chelonians and in the lizards, with the exception of the majority of *Varanus*, which have 9 like the *Crocodylia*.



FIG. 29.—Anterior aspect of a trunk vertebra of *Python* (from nature). a, zygapophyses; c, cup on the surface of the centrum.

THE NUMBER OF VERTEBRAE OF SOME SPECIMENS IN THE MUSEUM OF ZOOLOGY, CAMBRIDGE, ENGLAND

	Cervical.	Thoracic.	Xiphioid Ribs.	Floating Ribs.	Lumbar ribs.	Serial Numbers of the Sacral Vertebrae.	Caudal.
<i>Sphenodon punctatum</i>	7	3, 4	15	0	14	in all.	26, 27
<i>Crocodylus vulgaris</i>	9	5	3	2	5		25, 26, 33
<i>Alligator mississippiensis</i>	9	5	3	2	5		25, 26, 33
<i>Gavialis gangeticus</i>	9	7	2	3	3		25, 26, 40
<i>Chelone viridis</i>	8	9	0	0	0		19, 20, 21, 16 + pygostyle
<i>Macrolemys temminckii</i>	8	9	0	0	1		19, 20, 27
<i>Chelys namata</i>	8	8	0	0	0		17, 18, 17
<i>Varanus niloticus</i>	8	4	4	11	2		30, 31, 75 + 30, 31, 99
" <i>giganteus</i>	9	2	1	16	1		30, 31
<i>Iguana tuberculata</i>	8	4	2-3	10-9	1		26, 27, 46
<i>Uromastix spinipes</i>	8	4	1	11	0		25, 26, 24
<i>Trachysaurus rugosus</i>	6	4	1	25	0		37, 38, 7 + pygostyle of about 6
<i>Cyclodus gigas</i>	7	4	2	21	0		35, 36, 0
<i>Lacerta viridis</i>	7	3	2	15	0		28, 29, 40 +
<i>Ophisaurus apus</i>	0	0	0	0	2		55, 56
<i>Chamaeleo vulgaris</i>	5	2	1	12	2		23, 24, =50
<i>Rhampholeon spectrum</i>	5	1	3	8	2		20, 21, 17

The ribs, having arisen as lateral, separated off processes from the basiventral elements, show many modifications in their proximal attachments. These can be best studied on the skeleton of a young crocodile (fig. 25, 7 and 8). The first pair of ribs is very long and broad, attached to the unpaired ventral piece of the atlas-ring; the tubercular portion is indicated by a very small rugosity. The second pair of ribs is still larger; the capitulum attached to the second intercentral piece which fuses with the odontoid process; the tubercular process is weak or represented only by a ligamentous connexion with a small knob of the odontoid process; consequently the tuberculum has shifted its attachment away from the second vertebra. The other cervical, and the anterior thoracic, ribs have complete

capitular and tubercular processes, the bodies and with dorsolateral

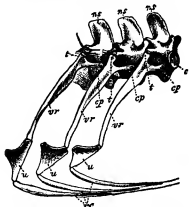

FIG. 30.—Lateral aspect of Three Thoracic Vertebrae of *Crocodilus vulgaris* (after Miyarti). *c*, cup on the anterior surface of centrum; *cp*, capitula of ribs; *ns*, neural spines; *t*, tubercula of ribs; *u*, uncinate processes; *rr*, dorsal or vertebral portions of the ribs; *rc*, ventral or sternal cartilaginous portions of ribs.

nective tissue only, with similar attachments as in crocodiles. The other cervical ribs are osseous; their short capitula retain their partly intercentral attachment, while the tubercula are carried by low processes of the centra. In the thorax both capitulum and tuberculum merge into one facet, which is gradually shifting farther tailwards and upwards until the attachment reaches them, and then lies upon the neuro-central suture. The first caudal vertebrae also possess ribs, very short and soon fusing with the diapophyses of the neural arches. In the cervical region of the *Chelonia* the ribs seem to be absent. In the thorax they retain their primitive intercentral position throughout life, assuming (except the first pair, which remains short and least modified) an absolutely intervertebral position. From the lumbar or presacral region backwards the capitula are gradually shifting upon short processes of the centra, until in the tail the vestigial ribs are carried by the diapophyses of the neural arches. In *Sphargis* (fig. 31) all the ribs are free; in the other *Chelonians* the ribs, generally in the recent species, flatten and become surrounded by the growing membrane bone of the dorsal plates, and the cartilage of the ribs (except the capitular and neck portion of the rib, which cannot be got at by the dermal bones) undergoes a process of calcification.

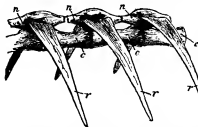

FIG. 31.—Three Vertebrae of *Sphargis coriacea*. *c*, vertebral centra; *n*, neural arches; *r*, ribs.

Ultimately this is resorbed and its place is taken by the dermal bone, which forms, so to speak, a cast of the rib. Several of the short presacral ribs, and of course the postsacrals, are not drawn into these enormous changes, although the carapace covers, and indirectly affects, them.

Certain changes initiated in *Sphenodon* are more marked in the ribs of the Lacertilia; cervical ribs are often long in the lower neck. In the trunk the capitular portions are often much reduced, and in these cases the ribs are suspended mainly by their tubercular portions, usually from the diapophyses of the neural arches near the anterior end.

In the snakes all the vertebrae, from the second cervical to the tail, carry ribs. These are very movable, articulating with a rather large, more or less vertically placed facet, which is borne by the parapophysis or transverse process; sometimes the

rib retains traces of the original division into a capitular and tubercular portion. The ribs of the snakes, although long, consist only of their dorsal portions. In snake-shaped lizards, e.g. *Pseudonotus*, rather long ribs begin with the fourth vertebra.

Uncinate processes are developed only in *Sphenodon* and in the Crocodylia. They are not homologous structures, arising in the former from the posterior margin of the middle of the dorsal portions of the ribs, overlapping the shaft of the next following rib; in the crocodyles they arise out of the middle portion of the ribs, remaining cartilaginous, whilst the middle portion coossifies with the dorsal. Only in *Sphenodon* and Crocodyles the thoracic ribs consist of three successive pieces; in the Lacertilia they consist only of the dorsal and the ventral or costosternal. The latter remain cartilaginous, or they calcify, but they never ossify.

The sternum and further modifications of the ribs of the trunk.—The sternum of most reptiles consists (1) of an anterior portion (presternum, Parker; prosternum, Fürbringer; mesosternum of Gegenbaur), which is generally broad, more or less rhomboid and carries the shoulder-girdle, and on its posterior sides several pairs of ribs; (2) of a posterior portion (metosternum and xiphisternum of Parker; xiphisternum of Fürbringer; metasternum of Gegenbaur), which is narrow, sometimes metameric, carries several pairs of ribs, and generally divides into a right and left xiphoidal half, each of which is continued into one or more ribs. These ribs tend to lose their connexion, and in these cases the sternum ends in two typical xiphoid processes. The distinction between pre- and metasternum is arbitrary. In *Sphenodon* the broad sternal plate carries only three pairs of ribs, the 8th to 10th, and there is no xiphisternum. The other ribs of the trunk are long and compound, but they remain free and do not approach the mid-line. From the posterior edge of the sternum to the pelvis extends the complicated *parasternum*, embedded in the abdominal wall; it is composed of about two dozen sets of abdominal ribs, each set containing a right and a left and a median chevron-shaped piece. In the Crocodylia the presternum carries only two or one pair of ribs, always that of the 10th vertebra. The narrow, more or less metameric metasternum carries seven or eight ribs, the last one to three being xiphoidal. The post-thoracic ribs gradually decrease in length; about three presacral vertebrae have no ribs, and so are typically lumbar. The sacral ribs are generally the 25th and 26th in *Crocodilus* and *Alligator*; sometimes the 24th and 25th in *Gavialis*. The parasternum consists of only seven or eight transverse sets, each composed of two right and two left narrow splint-bones. All these parasternal elements belong to the category of dermal bones, together with those of the plastron of tortoises, inherited from Stegocephalian conditions.

The Lacertilia present an almost endless variety. The presternum is rhomboid and broad; it carries from three to six pairs of ribs, mostly four or five; the first thoracic rib is that of the 6th vertebra, the only exceptions being the chameleons with only five cervical vertebrae, and *Varanus*, which has usually nine cervicals like the crocodyles. The last cervical rib in these long-necked lizards is very long and has all the appearance of having but recently severed its connexion with the sternum. The presternum of Lacertilia sometimes has a window, e.g. some species of *Lacerta*, *Phrynosoma*, *Iguana*, or a pair of windows, e.g. *Agama*, *Liolois*, *Gonioccephalus*. The xiphisternum carries a variable number of ribs; it is either scarcely distinguished from the anterior plate, or it is long, and in these cases either double, e.g. *Iguana*, *Gerrhonotus*, *Varanus*, *Zonurus*, *Agama*, *Cyclodus*, *Lacerta*; or single, e.g. *Zonosaurus*. The post-sternal ribs shorten gradually in the majority of the Lacertae, and there is sometimes a ribless lumbar vertebra, e.g. in *Iguana*; in many Lacertilia, however, the ventral cartilaginous halves of the ribs are connected with those of the other side, either by ligaments, or they join together, forming complete hoops of thin cartilages. Such ribs occur in all Geckones and Chameleons, but also in many Iguanidae, Scincidae, and even in the Anelytridae; their numbers vary much, from 27 in the Scincoid *Aconitias meleagris*, 7-10 in *Polychrus*, 8 in *Chamaeleo*

vulgaris, 4 or 5 in *Anolis*, to 1-3 in some other iguanids, skinks and geckos. *Uroplates fimbriatus* has 14, and the last four pairs are separated from the dorsal portions of their ribs; similar discontinuity occurs in geckos, the median portions bearing a striking, although not fundamental, resemblance to parasternal ribs.

In the lizards with much reduced fore limbs, the sternum loses its connexion with the ribs from behind forwards; two sternal ribs existing in the Tejid *Ophiodes* and in the Scincoid *Acontias*, one only in *Pygopus*, none in *Ophisaurus* s. *Pseudopus* and *Anguis* (in the latter one rib is still connected in the embryo). The sternum is likewise quite free in *Chirotes* in spite of its functional limbs; the sternum is still a large plate, with a window, and ending in two long, xiphoid processes.

Lastly, the sternum has vanished without a trace, as in the snakes, in some species of *Acontias*, in the Anelytropidae, *Dibamus* and *Aniella* (Fürbringer). In the limbless genera of Amphisbaenidae the sternum is very much reduced; in *Trogonophis* alone it is still represented by a narrow transverse bar connecting the ossicular vestiges of the shoulder-girdle; in the other genera the sternum has shrunk to a pair of nodules or to a single nodule.

The *pectoral or shoulder-girdle* in its completest condition consists of a right and left scapula, coracoid, precoracoid and clavicles, and an unpaired interclavicle or episternum. The dorsal portion of the scapula remains cartilaginous, with or without calcification, and is usually distinguished as supra-scapula. The ventral portion of the precoracoid and coracoid mass remains likewise more or less cartilaginous, rather unnecessarily distinguished as epicoracoid. Ossification begins near the glenoid cavity and thence spreads, eventually with the formation of a dorsal and a ventral centre. The resulting suture separates the dorsal or scapular from the ventral or coraco-precacoracoid mass. A kind of landmark, not always reliable, between coracoid and precoracoid is the exit of the supra-coracoid nerve. The ventral margins of the coracoids articulate in tenon and mortice fashion with the antero-lateral margins of the sternum. The interclavicle, usually T-shaped, is a dermal bone and rests upon the ventral side of the girdle. The paired clavicles, sometimes fused together, rest upon the anterior end of the interclavicle and extend transversely to the acromial process of the scapula; the detail of the attachments varies much.

The girdle is most complete in *Sphenodon* and in *Lacertilia*. In *Sphenodon* the coracoid forms one continuous mass with the precoracoid, without further differentiation; the clavicles are fused with the interclavicle into one T-shaped mass, the cross-arms of which are attached to the acromia by ligaments. In the lizards (except *Heloderma*) the much-broadened central and anterior halves of the girdle are fenestrated; the windows, always closed by membranes, are bordered by bony processes, distally by unossified cartilage. The first window to appear, or the most constant, lies between the coracoid and its precoracoid; in *Anguis* it is the only window, in this case not a primary feature. In other lizards, e.g. *Uromastix*, a second window occurs between precoracoid and scapula, and even a third window can appear in the scapula itself, causing in many Iguanidae, e.g. *Amblyrhynchus* (see fig. 33, *ms.*), the so-called mesoscapula; an analogous window within the coracoid produces the mesocoracoid; unnecessary distinctions of little morphological value considering the great variability of these fenestrations in closely allied genera.

The chameleons have lost the clavicles and the interclavicle, and the scapula, which is very slender and long, is devoid of an acromial process. The coracoid forms one mass with the precoracoid, through the middle of which passes the supra-coracoid nerve; the coracoids articulate by their whole bases with the sternum.

Geckos possess a complete shoulder-girdle; the ventral portion shows, e.g. *Hemidactylus*, three pairs of windows; only

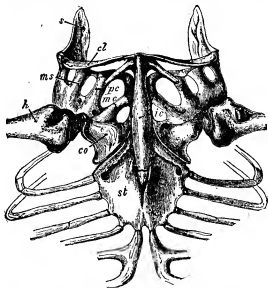

FIG. 33.—Sternum and Shoulder-Girdle of *Amblyrhynchus subcristatus* (after Steindachner). *cl*, clavicle; *co*, coracoid; *h*, humerus; *ic*, interclavicle; *mc*, mesocoracoid; *ms*, mesoscapula; *pc*, precoracoid; *s*, scapula; *st*, sternum.

one in *Uroplates*. In the latter the interclavicle is much reduced; the clavicles meet each other and are slender rods. In the Geckoninae and Eublepharinae the ventral halves of the clavicles are dilated and possess each a foramen; the interclavicle is cross-shaped.

In the more or less limbless genera of lizards the shoulder-girdle is much reduced. In *Chirotes*, which still has functional fore limbs, the clavicles and the interclavicle are absent, the coracoids are not divided from the precoracoids; in the limbless Amphisbaenidae the girdle is reduced to a pair of cylindrical ossicles in *Amphisbaena*, *Blanus* and *Trogonophis*; no vestiges exist in *Rhinea*, *Lepidosternon* and *Anops*.

Foramina in the broadened clavicles occur also in various Lacertae, for instance in the Iguanid *Laemacanthus*, in the Scincoid *Trachysaurus*, in *Plestiodon*, *Zonosaurus* and in *Lacerta simonyi*, but not in *L. agilis*. In *Mabuia* the median portions are especially broad and show each two foramina. Their presence can be of but very doubtful taxonomic value.

The girdle of the Crocodiles is considerably simplified. Scapula and coracoidae, movably united, at least in younger specimens. The precoracoid is slightly indicated by a process of the coracoid, which is perforated by the supra-coracoid nerve near the glenoid cavity. Clavicles are absent. The interclavicle is reduced to a long, flat splint-bone, which is firmly fused on to the sternal cartilage. The Chelonian shoulder-girdle shows several, very remarkable modifications. Instead of lying outside the trunk, it has been transferred into the cavity of the trunk, the carapace with the ribs covering it from the outside. An explanation of the changes implied in this transposition is still extant. Chelonians are, moreover, the only reptiles besides Pterosauria in which the scapula is attached to the skeleton of the trunk. The scapulae stand in a more or less vertical position, and their dorsal end rests against the inside of the nuchal plate, where this is sutured to the first neural and the first costal plate, a little in front of and sideways from the first short rib. From near its ventral end the scapula sends off a long process, which converges transversely with its fellow. This process, the claviclé(!) or the precoracoid of many authors, is the acromial process, the Plesiosauri giving the clue as to how an acromion can assume such an abnormal position. The coracoid, with a suture between it and the scapula, is very long and extends horizontally backwards, not meeting that of the other side. The sternum being

absent, and clavicles and interclavicles forming the epi- and endo-plastral elements of the plastron, the shoulder-girdle is nowhere in contact with the skeleton except at its dorsal end.

The Fore Limbs.—The humerus has near its upper end a median process, and at a variable distance a lateral process, near which is the biceps-fossa. Above the radial or outer condyle exists a foramen for the passage of the radial nerve in *Sphenodon*, in the Lacertilia, and in many Chelonians, e.g. *Chelone* and *Sphargis*; such an ectopicondylar foramen is absent in crocodiles. Above the ulnar condyle exists, but only in *Sphenodon*, the entepicondylar foramen, for the passage of the nervus medianus and brachial vessels. Thus *Sphenodon* alone possesses both foramina, the crocodiles neither.

Ulna and radius always remain distinct; the former is generally the stouter although not always the larger bone. The carpus may contain as many as 12 separate elements ulnare, intermedium, radiale, 2 centralia, a pisiform on the ulnar and a small nodule in a corresponding position on the medial side, and 5 distal carpals. In *Sphenodon* the centralia are sometimes fused into one, and the radial nodule is absent; the numbers of phalanges are 2, 3, 4, 4 and 3 proceeding from the first to the fifth finger. The carpus of the Chelonia is likewise primitive, with various unimportant reductions; *Chelydra* possesses one or two centralia, whilst pisiform and extra radial are absent; both these bones are present in *Emys*, but the centrale fuses with the radial carpal, and the fourth and fifth distal carpal are fused together. In *Testudo* the pisiform is small; intermedium, centrale and radiale are represented by one bone only, and the first, second and third distal carpals are fused, whilst the two remaining are free. In the marine turtles the fore limbs are transformed into paddles; the ulna is considerably shorter than the radius; all the normal nine carpal elements remain distinct; the pisiform is much enlarged, helping to increase the paddling surface, and it has moved from the ulnar carpal to the side of the fifth distal carpal. The three middle fingers and toes have mostly 3 phalanges; the pollex and hallux have always 2; the number of phalanges of the fifth finger varies from 3 to 1, of the fifth toe from 2 to 0. The greatest reduction occurs in *Testudo* and its allied genera of typical land-tortoises, *Homopus*, *Pyxis* and *Cinixys*, the formula for the fingers being 2, 2, 2, 2, 0 or 1, and 2, 2, 2, 0 for the toes. In *Pelomedusa* all the fingers possess 2 free phalanges only, owing to fusion of the first and second phalanges with each other.

Considerable advance is marked by the Crocodyles. The intermedium and centrale are lost, the pisiform is small, ulnar and radiale are considerably elongated and enlarged. Of the distal carpals the two last are fused into one bone, and the three first, together with the centrale, are transformed into a pad-like cartilaginous and ligamentous piece between the large radial and the first and second finger, to which the pad is firmly attached. The other fingers articulate with the "humatum." The result of the whole arrangement is the formation of two main joints, one between fore arm and carpus, the other intercarpal. The number of phalanges is 2, 3, 4, 4, 3.

The conditions prevailing in Lacertilia are connected with those of *Sphenodon*. The intermedium is lost, the other normal carpalia are present, also the pisiform; the first distal carpal is much reduced and the correspondingly enlarged radial carpal comes into articulating contact with the first metacarpal. The numbers of phalanges are 2, 3, 4, 4, and 2 or 3 for the fifth finger. The hand of the chameleons is most modified; the first three fingers form an inner bundle opposed to the outer or fourth and fifth fingers; in correlation herewith the third and fourth distal carpals are fused into one rather large mass; the other elements remain free, and A. Stecker has found a small intermedium present in the young, in a position which indicates that its subsequent absence is due to loss, not fusion with neighbouring elements.

The Pelvic Girdle.—The ilium is attached to the vertebral column by means of the two sacral ribs.¹ The ischia and the

pubic bones join the ilium at the acetabulum, which is not perforated, except in crocodiles. The ischia and pubes invariably form symphyses at their ventral ends, except the so-called pubes of the crocodiles, and these two symphyses are further continuous with each other, dividing the pubo-ischiadic space into a right and left foramen obturatum of very variable size. They are small and round in *Testudo*, divided by a broad, bony bridge, larger in *Chelone*, separated by a chiefly ligamentous, partly cartilaginous string; largest they are in *Sphenodon* and in the Lacertilia. Frequently the symphyseal portion at the anterior end of the pubic symphysis remains cartilaginous, unpaired, e.g. in most Chelonians and Lacertilians, comparable with the epibubis of Urodela. A corresponding cartilage, the os cloacae or hypischium, is continued backwards, from the ischiadic symphysis towards the vent, serving for the attachment of sphincter muscles; it occurs in many lizards and tortoises. In the Chelonians the pubic bones are generally much stronger than the ischia, and they send out each a strong lateral pubic process, directed forwards and outwards; the obturator nerve passes through the wide obturator foramen. In the pleurodirous tortoises the ends of the ilia and those of the lateral processes of the pubes are much broadened and firmly ankylosed with the posterior costal plates and with the xiphiplastron respectively. The whole pelvis, like the shoulder-girdle, lies inside the body. The pelvis of *Sphenodon* is essentially like that of the Lacertilia. The pubes are slender; they send out a pair of lateral processes, near the base of which the obturator nerve pierces the shaft of its pubis. This lateral process is the homologue of the long, slender pubis of birds. The chameleons' pelvis is peculiar. The pubes are devoid of lateral processes, but from their anterior end arises a pair of small cartilages, in a transverse direction; their ends are connected by ligament with the median anterior portion of the ischiadic symphysis. The crocodilian pelvis is very aberrant. The ilium is broad and sends two processes to the acetabulum, which retains a foramen; the posterior process articulates movably with the ischium; the preacetabular process fuses in very young specimens with a separate, ossifying, cartilaginous piece, which then forms a rough joint with the anterior portion or process of the ischium, which closes the acetabulum on its ventral side. To this anterior ischiadic process is attached the freely-movable, club-shaped bone, generally called pubis. The homologues of these club-shaped bones and of the small bone mentioned above are not clear. The club-shaped bones remain asunder; the ischia form a long and firm symphysis. The obturator nerve passes out of the pelvis between the ischium and the club-shaped bone, close to the posterior margin of the latter.

The posterior limbs show essentially the same composition as the fore limbs, but the modifications in the various reptilian orders are much greater. The femur has generally a well-marked neck. Fibula and tibia remain distinct; the former usually shows a reduction in thickness. In the tarsus we observe never more than two proximal tarsal elements, a reduction due either to the suppression of the intermedium or to its enlargement and concomitant loss of the tibial element. The least-modified foot-skeleton is that of the Chelydridae, the lowest Chelonians. The proximal row is composed of a fibulare, and a much larger piece articulates with both tibia and fibula, the "astragalus"; the centrale is present; the first three distal tarsals remain separate, each carrying a toe. The fused fourth and fifth tarsals carry the fourth toe, and, laterally attached, the hook-shaped fifth metatarsal. *Chelone* shows the same arrangement, except that the centrale is fused with the astragalus; in *Testudo*, *Emys*, the fibulare, astragalus and centrale are fused into one broad mass, with the result of forming a cruro-tarsal and an intertarsal joint. The same arrangement reached by the Testudinidae is universal in the Lacertae, with the further modification that their three first distal tarsals fuse on to the proximal ends of the respective metatarsals. Most aberrant is the tarsus of Chameleons, in which the first and second toe one passing through the acetabulum. In birds it is likewise present in mammals pre-acetabular.

¹ In all reptiles, except a few fossil groups, the ilio-sacral connexion is post-acetabular, i.e. it lies in a transverse plane tailwards from

form a bundle opposed to the rest; the fibulare and tibiale are fused into one bone; the fused fifth and fourth distal tarsals form a very large half-globular piece for the three outer toes, whilst the second toe is carried by the third distal tarsal, besides which there are three more small cartilages, one of which may be the displaced second tarsal or the still independent central. The tarsus of *Sphenodon* is like that of typical lizards, but none of its distal tarsals are fused on to metatarsals. The Crocodilian foot marks an advance. The astragalus is large, articulating well with tibia and fibula, and against the fibulare, which forms a typical, heel-shaped calcaneum. The fifth and fourth distal tarsals carry the fourth toe and the hook-shaped fifth metatarsal to which the fifth toe is reduced. The third, second and first distal tarsalia scarcely contain osseous nodules; they form together a wedge-shaped cartilaginous pad between the astragalus and the first and second toes. This attachment of the distal tarsals to the metatarsals reminds us of the Lacertilian condition, the result in either case being a still more marked intertarsal joint in addition to the cruro-tarsals.

Most well-footed reptiles retain all the five toes; only the crocodiles and a few tortoises have lost all the phalanges of the fifth toe. The phalangeal numbers are in the Lacertilia 2, 3, 4, 5 and 3 in the fifth toe; in chameleons 2, 3, 4, 4, 3; in most tortoises 2, 3, 3, 2; but in *Homopus*, *Ptyxis* and *Cinixys* 2, 2, 2, 0; in the crocodiles 2, 3, 4, 4, 0. The embryos of crocodiles are said to be hyperphalangeal; i.e. as many as 7 phalanges on the fourth; 5 or 6 on the fifth finger; 6 on the fourth toe, and there are traces of the fifth toe. In the adult the fourth toe remains without a claw. Burrowing and living in sand, or humus, is in many lizards correlated with reduction of the limbs and their girdles. The vestiges of the hind limbs come to lie as near the vent as possible. The reduction occurs in various families, independently. In most cases the fore limbs disappear first, but in the Amphisbaenidae, cf. *Chiroles*, and in the Tejidae, the reverse takes place. Whilst degeneracy of the shoulder-girdle is delayed long after the loss



FIG. 34.—Vestiges of pelvic limb—1, of *Lialis bartonii*; 2, of *Anguis fragilis*; 3, of *Amphisbaena fuliginosa*. f, femur; il, ilium; ip, iliopectineum; p, pubis; t, tibia.

of the anterior limbs, that of the pelvic arch precedes the loss of the hind limbs. Cope has drawn up a tabular statistic of

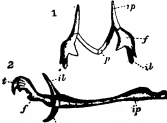

FIG. 35.—1, Vestigial pelvis and limb of *Glauconia macrolepis*. 2, The same parts of *Boa* (after Fürbringer). f, femur; il, ilium; ip, bone called "iliopectineum" by Fürbringer; p, pubis; t, tibia.

Tegumentary System.

The skin of reptiles is characterized by the strong development of its horny stratum; on the outside of it exists a thin cuticular or epithelial layer. An important feature in most lizards and in the snakes is the existence of a "subepidermoidal" or transitional layer which is produced by the migration of ectodermal cells into the cutis. The immigration takes place during the embryonic development, observed first by Kerschner, who, however, misinterpreted the process. Pigment cells, black chromatophores also, make their first appearance in the epiderm and then migrate into the transitional stratum, as has been first

correctly stated by F. Maurer. The horny stratum is shed periodically, several times during the year, and as one entire piece in snakes and a few lizards, e.g. Anguillidae; in most lizards, chameleons, geckos and in *Sphenodon* the thin, transparent colourless layer comes off in flakes. In crocodiles it is not shed except for the usual wear and tear, nor in tortoises, although in some e.g. *Chrysemys*, a periodical peeling of the large shields has been observed.

In all reptiles the cutis is raised into papillae, or folds. When the papillae are small the skin appears granular; when they are large, flat, mostly imbricating, they form scales; when they are very broad-based and still larger, they are called scutes or shields. The overlying epidermal covering partakes of these elevations, often e.g. in many snakes, with a very fine system of ridges of its own. Such a scale, cutis and horny sheath, may form spikes, or crests. They all have only basal growth. Thus, for instance, a shield of a tortoise-shell is a much flattened scale, or cone, with the apex more or less in the centre, surrounded by marginal ridges which indicate the continuous additional growth at the base. The central "areola" represents in fact the size of the shield at the time of hatching.

Of very common occurrence is the development of bone in the cutaneous portion of the scales; such osteoderms occur in many lizards, very strongly developed in the scutes of the crocodiles, especially on the back; they also occur in the skin of tortoises especially on their legs and on the tail, and they probably constitute the peculiar shell of *Sphargis*, the leathery turtle (see TORTOISE). *Sphenodon* and chameleons are devoid of such osteoderms, in geckos they are likewise absent, but calcifications occur in their tubular skin. A similar process seems to have produced the egg-tooth of crocodiles and tortoises (see under *Teeth* below). Calcareous deposits, or at least deposits of guanine and more commonly of carbonate of lime, play a considerable rôle in the skin of lizards and snakes. These waste products of the metabolism are always deposited within cells, and a favourite place is the subepidermal layer. In combination with superimposed yellow or red pigment, and with the black chromatophores as a foil, partial or complete screen to the light, as the case may be, these mineral deposits are to a great extent answerable for the colours and their often marvellous changes in the skin (see CHAMELEON).

Peculiar pits in the scales of snakes and crocodiles are described under *Sense-Organs* below.

The skin of reptiles is very poor in glands, but the few which exist are well developed. Crocodiles possess a pair of glandular musk bags which open by rather large slits on the under jaw, against the inner side of the jaw. Another pair of musk glands are the anal glands. During great excitement all these glands can be everted by the crocodiles. *Sphenodon* and snakes have only the anal pair. Water tortoises have inguinal glands, which secrete a strongly scented fluid, opening near the posterior rim of the bridge. *Trionyx* has additional glands opening near the anterior part of the plastron. Peculiar glandular structures are the femoral pores of many lizards. They lie in a line from the inner side of the knee to the anterior margin of the anal region, to which they are restricted in the limbless Amphisbaenidae. Each pore leads into a subcutaneous pocket, sometimes with slightly acinous side chambers, the walls of which produce a smeary, yellowish matter consisting chiefly of the debris of disintegrated cells which dries or hardens on the surface in the shape of a little projecting rod. They occur in both sexes, but are most active in males during the pairing season. Their use is unknown. It would be far-fetched to liken them to forerunners of the sebaceous portions of milk glands, although not so imaginary as to see in them and in the sensory pits of snake scales the forerunners of the mammalian hairs!

Claws, scarcely indicated in Batrachia, are fully developed in all limbed reptiles. The base is sunk into the skin like our own finger nails; the dorsal and ventral halves are differentiated into a harder, more curved dorsal sheath-like portion, and into the beginning of a sole, especially in crocodiles and in blunt-toed tortoises. The first claw to be reduced is that of

the fifth digit. The claws of many geckos are "retractile," like those of cats; the adhesive lamellae on the under side of their digits have already been described (see *Gecko*).

Nervous System.

The hemispheres are still much longer than broad, and pass, especially in lizards, gradually into the olfactory lobes, into which continue the ventricles of the hemispheres. The dorsal walls of these are thin, especially in crocodiles, although they possess already a considerable amount of grey matter. The basal masses of the fore-brain bulge into the rooey ventricles like cushions. Fibres referable to a corpus callosum are scarcely separated from those of the still much stronger anterior commissure. The epiphysis comes to the surface between the hinder parts of the hemispheres. The pineal eye is described below under *Sense Organs*. The hypophysis has but a shallow infundibulum. The mid-brain shows a pair of dorsal globular swellings, each with a cavity; they separate the hemispheres from the cerebellum. Of the hind-brain, the middle portion is by far the largest; although the dorsal wall of this cerebellum is thick, and rich in grey matter, its surface is still quite smooth and it shows no trace of an arbor vitae. It covers but a small portion of the wide fourth ventricle.

The spinal cord shows a brachial and a lumbar longitudinal swelling, especially marked in tortoises, but without a rhomboidal sinus. The cord is continued into the end of the tail.

The cranial nerves of the reptiles agree in their arrangement and distribution more with those of birds and mammals than with those of the Batrachia. The facial nerve sends a palatine branch to the palate and to the superior maxillary of the trigeminus, and a strong mandibular branch joins the third of the trigeminal, and further ramifications supply the sphincter muscle of the neck. The vagus and glosso-pharyngeus leave the cranium separately. The vagus then goes towards the

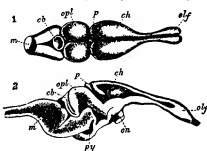

FIG. 36.—Brain of *Lacerta agilis*. (After Leydig.) 1, Dorsal aspect; 2, vertical longitudinal section. *cb*, cerebellum; *ch*, cerebral hemisphere; *m*, medulla oblongata; *of*, olfactory lobes; *opt*, optic nerve; *opt*, optic lobes; *p*, pineal body or epiphysis; *py*, base of pituitary body.

heart, which in the Sauropsida is far removed from the head, and there possesses another ganglion, variously called ganglion trunci vagi or g. nodosum. It is connected by a nerve with the large ganglion supremum of the sympathetic. From the cardiac ganglion, and from the continuation of the vagus, are sent off several branches in succession, which, having to pass below or tailwards from the transverse carotid, aortic and Botalian vessels, have to take again a headward course to the larynx and pharynx; a side branch enters the heart by its truncus. The main mass of the vagus then supplies lungs, stomach and further viscera. The accessory or 11th cranial nerve arises with about half a dozen roots which extend often beyond the second cranial nerve; they collect into a thin stem which leaves the cranium together with the vagus, with which it is often fused; it supplies the cucullaris s. trapezius muscle.

The hypoglossus arises by two ventral roots, leaving the skull by two holes through the lateral occipital bone, near the condyle. The united stem is invariably joined by strong branches from cervical nerves, always from the first, mostly also from the second, sometimes also from the third. The details vary much; occasionally there are three cranial roots and foramina, and then only the first cervical joins the hypoglossus; this often fuses with the glosso-pharyngeal or with

the vagus. In the broad and well-muscularized tongue of the crocodiles the right and left hypoglossal branches form a complete ansa, an arrangement in which A. Schneider saw the infraoesophageal nerve ring of Invertebrata!

The spinal nerves each issue behind, or through, the neural arch of the vertebra to which they belong genetically. The first spinal, or suboccipital, nerve has no dorsal roots, and, having lost its vertebra, an apparently anomalous arrangement has come to pass, in this way, that there are x cervical vertebrae, but $x + 1$ cervical nerves, a condition prevailing in, and characteristic of, all Amniota. The hypoglossal-cervical plexus is separated from the brachial plexus by several metameres, according to the length of the neck. The brachial plexus is composed of about 5 nerves; the variations have been studied chiefly by M. Fürbringer. It is interesting to note that the brachial plexus still persists in snakes, although they have completely lost the anterior girdle and the limbs (Albertina Carlsson). A disturbance in the pelvic region likewise indicates in snakes the former existence of a pelvic or lumbo-sacral plexus, which in limbed reptiles is composed of about 5 nerves, the last of which is weak and in many cases (by no means the rule) issues between the two sacral vertebrae, sending one branch to the ischiadic, another to the public plexus which supplies the cloacal region. (For details of these plexuses see the papers by Mivart, Jhering and Gadow.)

The sympathetic system shows considerable modifications in the various orders and even families of the reptiles. In the neck region, in *Sphenodon* and most lizards it is, on the right and left side, composed of two portions. One, more lateral and placed deeply, runs along the side of the vertebral column, starting from the first and second spinal nerves, with which it is connected by so-called rami communicantes; it is not connected with the other spinal nerves until it reaches, in the thorax, the first stem of the brachial plexus, and hereabout lies the so-called second thoracic ganglion. The other, superficial and more ventral, portion arises from the petrosal ganglion of the glosso-pharyngeal, and from the vagus ganglion, and then forms a long loop which joins the second thoracic ganglion. In its long course it sometimes, e.g. in *Varanus*, forms one common stem with the vagus before it splits off. At a variable distance, but not far above the heart, the vagus possesses a big swelling, the ganglion trunci vagi, and the sympathetic stem, in the same level, or farther down, has likewise a large ganglion, the g. supremum vagi, or first thoracic ganglion. The vagus ganglion receives several nerve strands from this big sympathetic ganglion, and then divides as described above.

In the crocodiles the deep portion of the sympathetic begins at the vagus and extends in rope-ladder fashion into the thorax, there being, as in birds, regular transverse communicating branches with the spinal nerves, and the longitudinal strands run through the transverse foramina between the caputal and tubercular portions of the cervical ribs. The other, ventral, portion starts by a right and a left branch from the vagus ganglia, but both branches unite at once into one unpaired stem, which is deeply embedded in the middle line between the ventral muscles of the cervical vertebrae. Very thin branches connect this unpaired stem with the right and left sympathetic portions; small ganglia are embedded in the unpaired nerve.

The so-called second thoracic ganglion is in reality a compound of all the sympathetic ganglia of the four or five metameres of the brachial plexus. It forms the point of juncture of the deep and the superficial cervical sympathetic portions. From the posterior region of the thorax backwards the right and left strands run along their side of the vertebral column, with a communicating branch and a ganglion for each metamere; sometimes one or more successive ganglia are combined, for instance near the cloaca. After having supplied the latter, the sympathetic system appears exhausted and is continued into the tail by a very thin strand, which runs between the caudal vein and artery. The best illustrations of the sympathetic system are those by Vogt (neck of crocodile), J. G. Fischer (many

lizards), H. Gadow (cloaca of crocodile), J. F. v. Bemmelen (*Sphenodon* and others), W. H. Gaskell and H. Gadow (heart of tortoise).

Sense Organs.

1. *Tegumentary Organs of some Tactile or other Sense.*—Reptiles possess apparently no traces of those tegumentary sense organs which, belonging to the domains of the trigeminal and vagus nerves, have spread far over the body in fishes and batrachia. They were developed by those classes in correlation with their essentially aquatic life. This does not apply to the reptiles which, as a class, are of absolutely terrestrial origin. Nevertheless all recent reptiles possess numerous low sense-organs, "tactile bodies," in most parts of the skin, connected with the regional, spinal nerves. They are most obvious in snakes, appearing as one or more little colourless spots near the apex of each scale on the back. The spot is formed by a little cluster of epidermal cells, connected with a sensory nerve. Their lowest stage they show in *Sphenodon* and in lizards, whilst in crocodiles they have reached a higher stage, at the bottom of the pit, since the tactile bodies, mostly several together, have sunk into the cutis, below the epiderm, forming a little pit, mostly near to the anterior margin of the flat scutes. They are most obvious on the belly of crocodiles, whilst in the American alligator such pits are scarcer, not because the organs are absent, but because these have sunk still farther into the skin. The last stage is that met with in tortoises, which possess such tactile bodies in considerable numbers in the softer subepidermal layers, beneath the large horny shields which themselves show no traces of them.

2. *Taste.*—The respective organs do not seem to have been investigated. That they exist is amply proved by the careful predilection for certain kinds of food which is shown especially by vegetarian tortoises and lizards, independent of smell. Many lizards are, for instance, very fond of sugar.

3. *Nose.*—The sense of smell is well developed in all reptiles. In none is the olfactory organ degraded; that the nasal passages, the nose itself, are never degraded is explained by the fact that all reptiles invariably breathe through the nose, except snakes during the act of swallowing their prey. The nostrils, always paired, are frequently provided with valves, to shut out the water, or sand. In some water tortoises, e.g. *Trionyx*, *Chelys*, the nostrils are prolonged into a soft, unpaired proboscis. Double tubes exist in the snake *Herpeton* (see SNAKES, Ophitoglyphs). The nostril leads into an antrum or vestibulum, this again into the nasal cavity proper, at the dorsal farther end enters the olfactory nerve, whilst ventrally it leads into the nasolaryngeal duct, with its posterior narial opening, or choana. The ducts are short in snakes and lizards, the choanae lying in the front part of the palate, but in tortoises and crocodiles they are placed far backwards, as has been described under *Skull* above. Into the nasal cavity projects, from the septum, a concha, least developed in tortoises, most in lizards and snakes. Crocodiles show a beginning of separation into several conchae as in birds and mammals. A large nasal gland lies against the lateral, or ventral, side of the outer wall of the nasal cavity, into which also opens the naso-lacrimal duct. Jacobson's organ, of uncertain function, is present in most reptiles. It is paired. In tortoises it is still placed within its nasal cavity, against the median wall, and is still nothing but a recess of the same and its mucous lining. In lizards and snakes the organ has become completely separated from the nasal cavity, lying below it and opening, each by a separate passage, into the palate mouth, close to or still within the choanae. In snakes it is mushroom-shaped, with a very short stalk. It lies immediately below the floor of the nasal capsule, and the membranous wall of the cavity on which it lies is covered and protected by a bone, commonly called the turbinal, which extends out from the median nasal system to the maxilla. In crocodiles these organs are vestigial and soon disappear.

4. *Ear.*—In crocodiles the outer ear lies in a recess, dorsally overhung by the lateral edge of the bony squamoso-frontal

bridge; it carries a flap of skin, provided with muscles, to close the ear tightly. In lizards the outer ear is quite unprotected, and when the meatus is very short and wide, the drum is quite exposed. No reptiles possess cartilages comparable to the mammalian outer ear. *Sphenodon*, chameleons, snakes have no outer ear, the skin passing over the region. So also in tortoises, but in some of the aquatic kinds its position is well indicated by softer and thinner skin; in others, for instance marine turtles, a thick leathery plug, or a bigger scale marks the former position. In various lizards, chiefly burrowing in sand, the ear passage is very narrow, or closed. The middle ear or tympanic cavity is quite obliterated in snakes, Anguisbaenas and some other snake-shaped lizards. In *Anguis* may exist individual traces. The cavity communicates with the mouth. In lizards the communication is a wide recess, lined with black pigment, so that in these creatures the whole auditory chain can easily be inspected from the opened mouth. In tortoises the recesses are contracted into the Eustachian tubes, each of which opens by a separate aperture into the roof of the mouth. In the crocodiles part of the cavities is transformed into an intricate system of canals and passages. The two Eustachian tubes open together in the mid-lines protected by a valve, between the basioccipital and basisphenoid; thence arises a median passage which with lateral arms and loops extends upward through the occiput into the cranial roof, communicating with the tympanic cavity, and further continued through the quadrate and beyond into the mandibles, by the siphonium.

In spite of the obliterated tympanic cavity of snakes, and the closed up outer ear passage and absence of a tympanic membrane in snakes and tortoises, these creatures can hear very well. The same applies to *Sphenodon*, but it seems doubtful whether chameleons can hear.

Through the whole middle ear, from the fenestra ovalis to the drum-membrane, stretches the chain of auditory ossicles or cartilages, partly attached to the posterior wall by the common lining membrane. The arrangement appears simplest in snakes, in chameleons and in tortoises, not because it is primitive but because it is so much reduced, partly in correlation with the abolition of the outer ear. In these creatures the columella goes as a bony, slender rod straight to the middle of the quadrate, against which it leans, or with which it articulates by a short piece of cartilage, the extra-columella. Here the whole chain ends. It looks like a proof that columella=stapes, extra-columella=incus, and quadrate=malleus; or, with the usual ignoring of the little extra-columellar piece, that quadrate=incus, Gegenbaur's favourite impossibility. In those lizards which have a tympanic membrane conditions are far less reduced. The extra-columellar piece sends out three distal processes; one leans on to the middle of the tympanic membrane, the second usually is fastened to the bony dorsal rim of the meatus, the third is directed downwards and is continued as a thin ligament towards the inner angle of the articular of the mandible, but before reaching this it comes to grief, being squeezed in between the quadrate and the posterior end of the pterygoid. The hyoid proper is of no account in snakes and tortoises, since it is reduced to very short distal pieces attached to the base of the tongue; but in lizards it remains in its original length, or it even lengthens, and shows many vagaries in its position and attachments. In embryos of *Sphenodon* and lizards it arises from near the junction of the columella with the extra-columella. It becomes very long, too long for the available space (perhaps correlated with lingual functions), and it forms a high loop, thereby causing the peculiar loop of the chorda tympani; the upward bend of the hyoid becomes connected with the parotic process of the cranium. Next aborts the portion between this connexion and the original proximal end of the hyoid, near the columellar mass. The upper end of the hyoid either remains attached to the parotic process (various lizards and *Sphenodon*) whence the lingual apparatus remains suspended, or the hyoid, having broken loose, leaves a little cartilage, Versluy's cartilage, behind, at the end of the parotic process, and the hyoid horn remains free, in the majority of lizards. In *Sphenodon*, whilst

passing the distal portion of the extra-columella, part of the hyoid fuses with it, often forming thereby a little hole, the remnant of imperfect fusion.

In the crocodiles the arrangement is at first complete and diagrammatically clear, not obscured by vagaries of the hyoid, which is free and much reduced. In the embryo the large extra-columellar cartilage, abutting against the tympanic membrane, and with another process against the quadrate, sends its third, downward, process as a thick rod of cartilage to the posterior inner angle of the mandible with which it is directly in cartilaginous continuity. It was W. K. Parker's mistake to call this cartilage the cerato-hyal. In young embryos it looks like an upward continuation of Meckel's cartilage, much resembling mammalian conditions. But in nearly ripe embryos this cartilage is already reduced to a string of connective tissue, cartilage remaining only at the upper end, and where this string enters the mandible lies the *siphonium*, the tube which connects the air cavities of the mandible with the Eustachian passages, the long connecting channel becoming—side by side with the extracolumellar-mandibular ligament—embedded into a canal of the quadrate, so that in older stages, and above all in the adult, the proper display of the whole arrangement requires a

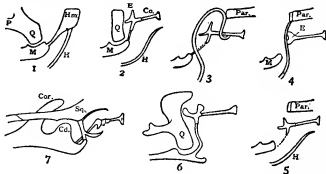

FIG. 37.—Diagram showing Evolution of the Ossicular Chain of the Ear. 1. Hyostylic Elasmobranch. H, hyoid; Hm, hyomandible; M, mandible; P Q, palatoquadrate. 2. Lacertilian. Cc, columella or stapes; and E, extra-columella with supra-, extra- and infra- "stapedial" processes. 3. Hypothetic stage between 2 and 4. *Sphenodon*. Par—parotic bone. 5. Lacertilian. Parotic process with a piece of cartilage at its end, remnant of piece of the hyoid; connexion of intra-stapedial process with mandible vanishing. 6. Embryo of Crocodile. Continuous cartilaginous connexion of extra-columella with Meckel's cartilage. 7. Embryonic Mammal; for comparison. Cd, the new condyle, articulating with Sg, squamosal; Cor, coronoid process; quadrate transforming into tympanic ring.

little anatomical skill. The whole string, whether cartilaginous or ligamentous, which connects the downward extracolumellar process with the articulare, is of course homologous with the continuation of Meckel's cartilage into the malleus of foetal and young mammals; and the chain of bones and cartilages between the auditory capsule, fenestra ovalis, and the proximal part of the mandible is also homologous wherever such a chain occurs; lastly, fenestra ovalis and membrana tympani are fixed points. Consequently columella=stapes, extracolumella of Sauropsida=lentiform + ear + malleus of Mammalia.

The *inner ear* has been studied minutely and well by C. Hasse, E. Clason and G. Retzius. It is enclosed by the petiotic bones. The fenestra rotunda is surmounted by the opisthotic, the fenestra ovalis by the same and by the pro-otic, and this protects also the anterior vertical semicircular canal. The posterior canal is opisthotic, the horizontal is pro- and opisthotic. The anterior canal is the largest of the three, a feature characteristic of the Sauropsida. The *lagena*, with its own acoustic papilla, begins to show a basilar membrane with papilla, at the expense of that in the sacculus. In *Sphenodon* and lizards a slight curving of the lagena indicates the beginning of a cochlea, and a scala is developed in crocodiles, but neither cochlea nor scala is specially twisted. The endo-lymphatic ducts end as closed sacs, in lizards and snakes, in the roof of the skull, between the occipital and

parietal bones. They reach an enormous development in many geckos, where they form large twisted sacs beneath the skin, covering the sides of the neck, which then assumes a much swollen appearance. They contain white otolithic masses, with lymph. It is remarkable that the extent of these sacs varies not only in allied species, but even individually, independent of sex and age, although they are naturally liable to increase with age.

5. Eyes are present in all reptiles, although in many of the burrowing snakes and lizards they may be so completely covered by the skin as to have lost their function. Most reptiles have upper and lower lids, moved by palpebral muscles, and a third lid, the nictitating membrane, which can be drawn over the front of the cornea from the inner angle obliquely up and backwards. Its mechanism is simplest in lizards. A muscle, a split from the retractor muscle of the eyeball, arises from the posterior part of the orbit, is attached to the posterior wall of the eyeball, and there forms a pulley for the long tendon which arises from the median side of the orbit and passes over the back of the ball forwards into the nictitating membrane. Contraction of this muscle draws the membrane backwards and over the eye. In crocodiles and tortoises the tendon of the nictitating membrane broadens out into a muscle (*M. pyramidalis*), which arises from the median side of the posterior portion of the ball; above, the optic nerve it crosses over the broad insertion of the retractor of the ball, without being much guided by it, although this muscle by its contraction slightly prevents the nictitating tendon and muscle from touching the optic nerve.

It is easy to recognize the mechanism of birds as a combination of the two types just described; their musc. quadrates s. bursalis is of course the single muscle of the lizards, but now restricted to, and broadened out upon, the eyeball.

Special Modifications of the Lids.—In the snakes the upper and lower lids are reduced to the rim, and the nictitating membrane has become the permanent cover, which protects the eye like a watch-glass, leaving between itself and the cornea a space, drained by the naso-lacrymal duct, and behind this space the eyeball moves as freely as in other animals. A similar arrangement exists in the true geckos, not in the Eublepharidae, which still possess the outer lids. In some lizards, especially such as live in deserts, the middle of the lower lid has a transparent disk, and it is always the lower lid which is drawn over the eye, the upper in nearly all Sauropsida being much smaller and less movable; for instance, some specimens of the Lacertine genus *Eremias* in Africa and India. In the Indian genus *Cabrita*, and in *Ophiops* of Africa and India, the lower lid is permanently fused with the rim of the shrunken upper lid and forms a transparent window superficially looking like that of the snakes. Exactly the same arrangement has been developed by *Ablepharus*, one of the Scincidae.

The eyeball is provided with the usual rectus and obliquus muscles, in addition to a retractor oculi. Apparently all reptiles possess a pair of Harderian or nictitating glands, which open in front, in the nasal, inner corner, and lacrymal glands which open likewise into the conjunctival sac, but near the outer or temporal corner. The secretion of both is drained off through the lacrymal canals, which in lizards open below in the outer wall of the posterior nares; in snakes they open into the mouth by a narrow aperture on the inner side of the palatine bone.

The walls of the anterior half of the sclerotic of lizards, tortoises and *Sphenodon* contain numerous cartilaginous or osseous plates, which imbricate in ring shape; they are absent in snakes and crocodiles. Internally the eye of most reptiles possesses at least traces of a pecten; very small indeed in tortoises, or in crocodiles where it is represented by only a few mosslike, pigmented vessels. In many lizards these vessels, arising from near the optic nerve, form a network which extends right up to the posterior side of the lens; in others, especially in Iguanidae, is developed a typical, large pecten, deeply pigmented with black, fan-shaped or umbrella-shaped, sometimes folded. In chameleons it is a short cone; apparently

quite absent in *Sphenodon*. A falciform process and other remnants of a campanula are absent. In most of those reptiles which have but a rudimentary pecten, the retina is supplied by hyaloid vessels which spread over the surface of the vitreous body; such superficial vessels disappear with a greater development of the pecten, and the retina receives a choroid supply; special retinal arteries from the a. centralis retinae, and veins, exist in snakes.

Ciliary processes of the choroid are usually small, a proper ciliary body being least developed in crocodiles; all reptiles have a ciliary muscle. The shape of the contracted pupil varies from round to a vertical slit; the latter is most marked in *Sphenodon*.

The retina shows usually a fovea centralis, sometimes but slightly indicated by a shallow depression; it is well marked in chameleons. The retina contains only cones, rods being absent; fat-drops on the apex of the cones are common; their usual colours are green and blue.

6. *The pineal, median or parietal eye* is the terminal organ of the epiphysis of the brain, with which it is connected by a nerve-containing string. Among recent reptiles it exists in *Sphenodon* and in the Lacertilia, with vestiges in snakes. It is embedded in the median parietal foramen. Externally its presence is generally marked by the scales being arranged in a rosette, with a transparent central scale. The organ itself is distinctly a dioptric apparatus, with all the essential features of an eye; a pigmented retina of the arthropodous simple type surrounds an inner chamber which is nearly filled by a cellular globular mass which projects into it from above; this is the so-called lens, in reality much more like the corpus vitreum in its still cellular condition, while the real lens has to be looked for in the superimposed tissue. The whole organ is best developed in *Sphenodon*, even in the adult; but whether it is still functional, and what its function is, remain unknown. The throwing of a beam of light upon this eye, by means of a lens, produces no effect. Whilst in *Sphenodon* the "lens" is rather dull and the efferent nerve is still present, in various lizards the "lens" is more perfect, but the nerve is degenerated. We conclude that the whole organ is now without the least visual function, whilst in various extinct groups of reptiles and Stegocephali it was fully developed. It has been well investigated by de Graaff, W. B. Spencer and A. Dendy.

The Muscular System.

A useful account of the differentiation of the muscles in the main reptilian groups, with their almost endless modifications in correlation with walking, climbing, swimming, gliding and burrowing, with limbs complete or absent, would fill several pages of this article and would necessitate many illustrations. The literature is great; it comprises many good detailed descriptions of various kinds of reptiles, and several monographs. M. Fürbringer has devoted a whole series to the muscles of the neck, shoulder-girdle and fore limbs. Hand in hand with these investigations went that of the innervation, without which myology would lack scientific value. The present writer has devoted much time to the muscles and nerves of the pelvis and hind limbs, and has, in tabular form, compared them with those of other vertebrates. The results of all these labours are rather disappointing, except for the study of myology as such, which raises many interesting questions. Broadly speaking, the muscles of typical reptiles, crocodiles and lizards are more highly differentiated (by no means always more numerous, but more individualized by origin and insertion, the behaviour of the tendons), more effectively disposed according to mechanical principles, than in Batrachia, and less than in birds and mammals. This can easily be proved, whether we take for comparison the muscles of the neck, of the larynx or hyoid, or limbs. Lowest in general stands *Sphenodon*, next to it the lizards, highest the crocodiles, while tortoises and snakes show the greatest reduction and specialization. In the tortoises it is the non-yielding box of carapace and plastron which has caused great changes within the region of the trunk proper. First, all the epiaxial muscles have

vanished; the same applies to the costal muscles; but traces of dorso-lateral muscles occur on the inside of the posterior half of the carapace, extending as a longitudinal system from one transverse process to the next in many of the lower aquatic tortoises, as perfectly useless vestiges; or more striking, these muscles exist in the young, and disappear with age, for instance in *Testudo*. Secondly, it is rather surprising that the rigid shell has offered so little or no inducement to the muscles of the girdles, neck and tail to transfer their origins upon it. Thirdly, the retractile neck of the typical cryptodirous tortoises is correlated with a pair of long retractor muscles, which in the shape of a pair of broad, vertical ribbons (between which is received the S-kinked neck) extend far back along the vertebral column, almost to the level of the pelvis.

In snakes, owing to the loss of limbs and girdles, only the spinal and costal muscles remain, besides of course those of the abdomen and the visceral arches. The vestigial muscles of the limbless lizards and of the peropodous snakes have been monographed by Fürbringer in much detail without great results.

Respiratory Organs.

All reptiles breathe by lungs, and they possess no vestiges of gills, not even during their embryonic stages, although gill clefts are invariably present in the embryo. Nor does any part of the outer skin assist respiration, as is so commonly the case in Batrachia; yet, strictly speaking, the lungs are not the only organs of respiration in the class of reptiles, since various tortoises possess additional breathing apparatus in the anal sacs and in certain recesses of the throat, to be mentioned farther on.

The *Larynx*, instead of lying at the bottom and, far back in the throat, as in the Batrachia, is considerably moved forwards so as to rest upon the hyoid and to project into the pharyngeal cavity. A pair of arytenoid cartilages, enclosing the glottis, rest upon several more or less fused tracheal cartilages, which thus represent the cricoid, but there is no thyroid cartilage. A small process from the anterior median edge of the cricoid is the beginning of an epiglottis. Vocal chords are indicated by lateral projecting folds of the inner membranous lining of the larynx, and are in a few cases effective in producing a voice. Crocodiles and alligators have a powerful, loud, bellowing voice; many tortoises utter weak, piping sounds, especially during the pairing season; and also various lizards can emit a feeble squeak, for instance, *Psammadromus hispanicus*, and the geckos. *Sphenodon*, at least the males, can grunt. Snakes have no voice; they can only hiss like all other reptiles, but a curious modification exists in the larynx of the North American *Coleuber s. Pityophis*, e.g. *C. melanoleucus*: the epiglottis is more enlarged, and laterally compressed so that the hissing sound is much strengthened by the vibration of the epiglottis. The larynx possesses a constrictor and a dilator muscle, which arise from the arytenoids and from the cricoid respectively, and are attached to the hyoid. Chameleons have bladder-shaped sacs which can be filled with air from a slit immediately below the larynx. For further modifications see G. Tornier.

The *Trachea* is furnished with cartilaginous rings and semi-rings, which extend to the lungs. As a rule the trachea is straight; in *Crocodilus americanus* it forms a loop; and similar curvings occur in various tortoises in correlation with the retractile neck. The two *bronchi* are shortest in *Sphenodon*, very long in most tortoises, where they begin frequently already half down the neck. In *Sphargis* most of the trachea is divided by a longitudinal partition. It is an advance upon amphibian conditions that the bronchus enters its lung no longer at its apex, since an anterior, pre-bronchial lung-portion has come into existence. This is still very short in *Sphenodon*, while in crocodiles, tortoises and in the highly developed Varanidae the bronchus enters near the middle of its lung, so that the anterior portion is nearly as long as the posterior. The shape of the trunk influences that of the lungs. In the snake-shaped forms, both snakes and lizards alike, the lungs have become

very asymmetrical, one of them being much larger than the other, which is often quite aborted.

The simplest form of lungs is that of *Sphenodon*; the pre-bronchial part is still small. Each lung is still a sac with one large lumen, the walls being honeycombed. In the lizards the walls are more spongy, and several septa begin to extend more or less far from the walls into the lumen, towards each bronchus. Some of these septa begin to cut the lung into lobes, especially in *Varanus* and in chameleons. In the latter exists a further specialization, a side-departure, in the shape of several long, hollow processes which are sent out from the posterior portions of the lungs and extend far into the body-cavity and between the viscera. By means of them these creatures can "blow" themselves out. They are of morphological interest since they are first stages of air-sacs so marvelously developed in birds, and possibly also in various Dinosaurs. In the Amphisbaenids the left lung alone remains.

The lungs of crocodiles have reached a considerably higher stage. They alone in reptiles are, on the ventral side, completely shut off from the viscera by a pleural, partly muscularized, membrane. From each bronchus extend a number of broad septa towards the periphery, dividing the originally single lumen into many chambers, perhaps a dozen, from the walls of which wide secondary or parabronchial canals extend into the alveolar meshwork, in very regular arrangement, in series like organ-pipes.

The lungs of the tortoises are, in adaptation to the peculiar shape of the body, stowed away along the back, as far as the pelvis, and only their ventral surface is covered by a strong peritoneal membrane which receives muscular, diaphragmatic fibres. The inner division of the lungs into chambers has progressed so much that a sort of mesobronchus has become discernible; the arrangement of the side-bronchi is far less regular than in crocodiles; the whole lung is much more honeycombed, meshy and spongy.

The mechanism of breathing of tortoises is not such a puzzle as it is sometimes stated to be. Of course the rigid box of the trunk excludes any costal, or abdominal breathing, but by protruding the limbs or the neck, piston-like, an effective vacuum is produced in the box. Moreover, the throat is distended and worked considerably by the unusually large and very movable hyoid apparatus, by which air is pumped into the lungs.

The lungs of the snakes are very thin-walled, with a very wide lumen, and only for about the first half from the heart backwards the walls are alveolar enough for actual respiratory function, while towards the blind end the sacs are so thin and sparsely vascularized that they act mainly as reservoirs of a large amount of air. Frequently their posterior portions receive blood vessels not from the pulmonary arteries but directly from those of the trunk. In correlation with the long, cylindrical body, the lungs are much elongated and they are not equally developed. The asymmetry shows great differences in the various groups, consequently the asymmetry has been developed independently in those groups. It is usually stated that the left lung is much smaller than the right. This is but rarely the case. The most recent observations are those of E. D. Cope (*Proc. Am. Phil. Soc.* (1894), xxxiii. 217). In Boidae both lungs are large, although unequal: the left or more dorsally placed one being the larger. In *Ilysia* the right is functional, the left is ventral and vestigial. In *Rhinophis* the right is very small, the left larger. In *Glaucônia* and *Typhlops* the right lung alone is developed: the left is quite aborted. In Colubridae the left lung alone is functional, while the right is vestigial. There is no trace of the right in Elapinae and Hydrophinae and most Viperidae. In the Colubridae the right, or ventral, lung is, when present at all, reduced to a length of from 2-5 mm., and it then communicates with the anterior portion of the left lung by a foramen, in level of the heart, whilst the right bronchus is so-aborted.

A further complication is the so-called tracheal lung, which is present in Typhlopidae, *Ungalia* of the Boidae, in *Chersydus* of the Acrochordinae, in the Hydrophinae and Viperidae. This

peculiar organ is a continuation of the anterior portion of the functional lung, extending far headwards, along the trachea, with the lumen of which it communicates by numerous openings. In *Chersydus* this mysterious organ is "composed of coarse cells and without lumen, extends from the heart to the head, and is discontinuous with the true lung; the trachea communicates with it by a series of symmetrical pores on each side." In *Typhlops* it extends likewise from the heart to the throat, as a cellular body but without lumen or connexion with either trachea or lung.

Thyroid and Thymus.

The *Thyroid* of the reptiles is a single, unpaired organ, placed ventrally upon the trachea and one or other of the arterial trunks, more or less distant from the heart. In snakes it lies on the mid-line near the heart; a little farther up in *Sphenodon*; still farther in lizards, and chameleons near the root of their gular sac. In tortoises it is globular, at the division of the carotic trunk. In crocodiles it is bilobed.

The *Thymus* is paired. It is largest in crocodiles, extending on either side of nearly the whole neck, along the carotids and jugulars. In the tortoises they are much shorter; in *Sphenodon* and lizards are two pairs, more or less elongated; in the snakes are sometimes as many as three pairs, elongated but small, attached to the carotis near the heart. As usual the thymus bodies become much reduced with age.

The Spleen.

The *Spleen* varies much in shape and position. In lizards it is mostly roundish, elongated in *Sphenodon*, and placed near the stomach; in crocodiles it lies in the duodenal loop behind the pancreas; similarly situated in snakes, but in the tortoises it is much concentrated, large and attached to the hind-gut.

The Body Cavity.

The *body cavity* of the reptiles is subdivided into several sacs or cavities by serous membranes of peritoneal origin. The number of these subcavities differs much in the various groups. The pericardial sac is always complete. In tortoises the lungs are retro-peritoneal, a dense serous membrane spreading over their ventral surface from the walls of the carapace forwards to the liver and shutting off a saccus hepato-pulmonalis from the rest of the peritoneal cavity. Snakes possess, besides the modifications mentioned above, separate chambers for the stomach, right and left liver, and for the gut, whilst the pleural cavities as such have been destroyed. In lizards a "post-hepatic septum" divides liver, lungs and heart from the rest of the intestines. This transverse vertical septum is best developed, almost complete, in some of the Tejidae, in others it seems to be more imperfect, and it is probably a further development of the suspensorial ligament of the liver, which is ultimately inserted upon the ventral wall of the body.

The subdivisions have reached their highest development in the crocodiles, there being, besides the pericardial and the two pleural cavities and the usual peritoneal room, a right and left hepato-pericardial, an hepato-gastric, and an hepato-pulmonal sac. The caudal and ventral edges of these liver-sacs are fused on to the ventral body-wall, thus producing a complete transverse partition, headwards of which lie the lungs, liver and heart. This partition, morphologically not homologous with the mammalian diaphragm, more resembling the imperfect structure in birds, acts, however, as a perfect diaphragm, since it is well furnished with muscular fibres. These are attached to its whole periphery, with centripetal direction, especially on the ventral half. These fibres are transgressors upon this septum from a broad sheet of muscles, which, inserted together with the septum upon the body-wall, arise from the iliac bones, the pubes, and the greater portion of the last pair of abdominal ribs. This broad muscular sheet, covering the intestines, is the so-called abdominal diaphragm or peritoneal muscle. Its continuation upon the transverse septum is the crocodilian musc. diaphragmaticus, and in functional effect very similar

to that of the Mammalia, whilst the abdominal diaphragm undoubtedly causes abdominal respiration. We have seen that these crocodilian conditions do not stand quite alone, but are connected with simpler features in the other reptiles. Two recent, very lengthy papers have been written on this subject by I. Bromann (1904) and by F. Hochstetter (1906), besides two in 1902 by G. Butler.

The Heart.

The Heart of all reptiles is removed from the head and is placed well in the thorax, in the Varanidae even a little beyond it. Only in snakes the heart lies headwards from the hilus of the lungs, not caudalwards, generally at about the end of the first fifth of the body. The batrachian conus arteriosus is reduced, one set of semilunar valves guarding the entrances into the truncus arteriosus which now issues directly from the heart. A sinus venosus exists still in *Sphenodon* and Chelonians, in which it may even receive separate hepatic veins, but in crocodiles, lizards and snakes the sinus as such exists no longer, forming part of the right atrium. All the hepatic veins enter the stem of the posterior vena cava, which henceforth enters the heart as inferior vena cava. This, the largest, and the right and left anterior vena cavae, are the only three veins which enter the right atrium. Into the left open the two pulmonary veins. Right and left atrium have in all reptiles a complete septum between them. The ventricular portion shows considerable steps towards the differentiation into a right and a left ventricle, but the partition is very incomplete in tortoises, lizards and snakes, quite complete only in the crocodiles. The most important character of the reptilian heart, absolutely diagnostic of it, is the fact that the systemic vessel which leaves the right ventricle turns to the left to form the left aorta, while the stem which comes from the left ventricular half arches over to the right as the right aorta. It is not at all necessary to conclude that this fact excludes the reptiles from the mammalian ancestry and to hark back to conditions as indifferent as are those of the batrachia. The Foramen Panizzae shows the way to a solution, how ultimately all the arterial blood from the left ventricle may pass, first through the root of the right arch, then through this hole into the left, whilst the rest of the right arch, and the root of the left, obliterate. The difficulty is not much greater than that of deriving the birds' condition from the reptilian. The Foramen Panizzae, which exists only in the Crocodilia, lies exactly where the right crosses dorsally over the left aorta. The whole is *not* the last remnant of the originally undivided truncus, as is taught generally, but it is a new foramen, a hole dug by the left arterial blood into the venous right aorta. According to the recent observations made by F. Hochstetter the foramen comes into existence in a very late embryonic stage.

Whilst the batrachian single ventricle possesses only one ostium ventriculare or outlet into the truncus, in the reptiles the inter-atrial septum extends considerably downwards into the base of the ventricle, so as to produce a right and a left niche, and correspondingly two ostia instead of one. The atrio-ventricular valves are still membranous, even in crocodiles; attached to them are muscles, trabeculae carneae, from the very trabecular walls of the ventricle; they are especially spongy in tortoises. By means of the arrangement of some of these trabeculae, perhaps still more through the confluence of their basal portions, an imperfect ventricular septum is initiated. Certainly even in tortoises, which represent the lowest stage, the venous blood is received into and sent out by the same right side of the ventricle, while the arterial blood is correspondingly managed and dodged by the left side. That there is not very much mixture of the two kinds of blood, in spite of the wide communication in the ventricle, is further due to the peristaltic systole and diastole of the various divisions of the heart.—The heart of Chelonians is broader than long. In correlation with the very much flattened body of *Trionyx* and its allied genera, the whole heart is dislodged from the middle line, far over to the right side; the vessels of the left side are correspondingly much

elongated and have to cross the neck, trachea and oesophagus.—The apex of the heart is attached to the pericardium by a special ligament in the Crocodilia and in many Chelonians, e.g. *Testudo*, but it is absent in *Clemmys*. Sometimes this little ligament sends a tiny blood vessel into the liver.

Arterial System.

Crocodiles.—The left aorta crosses obliquely beneath the right and gives off only the coeliac, just before joining the right aorta in the level of the eighth thoracic vertebra. The aorta descendens sends off, besides intercostals and other segmentals into the body-wall, the mesenteric, right and left iliac, a pair of renal and ischiadics, a cloacal and the caudal artery. The right aorta forms the main root of the a. descendens. Close to the heart it sends off two coronaries and a short carotis primaria which divides at once into two anomya, the left of which is the stronger. The right anomya divides into the subclavia and collateralis colli, the left into subclavia and carotis subvertebralis. Each subclavia sends off an a. vertebralis communis, which runs headwards and, with another longer branch, downwards, giving off intercostals, and then joins the descending aorta.

Tortoises.—The left aorta is rather more separated from the truncus, which it crosses ventrally in an oblique forward direction; it sends off a left cardiac to stomach and oesophagus, a coeliac and mesenteric, and then a communicating branch to the right aorta. The a. descendens gives off paired suprarenals, spermatics, very large iliacs, then a pair of renals, hypogastrics and the caudal. Each iliac artery divides into a recurrent intercostal anastomosing with the axillaries, an epigastric (sending off the crural and anastomosing with thoracics and humerals), and other arteries to abdominal muscles and to the shell. The hypogastrics supply the cloacal region and then continue as the ischiadics. But there are many anastomoses which cause great variation in the different tortoises. The right aorta sends off a right cardiac, the coronary, and the right and left anomya which are quite symmetrical, each dividing into subclavia and carotis; in the angle lies the thymus.

Lizards.—Two common carotids arise either side by side, or by one carotis primaria, from the right aortic root. In the majority each common carotis ascends the neck and then divides into the vessels for the head and another branch which turns back and goes into the descending part of the aortic arch. In chameleons two carotid stems ascend the neck and there is no recurrent vessel. In the Varanidae the two common carotids start from a long carotis primaria; there is no recurrent vessel. The vertebral arteries come from the origin of the subclavians and run to the head in a very lateral position. The subclavian arteries (which occur also in limbless lizards) arise far away from the carotids out of the descending arch of the right aorta, in a level often far behind the heart. "Anonymous" arteries are consequently absent in lizards.

Snakes.—The left aorta is stronger than the right, both combining soon to form the descending aorta. Owing to the absence of fore limbs and shoulder-girdle the conditions are much simplified. In most snakes the right aorta sends off but one strong carotic vessel which represents the left carotis communis whilst the right is much reduced or even quite absent; further, there is only one vertebral artery, which either runs along the right side of the vertebral column or it divides soon into a right and a left vessel along the neck. In conformity with the reduction of one lung there is usually but one pulmonary vessel.

Venous System.

Crocodiles.—Each, right and left, anterior vena cava is composed of a subclavian (axillary and external jugular), an internal jugular, common vertebral and an internal mammary vein. The posterior vena cava is composed of the two revehent renals, veins from the genital glands and ducts, revehent veins of the suprarenals (which, like birds, still have a portal system), and the big vein from the fat body. Thus the vena cava posterior

perforates the right liver, receiving from it many hepatic revehent veins and also the big revehent vessel from the left lobe; next it receives the coronary vein and then enters the heart as inferior vena cava. The portal vein arises out of the coccygo-mesenteric (which comes out of the bifurcation of the caudal), collecting the blood from most abdominal viscera and from the thorax and breaks up in the right liver. The rest of the venous system is rather complicated. The big caudal vessel divides near the vent, receives an unpaired cloacal and a rectal vessel, and goes off to the right and left, each of which trunks receives an ischiadic and an inter-sacral vein and then divides into the v. renalis advehens which breaks up in the kidney, and the abdominal vein. The latter are interesting; they run in the abdominal wall, receive the obturator and other pelvic veins, intervertebrals and intercostals, the crurals, and the epigastrics out of the body-wall. Then these two abdominals (Rathke's internal epigastrics) go to the liver, which they enter to either side of the gall bladder, collecting also blood from the stomach and from the vertebral column. Both break up in the liver. Consequently all the blood from "below the heart" passes through some portal system—renal or hepatic—except that which comes from the genital glands and ducts and from the fat body.

Tortoises.—The venous system much resembles that of the crocodiles, but many and wide anastomoses, especially on the inside of the carapace and plastron, exist between often distant vessels, so that one lucky injection may fill the whole system. There are three advehent renal veins which collect on the back of their kidney into one stem; they dissolve completely into a portal system, and leave the kidney on its ventral surface as one v. renalis revehens. The right and left then form the v. c. posterior which perforates the posterior margin of the right liver, then headwards of the liver takes up the hepatic and enters the heart. The three pairs of afferent renal veins are composed as follows. The externa collects from the shell and the abdominal muscles; the posterior collects along the rectum from the genital glands, the bladder, and from parts of other pelvic viscera; the anterior comes from the anterior part of the shell and runs backwards to the kidney, with frequent anastomoses with the other advehent renal veins. The abdominals arise, as in the crocodiles, with the external advehent renal from the lateral continuation of the bifurcated caudal, which takes up vessels from the pelvis, the shell and the crural. The abdominal itself takes up a femoral vein, vessels from the abdominal and pelvic muscles, and from the plastron, and then dives into the body-cavity, receives veins from the fore limbs, and enters the right lobe of the liver, there to break up. The hepatic portal collects from the intestinal tract, spleen and pancreas. Consequently in tortoises all the blood from below the heart passes through some portal system.

The most important peculiarity of the Lizards is the condition of the abdominal veins; they combine into a single stem (after having collected the blood from the fat body and from the ventral body-wall of the pelvic region) which dives into the body-cavity to join, embedded in the ventral hepatic ligament, the left branch of the portal vein. The chief characteristic of the abdominal is that it does not communicate directly with the caudal, and that it forms an unpaired stem. The renal portal system receives its blood from the tail, the hind limbs, the abdominal wall and the urino-genital organs, all the blood passing into a right and a left advehent vein. The suprarenal portal system drains from the abdominal wall and the suprarenal bodies, and issues into the revehent renals. These, with some intervertebrals and with hepatics, constitute the inferior vena cava.

Lymphatic System.

The lymphatic vessels frequently accompany the big arteries of the trunk, either surrounding them with a meshwork or ensheathing them completely, especially in tortoises. The lymphatics from the head and neck combine with stems which accompany the veins of the fore limbs; they join the thoracic

ducts and these open into the brachio-cephalic veins, as they do in birds. The lymph from the tail flows into the ischiadic veins or into the advehent renal veins. Reptiles possess only a posterior pair of lymph-hearts; they are placed near the root of the tail against the ends of one of the transverse processes. In snakes they lie in a space protected by the ribs and transverse processes of the original sacral vertebrae. Lymph glands proper are not developed in reptiles, except in the shape of the so-called mesenteric gland of crocodiles.

Blood.

The red corpuscles are invariably oval, and, since they still possess a nucleus, biconvex. Numerous measurements have been made by G. Gulliver (*P.Z.S.*, 1845, pp. 93-102), their long and short axes range between 0.015-0.023 and 0.009-0.021 mm. respectively. That means to say they are very much larger than those of mammals, considerably larger than those of most birds, and in turn much smaller than those of amphibia.

Digestive System.

Teeth.—All the groups of recent reptiles have teeth, except the tortoises, which have lost even embryonic traces of them. In the under jaw they are restricted to the dentary bones. In the upper they are almost universal in the maxilla and premaxilla, although the latter has lost them in most of the snakes. The pterygoids are toothed in most snakes and in a few lizards, e.g. *Lacerta* and *Iguana*. The palatines are toothed in *Sphenodon* and in some lizards.

Only the young of *Sphenodon* and the chameleons have a few small teeth on the vomer. The teeth themselves consist of dentine with a cap of enamel and with cementum around their base. In the crocodiles they are planted into separate alveoles in the maxilla, premaxilla and under jaw. In lizards they are either pleurodont, i.e. they stand in a series upon a longitudinal ridge which projects from the lingual side of the supporting bone, or they stand upon the upper rim of the bone, acrodon. In either case they are, when full grown, cemented on to the bone. Acrodon are amongst lizards only the Agamidae; the Tejidae are intermediate, almost acrodon. All the snakes and *Sphenodon* are acrodon. The latter is in so far peculiar as its broad-based, somewhat triangular teeth are much worn down in old specimens; originally there are several in the premaxilla, but the adults bite with the somewhat curved-down portions of the premaxillaries themselves, or with what remains of the ankylosed bases of the original teeth, which then, together with the bone, look like a pair of large chisel-shaped incisors. The lateral edges of the palatines of *Sphenodon* likewise carry teeth, those of the mandibles fit into a long slit-like space between the palatine and the maxillary teeth. This is a unique arrangement. Further, it is surprising that in this old, Rhynchocephalian type the supply of teeth has become exhausted, whilst in the other recent reptiles the supply is continuous and apparently inexhaustible. The new teeth lie on the lingual side of the old set, and long before the new tooth is finished part of the base of its older neighbour is absorbed, so that the pulp-cavity which persists in nearly all reptilian teeth becomes free. Ultimately the old tooth is pushed off and the new is cemented into its place. In the crocodiles it has come to pass that several sets of teeth are lodged more or less into one another's bases. Where crocodiles and alligators collect habitually the ground is sometimes found strewn with thousands of teeth, large and small, every creature shedding about seventy teeth many times during its long life.

Some or all teeth of various families of lizards and snakes have a more or less pronounced groove or furrow along their anterior convex curve. The usefulness of this furrow in facilitating the entering of saliva into the bitten wound is merely incidental, but this preformed feature has in many snakes been improved into a fearful weapon. In the *Opisthoglypha* a few of the most posterior teeth in the maxilla are enlarged, have deeper furrows, and lie in the vicinity of the poison ducts. In the *Pteroglypha* one or two of the most anterior maxillary

teeth are enlarged and furnished with a deep groove for the reception of poison. In the Solenoglypha or Viperidae the enlarged teeth of the Opisthoglypha have moved to the front, owing to reduction of the anterior portion of the maxilla. The latter, much shortened, moves with the firmly ankylosed poison fang upon the prefrontal as its pivot, being pushed forward, or "erected," by the ectopterygoid bone, which connects it with the pterygoid, and this in turn can be moved forwards and backwards, together with the quadrate. (See fig. 24, skull of *Vipera nasicornis* and the diagram of the mechanism in article SNAKES.) In the still unfinished fang the furrow is open, later the edges close together and the end of the duct of the gland itself is surrounded by the substance of the growing basal portion of the tooth, so that the furrow is converted into a canal continuous with that of the gland. The poison is now sure to be projected into the very deepest part of the wound with the precision of a surgical instrument. The Proteroglypha, with their long, non-erectile maxillae, bite, or, like *Elaps*, deliberately chew their victim; the Viperidae rather strike with the mouth widely open. The teeth of snakes and lizards are often of irregular size; but it is rare that a kind of differentiation into incisors, canines and molars occurs. In many lizards, especially in Iguanidae, some teeth are multicuspoid, trilobed, or somewhat serrated; in *Tiliqua*, universally known as *Cyclodus*, most of the hinder teeth are roundish crushers.

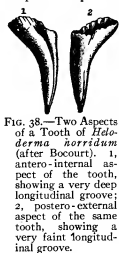

FIG. 38.—Two Aspects of a Tooth of *Heloderma norridum* (after Bocourt). 1, antero-internal aspect of the tooth, showing a very deep longitudinal groove; 2, postero-external aspect of the same tooth, showing a very faint longitudinal groove.

Lizards and snakes are born with an "egg-tooth" which is lost a day or two after hatching. Its function is the filing through of the eggshell. This tooth, always unpaired, is in *Tropidonotus natrix* one millimetre long and half a millimetre broad at its base, which rests upon a middle depression of the premaxillary bone; it stands forward above the mouth and is curved upwards. In crocodiles and tortoises the same effect is produced by another organ, which, as in birds, lies well outside the mouth on the top of the end of the snout and consists of a little cone of calcified epidermis.

Tongue.—The tongue of the crocodiles is very broad and flat, and with nearly its whole broad base attached to the floor of the mouth; however, in its whole circumference its edge is well marked, and it arises on its hinder border as a transverse fold which meets a similar fold descending from the palate in front of the posterior nares. By these folds the mouth can be completely shut off from the nasal passages into the trachea. The upper surface of the tongue contains several dozen large flat papillae, each with a central pit-like opening; it is not known whether they are gustatory organs. Besides scarce mucous glands on the tongue, there is an absence of salivary glands in the mouth. The tongue of tortoises is likewise short, broad, and not protractile, and there appears to be only a sublingual gland; the surface of the tongue is covered with velvety papillae in the terrestrial, with larger folds in the marine Chelonians. In the Lacertilia the tongue presents a number of variations which have been referred to as diagnostic characters of the various families of LIZARDS (*q.v.*). The chief modifications are the following: Either flat and broad, not protractile, e.g. Agamidae; or the body of the tongue is somewhat cylindrical, elongated, and the whole organ can be protruded; lastly, the anterior half of the tongue, which can be protruded, is retractile or telescoped into the posterior portion, e.g. Anguidae. In nearly all cases the posterior dorsal end of the body of the tongue is well marked off by a margin raised above the root, a character which does not occur in any snake. The upper surface is either smooth or curved with velvety, flat, or scaly, always soft; papillae. In the majority the tip of the tongue

is bifid, either slightly nighed or deeply bifid. The tips contain tactile corpuscles, although sometimes covered with a horny epithelium. The most specialized is the tongue of the chameleon. The body of this tongue is very thick, club-shaped, fleshy and full of large mucous glands which cover it with a sticky secretion. The base or root is very narrow, composed of extremely elastic fibres and supported by a much elongated copular piece of the hyoid. This elastic part is, so to speak, telescoped over the style-shaped copula, and the whole apparatus is kept in a contracted state like a spring in a tube. A pair of wide blood vessels and elastic bands extend from the base into the thick end, which in an ordinary chameleon can be shot out to a distance of about 8 in.

The tongue of the snakes is invariably slender, smooth and almost entirely retractile into its posterior sheath-like portion. It is always bifid and contains many tactile and other sensory corpuscles by which these creatures seem to investigate. The tongue is always protruded during excitement. How this is done is not very obvious, since the hyoid apparatus itself is much reduced. There is a niche in the middle of the rostral shield to permit protrusion of the tongue whilst the mouth is shut, and probably herewith is correlated the almost universal absence of teeth in the premaxilla. The tongue and the larynx are placed very far forwards in the mouth and, during the act of swallowing, the larynx approaches the chin, or it may even protrude out of the mouth to secure breathing during the often painfully protracted act.

Of Glands, sublingual glands are of general occurrence in reptiles; they open near the root or in the sheath of the tongue. Labial glands seem to be absent in crocodiles and tortoises, but upper and lower labial glands exist in lizards and snakes, generally in considerable numbers. *Heloderma* is the only lizard in which some of these glands—those along the lower jaw—produce a poisonous secretion, each small gland conducting its secretion towards the base of one of the somewhat furrowed teeth. In the snakes, upper and lower labial glands are well developed for salivation. It is the upper series which attracts our interest by its eventual modification into the deadly poison glands. Probably the saliva of most snakes, like their serum, possesses toxic properties. In most of the harmless Colubrine snakes the glands extend in a continuous series from behind the premaxilla along the whole of the upper jaw, with numerous openings. In the Opisthoglypha a gradual differentiation takes place into an anterior, middle and posterior portion; the middle, extending from below and behind the eye backwards, is the thickest and yellowish in colour; behind it follows a small portion, reddish grey like the anterior portion, with which it is more or less continuous below the middle complex. Thus, still rather indifferent, is *Dryophis*. In *Dipsos*, e.g. *D. fusca*, the middle portion has become predominant; some of its enlarged ducts lead to the pair of posterior, enlarged and well-grooved, maxillary teeth. It is this middle portion which becomes the characteristic poison gland with one long duct. The gland itself retains its position; all the other upper labials, except the anterior series, abort. In the Viperidae the poison duct opens near the base of the perforated fangs, which, owing to the shortening of the anterior portion of the maxilla with its teeth, have come to be the only teeth in the upper jaw. In the Elapine, still more in the Hydrophine snakes, the position of the gland and its duct is the same, but the duct has been carried past the smaller harmless teeth which stand in the maxilla and open at the base of the anterior maxillary teeth. The effect is the same, although the poison fangs are not homologous, in the one case the most posterior, in the other the most anterior, of the maxillary series. In *Doliophis*, one of the Malay genera of Elapine snakes, each poison gland sends an enormously elongated recess far into the body-cavity. (For some other details see SNAKES; VIPER; and RATTLESNAKE.) The best account of the buccal glands and teeth of poisonous snakes is that by G. S. West, *P.Z.S.*, 1895, pp. 812-826.)

Stomach, &c.—In lizards and in *Sphenodon* the wide pharynx and oesophagus passes gradually into the stomach, which is

more or less spindle-shaped, never transversely placed. The walls of the stomach are thrown into longitudinal folds which contain the specific gastric glands, whilst glands are absent in the oesophagus, excepting scattered and very simple slime glands. The circular muscular fibres of the stomach are much stronger than the longitudinal fibres. The end of the stomach is generally marked by a pyloric valve. The walls of the mid gut are said to be devoid of glands. The end gut, marked by a circular valve, is considerably wider and there is a caecum, mostly left-sided, largest in leaf-eating lizards, rarely absent, as, for instance, in *Anguis*. The absorbent portion of the rectum is always strongly marked off from the cloaca by a circular fold or sphincter, which projects into the widened coprodaeum of the cloaca. In those lizards which, like *Varanus*, have no urinary bladder, there are two successive sphincters, marking off two chambers, one, the upper or innermost, for the reception of the faeces, the lower for that of the urine. In adult crocodiles the stomach is transformed into a gizzard; it is more or less oval, with a wide fundus and with two opposite apo-neurotic or tendinous disks whence radiate the muscular fibres. The muscular walls remain, however, comparatively thin, like those of birds of prey. There is a distinct pyloric stomach and then follows the pylorus. The inner lining of the stomach is velvet-like with numerous gastric glands which form groups with net-like interstices. There is a distinct duodenal loop which contains the pancreas. The more convoluted mid gut is lined with net-like meshes which farther back assume a longitudinal zigzag arrangement; towards the end gut the walls become quite smooth, but in the end gut the walls again show a very narrow-meshed structure. None of these folds of the mid and hind gut is said to contain digestive glands; they seem to be entirely absorbent. The oesophagus of most tortoises shows longitudinal folds with very numerous mucous glands. In the Chelonidae the pharynx and adjoining part of the gullet are covered with little tubercles upon each of which opens a small gland. Farther down they give way to large, more or less conical papillae, which assume a considerable size, point backwards, and are covered with a somewhat horny epithelium. Similar conical, horny papillae exist also in *Sphargis*, in which the oesophagus, moreover, makes a long loop half round the stomach before passing into it, an absolutely unique feature. The transition into the stomach is quite gradual. The latter is strongly muscular, partly transversely placed, and possesses often a very distinct pyloric stomach. In *Chelone* conical papillae extend into the cardiac portion. In the majority of tortoises the inner lining shows longitudinal folds with numerous small glands, mucous and gastric, but their distribution differs much in the various families and even genera. The lining of the mid gut shows either longitudinal folds or a network, without glands, except in some cases, Lieberkühn crypts, e.g. in *Trionyx*, not in *Testudo* and *Chelone*. The hind gut begins suddenly, but there is no caecum; in its inner walls contain numerous glands in *Testudo*, *Emys*, not in *Chelys*, *Trionyx*, *Cinosternum*.

In the snakes the oesophagus is very thin-walled and passes imperceptibly into the stomach, which continues in a longitudinal direction, scarcely wider in the middle. Its muscular coating is surprisingly weak. There is a small pyloric portion. Mucous and especially long-bodied gastric glands are numerous. The wall of the mid gut carries numerous papillae variably arranged, velvet-like, or densely crowded little blades supported by longitudinal or by meshy folds. The hind gut is short, often constricted into several successive chambers, mostly smooth inside; there is a short, rather wide caecum which seems best developed in *Viperidae*; sometimes absent. The total length of the snakes' gut is always short, there being only short folds possible or necessary in the body cavity, which itself is of extraordinary length. Yet, while in *Typhlops* the gut is almost straight, it forms numerous convolutions in *Tortrix*.

Whilst in all other reptiles the gut, at least stomach, liver and mid gut, are suspended by the mesentery from the vertebral column and hang free into the body cavity, in some snakes, especially often described in *Boa* and *Python*, the body cavity

is cut up into numerous spaces, by peritoneal folds which connect neighbouring twists of the canal into bundles and attach them to the ventral surface of the body-wall. Probably the gut is thereby secured against dislocations in adaptation to the peculiar twisting contortions of the body, especially in the act of climbing. The mesentery of reptiles is remarkable for the possession of smooth, non-striated, muscular fibres. In most lizards, not in other orders, the peritoneum so far as it covers the abdominal cavity shows a deep black pigmentation; this pigment is situated in the connective tissue, not in the epithelial layer; it stops suddenly towards the thorax. In some lizards, e.g. in *Anguis*, the black pigment extends, more or less scattered, upon the mesentery and thence upon the intestines. The same pigment colours the pharynx with its recesses entirely black in many lizards. There is no compensating correlation between this internal pigment and that in the outer skin.

The Liver of lizards is more or less bilobed; more so in crocodiles; while in tortoises the broad right and left lobes are connected by a narrow isthmus. In the snakes it is much elongated and extends from the heart backwards along the right side of the oesophagus, closely connected in its long course with numerous short branches into, or from, the inferior vena cava and the portal vein. A gall bladder is always present. The ducts into and from the cyst sometimes form a complicated network, for instance in *Varanus* (F. E. Beddard); the bile is carried by one or more ducts into the duodenal portion of the mid gut. The microscopic structure of the reptilian liver has been compared with that of monotremes by M. Fürbringer.

The Pancreas is a compact body attached to the duodenal region, which surrounds it by a loop in the crocodiles, as is the case in birds and mammals.

The Cloaca of the reptiles shows a great advance upon the simple batrachian arrangement. It is no longer one common chamber, but consists of three successive chambers with the further tendency of separating the temporary retention and the passage of the faecal, urinary and genital products from each other. The arrangement is simplest and most typical in the lizards. There is first the *proctodaeum* or vestibulum of the cloaca, epiblastic in origin. Its outer boundary is formed by the cloacal lips, covered so far by the usual scaly integument. Just within this chamber arise the paired copulatory organs, and, when they are present, as in *Sphenodon* and snakes, the two anal glands. Secondly, the *urodaeum*, middle or urino-genital chamber, hypoblastic in origin. It is separated from the proctodaeum by a more or less circular fold which is provided with sphincter muscles, which form the true vent, and this is always round; whilst the outermost opening in lizards and snakes is a transverse slit. Farther inwards, headwards, the urodaeum is shut off by another circular fold, generally very well marked, especially in its dorsal half, which is higher and thicker. Into the dorsal, and innermost, recess of this urodaeum open the genital and urinary ducts; on the ventral side arises the urinary bladder. The whole chamber is always empty, being only a passage room, and in the female the copulatory chamber. The urine is of course collected in the bladder; when this is absent the fluid is pressed into the third chamber, the *coprodaeum*, which is often subdivided into two, or even three, successive rooms by circular folds. This coprodaeum serves for the temporary storage of the faeces, eventually mixed with the urine. Micturition and defaecation are in most lizards two successive separate acts.

The snake's arrangement is a side-departure of that prevailing in lizards. The urodaeum is transformed into a dorsal recess into which open above the oviducts, while the ureters open below, in the caudal corner. A horizontal fold imperfectly shuts off the wide urino-genital chamber or recess from the ventral half of the original urodaeum. The coprodaeum is marked above and below by strong sphincters. There is no urinary bladder.

In crocodiles the proctodaeum is rather shallow, but long; from its ventral wall arises the unpaired copulatory organ, the basal investing membranes of which continue into the ventral

half of the uro-protodaeal fold, near which open the male ducts. Very young crocodiles possess a typical middle chamber or urodaeum, into the dorso-lateral corners of which open the ureters, but soon the strong circular fold between urodaeum and coprodaeum disappears completely, so that both chambers now form one large oval room, which is used solely for the storage of the urine, there being no bladder. The faeces are kept in the not specially dilated rectum.

The cloacal arrangement of the Chelonina is a further development of early crocodilian conditions, but it has become rather complicated and shows a surprising resemblance to that which still prevails in the Monotremes. The protodaeum is deep and very long, especially in the males. From its innermost and ventral walls arises the large copulatory organ. From the urodaeum is separated off a deep ventral recess into which open the ureters and the genital ducts, and it is continued by a long neck into the large bladder. Between the dorsal wall of this recess and the ventral wall of the main portion of the urodaeum arises a horizontal fold which, diverging, is continued on to the investing skin of the penis, helping to form the edges of the deep longitudinal furrow on its morphologically dorsal surface. If the lips of this furrow were closed, urine and all the genital products would pass through this urethral canal, but in reality only the semen is conducted through it (the furrow during the state of turgescence being transformed into a closed tube), whilst urine and eggs escape through the wide slit near its inner end. This is an arrangement almost the same as that of *Ornithorhynchus*. The urodaeum is separated from the rectum by a strong sphincter, and there is, as in the crocodiles and mammals, no special coprodaeum. The Chelonian urodaeum is further complicated by the occurrence of a pair of large anal sacs, thin-walled diverticula on the dorsal side. Such sacs, not to be confounded with the anal glands of other reptiles, exist in many water tortoises, especially in the Chelydidae, also in various aquatic Testudinidae, e.g. *Emys*, in *Platysternum*, and sometimes in *Trionyx*; they are absent in the Chelonidae and in the typically terrestrial tortoises. These sacs have highly vascularized walls and a considerable layer of circular and longitudinal non-striated muscular fibres; their inside is sometimes villous, never glandular. They are incessantly filled and emptied with water through the vent, and act as additional respiratory organs, like a kind of water lungs. When such a tortoise is suddenly taken out of the water it squirts out a stream of water, which is not, as is usually supposed, the urine from the bladder.

In connexion with the cloaca may be mentioned the frequent occurrence of *peritoneal canals*. In the tortoises their abdominal openings are situated in a recess of the peritoneal cavity close to either side of the neck of the bladder; in the females they extend as funnels, generally blind, into the cloaca on or near the base of the clitoris. In the males they extend, without having communication with the cavities of the corpora cavernosa, and without ramifications, as canals along the dorsum penis and either terminate blindly in the glands (*Testudo*, *Chelone*), or they open, each by a small orifice, in the groove at the base of the glands. In crocodiles these canals are short and open near the base of the copulatory organ, protected by a small papilla. They are present in both sexes, but are still closed in newly hatched and very immature specimens. In an adult Nile crocodile they are wide enough to pass an ordinary lead pencil. The function of these outlets from the body cavity is obscure. In *Sphenodon* the writer has found them as closed funnels which project as soft papillae into the protodaeum a little to the right and left and caudalwards from the urino-genital papillae.

Urinary Organs.

The *kidneys* of the reptiles show, like those of the birds and mammals, a considerable advance upon those of the Batrachia. They are, in the adult, represented entirely by the metanephros; the segmental tubes have no longer any nephrostomes opening into the body cavity, not even during any time of their development, and it has come to a complete

separation of the efferent genital ducts from the kidneys and from their ureters. Yet these differences are but of degree, there being a continuous bridge from Batrachian to Lacertilian conditions. In *Lacerta*, for instance, in which these features have been studied most thoroughly, the mesonephros continues as the only functional excretory organ during the first year of the young creature until and during its first hibernation, when the formation of the metanephros takes place, and with it the complete separation of the vasa deferentia from the kidneys. Until then the segmental canals remain in the male as common carriers of semen and urine, at least morphologically, not physiologically, since in the immature there is no occasion for the conduction of semen. The kidneys of these young lizards show precisely the same arrangement as that of the Batrachia, excluding the Discoglossidae.

Clearly the metanephros is developed from, and is part of, the posterior portion of the mesonephros, the glomeruli of which no longer open into the segmental duct, but become connected with a new canal, the future ureter, which sprouts from the distal portion of the segmental duct and grows headwards. Or let us put these important changes in another way. Since there are originally several segmental ducts (permanent in the male newt) which tailwards more and more lose their connexion with the testes, until—in the posterior portion of the mesonephros—they become entirely urinary ducts, the hindmost of these sprouts (in lizards postembryonic, much earlier in birds and mammals) independently, but at the same time as the neighbouring mass of the mesonephros, the growing glomeruli of which then connect with the sprouting processes of the ureter. Phylogenetically and ontogenetically it is evident enough that the kidneys are essentially one organ, the anterior portion of which is the oldest and decays, whilst farther backwards new and more differentiated portions continue to grow. Pro-, meso- and metanephros and successive wave-like stages of the same organ with morphological and functional continuity, until the next, improved portion is ready. It is important that in the Discoglossidae, especially in the male *Alytes*, an arrangement has come to pass which much resembles that of the Amniota. The mesonephros has, by a simple contrivance, become a metanephros, provided we define the former as a kidney which is still connected with true segmental ducts.

The *supra-renal bodies*, adrenals, head-kidneys or Nebennieren, are yellowish bodies which lie more in connexion with the generative glands than with the kidneys, always closely attached to the vena cava posterior just above the kidneys. They are very elongated in the snakes, in a ro-foot python they measure about one inch in length; they are flattened in tortoises, roundish in crocodiles.

In all reptiles the kidneys are retroperitoneal, and they do not project into the body cavity. Their position is different in the various groups, and their general shape is much affected by the shape of the body. In the *Ophidia* they are much elongated, and of course far in front of the pelvic region, which has been moved to the cloaca. They are placed asymmetrically, the right extending farthest forwards. They consist of many transverse lobes, sometimes in such a way as to appear spirally twisted. Each terminates considerably in front of the cloaca. Each ureter begins at the anterior end of the kidney, and thence proceeds on its inner and dorsal border, receiving ducts from the interspaces of the numerous lobes. In the male each ureter opens upon a papilla, together with the vas deferens; in the female the ureter is joined by a blind canal, the vestige of the male duct. No snake has a urinary bladder. The urinary excretion is white, chalky, consisting mainly of uric acid in crystals, with very little fluid.

In the *Lacertilia* the kidneys are more posteriorly placed than in snakes. They lie between the pelvis and the cloaca and are generally close together, sometimes partly fused with each other. Only in the Amphisbaenids the right kidney extends more forwards. They are usually transversely furrowed. The ureters open dorso-laterally into the urodaeum upon papillae as in the snakes. In the females the remnants of the segmental

ducts, or vestigial representatives of the vasa efferentia, are often of considerable length, persistent in chameleon and *Uromastix*, much reduced in geckos, or disappearing with age as in *Lacerta*. The urine of most lizards contains much solid uric acid, which is retained in the urodaeum and voided as a rather solid, white mass, not united with the faeces. Those which have a greater amount of fluid urine have a bladder which receives the fluid portion. The opening of this bladder is on the ventral side of the cloaca, not in direct connexion with the ureters. The bladder is very rarely absent, e.g. in Varanidae and Amphisbaenidae.

The *Procodilla* have the kidneys placed below the pelvis; their surface shows meandering convolutions separated by furrows. The ureters are for the greater part of their length deeply sunk into the substance of the kidneys, which they leave near the hinder ends, to run freely for a short distance along the dorsal sides of the cloaca, and they open, each separately, and away from the vasa deferentia, into the dorsal side of the urodaeum, which, together with the coprodaeum, forms a large oval chamber, and this being filled with the very fluid urine, functionizes instead of the absent bladder.

In *Chelonia* the kidneys lie in the pelvis, short and thick, more or less trihedral; the surface is marked with many shallow meandering grooves and fewer deeper furrows. Each ureter, composed of several large successive canals, leaves its kidney near the inner hinder end, and then runs free for a short space, crossing the gut to open into the neck of the urinary bladder, which arises ventrally out of the urodaeum, which itself has become a recess of the cloaca. The bladder is large, often more or less two-horned, attached to the pelvic wall by a peritoneal fold, and it contains very fluid urine.

The kidneys of *Sphenodon* are very small and far removed from the generative organs. The ureters open, each close to the vas deferens of its side, beneath a little papilla, on the dorsal side, rather near the midline of the urodaeum, whence arises a long-necked bladder.

Reproductive System.

The *Ovaries* are always in pairs, placed headwards at a distance from the kidneys in *Sphenodon*, lizards and snakes; in the latter the right ovary lies farther forward. In tortoises, and especially in the crocodiles, where they are very long and much twisted or lobated, they are situated close to the kidneys and even accompany them. The ovaries of lizards and snakes contain many and large lymph spaces; those of the other reptiles are much denser in structure. The ripening eggs always cause them to assume the shape of a bunch of grapes. The *Oviducts* are each held by a peritoneal fold which arises from near the dorsal midline. The abdominal ostia are long slits and are turned towards the side, away from the ovaries. The walls of the ducts gradually become thicker, glandular and much folded. Whilst the ripe eggs, often in considerable numbers, receive their shell, each egg lies in a separate chamber; in the geckos, which lay only one pair of eggs, the two respective chambers have become permanent features. In *Sphenodon* each oviduct opens together with the ureter of its side near the dorsomedian line of the urodaeum. In most lizards the two oviducts and the two ureters have four separate openings in the dorsal wall of the rather deep dorsal recess of the urodaeum. But in *Lophura* both oviducts unite (like the ureters) and have only one opening, which is placed a little nearer towards the pelvis than the urinary opening, but they are divided by a longitudinal septum which extends almost to their common orifice. In the snakes the oviducts likewise open into the dorsal recess, sometimes by a common ostium, which is provided with a strong sphincter. The whole recess acts like a vagina for the reception of one of the copulatory organs. The oviducts of the crocodiles open in a decidedly ventral position, on either side close to the base of the clitoris, a considerable distance from the openings of the ureters. In the tortoises the oviducts open separately into a wide ventral urino-genital sinus, at the base of the neck of the bladder.

The *Testes* correspond in position with the ovaries; in snakes and Amphisbaenids the right is placed farther head-

wards than the left. The usual shape is elongated, sometimes pointed forwards. The *Epididymis* is sometimes of the same size as the testis and then consists of many meandering convolutions of the vas deferens which is composed of several canals from the testis. The convolutions are held together by a peritoneal lamella. Towards the cloaca they become much smaller and shorter, and the vas deferens passes along the median side of the ureter. In *Sphenodon* these open separately, each near and below the same papilla near which opens the ureter of the same side. In most lizards the vas deferens unites with its ureter into one short canal which opens beneath or upon a small papilla in the upper corner of the urodaeal recess, far away from the penis. In snakes vas deferens and ureter of each side are likewise commonly united. In the crocodiles each vas deferens passes from the dorsal side of the cloaca to the ventral side, not accompanied by the ureter, and opens into the blind sac which forms the basal continuation of the deep groove on the dorsal side of the penis. In the tortoises the epididymis is very large and the vas deferens is also much convoluted; each opens separately near the neck of the large urinary bladder close to the backward continuation of the deep longitudinal groove of the copulatory organ.

Remnants of the Müllerian ducts run parallel with the vasa deferentia, and similar remnants of the Wolffian ducts accompany the oviducts in crocodiles and tortoises, least degenerated of course in young specimens. Such reciprocal vestiges occur most likely also in lizards, and in female snakes a vestige of the male duct joins its ureter. In a nearly adult male *Sphenodon* the present writer missed the female remnants.

The copulatory organs show very important modifications. *Sphenodon* is the only recent reptile which is devoid of such an organ; its imperfect substitute is an unpaired, thin, but high membranous fold which arises from the dorsal middle of the circular fold between urodaeum and coprodaeum. During copulation this part of the cloaca is probably everted to secure conception, a striking resemblance to the arrangement found in the Caecilia. The organs of all lizards and snakes are paired, in their quiescent state withdrawn into deep pockets which open on the right and left posterior corners of the proctodaeum or outer chamber of the cloaca, which for this reason has assumed the shape of a transverse slit in all lizards and snakes. Hence these have sometimes been called *Plagioretama*. Each organ can be everted and tucked in like the finger of a glove, a muscle being attached to the inside of the apex; when everted, the muscle extends through the length of the organ; each muscle arises from the ventral side of several transverse processes of the tail vertebrae, at a considerable distance from the cloaca. In the embryo each organ arises as a conical protuberance, or papilla, which projects out of the vent. Later it becomes inverted. Probably this ontogenetic feature recapitulates the phylogeny of these organs, which have to be looked upon as swelling flaps or portions of the walls of the cloaca which were protruded during copulation, and which in time borrowed, and specialized, muscular fibres from the ventral tail muscles. On the outer everted side of each organ is a furrow for the reception of the semen. The apex is either single or more or less deeply bifurcated, each arm being followed by the likewise divided furrow. The outer investing membrane of these very muscular erectile bodies is epidermal; often, especially in snakes, provided with numerous papillae, folds or other excrescences. In

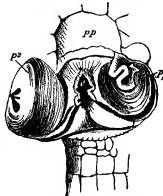

FIG. 39.—Male copulatory organs of *Lacerta agilis* (after Leydig). P, P, organs of right and left sides—between them is the anal aperture; PP, preanal plate.

many snakes these are spiny and hard, but according to Leydig this hardness is not due to a horny substance but to the deposition of calcifying matter. E. D. Cope has investigated the almost endless minor modifications of these penial features and uses them for taxonomic purposes in the snakes. Vestiges of these organs occur in females of snakes and lizards. Close to these organs of the snakes lies a pair of anal glands of some size, which pour their very offensive secretion through an opening close to the base of each penis. The same glands occur in the same position in *Sphenodon*, which has no copulatory organs, and in crocodiles they appear as evertible musk glands. Hence J. E. V. Boas, not knowing of their existence in both sexes of snakes, tried to homologize them with the paired penes of reptiles, an error which has been repeated in C. Gegenbaur's *Lehrbuch*, vol. ii. p. 533.

The crocodiles and tortoises possess a single, median copulatory organ; it lies on the ventral or anterior end of the cloaca, the outer opening of which is therefore a longitudinal slit, hence the term *uctrotremata*. In the crocodiles the organ is attached to the caudal corner of the ischiadic symphysis by a strong and roundish fibrous band, which arises single from the ventral sides and forms partly the continuation of the two fibrous halves of the organ; the bulk of the crura, comparable to corpora cavernosa, is not attached to the pelvis, as generally stated, but projects backwards towards and into the pelvic cavity. This portion is especially rich in venous cavernosities. The outer coating of the glands possesses various papillary projections, which are furnished with sensory, hedonic corpuscles. On the morphologically dorsal side of the organ, not on the dorsum penis, is a deep groove which ends towards the crura in a blind sac, into the farther corner of which open the vasa deferentia. In a full-grown Nile crocodile the whole organ is about 10 in. long. In young females up to a total length of 3 or 4 ft. the clitoris is nearly of the same size as the male organ, but it remains stationary and appears very small in large specimens.

The organ of the tortoises is essentially of the same type as that of the crocodiles, but it is nowhere directly attached to the pelvis or to any other skeletal part. The whole organ, when withdrawn, lies in a ventral, long recess of the wide outer cloacal chamber, and its crura extend so far back as to form the continuation of the ventral and lateral walls of the recessus which is continued into the neck of the urinary bladder. Its orifice and those of the seminal ducts are enclosed by the walls of the deep groove which runs along the underside of the organ. This is always of considerable size, surprisingly large in *Trionyx*. The clitoris is small, sometimes tiny.

The sexual act is extremely prolonged in Chelonians and still more so are the preliminaries, but in crocodiles it is the deed of a few seconds. Lizards and snakes insert only one side.

There remains the question whether the unpaired organ of the crocodiles and tortoises, which is the prototype of the mammalian organ in every essential point, and the paired organs of the lizards and snakes, are to a certain extent homologous organs in so far as they can both be derived from the same indifferent condition. With this view we assume that originally the protrusible walls of the outer cloacal chamber became specialized into a right and left imperfect intromittent organ, that subsequently, in lizards, those hemipenes were shifted back towards the tail and were henceforth bound to develop separately, while in the crocodiles, tortoises, mammals and birds the two primitive lateral evertible flaps approached each other towards the ventral anterior side of the cloaca, and that this led to a fusion, beginning probably at the basal part, which at the same time was farther withdrawn from the surface and secured the reception of the sperma from both vasa deferentia into one canal. This hypothesis has been objected to by Boas, but accepted by Gegenbaur (p. 538) after having been rejected on p. 533 of his *Lehrbuch*.

The *Fat bodies* belong at least physiologically to the generative system. They are placed outside the peritoneum. In

lizards they appear as two masses in the pelvic region, the black peritoneal lining covering only their dorsal side. They consist of a network of arteries and connective tissue, the meshy spaces of which are filled with "fat"; they each receive an artery from the femoral vessel which enters them in the inguinal region; the veins collect into the abdominal. In snakes the fat bodies are very long, extending from the cloaca to the liver. Tortoises seem to have only traces of them, but in *Sphenodon* and in crocodiles they resemble those of lizards.—The peculiar organ suspended from the right abdominal wall of crocodiles, variously mentioned as mesenteric gland or body, or fatty spleen, by Butler, is possibly related to the same category. The fat bodies of reptiles are sometimes vaguely alluded to as hibernating bodies; like the fat bodies which are attached to the generative glands of Amphibia they do not become reduced during the eventual hibernation but are largest before the pairing season, by the end of which they are exhausted, looking reddish or grey after the loss of their stores of fat and probably other important contents

The Embryonic Development.

Fertilization of the egg always takes place internally, and the egg containing a large amount of food-yolk is of course meroblastic. It is sufficient to mention that many lizards, some chameleons and many snakes (not *Sphenodon*, geckos, crocodiles and Chelonians) retain their, in these cases very thin-shelled, eggs in the oviducts until the embryo is ready to burst the egg-membrane during the act of parturition or immediately after it. Such species are usually called ovoviviparous, although there is no difference between them and other viviparous creatures, for instance the marsupials. The majority of reptiles are oviparous and the egg is enclosed in a strong parchment shell, with or without calcareous deposits. Only gas exchange can take place between such an egg and the outside, and it loses by evaporation, whilst in the batrachian egg various other exchanges are easy through the thin membrane. The salamander embryo, within its thin egg-membrane, even grows to a size many times larger than the original egg, it does not only breathe, but it is also nourished through the gills, and by some means or other the waste products are partly eliminated without filling the bladder. The Amphibia are born as larvae and live as such for a long time, often in a most imperfect condition. Nothing of all this applies to the reptile, which leaves the egg as a perfect little imago. A great amount of yolk supplying the material, and a large "bladder" to receive the waste products and to act as respiratory organ, have made this possible. That the allantois and the amnion behave precisely in the same way in the mammals with their much reduced yolk, only testifies to the superior value of these organs, and after all there is no difference in this respect between a monotreme and a reptile. These two organs seem to have come into existence with the reptiles and constitute the most reliable diagnostic feature between higher and lower vertebrates. All reptiles, birds and mammals have a navel, a feature unknown and impossible in Batrachia and fishes. A few remarks on these important embryonic organs may not be superfluous, especially concerning their possible origin.

Whilst the urinary bladder of the Batrachia remains within the body throughout the embryonic stage, this organ undergoes in the higher vertebrates, reptiles, birds and mammals, considerable modifications, and it assumes, henceforth as *Allantois*, new important functions besides that of being the receptacle of the embryonic urine. The development of the Allantois is in intimate causal connexion with that of the *Amnion*. All the *Allantoidea* are also *Amniota* and vice versa, but the term *Amniota* is preferable, since the basal portion of the Allantois remains in the adult as the urinary bladder, as an organ henceforth equivalent to and homologous with that of the *Anamnia*. The primary feature seems to be the allantois which leaves the body cavity, remains without the amniotic folds, even after these have enclosed the body within the amniotic bag, and

then spreads nearly all over the inner side of the egg-shell. Having thus come into the closest possible contact with the atmospheric air, the vessels of the allantois can exchange their carbon dioxide for oxygen and the allantois becomes the respiratory organ of the embryo. Herewith stands in direct correlation the complete absence of any internal and of external gills in the embryonic reptiles. The blood vessels of the allantois are fundamentally the same as those of the batrachian bladder, namely, branches from the pelvic arteries (later hypogastrics) and veins which return from the base of the bladder to the abdominal wall and thence to the liver.

In the normal reptilian egg, surrounded by its non-yielding shell, space is absolutely limited, and whilst the yolk is being diminished and increased secretion of urine distends the bladder, this soon protrudes out of the body cavity proper into the extra-embryonic coelomatic space between the true amnion and the false amnion or serous membrane. It fills this space so far as the yolk-sac allows it. It seems reasonable to suppose that this growth of the allantois has been one of the causes of the caudal amniotic fold; the sinking of the embryo into the space of the diminishing yolk-sac is no doubt another cause, but the fact remains that the amnion is the chief hindrance to the closing of the body-wall at the region of the future navel.

The life-histories of embryonic development are the domain of the embryographers. They are the imperfect accounts of the ways and means (often crooked and blurred, owing to short cuts and in adaptation to conditions which prevail during the embryonic period) by which the growing creature arrives at those features which form the account of the anatomical structure of the adult. Comparative anatomy, with physiology, alone lead through the maze of the endless embryonic vagaries and afford the clues for the reconstruction of the real life-history of an animal and its ancestry. For detail the reader is referred to numerous papers quoted in the list of literature, and to the various text-books, above all to the *Handbuch d. vergleichenden Entwicklungsgeschichte d. Wirbelthiere*, edited by O. Hertwig, Berlin.

AUTHORITIES ON ANATOMY: Bibliography.—The appended list of papers (many with shortened titles) represents but a fraction of the enormous literature dealing with the anatomy of reptiles. Special stress has been laid upon the more recent publications. A great amount of information, general and detailed, is contained in Bronn's *Klassen u. Ordnungen d. Thierreichs*, the three volumes concerning reptiles having been written by C. K. Hoffmann (Leipzig, 1878-1890); E. D. Cope's *Crocodylians, Lizards and Snakes of North America*, U.S. Nat. Mus., Washington, 1900; H. Gadow's "Amphibia and Reptiles," vol. xiii. of *The Cambridge Natural History* (London, 1901); above all in C. Gegenbaur's *Vergleichende Anatomie d. Wirbelthiere* (Leipzig, 1898-1901).

Skeletal.—J. F. v. Bemmelen, "Schaedelbau v. Dermochelys coriacea," *Festschr. f. Gegenbaur* (1896); E. Gaupp, "Morphologie d. Schaedels," *Morpholog. Arbeiten* (1894), iv. pp. 77-128, pls.; "Problems Concerning the Skull," *Anat. Ergebn.* (1901), x. pp. 847-1001. W. K. Parker, "Skull of Lacertilia," *Phil. Trans.* 170 (1880), pp. 595-640, pls. 37-45; of Tropidonotus, *ibid.* (1879), 169, pp. 385-417, pls.; "Crocodylia," *Trans. Zool. Soc.* (1885), xl. pp. 263-310, pls.; "Chamaeleons," *ibid.* (1885), xl. pp. 77-105, pls. 15-19; F. Siebenrock, "Kopfskelet d. Scincoiden, Anguiden u. Gerrhosauriden," *Ann. Nat. Hofmuseum* (Wien, 1892), vii. 3. Of the enormous, still increasing, literature concerning the homologies of the auditory ossicles, a few only can be mentioned; the papers by Kingsley and Versluys contain most of the previous literature; W. Peters, several most important papers in *Monatsber. Ak. Wiss.* (Berlin, 21st Nov. 1867, 5th Dec. 1867, 7th Jan. 1869, 17th Jan. 1870, 15th Jan. 1874). H. Gadow, "Modifications of the First and Second Visceral Arches, and Homologies of the Auditory Ossicles," *Arch. Anat. Hist. Sci.* (1885), xi. pp. 437-485, pls. 71-74. "Evolution of the Auditory Ossicles," *Anat. Anz.* (1901), xi. No. 16. J. Versluys, "Mittlere u. äussere Ohrsphäre d. Lacertilia u. Rhynchochaelia," *Zool. Jahrb. Anat.* (1898), 12, pp. 161-406, pls. (most exhaustive and careful); *ibid.*, "Entwickl. d. Coluella auris b. Lacertilia," *ibid.* (1903), 18, pp. 107-188, pls. J. S. Kingsley, "The Ossicula auditus," *Tufts College Studies*, No. 6 (1900). E. Gaupp, "Coluella auris," *Anat. Anz.* (1891), vi. p. 107. T. H. Huxley, "The Representatives of the Malleus and Incus of the Mammalia in the other Vertebrata," *P.Z.S.*, 1869. W. K. Parker, "Structure and Development of Crocodylian Skull," *Trans. Zool. Soc.* (1883), xii. especially pls. 68 and 69. H. Gadow, "Evolution of the Vertebræ, especially of Amphibia and Amniota," *Phil. Trans.* (1896), 136, pp. 1-57 (with a list of ninety-three papers). G. B. Hoves and H. H. Swinnerton,

"Development of the Skeleton of Sphenodon," *Trans. Zool. Soc.* (1901), xvi. pp. 1-86, pls. 1-6. G. A. Boulenger, *Catalogue of Chelonians, Rhynchocephalians and Crocodylians*, Brit. Mus. 1889; *Cat. of Lizards* (3 vols., 1885-1887); *Cat. of Snakes* (3 vols., 1893-1896); these volumes contain a great body of osteological observations, ignored by most compilers of anatomical text-books; "Osteol. of Heloderma, and Vertebrae of Lacertilia," *P.Z.S.*, pp. 109-115 (1891). L. Calori, "Skleton of Varanus, Lacerta," *Mém. Soc. Sci. Turin* (1870), 2, 1857, and 2 (1859). "Osteology of Lacertilia," *Proc. Anat. Phil. Soc.* (1892), 30, pp. 185-221; "Degeneration of Limbs and Girdles," *Journ. Morph.* (1892), vii. pp. 223-244. E. Ficalbi, *Ostologia del Platidattilo* (Pisa, 1882). A. Goette, "Beiträge z. Skeletsystem," *Arch. micr. Anat.* (1877), 14, pp. 502-620. A. Günther, "Anatomy of Hatteria," *Phil. Trans.* (1867), 157, pp. 595-629, pls. S. Orlandi, "Note anatomiche. Macroscincus, *Atti S. Lig.* (Geneva, 1894), 4, 2. "Sklet d. Scinc. Anguid. Gerrhosaurid," *Ann. Naturhist. Hofmus.* (1895), x. pp. 17-41; "Sklet d. Agamidae," *Sitzb. Ak. Wiss. Wien* (1895), 24, pp. 1089-1196. F. Siebenrock, "Sklet v. Brookesia," *Sitzb. Ak. Wiss. Wien* (1893), 102, pp. 71-118; "Sklet v. Uroplatan," *Ann. Naturhist. Hofmuseum* (1892), vii. pp. 517-536, 1893; "Sklet d. Lacertidien," *Sitzb. Ak. Wiss. Wien* (1894), 102, pp. 203-292. C. Smalian, "Anat. d. Amphibia," *Zeitschr. wiss. Zool.* (1885), 42, pp. 126-202. A. Voeltzkow, "Biolog. u. Entwickl. von Crocodilus," *Abh. Senckenb. Ges.* (1899), 26, pp. 1-150, 17 pls. E. A. Case, "Osteology and Relationships of Protostega," *Journ. Morph.* (1897), xiv. pp. 21-60. H. Goette, "Entwickl. des Cœrapax d. Schildkroeten," *Zeitschr. wiss. Zool.* (1899), 66, pp. 40-434. O. P. Hay, "Morphogeny of Chelonian Carapace," *Amer. Nat.* (1898), 32, pp. 92-148. G. Baur, "Morphol. d. Harkiefer d. Reptil," *Anat. Anz.* (1896), xi. pp. 410-415. M. Fürbringer, "Brustschulterapparat und Schultermuskeln. Reptilien," *Jena Zeitschr.* (1900), 34, pp. 215-718, pls. 13-17 (with a list of many titles of papers concerning reptiles; and a new, unsatisfactory classification of the whole class). C. K. Hoffmann, "Becken d. Amphib. u. Reptil.," *Niederl. Arch. f. Zool.*, iii. E. Mehnert, "Beckengürtel d. Emys lutaria," *Morph. Jahrb.* (1890), 16, pp. 537-571, pl.; "Os hyposiphicum, &c. d. Eidechsen," *Morph. Jahrb.* (1891), 17, pp. 123-144, pl. W. K. Parker, "Shoulder Girdle and Sternum," *Koy. Soc. London*, 1868. A. Gegenbaur, "Development of the Reptilian Limbs," *Zeitschr. wiss. Zool.* (1873), 23, pp. 116-170. A. Sabatier, "Comparaison des ceintures et des membres ant. et post.," *Mém. Ac. Montpellier* (1880), xix. C. Gegenbaur, *Untersuch. z. verg. Anat.*, "I. Carpus u. Tarsus" (1864), II. "Schultergürtel" (1865) (the most important monographs). A. Banchi, "Parafibula," *Montiore Zool. Italiano* (1900), xi. No. 7 (A node [?] between femur and fibula in Lacerta). G. Baur, "Carpus u. Tarsus d. Reptil.," *Anatom. Anzeig.* iv. No. 2. G. Born, "Carpus u. Tarsus d. Saurier," *Morph. Jahrb.* (1876), 2, pp. 1-26, pl. A. Carlsson, "Gliedmassenreste bei Schlangen," *Svensk Vetensk. Ac. Handlingar*, ii. (1886). A. Johnson, "Development of Pelvic Girdle," *O.J.M.S.* (1883), 23, pp. 399-411. G. Kehrer, "Carpus u. Tarsus," *Ber. Naturf. Ges.* (Freiburg, i. 1886). W. Kueckenthal, "Entwickl. d. Handskeletts des Crocodyliens," *Morph. Jahrb.* (1892), 19, pp. 42-55. H. F. Sauvage, "Membre antérieur du Pseudopus," *Ann. Sci. Nat.-Zool.*, 7. art. 15 (1878). A. Stecker, "Carpus u. Tarsus bei Chamaeleon," *Sitzb. Ak. Wiss.* (1877), 75, 2, pls. R. Wiedersheim, *Gliedmassenskelett, Schulter u. Beckengürtel* (Jena, 1892). K. Baechtdol, *Über die Gfhtwurke der Schlangen* (Tübingen, 1843). A. Duges, "Venin de l'Heloderma," *Jahrb. Soc. Biol.* (1899), pp. 43-37. W. Winkel, "Ueber die Egg-tooth of the Snake," *Proc. Zoolog. Institute* (Salern, 1886); and in *Wirbelth. Jahresheft, Verein naturh. Naturk.* (1886). G. S. West, "Buccal Glands and Teeth of Poisonous Snakes," *P.Z.S.* (1895), pp. 812-826, pls. 44-46.

Tegumentary.—A. Batelli, "Bau der Reptilienhaut," *Arch. micr. Anat.* (1880), 17, pp. 345-361, pls. J. E. V. Boas, "Wirbelthierkrallen," *Morph. Jahrb.* (1894), xxi. pp. 281-311, pl. A. Haase, "Bau d. Hautplatten bei den Geckotiden," *Arch. Naturg.* (1900), 61, pp. 321-345, pls. R. Keller, "Farbenwechsel d. Chamaeleons," *Arch. ges. Physiol.* (1895), 61, pp. 123-168. C. Kerbert, "Haut der Reptilien," *Arch. micr. Anat.* (1876), 13, p. 205-262. F. Maurer, *Epidermis und ihre Abkömmlinge* (Leipzig, 1895). F. Schaefer, "Schenkeldrüsen d. Ziechsen," *Arch. Anat. Hist. Sci.* (1902), 68, pp. 27-64. F. Todor, *Ricerche f. nel lavoro di anat. norm. d. Roma* (1878), II. 1. F. Toelg, "Drüsenartige Epidermoidalgänge d. Eidechsen u. Schlangen," *Arch. Zool. Inst. Wien* (1904), 15, pp. 119-154, pls.

Nervous System.—J. F. Bemmelen, "Beitr. Kenntniss d. Halsgegend bei Reptilien Medelched," *Natura Artis Magistra* (Amsterdam, 1887). L. Edinger, "Zwischenhirn d. Reptilien," *Abh. Senckenb. Ges.* (1899), 20, pp. 161-197, pls. J. G. Fischer, "Gehirnnerven d. Saurier," *Abhandl. Naturwiss. Verein. Hamburg*, II. (1852), pp. 115-212 (with many excellent illustrations). M. Fürbringer, "Spino-occipital Nerven," &c., *Festschr. f. Gegenbaur*, iii. (1896). S. P. Gage, "Brain of Trionyx," *Proc. Acad. Sci. Soc.* (1895), xvii. pp. 185-202. E. Gaupp, "Anlage d. Hypophysen," *Arch. Anat. Hist. Sci.* (1893), 42, pp. 569-680. Giuliani, "Struttura d. midolla spinale d. Lacerta viridis," *Ric. Lab. d. Anat. Roma*, ii. J. Grimm, "Rückenmark v. Vipera berus," *Arch. Anat. Phys.* (1864),

pp. 502-511, pl. 12. C. L. Herrick, "Brain of Certain Reptiles," *Journ. comp. Neurol.* (1891), p. 1-36, iii. (1893), pp. 77-106, 119-140, with many plates. O. D. Humphrey, "Brain of Chelydra," *Journ. comp. Neurol.* (1894), pp. 73-116. H. v. Jhering, *Das peripherische Nervensystem* (4to, Leipzig, 1873), pls. St. G. Mivart and R. Clarke, "Sacral Plexus of Lizards, &c.," *Trans. Linn. Soc. Zool.* i. (1877), pp. 513-532, pls. 66, 67. H. F. Osborn, "Origin of the Corpora callosa," *Morph. Jahrb.* xii, pp. 530-543. H. Rabi-Rückhard, "Centralnervensystem d. Alligator," *Zeitschr. wiss. Zool.* (1878), xxx, pp. 336-373, pls. 19 and 20. "Purdon," *ibid.* (1894), liviii, pp. 694-717, pl. 41. G. Ruge, "Peripher. Gebiet d. N. facialis bei Reptilien, Muskel, &c.," *Festschr. f. Gegenbaur* (1896), iii, L. Stieda, "Centralnervensystem d. Emys," *Zeitschr. wiss. Zool.* (1875), xxv, pp. 361-408.

Sense Organs.—R. Hoffmann, "Thraenenwege d. Vögel u. Reptil.," *Zeitschr. f. Naturw.* (Nat. Verein Sachsen u. Thüring., 1882). C. Röse, "Nasendrüse u. Gaumendrüsen d. Crocodils," *Anat. Anz.* (1893), viii, pp. 745-751. C. Ph. Sluiter, "Jacobson's Organ v. Crocodilus," *Anat. Anz.* (1892), vii, pp. 540-545. O. Seydel, "Nasenhöhle u. Jacobson's Organ d. Schildkröten," *Festschr. f. Gegenbaur* (1896), ii, B. Solger, "Nasennand u. Nasenschleim d. Reptil.," *Morph. Jahrb.* (1876), pp. 467-494, pl. E. Béranec, "Parietalauges d. Reptil.," *Jen. Zeitschr.* (1887), xxi, pp. 377-410, pls. 2; *ibid.*, *Anat. Anz.* (1893), No. 20. P. Francoette, "Cell. parietale &c. chez les Lacertiliens," *Mem. couronné Acad. Belgique* (1898), 55, No. 3. H. W. de Graaf, *Structure and Development of the Epiphysis in Amphib. and Rept.* (Leiden, 1886; written in Dutch). W. B. Spencer, "Presence and Structure of the Pinal Eye in Lacertilia," *Q.J.M.S.* (1886), 27, pp. 165-237, pls. H. Strahl u. E. Martin, "Entwickl. d. Parietalauges b. Anguis u. Lacerta," *Arch. f. Anat. u. Phys.* (1888), pp. 146-165, pl. 10. A. Dendy, "Development of Parietal Eye of Sphenodon," *Q.J.M.S.* (1899), 42, pp. 1-87 and pp. 111-153, 13 plates. H. Müller, *Schriften z. Anat. u. Physiol. d. Auges*, edit. O. Becker (Leipzig, 1872). E. Ficalbi, "Palpebralarapparat d. Schlangen u. Cuckonen," *Atti Soc. Tosc. Pisa*, ix, C. Hoffmann, "Anatomie u. Retina d. Amph. Rept. u. Vögel, Niederl.," *Arch. Zool.* (1875), iii. M. Borysiewicz, *Retina v. Chamaeleo vulgaris* (Leipzig, 1889), 7 pls. M. Weber, "Nebenergane d. Auges d. Reptil.," *Arch. f. Naturg.* (1897), 43. E. Clason, "Gehörorgan d. Eidechsen," *Anatom. Studien* (Leipzig, 1873). C. Hasse, "Gehörorgan d. Krokodile," &c., *ibid.*; "Gehörorgan d. Schildkröten, von Tropidonotus natrix," *ibid.*; G. Retzius, *Gehörorgan d. Wirbelthiere*, i. (Stockholm, 1881).

Muscles.—O. C. Bradley, "Muscles of Mastication of Lacertilia," *Zool. Jahrb. Anat.* (1902), 18, pp. 475-488. M. Fürbringer, "Vergleich. Anatomie d. Schultermuskeln," *Jena Zeitschr.* (1873), vii, pp. 237-320; (1874), vii, pp. 675-880; (1900), xxx, pp. 215-718; *Jena Zeitschr.* (1875), vii, pp. 139-181; *Knochen u. Muskeln d. schlangenähnlichen Vierter Leibesgegend*, Leipzig, 1876. "Bauchmuskeln d. Crocod. Eidechsen. Schildkröten," *Morph. Jahrb.* (1882), vii, pp. 57-100, pl.; "Myologie d. hinteren Extremität d. Reptilien," *ibid.* (1882), vii, pp. 327-466, pls. G. M. Humphrey, "Muscles of Pseudopus," *Journ. An. Phys.* (1872), vii. G. Killian, "Ohrmuskeln d. Crocodile," *Jen. Zeitschr.* (1890), xxiv, pp. 632-656, pl. F. Maurer, "Centrale Rumpfmuskulatur d. Reptil.," *Festschr. f. Gegenbaur* (1896), i. St. G. Mivart, "Muscles of Iguana," *P.Z.S.* (1867), p. 766; "of Chamaeleon," *ibid.* (1870), p. 850. N. Rosén, "Kaumuskeln d. Schlangen u. Gilttrüese," *Zool. Anz.* (1906), 28, pp. 1-7. A. Sanders, "Muscles of Platydactylus," *P.Z.S.* (1870), p. 413; "of Liolepis," *ibid.* (1872), p. 154; "of Phrynosoma," *ibid.* (1874), p. 71; F. Walther, "Visceralskelett u. Muskulatur b. Amph. u. Rept.," *Jen. Zeitschr.* (1887), xxi, pp. 1-45, pls.

Respiratory System.—F. E. Beddard, "Trachea and Lungs of Ophiophagus bungarus," *P.Z.S.* (1903), pp. 319-328. G. Butler, "Suppression of one Lung in various Reptiles," *ibid.* (1895), p. 691. S. H. Gage, "Pharyngeal Respiration in the Soft-shelled Turtle," *Proc. Am. Ass. Adv. Sci.* (1884), pp. 316-318; and *Amer. Nat.* (1886), xx, pp. 233-236. J. Henle, *Vergl. Anat. Beschreibung d. Kehlkopfes* (1839). F. Siebenrock, "Kehlkopf u. Luftrohr d. Schildkröten," *Sitzb. Ak. Wien* (1899), 108, pp. 563-595, pls. G. Tornier, "Kopftappen u. Halslutsacke bei Chamaeleonen," *Zool. Jahrb. Anat.* (1904), 21, pp. 1-40, pls. D. Bertelli, "Pieghie dei renni primitivi nei Rettili. Contributo allo sviluppo del diaframma," *Atti Soc. Toscan.* (Pisa, 1896), 15, (1898), 16. I. Bromann, *Entwicklung d. Bursa omentalis und zehnter Reccessbildungen* (Leipzig, 1894). G. Butler, "Subdivision of Body-cavity in Lizards, Crocodiles and Birds," *P.Z.S.* (1892), pp. 452-474, 4 pls.; "Subdivision of Body-cavity in Snakes," *ibid.* (1892), pp. 477-497, pl. 6; "The Fat Bodies of the Saurosida," *ibid.* (1889), p. 602, pls. 59-60. F. Hochstetter, *Scheidewandbildungen in d. Leibeshöhle der Krokodile*, Voeltzkow, *Reise in Ostafrika*, vol. iv, pp. 141-206, pls. 11-15 (Stuttgart, 1906).

Vascular System.—F. E. Beddard, various papers on vascular system of Ophidia and Lacertilia, *P.Z.S.* (1904); "Notes on Anatomy of Boidae," *ibid.* (1903), pp. 107-121. F. E. Beddard and P. C. Mitchell, "Structure of Heart of Alligator," *ibid.* (1895). A. Greil, "Herz u. Truncus arteriosus d. Wirbelthiere Reptilien," *Morph. Jahrb.* (1903), 31, pp. 123-310, pls. O. Grosser and E. Brezina, "Entwickl. Venen d. Kopfes u. Halses bei Reptil.,"

Morph. Jahrb. (1895), pp. 289-325, pls. 20 and 21. F. Hochstetter, several important papers on vascular system of reptiles, *Morph. Jahrb.* (1891, 1892, 1898, 1901); *ibid.*, "Blutgefäß-System," O. Hertwig's *Entwickl. d. Wirbelthiere* (Jena, 1902); "Blutgefäß-System d. Krokodile," Voeltzkow, *Reise in Ostafrika* (Stuttgart, 1906, iv.). A. Langér, "Entwickl. Bulbus cordis bei Amph. u. Rept.," *Morph. Jahrb.* (1894), pp. 40-67. J. Y. Mackay, "Arterial System of Vertebrates, homologically considered," *Memoirs and Memoranda in Anatomy* (London and Edinburgh, 1889), i. B. Penzance, *Sopra il sistema linfatico dei rettili* (Pavia, 1833). C. Roese, "Vergl. Anat. d. Herzens d. Wirbelthiere," *Morph. Jahrb.* (1890), 16, pp. 27-96, pls. A. Sabatier, *Etudes sur le cœur et la circulation centrale* (Paris, 1873); "Transformations du système aortique," *Ann. Sc. Nat. Ser.* (1874), 5, J. 19. H. Watney, "Minute Anatomy of Thymus," *Phil. Trans.* (1882), 173, pp. 1063-1123, ps. 83-95.

Urogenital System.—J. E. V. Boas, "Morphol. d. Begattungsorgane d. Wirbelth.," *Morph. Jahrb.* (1891), xvii, pp. 171-287, pl. 16. J. Budge, "Das Harnreservoir d. Wirbelthiere," *Neu Vorpommern*, Mittheil. 7 (1875), pp. 20-128, pl. W. R. Cooe and B. W. Kunkel, "Reproduct. Org. of Aniella," *Amer. Natural.* (1904), 38, pp. 487-490. H. Gadow, "Cloaca and Copulatory Organs of the Amniota," *Phil. Trans. B.* (1887), pp. 5-37, pls. 2-5. K. Hellmuth, "Kloake u. Phallus d. Schildkröten u. Krokodile," *Morph. Jahrb.* (1902), 30, pp. 582-613. F. v. Moeller, "Urogenital-system d. Schildkröten," *Zeitschr. wiss. Zool.*, 65, pp. 573-598, pls. F. W. Pickel, "Accessory Bladders of Testudinata," *Zool. Bull.* (1899), ii, pp. 291-391. F. School, *Zur Kenntnis d. Urogenitalsystems d. Saurier*, *Arch. f. Naturg.* (1888), 54, p. 62. P. Unterhossel, "Kloake u. Phallus d. Eidechsen u. Schlangen," *Morph. Jahrb.* (1902), 30, pp. 541-581. O. Schmidtgen, "Kloake und ihre Organe bei Schildkröten," *Zool. Jahrb.* (1907), pp. 357-412, pl. 32, 33. (H. F. C.)

IV. DISTRIBUTION IN SPACE

This zoo-geographical review deals only with modern reptiles. We begin with a survey of the faunas of some of the most obvious land-complexes which bear close resemblance to the now classical "regions" of P. L. Sclater and A. R. Wallace. None of these "regions" has definable frontiers, and what acts as a bar to one family may be totally ignored by another. According to the several orders of reptiles the world is mapped out in very different ways. The African fauna does not stop at the Suez Canal, nor even at the Red Sea; there is a transitional belt noticeable in the countries from Syria to Arabia, Persia and India. To the north, Indian influence extends right into Turkestan, or vice versa; the Central Asiatic fauna passes into that of India. On the Chinese side prevailing conditions are still almost unknown; Wallace's line is more or less rigidly respected by Trionychidae, hooded *Elops*, vipers and Lacertidae, while it has not the slightest influence upon crocodiles, pit vipers, Varanidae, Agamidae, &c. In the western hemisphere we have a grand illustration of the interchange of two faunas and of the fact that it is neither a narrow strait nor an equally narrow isthmus which decides the limitation of two regions. Central America and the Antilles form one complex with S. America. The nearctic region ends at the edge of the great Mexican plateau, which itself is a continuation of the north continent. Many nearctic forms have passed southwards into the tropics, even into far-off S. America, but the majority of the southerners, in their northern extension, have been checked by this plateau and have surged to the right and left along the Pacific and Atlantic tropical coastlands. The present writer happens to have made a special study of this part of the world (cf. "The Distribution of Mexican Amphibians and Reptiles," *P.Z.S.*, 1905, pp. 191-294); the N. and S. American faunas have therefore been more fully treated in the following review of the various faunas. No doubt others can be treated in a similar manner, but the physical features between N. and S. America are unique, and the results are closely paralleled by those of the fauna of birds. The narrow and long neck of the isthmus of Panama (once no doubt much broader) is no boundary; if the meeting of N. and S. had taken place there, that narrow causeway would be crowded, and this is not the case.

NEW ZEALAND.—The only recent reptiles are *Sphenodon* (gen.), which testifies to the great age of these islands; about half a dozen Scincidae of the genus *Lygosoma*, members of a cosmopolitan family; and some few geckos, e.g. *Nautinus*, of a family of great

age, world-wide distribution and with exceptional facilities of distribution.

AUSTRALIAN REGION.—Of crocodiles only *C. johnstoni* in N. Australia and Queensland; *C. porosus* on the N. coast, and occurring on various Pacific islands, as far E. as the Fiji Islands. Tortoises are represented only by the pleurodirous Chelydidae, e.g. *Chelodina*; they are absent in Tasmania and on the Pacific islands. New Guinea possesses the aquatic *Carettochelys*, sole type of a family.

The bulk of the Lacertilian fauna is composed of skinks, geckos, agamoids and Varanidae, with the addition of a small number of species peculiar to the region, the Pygopodidae. A peculiar type, *Dibamus*, inhabits the borderlands, namely, New Guinea, the Moluccas, Celebes and the Nicobar Islands; and, finally, a single iguanoid, *Brachylophus*, is common in the Fiji Islands; how it came there, or how it survived its severance from the American stock, is a mystery. The skinks are in this region more highly developed and more specialized than in any other part of the world; they exceed in numbers the geckos, which generally accompany the skinks in their range over the smaller islands of the Pacific; in these islands members of these two families represent the whole of the Lacertilian fauna. The Australian agamoids are chiefly peculiar and partly much differentiated forms (e.g. *Moloch* and *Chlamydosaurus*), but some have distinct affinities to, or are even identical with, Indian genera. The Varanidae are also closely allied to Indian species.

Of snakes, amounting to about one hundred species only, we note about one dozen Typhlopidae, and of Pythonidae simply *Python*, and the Boine *Enygrus* on the islands from New Guinea to Fiji. There are but surprisingly few innocuous colubrine snakes, scarcely a dozen, and all belonging to Indian genera. The bulk of the snakes belong to the poisonous Elapinae, and to the Viperidae of the region, e.g. *Acanthophis*, *Pseudochis*, *Notechis*. Such a preponderance of poisonous over harmless snakes is found nowhere else in the world. Tasmania is tenanted by poisonous snakes only. In Australia we meet, therefore, with the interesting fact that, whilst it is closely allied to S. America, but totally distinct from India by its Chelonians, its lizards and colubrine snakes connect it with this latter region. With regard to the other Ophiidians, they have their nearest allies partly in India, partly in Madagascar, partly in S. America; and the character of the Australian snake fauna consists chiefly in its peculiar composition, differing thereby more from the rest of the equatorial region than those do among themselves.

Wallace's line as the boundary between India and Australia only as far as Melanians are concerned, but it is quite effaced by the distribution of lizards and snakes. Thus in New Guinea lizards of the Indian region are mixed with Pygopodidae, and an island as far E. as Timorlaut is inhabited by snakes, some of which are peculiarly Indian, whilst the others are as decidedly Australian. The islands N. of New Guinea and of Melanisia are not yet occupied by the Ophiidian type, and only species of *Enygrus* have penetrated eastwards as far as the Low Archipelago, whilst the Fiji Islands and the larger islands of Melanisia have sufficiently been raised above the level of the sea to develop quite peculiar genera of snakes.

INDIAN REGION.—Of Crocodilia *C. palustris*, the "mugger" or marsh crocodile, and *C. porosus*; *Gavialis gangeticus*; *Tomistoma schlegelii* in Borneo, Malacca and Sumatra. Of tortoises *Platysternum megacephalum*, type of a family from Siam to S. China; many Trionychidae and Testudinidae, mostly aquatic; whilst the terrestrial *Testudo* is very scantily represented. One species which is common in the Indian peninsula (*T. stellata*) is so similar to an African species as to have been considered identical with it; the Burmese tortoise is also closely allied to it, and the two others extend far into western-central Asia. Thus this type is to be considered not as an immigrant from the present headquarters in Africa, but a survivor of the Indian Tertiary fauna, which comprised the most extraordinary forms of land tortoises. Wallace's line marks the E. boundary of *Trionyx*; species of this genus are common in Java and Borneo, and occur likewise in the Philippine Islands, but are not found in Celebes, Amboyna or any of the other islands E. of Wallace's line. Agamidae are exceedingly numerous, and are represented chiefly by arboreal forms, e.g. *Draco* (*a. s.*) peculiar to the region, *Ceratophora* and *Lyriocephalus* exclusively Ceylonese; terrestrial forms, like *Agama* and *Uromastix*, inhabit the hot and sandy plains in the N.W., and pass uninterceptedly into the fauna of western-central Asia and Africa. The Geckonidae, Scincidae and Varanidae are likewise well represented, but without giving a characteristic feature to the region by special modification of the leading forms except the gecko *Psychosoon homaloecephalum* in Malaya. The Lacertidae are represented by one characteristic genus, *Tachydromus*—*Ophiops* and *Cabria* being more developed beyond the limits assigned to this region. Finally, the Eublepharidae and Anguidae, families whose living representatives are probably the scattered remains of once widely and more generally distributed types, have retained respectively two species in W. India, and both in the Khasi Hills, whilst a single species of chameleon in S. India and Ceylon reminds us again of the relations of this part of the fauna to that of Africa.

The Indian region excels all the other tropical countries in the great variety of genuine types and numbers of species of snakes. Boulenger¹ recognizes 267 species, i.e. about one-fifth of the total number of snakes known. India is the only country in the world possessing viperine, crotaline and elapine poisonous snakes (their proportion to harmless snakes being about 1 : 10), e.g. *Vipera russelli*, the "daboba" (see VIPER); *Lachesis*, e.g. *gramineus*, an arboreal pit viper; *Naja tripudians*, the cobra; *Bungarus coruscus*, the "kras"; *Calophis*; and Hydrophinae along the coasts of the whole region. Several sub-families and families are peculiar to the region: the Uropeltidae with *Rhinophis* in southern India, and *Uropeltis* confined to Ceylon; Ilysiidae in Ceylon and Malay Islands, elsewhere only in S. America; the opisthogyphous *Elaichodon westermanni* of Bengal; the Homalopsinae, with many species from Bengal to N. Australia; further the Amblycephalidae; *Xenopeltis unicolor*, sole type of a family; and the Acrochordinae, a sub-family of aglyphous Colubridae, ranging from the Khasi Hills to New Guinea. Of other Colubridae, we notice numerous *Tropidonotus*, *Coronella* and *Zamenis*, the latter one of the most characteristic types of the warmer parts of Eurasia. Tree-snakes, e.g. *Dipsas* and *Dendrophis*, are common. Of other families we note a great number of Typhlopidae, of which *T. braminus* occurs even on Christmas Island. Lastly various species of *Python*, but no Glauconidae, the only family not represented in the Indian region, which claims the Uropeltidae, Xenopeltidae and Amblycephalidae as peculiar to itself.

Günther remarks that to this region Japan has to be referred. This is clearly shown by the presence of species of *Ophis*, *Calophis*, *Trimeresurus*, *Lachesis*, *Tachydromus*, characteristically Indian forms, with which species of *Clemmys*, *Trionyx*, *Gecko*, *Haly*, and some Colubrinae closely allied to Chinese and Central Asiatic species are associated. *Haly* is a central Asiatic pit viper. The few reptiles inhabiting the northern part of Japan are probably of palaeartic origin.

THE AFRICAN CONTINENT.—Of crocodiles, *C. vulgaris* in the E., *C. calophractus* and *Osteoleaemus tetraspis* in the W. There are many Chelonians, especially small land tortoises of *Testudo*, and with *Cinyx* which is peculiar to this continent; the freshwater *Clemmys* only in the N.W. corner; several genera of the pleurodirous Pelomedusidae, *Pelomedusa galeata*, which is equatorial and southern, with an outlying occurrence in the Sinai peninsula, and *Sternotherus* with several tropical and southern species; of Trionychidae the tropical *Cyclodermis* and *Cyclanorbis* peculiar to the country, and the large *Trionyx triunguis* which ranges from the Senegal and Congo into the Nile system with its big lakes, but occurring also in Syria.

Of Lacertilia the geckos and skinks, and the typically old world families of Lacertidae and Varanidae are well represented; also Amphisbaenidae; Gerrhosauridae and Zonuridae, peculiar to Africa and Madagascar; a few Eublepharidae and a few of the so-called Aneleptrodidae in West Africa. But the most important feature of this Lacertilian fauna is the almost universal distribution of geckos in numerous and some highly specialized forms, *Chamaeleon* and *Rhampholeon*. We note the entire absence of Iguanidae and Anguidae, the latter represented by *Ophisaurus* only in the north-western corner.

Of snakes only one sub-family is peculiar, the Rhachiodontinae with the sole species *Dasyptellus scabra*, the egg-swallowing snake. Many Typhlopidae and Glauconidae, but no Ilysiidae; large pythons, *Eryx* in the N., and a boa, *Pelophilus fordii* in the W. of Africa. Of poisonous snakes there is an abundance, notably the Viperinae have their centre in this continent; besides *Echis*, which is also Indian, and a peculiar one to the continent *Bisus*, the puff-adder, *Causus*, *Atractaspis*, *Cerastes*, and *Atheris* which is an arboreal genus, all of which see under VIPER. The pit vipers are entirely absent. Elapinae are numerous, e.g. hooded cobras like *Naja haje* and *Seledon* the "rhingals." Many opisthogyphous tree snakes and a considerable number of innocuous colubrinae, e.g. *Lygodon*, *Psammophis* and *Coronella* or closely allied genera all also in India, but *Coluber*-like forms and *Tropidonotus* are very scantily represented, chiefly in the N.

On the whole the reptilian fauna of Africa is not rich, considering the huge size of the continent, but this may be accounted for by the great amount of desert in the N. half, and the want of veld in the S. Lastly, the enormous central forests are still scarcely explored.

MADAGASCAR and certain other islands have a fauna which is as remarkable for its deficiencies as it is for its present forms. The following well-defined groups are absent: Trionychidae and Chelydidae; Agamidae, Lacertidae, Anguidae, Amphisbaenidae, Varanidae and Eublepharidae; all the Viperidae and Elapinae, so that this large island enjoys perfect absence of poisonous snakes, not counting the practically harmless opisthogyphous tree snakes; there are further no pythons and no ilysiids.

The actual fauna consists of: *Crocodilus vulgaris*, which is said to be extremely abundant; of Chelonians, *Pelomedusa galeata* and

¹The same authority enumerates 556 species of reptiles for British India, i.e. about one-sixth of all the recent species of reptiles (*Fauna of British India*, edit. W. T. Blanford, London, 1890).

Sternotherus, both also in Africa, *Podocnemis*, which elsewhere occurs in South America only, and several Testudinidae; of these *Ptyx* is peculiar to Madagascar, while *Testudo* has furnished the gigantic tortoises of Aldabra, the Seychelles, and recently extant in Mauritius and Madagascar. Of lizards are present a few Gerrhosauridae and Zonuridae, both African types; the remarkable occurrence of two iguanid genera *Chalarodon* and *Hoplorus*, both peculiar to the island; skinks, many geckos, and *Uroplatus*, sole type of the Uroplatinæ and an abundance of chameleons, of the genus *Chameleo* with *C. parsoni*, the giant of the family, and the small species of *Brookestia*, a genus peculiar to Madagascar. Of snakes we note Typhlopidae and Glauconidae, and the remarkable occurrence of Boinae, two of the genus *Boa* (*Pelophilus*), one of *Corallus* on the main island and *Casarea* on Round Island. There are ophioglyphous mostly arboreal snakes, and the rest are innocuous colubines, some few with Indian and African affinities, e.g. *Zamenis* s. *Ptyas*, more with apparently S. American relationship, or at least with resemblance in taxonomic characters.

An analysis of this peculiarly compound and deficient fauna gives surprising results, namely, the almost total absence of affinity with the Indian region, close connexion with Africa by the possession of Gerrhosauridae, Zonuridae, Chameleons and Pelomedusidae; lastly, the presence of several tree boas, of *Podocnemis* and of Iguanidae, i.e. families and genera which we are accustomed to consider as typically neo-tropical. Peculiar to Madagascar, autochthonous and very ancient, is only *Uroplatus*. Ancient are also the tortoises, chameleons, geckos, boas, typhlops, gerrhosaurids and zonurids. The absent families may be as ancient as the others, but most of them, notably *Varanus*, lacertids and agamids are of distinctly northern, para-tropical origin, and common with certainty that they had not spread into S. Africa before Madagascar and its satellites became severed from the continent.

EUROPE AND TEMPERATE ASIA.—The present reptilian fauna of this vast area is composed almost entirely of the leavings of those groups which are now flourishing with manifold differentiations under more genial climes, in Africa and India. Fossils, none too numerous, and long that it was not always thus, since crocodiles, alligators and true-snouted gavials, all the main groups of chelonians, iguanoids, &c., existed in England, the crocodilians persisting even towards the end of the Tertiary period.

The present fauna is composed of the European sub-region, existing small survivors in the Jordan basin, on the borderland of Africa; but the Yang-tse-Kiang is inhabited by an alligator, *A. sinensis*, while all its congeners are now in America. This finds, to a certain extent, a parallel in *Trionyx*, of which one species lives in the Euphrates basin, likewise borderland, and another, *T. maacki*, in rivers of N. China, e.g. in the Amoor. Of other Chelonians we note several species of *Testudo*, two of them European; *Emys europaea*, chiefly in Europe, with the other species *E. blandingi* in the eastern United States; and a few species of *Clemmys*, a truly perarctic genus.

The current we exclude the American. Of geckos *Hemidactylus turcicus* extends from Portugal to Karachi; *Platydictyus facetans* is at home in most S. Mediterranean countries; *Teratoscincus* is peculiar to the steppes and deserts of Turkestan and Persia; other geckos in the transitional region from Asia Minor to India. Of Lacertae we have Anguidae, Agamidae, Lacertidae, Amphibiaenidae and Scincidae, most of them in Europe represented by but one or two species. Thus *Blanus cinereus* in Mediterranean countries, Asia Minor and Syria, represents the Amphibiaenidae which are found nowhere else in Europe or Asia, but plentiful in Africa and both America, and the Anguine *Anguis fragilis* in Africa and to Europe. *Ophisaurus apus* in S.E. Europe and another in Indo-Burman countries, with the rest of the species in N. America. Of Scincidae few in Europe, e.g. *Chalcides* s. *Seps* s. *Gongylus*, others from Asia Minor eastwards, e.g. *Scincus*, and *Albepharus* in Turkestan. Agamidae do not occur in Europe but they exist in considerable numbers from Asia Minor and Turkestan to China, with *Phrynocephalus* peculiar to central Asia. Lastly, the Lacertidae, of which several species of *Lacerta*, *Psammoromus*, *Acanthodactylus* in Europe, but the majority in Africa and warmer parts of India; and in a similar manner the Manchurian forms are related to Chinese.

The total number of snakes amounts to about sixty, the majority living in the Mediterranean countries and in W. Asia. One *Typhlops* in the Balkan peninsula and in W. Asia, in Persia also *Glaucina*; *Eryx jaculus* extends into Greece from S.W. Asia as sole representative of the Boidae. Several vipers, the common viper, *V. berus*, from Wales to Saghalien Island, *V. aspis*, *V. latistai* and *V. ammodytes* in S. Europe; a pit viper, *Ancistrodon*, e.g. *halyi*, in the Caspian district, thence this genus through China and again in N. America. *Echis* extends N. into Turkestan. The Indian cobra ranges N. to Transcaspa and far into China. All the other snakes belong to the aglyphous and ophioglyphous Colubridae; of the latter *Coleopholis* is peculiar to S. Europe and S.W. Asia; *Macropododon cucullatus* to S. Spain, the Balearic Islands and N. Africa; *Tephrotopon* peculiar to Turkestan and neighbouring countries; none extending into E. Asia. Of the aglyphous colubines the most characteristic genus is *Zamenis* incl. *Zaocys*, very widely spread and including more species than any other palaeartic genus; several species of the wide-ranging genus *Tropidonotus*, besides *Coluber*

with *Rhinechis scalaris* in S.W. Europe. There are, besides, other genera, especially in the debatable countries of S.W. Asia, Persia and Afghanistan, and speaking generally the colubines show less affinity to African than to Indian forms, just as we should expect from the prevailing geographical conditions. If it were not for the N.W. corner of Africa and portion of its N. coast, the European fauna would have very little in common with Africa.

NORTH AMERICA.—Of this huge continent only the United States and Mexico come into consideration, since N. of 45° latitude reptilian life is very scarce. The number of species, however, is not so large as the Indian and Malay countries, and larger than the Australian region. Yet the fauna is comparatively poor, very poor indeed, if it were not for Mexico and the Sonoran province, which seems to be the ancient centre of distribution of much of the present typically N. American fauna.

Characteristic of the area is the abundance of Chelonians and Iguanidae, to which Tejidae have to be added in the S.; equally characteristic is the complete absence of Pleurodirous Chelonians, of Chameleons, Agamidae, Lacertidae, Varanidae and Viperinae. The fauna is composed as follows: Crocodylia, with *Crocodylus americanus* and *Alligator mississippiensis* in the S. Of Chelonians the Chelydridae, peculiar to the E. half but for the reappearance of a species of *Chelydra* in Central America; many Cionosternidae likewise almost peculiar to the area; of Testudinidae an abundance of freshwater forms, notably *Chrysemys*, and *Emys* in common with Europe, whilst terrestrial tortoises are extremely scanty, namely one species of *Testudo*, *T. polyphemus*, the gopher, and two of *Cistudo*, e.g. *C. carolina*; lastly, two *Trionyx* in the whole of the Mississippi basin and thence N. into Lake Winnipeg, 51° N. Lacertidae are not so numerous as in America, but have received only *Sphaerodactylus notatus* from the Antilles in the Pacific and *Phyllodactylus tuberculatus* into California from the Pacific side of Mexico; Eublepharinae are absent. Of Iguanidae we have a typically Sonoran set, e.g. *Crotaphytus*, *Holbrookia*, *Uta*, *Phrynosoma*, *Sceloporus*, and a S. set of which only *Anolis* extends out of the tropics. It is significant that only a few species of *Sceloporus* and *Phrynosoma* extend into the United States, although far N.; of the large genus *Anolis* only *A. carolinensis* enters Texas to Carolina. *Sceloporus* may be called the most characteristic genus of Sonoranland and Mexico. Of the tropical family of Tejidae only *Cnemidophorus*, with many species in Mexico, few in the adjoining N. states, and with *C. sexlineatus* over the greater part of the Union. *Anguidae*: *Ophisaurus ventralis* in the United States; the other species in the Old World. *Diploglossus* peculiar to mountains of Mexico. *Gerrhonotus*, the main genus, centred in Mexico, but *G. coeruleus* ranges from Costa Rica along the Pacific side right into British Columbia, the most northern instance of a New World reptile.

Xenosaurus grandis of Mexican mountains is the monotype of a family, and the same would apply to *Heloderma* (*H. suspectum*, the Gila monster of the hottest lowland parts of Arizona and New Mexico) and *H. horridum* (of Mexico) if it were not for *Lampropeltis* of Borneo. Scincidae, of this cosmopolitan family, America possesses the smallest number, and it is significant that the number of species decreases from N. to S.; *Eumeces* from Minnesota and Massachusetts through Mexico, with many species, and *Xantusia* s. *Mocosa laterale* from S.E. and Central States to Mexico. *Xantusia*, a small family, is composed of a N. or Sonoran and a S. or Central American-Antillean group; e.g. *Xantusia* of the deserts of Nevada and California. *Amelia*, monotype of a family of California to El Paso, Texas, i.e. peculiar to Sonoranland, Amphibiaenidae with *Rhynchoceros* in Florida and the marvelous *Strophosaurus* in Lower California and the Pacific side of Mexico; the other members of this family are tropical so far as America is concerned.

Snakes: of Typhlopidae only *Anomalapsis mexicana*, peculiar to Nuevo Leon; of Glauconidae several extending N. into Texas and Florida. Boinae continue N. as the arenicolous *Lichanura* of Lower California and Arizona, and the likewise arenicolous *Charina botae* which extends from California to the state of Washington; the other members of the family are all tropical, extra-regional. Of Viperidae only pit vipers occur, but of them rattlesnakes cover the whole of the habitable area; *Ancistrodon*, without a rattler, e.g. the meadow snake and the water viper, has other species in central and E. Asia. Of Elapinae, far into the E. United States only the genus *Elaaps* with a few species, of which *E. fulvius*, the commonest, ranges from S. Brazil far into the S. and E. states. A few ophioglyphous, terrestrial, snakes just enter the United States from Mexico, e.g. *Trimorphodon*. Of aglyphous colubines species of genera like or resembling *Tropidonotus*, *Coronella* and *Coluber*, including *Ptyopsis* and *Spilotes*, are abundant, the latter being very characteristic; *Ischnognathus* and *Contia*, *Ficimia* and *Zamenis* likewise are clearly nearctic, or Sonoran.

The *Gerrhonotus* and *Phrynosoma* neotropical, i.e. Central American and S. American affinities, but there is also some Sonoran infusion.—There is *Crocodylus americanus*; no Chelonians are natives except one or two *Chrysemys*. Of Lacertilia, geckos are abundant; of Iguanidae several arboreal forms, notably the large *Iguana*, and *Metopoceros* of Haiti, and *Cyclura*, both peculiar; of Anguidae *Celestus*, peculiar, but closely allied to *Diploglossus*; of Xantusiidae the peculiar genus *Cricosaura* s. *Cricolepis*. Of

Amphisbaenidae *Amphisbaena* itself occurs in Puerto Rico and on the Virgin Islands. Of Tejidae only *Ameiva*, not *Cnemidophorus*. Snakes: a *Typhlops* in Puerto Rico; of boas *Epicrates*, *Uroaia* and *Coralus*, the latter re-occurring in Madagascar. Absent are: Viperidae, Elapinae and Opisthophlyps; of aglyphous colubrids the Central American genera *Urotheca*, *Dromicus*, *Drymobiis* and *Leptophis*; the genera of distinctly northern origin.

SOUTH AND CENTRAL AMERICA.—The fauna is very rich. It is advisable first to mention those groups which are either confined to Central America (including the lowlands of Mexico), e.g. the Dermatemnydidae, Anelytrophidae, Anelytrophis and the aglyphous colubrids: *Urotheca*, *Dromicus*, *Drymobiis*, *Leptophis*, *Rhadinea*, *Streptophorus*, or which, from their N. centre have sent some genera into Central America, or beyond into the S. continent: e.g. *Chelydra rossignoni*, ranging from Guatemala to Ecuador; one *Cinosternum* extending into Guiana; *Testudo tabulata*, the only terrestrial tortoise of S. America, besides the gigantic creatures of the Galapagos Islands; a few Eublepharinae reaching Ecuador; of Anguillidae *Gerrhonotus cyroaleus*, extending S. to Costa Rica; of Scincidae, *Mabouia* and *Leiosoma*, which extend far into S. America, and the same applies to the Amphisbaenidae. Immigrants from the N. are probably also the Iguanidae, although they have found a congenial home in the S. countries, where they are now represented by an abundance of genera and species, e.g. *Laemancus* and *Corytophanes* of Mexico, *Anolis*, *Iguana*, *Basiliscus*, *Ctenosaura*, *Polychrus*, *Hopliurus*, *Chalarodon*. Amongst snakes the following appear to be of N. origin: Boidae (with the Pythonine *Loxocemus bicolor* in Mexico), in spite of their great development of boas and anacondas in the S.; certainly Crotalinae, of which only one species, *C. terrificus*, is found in S. America; further, some aglyphous colubrids, which have sent a few species only into Central, and still fewer into S. America, e.g. *Tropidontis*, *Tachynotatus*, *Onisia*,¹ *Pictinia*, *Coluber*, *Spilotes*, *Pityophis*, *Cornelia*² and *Zamenis*.

After these numerous restrictions we should expect the genuine autochthonous fauna of the S. American continent to be very scanty, especially if we remember those important Old World groups which are absent in America, e.g. Varanidae, Lacertidae, Agamidae and chameleons, and that Central and S. America have no Trionychidae. The oldest S. American reptilian fauna is composed as follows. It is the only part of the world which possesses Chelydidae in abundance, e.g. of *Chelys* the *Matamata*, *Hydromedusa*, and of Pelomedusidae, *Pelocnemis*, which re-occurs in Madagascar. Crocodyls are represented by *Crocodylus americanus* and *C. moreletii* in the N. and by about five species of *Caiman*.³ Of Lacertilia geckos are rather few, mostly in the N.W. of the continent, more numerous in Central America and the Antilles. The Tejidae are clearly a neotropical family, with several dozen genera in S. America; of all these, only *Ameiva* and the closely allied *Cnemidophorus* extend through and beyond Central America: *Ameiva* into the E. and W. hot lands of Mexico and into the Antilles, *Cnemidophorus* through Mexico far into most of the United States with a few species. Of snakes there is an abundance. Typhlopidae and Glauconiidae are well represented. Of aglyphous colubrids many genera, some of them extending northwards into Mexico, but not to the Antilles, e.g. *Atractes*, *Tropidodipsas*, *Dirosema*, *Geophis*, *Xenodon*.

Opisthophlyps are very numerous in genera and species both in S. and Central America, whence many of the arboreal forms extend into the hot countries of Mexico, while a few terrestrials have spread over the plateau and thence into the United States, none entering the Antilles; such typical neotropical genera are *Himantodes*, *Leptodira*, *Oxyrhopus*, *Erythrolamprus*, *Conopsis*, *Scotocepheus*, *Homalocranium*, *Petalognathus*, *Leptognathus*. Most of the Amphycephalidae are neotropical, the others in S.E. Asia. Of Elapinae only the genus *Elaps* occurs, but with many species. Of the Crotalinae, *Lachesis* is the essentially neotropical genus, with many species, some of which enter the hot lands of Mexico, e.g. *L. laevis* and *L. lanceolatus*, a very widely distributed species, the only pit viper which has entered the Lower Antilles.

The above survey of the world shows that but very few of the principal families of reptiles are peculiar to only one of the main "regions." The occurrence of some freak, constituting a little family or sub-family by itself in some small district, and therefore put down as peculiar to a whole wide region, cannot be much of a criterion, e.g. *Rhachiodon*, *Elachistodon*, *Acrochordinae*, *Uropletes*, *Xenosaurus*, *Heloderma*, *Anelliidae*, *Dibamus*, *Anelytrophidae*, *Platysernum*. They are not characteristic of any countries, but rather local freaks. Quite a number of very ancient families have such a wide distribution that they also are of little critical value, notably the peropodous snakes, which have survivors in almost any tropical country; such cosmopolitans are also geckos and skinks.

A difficulty which is ever present in such zoogeographical investigations is the uncertainty as to whether our zoological families and sub-families and even genera are genuine units, or heterogeneous compounds, as for instance the Anelytrophidae, of which degraded skinks there is one in Mexico, two others in W. Africa. *Heloderma* in Mexico and *Lanthanotus* in Borneo are both without much doubt descendants of some Anguid stock, but when we now combine them, in accordance with the highest view, as we do, as we thereby raise the tremendous problem of the present distribution of this

family. Boas and pythons are likewise not above suspicion, cf. some boas in Madagascar and the python *Loxocemus* in Mexico. The opisthophlyps colubrids are almost certainly not a natural group, not to speak of numerous genera of the aglyphous assembly. To avoid arguing in a circle, such doubtful units had better be avoided whilst building hypotheses.

G. Pfeffer has recently endeavoured to show by an elaborate careful paper ("Zoogeographische Beziehungen Südamerikas," *Zool. Jahrb.*, Suppl. viii., 1905), "that nearly all the principal groups of reptiles, amphibians and fishes had formerly a universal or sub-universal distribution, and that therefore it is not necessary to assume a direct land connexion of S. America with either Africa or Australia, with or without an Antarctic." Many cases of such a former universal distribution are undoubtedly true, but the question remains how the respective creatures managed to attain it.

For true characterization of large areas we must resort to the combination of some of the large wide-ranging families, and equally important is the absence of certain large groups; both to be selected from the following table.

	Antilles.	South America.	North America.	Eurasia.	Africa.	Madagascar.	Indo-Malaya.	Australia.
Chelydridae ¹	0	+	+	0	+	+	+	0
Testudinidae	0	+	+	0	+	+	+	0
Chelydridae	0	+	+	0	+	+	+	0
Pelomedusidae	0	+	+	0	+	+	+	0
Trionychidae	0	0	+	+	+	+	+	0
Chamaeleonidae	0	0	0	0	+	+	+	0
Varanidae	0	0	0	0	+	+	+	0
Agamidae	0	0	0	+	+	+	+	0
Iguanidae	+	+	+	0	+	+	+	0
Lacertidae	0	0	0	+	+	+	+	0
Zonuridae	0	0	0	0	+	+	+	0
Crocodylidae	0	0	0	0	+	+	+	0
Amphibisbaenidae	+	+	+	+	0	+	+	0
Tejidae	+	+	+	0	0	0	0	0
Pygopodidae	0	0	0	0	0	0	0	+
Viperinae	0	0	0	+	+	+	+	0
Crotalinae	0	+	+	+	+	+	+	0
Elapinae	0	+	+	+	+	+	+	+

¹ Including the related Dermatemnydidae and Cinosternidae.

² With an exception.

³ Entering, or in the borderland.

⁴ Mediterranean countries.

⁵ Rhineura; formerly wider distribution.

⁶ In Asia.

Deductions from this table show, for instance, that Australia is quite sufficiently characterized by the possession of Chelydidae and Varanidae; Madagascar by the presence of chamaeleons and Pelomedusidae. On the other hand, the separation of the whole of Africa from Asia, or the diagnosis of the palaearctic "region," would require the combination of several positive and negative characters.

Chelonians are very diagnostic, expressed by the following combinations of families:—
America as a whole: Chelydridae and Cinosternidae and Dermatemnydidae.

N. America: Chelydridae and Trionychidae, but only E. of the Rockies.

S. America: Chelydridae and Pelomedusidae.

Africa: Trionychidae and Pelomedusidae.

Madagascar: Pelomedusidae and Testudinidae.

India and Eurasia: Trionychidae and Testudinidae.

Australia: Chelydridae only.

That the Chelonians are regionally so very diagnostic that their main families are still in rational agreement with the main divisions of land, is perhaps due, first, to their being an ancient group; secondly, to their limited means of distribution (none across the seas, omitting of course Chelonidae, &c.); and lastly, to their being rather indifferent to climate. Note, for instance, *Trionyx ferox* from the Canadian lakes to the Gulf of Mexico, *Cinosternum pennsylvanicum* from New York to New Orleans. It may be taken for certain that wherever a *Testudo* occurs as a genuine native, it has got there by land, be the locality the Galapagos, Aldabra, Madagascar or some Malay islands. The Trionychidae reveal themselves as of periarctic origin, being debarred from Australia, Madagascar and the neotropical region (alleged from Eocene Patagonia). Testudinidae are cosmopolitan, excluding Australia, and practically also the Antilles; and *Testudo* is most instructive with its almost similar distribution; but something has gone wrong with this genus in America, where it flourished in mid-Tertiary times.

Pleurosa are less satisfactory than they appear to be from a methodical point of view. The Pelomedusidae, being known from European Trias and from nearctic cretaceous formations,

may have had a world-wide distribution; but Chelydidae may well have centred in an antarctic continent. Chelydridae were periarctic and have disappeared from Eurasia; N. American offshoots are the Cinosterridae and Dermatemydidae, the latter now restricted to Central American countries.

Crocodylia, probably once universal, afford through the Chinese *alligator* an instance of the original intimate connexion of the whole holarctic region, paralleled by many other animals which now happen to be restricted to E. Asia and to eastern N. America.

Lacertilia are less satisfactory for short diagnoses. America alone combines Iguanidae and Tejidae:—

N. America: Iguanidae, Anguidae, Tejidae (and Rhineura in Florida).

S. America: Iguanidae, Anguidae, Tejidae and many Amphibiaenidae.

Africa and Madagascar: Chameleons and Zonuridae and Gerrhosauridae.

Madagascar: Chameleons and Iguanidae.

India: Varanidae, Agamidae and Lacertidae, all of which also in Africa.

Australia alone has Pygopodidae.

The Lacertilia are now distributed upon principles very different from those of the tortoises. According to the lizards the world is divided into an E. and a W. half. The W. alone has Iguanidae and Tejidae, the E. alone that important combination of Varanidae and Agamidae. Further subdivision is in most cases possible only by exclusion, e.g. except in Lacertilia and chameleons from Australia of Varanidae and Agamidae from Madagascar. Lizards are rather susceptible to climatic conditions, infinitely more than water tortoises.

As regards *Ophidia*, America has Crotalinae and Elapinae, but no Viperinae. Eurasia and India alone combines Viperinae, Crotalinae and Elapinae. Africa, Viperinae and Elapinae but no Crotalinae. Australia only Elapinae. Madagascar none of these groups.

The Viperinae must have had their original centre in the palae-arctic countries, and they have been debarred only from Australia and Madagascar. Both vipers and pit vipers are still in Asia, but true vipers are absent in America, with their fullest development now in Africa, whilst pit vipers went E., covering now the whole of America, and having developed the rattlesnakes in Sonora land. The Agapinae are undoubtedly of Asiatic origin; they have overrun Africa, were too late for Madagascar, but early enough for Australia, where they are only poisonous snakes; and only one genus, *Elaps*, has got into, or rather, has differentiated in America, in the S. of which it is abundant.

Opisthogypha are useless for our purpose; they are cosmopolitan, with the exception of Australia, but probably they have one ancient centre in S. America, and another in the old world.

Amblycephalidae afford another of those curious instances of apparent affinity between S.E. Asia and Central America; paralleled by *Pelamis bicolor*, which ranges from Madagascar to Panama, while all the other Hydrophiinae belong to the Indian Ocean and the E. Asiatic seas. Aglyphous Colubridae show undoubted affinity between N. America and Eurasia; the whole group is absolutely cosmopolitan, and many of the genera, e.g. *Coluber*, *Tropidonotus* and *Coronella*, have proved their success by having acquired an enormous range. Snakes have comparatively few enemies, and they possess exceptional means of distribution. It is rare for a terrestrial species to have such a wide range as *Crotalus terrificus*, from Arizona to Argentina, or as the India cobra, which, like the tiger, is equally at home in Malay islands, Manchuria and Turkestan.

The tortoises divide the habitable world into a S. and a N. world, much as do the anurous Batrachians; the lizards split it into an E. and a W. hemisphere. The poisonous snakes, the most recent of reptiles in their full development and distribution, allow us to distinguish between Australia, America and the rest of the world.

(H. F. G.)

REPTON, a village in the S. parliamentary division of Derbyshire, England, 8 m. S.W. of Derby, on the Midland railway. Pop. (1901) 1605. It is famous for its school, founded in 1557 by Sir John Port, of the neighbouring village of Etwell, which has valuable entrance scholarships, and two leaving exhibitions to the universities annually. The number of boys is about 300. The school buildings are modern, but incorporate considerable portions of an Augustinian priory established in 1172. There was an ecclesiastical establishment on this site in the 7th century, the first bishop of Mercia being established here. This was destroyed by the Danes in 874. In the second half of the 10th century, during the reign of Edgar, another church was founded. The existing parish church of St Wystan retains pre-Conquest work in the chancel, beneath which is a remarkably fine vaulted crypt, probably dating from the reign of Edgar, its roof supported on fluted columns. The monastery was dissolved by Henry VIII.

REPUBLIC (Lat. *respublica*, a commonweal or commonwealth), a term now universally understood to mean a state, or polity, in which the head of the government is elective, and in which those things which are the interest of all are decided upon by all. This is notoriously a very modern interpretation of the term. In the ancient world of Greece and Rome the franchise was in the hands of a minority, who were surrounded by, and who governed, a majority composed of men personally free but not possessed of the franchise, and of slaves. Modern writers have often used *respublica*, and literal translation, as meaning only the state, even when the head was an absolute king, provided that he held his place according to law and ruled by law. "Republic," to quote one example only of many, was so used by Jean Bodin, whose treatise, commonly known by its Latin name *De Republica Libri Sex*, first appeared in French in 1577. Englishmen of the middle ages habitually spoke of the commonwealth of England, though they had no conception that they could be governed except by a king with hereditary right. The coins of Napoleon bear the inscription "*République française, Napoléon Empereur*." Except as an arbitrary term of art, or as a rhetorical expression, "republic" has, however, always been understood to mean a state in which the head holds his place by the choice of his subjects. Poland was a republic because its king had in earlier times to be accepted, and in later times was chosen by a democracy composed of gentry. Venice was a republic, though after the "closing of the great council" the franchise was confined to a strictly limited aristocracy, which was itself in practice dominated by a small oligarchy. The seven states which formed the confederation of the United Netherlands were republics from the time they renounced their allegiance to Philip II., though they chose to be governed by a stadtholder to whom they delegated large powers, and though the choice of the stadtholder was made by a small body of burghers who alone had the franchise. The varieties are many. What, however, is emphatically not a republic is a state in which the ruler can truly tell his subjects that the sovereignty resides in his royal person, and that he is king, or tsar, "pure and absolute," by the grace of God, even though he may hasten to add that "absolute" is not "despotic," which means government without regard to law. The case of Great Britain, where the king reigns theoretically by the grace of God, but in fact by a parliamentary title and under the Act of Settlement, is, like the whole British constitution, unique.

There is in fact a fundamental incompatibility between the conceptions of government as a commonwealth and as an institution based on a right superior to the people's will. Where the two views endeavour to live together one of two things must happen. The ruler will confiscate the rights of the community to himself and will become the embodiment of sovereignty, which is what happened in most of the states of Europe at the close of the middle ages; or the community, acting through some body politic which is its virtual representative, will confine the head of the government to defined functions.

The question of representation is dealt with separately (see REPRESENTATION), but the conception of a republic in which all males, who do not belong to an inferior and never have been accepted in the ancient or mediæval world, for it is based on a foundation of which they knew nothing, — the political rights of man. When the Scottish reformer John Knox based his claim to speak on the government of the realm on the fact that he was "a subject born within the same" he advanced a pretension very new to his generation. But it was one which was fated to achieve a great fortune. The right of the subject, simply as a member of the community, to a voice in the community in which he was born, and on which his happiness depended, implied all "the rights of man" as they were to be stated by the American Declaration of Independence, and again by the French in 1789. As they could be vindicated only by revolt against monarchical governments in the old world and the new, and as they were incompatible with all the convictions which make monarchy possible, they embodied

themselves in the modern democratic republics of Europe and America. It is a form of government not much more like the republic of antiquity and the middle ages than the French *sans-culottes* was like Harmodius and Aristogiton, whom he admired for being what they most decidedly were not—believers in equality and fraternity. But it does, subject to the imperfections of human nature, set up a government in which all, theoretically at least, have a voice in what concerns all.

REPUBLICAN PARTY. Of the three important American parties which have called themselves Republican,¹ this article deals only with that one which was organized during the years 1854 and 1856 and has been in control of the government of the United States during the larger portion of the half century since the presidential election of 1860.

Origin and Character.—Sectionalism, the movement which tended to break the Union into two separate republics, one based on free labour, the other on that of slaves, had gained before the middle of the 19th century such headway as to compel a reconstruction of the party system. The beginning of this reconstruction was heralded by the rise of the Liberty party (*q.v.*), in 1840, its completion by the disruption in 1860 of the Democratic party along sectional lines, and the election of Abraham Lincoln by a sectional vote.

The event which determined the date of the birth of the Republican party was the repeal by the Kansas-Nebraska Bill of 1854 of that provision of the Compromise of 1820 which excluded slavery from national territory N. of the geographical line 36° 30' and the formal substitution in that bill of "squatter" for national sovereignty, in deciding the question of slavery in the Territories. The enactment of this bill introduced a new and highly critical stage in the relations between North and South. Down to 1850 the differences of the two sections over slavery had always been arranged by mutual concessions. In 1854 this expedient was set aside. Without giving anything in return, Douglas and his supporters took from the free-labour section an inviolable barrier against the extension of slavery: and through the doctrine of "squatter sovereignty" denied to Congress the power to erect such barriers in the future. But this only hastened a crisis that could not have been greatly delayed. Calhoun had already discerned the true source and deadly nature of the growing sectional estrangement, and Lincoln was soon to utter the prophetic words: "This government cannot endure permanently, half slave and half free."

The immediate result of the agitation over the repeal was to convince a large number—which soon became a majority—of the best citizens of the North, irrespective of party, that the restriction of slavery was essential to the well-being both of the North and of the Union as a whole. In order to give effect to this conviction it was necessary to form a new party. The agitation which prepared the way for its rise began in Congress during the debates on the Kansas-Nebraska Bill, and spread thence throughout the North. The West was more quickly responsive than the East. But everywhere large elements of the existing parties came together and agreed to unite in resisting the extension of slavery. Before the discussion of the repeal in Congress had reached its later stages, a mass meeting of Whigs, Democrats and Free Soilers at Ripon, Wisconsin, resolved that if the Kansas-Nebraska Bill should pass: "They would throw old party organizations to the winds and organize a new party on the sole issue of the non-extension of slavery." The name Republican was formally adopted at a state convention of the new party held at Jackson, Michigan, on the 6th of July 1854, and by other Western state conventions on the 13th of the same month.

The great majority of the new party had been either Whigs or Democrats. In two cardinal points they were agreed, namely, opposition to slavery and belief in the national, as opposed to the federative, nature of the Union. In other points there was at the beginning much disagreement. For-

tunately the issues on which there was agreement overshadowed all others long enough to bring about a fusing of the two elements. It was the union of the Whig who believed in making government strong and its sphere wide, with the Democrat who believed in the people and the people's control of government, that made the Republican party both efficient and popular.

History.—Before its advent to power, from 1854 to 1860, the tasks of the Republican party were three: to propagate the doctrine of slavery restriction by Congressional action; to oppose the extension of slavery under the operation of the doctrine of squatter sovereignty; and to obtain control of the Federal government. In each it was successful. Throughout the North and under such leaders as Seward, Lincoln, Chase, Sumner, Henry Ward Beecher and Horace Greeley, all the resources of the press, the platform, the pulpit and (an institution then powerful but now forgotten) the lyceum or citizens' debating club, were fully enlisted in the propaganda. Other events that turned to the advantage of the Republicans were the brutal assault upon Charles Sumner in the Senate Chamber in 1856, the Ostend Manifesto, advising in the interest of slavery the acquisition of Cuba by force if Spain should refuse to sell, the enforcement—sometimes brutal and always hateful—of the Fugitive Slave Law (*q.v.*), and the quarrel of Douglas with the administration and the South over the application of squatter sovereignty to Kansas. On the other hand, the decision of the Supreme Court in the case of Dred Scott, which the Republicans refused to accept as good law, and the raid of John Brown at Harper's Ferry, which they condemned, brought them into serious embarrassment.

In the prosecution of the third task, the attainment of office, the party followed wise counsels and was fortunate. In its first national platform, that of 1856, the party affirmed its adherence to the principles of Washington and Jefferson, denied the constitutional right of Congress or a Territory to establish slavery, and declared that it was "both the right and duty of Congress to prohibit in the Territories those twin relics of barbarism, polygamy and slavery." At the close of the resolutions there was a demand for government aid to a Pacific railway and for the improvement of rivers and harbours.

The platform of 1860 was more comprehensive. It added to the planks of the first, an arraignment of the administration and the Dred Scott decision, and demands for a protective tariff and a homestead act. Although the popular vote for Abraham Lincoln was more than a half-million greater than that for John C. Frémont, the party's candidate in 1856, nevertheless it was the disruption of the Democratic party that made the Republican triumph possible. On the other hand, the Republican party was the strongest member of the new party system as reorganized on the sectional principle. Moreover, in character and purpose, as well as numerical strength, it was better qualified than its rivals to meet the impending crisis.

The War Period, 1861-1865.—Between the election of Mr Lincoln in November 1860, and his inauguration on the following 4th of March, seven of the slave-holding states seceded, formed a Confederacy and withdrew their representatives from the national legislature. All attempts to arrange a compromise failed. The vacillation of President Buchanan, and the position taken in his annual message that the national government had no right to coerce a seceding state, gave strong support to the disunion movement. These events forced upon the Republican party a change of policy. Hitherto its efforts had been directed chiefly to excluding slavery from the Territories. Now the first duty was to save the Union from disruption. In order to do this it was necessary to unite the North, and to bring to the support of the Union a large proportion of those border slave states, Delaware, Maryland, Virginia, Kentucky, Tennessee and Missouri, in which there was considerable Union sentiment. Hence the party laid aside completely the earlier issue of slavery restriction and accepted as the sole issue of the hour the maintenance of the Union. Indeed, in order to secure more easily the co-operation of loyal Democrats, it even gave up its own name for a time and called itself the Union party.

¹The party organized by Thomas Jefferson; the National Republicans, 1824-1834; and the Republican party of the present.

During the early period of the war the President checked all efforts on the part of zealous subordinates, civil and military, to make the war for the Union even incidentally a war upon slavery. In his efforts to unionize the border states Mr Lincoln in March 1862 urged that Congress should co-operate with any state in providing for a voluntary, gradual and compensated emancipation. Congress acceded, but not one of the border states would undertake emancipation. Many of the Republican leaders rejected the border state policy of the President and urged a more radical course towards slavery. In replying to Horace Greeley, who voiced the discontent in a public letter, to which he gave the title, *The Prayer of Twenty Millions of People*, Mr Lincoln in August 1862 wrote: "My paramount object is to save the Union and not either to save or destroy slavery."

But as evidence accumulated that slavery was a strong military support of the Confederacy the policy of destroying slavery as a means of saving the Union grew in favour. To this policy Mr Lincoln on the 22nd of September 1862 committed himself, the Republican party and the cause of the Union. The first response was distinctly unfavourable. The immediate effect was "to unite the South and divide the North." A considerable element of the Democratic party became disloyal, while the party as a whole opposed all measures looking to the destruction of slavery. The autumn elections greatly reduced the Republican majority in Congress. But the new policy steadily gained ground until the Republican party in its third national convention, which met on the 7th of June 1864, resolved: "that as slavery was the cause and now constitutes the strength of this rebellion, justice and national safety demand its utter and complete extirpation from the soil of the republic." In the following year slavery was finally abolished by the Thirteenth Amendment.

On the Republican party, since it had an effective majority in each house of Congress, rests the responsibility for the legislation of the war period. The theory of loose construction of the Constitution was accepted. Throughout the Civil War, Congress, proceeding upon this theory, made prompt provision for the prosecution of the war. It passed Legal Tender Acts; it established a system of national banks; greatly raised the tariff rates; and in order to hasten the settlement of the Far West and to make that section an integral part of the Union, it passed a Homestead Act and an act providing for a railway to the Pacific. For a time, while disloyalty was most rife in the North, there was a sharp curtailment of the rights of the individual citizen through the suspension, initiated by the President and approved by Congress, of the writ of Habeas Corpus. Most of the acts, which their opponents held to be violations of the Constitution, were in general acts of questionable utility. The results of the war, which came to a close early in 1865, vindicated in a signal way the principles, policies and leadership of the Republican party. It had saved the Union; it had established the national character of the Union so firmly as to bring to an end the doctrine of the right of secession; and it had destroyed slavery.

The party had been singularly fortunate in its founders and leaders. Of these three were pre-eminent: Horace Greeley, William H. Seward and Abraham Lincoln—Greeley in the field of journalism, Seward in the two realms of idealistic and practical politics, and, greatest of all, Abraham Lincoln who won and held the people.

Reconstruction.—The larger tasks of the period from the close of the Civil War in 1865 to the inauguration of Rutherford B. Hayes in 1877 were three: first, to accomplish with the least possible disturbance the transition from war to peace; second, to settle certain matters of dispute with France and England that had arisen during the progress of the war; and third, to reconstruct the South. Full responsibility for the way in which these tasks were discharged rests upon the Republican party, for it was in control of the presidency and the Senate throughout the period and of the House until December 1875. In the first and second it was notably successful. The soldiers of North and South returned at once to the fields of productive labour. The colossal

war establishment was quickly reduced to the requirements of peace. The French withdrew from Mexico. The Alabama Claims were submitted to arbitration. But the reconstruction of the South proved difficult in the extreme. The strain of a prolonged and exhausting war, the upheaval of emancipation, and the utter collapse of the Confederate government, had thrown the elements of social, economic and civil life in the South into almost hopeless disorder. To restore these to normal relations and working was but part of the task; the other and more important part was to apply those methods of reconstruction which would tend to make one nation out of hitherto discordant sections. In his third annual message, Dec. 8th, 1863, Lincoln brought forward the so-called presidential plan of reconstruction. This was rejected on the ground that reconstruction was a Congressional rather than an executive function; and on the 4th of July 1864 Congress passed a bill making Congress instead of the president the chief agent in the work of reconstruction. President Johnson adopted Lincoln's plan, and put it into operation with such vigour that when Congress met in December 1865 all the states that had seceded were quite or nearly ready to demand the readmission of their representatives to the House and Senate.

From the standpoint of party the situation was highly critical. The men whom the newly reconstructed states had sent to Washington represented the old South and would naturally join the opposition. Although the ratification of the Thirteenth Amendment, which abolished slavery, was assured, and a fortnight later was officially proclaimed, nevertheless the reconstructed legislatures were busy enacting police regulations which, in the opinion of most Republicans, threatened to re-enslave the freedmen. With an earnestness like that which the party in earlier days had shown in opposing the extension of slavery, it now resolved to secure full civil rights to the freedmen. Another consideration of great weight in shaping party policy was the need of maintaining the rights of Congress against executive encroachment. Owing to the war and Lincoln's masterful personality, the presidency had gained in prestige at the expense of Congress. The tendency thus established would be strengthened to a dangerous degree, it was thought, if the President were to take the leading part in reconstructing as well as in saving the Union. There now took place within the party a change of great importance. Hitherto the conservatives, represented by such leaders as Lincoln and Seward, had always won in struggles with the radical elements; but now the tide changed, and the radicals who were more narrowly national and more strongly partisan gained control, and ruled the party to the end of the period. This revolution within the Republican party between the years 1865 and 1867 was fostered by a marked recrudescence of sectional feeling in the North, and by the character of the successor of President Lincoln and of the party leaders in Congress. President Johnson while eminently patriotic and courageous, was tactless and imprudent to the last degree. Mr Sumner, the leader of the Senate, was not conciliatory in manner, and while incapable of revengeful feeling seemed more considerate of the freedman than of the Southern white. Thaddeus Stevens, whose influence over the House of Representatives was stronger than that of Sumner over the Senate, regarded the South as "a conquered province," and his personal feelings towards the ruling class of the South were harshly vindictive. The policy adopted by the Republican majority in each house of Congress was to refuse admission to the men chosen by the states that had been reconstructed under the presidential plan, until a joint-committee of both houses should investigate conditions in the South. In this rebuff there was distinct intimation of a purpose to set aside altogether the reconstructive work of the President. Congress proceeded at once to enact measures to continue and extend the earlier temporary provision for helpless freedmen whom emancipation had set adrift, and to give them full civil rights. By passing the Fourteenth Amendment in June 1866 Congress committed itself to the policy of securing the civil rights of the negro by constitutional guarantee. Each of these acts was vetoed by the President, between whom and

Congress political disagreement ripened soon into bitter enmity. As the quarrel developed Congress ignored the recommendations of the President, repassed by the requisite majority and without due consideration of his objections each measure that he vetoed, took from him the power to remove subordinates which had been exercised by his predecessors, deprived him of his constitutional rights as commander-in-chief of the army, and finally in 1868 undertook to drive him from office by impeachment.

In 1867 Congress, under the control of the radical wing of the Republican party, set aside nearly all reconstructive work that had been accomplished previously and put into execution a plan of its own, under which the Southern States were reconstructed anew and admitted to representation in Congress between the years 1867 and 1870. Inevitable consequences of the Congressional plan of reconstruction were: first, the erection of state governments that were inefficient, corrupt, ruinously wasteful and shamefully oppressive; second, the extreme demoralization of the freedmen suddenly transformed from slaves into rulers of their former masters; third, the demoralization, in many cases also extreme, of the great body of the Southern whites by the expedients to which they resorted in order to escape from the rule of the freedman, led by the "Carpet Bagger" his Northern, and the "Scalawag" his Southern, white ally; fourth, the alienation of the white and coloured races in the South,—an alienation which was to each a source of immeasurable evils; fifth, the speedy overthrow on the withdrawal of military support of the governments set up under the Congressional plan, and the creation of a South "solid" in resentful opposition to the North and the Republican party. And sixth, as the outcome of all these results, an unfortunate delay in reuniting North and South. The Republican party suffered during this period a moral decline, seen in the frequent efforts to gain party advantage by kindling anew the earlier sectional animosities, a growing arrogance, the increasing weight of the partisan and spoilsman in party management, and the widespread corruption that came to light in the "scandals" of the second administration of General Grant. The mismanaged Liberal Republican movement of 1870-1872 was a reaction against this moral decline and a protest against the Southern policy of the party and its support of the "Spoils" system. The service of the Liberal Republicans consisted mainly in the aid they gave to the reform of the Republican party and in the influence they exerted to induce the Democratic party to accept the results of the war.

But despite the warnings it received, the prestige it had gained during the war and the popularity of President Grant, the Republican party lost ground steadily during the second half of the period. In the election of 1874 the Democratic party gained control of the House of Representatives; and in the election of 1876 came within a hair's breadth of winning the presidency.

Election of Mr Hayes to that of Mr McKinley, 1876-1896.—During these twenty years the subsidence of old and the rise of new issues led to a reconstruction of the party system, which, although less radical than that of 1840 to 1860, brought into existence several new parties and changed in important respects the character and policies of those already in the field. From the standpoint of party history the chief interest of these twenty years lies in the answer to the question, How did the discredited Republican party secure in 1896 a new and prolonged lease of power? The task was not easy. The reconstruction policy of the party had alienated many Northern supporters and had made the South solidly Democratic. The prevalence of the spoils system and the scandals of the second administration of General Grant had hurt the prestige of the party as a guardian of public morals and of the national honour. What gave the Republicans a fighting chance were: its record down to the close of the Civil War; its proven aptitude for the tasks of government; and the growth among the people of a more vital national feeling which turned instinctively to the party that had saved the nation. Despite these substantial

advantages over their Democratic rivals the Republicans lost the presidential elections of 1884 and 1892, and the entire Democratic party—some Republicans agreeing—has always held that a just decision of the contested election of 1876 would have seated Samuel J. Tilden, the Democratic candidate, instead of Mr Hayes. In the Senate the Republicans were in a majority during fourteen years. In the House, whose members are chosen by popular vote, these figures were reversed, the Democrats having control during fourteen years. In each of five successive presidential elections, those of 1876, 1880, 1884, 1888 and 1892, the Democratic popular vote was larger than the Republican. Marked features of the party situation were the apparent similarity for a time of the principles of the two great parties, the influence on their policy exerted by the stronger minor parties, and the rise of the Mugwumps (not strictly a party), who claimed the right to vote for the best candidate independently of party and were in the main of Republican origin.

Of the issues of the period one, the reform of the civil service, was served by both of the great parties with imperfect fidelity. Each of the Republican presidents, Hayes, Garfield, Arthur and Harrison gave it efficient and steadfast support; and so did Cleveland, the Democratic president, although under stronger pressure from party hunger. The same was true in the case of the more important questions of foreign policy and, to a degree in its early stage, of the question of silver coinage. It was not so with the treatment of the South. President Hayes withdrew the national troops from S. Carolina and Louisiana and thus brought to an end Federal military interference with state governments. For this course a considerable section of the Republican party gave him thereafter a support which was half-hearted and inconstant. Further disaffection resulted from efforts to reform the civil service of New York which brought the President into conflict with the powerful Republican party machine in that state.¹ The high character of the President and his firm, wise and upright course raised the reputation of the party. His veto of the Silver Bill and the resumption of specie payments tended to the same result. The failure in 1889 of the third term movement for General Grant worked for the health of the party. The struggle of President Garfield with New York spoilsmen and his assassination by a disappointed office-seeker, gave a fresh impetus to the movement for the reform of the civil service. President Arthur maintained the high standard established by Presidents Hayes and Garfield.

In the election of 1884 the old parties were competitors for the confidence of the conservative and reforming elements of the country. Mr Blaine, the Republican candidate, who in brilliancy, popularity, patriotism, and disappointing personal fortunes recalled the Whig leader, Henry Clay, lost the election by a narrow margin because, while meeting the requirements of the conservatives, he had lost in a measure the confidence of the reformers.

In the election of 1888 Mr Cleveland, by making tariff reform the issue, turned the manufacturing interests to the support of Mr Harrison, the candidate of the Republicans, who thereby won the election. Mr Harrison, while not personally popular, maintained the best traditions of his Republican predecessors. The highly protective McKinley tariff, framed in obedience to the people's mandate in 1888, proved somewhat disappointing, and in the election of 1892, Mr Cleveland, as the champion of lower tariff rates, was successful for the second time. Mr Cleveland, at the beginning of his second term, secured the repeal of the act for the purchase of silver, and thus strengthened himself with the conservatives of both parties. Democratic defection in the Senate nullified largely the downward revision of the tariff urged by the President and supported by the House.

The election of 1896 marked the close of the period of party
¹ In the course of this conflict, which continued to disturb the harmony of the Republican party until the death of President Garfield, the term "Stalwarts" was used to designate the supporters of Senator Conkling, who was in control of the Republican machine in New York state, and the term "Half-Breeds" to designate the supporters of the administration.

readjustment. The leading issue was the free coinage of silver under conditions which would have made the monetary standard silver instead of gold, and would have lowered its value. The Democratic convention repudiated Mr Cleveland, accepted free coinage, and nominated W. J. Bryan. The Republicans, at the cost of a formidable party defection, endorsed the gold standard and a highly protective tariff, and nominated William McKinley, whose record and character made him an exceptionally strong candidate. In doing this the Democratic organization became the party of radicalism, the Republican, the party of conservatism. The committal of the Republican party to the maintenance of the gold standard far more than its continued support of high protection, established its position in the reconstructed party system. In doing this it allied its fortunes with those of all the property-holding classes of the country, while retaining in a high degree the confidence of the wage-earners.

Period 1897-1910.—During this period there was first a rapid recovery from economic depression, and then ten years of almost unexampled prosperity, followed by two years of moderate depression. But the period is chiefly memorable for the war of 1898 with Spain; for the oversea territorial expansion that followed; for the rise of the so-called policy of imperialism; for the assumption of a far more prominent international rôle; for wide-reaching measures of internal reform; and, lastly, for the establishment of the policy of conserving the natural resources of the nation.

Throughout this period the Republican party had undisputed control of the national government. One of the earliest acts in the administration of Mr McKinley was the enactment in 1897 of the highly protective Dingley Tariff. The provision for Reciprocity proved at first of little use. But the need of foreign markets for the rapidly growing output of manufactured products, the rising demand that the interests of the home consumer, as well as those of the producer, should be considered, and the conviction that high protection fostered monopolies, brought about a change of sentiment in the party. Mr McKinley, in his last speech, made at the Buffalo Exposition on the 5th of September 1901, gave voice to this change: "The period of exclusiveness is past. The expansion of our trade and commerce is the pressing problem. Commercial wars are unprofitable. A policy of good will and friendly trade relations will prevent reprisals. Reciprocity treaties are in harmony with the spirit of the times. Measures of retaliation are not." These views gained headway against the strenuous opposition of the "stand-patters,"¹ until revision of the tariff downward was demanded in the platform of 1908, and achieved to a moderate degree in the Tariff Act of 1909. The party has also fulfilled its promise to establish the gold monetary standard on a firm basis. During the war with Spain and in meeting the new problems of colonial empire, the Republican party has again justified its reputation for efficiency. Not less noteworthy has been the policy of the party initiated and urged by President Theodore Roosevelt and developed by President W. H. Taft for the regulation of railways and all corporations and trusts engaged in interstate business. The latest important event in the history of the Republican party is the rise of the "Insurgents," a group of senators and congressmen whose professed aims are to resist centralization in both party and national government, to lessen the influence of the money power over public policy, to regulate tariff schedules largely in the interest of the consumer, and in brief to emphasize anew the subordination of party and government to the will and service of the people.

BIBLIOGRAPHY.—See Francis Curtis, *History of the Republican Party* (2 vols., New York, 1904); J. F. Rhodes, *History of the United States from the Compromise of 1850* (*ibid.*, 1850-1902); J. W. Burgess, *The Middle Period* (New York, 1897); *The Civil War and the Constitution* (*ibid.*, 1899); and *Reconstruction and the Constitution* (*ibid.*, 1902); T. C. Smith, *The Parties and Slavery, 1851-1859* (*ibid.*, 1906); Henry Wilson, *Rise and Fall of the Slave Power in America* (3 vols., Boston, 1872-77); J. G. Blaine, *Twenty*

Years of Congress (2 vols., Norwich, Conn., 1884-1886); Horace Greeley, *The American Conflict* (2 vols., Hartford, 1864-66); J. G. Nicolay and John Hay, *Abraham Lincoln, A History* (10 vols., New York, 1890); J. T. Morse, *Life of Lincoln* (2 vols., Boston, 1893); F. Bancroft, *Life of W. H. Seward* (New York, 1900); H. E. Von Holst, *Political and Constitutional History of the United States* (Chicago, 1899); and E. Stanwood, *History of the Presidency* (Boston, 1898). (A. D. Mo.)

REQUENA, a town of E. Spain, in the province of Valencia; on the left bank of the river Magro, and on the railway from Valencia to Utiel. Pop. (1900) 16,236. The town was formerly a Moorish fortress, occupying a strong position in the mountainous region of Las Cabrillas (3400 ft.). It is dominated by the ancient citadel of the Moors, and still has traces of the original town walls. There are three ancient parish churches; San Nicolas, the oldest, dates from the 13th century, but was partly restored in 1727. Near the town are the sulphurous springs of Fuenteopodrida. The chief industries are the cultivation of grain, fruit and saffron, and the manufacture of wine and silk.

REQUESENS, LUIS DE ZUNIGA Y (? -1576), Spanish governor of the Netherlands, had the misfortune to succeed the duke of Alva (*q.v.*) and to govern amid hopeless difficulties under the direction of Philip II. His early career was that of a government official and diplomatist. In 1563 he gained the king's confidence as his representative at Rome. In 1568 he was appointed lieutenant-general to Don John of Austria during the suppression of the Morisco revolt in Granada, and he also accompanied Don John during the Lepanto campaign, his function being to watch and control his nominal commander-in-chief, whose excitable temperament was distrusted by the king. Philip must have been satisfied with Requesens, for he named him viceroy in Milan, a post usually given to a great noble. Requesens was only "a gentleman of cloak and sword" (*caballero de capa y espada*), though by the king's favour he was "grand commander" of the military order of Santiago in Castile. He was credited with having shown moderation at Milan, but it is certain that he came into sharp collision with the archbishop, Saint Charles Borromeo, who took up the cause of his flock. His docility rather than his capacity marked him out to succeed Alva. The king wished to pursue a more conciliatory policy, without, however, yielding any one of the points in dispute between himself and the revolted Netherlanders. Requesens came to Brussels on the 17th of November 1573, and till his death on the 5th of March 1576 was plunged into insuperable difficulties. With an empty treasury and unpaid mutinous troops, no faculty could have helped Requesens to succeed; and he was only an honest official who was worn out in trying to do the impossible.

AUTHORITIES.—*Documentos Inéditos para la historia de España* (Madrid, 1892); and *Nueva Colección de documentos*, vols. iv. and v. (Madrid).

REQUEST, LETTERS OF. The legal terms "letters rogatory," or "of request" (*commission rogatoire*), express a request made by one judge for the assistance of another in serving a citation, taking the deposition of a witness, executing a judgment, or the performance of any other judicial act. The later law of Rome imposed a duty of mutual assistance on the courts of the Empire, and this was extended to the courts of different states when, and so far as, Roman law came to rule the modern world. Consequently, outside ecclesiastical law (see below), the only trace of such a practice to be found in England or the United States, independent of statutory enactment, is in the admiralty doctrine that the sentence of a foreign court of admiralty may be executed on letters of request from the foreign judge or on a libel by a party for its execution. See the authorities collected by Sir R. Phillimore in *The City of Mecca*, 5 P.D. 28. The need of assistance in taking the depositions of witnesses outside their jurisdiction was long in being felt by the British and United States courts, because they issued commissions for that purpose to private persons, sometimes to foreign judges in their private capacities. But an increasing sensitiveness as to the rights of sovereignty led to

¹ Those members of the Republican party who would maintain as far as possible the high protective duties of the Dingley tariff.

objection being taken to the execution of such commissions by persons who in that employment were officers of courts foreign to the countries in which they acted, besides which those commissions could give no power to compel the attendance of witnesses abroad. Consequently both in the mother country and in the United States acts have been passed empowering the courts to issue commissions for taking evidence to colonial or foreign courts, and to execute such commissions when received by them from the courts of the colonies or of foreign countries. The British statutes are 13 Geo. III. c. 63; 1 Will. IV. c. 22; 3 & 4 Vict. c. 105, 6 & 7 Vict. c. 82, 22 Vict. c. 20 and 48 & 49 Vict. c. 74. But neither in England nor in the United States have commissions of the old kind been entirely disused. In the practice under the Anglo-American statutes, the leading rules are that all the acts of the judge whose services are required, and all things done before him, are governed by the law of the country in which the execution takes place (*locus regit actum*), while the admissibility of the evidence and all else which concerns the conduct of the action is governed by the law of the country in which it is pending (*lex fori*). Details may be seen for England and the United States in the usual books of practice, and in Wharton's *Conflict of Laws* (2nd ed., 1881), §§ 722-31, and Sir R. Phillimore's *International Law* (3rd ed., 1889), v. 4, §§ 882-885; for other countries in von Bar's *Private International Law*, translated by Guthrie (2nd ed., 1892), §§ 391, 392, 409, 410. In ecclesiastical law, letters of request are issued for the purpose of sending causes from one court to another. Where a diocesan court within a province has jurisdiction over the parties concerned, the plaintiff may apply to the judge of such court for letters of request, in order that the cause may be instituted either in the court of arches or the chancery court of York, as the case may be. When the judge of the diocesan court consents to sign such letters and they have been accepted by the judge of the higher court, a decree issues under his seal, calling upon the defendant to answer to the plaintiff in the suit instituted against him. Letters of request are also issued for other purposes, being sometimes sent from one judge to another to request him to examine witnesses who are out of the jurisdiction of the former, but in that of the latter; to enforce a monition, &c.

REQUESTS, COURT OF, a minor court of the king's council in England, under the presidency of the lord keeper of the privy seal. Its possible origin has been assigned to an order in council of 1390 directing the lords of the council to form a committee to examine the petitions of the humble people. Its jurisdiction was chiefly equitable, and owing to the small expenses of procedure it grew in popularity, especially for cases not of sufficient importance to bring into the court of chancery itself. Under Wolsey the court was fixed permanently at Whitehall. The judges of the court were styled masters of requests. In the reign of Queen Elizabeth there were two masters ordinary and two masters extraordinary. In James I.'s reign there were four masters ordinary. In Henry VIII.'s reign the judges of the court had ceased to be privy councillors, and towards the end of Elizabeth's reign the court incurred the hostility of the common law courts, as having neither a statutory nor prescriptive title to jurisdiction. Notwithstanding a decision in 1598 as to the illegality of its jurisdiction, and subsequent decisions to the same effect in the reigns of James I. and Charles I., it continued to flourish until the suppression of the Star Chamber in 1640 virtually put an end to it. Although it sat until 1642, and masters of requests were appointed even after the Restoration, it ceased to exercise judicial functions. There were also courts of requests or, as they were sometimes called, courts of conscience, established in London in the reign of Henry VIII. with jurisdiction in matters of debt under forty shillings. These courts were extended in the reigns of George I. and George II. to various places in England, but they were abolished by an act of 1846 (County Courts Act), which established in their place the tribunal of the county court (*q.v.*).

REQUIEM, the name of a solemn mass for the dead (*Missæ pro defunctis*) in the Roman Church, appointed to be sung on

All Souls' Day, in memory of all "faithful departed," at funeral services, and at the anniversaries of the death of particular persons. The name is taken from the first words of the Introit, *Requiem æternam dona eis, Domine*. The term is specially applied to the musical setting of the mass. The most celebrated Requiem Masses are those of Palestrina, Mozart and Cherubini. The word has been also used of memorial services held in honour of a deceased person in churches other than the Roman.

REREDOS (Anglo-Fr. *areredos*, from *arere*, behind, and *dos*, back), an ornamental screen of stone or wood built up, or forming a facing to the wall behind an altar in a church. Reredoses are frequently decorated with representations of the Passion, niches containing statues of saints, and the like. In England these were for the most part destroyed at the Reformation or by the Puritans later; a few medieval examples, however, survive, e.g. at Christchurch, Hants. In some large cathedrals e.g. Winchester, Durham, St Albans, the reredos is a mass of splendid tabernacle work, reaching nearly to the groining. In small churches the reredos is usually replaced by a hanging or parament behind the altar, known as a dossal or dorsal. (See also ALTAR.) For the legality of images on reredoses in the Church of England, see IMAGE.

The use of the word reredos for the iron or brick back of an open fire-place is all but obsolete.

RESCHEN SCHEIDECK. This Alpine pass is in some sort the pendant of the Brenner Pass, but leads from the upper valley of the Inn or Engadine to the upper valley of the Adige. It is but 4902 ft. in height. Near the summit is the hamlet of Reschen, while some way below is the former hospice of St Valentin auf der Haid, mentioned as early as 1140. Starting from Landeck, the carriage road runs up the Inn valley to Pfunds, whence it mounts above the gorge of Finstermünz to the village of Nauders (27½ m.) where the road from the Swiss Engadine falls in (53½ m. from St Moritz). Thence the road mounts gently to the pass, and then descends, with the infant Adige, to Mals (15½ m.), whence the pass is sometimes wrongly named Malserferde. The road now descends the upper Adige valley, or Vintschgau, past Meran (37½ m.) to Botzen (20 m. from Meran, or 100 m. from Landeck) where the Brenner route is joined. (W. A. B. C.)

RESCUE (in Middle Eng. *rescous*, from O. Fr. *recousse*, Low Lat. *recessus*, from *recessus*, *reexcute*, to shake off again, *re*, again, *ex*, off, *qualere*, to shake), the forcible setting at liberty of a person or thing. To constitute the legal offence of rescue, the person rescued must be in the custody of a constable or private individual, but in the latter case the rescuer must know that the prisoner is in lawful custody. The punishment for the offence is fine and imprisonment, with or without hard labour, if the party rescued has not been convicted of the offence for which he was in custody. But if the prisoner has been imprisoned on a charge of, or under sentence for, high treason, felony or misdemeanour, the rescue is high treason, felony or misdemeanour. The punishment for a felonious rescue may be penal servitude for not more than seven or less than three years, or imprisonment for not more than two years, with or without hard labour. The forcible rescue of goods legally distrained or the rescuing of cattle by pound breach are misdemeanours indictable at common law, but the more usual procedure is a civil action under 2 W. & M. c. 5, s. 3 (1690), which makes an offender liable for treble damages.

RESEARCH (O. Fr. *recherche*, from *rechercher*, *re-* and *cercer*, mod. *chercher*, to search; Late Lat. *circare*, to go round in a circle, to explore), the act of searching into a matter closely and carefully, inquiry directed to the discovery of truth, and in particular the trained scientific investigation of the principles and facts of any subject, based on original and first-hand study of authorities or experiment. Investigations of every kind which have been based on original sources of knowledge may be styled "research," and it may be said that without "research" no authoritative works have been written, no scientific discoveries or inventions made, no theories of any value propounded; but the word also has a somewhat restricted

meaning attached to it in current usage. It is applied more particularly to the investigations of those who devote themselves to the study of pure as opposed to applied science, to the investigation of causes rather than to practical experiment; thus while every surgeon or physician who treats an individual case of cancer may add to our sum of knowledge of the disease, the body of trained investigators which is endowed by the Cancer Research Fund are working on different lines. Again, the practical engineers who are building aeroplanes, and those who are making practical tests by actual flight in those machines, cannot be called "researchers"; that term should be confined to the members, for example, of the scientific committee appointed by the British Government in 1909 to make investigations regarding aerial construction and navigation. Further, the term is particularly used of a course of post-graduate study at a university, for which many universities have provided special Research Studentships or Fellowships. These act as endowments for a specific period, and are conditional on the holder devoting his time to the investigation at first hand of some specified subject.

RESENDE, ANDRÉ DE (1498-1573), the father of archaeology in Portugal, began life as a Dominican friar, but about 1540 passed over to the ranks of the secular clergy. He spent many years travelling in Spain, France and Belgium, where he corresponded with Erasmus and other learned men. He was also intimate with King John III. and his sons, and acted as tutor to the Infante D. Duarte. Resende enjoyed considerable fame in his lifetime, but modern writers have shown that he is neither accurate nor scrupulous. In Portuguese he wrote: (1) *Historia da antiguidade da cidade de Evora* (*ibid.* 1153); (2) *Vida do Infante D. Duarte* (Lisbon, 1789). His chief Latin work is the *De Antiquitatibus Lusitaniae* (Evora, 1593).

See the "Life" of Resende in Farinha's *Collecção das antiguidades de Evora* (1783), and a biographical-critical article by Rivara in the *Revista Literaria* (Oporto, 1839), iii. 340-62; also Cleynarts, *Latin Letters*.

RESENDE, GARCIA DE (1470-1536), Portuguese poet and editor, was born at Evora, and began to serve John II. as a page at the age of ten, becoming his private secretary in 1491. He was present at his death at Alvor on the 25th of October 1495. He continued to enjoy the same favour with King Manoel, whom he accompanied to Castile in 1498, and from whom he obtained a knighthood of the Order of Christ. In 1514 Resende went to Rome with Tristão da Cunha, as secretary and treasurer of the famous embassy sent by the king to offer the tribute of the East at the feet of Pope Leo X. In 1516 he was given the rank of a nobleman of the royal household, and became *escrivão de fazenda* to Prince John, afterwards King John III., from whom he received further pensions in 1525. Resende built a chapel in the monastery of Espinheiro near Evora, the pantheon of the Alentejo nobility, where he was buried.

He began to cultivate the making of verses in the palace of John II., and he tells us how one night when the king was in bed he caused him (Resende) to repeat some "trovas" of Jorge Manrique, saying it was as needful for a man to know them as to know the Pater Noster. Under these conditions, Resende grew up no mean poet, and moreover distinguished himself by his skill in drawing and music; while he collected into an album the best current verse of the time. The *Cancioneiro Geral*, probably begun in 1483 though not printed until 1516, includes the compositions of some three hundred *fidalgos* of the reigns of kings Alphonso V., John II. and Manoel. The main subjects of its pieces are love, satire and epigram, and most of them are written in the national redondilha verse, but the metre is irregular and the rhyming careless. The Spanish language is largely employed, because the literary progenitors of the whole collection were Juan de Mena, Jorge Manrique, Boscan and Garcilasso. As a rule the compositions were improvised at palace entertainments, at which the poets present divided into two bands, attacking and defending a given theme throughout successive evenings. At other times these poetical soirées took the form of a mock trial at law, in which the queen of John II. acted as judge.

Resende was much twitted by other rhymesters on his corpulence, but he repaid all their gibes with interest.

The artistic value of the *Cancioneiro Geral* is slight. Conventional in tone, the greater part are imitations of Spanish poets and show no trace of inspiration in their authors. The *Cancioneiro* is redeemed from complete insipidity by Resende himself, and his fine verses on the death of D. Ignez de Castro inspired the great episode in the *Lusiads* of Camoens (q.v.). Resende is the compiler of a gossiping chronicle of his patron John II., which, though plagiarized from the chronicle by Ruy de Pina (q.v.), has a value of its own. The past lives again in these pages, and though Resende's anecdotes may be unimportant in themselves, they reveal much of the inner life of the 15th century. Resende's *Miscellanea*, a rhymed commentary on the most notable events of his time, which is annexed to his *Chronicle*, is a document full of historical interest, and as a poem not without merit. The editions of his *Chronicle* are those of 1545, 1554, 1596, 1607, 1622, 1752 and 1798.

His *Cancioneiro* appeared in 1516, and was reprinted by Kausler at Stuttgart in 3 vols., 1846-52. A new edition has recently come from the university press at Coimbra. For a critical study of his work, see *Excerptos, seguidos de uma noticia sobre sua vida e obras, um juizo critico, apreciação de belezas e defeitos e estudo da lingua*, by Antonio de Castilho (Paris, 1865). Also *As sepulturas do Espinheiro*, by Anselmo Braamcamp, Freire Lisbon, 1901, *passim*, especially pp. 67-80, where the salient dates in Resende's life are set out from documents recently discovered; and Dr Sousa Viterbo, *Diccionario dos Architectos . . . Portuguezes*, ii. 361-74. (E. Pr.)

RESERVATION (Lat. *reservare*, to keep back), the act or action of keeping back or withholding something. There are some technical uses of the term. In English law "reservation" is used of the retention by the vendor or lessor, in a conveyance or lease, of some right or interest, which without such reservation would have passed to the purchaser or tenant; such "reservations" usually are concerned with rights of way or other easements or sporting rights. In ecclesiastical usage, the term is applied to the practice of preserving unconsumed a portion of the consecrated elements after the celebration of the Eucharist. For the history of this practice and its use in the Roman, Greek and English churches, see EUCHARIST, § *Reservation of the Eucharist*. In the Roman Church, where the pope retains for himself the right to nominate to certain benefices, that action is termed, technically, "reservation." When in making a statement, taking an oath, &c., a person qualifies that statement in his mind, or withholds some fact, word or expression which, if expressed, would materially alter the effect of his statement or oath, such qualification is termed a "mental reservation," or, in the technical language of casuistry, "mental restriction" (see LIGORI). The system of providing special tracts of land exclusively for the tribes of American Indians, adopted in the United States of America and in Canada, is known as the Reservation system, and such tracts are styled Indian Reservations. (See UNITED STATES AND CANADA.)

RESHT, the capital of the province of Gilan in Persia, in 37° 17' N., and 49° 36' E., on the left bank of the Siab-rud (Black river), which is a branch of the Sefid-rud (White river), and flows into the Murdab, lagoon of Enzeli. The distance from Enzeli, the port of disembarkation from Russia, on the S. shore of the Caspian, to Resht is 14 m. in a direct line, and is accomplished in an open boat, or (since 1892), depth of water permitting, in a small steamboat to Pir-i-Bazar and thence 6 m. on a good road by carriage. Resht has a population of 60,000 and is the residence of English, Russian, French and Turkish consuls and the seat of the governor-general of the province of Gilan. The town is situated in low, malarious ground, and was originally buried in jungle, but the Russians during their occupation of the place in 1723-34 cleared much timber and jungle and made some open spaces. The houses are red-tiled and raised from the ground, with broad verandahs and overhanging eaves. Conflagrations are frequent, particularly in the months of January and December, when hot, dry winds resembling the Föhn of the Alps come down from the snow-capped Elburz. A good carriage

road constructed and worked by a Russian company and opened to traffic in 1899 connects Resht with Teheran via Kazvin.

The value of trade probably exceeds £2,000,000, principal exports being rice, raw silk, dry fruit, fish, sheep and cattle, wool and cotton, and cocoons, the principal imports sugar, cotton goods, silkworm "seed" or eggs (£70,160 worth in 1906-7), petroleum, glass and china. The trade in dried silk-worm cocoons has increased remarkably since 1893, when only 76,150 lb valued at £6475 were exported; during the year 1906-7 ending 20th March, 2,717,540 lb valued at £238,000 were exported. There are telegraph and post offices and branches of the Imperial Bank of Persia and Banque d'Escompte.

ENZELI, the port of Resht in the S.E. corner of the Caspian, is 14 m. N. of Resht, in 37° 29' N., 49° 28' E. Pop. 4000. Between it and other ports in the Caspian communication is maintained by the mail-steamer from the Caucasus and Mercury Steam Navigation Company and many vessels of commercial firms with head offices chiefly at Baku. (A. H.-S.)

RESIDENCE (Latin *residere*, to remain behind, to dwell, reside), in general, a place of abode. In law, it usually means continuance in a place. The ordinary meaning of the word has been defined as "the place where an individual eats, drinks and sleeps, or where his family or his servants eat, drink and sleep" (*R. v. North Curry*, 1825, 4 B. & C. 959). For certain purposes, however, a man may be said to have his residence not only where he sleeps, but also at his place of business. See **ABODE**; **DOMICILE**. In ecclesiastical law residence is the continuance of a spiritual person upon his benefice. As a general rule, it is necessary for every rector or vicar to reside within his parish, even though there may be no house of residence annexed to the benefice. But under certain circumstances the bishop of the diocese may grant a licence of non-residence (*Pluralities Act 1838*).

RESIDENT, a political agent or officer representing the Indian government in certain native states in India. He resides in the state and advises on all matters of government, legislative or executive. Residents are divided into three classes or ranks. In certain other dependencies or protectorates of the British Empire the representative of the government is termed a resident or political agent, notably in Nepal, Aden, Sarawak, British North Borneo, &c. In general, where the state to which a resident is attached is not an independent one, he exercises consular and magisterial functions.

For "Resident" as the title of a diplomatic agent see **DIPLOMACY**.

RESIDUE (through the French, from the Lat. *residuum*, a remainder, from *residere*, to remain), in law, that which remains of a testator's estate after all debts and legacies are discharged, and funeral, administration and other expenses paid. The person to whom this residue or surplus is left is termed the residuary legatee; should none be mentioned in the will the residue goes to the next of kin (see **EXECUTORS AND ADMINISTRATORS**; **LEGACY**; **WILL**).

RESIN (through O.Fr. *resine*, modern *résine*, from Lat. *resina*, probably Latinized from Greek *ῥηίνη*, resin), a secretion formed in special resin canals or passages of plants, from many of which, such as, for example, coniferous trees, it exudes in soft tears, hardening into solid masses in the air. Otherwise it may be obtained by making incisions in the bark or wood of the secreting plant. It can also be extracted from almost all plants by treatment of the tissue with alcohol. Certain resins are obtained in a fossilized condition, amber being the most notable instance of this class; African copal and the kauri gum of New Zealand are also procured in a semi-fossil condition. The resins which are obtained as natural exudations are in general mixtures of different, peculiar acids, named the *resin acids*, which dissolve in alkalis to form resin soaps, from which the resin acids are regenerated by treatment with acids. They are closely related to the terpenes, with which they occur in plants and of which they are oxidation products. Examples of resin acids are abietic (sylvic) acid, $C_{20}H_{30}O_2$, occurring in

colophony, and pimaric acid, $C_{20}H_{30}O_2$, a constituent of gallipot resin. Abietic acid can be extracted from colophony by means of hot alcohol; it crystallizes in leaflets, and on oxidation yields trimellitic, isophthalic and terebic acid. Pimaric acid closely resembles abietic acid into which it passes when distilled in a vacuum; it has been supposed to consist of three isomers. Resins when soft are known as oleo-resins, and when containing benzoic or cinnamic acid they are called balsams. Other resinous products are in their natural condition mixed with gum or mucilaginous substances and known as gum-resins. The general conception of a resin is a noncrystalline body, insoluble in water, mostly soluble in alcohol, essential oils, ether and hot fatty oils, softening and melting under the influence of heat, not capable of sublimation, and burning with a bright but smoky flame. A typical resin is a transparent or translucent mass, with a vitreous fracture and a faintly yellow or brown colour, inodorous or having only a slight turpentine odour and taste. Many compound resins, however, from their admixture with essential oils, are possessed of distinct and characteristic odours. The hard transparent resins, such as the copals, dammars, mastic and sandarach, are principally used for varnishes and cement, while the softer odoriferous oleo-resins (frankincense, turpentine, copaiba) and gum-resins containing essential oils (ammoniacum, asafoetida, gamboge, myrrh, scammony) are more largely used for therapeutic purposes and incense. Amber (*q.v.*) is a fossil resin.

RESOLUTION, a word used in the two main senses, separation and decision, of the verb "to resolve" (Lat. *resolvere*, to loose, unfasten), to separate anything into its constituent elements or component parts, hence, through the subsidiary meaning of to clear up doubts or difficulties, to settle, determine. The principal applications of the term in its first sense are to the separation of a body into its component parts by chemical process, or, to the eye, by the lens of a microscope or telescope; similarly, in mathematics, to the analysis of a velocity, force, &c., into components. In the second sense, beyond the general meaning of determination, firmness of character, a "resolution" is specifically a decision of opinion formally submitted to a legislative or other assembly and adopted or rejected by votes.

RESORCIN (meta-dioxybenzene), $C_6H_4(OH)_2$, one of the dihydroxy phenols. It is obtained on fusing many resins (galbanum, asafoetida, &c.) with caustic potash, or by the distillation of Brazil-wood extract. It may be prepared synthetically by fusing meta-iodophenol, phenol meta-sulphonic acid, and benzene meta-disulphonic acid with potash; by the action of nitrous acid on meta-aminophenol; or by the action of 10% hydrochloric acid on meta-phenylene diamine (J. Meyer, *Ber.*, 1897, 30, p. 2569). Many ortho and para-compounds of the aromatic series (for example, the brom-phenols, benzene para-disulphonic acid) also yield resorcin on fusion with caustic potash. It crystallizes from benzene in colourless needles which melt at 119° C. and boil at 276.5° C. (L. Calderon), or 280° C. (C. Graebe), and is readily soluble in water, alcohol and ether, but insoluble in chloroform and carbon bisulphide. It reduces Fehling's solution, and ammoniacal silver solutions. It does not form a precipitate with lead acetate solution, as the isomeric pyrocatechin does. Ferric chloride colours its aqueous solution a dark violet, and bromine water precipitates tribromoresorcin. Sodium amalgam reduces it to dihydroresorcin, which when heated to 150-160° C. with concentrated baryta solution gives γ -acetylbutyric acid (D. Vorländer); when fused with caustic potash, resorcin yields phloroglucin, pyrocatechin and diresorcin. It condenses with acids or acid chlorides, in the presence of dehydrating agents, to oxyketones, e.g. with zinc chloride and glacial acetic acid at 145° C. it yields resorcinophenone $(HO)_2C_6H_2CO \cdot CH_3$ (M. Nencki and N. Sieber, *Jour. prak. Chem.*, 1881 [2], 23, p. 147). With the anhydrides of dibasic acids it yields fluorescins (*q.v.*). When heated with calcium chloride-ammonia to 200° C. it yields meta-dioxydiphenylamine (A. Seyewitz, *Bull. Soc. Chim.*, 1890 [3], 3, p. 811). With sodium nitrite it forms a water-soluble blue dye, which is turned red by acids, and is used as an indicator, under the name of *lacmoid*

(M. C. Traub and C. Hock, *Ber.*, 1884, 17, p. 2615). It condenses readily with aldehydes, yielding with formaldehyde, on the addition of a little hydrochloric acid, methylene diresorcin $[(HO)_2C_6H_3]_2CH_2$, whilst with chloral hydrate, in the presence of potassium bisulphate, it yields the lactone of tetra-oxodiphenyl methane carboxylic acid (J. T. Hewitt and F. G. Pope, *Jour. Chem. Soc.*, 1897, 73, p. 1084). In alcoholic solution it condenses with sodium acetoacetate to form β -methylumbelliferone, $C_{11}H_{10}O_3$ (A. Michael, *Jour. prak. Chem.*, 1888 [2], 37, 470). With concentrated nitric acid, in the presence of cold concentrated sulphuric acid, it yields *trinitro-resorcin* (*styphnic acid*), which forms yellow crystals, exploding violently on rapid heating.

In medicine, resorcin, which is official in the United States under the name of resorcinol, was formerly used as an antipyretic, but it has been given up. The dose is 2 to 8 grs. Used externally it is an antiseptic and disinfectant, and is used 5 to 10% in ointments in the treatment of chronic skin diseases such as psoriasis and eczema of a sub-acute character. Weak, watery solutions of resorcin (10 or 15 grs. to the ounce) are useful in allaying the itching in erythematous eczema. A 2% solution used as a spray has been used with marked effect in hay fever and in whooping-cough. In the latter disease 10 minims of the 2% solution has been given internally. It has also been employed in the treatment of gastric ulcer in doses of 2 to 4 grs. in pill, and is said to be analgesic and haemostatic in its action. In large doses it is a poison causing giddiness, deafness, salivation, sweating and convulsions. It is also worked up in certain medicated soaps. Mono-acetyl resorcin, $C_6H_4(OH)O-COCH_3$, is used under the name of "euresol."

Resaurin, $C_{12}H_7NO_4$, obtained by the action of nitrous acid on resorcin (P. Weselsky and R. Benedikt, *Monats.*, 1880, 1, p. 889), forms small dark red crystals possessing a greenish metallic gloss. When dissolved in concentrated sulphuric acid and warmed to $210^\circ C$, the solution on pouring into water yields a precipitate of *resorufin*, $C_{12}H_7NO_4$, an oxypheoxazine, which is insoluble in water, but is readily soluble in hot concentrated hydrochloric acid, and in solutions of caustic alkalis. The alkaline solutions are of a rose-red colour and show a cinnabar-red fluorescence. A tetrabromoresorufin is used as a dye-stuff under the name of *Fluorescent Resorcin Blue*.

Thioresorcin is obtained by the action of zinc and hydrochloric acid on the chloride of benzene meta-disulphonic acid. It melts at $27^\circ C$. and boils at $243^\circ C$. *Resorcin disulphonic Acid* $(HO)_2C_6H_3(HSO_3)_2$, is a deliquescent mass obtained by the action of sulphuric acid on resorcin (H. Fischer, *Monats.*, 1881, 2, p. 321). It is easily soluble in water and decomposes when heated to $100^\circ C$.

RESPIRATORY SYSTEM. (1). **ANATOMY**—The respiratory tract consists of the nasal cavities, the pharynx, the larynx, the trachea, the bronchi and the lungs, but of these the two first parts have been treated in separate articles (see **OLFACTORY SYSTEM** and **PHARYNX**).

The *larynx* is the upper part of the air tube which is specially modified for the production of notes of varying pitch, though it is not responsible for the whole of the voice. Its framework is made up of several cartilages which are moved on one another by muscles, and it is lined internally by mucous membrane which is continuous above with that of the pharynx and below with that of the trachea or windpipe. The larynx is situated in the front of the neck and corresponds to the fourth, fifth and sixth cervical vertebrae. For its superficial anatomy see **ANATOMY, Superficial and Artistic**.

The *thyroid cartilage* (see fig. 1) is the largest, and consists of two plates or *alae* which are joined in the mid-ventral line. At the upper part of their junction is the *thyroid notch* and just below that is a forward projection, the *pomum Adami*, best marked in adult males. From the upper part of the posterior border of each ala the *superior cornu* rises up to be joined to the tip of the great cornu of the hyoid bone by the *lateral thyro-hyoid ligament*, while from the lower part of the same border the *inferior cornu* passes down to be fastened to the cricoid cartilage by the *crico-thyroid capsule*. From the upper

border of each ala the *thyro-hyoid membrane* runs up to the hyoid bone, while near the back of the outer surface of each the *oblique line of the thyroid cartilage* runs downward and forward.

The *cricoid cartilage* (see figs. 1 and 2) is something like a signet ring with the seal behind; its lower border, however, is horizontal. To the mid-ventral part of its upper border is attached the mesial part of the *crico - thyroid membrane*, which attaches it to the lower border of the thyroid cartilage though the lateral parts of this membrane pass up internally to the thyroid cartilage and their upper free edges form the *true vocal cords*. On the summit of the signet part of the cricoid are placed the two *arytenoid cartilages* (see fig. 2), each of which

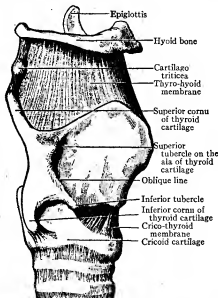

After D. J. Cunningham, from Cunningham's *Text-Book of Anatomy*.

FIG. 1.—Profile View of the Cartilages and Ligaments of the Larynx.

the two *arytenoid cartilages* (see fig. 2), each of which

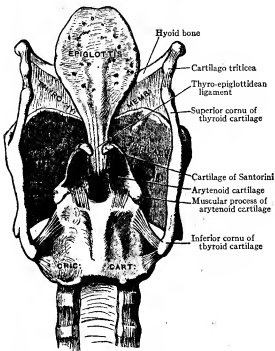

After D. J. Cunningham, from Cunningham's *Text-book of Anatomy*.

FIG. 2.—Cartilages and Ligaments of Larynx, as seen from behind.

forms a pyramid with its apex upward and with an anterior posterior and internal or mesial surface. The base articulates with the cricoid by a concave facet, surrounded by the *crico-arytenoid capsule*, and the two arytenoids are able to glide toward or away from one another, in addition to which each can rotate round a vertical axis. From the front of the base a delicate process projects which, as it is attached to the true vocal cord, is called the *vocal process*, while from the outer part of the base another stouter process

attaches the two crico-arytenoid muscles and so is known as the *muscular process*. Above each arytenoid are two smaller cartilages known as the *cornicula laryngis* or *cartilages of Santorini* and the *cuneiform cartilages*, but they are not of any practical importance.

The *epiglottis* (see fig. 3), on the other hand, is a very important structure, since it forms a lid to the larynx in swallowing; only

the box moves up to the lid instead of the lid moving down to the box. It is leaf-shaped, the stalk (*thyro-epiglottidean ligament*) being attached to the junction of the thyroid cartilages inside the larynx, while the anterior surface of the leaf is closely attached to the root of the tongue and body of the hyoid bone. The posterior or laryngeal surface is pitted for glands, and near the point where the stalk joins the leaf is a convexity which is known as the *cushion of the epiglottis*. All the cartilages of the larynx are of the hyaline variety except the epiglottis, the cornicula laryngis and the cuneiform cartilages, which are yellow elastic. The

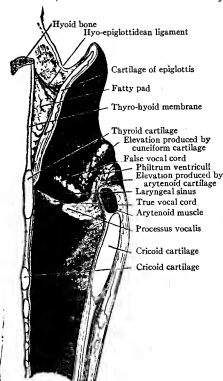

After D. J. Cunningham, from Cunningham's *Text-Book of Anatomy*.

FIG. 3.—Mesial Section through Larynx to show the outer wall of the right half.

result is that all except these three tend to ossify as middle age is approached.

The *muscles of the larynx* are: (1) the *crico-thyroids*, which are attached to the lower border of the thyroid and the anterior part of the cricoid, by pulling up which they make the upper part of the signet, with the arytenoids attached to it, move back and so tighten the vocal cords. (2) The *thyro-arytenoids* (see fig. 4), which run back from the junction of the thyroid ala to the front of the arytenoids and side of the epiglottis; they pull the arytenoids toward the thyroid and so relax the cords. (3) The single *arytenoides* muscle, which runs from the back of one arytenoid to the other and approximates these cartilages. (4) The *lateral crico-arytenoids* (see fig. 4) which draw the muscular processes of the arytenoids forward toward the ring of the cricoid and, by so doing, twist the vocal processes, with the cords attached, inward toward one another; and (5) the *posterior crico-arytenoids* (see fig. 4) which run from the back of the signet part of the cricoid to the back of the muscular processes of the arytenoid and, by pulling these backward, twist the vocal processes outward and so separate the vocal cords. All these muscles are supplied by the recurrent laryngeal nerve, except the crico-thyroid which is innervated by the external branch of the superior laryngeal (see NERVES, *Cranial*).

The *mucous membrane of the larynx* is continuous with that of the pharynx at the *aryteno-epiglottidean folds* which run from the sides of the epiglottis to the top of the arytenoid cartilages (see fig. 3). To the outer side of each fold is the *sinus pyriformis* (see PHARYNX). From the middle of the junction of the ala of the thyroid cartilage to the vocal processes of the arytenoids the mucous membrane is reflected over, and closely bound to, the true vocal cords which contain elastic tissue and, as has

been mentioned, are the upper free edges of the lateral parts of the crico-thyroid membrane. The chink between the two

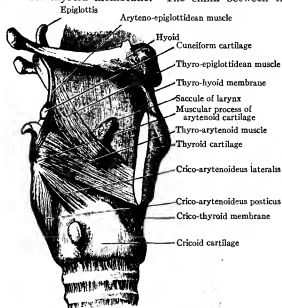

After D. J. Cunningham, from Cunningham's *Text-Book of Anatomy*.

FIG. 4.—Dissection of the Muscles in the Lateral Wall of the Larynx. The right ala of the thyroid cartilage has been removed.

true vocal cords is the *glottis* or *rima glottidis*. Just above the true vocal cords is the opening into a recess on each side which runs upward and backward and is known as the *laryngeal sacculus*; its opening is the *laryngeal sinus*. The upper lip of this slit-like opening is called the *false vocal cord*.

The mucous membrane is closely bound down to the epiglottis and to the true vocal cords, elsewhere there is plenty of sub-mucous tissue in which the products of inflammation may collect and cause "oedema laryngis," a condition which is mechanically prevented from passing the true vocal cords. In the upper part of the front and sides of the larynx and over the true vocal cords the mucous membrane is lined by squamous epithelium, but elsewhere the epithelium is of the columnar ciliated variety: it is supplied by the superior laryngeal branch of the vagus nerve and above the glottis is peculiarly sensitive.

The *Trachea* or windpipe (see fig. 5) is the tube which carries the air between the larynx and the bronchi; it is from four to four and a half inches long and lies partly in the neck and partly in the thorax. It begins where the larynx ends at the lower border of the sixth cervical, and divides into its two bronchi opposite the fifth thoracic vertebra. The tube is kept always open by rings of cartilage, which, however, are wanting behind, and, as it passes down, it comes to lie farther and farther from the ventral surface of the body, following the concavity of the thoracic region of the spinal column. In the whole of its downward course it has the oesophagus close behind it, while in front are the isthmus of the thyroid, the left innominate vein, the innominate artery and the arch of the aorta. On each side of it and touching it is the vagus nerve.

The cervical part of the tube is not much more than an inch in length, but it can be lengthened by throwing back the head. This, of course, is the region in which tracheotomy is performed, and it should be remembered that in children, and sometimes in adults, the great left innominate vein lies above the level of the top of the sternum.

In transverse section the trachea is rather wider from side to side than from before backward. In life the former measurement is said to be about 12.5 mm. and the latter 11 mm. It is made up of an external fibro-elastic membrane in which the cartilaginous rings lie, while behind, where these rings are wanting, is a layer of unstripped muscle which, when it contracts,

draws the hind ends of the rings together and so diminishes the calibre of the tube. Inside these is plentiful submucous tissue

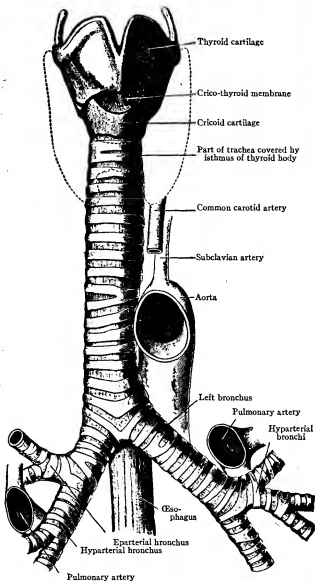

After D. J. Cunningham, from Cunningham's *Text-Book of Anatomy*.

FIG. 5.—The Trachea and Bronchi: The thyroid body is indicated by a dotted line.

containing mucous glands and quantities of lymphoid tissue, while the whole is lined internally by columnar ciliated epithelium.

The *Bronchi* (see fig. 5) are the two tubes into which the trachea divides, but, since the branches, which these tubes give off later, are also called bronchi, it may be clearer to speak of primary, secondary and tertiary bronchi. Each primary bronchus runs downward and outward, but the right one is more in a line with the direction of the trachea than the left. The right primary bronchus has also a greater calibre than the left because the right lung is the larger, and for these two reasons when a foreign body enters the trachea it usually enters the right bronchus.

The first secondary bronchus comes off about an inch from the bifurcation of the trachea on the right side and, as it lies above the level of the pulmonary artery, it is known as the *eparterial bronchus*. On the left side the first branch is about two inches from the bifurcation and, like all the remaining secondary bronchi, is *hyarterial*: the left primary bronchus is therefore twice as long as the right. After the eparterial secondary bronchus is given off the direction of the right primary bronchus is carried on by the *hyarterial* secondary bronchus,

and this, just before reaching the hilum of the lung, divides into upper and lower tertiary bronchi, while the left lower secondary *hyarterial* bronchus does not divide before reaching the hilum of its lung. Into the hilum or root of the right lung, therefore, three bronchial tubes enter, while on the left side there are only two. The firmly rooted habit of associating the term bronchi with those parts of the main tubes which lie between the bifurcation of the trachea and the point where the first branch comes off makes it very difficult to suggest a nomenclature which calls up any picture of the actual state of things to the mind. Certainly the classification into primary, secondary and tertiary bronchi only goes a very little way toward this, and it should be realized that, call them what we may, there are two long tapering tubes which run from the bifurcation of the trachea to the lower and back part of each lung, and give off a series of large ventral and small dorsal branches. The upper part of each of these long tubes or *stem bronchi* is outside the lung and in the middle mediastinum of the thorax, the lower part embedded in the substance of the lung. The structure of the bronchi is practically identical with that of the trachea. (See G. S. Huntington's "Eparterial Bronchial System of the Mammalia," *Am. Journ. Med. Sci.* (Phila. 1898). See also Quain's *Anatomy*, London, last edition.)

The *Lungs* are two pyramidal, spongy, slate-coloured, very vascular organs in which the blood is oxygenated. Each lies in its own side of the thorax and is surrounded by its own pleural cavity (see COELOM and SEROUS MEMBRANES), and has an *apex* which projects into the side of the root of the neck, a *base* which is hollowed for the convexity of the diaphragm, an outer surface which is convex and lies against the ribs, an inner surface concave for the heart, pericardium and great vessels, a sharp anterior border which overlaps the pericardium and a broad, rounded posterior border which lies at the side of the spinal column. Each lung is nearly divided into two by a *primary fissure* which runs obliquely downward and forward, while the right lung has a *secondary fissure* which runs horizontally forward from near the middle of the primary fissure. The left lung has therefore an *upper* and *lower* or *basal lobe*, while the right has *upper*, *middle* and *lower lobes*. On the inner surface of each lung is the *root* or *hilum* at which alone its vessels, nerves and ducts (bronchi) can enter and leave it. The structures contained in the root of each lung are the branches and tributaries of (1) the *pulmonary artery*, (2) the *pulmonary veins*, (3) the *bronchi*, (4) the *bronchial arteries*, (5) the *bronchial veins*, (6) the *bronchial lymphatic vessels and glands*, (7) the *pulmonary plexuses of nerves*. Of these the first three are the largest and, in dividing the root from in front, the veins are first cut, then the arteries and last the bronchi. As has been pointed out already, the eparterial bronchus on the right side is above the level of the artery, but all the others (*hyarterial*) are on a lower level.

The *bronchial arteries* supply the substance of the lung; there are usually two on each side, and they lie behind the bronchi. The blood which they carry is chiefly returned by the pulmonary veins bringing oxidized blood back to the heart, so that here there is a normal and harmless mixture of arterial and venous blood. If there are any *bronchial veins* (their presence is doubted by some, and the writer has himself carefully but unsuccessfully searched for them several times), they open into the azygos veins of their own side. The *bronchial lymphatic vessels* lie behind the pulmonary vessels and open into several large glands which are black from straining off the carbon left in the lungs from the atmosphere.

There is an *anterior* and *posterior pulmonary plexus of nerves* on each side, the fibres of which are derived from the vagus and the upper thoracic ganglia of the sympathetic.

Structure of the Lungs.—As the bronchi become smaller and smaller by repeated division, the cartilage completely surrounds them and tends to form irregular plates instead of rings—they are therefore cylindrical, but when the terminal branches (*lobular bronchi*) are reached, the cartilage disappears and hemispherical bulgings called *alveoli* occur (fig. 6 A). At the very end of

each lobular bronchus is an irregular chamber, the *atrium* (fig. 6 At), and from this a number of thin-walled sacs, about

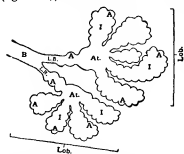

FIG. 6.—Diagram of Two Lobules of the Lung. B. Bronchus. A. Alveolus. I. Infundibulum. L.B. Lobular Bronchus. At. Atrium. Lob. Lobule.

1 mm. in diameter, open out. These are called the *infundibula* (fig. 6 I), and their walls are pouched by hemispherical air-cells or alveoli like those in the lobular bronchi. Each lobular bronchus with its atrium and infundibula forms what is known as a *lobule* of the lung, and these lobules are separated by connective tissue, and their outlines are evident on the surface of the lung.

The muscular tissue, which in the larger tubes was confined to the dorsal part, forms a complete layer in the smaller; but when the lobular bronchi are reached, it stops and the mucous membrane is surrounded by the elastic layer. In the lobular bronchi, too, the lining epithelium gradually changes from the ciliated to the stratified or pavement variety, and this is the only kind which is found in the infundibula and alveoli. Surrounding each alveolus is a plexus of capillary vessels so rich that the spaces between the capillaries are no wider than the capillaries themselves, and it is here that the exchange of gases takes place between the air and the blood.

Embryology.—The respiratory system is developed from the ventral surface of the foregut as a long gutter-like pouch which reaches from just behind the rudiment of the tongue to the stomach. Limiting the anterior or cephalic end of this is a Π -shaped elevation in the ventral wall of the pharynx which separates the ventral ends of the third and fourth visceral bars and is known as the *furcula*; it is from this that the epiglottis, aryteno-epiglottidean folds and arytenoid cartilages are developed. Later on the respiratory tube is separated from the digestive by two ridges, one on each side, which, uniting, form a transverse partition. In the region of the furcula, however, the partition stops and here the two tubes communicate. The caudal end of the respiratory tube buds out into the two primary bronchi, and the right one of these, later on, bears three buds, while the left has only two; these are the secondary bronchi, which keep on dividing into two, one branch keeping the line of the parent stem to form the stem bronchus, while the other goes off at an angle. By the repeated divisions of these tubes the complex "bronchial tree" is formed and from the terminal shoots the infundibula bud out. The alveoli only develop in the last three months of foetal life. The thyroid cartilage is probably formed from the fourth and fifth branchial bars, while the cricoid seems to be the enlarged first ring of the trachea. Before birth the lungs are solid and much less vascular than after breathing is established. Their slaty colour is gradually gained from the deposit of carbon from the atmosphere. (For further details see Quain's *Anatomy*, vol. i., Lond. 1908.)

Comparative Anatomy.—It has been shown (see PHARYNX) that in the lower vertebrates respiration is brought about by the blood vessels surrounding the gill clefts. In the higher fishes (Ganooids and Teleosts) the "*swim bladder*" appears as a diverticulum from the dorsal wall of the alimentary canal, and its duct (*d. pneumaticus*) sometimes remains open and at others becomes a solid cord. In the former case it is probable that the blood is to some extent oxidized in the vascular wall of this bladder. In the Dipnoi (mud-fish) the opening of the swim bladder shifts to the ventral side of the pharynx and the bladder walls become sacculated and very vascular, so that, when the rivers are dried up, the fish can breathe altogether by means of it. In the S. American and African species of mud-fish the bladder or lung, as it may now be called, is divided by a longitudinal septum in its posterior (caudal) part into right and left halves. In this sub-class of Dipnoi, therefore, a general

agreement is seen with the embryology or ontogeny of Man's lung. In the Amphibia the two lungs are quite separate though they are mere sacculated bags without bronchi. A trachea, however, appears in some species (e.g. Siren) and a definite larynx with arytenoid cartilages, vocal cords and complicated muscles is established in the Anura (frogs and toads). In most of the Reptilia the bag-like lungs are elaborated into spongy organs with arborizing bronchi in their interior. From the crocodiles upward a main or stem bronchus passes to the caudal end of the lung, and from this the branches or lateral bronchi come off. The larynx shows little advance on that of the Anura.

The respiratory organs of birds are highly specialized. The larynx is rudimentary, and sound is produced by the *syrrinx*, a secondary larynx at the bifurcation of the trachea; this may be tracheal, bronchial or, most often, tracheo-bronchial. The lungs are small and closely connected with the ribs, while from them numerous large air sacs extend among the viscera, muscles and into many of the bones, which, by being filled with hot air, help to maintain the high temperature and lessen the specific gravity of the body. This pneumaticity of the bones is to a certain extent reproduced by the air sinuses of the skull in crocodiles and mammals, and it must be pointed out that the amount of air in the bones does not necessarily correspond with the power of flight, for the Ratitae (ostriches and emus) have very pneumatic bones, while in the sea-gulls they are hardly pneumatic at all.

In mammals the thyroid cartilage becomes an important element in the larynx, and in the Echidna the upper and lower parts of it, derived respectively from the fourth and fifth branchial bars, are separate (R. H. Burne, *Journ. Anat. and Phys.* xxxviii. p. xxvii.). The whole larynx is much nearer the head than in Man, and in young animals the epiglottis is intra-narial, i.e. projects up behind the soft palate. This prevents the milk trickling into the larynx during suckling, and is especially well seen in the Marsupials and Cetacea, though evidences of it are present in the human embryo. In the lower mammals an inter-arytenoid cartilage is very frequent (see J. Symington, "The Marsupial Larynx," *J. Anat. and Phys.* xxxiii. 31, also "The Monotreme Larynx," *ib.* xxxiv. 90).

The lungs show a good deal of variation in their lobulation; among the porcupines as many as forty lobes have been counted in the right lung, while in other mammals no lobulation at all could be made out. The *azygous lobe* of the right lung is a fairly constant structure and is situated between the post-caval vein and the oesophagus. It is supplied by the terminal branch of the right stem bronchus and, although it is usually absent in Man, the bronchus which should have supplied it is always to be found. (F. G. P.)

(2) PHYSIOLOGY

So far as is known, the intake of oxygen, either free or combined, and the output of carbon dioxide, are an essential part of the life of all organisms. The two processes are so closely associated with one another that they are always included together under the designation of respiration, which may thus be defined as the physiological process which is concerned in the intake of oxygen and output of carbon dioxide. According to the evidence at present available, it is only within living cells that the respiratory oxygen is consumed and the carbon dioxide formed. The mere conveying of oxygen from the surrounding air or water to these cells, and of carbon dioxide from them to the air or water, is, however, in itself a complex process in the higher animals; and accordingly an account of animal respiration naturally falls into two divisions, the first of which (I.) is concerned with the manner in which oxygen and carbon dioxide are conveyed to and from the living tissues, and the second (II.) with the consumption of oxygen and formation of carbon dioxide by the living tissues themselves.

I. In all the more highly organized animals there are special respiratory organs: the lungs in the higher vertebrates; the gills in fishes; the tracheae in insects; and various rudimentary forms of lungs or gills in other higher invertebrates. In the

present article attention will be specially confined to the case of the higher vertebrates, and in particular to man.

Air is brought into the lungs by the movements of breathing (see above, *Movements of Respiration*). Oxygen from this air passes through the delicate lining membrane of the air-cells of the lungs into the blood, where it enters into loose chemical combination with the haemoglobin of the red corpuscles (see BLOOD). In this form it is conveyed onwards to the heart, and thence through the arteries to the capillaries, where it again parts from the haemoglobin, and passes through the capillary walls to the tissues, where it is consumed. Carbon dioxide passes out from the tissues into the blood in a corresponding manner, enters into loose combination as bicarbonate, and possibly in other ways, in the blood, and is conveyed by the veins to the lungs, whence it passes out in the expired air. Pure atmospheric air contains 20.93% of oxygen, .03% of carbon dioxide and 79.04% of nitrogen (with which is mixed about 0.9% of argon). The dried expired air in man contains about 3.5% of carbon dioxide and 17% of oxygen, so that roughly speaking the carbon dioxide is increased by about 3.5% and the oxygen diminished by 4%. Expired air as it leaves the body contains about 6% of moisture, compared with usually about 1% in the inspired air. The added moisture and higher temperature of expired air make it decidedly lighter than pure air.

Owing to the unpleasant effects often produced in badly ventilated rooms it was for long supposed that some poisonous volatile "organic matter" is also given off in the breath. Careful investigation has shown that this is not the case. The unpleasant effects are partly due to heat and moisture, and partly to odours which are usually not of respiratory origin. The carbon dioxide present in the air of even very badly ventilated rooms is present in far too small proportions to have any sensible effect.

The average volume of air inspired per minute by healthy adult men during rest is about 7 litres or .25 cub. ft. In different individuals the frequency of breathing varies considerably—from about 7 to 25 per minute, the depth of each breath varying about inversely as the frequency. During muscular work the volume of air breathed may be six or eight times as much as during rest. The volume of carbon dioxide given off varies from about half a cubic foot per hour during complete rest to 5 cub. ft. during severe exertion, but averages about 0.9 cub. ft. per hour, and will reach or exceed 1 cub. ft. per hour during even very light exertion. The volume of oxygen consumed is about a seventh greater than that of the carbon dioxide given off.

The breathing is regulated, from a nervous centre situated in the medulla oblongata, which is the lowest part of the brain. If this centre is destroyed or injured the breathing stops and death rapidly results. From the respiratory centre rhythmic efferent impulses proceed down the motor nerves supplying the diaphragm, intercostals and other respiratory muscles. Afferent impulses through various nerves may temporarily affect the rhythm of the respiratory centre. Of these afferent impulses by far the most important are those which proceed up the vagus nerve from the lungs themselves. On distention of the lungs with air the inspiratory impulses from the respiratory centre are suddenly arrested or "inhibited"; on the other hand, collapse of the lung strongly excites to inspiratory effort. On section of the vagus nerve these effects disappear, and the breathing becomes less frequent and much more laboured. The vagus nerve is thus the carrier of both inhibitory and exciting stimuli.

As the physiological function of breathing is to bring oxygen to and remove carbon dioxide from the blood, it would naturally be expected that breathing would be regulated in accordance with the amount of oxygen required and of carbon dioxide formed; but until quite recently the actual mode of regulation was by no means clear. It was commonly supposed that afferent nervous impulses in some way regulated the otherwise automatic action of the centre, want of oxygen or excess of

CO₂ in the blood being only an occasional and relatively unimportant factor in the regulations. The phenomenon of "apnoea" or complete cessation of natural breathing which occurs after forced breathing, was attributed mainly to the already mentioned distension effect through the vagus nerves. To go further back still, it was even supposed that the rate and depth of breathing, and the percentage of oxygen in the inspired air, determine the consumption of oxygen and formation of carbon dioxide in the body, just as the air-supply to a fire determines the rate of its combustion. This old belief is still often met with—for instance, in the reasons given for recommending "breathing exercises" as a part of physical training.

It is evident that if the breathing did not increase correspondingly with the greatly increased consumption of oxygen and formation of CO₂ which occurs, for instance during muscular work, the percentage of oxygen in the air contained in the lung cells or alveoli (alveolar air) would rapidly fall, and the percentage of carbon dioxide increase. The inevitable result would be a very imperfect aeration of the blood. Investigation of the alveolar air has furnished the key to the actual regulation of breathing. Samples of this air can be obtained by making a sudden and deep expiration through a piece of long tube, and at once collecting some of the air contained in the part of this tube nearest the mouth. By this means it has been found that during normal breathing at ordinary atmospheric pressure the percentage of carbon dioxide (about 5.6% on an average for men) is constant for each individual, though different persons vary slightly as regards their normal percentage. The breathing is thus so regulated as to keep the percentage of carbon dioxide constant; and under normal conditions this regulation is surprisingly exact. The ordinary expired air is a mixture of alveolar air and air from the "dead space" in the air passages. The deeper the breathing happens to be, the more alveolar air there will be in the expired air, and the higher, therefore, the percentage of carbon dioxide in it, so that the expired air is not constant in composition, though the alveolar air is. If air containing 2 or 3% of carbon dioxide is breathed, the breathing at once becomes deeper, in such a way as to prevent anything but a very slight rise in the alveolar carbon dioxide percentage. The difference is scarcely appreciable subjectively, except during muscular exertion. The effect of 1% of carbon dioxide in the inspired air is so slight as to be negligible, and there is no foundation for the popular belief that even very small percentages of carbon dioxide are injurious. With 4 or 5% or more of carbon dioxide, however, much panting is produced, and the alveolar carbon dioxide percentage begins to rise appreciably, since compensation is no longer possible. As a consequence, headache and other symptoms are produced. If, on the other hand, the percentage of carbon dioxide in the alveolar air is abnormally reduced by forced breathing, the condition of apnoea is produced and lasts until the percentage again rises to normal, but no longer. Forced breathing with air containing more than about 4% of carbon dioxide causes no apnoea, as the alveolar carbon dioxide does not fall.

If oxygen is breathed instead of air there is no appreciable change in the percentage of carbon dioxide in the alveolar air, and no tendency towards apnoea. Want of oxygen is thus not a factor in the regulation of normal breathing. During muscular work the depth and frequency of breathing increase in such a way as to prevent the alveolar carbon dioxide from rising more than very slightly. It is still the carbon dioxide stimulus that regulates the breathing, although with excessive muscular work other accessory factors may come in to some extent.

Under increased barometric pressure the percentage of carbon dioxide in the alveolar air no longer remains constant; it diminishes in proportion to the increase of pressure. For instance, at a pressure of 2 atmospheres it is reduced to half, and at 6 atmospheres to a sixth; while at less than normal atmospheric pressure it rises correspondingly unless symptoms of want of oxygen begin to interfere with this rise. These results show that it is not the mere percentage, but the pressure (or "partial pressure") of carbon dioxide in the

alveolar air that regulates breathing. The pressure exercised by the carbon dioxide in the alveolar air is of course proportional to its percentage, multiplied by the total atmospheric pressure. It follows from this law that at a pressure of 6 atmospheres 1% of carbon dioxide in the inspired air would have the same violent effect as 6% at the normal pressure of 1 atmosphere. To take a concrete practical application, if a diver whose head was just below water were supplied with sufficient air to keep the carbon dioxide percentage in the air of his helmet down to 3% at most, he would be quite comfortable. But if, with the same air supply as measured at surface, he went down to a depth of 170 ft., where the pressure is 6 atmospheres, he would at once experience great distress culminating in loss of consciousness, owing, not to the pressure of the water, which has trifling effects, but to the pressure of carbon dioxide in the air he was breathing. The air supply must be increased in proportion to the increase of pressure if these effects are to be avoided, and ignorance of this has led to the common failure of diving work at considerable depths.

The foregoing facts enable us to understand the regulation of breathing under normal conditions. The pressure of carbon dioxide in the alveolar air evidently determines that of the carbon dioxide in the arterial blood, and the latter in its turn determines the carbon dioxide pressure in the respiratory centre, which is very richly supplied with blood. The centre itself is extremely sensitive to the slightest increase or diminution in carbon dioxide pressure; and thus it is that the alveolar carbon dioxide pressure is so important. That the stimulus of carbon dioxide is from the blood and not through nerves is proved by many experiments. The function of the vagus nerves in regulating the breathing is apparently to, as it were, guide the centre in the expenditure of each separate inspiratory or expiratory effort; for as soon as inspiration or expiration is completed the inspiratory or expiratory effort is cut short by impulse proceeding up the vagus nerve, and much waste of muscular work and risk of injury to the lungs is thereby prevented.

Under ordinary conditions the regulation of carbon dioxide pressure in the alveolar air ensures at the same time a normal pressure of oxygen, since absorption of oxygen and giving off of carbon dioxide normally run parallel to one another. If, however, air containing abnormally little oxygen is breathed, the normal relation between oxygen and carbon dioxide in the alveolar air is disturbed. A similar state of affairs is brought about by any considerable diminution of atmospheric pressure. Not only does the partial pressure of oxygen in the inspired air fall, but this fall is proportionally much greater in the alveolar air; and the effects of want of oxygen depend on its partial pressure in the alveolar air. It has been known for long that any great deficiency in the proportion of oxygen in the air breathed increases the depth and frequency of the breathing; but this effect is not apparent until the percentage of oxygen or the barometric pressure is reduced by more than a third, which corresponds to a reduction of more than half in the alveolar oxygen pressure. In contrast with this an increase of a fiftieth in the alveolar carbon dioxide pressure has a marked effect on the breathing. Along with the increased breathing caused by deficiency of oxygen there is more or less blueness of the skin and abnormal effects of various kinds, such as partial loss of sensibility, memory and power of thinking. Long exposure often causes headache, nausea, sleeplessness, &c.—a train of symptoms known to mountaineers as "mountain sickness." That the primary cause of "mountain sickness" is lack of oxygen owing to the low atmospheric pressure there is not the slightest doubt. Lack of oxygen is thus not only an important, but also an abnormal form of stimulus to the respiratory centre, since it is accompanied by quite abnormal symptoms. A further analysis of the special effect of lack of oxygen on the respiratory centre has shown that this effect still depends on the partial pressure of carbon dioxide in the alveolar air. The lack of oxygen appears, in fact, to have simply increased the sensitiveness of the centre to carbon dioxide, so that a lower partial pressure of carbon dioxide

excites the centre, and the breathing is correspondingly increased. By prolonged forced breathing so much carbon dioxide is washed out of the body that the subsequent apnoea lasts until the oxygen in the alveolar air is nearly exhausted. The subject of the experiment becomes very blue in the face and is partially stupefied by want of oxygen before he has any desire to breathe. The probable explanation of these facts is that want of oxygen does not itself excite the centre, but that some substance—very probably lactic acid, which is known to be formed abundantly—is produced abnormally in the body during exposure to want of oxygen and aids the carbon dioxide in exciting the centre. It is known that the blood becomes less alkaline at high altitudes, and that acids in general excite the centre. A person on a high mountain thus gets out of breath much more easily than at sea-level. The extra stimulus to the centre during work still comes from the extra carbon dioxide formed, but has a greater effect than usual on the breathing. If the extra stimulus came directly from want of oxygen the person on the mountain would probably turn blue and lose consciousness on the slightest exertion. By analysing the alveolar air it can be shown that after a time even a height of 5000 to 6000 ft., or a diminution of only a sixth in the barometric pressure, distinctly increases the sensitiveness of the respiratory centre to carbon dioxide, so that there seems to be a slow accumulation of acid in the blood. The effect also passes off very slowly on returning to normal pressure, although the lack of oxygen is at once removed.

The blueness of the skin ("cyanosis") produced by lack of oxygen is due to the fact that the haemoglobin of the red corpuscles is imperfectly saturated with oxygen. Haemoglobin which is fully saturated with oxygen has a bright red colour, contrasting with the blue colour which it assumes when deprived of oxygen. According to the existing evidence the saturation of the haemoglobin is practically complete under normal conditions in the lungs, or when thoroughly shaken at the body temperature and normal atmospheric pressure with air of the same composition as normal alveolar air. As the partial pressure of the oxygen in this air falls, however, the saturation of the haemoglobin becomes less and less complete, and the arterial blood assumes a more and more blue tinge, which imparts a blue or leaden colour to the skin, accompanied by the symptoms, already referred to, of lack of oxygen. Normal arterial blood in man yields about 19 volumes of physiologically available oxygen for each 100 volumes of blood. Of these 19 volumes about 18½ are loosely combined with the haemoglobin of the red corpuscles, the small remainder being in simple solution in the blood. Venous blood, on the other hand, yields only about 12 volumes. The combination of haemoglobin with oxygen is only stable in the presence of free oxygen at a pressure of about that in normal alveolar air. As this pressure falls the compound is progressively dissociated. From this it can be readily understood why the blood loses its oxygen in passing through the tissues, which are constantly absorbing free oxygen, and regains it in the lungs. The marked effects produced by abnormal deficiency in the pressure of oxygen in the alveolar air are also readily intelligible; for even although the arterial blood still contains sufficient oxygen to cover the normal difference between the oxygen content of arterial and that of venous blood, yet this oxygen is given off to the tissues less readily—i.e. at a lower pressure, and thus fails to supply their demands completely. It is evident also that in pure air at normal pressure increased ventilation of the lungs does not appreciably increase the supply of oxygen to the blood, whereas in air largely deprived of its oxygen, or at low pressure, the increased alveolar oxygen pressure produced by deep breathing helps greatly in saturating the blood with oxygen, and may thus relieve the symptoms of want of oxygen. Hence it is that the increased sensitiveness of the respiratory centre to carbon dioxide, and consequent increased depth of breathing, at high altitudes compensates to a large extent for deficiency in the oxygen pressure. Addition of carbon dioxide to the inspired air produces exactly the same result. Indeed

Professor Angelo Mosso was led by observation of the beneficial effects of carbon dioxide at low atmospheric pressure to attribute mountain sickness to lack of carbon dioxide, a condition which he designated by the word "acpnia." When impure air is vitiated, not only by deficiency of oxygen, but also by carbon dioxide, the carbon dioxide causes panting, which not only gives warning of any danger, but prevents the alveolar oxygen percentage from falling in the way it would do if the carbon dioxide were absent. In this way the carbon dioxide greatly lessens the danger. To give instances, air progressively and very highly vitiated by respiration is much less likely to cause danger if the carbon dioxide is not artificially absorbed, and not nearly so dangerous as the great diminution of atmospheric pressure (and consequently of oxygen pressure) which occurs in a very high balloon ascent. Indeed the dangers of a very high balloon ascent are notorious, and a number of deaths or very narrow escapes are on record.

Just as oxygen forms a dissociable compound with the haemoglobin of the blood, so does carbon dioxide form dissociable compounds. One of these compounds appears to be with haemoglobin itself, and another is sodium bicarbonate, which is far more easily dissociated in the blood than in a simple watery solution, owing to the presence of proteid and possibly other substances which act as weak acids and thus help the dissociation process. The whole of the carbon dioxide can therefore be removed from the blood by a vacuum pump, just as the whole of the oxygen can. Venous blood contains roughly speaking about 40 volumes of carbon dioxide per 100 of blood, and arterial blood about 34 volumes. Of this carbon dioxide only about 3 volumes can be in free solution, the rest being loosely combined. The conveyance of carbon dioxide from the blood to the lungs is thus readily intelligible, as well as the fact that any increase or diminution of the pressure of carbon dioxide in the alveolar air will naturally lead to a damming back or increased liberation of carbon dioxide from the blood, and that by forced breathing carbon dioxide can be washed out of the blood to such an extent that a prolonged cessation of natural breathing (*apnoea*) follows, since even in the venous blood the partial pressure of carbon dioxide has become too low to excite the respiratory centre.

It will be evident from the foregoing that in order to supply efficiently the respiratory requirements of the tissues not only must the breathing, but also the circulation, be suitably regulated. In hard muscular work the consumption of oxygen and output of carbon dioxide may be increased eight or ten times beyond those of rest. Unless, therefore, the blood supply to the active tissues were correspondingly increased, deficiency of oxygen would at once arise, since the amount of oxygen carried by a given volume of the arterial blood is very limited, as already explained. It is known that the supply of blood to each organ is always increased during its activity. This increase can, for instance, readily be seen and measured in the case of contracting muscles or secreting glands; and the volume and frequency of the pulse are greatly increased during muscular work. But while it is evident enough that the flow of blood through the body is determined in accordance with the metabolic activities of each tissue, our knowledge is as yet very scanty as to the means by which this determination is brought about. Probably, however, carbon dioxide may be nearly as important a factor in the regulation of the circulation as in that of breathing. Just as the rate of breathing was formerly supposed to determine, and not to be determined by, the fundamental metabolic processes of the body, so the circulation was supposed to be another independent determining factor; and under the influence of these mechanistic conceptions the direction of investigation into the phenomena of respiration and circulation has been largely diverted to side issues.

Since the circulation, no less than the breathing, is concerned in the supply of oxygen to and removal of carbon dioxide from the tissues, it can readily be understood that defective circulation, such as occurs, for instance, in uncon-

pensated valvular affections of the heart, may affect the breathing and hinder the normal respiratory exchange. Conversely, also, defects in the aeration or oxygen-carrying power of the blood may be compensated for by increase in the circulation. For instance, in the very common condition known as anaemia, where the percentage of haemoglobin, and consequently the oxygen-carrying power of the blood, is often reduced to a third or less, the respiratory disturbances may be so slight that the patient is going about his or her ordinary work. A miner suffering from the now well-known "worm-disease" or ankylostomiasis (*g.v.*), may be working underground, or a housemaid suffering from chlorosis may be doing her work, with only a third of the normal oxygen-carrying power of the blood. There seems to be no doubt that in such cases an increased rate of blood circulation compensates for the diminished oxygen-carrying power of the blood. It is well known that at high altitudes a gradual process of adaptation to the low pressure occurs, and the shortness of breath and other symptoms experienced for the first few days gradually become less and less. This adaptation is partly, at least, due to a marked increase in the percentage of haemoglobin in the blood, though probably circulatory and perhaps other compensatory changes are also involved.

In connexion with respiration the action of certain poisons is of great interest. One of these, carbon monoxide, is of very common occurrence, and causes numerous cases of poisoning. Like oxygen, it has the property of combining with the haemoglobin of the blood, but its affinity for haemoglobin is far more strong than that of oxygen. In presence of air containing as little as 0.5% of carbon monoxide, the haemoglobin will become about equally shared between oxygen and carbon monoxide, so that, since air contains 20.9% of oxygen, the affinity of carbon monoxide for haemoglobin may be regarded as about 400 times greater than that of oxygen. The blood of a person breathing even a small percentage of carbon monoxide may thus become gradually saturated to a dangerous extent, since the haemoglobin engaged by the carbon monoxide is for the time useless as an oxygen-carrier. Air containing more than about 0.1% of carbon monoxide is thus more or less dangerous if breathed for long; but the blood completely recovers in the course of a few hours if pure air is again breathed. The poisonous action of carbon monoxide can be abolished by placing the animal exposed to it in oxygen at an excess pressure of about an atmosphere. The reason for this is that, in consequence of the increased partial pressure of the oxygen, the amount of this gas in free solution in the blood is greatly increased in accordance with Dalton's law, and becomes sufficient to supply the tissues with oxygen quite independently of the haemoglobin. Even at ordinary atmospheric pressure the extra oxygen dissolved in the blood when pure oxygen is breathed is of considerable importance. Carbon-monoxide poisoning is the chief cause of death in colliery explosions and fires, and the sole cause in poisoning by lighting gas and fuel gas of various kinds. Its presence in dangerous proportions may be readily detected with the help of a small bird, mouse or other small warm-blooded animal. In such animals the respiratory exchange is so rapid that symptoms of carbon-monoxide poisoning are shown far more quickly than in man. The small animal can thus be employed in mines, &c., to indicate danger from carbon monoxide. A lamp is useless for this purpose. There are various other poisons, such as nitrites, chlorates, dinitrobenzol, &c., which act by disabling the haemoglobin, and so cutting off the oxygen supply to the tissues.

Between the air in the air-cells of the lungs and the blood of the lung capillaries there intervenes nothing but a layer of very thin, flattened cells, and until recently it was very generally believed that it was by diffusion alone that oxygen passes inwards and carbonic acid outwards through this layer. Similar simple physical explanations of processes of secretion and absorption through living cells have, however, turned out to be incorrect in the case of other organs. It is known, moreover, that in the case of the swimming-bladder of fishes oxygen is secreted into

the interior against enormous pressure. Thus, in the case of a fish caught at a depth of 4500 ft., the partial pressure of the oxygen present in the swimming bladder at this depth was 127 atmospheres, whereas the partial pressure of oxygen in sea-water is only about 0.2 atmosphere. Diffusion can therefore have nothing to do with the passage of gas inwards, which is known to be under the control of the nervous system. The cells lining the interior of the swimming bladder are developed from the same part of the alimentary tract as those lining the air-cells of the lungs, so that it seems not unlikely that the lungs should possess the power of actively secreting or excreting gases. The question whether such a power exists, and is normally exercised, has been investigated by more than one method; and although it is not possible to go into the details of the experiments, there can be no doubt that the balance of the evidence at present available is in favour of the view that diffusion alone is incapable of explaining either the absorption of oxygen or the excretion of carbon dioxide through the lining cells of the lungs. The partial pressure of oxygen appears to be always higher, and of carbon dioxide often lower, in the blood leaving the lungs than in the air of the air-cells; and this result is inconsistent with the diffusion theory. As to the causes of the passage of oxygen and carbonic acid through the walls of the capillaries of the general circulation, we are at present in the dark. Possibly diffusion may explain this process.

II. Although we cannot trace the exact changes which occur when oxygen passes into living cells, yet it is possible to obtain a clear general view of the origin and destiny of the material concerned in the process, and of the physiological conditions which determine it.

The oxidizable material within the body consists, practically speaking, of proteids (albumen-like substances, with which the collagen of connective tissue may be included), fats and carbohydrates (sugars and glycogen). All of these substances contain carbon, hydrogen and oxygen in known, though different, proportions, and the former also contains a known amount of nitrogen and a little sulphur. Nitrogen is constantly leaving the body as urea and other substances in the urine and faeces; and a small but easily measurable proportion of carbon passes off in the same manner. The rest of the carbon passes out as carbon dioxide in respiration. Now carbohydrates and fats are oxidized completely in the body to carbon dioxide and water. This follows from the fact that, practically speaking, no other products into which they might have been converted leave the body except carbon dioxide and water. Moreover, a given weight of carbohydrate requires for its oxidation a definite weight of oxygen, and produces a definite weight of carbon dioxide. There is thus a definite relation between the weight of oxygen used up and the weight of carbon dioxide formed in this oxidation. The same is true for the oxidation of fat and of proteid, allowing in the latter case for the fact that the nitrogen, together with part of the carbon and hydrogen, passes out as urea, &c., in an incompletely oxidized form. From all this it follows that if we measure over a given period (1) the discharge of nitrogen from the body, (2) the intake of oxygen and (3) the output of carbonic acid, we can easily calculate exactly what the ultimate destiny of the oxygen has been, and at the ultimate expense of what material the carbonic acid has been formed. What the intermediate stages may have been we cannot say, but this in no way affects the validity of the calculation. If, during the period of measurement, food is taken, the basis of the calculation is still substantially the same, as the oxidizable material in food consists of practically nothing else except proteids, carbohydrates and fats.

Liberation of Energy.—From experiments made outside the body, we know that in the oxidation of a given weight of proteid, carbohydrate or fat, a definite amount of energy is liberated. In the article on DIETETICS it is shown that precisely the same liberation of energy occurs in the living body, due allowance being made for the fact that the oxidation of proteid is not quite complete. The following table shows the respiratory quotients (the respiratory quotient being the ratio between

the volume of carbon dioxide formed and that of oxygen used up) and energy expressed in units of heat (calories) liberated per gramme of carbon dioxide produced and oxygen consumed in the living body during the oxidation of proteid, fat and a typical carbohydrate:—

Substance oxidized.	Respiratory quotient.	Calories per gramme of CO ₂ produced.	Calories per gramme of oxygen consumed.
Proteid78	2.78	3.00
Fat71	3.35	3.27
Cane-sugar	1.00	2.59	3.56

In the oxidation of non-living substances the rate varies, within wide limits, according to that at which oxygen is supplied. Thus a fire burns the faster the more air is supplied, and the higher the percentage of oxygen in the air. It was for long believed that in the living body also the rate of oxidation must vary according to the oxygen supply. It has been found, however, that this is not the case. Provided that a certain minimum of oxygen is present in the air breathed, or in the blood supplied to the tissues, it is, practically speaking, indifferent whether the oxygen supply be increased or diminished: only a certain amount is consumed. It might be supposed that the reason for this is that the available oxidizable material in the body is limited, and that if the food supply were increased there would be a corresponding increase in the rate of oxidation. This hypothesis is apparently supported by the fact that, when an increased supply of proteid is given as food, the amount of nitrogen discharged in the urine is almost exactly correspondingly increased, so that evidently the oxidation of proteid increases correspondingly with the supply. Similarly, when carbohydrate food is given, the alteration in the respiratory quotient shows that more carbohydrate than before is being oxidized. Closer investigation in recent times has, however, brought out the very striking fact that, if oxidation be measured in terms of energy liberated by it in the body, it makes but little difference, other things being equal, whether the animal is fasting or not. If more proteid or carbohydrate is oxidized at one time, correspondingly less fat is oxidized, but the total energy liberated as heat, &c., in the body is about the same, unless the diet is very excessive, when there is a slight increase of oxidation. Even after many days of starvation, the rate of oxidation per unit of body weight has been found to remain sensibly the same in man. When more food is taken than is required, the excess is stored up, chiefly in the form of fat, into which carbohydrate and possibly also proteid are readily converted in the body. When less food is taken than is needed, the stock of fat is drawn upon, and supplies by far the greater proportion of the energy requirements of the body.

During the performance of muscular work oxidation is greatly increased, and may amount to ten times the normal or more. Even the slight exertion of easy walking increases oxidation to three times. When the energy represented by the external work done in muscular exertion is compared with the extra energy liberated by oxidation in the body, it is found, as would be expected, that the latter value largely exceeds the former. In other words, much of the energy liberated is wasted as heat. Nevertheless the muscles are capable of working with less waste than any steam or gas engine. In the work of climbing, for instance, it has been found in the case of man that 35 % of the energy liberated is represented in the work done in raising the body. Muscular work, if at all excessive, leads to fatigue, and consequent rest. On the other hand, unnatural abstinence from muscular activity leads to restlessness and consequent muscular work. Hence on an average of the twenty-four hours the expenditure of energy by different individuals, with different modes of life, does not as a rule differ greatly.

The rate of oxidation per unit of body weight varies considerably according to size and age. If we compare different warm-blooded animals, we find that the rate of oxidation is relatively

to their weight far higher in the smaller ones. In a mouse or small bird, for instance, the rate is about twenty times as great as in a man. The difference is in part due to the fact that the smaller animal is the greater its surface relatively to its mass, and consequently the more heat does it require to keep up its temperature. The smaller animal must therefore produce more heat. Even in cold-blooded animals, however, oxidation appears to be more rapid the smaller the animal. In the case of man, oxidation is relatively more than twice as rapid in children than in adults, and the difference is greater than would be accounted for by the difference in the ratio of surface to mass. Allowing for differences in size, oxidation is about equally rapid in men and women.

It was for long believed that the special function of respiratory oxidation was (1) the production of heat, and (2) the destruction of the supposed "waste products." Further investigation has, however, tended to show more and more clearly that in reality respiratory oxidation is an essential and intimate accompaniment of all vital activity. To take one example, secretion and absorption, which were formerly explained as simple processes of filtration and diffusion, are now known to be accompanied, and necessarily so, by respiratory oxidation in the tissues concerned. The respiratory oxidation of an animal is thus a very direct index of the activity of its vital processes as a whole. Looking at what is known with regard to respiratory oxidation, we see that what is most striking and most characteristic in it is its tendency to persist—to remain on the whole at about a normal level for each animal, or each stage of development of an animal. The significance of this cannot be over-estimated. It indicates clearly that just as an organism differentiates itself from any non-living material system by the manner in which it actually asserts and maintains its specific anatomical structure, so does it differentiate itself from any mere mechanism by the manner in which it asserts and maintains its specific physiological activities.

AUTHORITIES.—For further general information the reader may be referred to the sections by Pembrey and by Gamgee in Schäfer's *Handbook of Physiology*, vol. I, and by Bohr in Nagel's *Handbuch der Physiologie*, vol. I. The following additional references are to recent investigations: Regulation of Breathing, Haldane and Priestley, *Journal of Physiology*, xxxii. 225 (1905). Respiration at High Altitudes and Effects of Want of Oxygen, Zuntz, Loewy, Caspari, and Müller, *Das Höhenklima* (1905); Boycott and Haldane, Ward, and Haldane and Poulton, *Journal of Physiology*, xxvii. (1908). Respiration at High Pressures, "Report to the Admiralty of the Committee on Deep Diving" (1907). Respiratory Exchange and Secretion, Barcroft, *Journal of Physiology*, xxvii. 31 (1901); Barcroft and Brodie, *Journal of Physiology*, xxvii. 18, and xxxiii. 52 (1905). Excretion of CO₂ by the Lung Epithelium, Bohr, *Zentralblatt für Physiologie*, xxi. 337 (1907). "Normal Alveolar CO₂ Pressure in Man," Mabel Fitzgerald and J. Haldane in *Physiological Journal* (1905). (J. S. H.)

(3) MOVEMENTS OF RESPIRATION

Normal Respiration.—If the naked body of a person asleep or in perfect inactivity be carefully watched, it will be found that the anterior and lateral walls of the chest move rhythmically up and down, while air passes into and out of the nostrils (and mouth also if this be open) in correspondence with the movement. If we look more closely we shall find that with every uprising of the chest walls the membranous intercostal portions sink slightly as if sucked in, while at the same time the flexible walls of the abdomen bulge as if protruded by some internal force. If respiration be in the slightest degree hurried, these motions become so marked as to escape the attention of no one. The elevation of the chest walls is called *inspiration*, their depression *expiration*. Inspiration is slightly shorter than expiration, and usually there is a slight pause or momentary inaction of the chest between expiration and the following inspiration. Apparatuses for measuring the excursion of a given point of the chest wall during respiration are called *thoracometers* or *stethometers*. Apparatuses for recording the movements of the chest are called *stethographs* or *pneumographs*.

Frequency of Respiration.—The frequency of respiration

during perfect rest of the body is '16 to 24 per minute, the pulse rate being usually four times the rate of respiration; but the respiratory rhythm varies in various conditions of life. The following are the means of many observations made by Lambert Adolphe Quételet (1796-1874): at the age of one year the number of respirations is 44 per minute; at 5 years, 26; from 15 to 20 years, 20; from 25 to 30, 16; from 30 to 50, 18-1. Muscular exertion always increases the frequency of respiration. The higher the temperature of the environment the more frequent is the respiration. Paul Bert (1833-1886) has shown that with higher atmospheric pressures than the normal the frequency of respiration is diminished while the depth of each inspiration is increased. The frequency of respiration diminishes until dinner-time, reaches its maximum within an hour of feeding, and thereafter falls again; if dinner is omitted, no rise of frequency occurs. The respiratory act can be interrupted at any stage, reversed, quickened, slowed and variously modified at will, so long as respiration is not stopped entirely for more than a short space of time; beyond this limit the will is incapable of suppressing respiration.

Depth of Respiration.—The depth of respiration is measured by the quantity of air inspired or expired in the act; but the deepest expiration possible does not suffice to expel all the air the lungs contain. The following measurements have been ascertained, and are here classified according to the convenient terminology proposed by John Hutchinson (1811-1861). (1) *Residual air*, the volume of air remaining in the chest after the most complete expiratory effort, ranges from 100 to 130 cub. in. (2) *Reserve or supplemental air*, the volume of air which can be expelled from the chest after an ordinary quiet expiration, measures about 100 cub. in. (3) *Tidal air*, the volume of air taken in and given out at each ordinary respiration may be stated at about 20 cub. in. (4) *Complemental air*, the volume of air that can be forcibly inspired over and above what is taken in at a normal inspiration, ranges from about 100 to 130 cub. in. By *vital capacity*, which once had an exaggerated importance attached to it, is meant the quantity of air which can be expelled from the lungs by the deepest possible expiration after the deepest possible inspiration; it obviously includes the complemental, tidal and reserve airs, and measures about 230 cub. in. in the Englishman of average height, i.e. 5 ft. 8 in. (Hutchinson). It varies according to the height, body weight, age, sex, position of the body and condition as to health of the subject of observation.

Vital capacity is estimated by means of a *spirometer*, a graduated gasometer into which air may be blown from the lungs. The residual air, which for obvious reasons cannot be actually measured, may be estimated in the following way (Emil Harless, 1820-1862; Louis Gréhan, b. 1838). At the end of ordinary expiration, apply the mouth to a mouthpiece communicating with a vessel filled with pure hydrogen, and breathe into and out of this vessel half a dozen times—until, in fact, there is reason to suppose that the air in the lungs at the time of the experiment has become evenly mixed with hydrogen. Then ascertain by analysis the proportion of hydrogen to expired air in the vessel and estimate the amount of the air which the lungs contained by the following formula:—

$$V + v = p : 100 ; \\ V = \frac{v(100 - p)}{p}$$

where V = volume of air in the lungs at the time of experiment, v = volume of the vessel containing hydrogen, p = proportion of air to hydrogen in the vessel at the end of the experiment. V, then, is the volume of air in the lungs after an ordinary expiration; that is, it includes the residual and the reserve air; if we subtract from this the amount of reserve air ascertained by direct measurement, we obtain the 100-130 cub. in. which Hutchinson arrived at by a study of the dead body.

Volume of Respiration.—It is clear that the ventilation of the lungs in ordinary breathing does not merely depend on

the quantity of air inspired at each breath, but also on the number of inspirations in a given time. If these two values be multiplied together we get what might be called the *volume* of respiration (*Athmungsgrösse*, Isidore Rosenthal, b. 1836), in contradistinction to depth of respiration and frequency of respiration. Various instruments have been devised to measure the volume of respiration, all more or less faulty for the reason that they compel respiration under somewhat abnormal conditions (Rosenthal, Gad, Peter Ludwig, Panum (1820-1885), Ewald Hering (b. 1834)). From the data obtained we may conclude that the respiratory volume per minute in man is about 366 cub. in. (6000 cub. centim.). In connexion with this subject it may be stated that, after a single ordinary inspiration of hydrogen gas, 6-10 respirations of ordinary air must occur before the expired air ceases to contain some trace of hydrogen.

Types of Respiration.—The visible characters of respiration in man vary considerably according to age and sex. In men, while there is a moderate degree of upheaval of the chest, there is a considerable although not preponderating degree of excursion of the abdominal walls. In women the chest movements are decidedly most marked, the excursion of the abdominal walls being comparatively small. Hence we may distinguish two types of respiration, the costal and the abdominal, according to the preponderance of movement of one or the other part of the body wall. In forced respiration the type is costal in both sexes, and so it is also in sleep. The cause of this difference between men and women has been variously ascribed (*a*) to constriction of the chest by corsets in women, (*b*) to a natural adaptation to the needs of child-bearing in women, and (*c*) to the greater relative flexibility of the ribs in women permitting a wider displacement under the action of the inspiratory muscles.

Certain Concomitants of Normal Respiration.—If the ear be placed against the chest wall during ordinary respiration we can hear with every inspiration a sighing or rustling sound, called "vesicular," which is probably caused by the expansion of the air vesicles; and with every expiration a sound of a much softer sighing character. In children the inspiratory rustle is sharper and more pronounced than in adults. If a stethoscope be placed over the trachea, bronchi or larynx, so that the sounds generated there may be separately communicated to the ear, there is heard a harsh to-and-fro sound during inspiration and expiration which has received the name of "bronchial."

In healthy breathing the mouth should be closed and the ingoing current should all pass through the nose. When this happens the nostrils become slightly expanded with each inspiration, probably by the action of the *M. dilatatores naris*. In some people this movement is hardly perceptible unless breathing be heavy or laboured. As the air passes at the back of the throat behind the soft palate it causes the velum to wave very gently in the current; this is a purely passive movement. If we look at the glottis or opening into the larynx during respiration, as we may readily do with the help of a small mirror held at the back of the throat, we may notice that the glottis is wide open during inspiration and that it becomes narrower by the approximation of the vocal chords during expiration. This alteration is produced by the action of the laryngeal muscles. Like the movements of the nostril, those of the larynx are almost imperceptible in some people during ordinary breathing, but are very well marked in all during forced respiration.

The Mechanics of Respiration.—The thorax is practically a closed box entirely filled by the lungs, heart and other structures contained within it. If we were to freeze a dead body until all its tissues were rigid, and then were to remove a portion of the chest wall, we should observe that every corner of the thorax is accurately filled by some portion or other of its contents. If we were to perform the same operation of removing a part of the chest wall in a body not first frozen we should find, on the other hand, that the contents of the

thorax are not by any means in such circumstances bulky enough to fill up the space provided for them. If we were to measure the organs carefully we should find that those which are hollow and whose cavities communicate with the regions outside the thorax are all larger in the frozen corpse than in that which was not frozen. In other words, the organs in the thorax are distended somewhat in order that they may completely fill the chest cavity; and the nature of this curious and important condition may best be illustrated by the simple diagrams, figs. 7 and 8 (from Hermann's *Physiologie des*

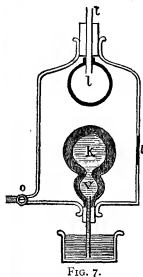

FIG. 7.

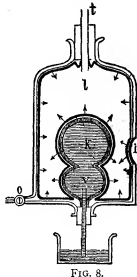

FIG. 8.

Menschen),—where *t* is the trachea, *l* the lung, *v* the auricle of the heart, *k* the ventricle, *i* an intercostal space with its flexible membranous covering. When the interior of the vessel is rendered vacuous by exhaustion through the tube *o*, the walls of the lungs and heart are expanded until the limits of the containing vessel are accurately filled, while all flexible portions of the walls of the vessel (corresponding to the intercostal membranes and the diaphragm of the thorax) are sucked inwards.

From this description it follows that the lungs, even when the thorax is most contracted, are constantly over-distended, and that, when the cause of this over-distension is removed, the lungs, being elastic, collapse. It further follows that if the thorax is dilated, the flexible hollow organs it contains must perforce be still more distended—a distension which in the case of the lungs is followed by an indrawing of air through the trachea in all cases where the trachea is open. Thus, as the act of respiration is primarily a dilatation of the thorax, the part played by the lungs is, as Galen knew, a purely passive one.

How is dilatation of the thorax effected? It has been pointed out that the rib-planes decline from the horizontal in two directions, viz. from behind forwards, and from the antero-posterior mesial plane outwards; a glance at fig. 9 will make this double sloping clear to the reader. It has, moreover, been explained that the diaphragm arches upwards into the thorax in such a manner that the lateral parts of the arch are vertical and in contact with the inner face of the thoracic walls. This being the structure of the thorax, the enlargement of its cavity is brought about (1) by raising the rib-planes until they approach the horizontal, and (2) by depressing the diaphragm and making its rounded dome more cone-like in outline. A moment's consideration will show how these actions enlarge the boundaries of the thorax. (*a*) When the postero-anterior slope of the rib-planes is diminished by the raising of the anterior ends of the ribs, the whole sternum is thrust upwards and forwards, and the antero-posterior diameter of the thorax is increased. (*b*) When the lateral slope of the rib-planes is diminished by the ribs being moved

upwards about an axis passing through their sternal and vertebral extremities, it is evident

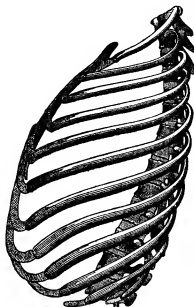

From Hermann's Handbuch.

FIG. 9.—Showing Slope of Ribs.

through their sternal and vertebral extremities, it is evident that the lateral diameter of the thorax must be increased. (c) When the muscular portion of the diaphragm contracts, the curves of its dome-like shape are straightened, the whole diaphragm comes to look more conical on section, and the apposition of its lateral parts to the inner surface of the thorax is destroyed; the two opposed surfaces are drawn apart much as the leaves of a book might be, and a space is formed between them, into which some portion of the lung slips. (d) When the diaphragm descends it draws with it the whole contents of the thorax; inasmuch as the contents as a whole are conical in shape with the apex upward and are fitted into the conical space of the thoracic cavity, it is clear that the descent of the contents will tend to create a space between them and the thoracic walls; for each stratum of lung, &c., which is adapted to fit a certain level of thorax, will thereby be brought into a lower and (as the thorax is conical) a more spacious level. Hence the descent of the diaphragm causes a much greater enlargement of the thorax than is measured by the mere elongation of the vertical diameter. In this manner the thorax is distended and air is drawn into the lungs. The contraction of the thorax in expiration is brought about by the return of the ribs and diaphragm to their original position of rest.

How the Inspiratory Movements are Produced.—The Rib Movements.—These are caused by the contraction of muscles which are fixed either to the central axis of the body (including under that term the head and vertebral column) or to some point rendered sufficiently stable for the purpose by the action of other adjuvant muscles. Thus the *M. levatores costarum* arise from the transverse processes of the 7th cervical and eleven upper dorsal vertebrae, and are attached to the ribs below in series; the *M. scaleni* spring from the cervical vertebrae, and are attached to the anterior parts of the first and second ribs; the *M. sternocleidomastoidei* arise from the side and back of the skull, and are inserted into the upper part of the sternum and the clavicle; the *M. pectoralis minor* arises from the coracoid process of the scapula, and is inserted into the anterior ends of some of the ribs; the *M. serratus posticus superior* arises from certain of the cervical and dorsal vertebrae, and is inserted into the posterior part of certain of the ribs; the *M. cervicalis ascendens* (part of the *M. erector spinae*) arises from certain of the cervical vertebrae, and is inserted into the posterior part of certain ribs. The *M. serratus magnus* and the *M. pectoralis major*, which are affixed on the one hand to the upper arm and to the scapula respectively, and on the other to the ribs and to the sternum respectively, may in certain elevated positions of the arm and shoulder act as inspiratory muscles. When all these muscles contract, the ribs are raised in the twofold way already described, some pulling up the anterior ends of the ribs, and others causing the arched ribs to rotate about an axis passing through their vertebral and sternal joints.

In addition to the muscles just enumerated, the *M. intercostales externi* are undoubtedly inspiratory muscles. Every external intercostal muscular fibre between a pair of ribs must, when it contracts, of necessity raise both ribs, as is clearly shown

by the accompanying diagram (fig. 10). Here $a'b'$ must be shorter than ab , for if angle $BAA' = x$, then

$$a'b'^2 = AB^2 + (Bb - Aa)^2 + 2AB(Bb - Aa)\cos x;$$

hence $a'b'$ will be larger the smaller the angle x , for the cosine increases as the angle diminishes.

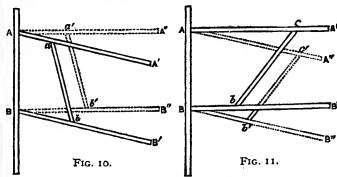

FIG. 10.

FIG. 11.

By a similar geometrical treatment of the question it may be shown that the internal intercostal muscles when they contract must of necessity depress both the ribs to which they are attached. If the angle $BAC' = x$ (fig. 11), then

$$c'd'^2 = AB^2 + (Ac' - Bd')^2 - 2AB(Ac' - Bd')\cos x;$$

hence $c'd'$ will be larger the larger the angle x .

The case, however, is not so clear with reference to the anterior portions of the internal intercostals which lie between the cartilages; for it is evident that these fibres have the same direction with regard to the sternum as an axis as the external intercostals have with regard to the vertebral column as an axis; that is to say, the geometrical diagram in fig. 10 applies to the inter-cartilaginous internal intercostals as perfectly as it does to the inter-osseous parts of the external intercostals, the inference being that the inter-cartilaginous internal intercostals tend to elevate the pair of ribs between which they stretch. The geometrical argument is, however, overborne by physiological experiment: Martin and Hartwell have observed in the dog and the cat that the internal intercostals throughout their whole extent contract (not synchronously) but alternately with the diaphragm; hence we must conclude that their function throughout is not inspiratory like that of the diaphragm, but expiratory.

The Movements of the Diaphragm.—The muscular fibres of the diaphragm are arranged in a radial manner, or, more strictly speaking, in a manner like the lines of longitude on a terrestrial globe. The central tendon of the diaphragm corresponds to the pole of such a globe. The contraction of the fibres is expended on straightening the longitudinal curves rather than on pulling down the central tendon to a lower level; in fact, the central tendon moves very little in ordinary respiration.

How the Expiratory Movements are Produced.—The action of inspiration disturbs many organs from the position of rest into which gravity and their own physical properties have thrown them. The ribs and sternum are raised from the position of lowest level; the elastic costal cartilages are twisted; the elastic lungs are put upon the stretch; the abdominal organs, themselves elastic, are compressed and thrust against the elastic walls of the belly, causing these to bulge outwards. In short the very act of inspiration stores up, as it were, in sundry ways the forces which make for expiration. As soon as the inspiratory muscles cease to act these forces come into play, and the position of rest or equilibrium is regained. It is very doubtful whether any special expiratory muscles are called into action during ordinary respiration. The internal intercostals may in man be exercised in ordinary expiration (although they are certainly not so exercised in the dog and the cat); but in laboured expiration many muscles assist in the expulsive effort. The muscles forming the belly-walls contract and force the abdominal contents against the relaxed diaphragm in such a manner as to drive it farther and farther into the thorax. At the same time by their attachment to the lower edge of the

thorax these same muscles pull down the ribs and sternum. The *M. triangularis sterni*, which arises from the back or thoracic aspect of the sternum and lower costal cartilages and is inserted into the costal cartilages higher up, can obviously depress the ribs. So also can the *M. serratus posticus inferior*, which arises from the thick fascia of the loins and is inserted into the last four ribs. So also can the *M. quadratus lumborum*, which springs from the pelvis and is attached to the last rib. Indeed there is hardly a muscle of the body but may be called into play during extremely laboured respiration, either because it acts on the chest, or because it serves to steady some part and give a better purchase for the action of direct respiratory muscles.

Certain Abnormal Forms of Respiration.

Coughing.—There is first a deep inspiration followed by closure of the glottis. Then follows a violent expiratory effort which bursts open the glottis and drives the air out of the lungs in a blast which carries away any light irritating matter it may meet with. The act is commonly involuntary, but may be imitated exactly by a voluntary effort.

Howling, or Clearing the Throat.—In this act a current of air is driven from the lungs and forced through the narrow space between the root of the tongue and the depressed soft palate. This action can only be caused voluntarily.

Sneezing.—There is first an inspiration which is often unusually rapid; then follows a sudden expiration, and the blast is directed through the nose. The glottis remains open all the time. The act is generally involuntary, but may be more or less successfully imitated by a voluntary effort.

Snoring is caused by unusually steady and prolonged inspirations and expirations through the open mouth,—the soft palate and uvula being set vibrating by the currents of air.

Crying consists of short deep inspirations and prolonged expirations with the glottis partially closed. Long-continued crying leads to sobbing, in which sudden spasmodic contractions of the diaphragm cause sudden inspirations and inspiratory sounds generated in larynx and pharynx.

Sighing is a sudden and prolonged inspiration following an unusually long pause after the last expiration.

Laughing is caused by a series of short expiratory blasts which provoke a clear sound from the vocal chords kept tense for the purpose, and at the same time other articulate but very characteristic sounds from the vibrating structures of the larynx and pharynx. The face has a characteristic expression. This act is essentially involuntary, and often is beyond control; it can only be imitated very imperfectly.

Yawning is a long deep inspiration followed by a shorter expiration, the mouth, fauces and glottis being kept open in a characteristic fashion. It is involuntary, but may be imitated.

Hiccough is really an inspiration suddenly checked by closure of the glottis; the inspiration is due to a spasmodic contraction of the diaphragm. The closure of the glottis generally leads to a characteristic sound. (A. G.*)

(4) PATHOLOGY OF THE RESPIRATORY SYSTEM

In the following article we have to give an account of the more important pathological processes which affect the lungs, pleurae and bronchial tubes. In the aetiology of pulmonary affections, the relations between the lungs and the external air, and also between them and the circulatory system, are important. The lungs are, so to speak, placed between the right and left cavities of the heart, and the only way for the blood to pass from the right ventricle to the left side of the heart, except in cases of a patent foramen ovale or other congenital defect forming a communication between the two sides of the organ, is by passing through them. The result is that not only may they become diseased by foreign material carried into them by the blood, but any obstruction to the flow of blood through the left side of the heart tends sooner or later to engorge or congest them, and lead to further changes. Through the nose and mouth they are in direct connexion with the external atmosphere. Hence the variable condition of the air as regards

temperature, degree of moisture, and density, is liable to produce directly various changes in the lungs, or to predispose them to disease; and the contamination of the air with various pathogenic germs and irritating particles in the shape of dust, is a direct source of many lung affections.

Bronchitis, or inflammation of the mucous membrane of the bronchial tubes, has been generally attributed to exposure to atmospheric changes. It occurs with great frequency in the extremes of life, and it is in early childhood and in old age that it is more liable to be fatal. Bronchitis may often follow exposure to cold, but that low temperature in itself is not sufficient to cause it is shown by the fact that the crews of arctic expeditions have been singularly free from diseases usually attributed to cold, but on their return to moist germ-laden atmospheres have at once been affected. Children reared in heated rooms with lack of ventilation are peculiarly susceptible to attacks on the slightest change of temperature. Bronchitis is also frequently caused by cardiac and renal diseases, and by the extension of inflammatory diseases of the upper air passages (as rhinitis, laryngitis or pharyngitis), while blockage of the nasal passages by adenoid or other growths may, by causing persistent mouth-breathing, lead to bronchial infection. Before the bacterial origin of disease was understood, bronchitis was attributed solely to what is termed "catching cold," and the exact relation of the chill to the bacterial infection is still unknown. It is probable that the chilling of the surface of the body by exposure causes congestion of the mucous membrane, the presence of a virulent micro-organism being then all that is required to produce bronchitis. It is generally accepted that in persons living in the pure air of the country the small bronchi and air-cells are sterile (Barthel in the *Zentralblatt für Bakteriologie*, vol. xxiv.). Bacteria are arrested on their way by the leucocytes of the nasal mucous membrane and by the vibration of the ciliated epithelium of the upper air passages. The mucous membrane of the upper bronchi is, however, tenanted by various micro-organisms such as the diplo-bacillus of Friedländer, bacillus coli communis, pneumococcus tetragenus, &c., and it is considered by William Ewart that these organisms, and in certain conditions of their host become virulent. "Specific" bronchitis occurs in the course of a specific infective disease (e.g. influenza, measles or whooping cough) and is due to the specific micro-organism gaining access by the mucous membrane of the respiratory tract. Cases have been known in which the diphtheria bacillus has been so localized. In glanders, small-pox, syphilis and pemphigus, the infective micro-organism is carried to the bronchi by the blood stream. In common or "non-specific" bronchitis, streptococci, pneumococci and staphylococci are found in the sputum together with Friedländer's bacillus and the bacillus coli communis. Microscopically the bronchi show hyperaemia of the mucous and submucous coats, and the whole wall becomes infiltrated with polymorphonuclear leucocytes and round cells. Many cells undergo mucoid degeneration, and there is abundant epithelial proliferation. A large quantity of mucus is secreted by the glands, and the lumen of the bronchi contains an exudate consisting of mucus, degenerated leucocytes and cast-off epithelial cells.

In the rare form of bronchitis known as fibrous or plastic bronchitis a membranous exudate is formed which forms casts of the bronchi, which may be coughed up. The casts vary from an inch to six or seven inches in length, with branches corresponding to the divisions of the bronchi from which they come. The cast consists of mucus and fibrin in varying proportions. The exact pathology of this variety is still undetermined.

Bronchitis may affect the whole bronchial tract, or more especially the larger or the smaller tubes. It may occur as an acute or as a chronic affection. In the acute form the inflammation may remain limited to the bronchial tubes and gradually subside, or it may lead to inflammation of the surrounding lung tissue, giving rise to disseminated foci of inflammation of greater or less extent throughout the lungs (catarrhal or bronchopneumonia). This is a common complication of bronchitis, especially where the smaller tubes are affected, and is more

frequently seen in children than adults. In cases of chronic bronchitis the affection, as a rule, begins as a slight ailment during the winter, and recurs in succeeding winters. The intervals of freedom from the trouble get shorter, and in the course of a few years it persists during the summer as well as the winter months. A condition of chronic bronchitis is thus established. The persistent cough which this occasions is one of the chief causes of the development of the condition of *emphysema*, where there is a permanent enlargement of the air-cells of the lungs with an atrophy of the walls of the air vesicles. The emphysema occasions an increase in the shortness of breath from which the person had previously suffered, and later, in consequence of the greater difficulty with which the blood circulates through the emphysematous lungs, the right side of the heart becomes dilated, and from that we have the development of a general dropsy of the subcutaneous tissues, and less and less perfect aeration of the blood.

The death rate from bronchitis in England and Wales during 1908 was: males 1102, females 1083 per million living. The death rate for the five years 1901-1905 was 1237 per million for all sexes. The death rate for the twenty years 1888-1908 consistently showed a slight decline.

Diseases of Occupations.—We all inhale a considerable amount of carbonaceous and other foreign particles, which in health are partly got rid of by the action of the ciliated cells lining the bronchial tubes, and are partly absorbed by cells in the wall of the tubes, and carried in the lymph channels to the bronchial lymphatic glands, where they are deposited, and cause a more or less marked pigmentation of the tissues. Part of such pigment is also deposited in the walls of the bronchial tubes and the interstitial tissue of the lungs, giving rise to the grey appearance presented by the lungs of all adults who live in large cities. In certain dusty occupations, such as those of stone masons, knife-grinders, colliers, &c., the foreign particles inhaled cause trouble. The most common affection so produced is chronic bronchitis, to which becomes added emphysema. In some cases not only is bronchitis developed, but the foreign particles lead to an increase of the fibrous tissue round the bronchi and in the interstitial tissue of the lungs, and so to a greater or lesser extent of fibroid consolidation. As this fibrous tissue may later undergo softening and cavities be formed, a form of consumption is produced, which is named according to the particular occupation giving rise to it; e.g. stonemasons' phthisis, knife-grinders' phthisis, colliers' phthisis. It should, however, be pointed out that these dusty occupations are probably not so frequently the cause as was at one time taught of these simple inflammatory fibroid changes in the lungs with their subsequent cavity formation; individuals engaged in such occupations are apt to suffer from a chronic tuberculosis of the lung associated with the formation of much fibrous tissue, and the occupation simply predisposes the lung to the attacks of the tubercle bacillus.

The term pneumonia is frequently used of different forms of inflammation of the lungs, and includes affections which run different clinical courses, present diverse appearances after death, and probably have different exciting causes. It would be better if the term *acute pneumonia* or *pneumonic fever* were reserved for that form of acute inflammation of the lungs which is usually characterized by sudden onset, and runs an acute course, which terminates generally by crisis from the fifth to the tenth day, the inflammation leading to the consolidation by fibrinous effusion of the greater part or whole of one lobe of a lung. Acute pneumonia usually occurs in a sporadic form, and is most prevalent in the United Kingdom from November to March. Occasionally it is epidemic, and there is evidence to show that sometimes it is an infective disease. There is great difficulty, however, in being quite certain that the occurrence of the disease in those who have been attending upon or brought into intimate connexion with sufferers from pneumonia is the result of infection, for such cases may be due to an epidemic of the disease, or to the various individuals attacked having been exposed to the same cause.

Formerly acute croupous or lobar pneumonia was thought to be due to "catching cold"; we now know it to be an infectious disease resultant on the invasion of one or more specific micro-organisms. The chief micro-organisms which have been found to be present during an attack of acute pneumonia are the micrococcus lanceolatus or pneumococcus of Fränkel and Weichselbaum, which is found in the inflamed lung in a large majority of cases and is capable of producing pneumonia when inoculated into guinea-pigs. Sternberg demonstrated the presence of the pneumococcus in the saliva of healthy individuals; it tends, however, in this case to vary in form. The micro-organism differs in virulence in given strains; thus one epidemic may be more severe than another; and it tends to increase in virulence in its passage through the human subject. The exact conditions necessary for the production of increased virulence in the organism causing an attack of lobar pneumonia are not yet determined, but are usually ascribed to lowered states of the health and to atmospheric conditions. The pneumococcus produces in the human organism an intracellular toxin, but the question as to whether it can also produce a soluble toxin in the living body is still debated. The difficulty of obtaining sufficient quantities of the toxins of this organism has prevented the production of antisera of high potency. In lower animals, less potent sera have proved successful in protecting against a fatal dose of pneumococci. The change effected by the administration of a serum is produced by causing a change in the pneumococci, which causes them to be more easily destroyed by the phagocytes. The element which brings about this change is termed an opsonin; see BLOOD and BACTERIOLOGY (ii). The bacillus pneumoniae of Friedländer is also said to be found in a certain percentage of cases, but a number of observers deny its presence in pure culture in primary croupous pneumonia.

Unlike many acute diseases, pneumonia does not render a person less liable to future attacks; on the contrary, those who have been once attacked must be looked upon as more prone to be affected again. Acute pneumonia usually attacks the whole or greater part of one lobe of one lung, but more than one lobe may be affected, or both lungs may be involved. The disease produces a solid and airless condition of the affected part owing to a fibrinous exudation taking place into the air-cells and smaller bronchial passages. In favourable cases the exudation is partly absorbed and partly expectorated, and the lung returns to its normal healthy condition; in others, death may ensue from the extent of lung affected, or from the spread of the inflammation to other parts, as for instance the pericardium or meninges of the brain. In such cases it is interesting to note that the same micro-organism has been found in the inflammatory exudation in the pericardium or on the meninges as in the pneumonic lung; probably the organism had been absorbed from the lung, and was the cause of the secondary inflammations. In cases of death from uncomplicated pneumonia a very variable extent of lung is involved. In some cases this result may be ascribed to the weakness of the individual and especially of the heart, but in others the virulence of the micro-organisms and the toxins which they have produced is probably the more correct explanation. The improvement in a patient suffering from pneumonia usually commences suddenly, with a rapid fall in the temperature. The day on which this "crisis" takes place varies, but most commonly it appears to be the seventh from the initial rigor (22% of the cases, Jürgensen). It may, however, occur a few days earlier or later, being observed in about 74% between the fifth and the ninth day of the disease (Jürgensen). The disease occasionally ends in the formation of an abscess, in gangrene, or in fibroid induration of the lung, but these terminations are rare.

The death rate of acute pneumonia for England and Wales in 1908 was 1383 per million living of the population.

Broncho-pneumonia.—It is usual to recognize a form of inflammation of the lungs which differs from the above lobar pneumonia.

and in which small patches of consolidation are usually scattered throughout the lower lobes of both lungs. This broncho- or catarrhal pneumonia is usually preceded by an attack of bronchitis, to which it bears an intimate relation. In some cases the small foci of inflammation may run together so as to affect the greater part of a lobe of a lung, and the distinction between such a form of broncho-pneumonia and lobar pneumonia presents such difficulties in the view of some observers, that they have refused to recognize any essential difference between the two. Usually, however, it is not difficult to distinguish the two affections both clinically and anatomically. Broncho-pneumonia is especially seen as a complication of bronchitis, and while it more frequently attacks children than young adults, it is not uncommon in old people, especially secondary to bronchitis. It is frequent in children after acute infectious fevers, especially measles and diphtheria, and in cases of whooping-cough. It differs from the above-mentioned pneumonia in that it does not usually attack the whole of a lobe of a lung, but occurs in small disseminated patches more especially throughout the lower lobe of both lungs. The accompanying fever is more irregular than in the preceding form, and the disease usually runs a more prolonged course. It is an extremely fatal affection in both the very young and old. Young persons who have suffered from it are not infrequently attacked by pulmonary tuberculosis subsequently. It must be admitted that we are even less certain of its bacteriology than we are of that of lobar pneumonia. In some cases Fränkel's pneumococcus is found, and in others various other micro-organisms. Many of the latter are doubtless saprophytic, and are not the essential cause of the disease, but it is not probable that any one particular form of organism accounts for all forms of broncho-pneumonia.

The bacteriology of broncho-pneumonia presents no one micro-organism which can be definitely said to cause the disease. The micro-organism most frequently found, either alone or associated with other bacteria, is the pneumococcus, which occurred in 67% of a series investigated by Wollstein. Other organisms found are the streptococcus, particularly in broncho-pneumonia following infectious fevers, the staphylococcus aureus and albus, and Friedländer's bacillus. In some cases the bacillus influenzae alone has been found, and the Klebs-Löffler bacillus in cases following upon diphtheria. When the disease is associated with pulmonary tuberculosis the tubercle bacillus is found.

The tuberculous virus, the tubercle bacilli, may gain entrance to the lungs through the inspired air or by means of the blood or lymph currents. Also in some cases it has been demonstrated that tubercle bacilli may infect the glands of the mesentery following the ingestion of the milk of tuberculous cattle. In this the Government Commissions of Great Britain and Germany as well as the United States Bureau of Animal Industry confirm the findings of private investigators. It may be well here to summarize the views generally held as to infection. In the first place, the doctrine of inherited disease is discredited, and the doctrine of specific susceptibility is in doubt. Infants are known to be extremely susceptible, and this susceptibility lessens with increasing age, adults requiring prolonged exposure. As a mode of infection the sputum of diseased persons is of great importance. Infected food, especially milk, comes next, together with food infected by flies; and the mother's milk is a minor source. Infection is not often received through the skin, but most frequently through the mucous membrane of the mouth, air passages and intestine; occasionally the infection is alveolar. Pulmonary tuberculosis is often secondary to a latent lymphatic form. The tubercle bacillus was discovered by Koch in 1882, and since then it has become generally accepted that the bacillus varies in type. The bacilli have been classified by A. G. Fouldrier into (a) occurring in fishes and cold-blooded animals, (b) in birds, (c) in rats, (d) in cattle, (e) in man. Exactly how far they

¹ The term catarrhal pneumonia has been usually regarded as synonymous with the term broncho-pneumonia, and this usual nomenclature has been maintained in the present article. We must, however, recognize that all simple acute broncho-pneumonias are not purely catarrhal in the strict pathological sense. For instance, a considerable amount of fibrinous exudation is not infrequently present in the patches of broncho-pneumonia, and some of the cases of septic broncho-pneumonia can scarcely be accurately termed catarrhal.

are interchangeable and can affect the human race is not definitely settled. They may be different varieties of the same species caused by differentiated strains of a common stock, or may be distinct but generically allied species. Von Behring considers that the bovine type may undergo modification in the human body, a theory which may lead to a complete change in our beliefs in the mode of entry of the bacillus. Recent investigators have put forward the view that the tubercle bacillus is not a bacterium, but belongs to the higher group known as streptotrichae or mould fungi.

The action of the tubercle bacillus upon the tissues, like most other infectious agents, gives rise to inflammatory processes and anatomical changes, varying with the mode of entry and virulence of the micro-organism. The most characteristic result is the formation throughout the lungs in the form of small scattered foci forming the so-called miliary tubercles. Such miliary tuberculosis of the lungs is frequently only a part of a general tuberculosis, a similar tuberculous affection being found in other organs of the body. In other cases the lungs may be the only or the principal seat of the affection. The source whence the tuberculous virus is derived varies in different cases. Old tubercular glands in the abdomen, neck and elsewhere, and tuberculous disease of bones or joints, are common sources whence tubercle bacilli may become absorbed, and occasion a general dissemination of miliary tubercles in which the lungs participate. Where the source of infection is an old tuberculous bronchial gland or a focus of old tubercle in the lung, the pulmonary organs may be the only seat of the development of miliary tuberculosis for a time; but even then, if life is sufficiently prolonged, other parts of the body become involved. Acute miliary tuberculosis of the lungs is not infrequently a final stage in the more chronic tuberculous lesions of the different forms of pulmonary phthisis.

In pulmonary phthisis, or consumption, the disease usually commences at the apex of one lung, but runs a very variable course. In a large majority of cases it remains confined to one small focus, and not only does not spread, but undergoes retrograde changes and becomes arrested. In such cases fibrous tissue develops round the focus of disease and the tuberculous patch dries up, often becoming the seat of the deposit of calcareous salts. This arrest of small tuberculous foci in the lung is doubtless of very frequent occurrence, and in *post mortem* examinations of persons who have died from injuries or various diseases other than tubercle it is common to find in the lungs arrested foci of tubercle, which in the majority of instances have never been suspected during life, and probably have occasioned few, if any, symptoms. It has been shown that in more than 37% of persons, over 21 years of age, dying in a general hospital of various diseases, there is evidence of arrested tubercle in the lungs. As such persons are chiefly drawn from the poorer classes, among whom tubercle is more common than among the well-to-do, this high percentage may not be an accurate indication of the frequency with which pulmonary tubercle does become arrested. It does, however, show that the arrest and the healing of tuberculosis of the lungs is by no means unrequent, and that it occurs among those who are not only prone to become infected, but whose circumstances are least favourable to the arrest of the disease. These facts indicate that the human organism does offer a resistance to the growth of the tubercle bacilli.

A focus of pulmonary tubercle may become arrested for a time and then resume activity. In many cases it is difficult to say why this is so, but often it is clearly associated with a lowering in the general health of the individual. It cannot be too strongly insisted that the arrest of a tuberculous focus in the lung is a slow process and requires a long time. Commonly a person in the early stage of phthisis goes away to a health resort, and in the course of a few weeks or months improves so much that he returns to a densely populated town and resumes his former employment. In a short time the disease shows renewed activity, because the improved

conditions were not maintained long enough to ensure the complete arrest of the disease.

Instead of the tuberculous focus becoming arrested, it may continue to spread. The original focus and the secondary ones are at first patches of consolidated lung. Later, their central parts soften and burst into a bronchus; then the softened portion is coughed up, and a small cavity is left, which tends gradually to increase in size by peripheric extension and by merging with other cavities. This process is repeated again and again, and sooner or later the other lung becomes similarly affected. At any stage of the softening process the blood vessels may become involved and give rise by rupture to a large or a small haemorrhage (*haemoptysis*). It not infrequently happens that such haemoptysis may be the first symptom that seriously attracts attention. At a later period haemorrhage frequently takes place in large or small amounts from the rupture of vessels, which frequently are dilated and form small aneurysms in the walls of cavities. A fatal termination may be hastened by the absorption by means of the blood vessels and lymphatics of the tuberculous virus from some of the foci of disease, and the occurrence therefrom of a local miliary tuberculosis of the lungs or a general tuberculosis of other organs. The rapidity with which the destructive process spreads throughout the lung varies considerably. We therefore recognize acute phthisis, or galloping consumption, and chronic phthisis. In the acute cases the softening progresses rapidly and is associated with the development of very little fibrous tissue; probably various forms of micro-organisms other than the tubercle bacilli assist in the rapid softening. In the more chronic cases there is development of much fibroid tissue, and the disease is associated with periods of temporary arrest of the tubercular process.

The expectoration from cases of pulmonary phthisis contains tubercle bacilli, and is a source of danger to healthy individuals, in whom it may produce the disease. Attendance on persons suffering from pulmonary phthisis involves very little risk of infection if proper care is taken to prevent the expectoration becoming dry and disseminated as dust; perfect cleanliness is therefore to be insisted upon in the rooms inhabited by a phthisical person. The tubercle bacilli soon lose their virulence in the presence of fresh air and sunshine, and therefore these agents are not only desirable for the direct benefit of the phthisical patient, but also are agents in preventing the development of fresh disease in healthy individuals.

Although the tubercle bacilli are the essential agents in the development of pulmonary tuberculosis, there are other conditions which must be present before they will produce the disease. It is probable that large numbers of individuals are exposed to the action of tubercle bacilli which gain entrance to the pulmonary tract, and yet do not give rise to the disease, because the conditions of their growth and multiplication do not exist. In such cases we may consider that the seed is present, but that the soil is unsuitable for its growth. Certain families appear more predisposed to tuberculosis than others.

The most important circulatory disturbances met with in the lungs are those seen in cases of dilated heart, with or without disease of the mitral valve, when engorgement of the pulmonary vessels sets up a condition of venous engorgement of the lungs. This may lead to various changes. After it has lasted a variable time, and if it is very intense, serous transudation occurs into the substance of the lung and the alveoli, and thus a condition of pulmonary dropsy or oedema is established. The venous engorgement also predisposes the subjects of such heart affections to bronchitis and pneumonia. In disease of the mitral valve, in cardiac dilatation and in simple feebleness of the heart, such as is seen in old age and after debilitating fevers, especially typhoid, there is commonly developed a venous congestion of the bases of the lungs, forming the so-called hypostatic congestion of those organs, and to this is frequently added pneumonia. In long-standing cases of pulmonary congestion brought about by disease of the mitral valve and dilatation of the heart, a certain amount of fibrous tissue may be found in the interstitial tissue of the lungs, and from transudation of certain elements of the blood we get the formation in the newly formed fibrous tissue of blood pigment. In these cases blood pigment

is found in the cells, in the pulmonary alveoli, and such cells also carry the pigment into the interstitial tissue. This condition constitutes the state known as *brown induration of the lungs*. Acute congestion of the lungs occurs as part of the first stage of pneumonia. It also probably exists during violent exertion, and may possibly be brought about by excitement.

Another circulatory disturbance of great importance is that arising from blocking of the pulmonary artery or its branches by an embolus or a thrombus. Where the obstruction takes place in the main vessel, death rapidly ensues. Where, however, a small branch of the vessel is occluded, as frequently occurs from a coagulum forming in the right side of the heart, or in the pulmonary vessels in cases of disease of the mitral valve, or in dilatation of the heart, or from the detachment of a small vegetation from disease of the tricuspid or pulmonary valves, a haemorrhagic exudation takes place, forming a patch of consolidation in the lung (*haemorrhagic infarct*). As this haemorrhagic exudation takes place not only into the substance of the lung, but also into the bronchial tubes, such lesions are usually associated with spitting of blood (*haemoptysis*). The increased tension produced in the pulmonary vessels in cases of mitral disease may also probably lead to the formation of haemorrhagic exudations into the lungs, apart from the occurrence of embolism or thrombosis. Usually the occurrence of pulmonary embolism and the formation of haemorrhagic infarcts in the lungs mark an important epoch in the course of a case of heart disease. It usually occurs at a late stage of the affection, and not infrequently contributes materially to a fatal termination. It is probable that many of the cases of pneumonia and pleuritic effusion, coming on in cases of valvular heart disease and of cardiac dilatation, owe their origin to an embolus and to the formation of a haemorrhagic infarct.

The term asthma is commonly applied to a paroxysmal dyspnoea of a special type which is associated with a variety of conditions. In true spasmodic asthma there **Asthma.** may be no detectable organic disease, and the paroxysms are generally believed to be due to a nervous influence which, acting upon the bronchial muscles, produces a spasm of the tubes, or, acting through the vaso-motor branches of the sympathetic, produces a congestion of the bronchial mucous membrane. The most probable theory is that lately advanced, that it is caused by a profound toxæmia. An organism has been isolated, which is said to be the cause of certain cases of asthma, and the fact that benefit has been said to follow treatment by a vaccine is in favour of this view. The exciting cause may not be at all apparent, even on the most careful observation and examination of the sufferer, but in other cases the attacks may be brought about by some reflex irritation. Nasal polypi and other diseases of nasal mucous membrane have been shown in some cases to be a cause of asthma. Irritation of the bronchial mucous membrane appears to be one of the most common, but it is usually difficult to say exactly in what the irritation consists.

The sputum in true asthma is typical, consisting of white translucent pellets like boiled tapioca. These pellets consist of mucus arranged in a twisted manner and known as Curschmann spirals; they also contain Charcot-Leyden crystals, degenerated epithelium and leucocytes, of which the majority are eosinophiles. The spirals consist of a central solid thread round which the mucus is arranged in spiral form. The twisting has been attributed to a rotatory motion of the cilia, helped by the spasm of the bronchial muscles. Allied to true asthma is the bronchial asthma frequently met with in the subjects of bronchitis and emphysema. In such cases the irritation evidently proceeds from the inflamed bronchial mucous membrane. Hay asthma is the variety in which the pollen of certain plants, especially grasses, is the exciting cause of the paroxysms. In cardiac feebleness, in valvular disease of the heart, and in cardiac dilatation, we may get dyspnoic attacks of a more or less

paroxysmal nature, to which the term cardiac asthma has been applied. Similarly, to a form of dyspnoea met with occasionally as a manifestation of uraemia in chronic Bright's disease the term of renal asthma has been given.

Pleurisy, or inflammation of the pleura, is a very common affection, and is met with under different forms. In many instances we have simply the pouring out, over a greater or less area of the surface of the pleura, of a fibrinous exudation which may become absorbed or undergo organisation, a certain amount of thickening of the pleura, and adhesions of the two layers resulting. Such cases form the group known as cases of dry pleurisy. In other instances a greater or lesser amount of serous exudation takes place into one or other pleural cavity, forming the cases of serous pleuritic effusion. In others the exudation into the pleural cavity is purulent, giving rise to the condition known as empyema or purulent pleuritic effusion. The occurrence of dry pleurisy is probably very frequent, and leads to small pleural adhesions which cause little or no inconvenience. In post-mortem examinations of persons who have died from various diseases it is common to find such pleural adhesions present, although they have never been suspected during life. Pleurisy in one or other of the above forms may come on in a person apparently in good health (idiopathic pleurisy), or it may follow a fracture of the ribs or other injury to the chest. It is not uncommonly secondary to some other disease; thus it is almost a constant accompaniment of acute lobar pneumonia. In such cases the effusion is most commonly a simple fibrinous one, which with the subsidence of the primary disease is in great part absorbed. In other cases of pneumonia we get a certain amount of serous effusion into the pleura; and sometimes, especially in children, the pneumonia is followed by the development of an empyema. Pleurisy with effusion is also frequently a complication of valvular heart disease and dilatation of the heart, and in such cases is often associated with the formation of superficial pulmonary infarcts. It is also seen in many other diseases of the lungs. For instance, in chronic pulmonary phthisis pleuritic adhesions over various parts of the lungs are the rule; and we also frequently get serous effusion into the pleura as a complication of the various forms of pulmonary tuberculosis. Purulent effusion is less common in phthisis, but it is the rule where the pleura is perforated by the necrosis of a tuberculous focus in the lung and the establishment of a communication between the pleura and a tuberculous cavity and the bronchial tubes (*pyopneumothorax*), a combination in which there is both air and pus in the pleural cavity. Secondary pleurisy is also seen in an extension of the disease from neighbouring parts, as from peritonitis, sub-diaphragmatic abscess, and suppuration in the liver or spleen. As a secondary disease, pleurisy is also known in the course of various forms of nephritis, rheumatism, and the acute specific diseases.

Cases formerly classed as idiopathic pleurisy are now known to be caused by certain micro-organisms. These vary in relation to the character of the effusion. The most frequent is the tubercle bacillus, which is generally present in sero-fibrinous effusions. In this case the pleurisy is really secondary to a possibly unrecognized tuberculous infection either of the lung or pleura. In purulent effusions the pneumococcus may occur as a pure infection, or the streptococcus pyogenes or the staphylococcus may be present. Mixed infections occur in 21% of purulent effusions, and varieties of other organisms, such as the influenza bacillus, the typhoid bacillus, the Klebs-Löffler bacillus and the colon bacillus, have been occasionally found.

There are at least five types of pulmonary emphysema; (1) hypertrophic, idiopathic or large-lunged emphysema; (2) senile or small-lunged emphysema; (3) compensatory emphysema; (4) acute vesicular emphysema; (5) interstitial or interlobular emphysema. Two points are usually admitted: that emphysema appears only in lungs that are congenitally weak, and that the exciting cause is increased intravascular tension. When one or more lobules are cut off from the working part of the lung the neighbouring vesicles become distended.

Should the plugging of the lobule remain permanent, typical emphysema results. This happens in illnesses inducing violent respiratory efforts, such as chronic bronchitis, whooping cough and asthma. In large-lunged emphysema the lung is excessively large, and does not collapse on opening the chest wall. Microscopically two lesions are notable. The septa between the vesicles are atrophied, many have disappeared and the vesicles have coalesced; the loss in lung tissue diminishes the vascular field of the lung and tends to imperfect aeration, whence the dyspnoea. The elastic tissue of the lung is also lost. In small-lunged emphysema there is a condition of senile atrophy. The lung is smaller than normal, and the intravascular septa are destroyed. In this case the primary cause is atrophy of the bronchi, and increased air pressure is not a factor. Compensatory emphysema is that which develops in a portion of a lung in which the other portion is the seat of a lesion, such as pneumonia. Occasionally it is merely physiological, but sometimes here too the septa undergo atrophic changes. Acute vesicular emphysema is hardly a pathological variety, and is really rapid distension coming on during an attack of asthma or angina pectoris. The variety is temporary only. Interstitial emphysema is characterized by the presence of air in the interstitial connective tissue of the lung. It is usually due to rupture of the air vesicles during paroxysms of coughing.

(T. H.*; H. L. H.)

(5) SURGERY OF THE RESPIRATORY SYSTEM

About the middle of the 19th century, Manuel Garcia demonstrated the working of the vocal cords in the living subject, by placing a flat mirror of about the size of a shilling at the back of the mouth, and throwing strong light on to it from a concave mirror fixed upon the observer's forehead. By the use of a laryngoscope and a cocaine spray the most irritable throat can now be made tolerant of the presence of the small mirror, and thus the medical man is enabled to make a prolonged and thorough examination of the interior of the larynx and even to perform delicate operations upon it. Foreign bodies which have become caught in the larynx can thus be seen and extracted, and small growths can be satisfactorily removed even from the vocal cords themselves.

A foreign body in the air-passages may be impacted above the vocal cords, and the prompt thrusting down of a finger may dislodge it and save the person from death by suffocation. If there is doubt as to the site of the impaction, and the symptoms are urgent (as is likely to be the case) immediate *laryngotomy* should be done. In this operation a tube is introduced through the crevice which can easily be felt in the middle line of the neck, between the thyroid and cricoid cartilages. The procedure is easily and quickly accomplished. It is, moreover, often resorted to when the surgeon is about to perform some extensive operation in the mouth which must needs be accompanied by free haemorrhage. Laryngotomy having been done, and the pharynx having been plugged with gauze, the air passages can be kept free of blood during the whole operation.

If the foreign body be such a thing as a button, cherry-stone, sugar-plum or coin, it may at once set up alarming symptoms of spasmodic suffocation. But when the first alarm has quieted down, the attacks are likely to be only occasional, as when the article, drawn up with the expired air, comes in contact with the under aspect of the vocal cords. It may be that in a violent fit of coughing it will be expelled, but, if not, the surgeon must be at hand ready to perform tracheotomy when the urgency of the symptoms demands it. *Tracheotomy* is the making of an opening into the trachea, the air-tube below the larynx. It is unsafe to leave a child with a foreign body loose in its windpipe, on account of the risk of sudden and fatal asphyxia. Possibly the X-rays may show its exact position and give help in its removal. But, in any case, the safest thing will be to perform tracheotomy and to leave the edges of the opening into the windpipe wide asunder, so that the object may be coughed out—the nurse being on guard all the while. The operation of tracheotomy is sometimes urgently called for in the case in

which the air-way has become blocked by a child having sucked hot water from the spout of a kettle or teapot, or in the case of obstruction by the swelling of the acute inflammation of laryngitis or of diphtheria. Should the air-way through the larynx become narrowed by the presence of a growth which does not diminish under the influence of iodide of potassium, the question may arise as to whether it should be dealt with by splitting the thyroid cartilage and holding the wings apart, or by the removal of the whole larynx. For such growths are often malignant. If the wide infection of the lymphatic glands of the neck suggests that no radical operation should be undertaken, a bent silver tube may be introduced below the growth (tracheotomy) in order to provide for the entrance of air. This will get over the difficulty of breathing, but it cannot, of course, do more than that.

Acute laryngitis is very often due to diphtheria. The symptoms are those of laryngeal obstruction, together with constitutional disturbances of various kinds. The old-fashioned nurse called the disease "croup"—a term devoid of scientific meaning (see DIPHTHERIA). In an ordinary catarrhal case, leeches and fomentations may suffice, though sometimes tracheotomy or intubation is called for. But if bacteriological examination shows the presence of diphtheritic bacilli, antitoxin must at once be injected. (See also LUNG.) (E. O. *)

RESPITE (O. Fr. *respit*, modern *répit*, Lat. *respectus*, regard, consideration, *respicere*, to look back at), properly a delay, given for the further consideration of some matter, hence relief. In law the term is used of the postponement of the immediate execution of the law in criminal cases, e.g. by binding a convicted prisoner over to come up for judgment when called upon, or when a case is "respited" from one quarter sessions to another. The word is loosely used in the sense of a "reprieve" (q.v.).

RESPOND, in architecture, the term given to the half-pier or semi-detached column at the end of a range of piers or columns carrying an architrave or arcade. In Greek temples the respond is known as the *antia*. The term is also given to the wall pilaster which in Roman and Renaissance work is frequently placed behind the detached columns forming the decoration of a wall.

RESPONDENT (from Lat. *respondere*, to answer), strictly, one who answers; in law one called upon to answer a petition or other proceeding. In a matrimonial cause the defendant in the suit is called the respondent. The defendant to a quarter sessions appeal is called the respondent, and so generally in appeals is the party, whether plaintiff or defendant, against whom the appeal is brought.

REST (O. Eng. *rast*, *rest*, bed, cognate with other Teutonic forms, e.g. Ger. *Rast*, *Rüste*, rest, and probably Gothic *Rasta*, league, i.e. resting or stopping place), a cessation from active or regular work, hence a time of relief from mental or manual labour. Specific meanings are for an interval of silence in music, marked by a sign indicating the length of the pause; for the forked support with iron-shod spike carried by the soldier till the end of the 17th century as a rest for the heavy musket; and for the support for the cue in billiards to be used when the striking ball is out of reach of the natural rest formed by the hand. In the medieval armour of the horsed man-at-arms, and later in the armour of the tournament, a contrivance was fixed to the side of the body-armour near the right arm-pit, in which the butt-end of the lance was placed to prevent the lance being driven back after striking the opponent at full charge; hence a knight, as a preliminary to the charge, "laid his lance in rest." This "rest" is a shortened form of "arrest," to check, stop, as is seen by the French equivalent, *arrêt*. Further, "rest," that which remains over and above, is derived from the French *rester*, to remain over, Lat. *restare*, to remain, literally, to stay behind. The principal specific use of this word is in commerce for the balance of undivided profit; it has thus always been the term used by the Bank of England for that which in other banks and companies is called the "reserve" (Hartley Withers, *The Meaning of Money* (1000). p. 298). The Bank of

England "rest" is never allowed to fall below £3,000,000 (see BANKS AND BANKING).

RESTIF, NICOLAS EDMÉ (1734-1806), called **RESTIF DE LA BRETONNE**, French novelist, son of a farmer, was born at Sacy (Yonne) on the 23rd of October 1734. He was educated by the Jansenists at Bicêtre, and on the expulsion of the Jansenists was received by one of his brothers, who was a curé. Owing to a scandal in which he was involved, he was apprenticed to a printer at Auxerre, and, having served his time, went to Paris. Here he worked as a journeyman printer, and in 1760 he married Anne or Agnes Lebègue, a relation of his former master at Auxerre. It was not until five or six years after his marriage that Restif appeared as an author, and from that time to his death, on the 2nd of February 1806, he produced a bewildering multitude of books, amounting to something like two hundred volumes, many of them printed with his own hand, on almost every conceivable variety of subject. Restif suffered at one time or another the extremes of poverty and was acquainted with every kind of intrigue. He drew on the episodes of his own life for his books, which, in spite of their faded sentiment, contain truthful pictures of French society on the eve of the Revolution. The most noteworthy of his works are *Le Pied de Fanchette*, a novel (1760); *Le Pornographe* (1769), a plan for regulating prostitution which is said to have been actually carried out by the Emperor Joseph II., while not a few detached hints have been adopted by continental nations; *Le Paysan parvenu* (1775), a novel with a moral purpose, though sufficiently horrible in detail; *La Vie de mon père* (1779); *Les Contemporaines* (42 vols., 1780-1785), a vast collection of short stories; *Ingénue Saxanour*, also a novel (1785); and, lastly, the extraordinary autobiography of *Monsieur Nicolas* (16 vols., 1794-1797; the last two are practically a separate and much less interesting work), in which at the age of sixty he has set down his remembrances, his notions on ethical and social points, his hatreds, and above all his numerous loves, real and fancied. The original editions of these, and indeed of all his books, have long been bibliographical curiosities owing to their rarity, the beautiful and quaint illustrations which many of them contain, and the curious typographic system in which most are composed. In 1795 he received a gratuity of 2000 francs from the government, and just before his death Napoleon gave him a place in the ministry of police, which he did not live to take up.

Restif de la Bretonne undoubtedly holds a remarkable place in French literature. He was inordinately vain, of extremely relaxed morals, and perhaps not entirely sane. His books were written with haste, and their licence of subject and language renders them quite unfit for general perusal.

The works of C. Monselet, *Réatif de la Bretonne* (1853), and P. Lacroix, *Bibliographie et iconographie* (1875), J. Assézat's selection from the *Contemporaines*, with excellent introductions (3 vols., 1875), and the valuable reprint of *Monsieur Nicolas* (14 vols., 1883-1884) will be sufficient to enable even curious readers to form a judgment of him. His life, written by his contemporary Cubières-Palmezeaux, was republished in 1875. See also Eugen Dühren, *Réatif de la Bretonne, der Mensch, der Schriftsteller, der Reformator* (Berlin, 1906), and a bibliography, *Réatif-Bibliothek* (Berlin, 1906), by the same author.

RESTOUT, JEAN (1692-1768), French painter, born at Rouen on the 26th of March 1692, was the son of Jean Restout, the first of that name, and of Marie M. Jouvenet, sister and pupil of the well-known Jean Jouvenet. In 1717, the Royal Academy having elected him a member on his work for the *Grand Prix*, he remained in Paris, instead of proceeding to Italy, exhibited at all the salons, and filled successively every post of academical distinction. He died on the 1st of January 1768. His works, chiefly altar-pieces (Louvre Museum), ceilings and designs for Gobelin tapestries, were engraved by Cochin, Drevet and others; his diploma picture may still be seen at St Cloud.

His son, JEAN BERNARD RESTOUT (1732-1797), won the *Grand Prix* in 1758, and on his return from Italy was received into the Academy; but his refusal to comply with rules led to a quarrel with that body. Roland appointed him keeper of the Garde Meuble, but this piece of favour nearly cost him his life during the Terror. The St Bruno painted by him at Rome is in the Louvre.

RESTRAINT (from "to restrain," Lat. *restringere*, to hold back, prevent), in law, a restriction or limitation. The word is used particularly in three connexions: 1. *Restraint on Anticipation*. Although it is a principle of English law that there can be no restriction of the right of alienation of property vested in any person under an instrument, equity makes an exception in the case of a married woman, and has laid down the rule that property may be so settled to the separate use of a married woman that she cannot, during coverture, alienate it or anticipate the income. Restraint on anticipation attaches only during coverture and is therefore removed on widowhood, but it may attach again on remarriage. By the Conveyancing Act 1881, s. 39, a court may however, if it thinks fit, by judgment or order bind a married woman's interest in her property, with her consent, if it appears to be for her benefit, notwithstanding that she is restrained from anticipating.

2. *Restraint of Marriage*.—A gift or bequest to a person may have a condition attached in restraint of marriage. This condition may be either general or partial. A condition in general restraint of marriage is void, as being contrary to public policy, although a condition in restraint of a second marriage is not void. A condition in partial restraint of marriage is valid, and may be either to restrain marriage with a particular class of persons, e.g. a papist, a domestic servant, or a Scotsman, or under a certain age.

3. *Restraints of Trade*.—A contract in general restraint of trade is void as being against public policy. In the leading case of *Mitchell v. Reynolds*, 1711, 1 Smith L.C., it was laid down that "it is the privilege of a trader in a free country, in all matters not contrary to law, to regulate his own mode of carrying it on according to his own discretion and choice. If the law has regulated or restrained his mode of doing this, the law must be obeyed. But no power short of the general law ought to restrain his free discretion." It has been suggested that the rule dates from a time when a covenant by a man not to exercise his own trade meant a covenant not to exercise any trade at all—every man being obliged to confine himself to the trade to which he had been apprenticed. However, contracts which are only in partial restraint of trade are good. A contract not to carry on the business of an ironmonger would be bad; but a contract made by the seller of an ironmonger's business not to compete with the buyer would be good. To make such a contract binding it must be founded on a valuable consideration and must not go beyond what is reasonably necessary for the protection of the other party. This is the tendency also of the law in the United States.

See Matthew on *Restraint of Trade* (1907).

RESZKE, JEAN DE (1850—), operatic singer, was born at Warszewo on the 14th of January 1850. His parents were Poles; his father was a state official and his mother a capable amateur singer, their house being a recognized musical centre. After singing as a boy in the Cathedral of Warsaw, he studied law in the university there, but in a few years he abandoned this and went to Italy to study singing. He made his first public appearance, as a baritone, at Venice in January 1874, as Alfonso in *La Favorita*, and in the following April he sang for the first time in London, appearing at Drury Lane Theatre, and a little later in Paris. He was not entirely successful and retired for a further period of study, during which his voice gained remarkably in the upper register; so that when he made his first reappearance at Madrid in 1879 it was as a tenor, in the title-rôle of *Robert le Diable*. Jean de Reszke's great fame as a singer dates from this time. For several seasons he sang regularly in Paris, and he reappeared at Drury Lane in 1887 as Radames. In the next year he was again in London, this time at Covent Garden as Vasco da Gama; this appearance was mainly responsible for the revival of the opera as a fashionable amusement in London. He appeared in London nearly every year from this date until 1900. In 1891 he visited America, and from 1893 to 1899 he was welcomed each year at the Metropolitan Opera House in New York. Jean de Reszke's most successful parts were the title-rôle of *Le Cid*, which was written for him by

Massenet, and those of Romeo, Lancelot in *Elaine*, and Lohengrin, Walther von Stolzing, Siegfried and Tristan in Wagner's operas. In 1904 illness compelled him to retire from the stage, and he subsequently divided his time between teaching singing in Paris and breeding race-horses in Poland.

Jean de Reszke's younger brother, EDOUARD, born at Warsaw on the 23rd of December 1855, is also famous as an operatic singer. He appeared for the first time in Paris in April 1896, and has since sung with his brother for many seasons both in London and in New York. His magnificent bass voice and admirable technique earned him fame in such parts as those of Mephistopheles in *Faust*, Charles V. in *Marchetti's Don Giovanni d' Austria*, Walter in *Tell*, the Count in *Sonnambula*, Prince Gundi in *Demonio*, and Hans Sachs, King Mark, Hunding and Hagen in Wagner's operas.

RETABLE (Fr. *rétable*, a shortened form derived from Med. Lat. *retabulum*), a term of ecclesiastical art and architecture, applied in modern English usage to an altar-ledge or shelf, raised slightly above the back of the altar or communion table, on which are placed the cross, ceremonial candlesticks and other ornaments. Retables may be lawfully used in the church of England (*Liddell & Beale*, 1866, 14 P.C.).

Foreign usage of the term, as in French, is different, and where the word is kept with this foreign application, the distinction should be observed. The Med. Lat. *retabulum* (modernized *retabulum*) was applied to an architectural feature set up at the back of an altar, and generally taking the form of a screen framing a picture, carved or sculptured work in wood or stone, or mosaic, or of a movable feature such as the famous *Pala d' Oro* in St Mark's, Venice, of gold, jewels and enamels. The foreign "rétable" is, therefore, what should in English be called a "recredos" (*q.v.*), though that is not in modern usage a movable feature.

RETAIL, the sale of goods or commodities in small quantities to the immediate consumer, opposed to a sale wholesale or in gross. The O. Fr. *retaille*, from which the word is taken, meant a piece cut off, from *tailler*, to cut, Med. Lat. *talcare*, Lat. *talca*, a rod, cutting for planting. The English meaning appears in Anglo-French and in the Italian *retaglio*, selling by the piece. The other meaning of "retail," to repeat a story, is a transferred sense of an early meaning, "to sell at second hand." The Latin source is also seen in the related words "entail," "tailor," "detail" and "tally."

RETAINER (from "retain," Lat. *retinere*, to hold back, keep), properly the act of retaining or keeping for oneself, or a person or object which retains or keeps; historically, a follower of a house or family, and particularly used of armed followers attached to the barons of the middle ages. John Cowell, in *The Interpreter* (1607), defines "retainer" as a "servant not menial nor familiar, that is, not continually dwelling in the house of his lord or master, but only using or bearing his name or livery."

Retainer of Counsel.—When it is considered desirable by a litigant that the services of any particular counsel (barrister) should be obtained for the conduct of his case, it is necessary to deposit with counsel a form of retainer together with the necessary fee in cash, from which time counsel is bound to give the party who has thus retained him the first call on his services in the matter in which he has been retained. Retainers are either *general* or *special*. A general retainer is one which retains counsel for all proceedings in which the person retaining is a party, and lasts for the joint lives of client and counsel. If any other person offers a special retainer or brief against the general retainer, counsel must give the general retainer notice of such offer—and if after a reasonable time the general retainer does not himself specially retain or brief counsel, the general retainer is forfeited. A special retainer is one which only applies to some particular cause or action. It can only be delivered after the action is begun, and gives the client a right to the services of counsel throughout the course of the action, and counsel is entitled to be briefed on all occasions to which the retainer applies. Retainer rules were drawn up in 1901 by the Bar Committee, read by the Bar Council and approved by the Attorney-General and the Council

of the Incorporated Law Society in 1902. They may be found in the *Annual Practice*.

Retainer of Debt.—In connexion with the administration of an estate under a will, it is the right of the personal representative—whether executor or administrator—of a deceased person to retain legal assets which have come into his hands towards the payment of a debt due to himself as against creditors of an equal degree, and this even though his debt is barred by the Statutes of Limitation. The privilege arose in all probability from the inability of the representative to sue himself, though it has been suggested that it is merely a corollary to the right of the representative to prefer one creditor to another of equal degree.¹ The principle of retainer is not looked upon with favour by courts of equity, and consequently it has long been the rule that there is no right to retain out of equitable assets. It was thought that the effect of the Land Transfer Act 1897 was to make all the assets of the deceased legal assets, and so extend the privilege to reality which had till then been exempt; this view, however, has been repudiated by the courts of equity, and it must now be taken that there is still no right to retain out of real estate.² It is a rule of the probate division to require a creditor administrator, to whom letters of administration are granted, to enter into a bond with two sureties not to prefer himself. This course, however, is not followed where administration is granted to a person as next of kin who happens also to be a creditor.

The privilege is not lost by judgment for an account being given in a suit by other creditors for the administration of assets, and the representative may retain out of assets which come to his hand subsequent to such judgment. On the other hand, the appointment of a receiver deprives the representative of his right except as regards assets which come to his hands prior to the appointment of the receiver.

RETALIATION, repayment of like with like, especially the return of hostile action, injuries or wrongs by similar action or injury, as in the primitive theory of punishment, an "eye for an eye," "a tooth for a tooth." The Late Lat. *retaliare* was formed from *talio*, such as, of the same quality as; and this source also gave *talio*, *talionis*, the name of this type of punishment. (See PUNISHMENT, THEORY OF, and ROMAN LAW, § *The Twelve Tables*.) A special form of retaliation is familiar in the imposition of differential import duties against the goods of a particular country (see **TARIFFS and PROTECTION**).

RETENE (methyl isopropyl phenanthrene), $C_{18}H_{18}$, a hydrocarbon present in the coal-tar fraction, boiling above $360^{\circ}C$.; it also occurs in the tars obtained by the distillation of resinous woods. It crystallizes in large plates, which melt at $98.5^{\circ}C$. and boil at $390^{\circ}C$. It is readily soluble in warm ether and in hot glacial acetic acid. Sodium and boiling amyl alcohol reduce it to a tetrahydroretene, whilst if it be heated with phosphorus and hydriodic acid to $260^{\circ}C$. a dodecahydride is formed. Chromic acid oxidizes it to retene quinone, phthalic acid and acetic acid. It forms a picrate which melts at $123-124^{\circ}C$.

RETFORD (officially **EAST RETFORD**), a market town and municipal borough in the Bassetlaw parliamentary division of Nottinghamshire, England, $13\frac{1}{2}$ m. N. by W. from London by the Great Northern railway, the station being a junction with the Great Central railway. Pop. (1901) 12,340. The church of St Swithin dates from the 13th century, but was rebuilt in 1658 by a brief granted by Richard Cromwell. Modern buildings are the town hall, the corn exchange, the court house, and the covered markets. There is a large trade in corn and cheese, and the town possesses iron foundries, paper and corn mills, and india-rubber works. The town is governed by a mayor, 6 aldermen, and 18 councillors. Area, 4656 acres.

The situation of Retford (*Redford*, *Ratford*), near one of the Roman roads and on the river Idle, where there was possibly a ford, may account for its origin. In 1086 the archbishop of York

owned a mill at Retford, and Roger de Busli had rights here. Retford was a borough by prescription, and was in the hands of the crown when, in 1276, Edward I. granted it to the burgesses in fee-farm with the right of electing bailiffs. This charter was confirmed by Edward III., Henry VI. and Elizabeth. In 1607 James I. granted a charter of incorporation to the bailiffs and burgesses, under which the town was governed until 1835, when it was reincorporated under a mayor. East Retford returned two members to parliament in 1315, and again from 1572 till 1885, when it was disfranchised. Henry III. granted the burgesses an eight-days' fair at Holy Trinity, altered by Edward II. to St Gregory. Edward III. granted a six-days' fair at St Margaret, and Henry VI. a four-days' fair at St Matthew. Fairs are now held in March, June, July and December. The market held on Saturdays by prescription was sanctioned by Edward III. and still exists.

RETHEL, ALFRED (1816-1859), German historical painter, was born at Aix-la-Chapelle in 1816. He very early showed an interest in art, and at the age of thirteen he executed a drawing which procured his admission to the academy of Düsseldorf. Here he studied for several years, and produced, among other works, a figure of St Boniface which attracted much attention. At the age of twenty he removed to Frankfort, and was selected to decorate the walls of the imperial hall in the Römer with figures of famous men. At the same period he produced a series of designs illustrative of Old Testament history. Four years later he was the successful competitor for the work of ornamenting the restored council house of his native city with frescoes depicting prominent events in the career of Charlemagne, but the execution of this work was delayed for some six years. Meanwhile Rethel occupied himself with the production of easel pictures and of drawings; and in 1842 he began a striking series of designs dealing with the "Crossing of the Alps by Hannibal," in which the weird power which animates his later art becomes first apparent. In 1844 Rethel visited Rome, executing, along with other subjects, an altar-piece for one of the churches of his native land. In 1846 he returned to Aix, and commenced his Charlemagne frescoes. But mental derangement, remotely attributable, it is believed, to an accident from which he suffered in childhood, began to manifest itself. While he hovered between madness and sanity, Rethel produced some of the most striking, individual and impressive of his works. Strange legends are told of the effect produced by some of his weird subjects. He painted "Nemesis pursuing a Murderer"—a flat stretch of landscape, with a slaughtered body, while in front is the assassin speeding away into the darkness, and above an angel of vengeance. The picture, so the story goes, was won in a lottery at Frankfort by a personage of high rank, who had been guilty of an undiscovered crime, and the contemplation of his prize drove him mad. Another design which Rethel executed was "Death the Avenger," a skeleton appearing at a masked ball, scraping daintily, like a violinist, upon two human bones. The drawing haunted the memory of his artist friends and disturbed their dreams; and, in expiation, he produced his pathetic design of "Death the Friend." Rethel also executed a powerful series of drawings—"The Dance of Death"—suggested by the Belgian insurrections of 1848. It is by such designs as these, executed in a technique founded upon that of Dürer, and animated by an imagination akin to that of the elder master, that Rethel is most widely known. He died at Düsseldorf on the 1st of December 1859.

His picture of "Peter and John at the Beautiful Gate of the Temple," is preserved in the Leipzig Museum, and his "St Boniface" and several of his cartoons for the frescoes at Aix in the Berlin National Gallery. His *Life*, by Wolfgang Müller von Königswinter, was published in 1861. See also *Art Journal*, November 1865.

RETHEL, a town of N. France, capital of an arrondissement in the department of Ardennes, on the right bank of the Aisne and the Ardennes canal, 31 m. S.W. of Mézières by rail. Pop. (1906) 5254. The church of St Nicholas was formed by the amalgamation of two churches, the oldest of which dates from the 13th century. Rethel has a subprefecture, a tribunal of first instance, a board of trade arbitration, a chamber of arts and manufactures and a school of agriculture, and carries on

¹ Per *Jessel*, M.R. *Talbot v. Frere* (1879), L.R. 9. C.D. 568, 574.

² *In re Williams*; *Holder v. Williams* (1904), 1 Ch. 52.

wool-spinning, the weaving of light woollen fabrics, and the manufacture of millboard and farm implements.

Rethel (*Castrum Relectum*), of Roman origin, was from the end of the 10th century the seat of a countship which passed successively to the families of Flanders, Burgundy, Cleves, Foix and Gonzaga. In 1581 it was erected into a duchy in favour of the latter. In 1663 it was sold by Charles VI. de Gonzaga to Mazarin, whose family held it till the Revolution.

RETINITE (Gr. *ῥηίνη*, resin), a general name applied to various resins, particularly those from beds of brown coal, which are near amber in appearance, but contain little or no succinic acid. It may conveniently serve as a generic name, since no two independent occurrences prove to be alike, and the indefinite multiplication of names, no one of them properly specific, is not to be desired.

RETINUE (O. Fr. *retenue*, from *retenir*, Lat. *retinere*, hold back, retain), a body of persons "retained" in the service of a noble or royal personage, a suite of "retainers." Such retainers were not in the domestic service of their lord, but were his "livery" and claimed his protection. They were a source of trouble and abuse in the 15th and early 16th century (see **LIVERY** and **MAINTENANCE**).

RETORT (Lat. *retorque*, to twist or turn back), a word used in two distinct meanings: (1) a sharp reply, answer to an argument, statement or charge; (2) a vessel used in chemistry and manufacture. The chemical retort is a flask-shaped or bulbous vessel made of glass, earthenware or metal, with a neck, bent downwards, which leads to a receiver; such vessels are particularly used for distillation (q.v.). The name is also given to the apparatus, varying in size and shape, used in the distinctive distillation of various substances, such as coal, in the manufacture of gas (q.v.).

RETREAT (O. Fr. *retrête*, mod. *trêvaille*, from Lat. *retrahere*, to draw back), a withdrawal, especially of a body of troops after a defeat or in face of a superior enemy. In military usage "retreat" is also the term for a signal, given by bugle and drum at or about sunset. It is the last general signal before "tattoo." In religious usage, a "retreat" is a period and place set apart for prayer, self-examination and other spiritual exercises. Such "retreats" conducted by a director have long been the practice in the Roman Church. They were introduced into the English Church by Pusey. The word is also used of an institution or home where insane persons or habitual inebriates may be treated. For the law relating to "licensed retreats" for inebriates, see **INEBRIETY**, **LAW OF**.

RETRENCHMENT (Fr. *retrenchement*, an old form of *retrenchement*, from *retrancher*, to cut down, cut short), an act of cutting down or reduction, particularly of expenditure; the word is familiar in this, its most general sense, from the motto of the Gladstonian Liberal party in British politics, "Peace, Retrenchment and Reform." A special technical use of the term is in fortification, where it is applied to a work or series of works constructed in rear of existing defences in order to bar the further progress of the enemy should he succeed in breaching or storming these. A modern example may be found in the siege of Port Arthur in 1904. When early in the siege Fort Panlung fell into the hands of the Japanese, the Russians connected up the two adjacent first-line forts to a fort in the rear by means of new works, the whole forming a rough semicircle facing the lost fort. This retrenchment prevented the Japanese from advancing, and remained in the hands of the defenders up to the fall of the whole line of forts.

RETRO-COGNITION (from Lat. *retro*, back, *cognitio*, the acquiring of knowledge), a word invented by F. W. H. Myers to denote a supposed faculty of acquiring direct knowledge of the past beyond the reach of the subject's ordinary memory. The alleged manifestations of the faculty are of several kinds, of which the most important are as follows: (1) There are many recorded cases in which an impression has been received in dream or vision representing some recent event—shipwreck, death-bed scene, railway accident—outside the knowledge of the percipient. (2) Analogous to the transmission of habits

and physical peculiarities in particular families, it is alleged that there are also cases of the transmission of definite memories of scenes and events in the life of some ancestor. (3) It is asserted that pictures of past scenes may be called up in certain cases by the presence of a material object associated with those scenes—e.g. a vision of the destruction of Pompeii by a piece of cinder from the buried city, or the scene of a martyrdom by a charred fragment of bone—the percipient being unaware at the time of the nature of the object. For this supposed faculty the American geologist, Professor Denton, has suggested the name "psychometry." There are also cases recorded in which pictures of historical scenes unknown to the seer have been described in the crystal. (4) Some spirit mediums profess to realise incidents belonging to their previous incarnation. Thus Flournoy's medium, Hélène Smith, represented herself as having been successively incarnated as a Hindoo Princess, Simandini, and as Marie Antoinette, and gave vivid descriptions of scenes in which she had figured in these capacities.

It will be gathered that the facts afford little warrant for the assumption of a faculty of retro-cognition. The cases described in the first class, though apparently exhibiting knowledge not within the range of the percipient's ordinary faculties, hardly call for such an extreme hypothesis. In the other cases the result recorded may plausibly be attributed to the imagination of the percipient, working upon hints given by bystanders, or aided by the emergence of forgotten knowledge.

BIBLIOGRAPHY.—See W. Denton, *The Soul of Things* (Wellesley, Mass., U.S.A., 1863); F. W. H. Myers, article "The Subliminal Self" in *Proc. S. P. R.* vol. xi. *Human Personality* (London, 1903); Th. Flournoy, *Des Indes à la planète Mars* (Geneva, 1900).

(F. P.)

RETROGRADE (from the Lat. *retro*, backwards, *gradiri*, to go), in astronomy, the direction of the apparent motion of a planet from E. to W.; the opposite of its regular motion around the sun, and due to the motion of the earth.

RETZ, SEIGNEURS AND DUKES OF. The district of Retz or Rais, in S. Brittany, belonged in early times to a house which bore its name, and of which the eldest branch became extinct in the 13th century in the Chabot family. From the Chabot family the lordship passed to the Lavals. Gilles de Laval, sire de Retz (1404-1440), the comrade-in-arms of Joan of Arc and marshal of France, gave himself over to the most revolting debauchery, and was strangled and burned at Nantes. The barony of Retz passed successively to the families of Tournemine, Annebaut and Gondi. In 1581 it was erected into a duchy in the peerage of France (*duché-pairie*) for Albert de Gondi, marshal of France and general of the galleys. Pierre de Gondi, brother of the first duc de Retz, became bishop of Paris in 1570 and cardinal in 1587. He was succeeded by his nephews, Henri (d. 1622) and Jean François de Gondi (d. 1654), for whom the episcopal see of Paris was erected into an archbishopric in 1622, and by his great-nephew, Jean François Paul de Gondi, the famous cardinal de Retz. With the death of the last male of the house of Gondi in 1676 the *duché-pairie* became extinct; the lordship passed to the house of Neuville-Villeroy.

(M. P.)

RETZ, JEAN FRANÇOIS PAUL DE GONDI, CARDINAL DE (1614-1679), French churchman and agitator, was born at Montmirail in 1614. The family was one of those which had been introduced into France by Catherine de' Medici, but it acquired great estates in Brittany and became connected with the noblest houses of the kingdom. It may be added that Retz himself always spelt his designation "Rais." He was the third son, and according to Tallemant des Réaux was made a knight of Malta on the very day of his birth. The death of his second brother, however, destined him for a closer connexion with the church. The family of Retz had military traditions, but it had also much church influence, and, despite the very unclerical leanings of the future cardinal, which were not corrected by the teachings of his tutor St Vincent de Paul, the intentions of his family never varied respecting him. By unanimous consent his physical appearance was not that of a soldier. He was

short, near-sighted, ugly and exceptionally awkward. Retz, however, despite the little inclination which he felt towards clerical life, entered into the disputes of the Sorbonne with vigour, and when he was scarcely eighteen wrote the remarkable *Conjuration de Fiesque*, a little historical essay, of which he drew the material from the Italian of Augustino Mascardi, but which is all his own in the negligent vigour of the style and the audacious insinuation, if nothing more, of revolutionary principles. Retz received no preferment of importance during Richelieu's life, and even after the minister's death, though he was presented to Louis XIII. and well received, he found a difficulty in attaining the coadjutorship with reversion of the archbishopric of Paris. But almost immediately after the king's death Anne of Austria appointed him to the coveted post on All Saints' Eve, 1643. Retz, who had, according to some accounts, already plotted against Richelieu, set himself to work to make the utmost political capital out of his position. His uncle, who was old, indolent and absurdly proud, had lived in great seclusion; Retz, on the contrary, gradually acquired a very great influence with the populace of the city. This influence he gradually turned against Mazarin. No one had more to do than Retz with the outbreak of the Fronde in October 1648, and his history for the next four years is the history of that confused and, as a rule, much misunderstood movement. Of the two parties who joined in it Retz could only depend on the bourgeoisie of Paris. The fact, moreover, that although he had some speculative tendencies in favour of popular liberties, and even perhaps of republicanism, he represented no real political principle, inevitably weakened his position, and when the break up of the Fronde came he was left in the lurch, having more than once in the meanwhile been in no small danger from his own party. One stroke of luck, however, fell to him before his downfall. He was made cardinal almost by accident, and under a misapprehension on the pope's part. Then, in 1652, he was arrested and imprisoned, first at Vincennes, then at Nantes; he escaped, however, after two years' captivity, and for some time wandered about in various countries. He made his appearance at Rome more than once, and had no small influence in the election of Alexander VII. He was at last, in 1662, received back again into favour by Louis XIV. and on more than one occasion formally served as envoy to Rome. Retz, however, was glad in making his peace to resign his claims to the archbishopric of Paris. The terms were, among other things, his appointment to the rich abbacy of St Denis and his restoration to his other benefices with the payment of arrears.

The last seventeen years of Retz's life were passed partly in his diplomatic duties (he was again in Rome at the papal election of 1668), partly at Paris, partly at his estate of Commercy, but latterly at St Mihiel in Lorraine. His debts were enormous, and in 1675 he resolved to make over to his creditors all his income except twenty thousand livres, and, as he said, to "live for" them. This plan he carried out, though he did not succeed in living very long, for he died at Paris on the 24th August 1679. One of the chief authorities for the last years of Retz is Madame de Sévigné, whose connexion he was by marriage.

Retz and La Rochefoucauld, the greatest of the Frondeurs in literary genius, were personal and political enemies, and each has left a portrait of the other. La Rochefoucauld's character of the cardinal is on the whole harsh but scarcely unjust, and one of its sentences formulates, though in a manner which has a certain recoil upon the writer, the great defect of Retz's conduct: "Il a suscité les plus grands désordres dans l'état sans avoir un dessein formé de s'en prévaloir." He would have been less, and certainly less favourably, remembered if it had not been for his *Memoirs*. They were certainly not written till the last ten years of his life, and they do not go further than the year 1655. They are addressed in the form of narrative to a lady who is not known, though guesses have been made at her identity, some even suggesting Madame de Sévigné herself. In the beginning there are some gaps. They display, in a rather irregular style and with some oddities of dialect and phrase, extraordinary narrative skill and a high degree of ability in that special art

of the 17th century—the drawing of verbal portraits of characters. Few things of the kind are superior to the sketch of the early barricade of the Fronde in which the writer had so great a share, the hesitations of the court, the bold adventure of the coadjutor himself into the palace and the final triumph of the insurgents. Dumas, who has drawn from this passage one of his very best scenes in *Vingt ans après*, has done little but throw Retz into dialogue and amplify his language and incidents. Besides these memoirs and the very striking youthful essay of the *Conjuration de Fiesque*, Retz has left diplomatic papers, sermons, Mazarinades and correspondence in some considerable quantity.

The *Memoirs* of the cardinal de Retz were first published in a very imperfect condition in 1717 at Nancy. The first satisfactory edition was that which appeared in the twenty-fourth volume of the collection of Michaud and Poujoulat (Paris, 1836). They were then re-edited from the autograph manuscript by Gêruzez (Paris, 1844) and by Champollion-Figeac with the Mazarinades, &c. (Paris, 1859). In 1870 a complete edition of the works of Retz was begun by M. A. Feillet in the collection of *Grands Écrivains*. The editor dying, this passed into the hands of M. Gourdault and then into those of M. Chantelauze, who had already published studies on the connexion of St Vincent de Paul with the Gond family, &c. (1882). (G. SA.)

REUBEN, a tribe of Israel named after the eldest "son" of Jacob and of Leah. Both the meaning of the name (see Gen. xxix. 32) and the history of the tribe are extremely obscure. In one version of the story of Joseph, Reuben appears in a somewhat favourable light (Gen. xxvii. 22, 29, xli. 37), but in Gen. xxv. 22 he is charged with a grave offence, which in Gen. xlix. 4 is given as a reason why the tribe which called him father did not take in Hebrew history the place proper to its seniority (cp. 1 Chron. v. 1). Dathan and Abiram were Reubenites (Num. xvi.; Deut. xi. 6), and in Deut. xxxiii. 6 the tribe appears as threatened with extinction. In Judg. v. 15 seq. it is described as a pastoral tribe which took no share in the patriotic movement under Barak and Deborah. The district allotted to Reuben (Josh. xiii. 15-23; Num. xxxii. 37 seq.) is detailed in late passages which have little historical value for the age to which they are attributed. The tribe is represented as settled E. of the Jordan on the Moabite border, but no mention is made of it in the inscription of the Moabite king Mesha (see GAD; MOAB). The references to the tribe's wars against Arabians (1 Chron. v. 10, 18 seq.) in the time of Saul have caused much fruitless speculation.

For mythological elements in the tribe's history, see especially E. Stucken, *Mittheil. d. vorderasiat. Gesell.* (1902), pt. iv. pp. 46 sqq.; and for a full discussion of the biblical data, see H. W. Hogg, *Encyc. Bib. sc.*, also E. Meyer, *Die Israeliten und ihre Nachbarstämme*, pp. 59 sqq.

REUCHLIN, JOHANN (1455-1522), German humanist and Hebraist, was born on the 22nd of February 1455 at Pforzheim in the Black Forest, where his father was an official of the Dominican monastery. In the pedantic taste of his time the name was graecized by his Italian friends into Capnio, a form which Reuchlin himself uses as a sort of transparent mask when he introduces himself as an interlocutor in the *De Verbo Mirifico*. For his native place Reuchlin always retained an affection; he constantly writes himself Phorcens, and in the *De Verbo* he does not forget to ascribe to Pforzheim his first disposition to letters. Here he began his Latin studies in the monastery school, and, though in 1470 he was a short time in Freiburg, that university seems to have taught him little. Reuchlin's career as a scholar appears to have turned almost on an accident; his fine voice gained him a place in the household of Charles I., margrave of Baden, and by-and-by, having already some reputation as a Latinist, he was chosen to accompany to the university of Paris Frederick, the third son of the prince, a lad some years his junior, who was destined for an ecclesiastical career. This new connexion lasted but a year or so, but it determined the course of Reuchlin's life. He now began to learn Greek, which had been taught in the French capital since 1470, and he also attached himself to the leader of the Paris realists, Jean Heynlin, or à Lapide (d. 1496), a

worthy and learned man, whom he followed to the vigorous young university of Basel in 1474. At Basel Reuchlin took his master's degree (1477), and began to lecture with success, teaching a more classical Latin than was then common in German schools, and also explaining Aristotle in Greek. His studies in this language had been continued at Basel under Andronicus Contoblacas, and here too he formed the acquaintance of the bookseller, Johann Amorbach, for whom he prepared a Latin lexicon (*Vocabularius Breuiquous*, 1st ed., 1475-76), which did good service in its time and ran through many editions. This first publication and Reuchlin's account of his teaching at Basel in a letter to Cardinal Adrian (Adriano Castelles) in February 1518 show that he had already found the work which in a larger sphere occupied his whole life. He was no original genius, but a born teacher. But this work of teaching was not to be done mainly from the professor's chair. Reuchlin soon left Basel to seek further Greek training with George Hieronymus at Paris, and to learn to write a fair Greek hand that he might support himself by copying MSS. And now he felt that he must choose a profession. His choice fell on law, and he was thus led to the great school of Orleans (1478), and finally to Poitiers, where he became licentiate in July 1481. From Poitiers Reuchlin went in December 1481 to Tübingen with the intention of becoming a teacher in the university, but his friends recommended him to Count Eberhard of Württemberg, who was about to journey to Italy and required an interpreter. Reuchlin was selected for this post, and in February 1482 left Stuttgart for Florence and Rome. The journey lasted but a few months, but it brought the German scholar into contact with several learned Italians, especially at the Medicæan Academy in Florence; his connexion with the count became permanent, and after his return to Stuttgart he received important posts at Eberhard's court. About this time he appears to have married, but little is known of his married life. He left no children; but in later years his sister's grandson Melanchthon was almost as a son to him till the Reformation estranged them. In 1490 he was again in Italy. Here he saw Pico della Mirandola, to whose Cabalistic doctrines he afterwards became heir, and also made the friendship of the pope's secretary, Jakob Questenberg, which was of service to him in his later troubles. Again in 1492 he was employed on an embassy to the emperor Frederick at Linz, and here he began to read Hebrew with the emperor's Jewish physician Jakob ben Jehiel Loans. He knew something of this language before, but Loans's instruction laid the basis of that thorough knowledge which he afterwards improved on his third visit to Rome in 1498 by the instruction of Obadja Sforno of Cesena. In 1494 his rising reputation had been greatly enhanced by the publication of *De Verbo Mirifico*.

In 1496 Eberhard of Württemberg died, and enemies of Reuchlin had the ear of his successor, Duke Eberhard. He was glad, therefore, hastily to follow the invitation of Johann von Dalberg (1445-1503), the scholarly bishop of Worms, and flee to Heidelberg, which was then the seat of the "Rhenish Society." In this court of letters Reuchlin's appointed function was to make translations from the Greek authors, in which his reading was already extremely wide. Though Reuchlin had no public office as teacher, and even at Heidelberg was prevented from lecturing, he was during a great part of his life the real centre of all Greek teaching as well as of all Hebrew teaching in Germany. To carry out this work he found it necessary to provide a series of helps for beginners and others. He never published a Greek grammar, though he had one in MS. for use with his pupils, but he put out several little elementary Greek books. Reuchlin, it may be noted, pronounced Greek as his native teachers had taught him to do, i.e. in the modern Greek fashion. This pronunciation, which he defends in *Dialogus de Recla Lat. Græcicæ Serm. Prom.* (1519), came to be known, in contrast to that used by Erasmus, as the Reuchlinian.

At Heidelberg Reuchlin had many private pupils, among whom Franz von Sickingen is the best known name. With the monks he had never been liked; at Stuttgart also his great enemy was the Augustinian Conrad Holzinger. On this man he

took a scholar's revenge in his first Latin comedy *Sergius*, a satire on worthless monks and false relics.

Through Dalberg, Reuchlin came into contact with Philip, elector palatine of the Rhine, who employed him to direct the studies of his sons, and in 1498 gave him the mission to Rome which has been already noticed as fruitful for Reuchlin's progress in Hebrew. He came back laden with Hebrew books, and found when he reached Heidelberg that a change of government had opened the way for his return to Stuttgart, where his wife had remained all along. His friends had now again the upper hand, and knew Reuchlin's value. In 1500, or perhaps in 1502, he was given a very high judicial office in the Swabian League, which he held till 1512, when he retired to a small estate near Stuttgart.

For many years Reuchlin had been increasingly absorbed in Hebrew studies, which had for him more than a mere philological interest. Though he was always a good Catholic, and even took the habit of an Augustinian monk when he felt that his death was near, he was too thorough a humanist to be a blind follower of the church. He knew the abuses of monkish religion, and was interested in the reform of preaching as shown in his *De Arte Predicandi* (1503)—a book which became a sort of preacher's manual; but above all as a scholar he was eager that the Bible should be better known, and could not tie himself to the authority of the Vulgate. The key to the *Hebraea veritas* was the grammatical and exegetical tradition of the medieval rabbins, especially of David Kimhi, and when he had mastered this himself he was resolved to open it to others. In 1506 appeared his epoch-making *De Rudimentis Hebraicis*—grammar and lexicon—mainly after Kimhi, yet not a mere copy of one man's teaching. The edition was costly and sold slowly. One great difficulty was that the wars of Maximilian I., in Italy prevented Hebrew Bibles coming into Germany. But for this also Reuchlin found help by printing the Pentential Psalms with grammatical explanations (1512), and other helps followed from time to time. But his Greek studies had interested him in those fantastical and mystical systems of later times with which the Cabbala has no small affinity. Following Pico, he seemed to find in the Cabbala a profound theosophy which might be of the greatest service for the defence of Christianity and the reconciliation of science with the mysteries of faith—an unhappy delusion indeed, but one not surprising in that strange time of ferment. Reuchlin's mystico-cabalistic ideas and objects were expounded in the *De Verbo Mirifico*, and finally in the *De Arte Cabalistica* (1517).

Unhappily many of his contemporaries thought that the first step to the conversion of the Jews was to take from them their books. This view had for its chief advocate the bigoted Johann Pfefferkorn (1469-1521), himself a baptized Hebrew. Pfefferkorn's plans were backed by the Dominicans of Cologne; and in 1509 he got from the emperor authority to confiscate all Jewish books directed against the Christian faith. Armed with this mandate, he visited Stuttgart and asked Reuchlin's help as a jurist and expert in putting it into execution. Reuchlin evaded the demand, mainly because the mandate lacked certain formalities, but he could not long remain neutral. The execution of Pfefferkorn's schemes led to difficulties and to a new appeal to Maximilian. In 1510 Reuchlin was summoned in the name of the emperor to give his opinion on the suppression of the Jewish books. His answer is dated from Stuttgart, October 6, 1510; in it he divides the books into six classes—apart from the Bible which no one proposed to destroy—and, going through each class, he shows that the books openly insulting to Christianity are very few and viewed as worthless by most Jews themselves, while the others are either works necessary to the Jewish worship, which was licensed by papal as well as imperial law, or contain matter of value and scholarly interest which ought not to be sacrificed because they are connected with another faith than that of the Christians. He proposed that the emperor should decree that for ten years there be two Hebrew chairs at every German university for which the Jews should furnish books. The other experts proposed that all books

should be taken from the Jews; and, as the emperor still hesitated, the bigots threw on Reuchlin the whole blame of their ill success. Pfefferkorn circulated at the Frankfurt fair of 1511 a gross libel (*Handspiegel wider und gegen die Juden*) declaring that Reuchlin had been bribed; and Reuchlin retorted as warmly in the *Augenspiegel* (1511). His adversary's next move was to declare the *Augenspiegel* a dangerous book; the Cologne theological faculty, with the inquisitor Jakob von Hochstraten (d. 1527) took up this cry, and on the 7th of October 1512 they obtained an imperial order confiscating the *Augenspiegel*. Reuchlin was timid, but he was honesty itself. He was willing to receive corrections in theology, which was not his subject, but he could not unsay what he had said; and as his enemies tried to press him into a corner he met them with open defiance in a *Defensio contra Calumniatores* (1513). The universities were now appealed to for opinions, and were all against Reuchlin. Even Paris (August 1514) condemned the *Augenspiegel*, and called on Reuchlin to recant. Meantime a formal process had begun at Mainz before the grand inquisitor, but Reuchlin by an appeal succeeded in transferring the question to Rome. Judgment was not finally given till July 1516; and then, though the decision was really for Reuchlin, the trial was simply quashed. The result had cost Reuchlin years of trouble and no small part of his modest fortune, but it was worth the sacrifice. For far above the direct importance of the issue was the great stirring of public opinion which had gone forward. And if the obscurantists escaped easily at Rome, with only a half condemnation, they received a crushing blow in Germany. No party could survive the ridicule that was poured on them in the *Epistolae Obscurorum Virorum*, the first volume of which written chiefly by Crotus Rubianus appeared in 1524, and the second by Ulrich von Hutten in 1517. Hutten and Franz von Sickingen did all they could to force Reuchlin's enemies to a restitution of his material damages; they even threatened a feud against the Dominicans of Cologne and Spiers. In 1520 a commission met in Frankfurt to investigate the case. It condemned Hochstraten. But the final decision of Rome did not indemnify him. The contest ended, however; public interest had grown cold, absorbed entirely by the Lutheran question, and Reuchlin had no reason to fear new attacks. Reuchlin did not long enjoy his victory in peace. In 1519 Stuttgart was visited by famine, civil war and pestilence. From November of this year to the spring of 1521 the veteran statesman sought refuge in Ingolstadt and taught there for a year as professor of Greek and Hebrew. It was forty-one years since at Poitiers he had last spoken from a public chair; but the old man of sixty-five had not lost his gift of teaching, and hundreds of scholars crowded round him. This gleam of autumn sunshine was again broken by the plague; but now he was called to Tübingen and again spent the winter of 1521-22 teaching in his own systematic way. But in the spring he found it necessary to visit the baths of Liebenzell, and here he was seized with jaundice, of which he died on the 30th of June 1522, leaving in the history of the new learning a name only second to that of his younger contemporary Erasmus.

The authorities for Reuchlin's life are enumerated in L. Geiger, *Johann Reuchlin* (1871), which is the standard biography. The controversy about the books of the Jews is well sketched by D. F. Strauss, *Ulrich von Hutten*. See also S. A. Hirsch, "John Reuchlin, the Father of the Study of Hebrew among the Christians," and his "John Pfefferkorn and the Battle of Books," in *Essays* (London, 1905). Some interesting details about Reuchlin are given in the autobiography of Conrad Pellicanus (*q.v.*), which was not published when Geiger's book appeared. See also the article on Reuchlin in Herzog-Hauck, *Realencyclopädie*, and literature there cited.

(W. R. S.)

REUMONT, ALFRED VON (1808-1887), German scholar and diplomatist, the son of Gerhard Reumont (1765-1829), was born on the 15th of August 1808 and was named Alfred after the English king, Alfred the Great. Educated at the universities of Bonn and Heidelberg, he obtained a position in Florence through the influence of an Englishman, William Craufurd, but soon he entered the Prussian diplomatic service and was employed in

Florence, in Constantinople and in Rome. He also spent some time in the Foreign Office in Berlin. From 1851 to 1860 he represented his country in Florence. Reumont was the friend and adviser of Frederick William IV. In 1879 he founded the *Aachener Geschichtsverein*, and having spent his concluding years at Bonn and at Aix-la-Chapelle, he died in the latter city on the 27th of April 1887.

Reumont's numerous writings deal mainly with Italy, in which country he passed many years of his life. On the history of Florence and of Tuscany he wrote *Tavola cronologica e sinchrona della storia fiorentina* (1841; Supplement, 1878); *Geschichte Toscanas seit dem Ende des florentinischen Freistaats* (Gotha, 1876-77); and *Lorenzo de' Medici* (Leipzig, 1874, and again 1883). This last book has been translated into English by R. Harrison (1876). He remembered his connexion with Florence when he wrote *Römische Briefe von einem Florentiner* (Leipzig, 1840-44), and his residence in Rome was also responsible for his *Geschichte der Stadt Rom* (3 vols., 1867-70). Turning his attention to the history of Naples, he wrote *Die Carafa von Maddaloni: Neapel unter spanischer Herrschaft* (1851; Eng. trans., 1854), and more general works on Italian history are: *Beiträge zur italienischen Geschichte* (6 vols., Berlin, 1853-57), and *Charakterbilder aus der neueren Geschichte Italiens* (1866). More strictly biographical in their nature are: *Die Jugend Caterinas de' Medici* (1854), which has been translated into French by A. Baschet (1866); *Die Gräfin von Albany* (1860) and a life of his close friend Capponi, *Gino Capponi, ein Zeit- und Lebensbild* (Gotha, 1880). His *Ganganelli: Papst Clemens XIV., seine Briefe und seine Zeit* (Berlin, 1847) is valuable for the relations between this pope and the Jesuits. Other works which may be mentioned are *Zeitgenossen, Biographien und Charakteristiken* (Berlin, 1862); *Bibliographia dei lavori pubblicati in Germania sulla storia d'Italia* (Berlin, 1863); *Biographische Denkwürdiger nach persönlichen Erinnerungen* (Leipzig, 1878); and *Saggi di storia e letteratura* (Florence, 1880). Reumont's other important work, one which he was peculiarly fitted to write, was his *Aus Friedrich Wilhelms IV. gesunden und kranken Tagen* (Leipzig, 1885).

See H. Hüter, *Alfred von Reumont* (Cologne, 1904); and the same writer's article in the *Allgemeine Deutsche Biographie*, Band xxviii. (1889).

REUNION, known also by its former name **BOURBON**, an island and French colony in the Indian Ocean, 400 m. S.E. of Tamatave, Madagascar, and 130 S.W. of Port Louis, Mauritius. It is elliptic in form; its greatest length is 45 m. and its greatest breadth 32 m., and it has an area of 965 sq. m. It lies between 20° 51' and 21° 22' S. and 55° 15' and 55° 54' E.

The coast-line (about 130 m.) is little indented, there are no natural harbours and no small islets round the shore. The narrow coast-lands are succeeded by hilly ground which in turn gives place to mountain masses and tableland, which occupy the greater part of the island. The main axis runs N.W. and S.E., and divides the island into a windward (E.) district and a leeward (W.) district, the dividing line being practically that of the watershed. The form of the mountains is the result of double volcanic action. First there arose from the sea a mountain whose summit is approximately represented by Piton des Neiges (10,069 ft.), a denuded crater of immense proportions, and at a later date another crater opened towards the E., which, piling up the mountain mass of Le Volcan, turned what was till then a circle into an ellipse. The oldest erupted rocks belong to the type of the andesites; the newest are varieties of basalt. The two massifs are united by high tablelands. In the older massif the most striking features are now three areas of subsidence—the cirques of Salazie, Rivière des Galets and Cilaos—which lie N.W. and S. of the Piton des Neiges. The first, which may be taken as typical, is surrounded by high almost perpendicular walls of basaltic lava, and its surface is rendered irregular by hills and hillocks of débris fallen from the heights. Towards the S. lies the vast stratum of rocks (150 to 200 ft. deep) which, on the 26th of November 1875, suddenly sweeping down from the Piton des Neiges and the Gros Morne (a "shoulder" of the *piton*), buried the little village of Grand Sable and nearly a hundred of its inhabitants. Besides the Piton des Neiges and the Gros Morne the chief heights in this part of the island are the pyramidal Cimandef (7300 ft.), another shoulder of the *piton*, and the Grand Brand (9490 ft.), separating the cirques of Mafate and Cilaos.

The second massif, Le Volcan, is cut off from the rest of the island by two "enclosures," each about 500 or 600 ft. deep.

The outer enclosure runs across the island in a N. and S. direction; the inner forms a kind of parabola with its arms (Rempart du Tremblet on the S. and Rempart du Bois Blanc on the N.) stretching E. to the sea and embracing not only the volcano proper but also the great eastward slope known as the Grand Brûlé. The 30 m. of mountain wall round the volcano is perhaps unique in its astonishing regularity. It encloses an area of about 40 sq. m. known as the Grand Enclos. There are two principal craters, each on an elevated cone,—the more westerly, now extinct, known as the Bory Crater (8612 ft.), after Bory de St Vincent, the geologist, and the more recently called the Burning Crater or Fournaise (8204 ft.). The latter is partially surrounded by an "enclosure" on a small scale with precipices 200 ft. high. Eruptions, though not infrequent (thirty were registered between 1735 and 1860), are seldom serious; the more noteworthy are those of 1745, 1778, 1791, 1812, 1860, 1870, 1881. Hot mineral springs are found on the flanks of the Piton des Neiges; the Source de Salazie (discovered in 1831) lies 2860 ft. above sea-level, has a temperature of 90°, and discharges 200 to 220 gallons per hour of water impregnated with bicarbonate of soda, and carbonates of magnesium and lime, iron, &c.; that of Cilaos (discovered in 1826) is 3560 ft. above the sea with a temperature of 100°; and that of Mafate 2238 ft. and 89°.

Vertically Réunion may be divided into five zones. The first or maritime zone contains all the towns and most of the villages, built on the limited areas of level alluvium occurring at intervals round the coast. In the second, which lies between 2600 and 4000 ft., the sugar plantations made a green belt round the island and country houses abound. The third zone is that of the forests; the fourth that of the plateaus, where European vegetables can be cultivated; and above this extends the region of the mountains.

Climate.—The year divides into two seasons—that of heat and rain from November to April, that of dry and more bracing weather from May to October. The prevailing winds are from the S.E., sometimes veering round to the S., and more frequently to the N.E.; the W. winds are not so steady (three hundred and seven days of E. to fifty-eight of W. wind in the course of the year). It is seldom calm during the day, but there is usually a period of complete repose before the land wind begins in the evening. Several years sometimes pass without a cyclone visiting the island; at other times they occur more than once in a single "winter." The *ras de marée* occasionally does great damage. On the leeward side of the island the winds are generally from the W. and S.W., and bring little rain. Mist hangs almost all day on the tops of the mountains, but usually clears off at night. On the coast and lower zones on the windward side the mean temperature is about 73° F. in the "winter" and 78° F. in the "summer." On the leeward side the heat is somewhat greater. In the Salazie cirque the mean annual average is 66° F.; at the Plaine des Palmistes 62° F. The rainfall is very heavy on the windward side, some stations registering 160 in. a year, while on the "dry" side of the island not more than 50 in. are registered. On the mountain heights snow falls every year, and ice is occasionally seen. In general the island is healthy, but fever is prevalent on the coast.

Fauna and Flora.—The fauna of Réunion is not very rich in variety of species. The mammals are a brown maki (*Lemur mongoz*, Linn.) from Madagascar, *Pteropus edwardsii* now nearly extinct, several bats, a wild cat, the tang or tamec (*Cenietes setosus*, Denn.), several rats, the hare, and the goat. Among the more familiar birds are the "oiseau de la vierge" (*Muscipeta borbonica*), the tectec (*Pratincola sylvia*), *Certhia borbonica*, the cardinal (*Foudia madagascariensis*), various swallows, ducks, &c. The visitants from Madagascar, Mauritius and even India, are very numerous. Lizards and frogs of more than one species are common, but there is only one snake (*Lycodon auiculum*) known in the island. Various species of *Gobius*, a native species of mullet, *Nesitis cyprinoides*, *Ophronomus olifax* and *Doules rupestris* are among the freshwater fishes. Turtles, formerly common, are now very rare.

In the forest region of the island there is a belt, 4500–5000 ft. above the sea, characterized by the prevalence of dwarf bamboo (*Bambusa alpina*); and above that is a similar belt of *Acacia heterophylla*. Besides this last the best timber-trees are *Casuarina lateralis*, *Foetida mauritiana*, *Imbricaria pitularis*, *Elacodendron* (*Calophyllum spicatum*) (red tacaamah), *Terminalia borbonica*, *Parhia speciosa*. The gardens of the coast districts display a marvellous wealth of flowers and shrubs, partly indigenous and partly gathered from all parts of the world. Among the indigenous varieties may be noted the vacoa (*Pandanus utilis*) and the aloe.

A species of coffee plant is also indigenous. Fruits grown in the island are, the banana, the guava, the pink-bud and jack-fruit, the bilimbi, the carambola, the guava, the litchi, the Japanese medlar, the mango-steen, the tamarind, the *Abelmoschus esculentus*, the chirimoya, the papaya, &c. Forests originally covered nearly the whole island; the majority of the land has been cleared by the inhabitants, but there are still some 200 sq. m. of forest land and the administration has in part replanted the higher districts, such as Salazie, with eucalyptus and caoutchouc trees.

Inhabitants.—The inhabitants are divided into various classes, the creoles, the mulattoes, the negroes, and Indians and other Asiatics. The population extended from the first to the last settlers, chiefly Normans and Bretons, who married Malagasy women. Later settlers included European women, but the presence of non-European blood is so common among the creoles that the phrase "Bourbon white" was given in Mauritius to a line of doubtful cleanness. Three kinds of creoles are recognized—those of the towns and coasts, those of the mountains, and the *petits créoles*, originally a class of small farmers living in the uplands, now reduced to a condition of poverty and dependence on the planters. The *créoles blancs de villes*, the typical inhabitants of the island, are in general of a somewhat weak physique, quick-witted and of charming manners, brave and very proud of their island, but not of strong character. The mixed races tend to approximate to a single type, one in which the European strain predominates. The creole patois is French mixed with a considerable number of Malagasy and Indian words, and containing many local idioms. The population, about 35,000 towards the close of the 18th century, was in 1849, at the period of the liberation of the slaves, 120,000, of whom 60,800 were newly freed negroes. Thereafter coolies were introduced from India, and in 1870 the population had increased to 212,000. It was completely under the government of France since the emigration of coolies to Réunion, and in consequence of that and other economic causes the population decreased. In 1902 the inhabitants numbered 173,315. Of these 13,492 were British Indians, 4496 Malagasy, 9457 foreign-born negroes, and 1378 Chinese. Of the native born the creoles numbered about 3000, the remainder being negroes or of mixed race. Among the Indian population the males are as three to one to the females, and the birth-rate is lower than the death-rate.

Towns and Communication.—St. Denis, the capital of the island, lies on the N. coast. It had in 1902 a population of 27,392. It is built in the form of an amphitheatre, and has several fine public buildings, a university, a botanical garden, a museum, the seat of a bishopric, a court of first instance and an appeal court. It has an abundant supply of pure water. The only anchorage for vessels is an open roadstead. St. Pierre (pop. 28,885), the chief town on the leeward side of the island, has a small artificial harbour. Between St. Pierre and St. Denis, and both on the leeward shore, are the towns of St. Louis (pop. 12,541) and St. Paul (pop. 19,617). A few miles N. of St. Paul on the S. side of Cape Pointe des Galets is the port of the same name, the only considerable harbour in the island. It was completed in 1886 at a cost of £2,700,000, covers 40 acres, is well protected, and has 28 ft. of water. A railway serving the port goes round the coast from St. Pierre, by St. Paul, St. Denis, &c., to St. Benoit (a town on the E. side of the island with a pop. of 12,523), a distance of 8½ m. This line is carried through a tunnel nearly 6½ m. long between La Possession and St. Denis. Besides the railway the lower parts of the island are well provided with roads. There is regular steamship communication between Pointe des Galets, Marseilles, Havre and Madagascar. Telegraphic communication with all parts of the world was established in 1906 when a cable connecting Réunion with Tamatave and Mauritius was laid.

Industry.—The Sugar Plantations.—The area of the cultivated lands is estimated at 148,200 acres (or 230 sq. m.), of which 86,450 acres are under sugar-cane, the remainder being under either maize, manioc, potatoes, haricots, or coffee, vanilla and cocoa. The sugar-cane, introduced in 1711 by Pierre Parat, is now the staple crop. In the 18th century the first place belonged to coffee (introduced from Arabia in 1715) and to the clove tree, brought from the Dutch Indies by Poivre at the risk of his life. Both are now cultivated on a very limited scale. Vanilla, introduced in 1818, was not extensively cultivated till about 1850. Bourbon vanilla, as it is called, is of fine character, and next to sugar is the most important article of cultivation in the island. There are small plantations of cocoa and cinchona; cotton-growing was tried, but proved unsuccessful.

The sugar industry has suffered greatly from the competition with beet sugar and the effects of bounties, also from the scarcity of labour, from the ravages of the phylloxera (which made its appearance in 1878) and from extravagant methods of manufacture. It was not until 1906 that steps were taken for the creation of central sugar mills and refineries, in consequence of the compulsory shut-down of many of the small firms which were unprofitable and forms an important article of export. There are also manufactories for the making of geranium essence, St. Pierre being the centre of this industry. Other articles exported are aloe fibre and vacoa casks. The mineral wealth of the island has not been

exploited, except for the mineral springs which yield waters highly esteemed. Almost all the products of the island are exported, so that the import trade is very varied. Cattle are imported from Madagascar; rice, the chief article of food, from Saigon and India; petroleum, largely used in manufactories, from America and Russia; almost everything else comes from France, to which country go the great majority of the exports. Over 75% of the shipping is under the French flag.

Commerce.—The total trade amounted in 1860 to the value of £4,404,000 (the highest during the century); in 1900, to £1,533,240. In 1905 the imports were valued at £727,000 and the exports at £228,000. Of the imports £500,000 were from France or French colonies of the exports £388,000 went to France or French colonies. The currency consists of notes of the Banque de la Réunion (guaranteed by the government) and nickel token money. Neither the notes nor the nickel money have any currency outside Réunion; the rate of exchange varies from 5 to 20%.

Administration and Revenue.—Réunion is regarded practically as a department of France. It sends two deputies and one senator to the French legislature, and is governed by laws passed by that body. All inhabitants, not being aliens, enjoy the franchise, no distinction being made between whites, negroes or mulattoes, all of whom are citizens. At the head of the local administration is a governor who is assisted by a secretary-general, a *procureur général*, a privy council and a council-general elected by the suffrages of all citizens. The governor has the right of direct communication and negotiation with the government of South Africa and all states east of the Cape. The council-general has wide powers, including the fixing of the budget. For administrative purposes the island is divided into two arrondissements, the Windward, with five cantons and nine communes, and the Leeward, with four cantons and seven communes. The towns are subject to the French municipal law. The revenue, largely dependent on the prosperity of the sugar trade, declined from an average of £163,765 in the five years 1895-99 to an average of £147,225 in the five years 1900-4. For the same periods the average colonial expenditure, which includes the loss incurred in maintaining the harbour and railway, increased from £224,508 to £225,088. Deficits are made good by grants from France.

History.—Réunion is usually said to have been first discovered in April 1513 by the Portuguese explorer Pedro Mascarenhas, and his name, or that of Mascarene Islands, is still applied to the archipelago of which it forms a part; but it seems probable that it must be identified with the island of Santa Apollonia discovered by Diego Fernandes Pereira on the 9th of February 1507. It was visited by the Dutch towards the close of the 16th century, and by the English early in the 17th century. When in 1638 the island was taken possession of by Captain Gaubert, or Gobert, of Dieppe, it was still uninhabited; a more formal annexation in the name of Louis XIII. was effected in 1643 by Jacques Pronis, agent of the *Compagnie des Indes* in Madagascar; and in 1649 Étienne de Flacourt, Pronis's more eminent successor, repeated the ceremony at a spot which he named La Possession. He also changed the name of the island from Mascarenhas to Bourbon. By decree of the Convention in 1793, Bourbon in turn gave place to Réunion, and, though during the empire this was discarded in favour of Île Bonaparte, and at the Restoration people naturally went back to Bourbon, Réunion has been the official designation since 1848.

The first inhabitants were a dozen mineurs deported from Madagascar by Pronis, but they remained only three years (1646-49). Other colonists went thither of their own will in 1654 and 1662. In 1664 the *Compagnie des Indes orientales de Madagascar*, to whom a concession of the island was granted, initiated a regular colonization scheme. Their first commandant was Étienne Régnauld, who in 1689 received from the French crown the title of governor. The growth of the colony was very slow, and in 1717 there were only some 2000 inhabitants. It is recorded that they lived on excellent terms with the pirates, who from 1748 onward infested the neighbouring seas for many years. In 1735 Bourbon was placed under the governor of the Île de France (Mauritius), at that time the illustrious Mahé de Labourdonnais. The *Compagnie des Indes orientales* gave up its concession in 1767, and under direct administration of the crown liberty of trade was granted. The French Revolution effected little change in the island and occasioned no bloodshed; the colonists successfully resisted the attempts of the Convention to abolish slavery, which continued until 1848 (when over 60,000 negroes were freed), the slave trade being, however, abolished in 1817. During the Napoleonic wars Réunion, like Mauritius, served the French corsairs as a rallying place from which attacks on Indian merchantmen could be directed. In 1809 the British attacked the island, and the French were forced to capitulate on the 8th of July 1810; the island remained in the possession of Great Britain until April 1815, when it was restored to France. From that period the island has had no exterior troubles. The negro population, upon whom in 1870 the third Republic conferred the full rights of French citizenship including the vote, being unwilling to labour in the plantations, the immigration of coolies began in 1860, but in 1882 the government of India prohibited the further emigration of labourers from that country in consequence of the inconsiderate

treatment of the coolies by the colonists. Réunion has also suffered from the disastrous effects of cyclones. A particularly destructive storm swept over the island in March 1879, and in 1904 another cyclone destroyed fully half of the sugar crop and 75% of the vanilla crop.

See A. G. Garsault, *Notice sur la Réunion* (Paris, 1900), a monograph prepared for the Paris exhibition of that year; E. Jacob de Cordemoy, *Étude sur l'île de la Réunion, géographie, richesses naturelles, &c.* (Marseille, 1905); W. D. Oliver, *Crags and Craters; Rambles in the island of Réunion* (London, 1896); C. Keller, *Natur und Volksleben der Insel Réunion* (Basel, 1888); J. D. Brunet *Histoire de l'association générale des francs créoles de l'île Bourbon* (St. Denis, Réunion, 1885); Trouette, *L'île Bourbon pendant la période révolutionnaire* (Paris, 1888). Of earlier works consult Demaret, *Nov. Hist. de l'Afrique française* (1767); P. U. Thoma, *Essai de statistique de l'île Bourbon* (1828); Dejean de la Batie, *Notice sur l'île Bourbon* (1847); J. Mauran, *Impressions dans un voyage de Paris à Bourbon* (1850); Maillard, *Notes sur l'île de la Réunion* (1862); Azéma, *Hist. de l'île Bourbon* (1862). The geology and volcanoes of Réunion were the object of elaborate study by Bory de St Vincent in 1801 and 1802 (*Voyages dans les quatre principales îles des mers d'Afrique*, Paris, 1804), and have since been examined by R. von Drasche (see *Die Insel Réunion*, &c., Vienna, 1878, and C. Vélain, *Descriptions géologiques de . . . l'île de la Réunion* . . . Paris, 1878). The best map is Pau Lépervanche's *Carte de la Réunion 1:100,000* (Paris, 1906).

REUS, a city of N.E. Spain, in the province of Tarragona, on the Saragossa-Tarragona railway, 4 m. N. of Salou, its port on the Mediterranean. Pop. (1900) 26,681. Reus consists of two parts, the old and the new, separated by the Calle Arrabal, which occupies the site of the old city wall. The old town centres in the Plaza del Mercado, from which narrow and tortuous lanes radiate in various directions; the new one dates from about the middle of the 18th century, and its streets are wide and straight. There is an active trade in the agricultural products of the fertile region around the city. The local industries developed considerably between 1875 and 1905, and the city has important flour, wine and fruit export houses. There is a model farm belonging to the municipality in the suburbs. Reus has excellent primary, normal and higher-grade state schools, many private schools, an academy of fine arts and a public library. The hospitals and founding refuge, the institute and the town hall are handsome modern buildings.

The earliest records of Reus date from about the middle of the 13th century. Its modern prosperity is traced to about the year 1750, when a colony of English settled here and established a trade in woollens, leather, wine and spirits. The principal incidents in its political history arose out of the occurrences of 1843 (see SPAIN, *History*), in connexion with which the town received the title of city, and Generals Zubrano and Prim were made counts of Reus. The city was the birthplace of General Prim (1814-1870) and of the painter Mariano Fortuny (1839-1874).

REUSCH, FRANZ HEINRICH (1823-1900), Old Catholic theologian, was born at Heilbrunn, in Westphalia, on 4th December 1823. He studied general literature at Paderborn, and theology at Bonn, Tübingen and Munich. The friend and pupil of Döllinger, he took his degree of Doctor in Theology at Munich, the university of which Döllinger was so long an ornament. He was ordained priest in 1849, and was immediately afterwards made chaplain at Cologne. In 1854 he became *Privat-docent* in the exegesis of the Old Testament in the Catholic Theological Faculty at Bonn; in 1858 he was made extraordinary, and in 1861 ordinary, professor of theology in the same university. From 1866 to 1877 he was editor of the *Bonner Theologisches Literaturblatt*. In the controversies on the Infallibility of the Pope, Reusch attached himself to Döllinger's party, and he and his colleagues Hilgers, Knoodt and Langen were interdicted by the archbishop of Cologne in 1871 from pursuing their courses of lectures. In 1872 he was excommunicated. For many years after this he held the post of Old Catholic *curé* of Bonn, as well as the position of vicar-general to the Old Catholic Bishop Reinkens, but resigned both in 1878, when, with Döllinger, he disapproved of the permission to marry granted by the Old Catholic Church in Germany to its clergy. From that time he retired into lay communion,

but continued to give lectures as usual in the Old Catholic Faculty of Theology in the university of Bonn, and to write on theological subjects. He was made rector of that university in 1873. In 1874 and 1875 he was the official reporter of the memorable Reunion Conferences held at Bonn in those years and attended by many distinguished theologians of the Oriental and Anglican communions.

Reusch was a profound scholar, an untiring worker and a man of lovable character. Among his voluminous works were contributions to the *Revue internationale de théologie*, a review started at Bern at the instance of the Old Catholic Congress at Lucerne. He wrote also works on the Old Testament; a pamphlet on *Die Deutschen Bischöfe und der Aberglaube*; and another on the falsifications to be found in the treatise of Aquinas against the Greeks; as well as essays on the history of the Jesuit Order, and a book of prayers. But his fame will mainly rest on the works which he and Döllinger published jointly. These consisted of a work on the Autobiography of Cardinal Bellarmine, the *Geschichte der Moralstreitigen in der Römisch-Katholischen Kirche seit dem XVI. Jahrhundert*, and the *Erörterungen über Leben und Schriften des hl. Liguori*. During the last few years of his life he was smitten with paralysis. He died on the 3rd of March 1900, leaving behind him in manuscript a collection of letters to Bunsen about Roman cardinals and prelates, which has since been published. (J. J. L. *)

REUSCH, HANS HENRIK (1852—), Norwegian geologist, was born at Bergen on the 5th of September 1852. He was educated at Christiania, Leipzig and Heidelberg, and graduated Ph.D. at Christiania in 1883. He joined the Geological Survey of Norway in 1875, and became Director in 1888. He is distinguished for his researches on the crystalline schists and the Palaeozoic rocks of Norway. He discovered Silurian fossils in the highly altered rocks of the Bergen region; and in 1891 he called attention to a palaeozoic conglomerate of glacial origin in the Varanger Fiord, a view confirmed by Mr A. Strahan in 1896, who found glacial striae on the rocks beneath the ancient boulder-bed. Reusch has likewise thrown light on the later geological periods, on the Pleistocene glacial phenomena and on the sculpturing of the scenery of Norway. Among his separate publications are *Sibir fossiler og presede Konglomerater* (1882); *Det nordlige Norges Geologi* (1891).

REUSS, AUGUST EMANUEL VON (1811—1873), Austrian geologist and palaeontologist, the son of Franz Ambrosius Reuss (1761—1830), was born at Bilin in Bohemia on the 8th of July 1811. He was educated for the medical profession, graduating in 1834 at the university of Prague, and afterwards practising for fifteen years at Bilin. His leisure was devoted to mineralogy and geology, and the results of his researches were published in *Geognostische Skizzen aus Böhmen* (1840—44) and *Die Versteinerungen der Böhmisches Kreideformation* (1845—46). In 1849 he gave up his medical practice, and became professor of mineralogy at the university of Prague. There he established a fine mineralogical collection, and he became the first lecturer on geology. In 1863 he was appointed professor of mineralogy in the university of Vienna. He investigated the Cretaceous fauna of Gosau, and studied the Crustacea, including entomostraca, the corals, bryozoa, and especially the foraminifera of various geological formations and countries. He died in Vienna on the 26th of November 1873.

REUSS, ÉDOUARD GUILLAUME EUGÈNE (1804—1891), Protestant theologian, was born at Strassburg on the 18th of July 1804. He studied philology in his native town (1819—22), theology at Göttingen under J. G. Eichhorn; and Oriental languages at Halle under Wilhelm Gesenius, and afterwards at Paris under Silvestre de Sacy (1827—28). In 1828 he became *Privatdozent* at Strassburg. From 1829 to 1834 he taught Biblical criticism and Oriental languages at the Strassburg Theological School; he then became assistant, and afterwards, in 1836, regular professor of theology at that university. The sympathies of Reuss were German rather than French, and after the annexation of Alsace to Germany he remained at Strassburg, and retained his professorship till, in 1888, he retired

on a pension. Amongst his earliest works were: *De libris veteris Testamenti apocryphis plebi non negandis* (1829), *Ideen zur Einleitung in das Evangelium Johannis* (1840) and *Die Johannische Theologie* (1847). In 1852 he published his *Histoire de la théologie chrétienne au siècle apostolique*, which was followed in 1863 by *L'Histoire du canon des saintes écritures dans l'église chrétienne*. In 1874 he began to publish his translation of the Bible, *La Bible, nouvelle traduction avec commentaire*. It was the criticism and exegesis of the New Testament which formed the subject of Reuss's earlier labours—in 1842, indeed, he had published in German a history of the books of the New Testament, *Geschichte der heiligen Schriften N. Test.*; and though his own views were liberal, he opposed the results of the Tübingen school. After a time he turned his attention also to Old Testament criticism, for which he was especially fitted by his sound knowledge of Hebrew. In 1881 he published in German his *Geschichte der heiligen Schriften A. Test.*, a veritable encyclopaedia of the history of Israel from its earliest beginning till the taking of Jerusalem by Titus. He died at Strassburg on the 15th of April 1891.

Reuss belonged to the more modern section of the Liberal party in the Lutheran Church. His critical position was to some extent that of K. H. Graf and J. Wellhausen, allowing for the circumstances that he was in a sense their forerunner, and was actually for a time Graf's teacher. Indeed, he was really the originator of the new movement, but hesitated to publish the results of his studies. For many years Reuss edited with A. H. Cuniz (b. 1812) the *Beiträge zu den theologischen Wissenschaften*. With A. H. Cuniz and J. W. Baum (1809—1878), and after their death alone, he edited the monumental edition of Calvin's works (38 vols., 1863 ff.). His critical edition of the Old Testament appeared a year after his death. His son, ERNST RUDOLF (b. 1841), was in 1873 appointed city librarian at Strassburg.

See the article in Herzog-Hauck, *Realencyklopädie*, and cf. Otto Pfeiderer, *Development of Theology in Germany since Kant* (1890).

REUSS, the name of two small principalities of the German empire, called Reuss, elder line, or Reuss-Greiz, and Reuss, younger line, or Reuss-Schleiz-Gera. With a joint area of 441 sq. m. they form part of the complex of Thuringian states, and consist, roughly speaking, of two main blocks of territory, separated by the Neustadt district of the duchy of Saxe-Weimar. The more southerly, which is much the larger of the two portions, belongs to the bleak, mountainous region of the Frankenwald and the Vogtland, while the northern portion is hilly, but fertile. The chief rivers are the Weisse Elster and the Saale. About 35% of the total surface is occupied by forests, while about 40% is under tillage and about 10% under meadow and pasture. Wheat, rye and barley are the principal crops grown, and the breeding of cattle is an important industry.

Reuss-Greiz, with an area of 122 sq. m., belongs to the larger of the two divisions mentioned above, and consists of three large and several small parcels of land. On the whole, the soil is not favourable for agriculture, but the rearing of cattle is carried on with much success. About 63% of the inhabitants maintain themselves by industrial pursuits, the chief products of which are the making of woollen fabrics at Greiz, the capital, and of stockings at Zeulenroda. Other industries are machine-building, printing and the making of paper and porcelain. In 1905 the population of the principality was 70,603. The constitution of Reuss-Greiz dates from 1867, and provides for a representative chamber of twelve members, of whom three are appointed by the prince, while two are chosen by the landed proprietors, three by the towns and four by the rural districts. The revenue and expenditure amount to about £76,000 a year, and there is no public debt. The reigning prince is Henry XXIV. (b. 1878), but as he is incapable of discharging his duties, these are now undertaken by a regent.

Reuss-Schleiz-Gera, with an area of 319 sq. m., includes part of the southern and the whole of the northern of the two main divisions mentioned above; it touches Bavaria on the south

and Prussian Saxony on the north. The former portion is known as the Oberland and the latter as the Unterland. Owing to the fertility of the Unterland, quite one-quarter of the people are supported by agricultural pursuits, although there is also much industrial activity. The chief industrial product consists of woollen goods, and the manufacture centres in the capital Gera, the largest of the six towns of the principality. Other industries are jute-spinning, dyeing and brewing, and the manufacture of musical instruments, chemicals, tobacco, cigars, porcelain and machinery. A considerable trade is carried on in these goods and also in timber, cattle and slate. Iron is mined in the Oberland, and large quantities of salt are yielded by the brine springs of Heinrichshall. In 1905 Reuss-Schleiz contained 144,584 inhabitants. Its annual revenue and expenditure amount to about £129,000, and in 1908 it had a public debt of £52,027. The constitution, which rests on laws of 1852 and 1856, provides for a representative assembly of 16 members which possesses limited legislative powers, the administrative duties being discharged by a cabinet of three members. The reigning prince is Henry XIV. (b. 1832), but since 1892 his duties have been undertaken by a regent. The states of Reuss return one member each to the Bundesrat, and one each to the Reichstag of the German empire.

History.—The history of Reuss stretches back to the times when the German kings appointed vogts, or bailiffs (*advocati imperii*), to administer their lands. One of these vogts was a certain Henry, who died about 1120, after having been entrusted by the emperor Henry IV. with the vogtship of Gera and Weida, and he is generally recognized as the ancestor of the princes of Reuss. His descendants called themselves lords of Weida, and some of them were men of note in their day, serving the emperors and German kings and distinguishing themselves in the ranks of the Teutonic order. The land under their rule gradually increased in size, and it is said that the name of Reuss was applied to it owing to the fact that one of its princes married a Russian princess, their son being called "der Russe," or the Russian. Another version is that the prince received this sobriquet because he passed many years in Russia. The district thus called Reuss was at one time much more extensive than it is at present, and for some years its rulers were margraves of Meissen. In 1564 the family was divided into three branches by the sons of Henry XVI. (d. 1535). One of these became extinct in 1616, but the remaining ones are those of Reuss-Greiz and Reuss-Schleiz-Gera, which are flourishing to-day. Although there have been further divisions these have not been lasting, and the lands of the former family have been undivided since 1768 and those of the latter since 1848. The lords of Reuss took the title of count in 1673; and the head of the elder line became a prince of the Empire in 1778, and the head of the younger line in 1806. In 1807 the two princes joined the Confederation of the Rhine and in 1815 the German confederation. In 1866 Reuss-Greiz was compelled to atone for its active sympathy with Austria by the payment of a fine. In 1871 both principalities became members of the new German empire. The princes of Reuss are very wealthy, their private domain including a great part of the territory over which they rule. In the event of either line becoming extinct, its possessions will fall to the other.

A curious custom prevails in the house of Reuss. The male members of both branches of the family all bear the name of Henry (Heinrich), the individuals being distinguished by numbers. In the elder line, according to an arrangement made in 1701, the enumeration continues until the number one hundred is reached when it begins again. In the younger line the first prince born in a new century is numbered I., and the numbers follow on until the end of the century when they begin again. Thus Henry XIV. of Reuss younger line, who was born in 1832, was the son of Henry LXVII. (1789-1867), the former being the 14th prince born in the 19th century, and the latter the 67th prince born in the 18th.

See B. Schmidt, *Die Reussen, Genealogie des Gesamthausess Reuss* (Schleiz, 1903); H. von Voss, *Die Ahnen des reussischen Hauses*

(Lobenstein, 1882); C. F. Collmann, *Reussische Geschichte. Das Vogtland im Mittelalter* (Greiz, 1882), and O. Liebmann, *Das Staatsrecht des Fürstenthums Reuss* (1894).

REUTER, FRITZ (1810-1874), German novelist, was born on the 7th of November 1810, at Stavenhagen, in Mecklenburg-Schwerin, a small country town where his father was burgomaster and sheriff (*Stadtrichter*), and in addition to his official duties carried on the work of a farmer. He was educated at home by private tutors and subsequently at the gymnasiums of Friedland in Mecklenburg-Strelitz, and of Parchim. In 1831 he began to attend lectures on jurisprudence at the university of Rostock, and in the following year went to the university of Jena. Here he was a member of the political students' club, or German Burschenschaft, and in 1833 was arrested in Berlin by the Prussian government; although the only charge which could be proved against him was that he had been seen wearing its colours, he was condemned to death for high treason. This monstrous sentence was commuted by King Frederick William III. of Prussia to imprisonment for thirty years in a Prussian fortress. In 1838, through the personal intervention of the grand-duke of Mecklenburg, he was delivered over to the authorities of his native state, and the next two years he spent in the fortress of Dömitz, but in 1840 was set free, an amnesty having been proclaimed after the accession of Frederick William IV. to the Prussian throne.

Although Reuter was now thirty years of age, he went to Heidelberg to resume his legal studies; but he soon found it necessary to return to Stavenhagen, where he aided in the management of his father's farm. After his father's death, however, he abandoned farming, and in 1850 settled as a private tutor at the little town of Treptow in Pomerania. Here he married Luise Kunze, the daughter of a Mecklenburg pastor. Reuter's first publication was a collection of miscellanies, written in Plattdeutsch, and entitled *Löschen an Riemels* ("anecdotes and rhymes," 1853; a second collection followed in 1858). The book, which was received with encouraging favour, was followed by *Potterabendgedichte* (1855), and *De Reis' nah Bellingen* (1855), the latter a humorous poem describing the adventures of some Mecklenburg peasants who resolve to go to Belgium (which they never reach) to learn the secrets of an advanced civilization. In 1856 Reuter left Treptow and established himself at Neubrandenburg, resolving to devote his whole time to literary work. His next book (published in 1858) was *Kein Häusung*, an epic in which he presents with great force and vividness some of the least attractive aspects of village life in Mecklenburg. This was followed, in 1860, by *Hanne Nüte un de lütte Pudel*, the best of the works written by Reuter in verse. In 1861 Reuter's popularity was largely increased by *Schurr-Murr*, a collection of tales, some of which are in High German, but this work is of slight importance in comparison with the series of stories, entitled *Olle Kamellen* ("old stories of bygone days") 1861. The first volume, published in 1860, contained *Woans ick tau'ne Fru kam and Ut de Franzosentid. Ut mine Festungstid* (1861) formed the second volume; *Ut mine Stromtid* (1864) the third, fourth and fifth volumes; and *Dörchlüchtung* (1866) the sixth volume—all written in the Plattdeutsch dialect of the author's home. *Woans ick tau'ne Fru kam* is a bright little tale, in which Reuter tells, in a half serious half bantering tone, how he wooed the lady who became his wife. In *Ut de Franzosentid* the scene is laid in and near Stavenhagen in the year 1813, and the characters of the story are associated with the great events which then stirred the heart of Germany to its depths. *Ut mine Festungstid* is of less general interest than *Ut de Franzosentid*, a narrative of Reuter's hardships during the term of his imprisonment, but it is not less vigorous either in conception or in style. *Ut mine Stromtid* is by far the greatest of Reuter's writings. The men and women he describes are the men and women he knew in the villages and farmhouses of Mecklenburg, and the circumstances in which he places them are the circumstances by which they were surrounded in actual life. As in *Ut de Franzosentid* he describes the deep national impulse in obedience to which Germany rose against

Napoleon, so in *U1 mine Stromtid* he presents many aspects of the revolutionary movement of 1848.

In 1863 Reuter transferred his residence from Neubrandenburg to Eisenach; and here he died on the 12th of July 1874. In the works produced at Eisenach he did not maintain the high level of his earlier writings.

Reuter's *Sämtliche Werke*, in 13 vols., were first published in 1863-68. To these were added in 1875 two volumes of *Nachgelassene Schriften*, with a biography by A. Wilbrandt; and in 1878 two supplementary volumes to the works appeared. A popular edition in 7 vols. was published in 1877-78 (last edition, 1902); there are also editions by K. F. Müller (18 vols., 1905), and W. Seelmann (7 vols., 1905-6). See O. Glagau, *F. Reuter und seine Dichtungen* (1866; 2nd ed., 1875); H. Ebert, *F. Reuter und seine Werke* (1874); F. Latendorf, *Zur Erinnerung an F. Reuter* (1879); K. T. Gädertz, *Reuter-Studien* (1890); by the same, *Aus Reuters allen und jungen Tagen* (3 vols., 1894-1900); *Briefe F. Reuters an seinen Vater*, edited by F. Engel (2 vols., 1895); A. Römer, *F. Reuter in seinem Leben und Schaffen* (1895); G. Raatz, *Wahrheit und Dichtung in Reuters Werken* (1895); A. Brandes, *Aus F. Reuters Leben* (1899); K. F. Müller, *Der Mecklenburger Volksmund und F. Reuters Schriften* (1902). A complete bibliography of F. Reuter will be found in the *Niederdeutsche Jahrbuch* for 1896 and 1902.

REUTER, PAUL JULIUS, BARON DE (1821-1899), founder of Reuter's News Agency, was born at Cassel, Germany. At the age of thirteen he became a clerk in his uncle's bank at Göttingen, where he chanced to make the acquaintance of Professor Gauss, whose experiments in telegraphy were then attracting some attention. Reuter's mind was thus directed to the value of the speedy transmission of information, and in 1849, on the completion of the first telegraph lines in Germany and France, he found an opportunity of turning his ideas to account. There was a gap between the termination of the German line at Aix-la-Chapelle and that of the French and Belgian lines at Verviers. Reuter organized a news-collecting agency at each of these places, his wife being in charge of one, himself at the other, and bridged the interval by a pigeon-post. On the establishment of through telegraphic communication, Reuter endeavoured to start a news agency in Paris, but finding that the French government's restrictions would render the scheme unworkable, removed in 1851 to England and became a naturalized British subject. The first submarine cable—between Dover and Calais—had just been laid, and Reuter opened an office in London for the transmission of intelligence between England and the continent. At first, however, his business was practically confined to the transmission of private commercial telegrams to places not connected with the new telegraph system. He appointed agents at the various telegraph termini on the continent to take these despatches off the wires and forward them by rail or pigeon-post to the addresses. Simultaneously he endeavoured to induce the English papers to publish the foreign news telegrams supplied by his various agents. These efforts were for some years unsuccessful, until in 1858 *The Times* published the report of an important speech by Napoleon III. forwarded by Reuter's Paris agent. Reuter now extended his sphere of operations all over the world, and in 1859 obtained leave for the presence of representatives at the headquarters of the Austrian and French armies during the war. In 1866 he laid down a special cable from Cork to Crookhaven, which enabled him to circulate news of the American Civil War several hours before the steamer could reach Liverpool. A concession for a cable beneath the North Sea to Cuxhaven was granted him by the king of Hanover in 1865, and in the same year a concession was granted him for a cable between France and the United States, the line being worked jointly by Reuter (whose business had just been converted into a limited liability company) and the Anglo-American Telegraph Company. In 1872 he obtained from the shah of Persia an exclusive concession to develop the internal resources of that country, but the concession was annulled and its privileges transferred to the Imperial Bank of Persia. Reuter was in 1871 given the title of baron by the duke of Saxe-Coburg and Gotha, and by a special grant of Queen Victoria he and his heirs were authorized to have the privileges of this rank in England. Baron Reuter died at Nice on the 25th of February 1899.

REUTERHOLM, GUSTAF ADOLF, BARON (1756-1813), Swedish statesman. After a brief military career he was appointed *Kammerherr* to Sophia Magdalena, queen consort of Gustavus III., and subsequently became intimately connected with the king's brother, Charles, then duke of Sudermania. He remained in the background throughout the reign of Gustavus III., whom he constantly opposed and by whom he was imprisoned along with the other malcontents in 1789. He was abroad at the time of the king's death, but a summons from his friend, now duke regent, speedily recalled him, and in 1793 he was made a member of the council of state and one of the "lords of the realm." At first he seemed inclined to adopt a liberal system, and reintroduced the freedom of the press. He did this solely, however, to reverse the Gustavian system, and persecuted the stalwarts of the late king (e.g. G. M. Armfelt, J. K. Toll) with a petty vindictiveness which excited general disgust. Towards the end of the regency, Reuterholm inclined towards an alliance with Russia on the basis of a marriage between the young king, Gustavus IV., and the empress Catherine's granddaughter, Alexandra Pavlovna, an alliance frustrated by the bigotry of the intended groom. At home the Swedish government ended as ultra-reactionary, owing to an insignificant riot in Stockholm which so alarmed Reuterholm that he threatened all printers who printed anything relating to the constitutions of the French republic or the United States of America with the loss of their privileges. In March 1795 he closed the Swedish Academy because A. G. Silfverstolpe in his inaugural address had ventured to disapprove of the *coup d'état* of 1789. On the accession of Gustavus IV. (November 1st, 1796) Reuterholm was expelled from Stockholm. For the next twelve years he lived abroad under the name of Tempelcentz. After the revolution of 1809 he returned to Sweden, but was denied all access to Charles XIII., and quitted his country for good. He died in Schleswig on the 27th of December 1813.

See *Sveriges Historia* (Stockholm, 1877-1881), vol. v. (R. N. B.)

REUTLINGEN, a town of Germany, in the kingdom of Württemberg, situated on the Echaz, an affluent of the Neckar, near the base of the Achalm and 36 m. by rail S. of Stuttgart. Pop. (1905) 23,850. It is a quaintly built town, with many picturesque houses and a fine Gothic church of the 13th and 14th centuries dedicated to St Mary, which was restored in 1893-1901; it contains in the choir a replica of the Holy Sepulchre and a sculptured stone font, and has a tower 240 ft. high. Reutlingen has three other Evangelical churches, a Roman Catholic church, a town hall, and several monuments, including one to the emperor William I. and another to Friedrich List. The industries of the town are numerous, and include the spinning and weaving of cotton, dyeing and bleaching; also the manufacture of leather, machinery, furniture, shoes, paper, clothing, hardware, bricks, beer and woollen goods. Hops, vines and fruit are grown in the neighbourhood. Reutlingen has several schools and educational establishments, including a celebrated pomological institute. It is also famous as the place where Pastor Gustav Werner (1809-1887) founded his Christian Socialist refuge, which has become widely known in philanthropic circles.

Reutlingen, which is first mentioned in 1213, became a free imperial town in the 13th century and was fortified by the emperor Frederick II., remaining loyal to him and to his son, Conrad IV. A member of the league of Swabian towns, its citizens defeated Count Ulrich of Württemberg on the 14th of May 1377. Later it joined the Swabian League and was favoured by the emperor Maximilian I. It came into the possession of Württemberg in 1802. An explosion which took place on the 27th of December 1852 destroyed many houses in the town.

See Rupp, *Aus der Vorzeit Reutlingens und seiner Umgegend* (Stuttgart, 1869); Hochstetter, *Führer durch Reutlingen und Umgegend* (Reutlingen, 1901); and Zwiesle, *Geognostischer Führer in der Umgegend von Reutlingen* (Stuttgart, 1897).

REVAL, or REVEL (Russ. *Revel*, formerly *Колывань*; Estonian, *Tallina* and *Tannisiin*), a fortified seaport town of Russia, capital of Estonia, situated on a bay on the S. coast of the gulf of Finland, 230 m. W. of St Petersburg by rail. Pop. (1900) 66,292, of whom half were Estonians and 30%

Germs. The city consists of two parts—the Domborg or Dom, which occupies a hill, and the lower town on the beach. The Dom contains the castle (first built in the 13th century, rebuilt in 1772), where the provincial administration has its seat, and a cathedral (1894-1900) with five gilded domes. It has its own administration, separate from that of the lower town. The church of St Nicholas, built in 1317, contains many antiquities of the former Roman Catholic times and old German paintings. The Dom church contains many interesting shields, as also the graves of the circumnavigator Baron A. J. von Krusenstern (1770-1846), of the Swedish soldiers Pontus de la Gardie (d. 1585) and Carl Horn (d. 1601), and of the Bohemian Protestant leader Count Matthias von Thurn (1580-1640). The church of St Olaf, first erected in 1240, and often rebuilt, was completed in 1840 in Gothic style; it has a bell tower 456 ft. high. The oldest church is the Estonian, built in 1219. The public institutions include a good provincial museum of antiquities; an imperial palace, Katharinenthal, built by Peter the Great in 1719; and very valuable archives, preserved in the town hall (14th century). The pleasant situation of the town attracts thousands of people for sea-bathing. It is the seat of a branch board of the Russian admiralty and of the administration of the Baltic lighthouses. Its port has a depth of 4 to 6 fathoms, and a roadstead $3\frac{1}{2}$ m. wide, which freezes nearly every winter. The exports consist chiefly of grain, timber, flax, hides, wool, a species of anchovy, and hemp, and the imports of manufactured goods and machinery. The value of the aggregate trade amounts to an average of seven to nine millions sterling annually. There is considerable trade with Finland. Baltic Port, 30 m. W., is a sort of annex to the port of Revel.

The high Silurian crag now known as Domborg was early occupied by an Estonian fort, Lindanissa. In 1219 the Danish king Valdemar II. erected here a strong castle and founded the first church. In 1228 the castle was taken by the Livonian Knights, but nine years later it returned to the Danes. About the same time Lübeck and Bremen merchants settled there, and their settlement became an important seaport of the Hanseatic League. It was fortified early in the 14th century, and in 1343 sustained a siege by the revolted Estonians. Valdemar III. sold Revel and Estonia to the Teutonic Knights in 1346, but on the dissolution of the order, in 1561, Estonia and Revel surrendered to the Swedish king Erik XIV. A great conflagration in 1433, the pestilence of 1532, the bombardment by the Danes in 1569, and the Russo-Livonian War, destroyed its trade. The Russians besieged Revel twice, in 1570 and 1577. It was still an important fortress, having been enlarged and fortified by the Swedes. In 1710 it was surrendered to Peter the Great, who immediately began the erection of a military port for his Baltic fleet. His successors continued to fortify the access to Revel from the sea, large works being undertaken, especially in the early years of the 19th century.

REVEILLÉ (Fr. *réveiller*, imperative of *réveiller*, to awaken, Lat. *re-* and *vigilare*, to watch), the signal by call of bugle or beat of drum to announce to soldiers the time to awake and begin duty.

REVELATION, BOOK OF, in the Bible, the last book of the New Testament.

Title.—According to the best authorities κ CA (in the subscription) 2, 8, 82, 93, the title of this book is ἀποκάλυψις Ἰωάννου. Some cursives (1, 14, 17, 25, 28, 31, 38, 51, 90, 91, 94, 97) read ἀρ. (+ τοῦ ἁγίου 1, 25, 28, 31, 38, 51, 90, 94) Ἰωάννου τοῦ θεολόγου; Q and 12, ἀρ. Ἰ. τοῦ θεολ. καὶ εὐαγγελιστοῦ; P and 42, ἡ ἀρ. τοῦ ἀποστόλου Ἰ. καὶ εὐαγγελιστοῦ. The word "apocalypse" gives the current title not only to this book, but to a large body of Jewish and Christian writings. This is one of the first instances of its use in this sense in existing literature. An earlier use is probably to be found in the title of the Syriac Apocalypse of Baruch, which = γράφει τῆς ἀποκαλύψεως τοῦ βασιλέως τοῦ Νηβου. The title is different from what the New Testament use of the term would have led us to expect, i.e. Ἀποκάλυψις Ἰησοῦ, which are indeed the opening words of this book. With

the latter phrase we might compare Gal. i. 12, where we have ἀποκαλύψεως Ἰησοῦ Χριστοῦ, "revelation from Jesus Christ." For the book is a revelation made by God to Jesus Christ, who through His angel made it known to John for transmission to the churches. Instead of this the Church substituted the name of the disciple through whom the message was delivered for that of his Master, and designated our Apocalypse "The Apocalypse of John." This title was familiar before the end of the 2nd century.

MSS. and Versions.—There are six uncials, κ , A, C, P, Q, 1, the last of which has not been edited or collated. Of the rest, P and Q are imperfect. The known cursives amount to 229, according to von Soden (*Die Schriften des Neuen Testaments*, I. i. 289). There are six ancient versions of various values. (a) The best is the Latin, which is found in the Old Latin (g h m and the text used by Primasius) and the Vulgate, of which there are eight MSS. written between the 6th and 15th centuries. (b) The Syriac version appears in two forms, the Peshitta (A.D. 508), recently discovered and edited by Gwynn, and the Harclean (A.D. 616). The true Peshitta did not contain the Apocalypse. (c) The Armenian version. The Apocalypse was admitted to the canon, according to Conybeare, in the 12th century through the influence of Nerses, who revised an older version traceable to the opening of the 5th century. (d) The Egyptian version is found in two forms, i.e. the Bohairic and Sahidic. The former has been edited by Horner, who is now also engaged on an edition of the latter. (e, f) The Ethiopic and Arabic versions have not yet been critically edited.

External Evidence and Canonicity, 2nd Century.—It is possible that the Apocalypse was known to Ignatius, *Eph.* xv. 3 (*Rev.* xxi. 3); *Philad.* vi. 1 (*Rev.* iii. 12). Some have thought also that Barnabas (vi. 13, xxi. 3) was acquainted with our text, but this is highly improbable. Andreas of Caesarea mentions Papias as attesting the credibility of Revelation, and cites two of his remarks on *Rev.* xii. 7. The fact that Eusebius does not mention Revelation among the New Testament books known to Papias (*H.E.* iii. 39) may be due to the historian's unfriendly attitude to the book. Moreover, Papias may be one of the presbyters to whom, as having actually seen John, Irenaeus (v. 30 = Eusebius, *H.E.* v. 8) appeals on behalf of the number 666. From these possible and highly probable references we pass on to the clear testimony of Justin Martyr, who is the first to declare that Revelation is by "John, one of the Apostles of Christ" (*Dial.* lxxxi. 15), and a book of canonical standing (i. 28). In the latter half of this century it meets with very wide recognition. Thus a treatise of some description was written upon it by Melito of Sardis in Asia Minor (*Eus. H.E.* iv. 26), and quoted by the anti-Montanist Apollonius (*H.E.* v. 18) and Theophilus of Antioch (*H.E.* iv. 24). In Carthage its currency is proven by the references of Tertullian, and the phraseology of the Acts of Perpetua and Felicitas (§§ 4, 12); in Alexandria by the citations of Clement (*Paed.* i. 6, 36; ii. 10, 108, &c.); in Rome by its inclusion in the Muratorian canon, and in Gaul by its use in the Epistle to the churches of Vienne and Lyons (*Eus. H.E.* v. 10, 58), and in Irenaeus, who defends the apostolic authorship of the Revelation of John (*Haer.* iv. 14, i. 17, 6, 18, 6, 20, 11, 21, 3; v. 26, i. &c.).

But in certain quarters the authority of the book was denied. Thus Marcion rejected it on the ground of its Jewish character (Tertullian, *c. Marcion*, iv. 5), and the Alogi assigned both Revelation and the Gospel to Cerinthus (Epiphanius, *Haer.* li. 3). This attitude is more widely represented in the next century.

Third Century.—The attack on Revelation was resumed by abler antagonists in this century. The objections of the Alogi were restated and maintained by the Roman presbyter Caius in his controversy with the Montanist Proclus (*Eus. H.E.* ii. 25, 6; iii. 28, 2), but met with such overwhelming refutation at the hands of Hippolytus (see Gwynn, *Hermathena*, vi. 397-418) that no church writer in the West subsequently except Jerome seriously called in question the authorship of our book.

Dionysius of Alexandria (A.D. 255) wrote a moderate and effective criticism, in which he rejects the hypothesis of the

Cerinthian authorship and urges that it was not written by the apostle, on the ground of its difference in language, style and contents from the other Johannine writings. Its author was some inspired man bearing the same name as the son of Zebedee. The arguments of Dionysius were repeated by Eusebius, who ascribed the work to the presbyter John mentioned by Papias (Eus. *H. E.* iii. 39) and was in doubt whether he should place Revelation among the spurious (*pseuda*) works (*H. E.* iii. 25.4) or the accepted (*ὁμολογούμενα*).

Eastern Church.—In the Eastern Church the views of Dionysius and Eusebius were generally accepted. With the exception of Methodius and Pamphilus the book was not received by Eastern scholars. Thus it was either not mentioned or disowned by Cyril of Jerusalem, Chrysostom, Theodore of Mopsuestia, Theodore and Amphilocheus of Iconium. It is absent from the so-called Synopsis of Athanasius, the Stichometry of Nicephorus, the List of Sixty Books and other authoritative documents. It formed no part of the Peshitta New Testament. It was apparently unknown to Ephraem. Even when later it found a place in the Philoxenian and Harclean versions it never became a familiar book to the Syrian Churches, while it was unhesitatingly rejected by the Nestorian and Jacobite Churches.

But though the Syrian Church maintained this unconciliatory attitude to the book, opposition to it began gradually to disappear in the rest of the East. Thus it came to be acknowledged by Athanasius, Isidore of Pelusium, Gregory of Nyssa, and others. Commentaries on the book were written by Andreas, archbishop of Caesarea, in the 5th century, and Arethas in the 9th.

Western Church.—In the Western Church, Revelation was accepted by all writers from Hippolytus onward with the exception of Jerome, who relegated it to the class lying between the canonical and apocryphal. The authenticity of the book was unquestioned throughout till the Reformation, when the view of Jerome was revived by Erasmus, Carlstadt, Luther and others under various forms. In the Lutheran Church this opposition lasted into the next century, but in the Reformed it gave way much earlier. That Revelation has retained its place in the canon is due not to its extravagant claims to inspiration or its apocalyptic disclosures, but to its splendid faith and unconquerable hope, that have never failed to awake the corresponding graces in every age of the Church's history.

The History of Interpretation.—This is a most fruitful subject, and the study of it helps to settle other related questions. We first of all might divide the methods of interpretation into two classes: I. Methods which presuppose the literal unity of the book; II. Methods which presuppose some breach of this unity either in the plan of the book as a whole or in some of its details.

I. Methods presupposing the Literal Unity of the Book.—Where the book was accepted the problem of its interpretation was differently dealt with according to the age and environment of the interpreter. The book was first taken in a severely literal sense, and particularly in its chiliastic doctrine.

i. Chiliastic Interpretation.—Revelation was held to teach chiliasm, or the doctrine of the literal reign of 1000 years. Amongst the chiliasts were Cerinthus, Papias, Justin, Irenaeus, Hippolytus, Tertullian and Victorinus.¹ When the Church obtained the mastery of the world this method came naturally to be abandoned in favour of a spiritualistic interpretation, to which we shall presently refer. But the growing secularism of the Church led to a revival of the former method in the beginning of the 13th century amongst the Franciscans. Thus Joachim of Floris in his *Expositio magni abbatis Iochimi in Apoc.* teaches that Babylon is Rome, the Beast from the Sea Islam, the False Prophet the heretical sects of the day, and that on the close of the present age which was at hand the millennium would ensue. This method of interpretation was pursued to extravagant lengths by other Franciscans and was subsequently

adopted by the Protestant reformers, who could justify their identification of the papacy with the Antichrist from books written within the Roman communion. Joachim was the first to apply the "recapitulation" theory to Revelation.

ii. Spiritualistic Interpretation.—The founder of this school of interpretation was Ticonius the Montanist (*floruit* A.D. 380), though he followed therein the precedent set by Origen. His interpretation is on the whole mystical. Historical fulfillments, if not excluded, are not sought for. The millennium is the period between the first and second comings of Christ. The method of Ticonius was dominant in the Church down to the middle ages, amongst his followers being such notable churchmen as Augustine, Primasius, Cassiodorus, Bede, Anselm.

iii. Universal Historical Method of Interpretation.—A counter-attempt over against Joachim to interpret Revelation in the light of history was made by Nicolas of Lyra (1329, in his *Postilla*), following (?) therein the lead of Petrus Aureolus (1317). Here for the first time a consistently elaborated world-historical interpretation is carried out from the reign of Domitian to Lyra's own period. Under this method might be classed the expositions of Luther, Osiander, Striegel, Flacius, Gerhard and Calovius; and English writers such as Napier, Mede and Newton. Throughout these later commentaries a strong antipapal interest which identified the pope with the Antichrist held a central place—a doctrine which, as we have seen, goes back historically to the immediate disciples of Joachim and like-minded Franciscans.

iv. Contemporary-Historical Method.—Under the stress of the Protestant attack there arose new methods on the papal side, and their authors were the Spanish Jesuits, Ribeira (*ob.* 1591) and Alcasar (*ob.* 1614). With these writers we have the beginning of a scientific method of interpretation. They approach the book from the standpoint of the author and seek the clue to his writings in the events of his time. It is from these scholars that subsequent writers of Revelation have learnt how to study this book scientifically.² This method was adopted and developed by Grotius,³ Hammond, Clericus, Semler, Corredi and Eichhorn, Lücke, Bleek and Ewald, and the consciousness that Rome and not Jerusalem was the object of attack in Revelation became increasingly clear in the works of these scholars. The work of Ramsay, *The Letters to the Seven Churches* (1904), is a pure representative of this method.

v.-vii. Continuously Historical, Eschatological⁴ and Symbolical Methods.—These methods are now generally regarded as unscientific, and call for no further notice here save to mention that the first was upheld by Hengstenberg, Ebrard, Maitland, Elliott, &c.; the second by Kliefoth, Beck, Zahn, and the third by Auberlen, Luthardt, Milligan and Benson.

The learned Cambridge Commentary by Swete (*The Apocalypse of John*, 2nd ed., 1907) makes use of several of the methods of interpretation enumerated above. Thus Dr Swete writes (p. ccxviii) of his work: "With the 'preterists' (contemporary-historical) it will take its stand on the circumstances of the age and locality to which the book belongs, and will connect the greater part of the prophecy with the destinies of the empire under which the prophet lived; with the 'futurists' (eschatological) it will look for fulfillments of St John's pregnant words in times yet to come. With the school of Auberlen and Benson it will find in the Apocalypse a Christian philosophy of history; with the 'continuous-historical' school it can see

¹ The Jesuit Juan Mariana was the first after Victorinus to explain "the wounded head" as referring to Nero. This interpretation was introduced into Protestant exegesis by Corradi.

The beginnings of the literary-critical method are to be found in Grotius. Starting from the different dates assigned by tradition to the exile of Patmos and the different chronological relations implied in the book itself, he conjectured that the Apocalypse was composed of several works of St John, written in different places and at different times, some before, some after A.D. 70. Herein he was followed by Hammond and Lakemacher, but the idea was before its time and practically died stillborn.

⁴ Or futurist. While it is impossible to interpret the Apocalypse scientifically as a whole by the eschatological method, there are undoubtedly some sections in it which must be so interpreted.

³ The oldest Latin commentary was written by this scholar (*ob.* 1613). He was the first in extant literature to interpret certain passages in Revelation of Nero.

in the progress of events ever new illustrations of the working of the great principles which are revealed. And . . . it will gladly accept all that research and discovery can yield for the better understanding of the conditions under which the book was written." The chief value of this very scholarly book is to be found in its textual side.

The greater number of the methods discussed above have made no permanent contribution to the exegesis of Revelation; the method among them that has done most in this direction is the contemporary-historical. But, though this method has been applied in its fullness, and that by the keenest exegetes, there remains a consciousness that it has failed to solve many of the problems of the book. In many important points, however, its upholders are agreed, *i.e.* that the book is directed against Rome, that Nero *redivivus* is to be recognized in the wounded head, that the number 666 denotes Nero Caesar, and that in chap. xi. the preservation of the temple is foretold. Consequently the date of the composition of the book is placed before A.D. 70. Against the date assigned to the opening verses of this chapter modern scholars can make no objection, but, if this be the date of the entire work, then many passages in it are hopelessly inexplicable; for the latter just as certainly demand a date subsequent to A.D. 70 as xi. 1-2, a date prior to it. If, therefore, the possibilities of exegesis were exhausted in the list of methods already enumerated, science would have to put the New Testament Apocalypse aside as a hopeless enigma. But there is no such *impasse*. For in the New Testament Apocalypse there is not that rigid consistency and unity in detail that the past presupposed. The critical studies of recent years have shown that most of the Old Testament prophetic books are composite. And this holds true in no less a degree of most of the Jewish apocalypses. Such works are to be explained on what might be called the "fragmentary hypothesis." Other books, like the Ethiopic Enoch, exhibit a series of independent sources connected more or less loosely together. Such are to be explained on the "sources hypothesis." Others, like the Ascension of Isaiah, betray the handiwork of successive editors, and are accordingly to be explained on the "redaction hypothesis." Now modern scholars have with varying success used in turn these three hypotheses with a view to the solution of the problems of the New Testament Apocalypse. To these we shall now address ourselves.

II. Methods—Literary-Critical—presupposing some Degree of Compositeness in the Book.

1. *Redaction Hypothesis.*—Suggestions, as we have already observed, had been made in this direction, but it was not till Weizsäcker (*Theol. Literaturzeitung*, 1882, p. 78 seq.) reopened the question that the problem was seriously undertaken. In the same year his pupil Völter (*Die Entstehung der Apok.*, 1882, 1885) put forward the bold theory that the original Apocalypse consisted of i. 4-6, iv. 1-10, vi. 1-17, vii. 1-8, viii. 1-13, ix. 1-21, xi. 14-19, xiv. 1-3, 6, 7, xv. 14-20, xviii. 1-24, xix. 1-4, xix. 5-10a, which he assigned to the year A.D. 66 (so the second edition). To this the original author added as an appendix x. 1-13, xiv. 8, xvii. 1-18, in A.D. 68-70. The work underwent three later redactions at the hands of successive editors in the reigns of Trajan and Hadrian. Instead of the above complex theory this writer now offers another (*Die Offenbarung Johannis*, 1904)¹ in which he distinguishes an apocalypse of John, A.D. 65, i. 4-6, iv. 1-10, vi. 1-17, vii. 8, viii. 1-13, ix. 1-4, xiv. 1-3, 6, 7, xv. 14-20, xviii. 1-24, xix. 5-10 (pp. 3-56), an apocalypse of Cerinthus A.D. 70, x. 1-11, xvii. 1-18, xl. 1-13, xli. 1-16, xv. 5-6, 8, xvi. 1-21, xix. 11-21, xxi. 9-xxii. 6 (pp. 56-120), a redaction of the work in A.D. 114-15, i. 7-8, v. 6b, 11-14, vii. 9-17, xii. 11, 18-xiii. 18, xiv. 4-5, 9-12, xv. 1-4, 7, xvi. 19b, xvii. 14, 16, 17, xxi. 14, 22-27, xxii. 1-2, 8-9 (pp. 120-48), and certain additions, i. 1-3, 9-iii. 2, xiv. 13, xvi. 15, xxii. 7, 10-20, made in the time of Hadrian (pp. 148-171). First of all it should be observed that Völter was the first to

call attention to the radical difference in outlook between vii. 1-8 and vii. 9-17—a difference now generally recognized. Next it is noteworthy that in the second scheme here given Völter has abandoned his theory of a redaction hypothesis in favour of a sources hypothesis—a redactor. The earlier view of Völter was rejected on every side: the latter will not prove more acceptable, though individual suggestions of this scholar will be occasionally helpful. The problem was next dealt with by Vischer (*Die Offenbarung Johannis, eine Jüdische Apokalypse in Christlicher Bearbeitung*, 1886, 2nd ed., 1895), who took iv. 1-xxii. 5 to be a Jewish apocalypse revised and edited by a Christian, to whom he assigned i-iii., v. 9-14, vii. 9-17, xi. 8b, xii. 11, xiii. 9, 10, xiv. 1-5, 12, 13, v. 15, xvii. 14, xix. 9, 10, 13b, xx. 4b-5a, 6, xxi. 5b-8, 14b, xxii. 6-21, together with some isolated expressions and all references to the Lamb. This scheme met with a better reception than that of Völter, but it also has failed to solve the problem. In 1891 Erbes (*Offenbarung Johannis*, 1891) maintained that the book was entirely of Christian origin. The groundwork was written about A.D. 62. In this an editor incorporated a Caligula apocalypse, and a subsequent editor revised the existing work in many passages and made considerable additions, especially in the later chapters. Another attempt, mainly from this standpoint, has recently been made by J. Weiss of Marburg (*Offenbarung des Johannis*, 1904). This writer seeks to establish the existence of an original Christian apocalypse written before A.D. 60. This included (see p. 111) i. 4-6 (7, 8), 9-19, ii. 7-11, ix., xii. 7-12, xiii. 11-18, xiv. 1-5, 14-20, xx. 1-15, xxi. 1-4, xxii. 3-5, 8 seq. With this a Jewish apocalypse (x. 1-13, xii. 1-6, 14-17, xiii. 1-7, xv. 1-13, xvi. 9-27—see p. 115), written A.D. 70, was incorporated by the redactor. This latter apocalypse consisted of a series of independent prophecies which appeared to have the same crisis in view. This redactor, moreover, was the first who gave to the Apocalypse the character of an attack on the Roman Empire and the imperial cult by means of a series of small additions. In the above work we have a combination of the redaction and sources hypotheses.

ii. *Sources Hypothesis.*—The same year Weyland (*Theol. Tijdsch.*, 1886, 454-70; *Omwerkingen en Compilatie-Hypothesen toegepast op de Apoc. van Johannis*, 1888) advanced the theory of two Jewish sources (α and β), which were subsequently worked over by a Christian redactor. Such a theory as that just mentioned hopelessly fails to account for the linguistic unity of the book.

A very elaborate form of this theory was issued in 1884 (*Offenbarung Johannis*) by Spitta, who found three main sources in the Apocalypse. First, there was the primitive Christian apocalypse embracing the letters and the seals written by John Mark soon after A.D. 60,—i. 4-6, 9-19, ii. 1-iii. 22, iv. v. 1, viii. 1, vii. 9-17, ix. 9b, 10, xxii. 8, 10-13, 16a, 17, 18a, 20b-21. Secondly, the trumpet source of the time of Caligula. (*circa* 40),—vii. 1-8, viii. 2-ix. 1, x. 1-7, xi. 15, 19, xii-xxii. 18, xiv. 1-11, xvi. 13-20, xv. 11-21, xx. 1-3, 8-15, xxi. 1, 5a, 6a. Thirdly, the vials source from the time of Pompey (*circa* 63),—x. 1b, 2a, 8a, 9b, 10-11, xi. 1-13, 15b, 17, 18, xiv. 14-20, xv. 2-6, 8, xvi. 1-12, 17a, 21, xvii. 1-6a, xviii. 1-23, xix. 1-8, xxi. 9-xxii. 3a, 15. The rest of the book is from the hands of the redactor.

In 1891 Schmidt resolved the book into three independent sources which were put together by a redactor (*Anmerkungen über d. Komposition der Offenb. Johannis*).

In 1895 Briggs (*Messiah of the Apostles*, 1895) developed this theory to a still more extreme degree.

iii. *Fragment Hypothesis.*—The previous theories have brought to light and emphasized the fact that within the Apocalypse there are passages inconsistent with the tone and character of the whole. But, notwithstanding this fact, the Apocalypse gives a strong impression of its unity. Thus apparently the only remaining theory which can account for both these phenomena is that at which we have now arrived, *i.e.* the fragment hypothesis. To Weizsäcker we owe the first statement of this theory. In 1882 (*Theol. Literaturz.* pp. 78-9) he suggested

¹ Besides the works mentioned here Völter wrote two other works on the Apocalypse: *Die Offenbarung Johannis*, 1886; *Das Problem der Apokalypse*, 1893.

that while the book is a unity the author made free use of older materials. Later, in his *Apostolic Age* (1886, 2d ed. 1892), he specifies these additions as vii. 1-8 (A.D. 64-66), x-xi. 1-13 (circa A.D. 67), xii. 1-11, 12-17 (circa 69), xiii. (time of Vespasian), xvii. (time of Domitian).

Sabatier (*Les Origines littéraires . . . de l'Apocalypse*, 1888) regards the book as a unity into which its author had introduced older Jewish materials not always consistent with their new contexts, such as xi. 1-13, xii.-xiii., xiv. 6-20, xvi. 13, 14, 16, xvii. 1-xix. 2, xix. 11-xx. 10, xxi. 9-xxii. 5. The author wrote x. 1 with a view to adapting xi. 1-13 to its new context. Schoen (*L'Origine de l'Apocalypse*, 1887) attached himself in the main to the scheme of Sabatier. Both these writers assign the Apocalypse to the reign of Domitian.

The labours of these scholars, though to the superficial student they seem to prove that everything is possible and nothing certain, have certainly thrown great light on the literary character of the Apocalypse. Though differing in detail, they tend to show that, while the book is the production of one author, all its parts are not of the same date, nor are they one and all his first-hand creation. For many of the facts, the discovery of which we owe to the literary critics, have made the assumption of an absolute unity in the details of the Apocalypse a practical impossibility. Incongruities manifest themselves not only between certain sections and the main scheme of the book, but also between these and their immediate contexts. These sections are vii. 1-8a, xi. 1-13, xii., xiii., xvii., xviii., xx., xxi. 9-xxii. 5. Some of these sections (xi., xii., xiii., xvii.) contain elements that cannot be explained from any of the above methods. The symbols and myths in these are not the creation of the writer, but borrowed from the past, and in not a few instances the materials are too foreign to his subject to lend themselves to his purpose without the help of artificial and violent expedients. For the elucidation of these foreign elements a new method—the traditional-historical—is necessary, and to the brilliant scholar Gunkel we owe its origination.

iv. *Traditional-historical Method*.—Gunkel (*Schöpfung und Chaos in Urzeit und Endzeit; eine religionsgeschichtliche Untersuchung über Gen. 1 und Joh. 12*, 1895) opened up new lines of investigation. He criticizes sharply (pp. 173 sqq., 233 sqq.) former methods of interpretation, and with the ardour of a discoverer of a new truth seeks to establish its currency throughout the entire field of apocalyptic. To such an extreme does he carry his theory that he denies obvious references to historical personages in the Apocalypse, when these are clothed in apocalyptic language. Thus he refuses to recognize Nero in the beast and its number. But apart from its extravagances, his theory has undoubted elements of truth. It is true that tradition largely fixes the form of figures and symbols in apocalyptic. Yet each new apocalypse is to some extent a reinterpretation of traditional material, which the writer uses not wholly freely but with reverence from the conviction that they contained the key to the mysteries of the present and the past. From this standpoint it may be argued that every apocalypse is in a certain sense pseudonymous; for the materials are not the writer's own, but have come down to him as a sacred deposit—full of meaning for the seeing eye and the understanding heart. On the other hand, since much of the material of an apocalypse is a reinterpretation, it is necessary to distinguish between its original meaning and the new turn given to it in the Apocalypse. At times details in the transmitted material are unintelligible to our author, and these in some cases he omits referring to in his interpretation. The presence of such details is strong evidence of the writer's use of foreign material.

As an illustration of his theory Gunkel seeks at great length to establish the Babylonian origin of chap. xii. of the Apocalypse. His investigation tends to show that in the course of tradition cosmological myths are transformed into eschatological dogmas.

The above method was adopted by Bousset in his work *Der Antichrist in der Überlieferung des Judentums, des Neuen Testaments, und der alten Kirche* (1895), in which he sought to show that a fixed tradition of the Antichrist originating in

Judaism can be traced from New Testament times down to the middle ages, and that this tradition was in the main unaffected by the Apocalypse, though in chap. xi. the Apocalypse shows dependence on it. Next in 1896 he published his commentary *Die Offenbarung Johannis* (2nd ed. 1906). In this work he availed himself of the results of the past and followed the three approved methods—the contemporary-historical, the fragmentary and the traditional-historical.

Julicher (*Einleitung in das Neue Testament*, 1901, pp. 204-29) adopts the same three methods of interpretation.

Holtzmann (*Einleitung in das N.T.*, 1892; *Hand-Commentar*, 1893; *Lehrbuch der NTlichen Theol.*, i. 463-76) holds mainly to the contemporary-historical method in his earlier works, though recognizing signs of a double historical background; but in his last work the importance of tradition as a source of the writer's materials is fully acknowledged.

In 1902 O. Pfeiderer in the second edition of his *Urchristentum* (1902, pp. 281-335) abandoned his former view on the Apocalypse and followed essentially the lines adopted by Bousset, though the details are differently treated.

In the same year Porter's able article on "Revelation" appeared in Hastings' *Bible Dictionary* (iv. 239-66), and in 1905 his still fuller treatment of the same theme in *The Messages of the Apocalyptic Writers*, 169-294. To these works the present writer is indebted for many a suggestion.

A small commentary (no date) by Anderson Scott follows in some measure the lines laid down in Bousset and Porter.

Psychological Method.—It might be supposed that all possible methods had now been considered, and that a combination of the three methods which have established their validity in relation to the interpretation of the Apocalypse would be adequate to the solution of all the problems of the book, but this is not so; for even when each in turn has vindicated the provinces in the book that rightly belong to it, and brought intelligibility into these areas, there still remain outlying regions which they fail to illumine. It is not indeed that these methods have not claimed to solve the questions at issue, but that their solutions have failed to satisfy the larger body of reasonable criticism. The main problem, which so far has not been satisfactorily solved, may be shortly put as follows: Are the visions in the Apocalypse the genuine results of spiritual experiences, or are they artificial productions, mere literary vehicles of the writer's teaching? Weizsäcker unhesitatingly advocates the latter view. But the serious students of later times find themselves unable to follow in his footsteps. The writer's belief in his prophetic office and his obvious conviction of the inviolable sanctity of his message make it impossible to accept Weizsäcker's opinion. Nor is it possible to accept Gunkel's theory in *Schöpfung und Chaos* as an adequate explanation, who explained the author's conviction of the truth of his message as springing always from the fact that he was dealing with traditional material. This theory, which we have already dealt with in other connexions, is undoubtedly helpful, but here we require something more, and Gunkel has in consequence of Weinle's work (*Wirkungen des Geistes und der Geister*, 1899) subsequently acknowledged that actual spiritual experiences lie behind some of the visions in apocalyptic (Kautzsch, *Pseud. des A.T.*, ii. 341 sqq.). The fact of such visionary experience can hardly be questioned: the only difficulty lies in determining to what extent it underlies the revelations of apocalyptic. For a short discussion of this question we might refer to Bousset's *Offenbarung Johannis*, pp. 8 sqq., and Porter's article on "Revelation" in Hastings' *Bible Dictionary*, iv. 248 sqq.

Methods of Interpretation.—As a result of the preceding inquiry we conclude that the student of the Apocalypse must make use of the following methods—the contemporary-historical, the literary-critical (fragmentary hypothesis), the traditional-historical and the psychological. Each of these has its legitimate province, and the extent of this province can in most cases be defined with reasonable certainty.

Plan and Detailed Criticism of the Book.—Two theories have been advanced to explain the plan and order of the book. The

first of these is the *recapitulation theory* which Tyconius originated and Augustine adopted, and which has been revived in later times by Hofmann, Hengstenberg and others. This theory holds that no progress is designed in the successive visions of the seven seals, the seven trumpets and the seven bowls; for that in the vision of the seals we have already an account of the last judgment (vi. 12-17) and the blessed consummation (vii. 9-17). Thus the three groups form parallel accounts and contain the same or closely related material. But such a view is in conflict with the fact that the Apocalypse exhibits a steady movement from a detailed account of the condition of actual individual churches on an ever-widening sweep to the catastrophes that will befall every nation and country till at last evil is finally overthrown and the blessedness of the righteous consummated. Accordingly later exegetes hold that the seventh in each series is unfolded in the series of seven that follows. But to this theory also it has been objected (Holtzmann, *Hand-Commentar*, p. 294) that the bowls are in the main a repetition—in parts weaker, in others stronger—of what has already been put forward in the trumpets; that before the seventh member of each hebdomad there is a pause occasioned by the insertion of visions of a different nature; that the final judgment has already been depicted in vi. 17, and yet further descriptions recur in x. 6, 7, xi. 15-18, xiv. 7, xix. 11: the temple in heaven is opened in xi. 19 and yet again in xv. 5: heaven itself has already been rent in sunder in vi. 12-17, and yet in viii. 7-12 is supposed to be in its ancient order: all green grass is burnt up in viii. 7, yet in ix. 4 the locusts are not permitted to injure the grass, and other like inconsistencies.

The impossibility of logically carrying out either theory has given rise to doubts as to the unity of the book. Holtzmann (*Hand-Comment.* 295) represents its structure as follows:—

- i. 1-8 . . . Introduction.
- i. 9-viii. 22 . . . Group of seven letters.
- iv.-v. 14 . . . Heavenly scene of the Vision.
- vi. 1-17 . . . Six seals.
- vii. 1-17 . . . The sealed and the blessed.
- viii. 1-5 . . . The emergence of the trumpets from the seventh seal.
- viii. 6.-ix. 21 . Six trumpets.
- x. 1.-xi. 14 . . . Destiny of Jerusalem.
- xi. 15-19 . . . The seventh trumpet.
- xii. 1-xiv. 5 . . . The great visions of the three chief enemies and of the Kingdom of the Messiah.
- xiv. 6-20 . . . Return to the earlier connexion.
- xv. 1-xvi. 1 . . . Transition to the bowls.
- xvi. 2-21 . . . Seven bowls.
- xvii. 1-xix. 10 The great Babylon.
- xix. 11-xx. 15 Final catastrophes.
- xxi.-xxii. 5 . . . The New Jerusalem.
- xxii. 6-21 . . . Conclusion.

It is noteworthy that the sections on the right hand correspond in the main to the elements which have been those to which

¹ Swete divides the Apocalypse first of all into forty-two minor sections. Next he groups these sections into fourteen larger masses of apocalyptic matter, and by a process of synthesis seeks to arrive at the plan on which the author constructed his book. In so doing he points out that we become conscious of a great cleavage which practically divides the book into two parts, i. 9-xi. 14 and xii. 1-xxii. 5, independently of the prologue and greeting, i. 1-8, and the epilogue and benediction, xxii. 6-21. A further study of the leading thoughts of the above parts enables him to set forth the scheme of the book as follows:—

PROLOGUE AND GREETING, i. 1-8.

- Part I. Vision of Christ in the midst of the churches, i. 9-viii. 22.
- Vision of Christ in Heaven, iv. 1-10. 14.
- Preparations for the End, vi. 1-xi. 10.

- Part II. Vision of the Mother of Christ (*i.e.* the Church) and her enemies, xii. 1-xiii. 18.

Preparations for the End, xiv. 1-xx. 15.

Vision of the Bride of Christ arrayed for her husband,

xxi. 1-xxii. 5.

Epilogue and benediction, xxii. 6-21.

the latest critics have assigned either an earlier date or a different authorship.

Chaps. i.-iii.—These chapters open with a prologue, i. 1-3, which defines the source, character and contents of the book, followed by a greeting, i. 4-8, in which the writer salutes the Seven Churches of Asia. Having so introduced his work the author describes a vision of the ascended Christ, i. 9-20, who sends His messages to the angels of the Seven Churches, ii.-iii. With the conclusion of these epistles the Apocalypse proper really begins. But the way has been prepared for it. Its contents are "the things which must quickly happen," i. 1. The visions are not for John's personal benefit, but for transmission to the church at large, i. 11, and the writer is bidden to write down what he has seen and "the things which are and the things which shall be hereafter," i. 19.

iv.-vi.—The first three chapters show great artistic skill, and the power of the artist is no less conspicuous in what follows. First of all John is bidden to come up into heaven and see the things that should be hereafter, the vision of iv. 1. Then he beholds the Almighty on His throne surrounded by the four and twenty elders and the four living creatures. Before Him they all bow in worship and acknowledge that by Him were created all things and of His own free will were all created. In the next chapter (v.) the seer has a vision of a roll in the hand of Him that sat on the throne which none could open or look upon, till the Lion of the tribe of Judah, the mighty one with seven horns and seven eyes, appeared. Before Him all the elders and the living creatures fell down and acknowledged that He had power to open the seven seals thereof, and their song was re-echoed by every thing alike in heaven and earth. The contrast between these two chapters and those that follow is striking in the extreme. The time of the seer's vision is one of direst need. The life and death struggle between the church and the empire has now entered on its final stage, and fear and trouble and woe are rife in the hearts of the faithful. But when the seer is exalted to heaven he sees no trace of the turmoil on earth. The vision of the Almighty is full of majesty and peace. All things do Him service; for all are the free creation of His will. The next vision serves to connect the Source and Sustainer of all things with the world and its history. The closing of the intermediate stage of the history of created things is committed to the Christ who will also be Lord of the age to come. The future of the saints is assured: what can avail against Him that hath "glory and dominion for ever and ever" the wild attacks of Rome and even of Satan and his hosts? The Lamb that was slain has taken upon Himself the burden of the world's history.

In vi. we have the opening of the six seals, and the horrors of the future begin. The choice of three series of seven seals, seven trumpets and seven bowls, to form the framework in which the history of the last woes is to be given, shows the same hand that addressed the churches as seven. But between the sixth and seventh seals and the sixth and seventh trumpets the connexion is more or less disturbed by the insertion of certain interludes containing material foreign in certain aspects to the Apocalypse. These are vii. 1-17 and x. 1-xi. 14.

vii. 1-17.—These verses, which interrupt the plan of the book, fall into two independent fragments, 1-8 and 9-17, which are inconsistent in their original meaning with each other. For while 1-8 was most probably a Jewish apocalyptic fragment and strongly particularistic, 9-17 is clearly universalist in character and is probably from the hand of our author. The foreign origin of vii. 1-8 may be concluded with Spitta, Bousset and others from the fact that the four winds, which in vii. 1 are said to be held fast lest they should break in elemental fury on land and sea, are not let loose or referred to in the subsequent narrative, and also from the mention of the 144,000 Israelites of the twelve tribes, to whom no further reference is made; for these can no more be identified with the countless multitudes in vii. 9-17 than with those who are "sealed" in ix. 4 sq. nor with the 144,000 in xiv. 1; for in both these cases the sealed are not Jews but elect Christians. The object of both fragments was to encourage the faithful in the face of the coming strife. In the

latter, in which the Apocalypticist looks forward prophetically to the issue, the assurance held out is of ultimate victory, but of victory through death or martyrdom. In the former (Jewish or Christian-Jewish fragment) the sealing seemed to have carried with it the assurance of deliverance from physical death, as in Ezek. ix. 4 sqq. But in its *new* context this meaning can hardly be retained. Not improbably the sealing means to our author the preservation not from death, but through death from unfaithfulness, and the number 144,000 would signify mystically the entire body of true Christians, which formed the true people of God.

Chapter vii., then, interrupts the development of the author's plan, but the interruption is deliberate. He wishes to encourage the persecuted church not only to face without fear, but also to meet with triumphant assurance the onset of those evils which would bring panic and despair on the unbelieving world.

viii.-ix.—These chapters, though presenting some minor difficulties, do not call for discussion here. They recount the six partial judgments which followed the opening of the seventh seal and the blasts of the six trumpets.

x.-xi. 1-13.—This section bristles with difficulties. Chapter x. forms an introduction to xi. 1-13. In it the prophet receives a new commission, x. 11: "Thou must prophesy again over many peoples and nations and tongues and kings." This new commission explains his departure from the plan pursued in the earlier chapters of developing the seventh in each series to a new series of seven. The seer has a vision of the seven thunders, but these he is bidden to seal and not commit to writing. He is instead to write down the new book of prophecies. The end is at hand. It is noteworthy that in the earlier visions it was Christ who spoke to the seer. Here and in the later visions, especially those drawn from foreign sources, it is an angel.

In xi. 1-13 we have a characteristic illustration of our author's dependence on traditional materials and his free adaptation of them to meanings other than originally belonged to them. For it is generally agreed among critics that xi. 1-13 is borrowed from Jewish sources, and that this fragment really consists of two smaller fragments, xi. 1-2 and xi. 3-13. The former oracle referred originally to the actual Temple, and contained a prediction of the preservation of the Temple. It must have been written before A.D. 70 and probably by a Zealot.¹ But our author could not have taken it in this literal sense if he wrote after A.D. 70 or even anterior to that date, owing to the explicit declaration of Christ as to the coming destruction of Jerusalem. The passage, then, must have a spiritual meaning, and its purpose is the encouragement of the faithful by the assurance of their deliverance not necessarily from physical death but from the dominion of the evil one. In xi. 3-13 we have another Jewish fragment of a very enigmatic character. Bousset has shown with much probability that it is part of the Antichrist legend. The prophecy of the two witnesses and their martyrdom belongs to this tradition. The fragment was apparently written before A.D. 70, since it speaks of the fall of only a tenth of the city, xi. 13.² The significance of this fragment in our author's use of it is similar to that of xi. 1-2. The details defy at present any clear interpretation, but the incorporation of the fragment may be due in general to the emphasis it lays on the faithful witness, martyrdom and resurrection of the saints.

xi. 14-19.—The seventh trumpet, xi. 15, ushers in the third see, xi. 14. Its contents are given in xii.-xx. In xi. 15-19 the seer hears great voices in heaven singing a triumphal song in anticipation of the victory that is speedily to be achieved. This song forms a prelude to the chapters that follow.

¹ The Zealots occupied the inner court of the Temple during its siege by the Romans.

² The linguistic evidence, as Bousset has pointed out, confirms the critical conclusion that xi. 1-13 were independent sources. For whereas in ix.-x. the verb almost regularly begins the sentence and the object follows the verb, in xi. 1-13 the object frequently precedes the verb and the subject nearly always. The order of the genitive in xi. 4 is elsewhere unknown in the Apocalypse, and in xi. 2, 3 the construction of *Abrahas* followed by *et* instead of infinitive or *tra* is unique in this book.

xii.—This is the most difficult chapter in the book. Its main intention in its present context is apparently to explain Satan's dominion over the world and the bitterness of his rage against the church and against Christ. Christ, indeed, escapes him and likewise the Jewish Christians ("the woman," xii. 16) but "the rest of her seed," xii. 17 (the Gentile Christians?), are exposed to his fury. But his time is at hand; together with his hosts he has been cast down from heaven, and on the earth he "hath but a short time." The attribution of the seven heads and ten horns to the dragon, xii. 3, points forward to Rome, which is regarded as a temporary incarnation of Satan, xiii. 1, xvii. 3.

But, though a few of the leading thoughts of this chapter may be obvious, we are plunged into problems that all but defy solution when we essay to discover its origin or interpret its details. Most scholars are agreed that this chapter is not, except in the case of a few sentences, the work of our author. In other words, it has been taken over from pre-existing material—either Christian or Jewish—and the materials of which it is composed are ultimately derived from non-Jewish sources—either Babylonian, Greek or Egyptian—and bore therein very different meanings from those which belong to them in their present connexion. Furthermore, the materials are fragmentary and the order irregular.

(a) First of all, the chapter is not the free creation of a Christian writer. Such an one could never have so represented the life of Christ—a child persecuted by a dragon and carried off to God's throne. No mention of Christ's earthly life and crucifixion. Furthermore, the victory over Satan is ascribed to Michael. Again, a Christian could not represent Christ as the son of the wife of the sun-god; for such is the natural interpretation of the woman crowned with the twelve stars and with her feet upon the moon. Finally, even if "the woman" who is the mother of Christ be taken to be the ideal Israel in the beginning of the chapter, at its close she is clearly the Christian community founded by Him. We conclude, therefore, that the present chapter is not the work of our author. There are, however, traces of his hand. Thus 7-12, which is really a Jewish fragment recounting the victory of Michael over Satan, has to a certain degree been adapted to a Christian environment by the insertion of the 10b-11.

(b) The order is not original. The flight of the woman is mentioned in verse 6 to a place of refuge prepared for her by God. Then comes an account of the casting down of Satan from heaven. Then again in 13-16 the flight of the woman is described. This fact has been variously accounted for by different critics. Wellhausen regards 1-6 and 7-14 as doublets, and differentiates two actions in the original account which are here confused. Spitta takes verse 6 to be an addition of the redactor, which describes proleptically what follows, while Gunkel sees in 6 and 7-16 parallel accounts. In any case we should probably agree with the contention of J. Weiss, supported by Bousset in the second edition of his commentary, that 7-12 is a fragment of a Jewish apocalypse, of which 10b-11 is an addition of our author. Next that 6 is a doublet of 13 sqq. What then is to be made of 1-5, 13-17? Different explanations have been offered. Gunkel³ traces it to a Babylonian origin. He urges that an adequate explanation is impossible on the assumption of a Jewish or Christian origin. At the base of this account lies the Babylonian myth of the birth of the sun-god Marduk, his escape from the dragon who knows him to be his destined destroyer, and the persecution of Marduk's mother by the dragon. But Gunkel's explanation is an attempt to account for one *ignotum per ignotius*; for hitherto no trace of the myth of the sun-god's birth and persecution and the flight into the wilderness has been found in Babylonian mythology. Moreover, Gunkel no longer lays emphasis on the Babylonian, but merely on the mythical origin of the details. A more satisfactory explanation has been offered by Dieterich (*Abraxas*, 17 sqq.), who finds in this chapter an adaptation of the birth of Apollo and the attempt of the dragon Python to kill his mother

³ *Schöpfung und Chaos* § 3, *Religionsgesch. Verständniss d. N.T.*, 54 sqq.

Leto, because it was foretold that Leto's son would kill the dragon. Leto escapes to Ortygia, which Poseidon covers with the sea in order to protect Leto. Here Apollo is born, who four days later slays the dragon. Yet another explanation from Egyptian mythology is given by Bousset (*Offenbarung Johannis*, 2nd ed., pp. 354, 355) in the birth of the sun-god Horus. Here the goddess mother is represented with a sun upon her head. Typhon slays Horus. Hathor, his mother, is persecuted by Typhon and escapes to a floating island with the bones of Horus, who revives and slays the dragon.¹ There are obvious points of similarity, possibly of derivation, between the details in our text and the above myths, but the subject cannot be further pursued here, save that we remark that in the sun myth the dragon tries to kill the mother before the child's birth, whereas in our text it is after his birth, and that neither in the Egyptian nor in the Greek myth is there any mention of the fight into the wilderness.

The insertion of the alien matter 7-12 between 1-5 and 13-17 may be due to our author's wish to show that the expulsion of Satan from heaven after Christ's birth and ascension to heaven was owing in some measure to Christ, although he has allowed Michael's name to remain in the borrowed passage, 7-12—a fact which shows how dependent the writer was on tradition.

xiii.—In this chapter we have the two beasts² which symbolize respectively Rome and the Roman provincial priesthood of the imperial cult. Thus the world powers of heathen statesmanship and heathen religion are leagued in a confederacy against the rising Christian Church. Against these the church is not to attempt to use physical force; its only weapon is to be passive endurance and loyalty to God.

That this chapter must be interpreted by the contemporary-historical method is now generally admitted. Even Gunkel is obliged to abandon his favourite theory here, though he contests strongly the recognition of any allusion to Nero. Various solutions have been offered as to the seven emperors designed by the seven heads of the beast, xiii. 1. But the details of this passage are not sufficiently definite to determine the question here. It will return in chapter xvii. There are, however, two facts pointing to a late date. The first is the advanced stage of development of this, the Neronic-Antichrist legend. One of the heads "is smitten unto death," but is healed of the death stroke. This points, we may here assume, to the Nero *redivivus* legend, which could not have arisen for a full generation after Nero's death, and the assumption receives large confirmation from the most probable interpretation of the enigmatical words, xiii. 18, "the number of the beast . . . is six hundred and sixty six." Four continental scholars, Fritzsche, Benary, Hitzig and Reuss, independently recognized that Nero was referred to under the mystical number 666. For by transliterating Καῖσαρ Νερώων into Hebrew פ"ך קס"ו and adding together the sums denoted by the Hebrew letters we obtain the number 666. This solution is confirmed by the fact that it is possible to explain by it an ancient (Western?) variant for the number 666, *i.e.* 616. This latter, which is attested by Irenaeus (v. 30. 1), the commentary of Ticonius, and the uncial C, can be explained from the Latin form of the name Nero, which by its omission of the final *n* makes the sum total 616 instead of 666.

The above solution may be regarded as established, though several scholars, as Oscar Holtzmann (*Stade's Geschichte des Volkes Israel*, i. 661), Spitta and Erbes, have contended that 616 was the original reading (ἑξάκιστος Καῖσαρ=616) and that

¹ On the possibility of other points of contact between the Apocalypse and Egyptian mythology, see Mrs Grenfell's article, "Egyptian Mythology and the Bible," in the *Monist* (1906), pp. 169-200.

² In xiii. 2 the description of the beast unites the features of the four beasts in Daniel's vision (vii.). It is clear that our author identified the fourth beast (vii. 23) with Rome, as did also the author of 4 Ezra xii. 10. But this was not the original significance of the fourth beast; for the author of Daniel referred thereby to the Greek empire; but, since the prophecy was not realized, it was subsequently reinterpreted, and applied, as we have observed, to Rome.

chapter xiii. was part of a Jewish apocalypse written under Caligula between the years 39 and 41. But this Caligula hypothesis cannot be carried out unless by a vigorous use of the critical knife, in the course of which more than a third of the chapter is excised. Moreover the number 616 is too weakly supported to admit of its being recognized as the original.

The figure of the first beast presents many difficulties, owing to the fact that it is not freely invented but largely derived from traditional elements and is by the writer identified with the seventh wounded head. The second beast, signifying the pagan priesthood of the imperial cult, called "the false prophet" in xvi. 13, appears to be an independent development of the Antichrist legend.

xiv.-xvi.—These chapters contain a vision of Christ on Mount Zion and the 144,000 of the undefiled that follow Him, xiv. 1-5, the last warnings relating to the harvest and vintage of the world, xiv. 6-20: the vision of the wrath of God in the out-pouring of the seven bowls containing the seven last plagues, xv.-xvi.

In the above section most critics are agreed that xiv. 14-20 originally represented the final judgment and was removed from its rightful place at the close of an apocalypse to its present position. In its original setting "the one like unto a Son of Man, having on his head a golden crown" (xiv. 14), undoubtedly designated the Messiah, but the transformation of the final judgment into a preliminary act of judgment by a redactor, necessarily brought with it the degradation of the Son of Man to the level of a mere angel. Some critics hold that this apocalypse was the apocalyptic groundwork, but Bousset is of opinion that it stood originally in connexion with xi. 1-13.

As regards xvi. the views of critics take different directions, but that of Bousset followed by Porter seems the most reasonable. This is that this chapter forms an introduction to xvii., which was an independent fragment. The writer throws this introduction into his favourite scheme of seven acts, in this case symbolized by seven bowls. The earlier verses, 2-11, do not amount to much beyond a repetition of what is found in viii.-ix., save that as a preparation for xvii. references are inserted to the beast and his worshippers (ver. 2) and to Rome (ver. 10). In xvi. 12-16 is a revised form of an older tradition.

xvii.—This chapter presents great difficulties, especially if with the older and some of the recent exegetes we regard it as written at the same time and by the same author. Even so strong an upholder of the unity of the book as Swete is ready to admit that portions of xvii., as well as of xiii., show signs of an earlier date than the rest of the book. He writes: "The unity of the Book . . . cannot be pressed so far as to exclude the possibility that the extant book is a second edition of an earlier work, or that it incorporates earlier materials, and either hypothesis would sufficiently account for the few indications of a Neronic or Vespasianic date that have been found in it" (*Apoc. of St John*², p. civ.). This chapter cannot be interpreted apart from the Neronic myth. Of this there appear to be two stages attested here. Of the earlier we have traces in xvii. 16-17 and xvi. 12, where there are allusions to Nero's confederacy with the Parthian kings with a view to the destruction of Rome. Of the later stage, when the myth of Nero *redivivus* was fused with that of the Antichrist, we have attestation in xvii. 8, 12-14, where Nero is regarded as a demon coming up from the abyss to war not with Rome but with Christ and the elect. This development of the Neronic myth belongs to the last years of the 1st century, and is decidedly against a Vespasianic date. To meet this difficulty a recent interpreter—Anderson Scott—though he assigns the book to the year A.D. 77, is yet willing to admit that the book though composed in the reign of Vespasian was "reissued with additions by the same hand after the death of Domitian" (*Revelation*, p. 56). Our author represents himself as writing under the sixth emperor. Five have already died, the seventh is yet to come, to be followed by yet an eighth, who is one of the seven (*i.e.* Nero). In order to arrive at the date here implied, we can

begin the reckoning from Julius Caesar or Augustus, we can include or exclude Galba, Otho and Vitellius, and, finally, when we have drawn our conclusions from these data, there remains the possibility that the book was after all not written under the sixth emperor, but was really a *vaticinium ex eventu*. According to the different methods pursued, some have concluded that Nero was the sixth emperor, and thus dated the Apocalypse before A.D. 70; others Vespasian, and yet others Domitian. No solution of the difficulties of the chapter is wholly satisfactory, but the best yet offered seems to be that of Bousset (*Offenbarung*, 410-18). He holds that 1-7, 9-11, 15-18, belong to an original source, which was written in the reign of Vespasian and represents the earlier stage of the Neronian myth. To a reviser in Domitian's reign we owe 8, 12-14 and 24, a clause in 9, ἐν τῷ ὄρει . . . αὐτῶν, and another in 11, ὃ ἦν καὶ οὐκ ἔστιν. If the clause καὶ ἐκ τοῦ ἀλμαρῶν τῶν μαρτύρων Ἰησοῦ in 6 is an addition, then he thinks the source was Jewish and the "blood of the saints" was that shed at the destruction of Jerusalem, and the forecast of the author related to the destruction of Rome. When the reviser recast the passage it dealt not with the destruction of Jerusalem, but with the persecution of the Christians. Nero was now a demonic monster from the abyss, and the ten kings no longer Parthians but ghostly helpers of Nero. The destruction of Rome has now become a secondary event: the reviser's thought is fixed on the final strife between the Lamb and the Antichrist.

xviii.-xix. 10.—This section describes in prophetic language borrowed almost wholly from Isaiah and Jeremiah the coming judgment of Rome, and gives the ten lamentations of the kings and the merchants and the seamen over her, and the thanksgivings in heaven for her overthrow.

xix. 11-21.—The victory of the warrior Messiah over the two beasts, the Roman Empire and the imperial cultus and the kings of the earth. Many of the ideas set forth in earlier chapters here coalesce and find their consummation. The Messiah, whose birth and escape from the dragon was recounted in xii. 5, and who was to rule the nations with a rod of iron, at last appears in discharge of His office. The beast and the false prophet who are described in xiii. are cast alive into the lake of fire, and the kings of the earth who had assembled for this conflict, xvi. 14, xvii. 14, were slain by the sword of Him that sat on the horse.

The conception of the Messiah may be Jewish: at all events it is not distinctively Christian. The title "Word of God" can hardly be said to establish any connexion with the prologue of the Fourth Gospel; for the conceptions of the Messiah in that Gospel and in these chapters belong to different worlds of thought.

It is to be observed that our author follows the apocalyptic scheme of two judgments which is first attested about 100 B.C. The first judgment precedes the establishment of the temporary Messianic kingdom, as here in xix. 10-21; and the final judgment follows at its close, as here in xx. 7-10.

xx. 1-6.—The millennium, or the period between the first and final judgments, when Christ, with His chosen, reigns and Satan is imprisoned. Rome has been overthrown, but, as Rome is only the last secular manifestation of Satan, there is yet the final struggle with Satan and his adherents. But the time for this struggle has not yet arrived. Satan is bound¹ and cast into the abyss, and the kingdom of Christ and of the martyrs and faithful confessors established for a thousand years. Thus it is shown that evil will be finally overcome; for that the true and ultimate power even in this world belongs to Christ and those that are His.

The main features of this section have been borrowed from Judaism. The Messianic kingdom was originally conceived of as of everlasting duration on the present earth, but about 100 B.C. this idea was abandoned and the hopes of the faithful were directed to a temporary earthly kingdom of 400 or 1000 years or of indefinite duration (see R. H. Charles, *Critical History of*

the Doctrine of a Future Life, pp. 201-4, 261, 286, 288). Moreover, the expectation that the saints would rise to share in the blessedness of this kingdom is also found in Judaism, 4 Ezra vii. 28 (*op. cit.* p. 285).

xx. 7-10.—Release of Satan and final assault on the city of God by the hosts of Gog and Magog at the instance of Satan. Satan and the beasts condemned to eternal torment.

xx. 11-14.—The Final Resurrection and Judgment.

xxi. 1-8.—The new heavens and the new earth. The language in this and the following section is highly figurative; but as Porter has well remarked: "Figurative language is the only language in which we can express our hope of heaven, and no figures can have greater power to suggest this hope than those taken from the literal longings of exiled Israel for the recovery of its land and city."

xxi. 9-xxii. 5.—The vision of the New Jerusalem. There are several grounds for regarding this section as an independent source possibly of Jewish origin and subsequently submitted to a Christian revision. This view is taken by Vischer, Weyland, Spitta, Sabatier, J. Weiss, Bousset and others. Our author has incorporated it as describing the consummation of the prevision contained in xi. 15-18, in which he foresaw the time when the kingdom of the world would become the kingdom of our Lord and of His Christ, and the saints should enter on their reward. Moreover, he has already hinted at its contents in xix. 7 and xxi. 2, where he speaks of the church as a bride and the marriage supper of the Lamb. But the section betrays inconsistent conceptions. The standpoint of the heavenly Jerusalem is abandoned in xxi. 24-27, xxii. 2, and the context implies an earthly Jerusalem to which the Gentiles go up as pilgrims. Outside the gates of this city are unclean and abominable things. These inconsistencies are best explained by the hypothesis that our author was drawing upon a literary fixed tradition. The doublets in xxi. 23 and xxii. 5b, in xxi. 25 and xxii. 5a, and in xxi. 27 and xxii. 3, point in the same direction. Various additions were introduced, according to Bousset, by the last redactor, such as the frequently recurring reference to the Lamb, xxi. 9, 22, 23, 27, xxii. 1, 3. In xxi. 3 the fact that the words "of the Lamb" are an addition is clear from the context; for, after the clause "the throne of God and of the Lamb shall be therein" the singular follows, "His servants shall do Him service."

xxii. 6-21.—The conclusion. The promises are sure, the end is near and the judgment at hand. The words of the book are the message of Christ Himself and are inviolable.

Unity.—From the preceding sections it follows that we cannot ascribe a strict literary unity to the book. The book is most probably the work of a single author, but it was not written wholly at one date, nor have all the parts come directly from one brain. We have several good grounds, for regarding vii. 1-8, xi. 1-13, xii., xiii., xvii., as wholly or in part independent sources, which our author has laid under contribution and adapted more or less adequately to his purpose. He appears to have taken over with but slight modification xx. and xxi. 9-xxii. 5. Furthermore, while certain fragments such as xi. 1-2 presuppose a date anterior to A.D. 70, others, as xvi. 12 and xvii. 12, require a date not later than Vespasian's time; other parts of xvii. postulate a Vespasianic date as the earliest admissible, and, finally, the composition of the book in its present form cannot be placed before the closing years of Domitian. But to this question we shall return presently.

Nevertheless, the book exhibits a relative unity; for, whatever digressions occur in the development of its theme, the main object of the writer is never lost sight of. This relative unity is manifested also in the uniform character of the language, a uniformity, however, which is occasionally conspicuous by its absence in the case of independent sources, as in xi. 1-13. The author or the final redactor has impressed a certain linguistic character on the book, which differentiates it not only from all secular writings of the time, but also from all the New Testament books, including the Johannine. And yet the Apocalypse shows in many of its phrases an undoubted affinity to the latter—

¹ This idea appears as early as the 2nd century B.C. Cf. Test. Levi xviii. 12.

a fact which requires for its explanation the assumption that the book emanated from certain literary circles influenced by John.

Date.—There are many indications of the date, which may be summarized as follows: (a) Condition of the Asian churches. (b) Persecution of the church. (c) Attitude of the author to Rome. (d) The Antichrist legend. (e) Primitive tradition and its confirmation through the discovery of references in the text to certain edicts of Domitian. As a result of these considerations we may arrive at the date of the work with almost greater certainty than that of any other New Testament book.

(a) *Condition of the Churches.*—Christianity appears to have already had a long history behind it. The fact that St Paul founded the church of Ephesus seems to have been forgotten. The earliest zeal has passed away and heathen ways of thought and life are tolerated and practised at Pergamum and Ephesus, and faith is dying or dead at Laodicea and Sardis. These phenomena belong to a period considerably later than the time of Nero.

(b) *Persecution of the Church.*—Persecution is the order of the day. Each of the seven letters concludes with praise of those who have been victorious therein. There had been isolated instances of persecution at Ephesus, ii. 3, Philadelphia, iii. 8, 10, and at Smyrna, ii. 9, and of an actual martyrdom at Pergamum, ii. 13. But now a storm of persecution was about to break upon the universal church, iii. 10, and in the immediate future. Already the seer beholds the destined number of the martyrs complete, vi. 9-11: the great multitude whom no man could number, clothed in white before the throne of God, vii. 9; he exhorts his readers to patient endurance unto death, xiv. 12, and already sees them as victors in heaven, xv. 2. Over the true witnesses and martyrs he pronounces the final beatitude of the faithful: "Blessed are those who die in the Lord," xiv. 13.

Such an expectation of persecution is inexplicable from Nero's time. There is not a trace of any declaration of war on the universal church in his period such as the Apocalyptic anticipates and in part experiences. Christian persecution under Nero was an imperial caprice. The Christians were attacked on slanderous charges of superstition and secret abominations, but not as a church. Not till the last years of Domitian is it possible to discover conditions which would explain the apprehensions and experiences of our writer. So far as we can discover, no persecution was directed against Christians as Christians till Domitian's time. In the year A.D. 92 Flavius Clemens was put to death and his wife banished, on the ground that they were adherents of the new faith. Thus the temper of the book on this question demands some date after A.D. 90. It marks the transition, from the earlier tolerant attitude of Rome towards Christianity, to its later hostile attitude.

(c) *Attitude of the Author towards Rome.*—In earlier times the church had strongly impressed the duty of loyalty to Rome, as we see from the Epistle to the Romans and 1 Peter. This was before the pressure of the imperial cult was felt by the Christian church. But in the Apocalypse we have the experiences of a later date. The writer manifests the most burning hatred towards Rome and the worship of its head—the beast and the false prophet, who are actual embodiments of Satan. Such an attitude on the part of a Christian is not explicable before the closing years of Domitian; for, apart from Caligula, he was the first Roman emperor who consistently demanded divine honours.

(d) *The Antichrist Legend.*—We find at least two stages of the Neronic and Antichrist myth in the Apocalypse. The earliest form is not attested here, that Nero had not really been slain, but would speedily return and destroy his enemies. The first pretender appeared in A.D. 69, and was put to death in Cythrus. The second stage of this legend was that Nero had taken refuge in the Far East, and would return with the help of his Eastern subjects for the overthrow of Rome. Two pretenders arose in conformity with this expectation among the Parthians in A.D. 80 and 88. This widespread expectation has left its

memorial in our book in xvi. 12 and in xvii. 16-17, which point to the belief that Rome would be destroyed by Nero and the Parthian kings. Finally, in xvii. 8, 12-14, we have a later phase of the myth, in which there is a fusion of the Antichrist myth with that of Nero *redivivus*. This fusion could hardly have taken place before the first half of Domitian's reign, when the last Neronic pretender appeared. As soon as the hope of the living Nero could no longer be entertained, the way was prepared for this transformation of the myth. The living Nero was no longer expected to return from the East, but Nero was to be restored to life from the abyss by the dragon, i.e. Satan. This expectation is recounted in xvii., but it appears most clearly in the additions to xvii. Thus in xvii. 8 the reference to Nero *redivivus* as the Antichrist is manifest: "The beast that thou sawest was, and is not, and is about to come up out of the abyss and to go into perdition."¹ Thus again we are obliged to postulate a date not earlier than A.D. 90 for the book in its present form.

(e) *Primitive Church Tradition and its Confirmation through the Discovery of References in the Text to Certain Edicts of Domitian.*

—The earliest external evidence is practically unanimous in ascribing the Apocalypse to the last years of Domitian. The oldest testimony is that of Irenaeus v. 30. 3: *δὲ ἐκείνου ἐν ἐρήθει τοῦ καὶ τῆν Ἀποκάλυψιν ἰσορακότος οὐδὲ γὰρ πρὸ πολλοῦ χρόνου κορήθη, ἀλλὰ σκεδόν ἐπι τῆς ἡμετέρας γενεᾶς, πρὸς τῷ τέλει τῆς Διομηττιανοῦ ἀρχῆς.* The rest of the patristic evidence from Clement of Alexandria, Origen, Victorinus, Eusebius and Jerome will be found in Swete's *Apocalypse of St John*², xcix. seq. Though a few later authorities, such as Epiphanius and Theophylact, assign the book to earlier or later periods, the main body of early Christian tradition attests the date of its composition in the closing years of Domitian. Notwithstanding, on various critical grounds, Baur, Hilgenfeld, Lightfoot, Westcott, Hort and Beyschlag assigned the book to the reign of Nero, or to the years immediately following his death, while Weiss, Dusterdieck and Mommsen assign it to the time of Vespasian. When, however, we combine the preceding arguments with that of the early church tradition, the evidence for the Domitian date outweighs that for any other. And this conclusion receives remarkable confirmation from a recent fact brought forward by S. Reinach in an article in the *Revue archéologique*, sér. III. t. xxxix. (1901), pp. 350-74, and reprinted in *Cultes, mythes et religions*, ii. 356-80 (1906). This fact explains a passage which has hitherto been a total enigma to every expounder, i.e. vi. 6: "A choenix of wheat for a denarius, and three choenicks of barley for a denarius, and the oil and the wine hurt thou not." Swete writes here: "The vice fixes a maximum price for the main food-stuffs. The denarius . . . was the daily wage . . . and a choenix of wheat

¹ Verse 11 postulates either a Vespasianic or Domitianic date: "And the beast that was, and is not, is himself also an eighth, and is of the seven; and he goeth into perdition." In verse 10 it is stated that five of the seven had fallen, "the one is and another is not, yet come, and when he cometh he must continue a little while." If we reckon from Augustine and omit Galba, Otho and Vitellius, each of whom reigned only a few months, we arrive at Domitian. The vision, therefore, belongs to his reign, A.D. 69-79. Verse 11, with the exception of the words "which was and is not," leads to the identification of the eighth with Nero *redivivus*. But what then is to be made of the above reckoning when it was taken over by the Apocalyptic writer in Domitian's reign? Some scholars are of opinion that this writer identified Domitian with the eighth emperor, the Nero *redivivus*, the beast from the abyss. But this is unlikely, notwithstanding the fact that even some pagan writers, such as Juvenal, Pliny and Martial (?), traced a resemblance between Domitian and Nero. On the other hand, if we refuse to accept this identification, and hold that the beast from the abyss is yet to be hoped, any attempt at a strict exegesis of the text plunges us in hopeless difficulties. For Domitian, in that case would be the sixth, and the preceding five would have to begin with Galba—a most improbable supposition. But furthermore, since this new reckoning would exclude Nero, how could the eighth be said to be one of the seven, i.e. Nero? Bousset thinks that the Apocalypticist, knowing not what to make of this reckoning, left it standing as it was and attempted a new interpretation of the seven heads by taking them to refer to the seven hills of Rome in the addition he made to verse 9.

the average daily consumption of the workman. . . . Barley was largely the food of the poor." According to the words just quoted from the Apocalypse, there was to be a dearth of grain and a superfluity of wine; the price of the wheat was to be seven times the ordinary, according to Reinach's computation, and that of the barley four times, This strange statement suggested some historical allusion, and the discovery of the allusion was made by Reinach, who points out that Domitian by an edict in A.D. 92 prohibited the planting of new vineyards in Italy, and ordered the reduction of those in the provinces by one-half. As Asia Minor suffered specially under this edict, an agitation was set on foot which resulted in the revocation of the edict. In this revocation the Apocalypticist saw the menace of a famine of the necessities of life, while the luxuries would remain unaffected. From his ascetic standpoint the revocation of the edict could only pander to drunkenness and immorality. Reinach's explanation of this ancient *crux interpretum*, which has been accepted by Harnack, Bousset, Porter, Sanday, Swete and others, fixes the earliest date of the composition of the Apocalypse as A.D. 93. Since Domitian died in 96, the book was therefore written between A.D. 93 and 95.

Author.—Before entering on the chief data which help towards the determination of this question, we shall first state the author's standpoint. His book exhibits a Christianity that is—as Harnack (*Ency. Brit.*, xx. 498) writes—"free from the law, free from national prejudices, universal and yet a Christianity which is independent of Paul. . . . The author speaks not at all of the law¹—the word does not occur in his work; he looks for salvation from the power and grace of God and Christ alone. . . . nowhere has he made a distinction between Gentile and Jewish Christians. . . . The author of the Apocalypse has cast aside all national religious prejudices." The writer is not dependent, consciously or unconsciously, on the Pauline teaching. He has won his way to universalism, not through the Pauline method, but through one of his own. He has no serious preference for the people of Israel as such, but only for the martyrs and confessors, who shall belong to every tribe and tongue and people and nation (vii. 9 seq.). The unbelieving Jews are "a synagogue of Satan" (ii. 9).

Yet, on the other hand, our author's attitude to the world reflects the temper of Judaism rather than that of Christianity. He looks upon the enemies of the Christian Church with unceasing hatred. No prayer arises within his work on their behalf, and nothing but unalloyed triumph is displayed over their doom. The Christian duty of love to those that wrong us does not seem to have impressed itself on our Apocalypticist.

Is the Apocalypse pseudonymous?—All the Jewish apocalypses are pseudonymous, and all the Christian with the exception of the *Shepherd of Hermas*. Since our book undoubtedly belongs to this category, the question of its pseudonymity must arise. In the articles on Apocalyptic Literature and Apocryphal Literature (*qq.v.*) we have shown the large lines of differentiation between apocalyptic and prophecy. The chief ground for resorting to pseudonymous authorship in Judaism was that the belief in prophecy was lost among the people. Hence any writer who would appeal to them was obliged to do so in the name of some great figure of the past. Furthermore, this belief that prophecy had ceased led the religious personalities of the later time to authenticate their message by means of antedated prophecy. They procured confidence in their actual predictions by appealing to the literal fulfilment of such antedated prophecy. In such literature we find the characteristic words or their equivalents: "Seal up the prophecy: it is not for this generation," which are designed to explain the late appearance of the works in which they are found. But this universal characteristic of apocalyptic is almost wholly lacking in the New Testament Apocalypse. The *vaticinium ex eventu* plays but a very

small part in it. Moreover, the chief ground for the development of a pseudonymous literature was absent in the early Christian church. For with the advent of Christianity prophecy had sprung anew into life, and our author distinctly declares that the words of the book are for his own generation (xxii. 10). Hence we conclude that the grounds are lacking which would entitle our assuming a priori that the Apocalypse is pseudonymous.

Was the Author the Son of Zebedee, the Apostle?—The evidence of the book is against this assumption. The writer demands a hearing as a prophet (xxii. 6), and in no single passage makes any claim to having been an apostle. Nay more, the evidence of the text, so far as it goes, is against such a view. He never refers to any previous intercourse with Christ such as we find frequently in the Fourth Gospel, and when he speaks of "the twelve apostles of the Lamb" (xxi. 14) he does so in a tone that would seem to exclude him from that body. Here internal and external evidence are at strife; for from the time of Justin onwards the Apocalypse was received by the church as the work of the Apostle John (see Swete, *op. cit.*, p. clxxv). If the writer of the Fourth Gospel was the Apostle John, then the difficulties for the assumption of an apostolic authorship of the Apocalypse become well-nigh insuperable. Nay more, the difficulties attending on the assumption of a common authorship of the Gospel and Apocalypse, independently of the question of the apostolic authorship of the Gospel, are practically insuperable. Some decades ago these difficulties were not insurmountable, when critics assigned a Neronian date to the Apocalypse and a Domitianian or later date to the Gospel. It was from such a standpoint conceivable that the thoughts and diction of the writer had undergone an entire transformation in the long interval that intervened between the composition of the two books, on the supposition that both were from the same hand. But now that both books are assigned to the last decade of the 1st century A.D. by a growing body of critics, the hypothesis of a common authorship can hardly be sustained. The validity of such an hypothesis was attacked as early as the 4th century by Dionysius of Alexandria in the fragment of his treatise *περί ἐκταγμένων*, in Eusebius, *H.E.* vii. 24 seq. His arguments, as summed up by Swete (*op. cit.*, p. cxiv seq.), are as follows: "John the Evangelist abstains from mentioning his own name, but John the Apocalypticist names himself more than once at the very outset of his book, and again near its end. Doubtless there were many who bore the name of John in the early Christian communities; we read, for instance, of 'John, whose surname was Mark,' and there may have been a second John in Asia, since at Ephesus, we are told, there were two tombs said to be John's. . . . Again, while the Gospel and the Epistle of John show marks of agreement which suggest a common authorship, the Apocalypse differs widely from both in its ideas and in its way of expressing them; we miss in it the frequent references to 'life,' 'light,' 'truth,' 'grace' and 'love' which are characteristic of the Apostle and find ourselves in a totally different region of thought. . . . Lastly, the linguistic eccentricities of the Apocalypse bar the way against the acceptance of the book as the work of the Evangelist. The Gospel and the First Epistle are written in correct and flowing Greek, and there is not a barbarism, a solecism, or a provincialism in them; whereas the Greek of the Apocalypse is inaccurate, disfigured by unusual or foreign words and even at times by solecisms."

All subsequent criticism has more or less confirmed the conclusions of Dionysius. On the other hand, it is impossible to ignore the signs of a relationship between the Apocalypse and the Gospel in the minor peculiarities of language.² These, Swete holds, "create a strong presumption of affinity" between the two books, while Bousset infers that they "justify the assumption that the entire circle of Johannine writings spring from circles which stood under the influence of the John of Asia Minor."

We conclude, therefore, that the Gospel and the Apocalypse
¹ See Bousset, *Offenbarung Johannis*,² pp. 177-179; Swete², pp. cxxv-cxxix.

¹ His freedom from legal bondage is as undeniable as his universalism. He lays no further burden on his readers than those required by the Apostolic Decree of Acts xv. 28 seq.

are derived from different authors who moved in the same circles.¹

As regards the John mentioned in the Apocalypse, he is now identified by a majority of critics with John the Presbyter, and further the trend of criticism is in favour of transferring all the Johannine writings to him, or rather to his school in Asia Minor.²

For an independent discussion of the authorship of the Fourth Gospel, see JOHN, GOSPEL OF ST. (R. H. C.)

REVELS, MASTER OF THE.—The history of the Revels office has an interesting place in that of the English stage (see also DRAMA, and THEATRE). Among the expenses of the royal Wardrobe we find provision made for *unicas* and *viseses* in 1347 for the Christmas *ludi* of Edward III.; during the reign of Henry VII. payments are also recorded for various forms of court revels; and it became regular, apparently, to appoint a special functionary, called Master of the Revels, to superintend the royal festivities, quite distinct from the Lord of Misrule (*q.v.*). In Henry VII.'s time he seems to have been a minor official of the household. In Henry VIII.'s time, however, the post became more important, and an officer of the Wardrobe was permanently employed to act under the Master of the Revels. With the patent given to John Farlyon in 1534 as Yeoman of the Revels, what may be considered as an independent office of the Revels (within the general sphere of the lord chamberlain) came into being; and in 1544 Sir Thomas Cawarden received a patent as Master of the Revels, he being the first to become head of an independent office, *Magister Jocorum, Revelorum et Mascorum omnium et singularium nostrorum vulgariter nuncupatorum Revels and Masks*. Cawarden was Master till 1550. Soon after his appointment, the office and its stores were transferred to a dissolved Dominican monastery at Blackfriars, having previously been housed at Warwick Inn in the city, the Charterhouse, and then at the priory of St John of Jerusalem in Clerkenwell, to which a return was made after Cawarden's death. Sir Thomas Benger succeeded Cawarden, and Edmund Tylney followed him (1570-1610); it was the appointment of the latter's nephew, Sir George Buck, as deputy-master, with the reversion to the mastership, which led to so much repining on the part of the dramatist, John Lyly, who was himself a candidate. Under Tylney, the functions of Master of the Revels gradually became extended to a general censorship of the stage, which in 1624 was put directly in the hands of the lord

chamberlain, thus leading to the licensing act of 1737 (see DRAMA).

See E. K. Chambers, *The Mediaeval Stage* (1904); and his *Notes on the History of the Revels Office under the Tudors* (1906), with authorities quoted.

REVELSTOKE, an incorporated town of British Columbia, on the Columbia river and the Canadian Pacific railway, 381 m. E. of Vancouver. Pop. (1907) 3526. It is the capital of Kootenay county, and the shipping centre for the mining and lumbering district. It contains large railway shops, several breweries, and saw and shingle mills.

REVENTLOW, CHRISTIAN DITLEV FREDERICK, COUNT (1748-1827), Danish statesman and reformer, the son of Privy Councillor Christian Ditlev Reventlow, born on March 11, 1748. After being educated at the academy of Sorø and at Leipzig, Reventlow, in company with his younger brother Johan Ludwig and the distinguished Saxon economist Carl Wendt (1731-1815), the best of cicerones on such a tour, travelled through Germany, Switzerland, France and England, to examine the social, economical and agricultural conditions of civilized Europe. A visit to Sweden and Norway to study mining and metallurgy completed the curriculum, and when Reventlow in the course of 1770 returned to Denmark he was an authority on all the economic questions of the day. In 1774 he held a high position in the *Kammerkollegiet*, or board of trade, two years later he entered the Department of Mines, and in 1781 he was a member of the *Overskattedirectionen*, or chief taxing board. He had, in 1774, married Frederica Charlotte von Beulwitz, whose bore him thirteen children, and on his father's death in 1775 inherited the family estate in Laaland. Reventlow overflowed with progressive ideas, especially as regards agriculture, and he devoted himself, heart and soul, to the improvement of his property and the amelioration of his serfs. Fortunately, the ambition to play a useful part in a wider field of activity than he could find in the country ultimately prevailed. His time came when the ultra-conservative ministry of Hoegh Guldberg was dismissed (April 14th, 1784) and Andreas Bernstorff, the statesman for whom Reventlow had the highest admiration, returned to power.

Reventlow was an excellently trained specialist in many departments, and was always firm and confident in those subjects which he had made his own. Moreover, he was a man of strong and warm feelings, and deeply religious.

The condition of the peasantry especially interested him. He was convinced that free labour would be far more profitable to the land, and that the peasant himself would be better if released from his thralldom.

His favourite field of labour was thrown open to him when, on the 6th of August 1784, he was placed at the head of the *Rentekammeret*, which took cognisance of everything relating to agriculture. His first step was to appoint a small agricultural commission to better the condition of the crown serfs, and amongst other things enable them to turn their leaseholds into freeholds. Observing that the Crown Prince Frederick was also favourably disposed towards the amelioration of the peasantry, Reventlow induced him, in July 1786, to appoint a grand commission to take the condition of all the peasantry in the kingdom into immediate consideration. This celebrated agricultural commission continued its labours for many years, and introduced a whole series of reforms of the highest importance. Thus the ordinance of 8th June 1787 modified the existing leaseholds, greatly to the advantage of the peasantry; the ordinance of 20th June 1788 abolished villenage and completely transformed the much-abused *hoversi* system whereby the feudal tenant was bound to cultivate his lord's land as well as his own; and the ordinance of 6th December 1799, which did away with *hoversi* altogether. Reventlow was also instrumental in starting the public credit banks, for enabling small cultivators to borrow money on favourable terms. In conjunction with his friend, Heinrich Ernst Schimmelmann (1747-1831), he also procured the passing of the ordinances permitting free trade between Denmark and Norway,

¹ There are several analogies in Jewish literature. Thus the *Testaments of the XII. Patriarchs*—a universalist work—and the *Book of Jubilees*—a particularist work—are from different authors, though they are written within a few years of each other by Pharisees and use much common material. Similarly with regard to the Apocalypse of Baruch and 4 Ezra.

² Several converging lines of testimony tend to prove that John the son of Zebedee was, like his brother James, put to death by the Jews. First, we have the express testimony of Papias to this effect, which is preserved in George Hamartolus and in an epitome of Philip of Side. Attempts have been made to explain away this testimony by Lightfoot, Harnack, Drummond, and Bernard (*Irish Church Quarterly*, 1908, 52 sqq.). Secondly, Papias's testimony receives support from Jesus's own words in Mark x. 39; for, as Wellhausen remarks on this passage, "the prophecy refers not only to James but also to John; and if it had remained only half fulfilled, it would hardly have kept its place in the Gospel." The third strand of evidence is found in the Martyrologies, Carthaginian, Armenian and Syrian. Bernard (*op. cit.*) has tried to prove that the Martyrologies do not imply the martyrdom but only the faithful witness of John. Finally, Clement of Alexandria (Bousset, *Die Offenbarung*, p. 38) furnishes evidence in the same direction; and in Clem. Alex. *Strom. iv.* 9, 71, the Gnostic Heracleon gives a list of the Apostles who had not been martyred, and these were: "Matthew, Philip, Thomas and Levi" (corrupt for Lebbeaus). If we accept this evidence, the martyrdom cannot have been later than A. D. 69, and may have been considerably earlier. In either case such a fact, if it is a fact, is against an Apostolic origin of the Johannine writings. John the Presbyter is in that case "the disciple whom Jesus loved" and the founder of the Johannine school in Asia Minor. But the question is still at issue.

³ The word "revel" meant properly a noisy or riotous tumult or merry-making, and is derived from O. Fr. *reveler*, to rebel, to riot, make a noise; Lat. *rebellare*.

the free importation of corn from abroad, and the abolition of the mischievous monopoly of the Iceland trade.

But the financial distress of Denmark, the jealousy of the duchies, the ruinous political complications of the Napoleonic period, and, above all, the Crown Prince Frederick's growing jealousy of his official advisers, which led him to rule, or rather misrule, for years without the co-operation of his Council of State—all these calamities were at last too much even for Reventlow. On 7th December 1813 he received his dismissal and retired to his estates, where, after working cheerfully among his peasantry to the last, he died on the 11th of October 1827.

See Adolph Frederik Bergsøe, *Gre. C. D. F. Reventlows Virksomhed* (Copenhagen, 1837); Louis Theodor Alfred Bobe, *Efterl. Papirer fra den Reventlowske Famieliekræds* (Copenhagen, 1895-97).

REVENUE (O. Fr. *revenu*, from *revenir*, to return), income, return, or profit; more particularly the receipts from all sources of a government or state. The revenue of a state is largely made up of taxation, and the general principles of taxes are discussed in **TAXATION and FINANCE**. In some countries the public or state domain may contribute substantially to the revenue, as do the crown forests in Russia, while in other countries important contributions are made from the state railways, post and telegraph services, &c. For the historical development of the English revenue see **ENGLISH FINANCE**, and for other countries see the sections on finance in the articles dealing with the various countries. In the United Kingdom the term inland revenue is used to denote that part of the revenue which is derived from death duties, stamps and other taxes, such as income tax, land tax, inhabited house duty, &c. The Board of Inland Revenue is a special department of the English civil service, with headquarters at Somerset House. The Board consists of a chairman, deputy chairman, and two commissioners, with joint secretaries, assistant secretaries and a staff of officials. The other important department engaged in the collection of the English revenue is the Board of Customs and Excise. The excise department was formerly a branch of the inland revenue, but was amalgamated with the customs department on the 1st of April 1909. The Board of Customs and Excise is constituted as is the Board of Inland Revenue.

In the United States the greater proportion of the national revenue (\$547,086,902 out of \$663,217,677 in 1909) is derived from customs and internal revenue. The internal revenue consists for the most part of receipts from taxes on spirits, tobaccos and fermented liquors. In 1909 the amount derived from customs revenue was \$300,977,438, and internal revenue, \$246,109,554.

REVERE, PAUL (1735-1818), American engraver and patriot, was born in Boston, Massachusetts, on the 1st of January 1735. He had a meagre schooling, and in his father's shop learned the trade of a gold- and silversmith. In 1756 he was second lieutenant of artillery in the expedition against Crown Point, and for several months was stationed at Fort Edward, in New York. He became a proficient copper engraver, and engraved several anti-British caricatures in the years before the War of Independence. He was one of the Boston grand jurors who refused to serve in 1774 because parliament had made the justices independent of the people for their salaries; was a leader in the Boston Tea Party; was one of the thirty North End mechanics who patrolled the streets to watch the movements of the British troops and Tories; and in December 1774 was sent to Portsmouth, New Hampshire, to urge the seizure of military stores there, and induced the colonists to attack and capture Fort William and Mary—one of the first acts of military force in the war. His midnight ride from Charlestown to Lexington on the 18th-19th of April 1775, to give warning of the approach of British troops from Boston, is Revere's most famous exploit; it is commemorated by Longfellow, who, however, has "paid little attention to exactness of fact" (Justin Winsor). In 1775 Revere was sent by the Massachusetts

provincial congress to Philadelphia to study the working of the only powder mill in the colonies, and although he was allowed only to pass through the building, obtained sufficient information to enable him to set up a powder mill at Canton. He was commissioned a major of infantry in the Massachusetts militia in April 1776; was promoted to the rank of lieutenant-colonel of artillery in November; was stationed at Castle William, defending Boston harbour, and finally received command of this fort. He served in an expedition to Rhode Island in 1778, and in the following year participated in the unsuccessful Penobscot expedition. After his return he was accused of having disobeyed the orders of the commanding officer, was tried by court-martial, and was acquitted. After the war he engaged in the manufacture of gold and silver ware, and became a pioneer in the production in America of copper plating and copper spikes for ships. In 1795, as grandmaster of the Masonic fraternity, he laid the cornerstone of the new State House in Boston, and in this year also founded the Massachusetts Charitable Mechanic Association, becoming its first president. He died in Boston on the 10th of May 1818.

See Charles F. Gettemy, *The True Story of Paul Revere* (Boston, 1905).

REVERE, a township and a coast resort of Suffolk county, Massachusetts, U.S.A., immediately N.E. of Boston on Massachusetts Bay. Pop. (1910, U.S. census), 18,219. Area, 4.56 sq. m. The township is served by the Boston & Maine and the Boston, Revere Beach & Lynn railways, and by several electric railways connecting with Boston, Chelsea, Lynn, Malden, and Medford. Revere Beach, a crescent-shaped beach of white sand extending from the promontory of Winthrop on the S. to the Point of Pines on the N., is a popular bathing resort, and has been called the Coney Island of Boston. The township has a Carnegie library and a handsome town hall. The first settlement here was made about 1626, and, under the name of Runney Marsh, it was a part of Boston until 1739, when it became a part of the new township of Chelsea. The northern part of Chelsea was organized as the township of North Chelsea in 1846; part of it was separated as Winthrop in 1852; and in 1871 the name North Chelsea was changed to Revere, in honour of Paul Revere.

REVEREND (Lat. *reverendus*, gerundive of *revereri*, to revere, pay respect to), a term of respect or courtesy, now especially used as the ordinary prefix of address to the names of ministers of religion of all denominations. The uses of *Med. Lat. reverendus* do not confine the term to those in orders; Du Cange (*Gloss. s.v.*) defines it as *titulus honorarius, etiam mulieribus potioris dignitatis concessus*, and in the 15th century in English it is found as a general term of respectful address. The usual prefix of address of a parson was "sir," representing *Lat. dominus* (see **SIR**), or "master." It has been habitually used of the parochial clergy of the Church of England since the end of the 17th century. It is not, however, a title of honour or dignity, and no denomination has any exclusive right to use it. A faculty was ordered to be issued for the erection of a tombstone, the inscription on which contained the name of a Wesleyan minister prefixed by "reverend"; this the incumbent had refused (*Keat v. Smith*, 1876, 1 P.D. 73). In the Church of England deans are addressed as "very reverend," bishops as "right reverend," archbishops as "most reverend." The Moderator of the Church of Scotland is also styled "right reverend."

REVERIE, a condition of mental abstraction, a fit of musing, a "brown study" ("brown" in the sense of "gloomy," and not to be referred to *Germ. Braune*, brow). The word appears in the 14th or 15th centuries in its original meaning in Old French, of joy, delight, also wildness, anger. The French *rever*, later *reveser*, modern *reveser*, to dream, meant originally to wander in speech or thought, and is derived from the *Lat. rabiare*, cf. "rabies," "rage" and "rave." The French *reverie* (*reveserie*) was adopted again in the 17th and 18th centuries as meaning a state of dreaminess; thus Locke (*Essay on the Human Understanding*, 1695, ii. xix.) says: "When ideas float in our minds

without any reflection or regard of the understanding, it is that which the French call *revue*; our language has scarce a word for it."

REVIEW (Fr. *revue*, from *revoir*, to see again, Lat. *re* and *videre*), an inspection or critical examination; it is chiefly used as a military or naval term for an inspection on a large or formal scale of a fleet or body of troops by the sovereign or other person holding a high official position, or for a critical account of a recently published literary work in a magazine or periodical. The earliest use of the word for the title of such a periodical was in the paper begun by Defoe in 1704, the full title of which was *A Review of the Affairs of France and of all Europe, as influenced by that Nation* (see PERIODICALS and NEWSPAPERS). In France there is a particular application of the term *revue* or, more fully, *revue de fin d'année* to a form of dramatic performance, acted or sung, in which the chief events of the past year, and the personages who have been prominently before the public, are satirically and critically passed under review. Attempts have been made to trace such performances to an early origin. In their modern form, however, they date from the reign of Louis Philippe. *L'An 1841 et l'An 1941*, by the brothers Cogniard, was one of the earliest.

REVILLAGIGEDO, an isolated, uninhabited group of rocky islands in the N. Pacific, lat. 18° N., long. 112° W., belonging to Mexico, and forming part of the state of Colima. They are about 420 m. from the Mexican coast and comprise the large island of Socorro (San Tomás), 24 m. long by an average of 9 m. wide, and the three widely separated islets of San Benedicto, Roca Partida and Clarion, with a total area of 320 sq. m. The island of Socorro has an extinct volcano 3660 ft. high. The islands have certain remarkable zoological features, comprising several birds and reptiles allied to those of the Mexican mainland but differing from them in species. The archipelago derives its name from the Spanish viceroy who governed Mexico from 1746 to 1755.

RÉVILLE, ALBERT (1826–), French Protestant theologian, was born at Dieppe on the 4th of November 1826. After studying at Geneva and Strassburg, he became in 1849 pastor at Lunera near Dieppe, and in 1851 of the Wallon Church at Rotterdam, where he remained until 1872. In 1880 he was made professor of the history of religions in the Collège de France at Paris. Six years later he was appointed president of the section of religious studies in the École des hautes études at the Sorbonne. He is one of the leaders of the French school of advanced critical theology.

Works.—Besides contributing to the *Revue de théologie* (Paris), the *Revue de l'histoire des religions* (Paris), the *Revue des deux mondes*, the following works are important: *Manuel d'histoire comparée de la philosophie et de la religion* (1859; Eng. trans., 1864); *Histoire du dogme de la divinité de Jésus Christ* (1869, 3rd ed., 1904; Eng. trans., 1905); *Prolegomènes de l'histoire des religions* (1881, 4th ed., 1886; Eng. trans., 1884); *Théodore Parker, sa vie et ses œuvres* (1865; Eng. trans., 1865, 2nd ed., 1877); *Lectures on the Origin and Growth of Religion as illustrated by the native religions of Mexico and Peru* (the "Hibbert Lectures" for 1884); *Jésus de Nazareth* (1897, 12th ed., 1906).

His son, **JEAN RÉVILLE**, was born on the 6th of November 1854, studied at Geneva, Paris, Berlin and Heidelberg, and became professor of patristic literature and secretary of the section of religious studies in the École des hautes études at the Sorbonne. In 1884 he became co-editor of the *Revue de l'histoire des religions* (Paris).

His books include: *La Doctrine du logos* (1881); *La Religion à Rome sous les Sévères* (1886); *Les Origines de l'épiscopat* (1895); and *Le Protestantisme libéral, ses origines, sa nature, sa mission* (1903; Eng. trans., 1903).

REVOLUTIONARY TRIBUNAL, THE (*le tribunal révolutionnaire*), a court which was instituted in Paris by the Convention during the French Revolution for the trial of political offenders, and became one of the most powerful engines of the Terror. The news of the failure of the French arms in Belgium gave rise in Paris to popular movements on the 9th and 10th of March 1793, and on the 10th of March, on the proposal of Danton, the Convention decreed that there should be established in Paris

an extraordinary criminal tribunal, which received the official name of the Revolutionary Tribunal by a decree of the 29th of October 1793. It was composed of a jury, a public prosecutor, and two substitutes, all nominated by the Convention; and from its judgments there was no appeal. With M. J. A. Hermann as president and Fouquier-Tinville as public prosecutor, the tribunal terrorized the royalists, the refractory priests and all the actors in the counter-revolution. Soon, too, it came to be used for personal ends, particularly by Robespierre, who employed it for the condemnation of his adversaries. The excesses of the Revolutionary Tribunal increased with the growth of Robespierre's ascendancy in the Committee of Public Safety; and on the 10th of June 1794 was promulgated, at his instigation, the infamous Law of 22 Prairial, which forbade prisoners to employ counsel for their defence, suppressed the hearing of witnesses and made death the sole penalty. Before 22 Prairial the Revolutionary Tribunal had pronounced 1220 death-sentences in thirteen months; during the forty-nine days between the passing of the law and the fall of Robespierre 1376 persons were condemned, including many innocent victims. The lists of prisoners to be sent before the tribunal were prepared by a popular commission sitting at the museum, and signed, after revision, by the Committee of General Security and the Committee of Public Safety jointly. Although Robespierre was the principal purveyor of the tribunal, we possess only one of these lists bearing his signature. The Revolutionary Tribunal was suppressed on the 31st of May 1795. Among its most celebrated victims may be mentioned Marie Antoinette, the Hébertists, the Dantonists and several of the Girondists. Similar tribunals were also in operation in the provinces.

See H. A. Wallon, *Histoire du tribunal révolutionnaire de Paris* (Paris, 6 vols., 1880-82); E. Campardon, *Le Tribunal révolutionnaire de Paris* (Paris, 2nd ed., 2 vols., 1866); C. Berriat Saint-Prix, *La Justice révolutionnaire à Paris, Bordeaux, Brest, Lyon, Nantes, . . .* (Paris, 1861), and *La Justice révolutionnaire (août 1793-prairial an II) d'après des documents originaux* (Paris, 1870); also G. Lenôtre, *Le Tribunal révolutionnaire* (1908). For a bibliography of its records see M. Tourneux, *Bibliog. de la ville de Paris* . . . (1890, vol. i. Nos. 3925-3974).

REWA, or **RWA**, a native state of Central India in the Bagelkhand agency. It is the only large state in Bagelkhand, and the second largest in Central India, having an area of about 13,000 sq. m. It is bounded N. by the United Provinces, E. by Bengal and S. by the Central Provinces. On the W. it meets other petty states of Bagelkhand. Rewa is divided into two well-defined portions. The northern and smaller division is the plateau lying between the Kaimur range of hills and that portion of the Vindhya known as Binjh, which overlook the valley of the Ganges. This plateau is for the most part cultivated and well peopled; rich harvests both of *kharif* and *rabi* crops are generally obtained. Water is plentiful, and the country is full of large tanks and reservoirs, which, however, are not used for irrigation purposes; the only system of wet cultivation which has any favour with the villagers is that of *bunds*, or mounds of earth raised at the lower ends of sloping fields to retain the rain water for some time after the monsoon rains cease. The country to the S. of the Kaimur hills comprises by far the largest portion of the state; but here cultivation is restricted to the valley between the hills and the Sone river, and to a few isolated patches in scattered parts of the forest wastes. The principal river is the Sone, which flows through the state in a N.E. direction into Mirzapur district. Another important river is the Tons, but neither is navigable. The annual rainfall averages about 41 in. The population in 1901 was 1,327,385, showing a decrease of 12% in the decade. Many of the inhabitants of the hilly tracts are Gonds and Kols. Estimated revenue, £200,000. The staple crops are rice, millets and wheat; but more than one-third of the area is covered with forests, yielding timber and lac.

The S. of the state is crossed by the branch of the Bengal-Nagpur railway from Bilaspur to Katni, which taps the Umari coal-field. The state suffered from famine in 1896-97, and again to a less

extent in 1899-1900; but on both occasions adequate measures of relief were provided.

The state first came under British influence in 1812. The chief, Venkat Raman Singh, was born in 1876, succeeded in 1880 and was created G.C.S.I. in 1897. During his minority the administration was reformed. He is Rajput of the Baghela branch of the Solanki race, and is descended from the founder of the Anhilwara Patan dynasty in Gujarat.

The town of Rewa is 131 m. S. of Allahabad. Pop. (1901) 24, 608. It has a high school, also the Victoria and zenana hospitals and a model gaol. The political agent for Bagelkhand resides at Satna, on the East Indian railway: pop. (1901) 7471.

REWA KANTHA, a political agency or collection of native states in India, subordinate to the government of Bombay. It stretches for about 150 m. between the plain of Gujarat and the hills of Malwa, from the river Tapi to the Mahi, crossing the Nerbudda or Rewa, from which it takes its name. The number of separate states is 61, many of which are under British jurisdiction. The only important one is Rajpipla (*q.v.*). It includes also five second-class states entitled Chota Udaipur, Bariya, Sunth, Lunawada and Balamor. Total area, 4972 sq. m. In 1901 the population was 479,065, showing a decrease of 35 % in the decade, due to the results of famine. Estimated revenue, £140,000; tribute (mostly to the gaekwar of Baroda), £10,000. Many of the inhabitants belong to the wild tribes of Bhils and Kolis. The political agent, who is also collector of the British district of the Panch Mahals, resides at Godhra.

REWARD, recompense, a gift or payment in return for services rendered. "Reward" and "regard" are forms of the same word. Old French, from which both words came into English, also had *rewarder* and *regarder* (the latter form only surviving in modern French), from *re-*, back, in return, and *warder*, *garder*, to watch, protect—ultimately a Teutonic word, from the base *war-*, to defend; cf. "ward" and "guard," which are thus also doublets. In early use in English, "reward" and "regard" were interchangeable in meaning; thus in *Piers Plowman*, xi. 129, "Reson rod thow and tok reward of no man," cf. "The towne doth receive . . . an annual regard for the same" (a 16th-century reference quoted by the *New English Dictionary* from R. Willis and J. W. Clark, *Archit. Hist. of Univ. of Cambridge*, 1886). In use the words are now distinct, "regard" being restricted to such meanings as attention, respect, esteem, consideration.

In English law the offering of rewards presents two distinct aspects: (1) with reference to the nature of the information or act for the giving or doing whereof the reward is offered; (2) with reference to the nature of the relation created between the person offering and the person claiming the reward.

1. Courts of assize and quarter sessions are empowered to order the payment of rewards to persons who have been active in or towards the apprehension of persons charged with certain specified crimes against person and property (Criminal Law, 1826, ss. 28, 29; Criminal Justice Administration Act 1851, ss. 7, 8). The rewards are payable according to a scale fixed by the home secretary. In the case of courts of quarter sessions the maximum is £5. Courts of assize may award a larger sum where extraordinary courage and diligence have been shown towards the apprehension. The sums awarded are paid out of the rate or fund chargeable with the costs of assizes and sessions. It is illegal to advertise for the recovery of stolen property (including dogs) on terms of not asking questions (Larceny Act 1861, s. 102; Larceny Advertisements Acts 1870, s. 3). The advertiser and the newspaper which publishes it incur a penalty of £50. (See *Mirams v. Our Dogs Publishing Co.*, 1901, 2 K.B. 564.) It is a criminal offence at common law to offer any reward on terms leading to compounding a felony or sheltering the offender (*R. v. Burgess*, 1886, 16 Q.B.D. 141), and under the Larceny Act 1861 (ss. 20, 101) it is criminal to accept a reward for recovery of stolen property without bringing the thief to justice.

2. Where a reward is lawfully offered for information the person who first supplies the required information, *i.e.* satisfies the conditions on which the reward is payable, is entitled to

recover by action the reward offered. Performance of the conditions is an acceptance of the offer (*Carlill v. Carbolic Smoke Ball Co.*, 1893, 1 Q.B. 256, 270). Thus on an advertisement for information leading to the arrest and conviction of shop-breakers, T. gave information which led to the arrest of R., who while in prison told the police where to find the thieves. T. was held entitled to the reward (*Turner v. Walker*, 1866, L.R. 1 Q.B. 641). This rule applies even where the offer is general to all the world (*Williams v. Carwardine*, 1833, 4 B. & Ad. 621; *Spencer v. Harding*, 1870, L.R. 5 C.P. 561). It would seem that on grounds of public policy an offender could not claim the reward on surrendering himself to justice (*Bent v. Wakefield &c. Bank*, 1878, 4 C.P.D. 1, 4). It is not clear whether officers of justice are by their office and duty debarred from claiming rewards offered for the arrest of offenders (*Ibid.*, p. 5).

REWARI, a town of British India, in Gurgaon district of the Punjab, 32 m. S.W. of Gurgaon, on the Rajputana-Malwa railway. Pop. (1901) 27,295. It is an important centre of trade, being the junction for the Rewari-Bhatinda branch of the Rajputana railway. The chief manufacture is that of brass-ware for cooking utensils.

REWBELL, JEAN FRANÇOIS (1747-1807), French politician, was born at Colmar (then in the department of Haut-Rhin) on the 8th of October 1747. He was president (*doctonnier*) of the order of *avocats* in Colmar, and in 1789 was elected deputy to the States-General by the Third Estate of the *bailliage* of Colmar-Schlestadt. In the Constituent Assembly his oratorical gifts, legal knowledge and austerity of life gave him much influence. During the session of the Legislative Assembly he exercised the functions of *procureur syndic* and was subsequently secretary-general of the department of Haut-Rhin. In the Convention he was a zealous promoter of the trial of Louis XVI, but was absent on mission at the time of the king's condemnation. He took part in the reactionary movement which followed the fall of Robespierre, and became a member of the reorganized Committees of Public Safety and General Security. The moderation he displayed caused his election by seventeen departments to the Council of Five Hundred. Appointed a member of the Directory on the 1st of October 1795, he became its president in 1796, and retired by ballot in 1799. He then entered the Council of Ancients. After the *coup d'état* of 18 Brumaire he retired from public life, and died at Colmar on the 23rd of November 1807.

See L. Sciout, *Le Directoire* (Paris, 1895-97).

REYBAUD, MARIE ROCH LOUIS (1799-1879), French writer, economist and politician, was born at Marseilles on the 15th of August 1799. After travelling in the Levant and in India, he settled in Paris in 1820. Besides writing for the Radical press, he edited the *Histoire scientifique et militaire de l'expédition française en Egypte* in ten volumes (1830-36) and Dumont d'Urville's *Voyage autour du monde* (1833). In 1840 he published *Études sur les réformateurs ou socialistes modernes* (see SOCIALISM) which gained him the Montyon prize (1841) and a place in the Académie des sciences morales et politiques (1850). In 1843 he published *Jérôme Paturot à la recherche d'une position sociale*, a clever social satire that had a prodigious success. In 1846 he abandoned his democratic views, and was elected liberal deputy for Marseilles. His *Jérôme Paturot à la recherche de la meilleure des républiques* (1848) was a satire on the new Republican ideas. After the *coup d'état* of 1849 he ceased to take part in public life, and devoted himself entirely to the study of political economy. To this period belong his *La Vie de l'employé* (1855); *L'Industrie en Europe* (1856); and *Études sur le régime de nos manufactures* (1859). He died in Paris on the 28th of October 1879.

REYER, ERNEST (1823-), French composer, was born at Marseilles on the 1st of December 1823. At the age of sixteen he went to Algeria, and remained there some years. The outcome of his residence there was a symphonic ode entitled *Le Sélem*, the musical orientalism of which had, unluckily for him, already been anticipated by Félicien David in *Le Désert*. *Maitre Wolfram*, a one-act opera, was produced at the Opéra comique

in 1854; and in 1858 *Sacuntala*, a ballet, at the Opéra. It was the production of *La Statue* at the Théâtre lyrique in 1861 that brought Reyer's name prominently before the public. But Reyer had to wait several years before obtaining a real and permanent success. *Erostrata*, an opera produced at Baden-Baden in 1862, and given at the Paris Opéra some ten years later, was a failure. The composer had in the meanwhile set to work on *Sigurd*, the subject of which is the same that inspired Wagner in *Siegfried* and *Götterdämmerung*. It was at last produced in Brussels in 1884, and subsequently brought out at the Paris Opéra. *Sigurd* is a work of great value, displaying its composer's elevated notions as regards the form of the "lyrical drama." *Salammô*, founded upon Flaubert's romance, was successfully produced at Brussels in 1890. Gluck, Weber, Berlioz and Wagner exercised most influence over Reyer. As a musical critic (preceding Berlioz in that capacity for the *Journal des débats*) Reyer was a well-known writer; and he became librarian of the Paris Opéra, and a member of the Institute. His *Quarante Ans de musique* (with biographical notice by E. Henriot) was published in 1909.

REYNARD THE FOX, a beast-epic, current in French, Dutch and German literature. The cycle of animal stories collected round the names of Reynard the Fox and Isengrim the Wolf in the 12th century seems to have arisen on the borderland of France and Flanders. Much of the material may be found in Aesop, in *Physiologus*, and in the 12th-century *Disciplina Clericalis* of Petrus Alfonsus. But the difference is very great. The intention of the *trouvères* who recited the exploits of Reynard was, in the earlier stages, in no sense didactic. The tales, like those of "Uncle Remus," were amusing in themselves; and they were based on widely diffused folklore, and Reynard and his companions were not originally men disguised as animals. Jacob Grimm (*Reinhart Fuchs*, 1834) maintained their popular origin; his theories, which have been much contested, have received additional support from the researches of K. Krohn, who discovered many of the stories most characteristic of the cycle in existing Finnish folklore, where they can hardly have arrived through learned channels.

There is abundant evidence that Isengrim and Reynard were firmly established in the popular imagination in the 13th century, and even earlier. Guibert de Nogent (*De Vita sua*, book 3, chap. viii., printed Paris, 1651), in referring to the disturbances at Laon in 1112, says that the bishop Gaudri was accustomed to call one of his enemies Isengrim, and it is obvious from the context that the taunt was perfectly understood by the popular mind. Philip the Fair is said to have annoyed Pope Boniface III., who died in 1303, by the representation of the "Procession Renart"; and in 1204-1206 in Flanders two opposing parties were designated Isagrinni and Blavotini (blue-footed). The principal names of the Reynard cycle, and the earliest in use, were German. Reynard himself (Raginohardus, strong in counsel), Bruin the Bear, Baldwin the Ass, Tibert the Cat, Hirsent the She-wolf, had German names, most of which were used as person-names in Lorraine. Whatever the sources of the stories, it was in France that the cycle obtained its greatest vogue. The *Roman de Renart* as printed by Méon (Paris, 4 vols., 1826) runs to over 40,000 lines, and contains a great number of detached episodes or branches, to which the *trouvères* gave a certain unity by attaching them to the traditional feud between Reynard and Isengrim. This rapidly became symbolic of the triumph of craft and eloquence over brute strength. *Renart* was a popular epic parodying feudal institutions as represented in the romances of chivalry, and readily adapting itself to satire of the rich, of the forms of justice, and of the clergy.

The early French originals are lost, the most ancient existing fragments being in Latin. The fable of the lion's sickness and his cure by the wolf's skin occurs in the *Echasis capusdom captivi per Trapologium* (ed. E. Voigt; Strassburg, 1875), written by a monk of St. Evre at Toul (Meurthe-et-Moselle) about 940. *Ysengrimus* (ed. E. Voigt; Halle, 1884), a clerical satire written by Nivard of Ghent about 1148, includes the story of

the lion's sickness and the pilgrimage of Bertiliana the Goat. Another Latin poem, *Reinardus vulpes* (ed. F. J. Mone; Stuttgart, 1832), contains in addition the theft of the bacon, and how Isengrim is induced to fish with his tail. A simpler version, derived probably from a French original, is *Isingrines nôt*, written in German about 1180 by the Alsatian Heinrich der Gilchezäre. Only fragments of this poem are preserved, but about a quarter of a century later it was re-written with little change in the subject matter as *Reinhart Fuchs* (ed. J. Grimm, Berlin, 1834; and K. Reissenberger, Halle, 1886). Most later versions of Reynard have been derived, however, from the Flemish *Reinoert de vos* (ed. J. F. Willems, Ghent, 1836; and E. Martin, Paderborn, 1874), written about 1250 in East Flanders by Willem. *Reinoert* is a poem of 3474 lines. The corresponding branch of the French *Roman de Renart* (for which and its satirical sequels, *Le Couronnement Renart*, *Renart le nouveau*, and *Renart le contrefait*, see FRENCH LITERATURE) is one of the earliest and best of the great French cycle.

The fable was, like other French works, known in England, but did not at once pass into the popular stock. Odo of Cheriton, who died in 1247, used the Reynard stories in his sermons, and many of them occur in his collection of *Parabolæ* (ed. Hervieux, *Fabulistes latins*, 1884, vol. i.). The English poem of the *Vox and the Wolf* dates from the 13th century; and the "Nonne Preestes Tale" of Chaucer, in which, however, the fox is Rosell and the ass Brunel, is a genuine Reynard history.

Willem's *Reinoert de Vos* was left incomplete, and the continuation—about 4000 lines in a more didactic vein—was added by an unknown writer of West Flanders about 1370. The first copy printed in any language was the Dutch prose version, *Historie van Reynaert de Vos*, printed at Gouda by Gheraert Leeuw in 1479. On this Caxton based his *Historie of reynart the foxe* (reprinted by E. Arber, 1878), which he finished on the 6th of June 1481. As a satire on the church, especially on monks and nuns, *Reynard* became popular with reformers, and numerous versions followed in England and Germany. A Low German version, *Reinke Fuchs*, with a prose commentary by Hinrek Alckmer (Henry of Alkmaar), was issued from the Antwerp press of Gheraert Leeuw in 1487. From this *refacimento* was derived the Low German *Reynke de Vos* (ed. Hoffmann von Fallersleben, Breslau, 1834; and Friedrich Prien, Halle, 1887), which was printed at Lübeck in 1498. Michael Beuther is said to have been the translator into High German (*Reiniken Fuchs*, 1544); and the book was made available to the general European public in the Latin version of Hartmann Schopper, *Opus Poeticum de admirabili fallacia et astutia Vulpeculae Reinikes Libros quatuor* (Frankfort, 1567). The modern German version (1794) of Goethe has been often reprinted, notably in 1846 with illustrations by Wilhelm von Kaulbach.

Reynard is dealt with by Carlyle in an essay "On German Literature of the Fourteenth and Fifteenth Centuries" in the *Foreign Quarterly Review* (1831). An admirable account of the Reynard cycle is given by W. J. Thoms in his edition of Caxton's version for the Percy Society (1844). Prien's edition of *Reynke de Vos* contains bibliographical particulars of the German, Danish, Swedish, Icelandic and English editions (cp. Brunet, *Manuel du libraire*, 220, Renart). The best edition of the *Roman de Renart* is by Ernest Martin (3 vols., Strassburg and Paris, 1881-1887). See also Léopold Sudre, *Les Sources du roman de Renart* (Paris, 1890); Jacob Grimm, *Sendschreiben an C. Lomann über Reinhart Fuchs* (Leipzig, 1840); Gaston Paris, "Le Roman de Renart" in the *Journal des savants* (Dec. 1894 and Feb. 1895); Kaarle Krohn, *Bär und Fuchs* (Helsingfors, 1888), and the editions mentioned above. The story is told in modern French by Paulin Paris, *Les Aventures de Maître Renart et d'Ysengrim son compère* (1861), and in English by Felix Jacobs, following a modernized text of Caxton made by "Felix Summerley" (Sir H. Cole), in *The Most Delectable History of Reynard the Fox* (1895), with a valuable introduction.

REYNOLDS, JOHN FULTON (1820-1863), American soldier, was born at Lancaster, Pennsylvania, on the 20th of September 1820, and graduated at West Point in 1841. He became first lieutenant of artillery in 1846, and was breveted captain and major for gallantry in the Mexican War. He took part in the Utah expedition under Brigadier-General Albert Sidney Johnston. In 1859 he was made commandant of cadets

at West Point, where he was stationed at the outbreak of the Civil War in 1861. He was made a lieutenant-colonel of infantry in May and brigadier-general of volunteers in August of that year. In the Peninsular campaign, after taking part in the battles of Beaver Dam Creek and Gaines' Mill, he was taken prisoner in the hard-fought action of Glendale or Frazier's Farm. Exchanged after six weeks' captivity, he commanded a division with conspicuous ability and courage in the second battle of Bull Run. Shortly after this he was placed in command of the militia of his native state when Lee's invasion threatened it. In November 1862 he was commissioned major-general of volunteers, and appointed to command the I. Corps of the Army of the Potomac, and took part in the battle of Fredericksburg. At the time of General Meade's appointment to command the Army of the Potomac many desired to see Reynolds selected for that post, but he gave Meade his whole-hearted support in the three critical days preceding the battle of Gettysburg (*q.v.*). He was placed by Meade in command of the left wing (I., III. and XI. corps and Buford's cavalry division) and thrown forward to Gettysburg to cover the concentration of the Army of the Potomac. The battle which ensued there, on the 1st of July 1863, took its shape from Reynolds's resolution to support Buford's cavalry with the I. and XI. corps. Meade was notified, and hurried forward the right wing under Hancock. Reynolds himself was killed very early in the day by a rifle bullet. A bronze statue was placed on the field of Gettysburg and a portrait in the library at West Point by the men of the I. Corps. The state of Pennsylvania erected a granite shaft on the spot where he fell, and an equestrian bronze statue stands in Philadelphia.

His elder brother WILLIAM (1815-1879), a naval officer, served afloat in the Civil War, effected many useful reforms while acting secretary of the navy in 1873 and 1874, and retired from the United States navy in 1877 as a rear-admiral.

REYNOLDS, SIR JOSHUA (1723-1792), the most prominent figure in the English school of painting, was born at Plympton Earl, in Devonshire, on the 16th of July 1723. He received a fairly good education from his father, who was a clergyman and the master of the free grammar school of the place. At the age of seventeen, the lad, who had already shown a fondness for drawing, was apprenticed in London to Thomas Hudson, a native of Devonshire, who, though a mediocre artist, was popular as a portrait painter. Reynolds remained with Hudson for only two years, and in 1743 he returned to Devonshire, where, settling at Plymouth Dock, he employed himself in portrait painting. By the end of 1744 he was again in London. He was well received by his old master, from whom he appears previously to have parted with some coldness on both sides. Hudson introduced him to the artists' club that met in Old Slaughter's, St Martin's Lane, and gave him much advice as to his work. Reynolds now painted a portrait of Captain the Hon. John Hamilton, the first that brought him any notice, with those of other people of some repute; but on the death of his father in 1746 he established himself with two of his sisters at Plymouth Dock, where he painted numerous portraits, and it was here that he came under the influence of the works of one of the painters who materially affected his art. This was William Gandy of Exeter, who had died in 1730, and whose painting, derived through his father from Van Dyck, was pronounced by Northcote to come nearer to nature in the texture of flesh than that of any artist who ever lived. The influence on him of Gandy may be seen in the early self-portrait of the National Portrait Gallery, so rich in impasto and strong in light and shade, in which he is seen shading his eyes with his hand.

Meanwhile the pleasant urbanity of manner which distinguished Reynolds throughout life had been winning for him friends. He had made the acquaintance of Lord Edgcumbe, and by him was introduced to Captain (afterwards Viscount) Keppel. Keppel was made aware of Reynolds's ardent desire to visit Italy; and, as he had just been appointed to the command of the Mediterranean squadron, he gracefully invited the artist to accompany him in his own ship, the "Centurion."

The offer was gladly accepted. While Keppel was conducting his tedious negotiations with the dey of Algiers, relative to the piracy with which that potentate was charged, Reynolds resided at Port Mahon, the guest of the governor of Minorca, painting portraits of the principal inhabitants; and in December 1749 he sailed for Leghorn, and thence, with all eagerness, made his way to Rome.

He has confessed that his first sight of the works of Raphael was a grievous disappointment, but he recognized afterwards, as he said, that the fault was in himself, and he brought his mind ultimately into the fitting posture of reverence. The fact is significant of Reynolds's attitude towards the older masters. It has been often noticed that in his "Discourses" and elsewhere he praises just the very masters whose practice his own work implicitly condemns. The truth is that Reynolds was naturally a good critic, but was not strong enough to believe in his own opinions if they ran counter to the prevailing taste of his times. Of the early Italians he praises the "simplicity and truth" and observes that they "deserve the attention of a student much more than many later artists." In Venice he adopted a method of study that only a born painter could have thought of, making memoranda of the gradations of light and shade in the pictures, "and this without any attention to the subject, or to the drawing of the figures." On the other hand, we find him lavishing both attention and eulogy on the later Italian mannerists, such as Guido and the Carracci, and even Salvati and Vasari.

After a residence of more than two years in Rome, where he caught a severe cold which resulted in the deafness that clung to him for the rest of his life, Reynolds, in the spring of 1752, spent five months in visiting Parma, Florence, Venice and other important cities of Italy. Returning to England by way of Paris, Reynolds, after a brief stay in Devonshire, established himself as a portrait painter in St Martin's Lane, London, whence he afterwards removed to Great Newport Street, and finally, in 1760, to Leicester Square, where he continued to paint till his death.

In London, Reynolds stepped at once and without a struggle into a foremost position as the fashionable portrait painter of the day. In this he was greatly helped by his success in society. Throughout his career his social occupations claimed the next place to his painting, and here it may be noticed that, though we read of some little ostentation in the form of a showy chariot and liveried lackeys, his good taste always kept him from any undue "push," or adulation of the great. At the outset Lord Edgcumbe played the part of the generous patron, and exerted himself to obtain commissions for his protégé, of whose ability the portraits which he now produced—especially the famous full-length of his old friend Keppel—were sufficient guarantee. The artist's painting room was thronged with the wealth and fashion of London. In 1755 his clients for the year numbered 120, and in 1757 the number of sittings recorded in his pocket-books reached a total of 677. He was not always so busy, but his popularity never really waned, though various other artists competed with him for popular applause. First the Swiss Liotard had his moment of popularity; and at a later period there was Opie, and the more formidable and sustained rivalry of Gainsborough and of Romney; but in the midst of all Reynolds maintained his position unimpaired. During the first year of his residence in London he had made the acquaintance of Dr Johnson, which, diverse as the two men were, became a friendship for life. To him Burke and Goldsmith, Garrick, Sterne and Bishop Percy were before long added. At the hospitable dinner-table of Reynolds such distinguished men enjoyed the freest and most unconstrained companionship, and most of them were members of the "Literary Club," established, at the painter's suggestion, in 1764.

In 1760 the London world of art was greatly interested by the novel proposal of the Society of Artists to exhibit their works to the public. The hall of the society was at their disposal for the purpose; and in the month of April an exceedingly successful exhibition was opened, the precursor of many that followed. To this display Reynolds contributed four portraits

In 1765 the association obtained a royal charter, and became known as "The Incorporated Society of Artists"; but much rivalry and jealousy were occasioned by the management of the various exhibitions, and an influential body of painters withdrew from the society. They had access to the young king, George III., who promised his patronage and help. In December 1768 the Royal Academy was founded, and Reynolds, whose adhesion to the movement was for a time doubtful, was hailed by acclamation its first president, an honour which more than compensated for his failure to obtain the appointment of king's painter, which, the previous year, had been bestowed on Allan Ramsay. In a few months the king signified his approval of the election by knighting the new president, and intimating that the queen and himself would honour him with sittings for portraits to be presented to the Academy.

Reynolds was in every way fitted for his new position, and till the late Lord Leighton the Academy never had so good a figure-head. He did not take any part in the educational work of the new institution, but on the social side he set the Academy on the lines it has followed with the greatest worldly success ever since. It was at his suggestion that the annual banquet was instituted. To the specified duties of his post he added the delivery of a presidential address at the distribution of the prizes, and his speeches on these occasions form the well-known "Discourses" of Sir Joshua. These discourses alone would be sufficient to entitle their author to literary distinction; indeed, when they were first delivered, it was thought impossible that they could be the production of a painter, and Johnson and Burke have been credited with their composition, in spite of the specific denials of both, and of Dr Johnson's indignant exclamation—"Sir Joshua, sir, would as soon get me to paint for him as to write for him!"

Sir Joshua was too prosperous and successful an artist altogether to escape the jealousy of his less fortunate or less capable brethren, and it must on the other side be admitted that his attitude towards some of his contemporaries was wanting in generosity. His relations with Gainsborough, who on his part was in fault, would require more space for discussion than can here be afforded, but he was not just either to Hogarth or to Richard Wilson. It may be added that though Reynolds's friends were genuinely fond of him, his was not a nature that could inspire or feel any great warmth of personal feeling. Cosmo Monkhouse in the *Dictionary of National Biography* speaks of "the beauty of his disposition and the nobility of his character," but adds: "he was a born diplomatist." The latter phrase gives the real key to his character. Without going so far as fully to endorse the sentiment of Mrs Thrale's famous line about a "heart too frigid" and a "pencil too warm," we must agree with a recent writer that the attitude of Reynolds towards his fellow men and women was one of detachment. Hence we regard Reynolds as a man with tempered admiration, and reserve our enthusiasm for his art. In 1784, on the death of Ramsay, Reynolds was appointed painter to the king. Two years previously he had suffered from a paralytic attack; but, after a month of rest, he was able to resume his painting with unabated energy and power. In the summer of 1780 his sight began to fail; he was affected by the *gutta serena*, but the progress of the malady was gradual, and he continued occasionally to practise his art till about the end of 1790, delivering his final discourse at the Academy on the 10th of December. He was still able to enjoy the companionship of his friends, and he exerted himself in an effort to raise funds for the erection of a monument in St Paul's to Dr Johnson, who had died in 1784. Towards the end of 1791 it was evident to the friends of Reynolds that he was gradually sinking. For a few months he suffered from extreme depression of spirits, the result of a severe form of liver complaint, and on the 23rd of February 1792 this great artist and blameless gentleman passed peacefully away.

As a painter Reynolds stands, with Gainsborough, just behind the very first rank. There can be no question of placing him by

the side of the greatest Venetians or of the triumvirate of the 17th century, Rubens, Rembrandt, Velasquez; but, if he fail also to equal either Hals or Van Dyck, this is due, not to any defect in his natural capacity, but to deficiencies in his education combined with the absence in his case of that splendid artistic tradition on which the others leaned. He could not draw the figure properly; nor could he as a rule compose successfully on anything like a monumental scale. English painters in his early days possessed a sound technique, and most of Hogarth's best pictures are perfectly well presented as well as being painted by Reynolds. Reynolds was not content with the tried methods Hudson could have taught him. In the desire to compass that creaminess, that juicy opulence in colour and texture, of which he conceived the idea before the Italian journey, and which he found realized in the works of the Venetians and Correggio, he embarked on all sorts of fantastic experiments in pigments and media, so that Haydon exclaimed, "The wonder is that the picture did not crack beneath the brush!" The result was the speedy ruin of many of his own productions, and he inaugurated an era of uncertainty in method which seriously compromised the efforts of his successors in the English school.

The motive for this procedure may explain if it do not justify it. It was all he could do to satisfy a perpetual desire to advance; and he accounts for his own uncertainty partly from his want of training, and partly from his "inordinate desire to possess every kind of excellence," he saw in the works of others. Now if this mental energy led him into hazardous attempts to find a royal road to the painter's ideal, it acted well upon his design in lending to it a certain intellectual solidity, which gives it an advantage over the slighter, though at times more exquisite, productions of the pencils of Gainsborough or Romney. The weight and power of the art of Reynolds are best seen in those noble male portraits, "Lord Heathfield," "Johnson," "Sterne," "Goldsmith," "Gibson," "Burke," "Boswell," "Garwick," that are historical monuments as well as sympathetic works of art. In this category must be included his immortal "Mrs Siddons as the Tragic Muse."

In portraits of this order Reynolds holds the field, but he is probably more generally admired for his studies of women and of children, of which the Althorp portraits of the Spencer family are classic examples. Nature had singled out Sir Joshua to endow him with certain gifts in which he has hardly an equal. No portrait painter has been more happy in his poses for single figures, or has known better how to control by good taste the piquant, the accidental, the daring, in mien and gesture. "Viscountess Crosbie" is a striking instance. When dealing with more than one figure he was not always so happy, but the "Duchess of Devonshire and her Baby," the "Three Ladies decking a Figure of Hymen," and the "Three Ladies Waldegrave" are brilliant successes. He was felicitous too in his arrangement of drapery, often following his own fashion of investing his graceful dames in robes of ideal cut and texture, quite apart from the actual clothes worn at the time. Few painters, again, have equalled the president in daintiness and at the same time firm manipulation of the brush. The richness of his deeper colouring is at times quite Venetian. For pure delight in the quality of paint and colour we cannot do better than go to the "Angels' Heads" of the National Gallery, or the "Nelly O'Brien" in the Wallace Collection.

It corresponds with what has been noted as Reynolds's habit of mind in regard to older art to find him throughout his life hankering after success in what he was fond of calling the "grand style" in "historical painting." His failure here is as notorious as his brilliant success in the field of art for which nature had equipped him. His "Ugolino," his "Macbeth," his "Cardinal Beaufort," have no real impressiveness, while his greatest effort in the "historic" style, the "Infant Hercules" at St Petersburg, resulted in his most conspicuous disaster.

It is in the "Discourses" that Reynolds unfolds these artistic theories that contrast so markedly with his own practice. The first discourse deals with the establishment of an academy for the fine arts, and of its value as being a repository of the traditions of the best of bygone practice, of "the principles which many artists have spent their lives in ascertaining." In the second lecture the study of the painter is divided into three stages,—in the first of which he is busied with processes and technicalities, with the grammar of art, while in the second he examines what has been done by other artists, and in the last compares these results with Nature herself. In the third discourse Reynolds treats of "the great and leading principles of the grand style"; and succeeding addresses are devoted to such subjects as "Moderation," "Taste," "Genius," and "Sculpture." The fourteenth has an especial interest as containing a notice of Gainsborough, who had died shortly before its delivery; while the concluding discourse is mainly occupied with a panegyric on Michelangelo.

The other literary works of the president comprise his three essays in *The Idler* for 1759-1760 ("On the Grand Style in Painting," and "On the True Idea of Beauty"), his notes to Du Fresnoy's *Art of Painting*, his *Remarks on the Art of the Low Countries*, his brief notes in Johnson's *Shakespeare*, and two singularly witty and brilliant fragments, imaginary conversations with Johnson, which

were never intended by their author for publication, but, found among his papers after his death, were given to the world by his niece, the marchioness of Thomond.

The president left to his niece, Mary Palmer, the bulk of his property, about £100,000, with works of art that sold for £30,000 more. There were, besides, legacies amounting to about £15,000. His body rests in St Paul's.

See Northcote, *Memoirs of Sir Joshua Reynolds, Knight, etc.* (1813), and *Supplement* thereto (1815); Farrington, *Memoirs of the Life of Sir Joshua Reynolds* (1819); Cotton, *Sir Joshua Reynolds and his Works* (edited by Burnet, 1856); Leslie and Taylor, *Life and Times of Sir Joshua Reynolds* (2 vols., 1865); Redgrave, *A Century of English Painters* (1866), vol. 1.; Graves and Cronin, *A History of the Works of Sir Joshua Reynolds, P.R.A.* (4 vols., 1899-1901); Sir Walter Armstrong, *Sir Joshua Reynolds, First President of the Royal Academy* (1900); also a shorter work, 1905; Lord Ronald Gower, *Sir Joshua Reynolds* (1902). For Reynolds's literary works, see Malone, *The Works of Sir Joshua Reynolds, Knight* (3 vols., 1798); Beechey, *Literary Works of Sir Joshua Reynolds* (1835); Leisching, *Sir J. Reynolds zur Aesthetik u. Technik der bildenden Künste* (Leipzig, 1893); *Discourses delivered to the Students of the Royal Academy by Sir Joshua Reynolds, Kt.*, with introductions and notes by Roger Fry (1905).

REYNOLDS, WALTER (d. 1327), archbishop of Canterbury, was the son of a Windsor baker, and became a clerk, or chaplain, in the service of Edward I. He held several livings and, owing perhaps to his histrionic skill, he became a prime favourite with the prince of Wales, afterwards Edward II. Just after the prince became king in 1307 Reynolds was appointed treasurer of England; in 1308 he became bishop of Worcester and in 1310 chancellor. When Robert Winchelsea, archbishop of Canterbury, died in May 1313 Edward II. prevailed upon Pope Clement V. to appoint his favourite to the vacant archbishopric, and Walter was enthroned at Canterbury in February 1314. Although the private life of the new archbishop appears to have been the reverse of exemplary he attempted to carry out some very necessary reforms in his new official capacity; he also continued the struggle for precedence, which had been carried on for many years between the archbishops of Canterbury and of York. In this connexion in 1317 he laid London under an interdict after William de Melton (d. 1340), archbishop of York, had passed through its streets with his cross borne erect before him. Reynolds remained in general loyal to Edward II. until 1324, when with all his suffragans he opposed the king in defence of the bishop of Hereford, Adam of Orilton. In the events which concluded Edward's life and reign the archbishop played a contemptible part. Having fled for safety into Kent he returned to London and declared for Edward III., whom he crowned in February 1327. He died at Mortlake on the 16th of November following.

REZÁNOV, NICOLAI PETROVICH DE (1764-1807), Russian nobleman and administrator under Catherine II., Paul I. and Alexander I., was one of the ten barons of Russia, and, for his services to the empire, was rewarded with the court title of chamberlain. In 1803 he was made a privy councillor and invested with the order of St Ann. He was also the author of a lexicon of the Japanese language and of several other works, which are preserved in the library of the St Petersburg Academy of Sciences, of which he was a member. He was the first Russian ambassador to Japan (1804), and instigated the first attempt of Russia to circumnavigate the globe (1803), commanding the expedition himself as far as Kamchatka. But Rezánov's monument for many years after his death was the great Russian American Fur Company; and his interest to students of history centres round the policy involved in that enterprise, which, thwarted by his untimely death, would have changed the destinies of Russia and the United States.

Meeting (in 1788) Shelkov, chief of the Shelkov-Golikov Fur Company, Rezánov became interested in the merchant's project to obtain a monopoly of the fur trade in those distant dependencies. Conscious of latent energies, and already tired of the pleasures of a dissolute court, he became a partner in the company, and rapidly developed into a keen and tireless man of business. At the death of Shelkov in 1795 he became the leading spirit of the wealthy and amalgamated but harassed companies, and resolved to obtain for himself and his partners

privileges analogous to those granted by Great Britain to the East India Company. He had just succeeded in persuading Catherine to sign his charter when she died, and he was obliged to begin again with the ill-balanced and intractable Paul. For a time the outlook was hopeless; but Rezánov's skill, subtlety and address prevailed, and shortly before the assassination of the emperor Paul he obtained his signature to the momentous instrument which granted to the Russian-American Company, for a term of twenty years, dominion over the coast of N.W. America, from latitude 55 degrees northward; and over the chain of islands extending from Kamchatka northward and southward to Japan. This famous "Trust," which crowded out all the small companies and independent traders, was a source of large revenue to Rezánov and the other shareholders, including members of the Imperial family, until the first years of the 19th century, when mismanagement and scarcity of nourishing food threatened it with serious losses if not ultimate ruin. Rezánov, his humiliating embassy to Japan concluded, reached Kamchatka in 1805, and found commands awaiting him to remain in the Russian colonies as Imperial inspector and plenipotentiary of the company, and to correct the abuses that were ruining the great enterprise. He travelled slowly to Sitka by way of the Islands, establishing measures to protect the fur-bearing animals from reckless slaughter, punishing or banishing the worst offenders against the company's laws, and introducing the civilizing influence of schools and libraries, most of the books being his personal gifts. He even established cooking schools, which flourished briefly.

At the end of a winter in Sitka, the headquarters of the company, during which he half-starved with the others, he bought a ship from a Yankee skipper and sailed for the Spanish settlements in California, purposing to trade his tempting cargo of American and Russian wares for food-stuffs, and to arrange a treaty by whose terms his colonies should be provisioned twice a year with the bountiful products of New Spain. He cast anchor in the harbour of San Francisco early in April 1806, after a stormy voyage which had defeated his intention to take possession of the Columbia river in the name of Russia. Although he was received with great courtesy and entertained night and day by the gay Californians, no time was lost in informing him that the laws of Spain forbade her colonies to trade with foreign powers, and that the governor of all the Californias was incorruptible. Rezánov, had it not been for a love affair with the daughter of the comandante of San Francisco, Don José Argüello, and for his personal address and diplomatic skill, with which he won over the clergy to his cause, would have failed again. As it was, when he sailed for Sitka, six weeks after his arrival, the "Junco's" hold was full of bread-stuffs and dried meats, he had the promise of the perplexed governor to forward a copy of the treaty to Spain at once, and he was affianced to the most beautiful girl in California. Shortly after his arrival in Sitka he proceeded by water to Kamchatka, where he despatched his ships to wrest the island Sakhalen of the lower Kurile group from Japan, then started overland for St Petersburg to obtain the signature of the tsar to the treaty, and also personal letters to the pope and king of Spain that he might ask for the dispensation and the royal consent necessary to his marriage. He died of fever and exhaustion in Krasnoyarsk, Siberia, on the 8th of March 1807.

The treaty with California, the bare suggestion of which made such a commotion in New Spain, was the least of Rezánov's projects. It was sincerely conceived, for he was deeply and humanely concerned for his employees and the wretched natives who were little more than the slaves of the company; but its very obviousness raised the necessary amount of dust. His correspondence with the company, and with Zapinsky, betrays a clearly defined purpose to annex to Russia the entire western coast of North America, and to encourage immediate emigration from the parent country on a large scale. Had he lived, there is, all things considered, hardly a doubt that he would have accomplished his object. The treaty was never signed, the reforms of Rezánov died of discouragement, the fortunes of

the colonies gradually collapsed, the Spanish girl who had loved Rezánov became a nun; and one of the ablest and most ambitious men of his time lies forgotten in the cemetery of a poor Siberian town.

See Bancroft's *History of California, and Alaska*; Tikménev's *Historical Review of the Origin of the Russian American Company*; Rezánov-Zapiski Correspondence; Travels of Krusenstern and Langford, &c. (G. A. *)

RHACIS, or **RACHIS** (Gr. *ράχης*, a backbone), in botany the axis of an inflorescence or of a branched leaf; in zoology, the stem of a feather, as opposed to the vesticulum, or web.

RHADAMANTHUS (Gr. Rhadamanthys), in Greek mythology, son of Zeus and Europa and brother of Minos, king of Crete. Driven out of Crete by his brother, who was jealous of his popularity, he fled to Boeotia, where he wedded Alcmena. Homer represents him as dwelling in the Elysian fields (*Odyssey*, iv. 564). According to later legends, on account of his inflexible integrity he was made one of the judges of the dead in the lower world, together with Aeacus and Minos. He was supposed to judge the souls of Asiatics, Aeacus those of Europeans, while Minos had the casting vote (Plato, *Gorgias*, 424A).

RHAETIC (Fr. *Rhétien* or *Rhätien*; Ger. *Rhät* or *Rhätisch*; It. *Rético*), in geology, the assemblage of rocks classed by most English and German authorities in the Triassic system, and by most French geologists placed at the base of the Lias, in the Jurassic system. It has been called the *Infra-Lias*. This diversity of opinion is due to the fact that the Rhaetic formation presents the characters of a group of passage-beds, uniting certain features of the Trias with others of the Jurassic system; none the less, it has sufficient individuality to be recognized with tolerable certainty over a wide area, in Europe and beyond. The name Rhaetic was first applied by C. W. Gümbel to the strata of this horizon in the Rhaetic Alps, where they are thickly developed and in parts fossiliferous. The labours of E. V. Mojsisovic and E. Suess have demonstrated that in the Alpine Rhaetic several distinct facies may be recognized, viz. a Swabian facies: shore and lagoon deposits with a pelecypod fauna, poor in species but rich in individuals; a Carpathian facies with corals, algae, *Tereratulina gregaria* and *Plicatula industrialis*, exemplified in the upper part of the Dachstein limestone; a Kössener facies: black limestones and marls, with a brachiopod fauna in which *Spirigera oxycolpos* is very noticeable; and a Salzburg facies, characterized by pelagic pelecypods and some ammonites (see table in TRIASSIC SYSTEM). The whole of the Rhaetic falls within Mojsisovic's zone of *Avicula contorta*. This epoch is marked off from the earlier Triassic period by a very general marine transgression which proceeded with minor irregularities and retrogressions over the whole area, until at its close it was followed by the more decided transgression which indicates the commencement of the Lias.

Among the marine fossils of the Rhaetic, *Avicula contorta*, the principal zone form, is very characteristic and has a wide range; *Myophoria inflata*, *Modiola minuta*, *Protocardium rhaeticum* and *Tereratulina gregaria* are common species. True bellerophonites make their first appearance. Corals, *Thecosmilites*, &c., are common in some districts. Plant remains are abundant in certain areas, and in places give rise to beds of lignite and coal. The flora is more nearly akin to that of the Trias than to that of the Jurassic rocks. Vertebrate remains are fairly abundant in the form of teeth, isolated bones, scales and coprolites in what are known as "Bone Beds" (*q.v.*). These beds are a very characteristic feature; they occur on several horizons in many tracts of the European Rhaetic, and recur in beds of this age in America. In England there is usually a bone bed about the base of the formation; in Germany one occupies a similar position; a second occurs less constantly about the middle, and in the Württemberg district a third bed separates the Rhaetic and Lias, and constitutes the well-known manure bed of Bebenhausen. In these beds are found the bones of *Ichthyosaurus* and *Pliosaurus*, anticipating their great development in the Lias, while the remains of *Belodon* and *Mystriosuchus* serve to link this epoch with Triassic stego-

cephalian reptiles. Several coleopterous insects have been found in the same beds, but the most interesting feature of the bone-bed fauna is the first appearance in the northern hemisphere of true mammals: *Microlestes* in England and Württemberg, *Triglyphus* in Württemberg, *Dromatherium* and *Microcodon* in America.

In England the Rhaetic formation occurs as a thin but constant series of beds at the base of the Lias and above the Keuper marls. The upper part, often called the "White Lias," is a series of thin-bedded shales, limestone and marls, 1 to 25 ft. thick; the lower portion consists mainly of dark shales, sometimes with very perfect lamination—"paper shales." Below there are beds of grey and "teal-green" marls which are now usually regarded as the topmost Keuper beds, but they have often been included in the Rhaetic formation (see KEUPER). The best exposures in Britain are those between Penarth Head and Cavernock Point, Aust Cliff and Garden Cliff near Westbury-on-Severn, and Wainloade Cliff between Tewkesbury and Gloucester. From their excellent development near Penarth the Rhaetic beds have long been known in England as the Penarth Beds (H. W. Bristow, 1864). The more prominent beds in the White Lias of the west of England and Glamorganshire are the *Estheria* beds and the insect limestone or *Pseudomonotis*-bed, and on both of these horizons the limestone may assume the peculiar character of a lacustrine marble, sometimes called Cotham marble, from Cotham House near Bristol. A hard fine-grained limestone, known locally as the Sun-bed, occurs at the top of the series near Bath and Radstock; at Street, Wedmore and south of the Mendips generally it is called Jew stone. Wedmore stone is a tough, shelly and sandy limestone in the black shales at Wedmore, near Wells; it is employed in the neighbourhood as a building stone. North of Somersetshire the White Lias is poorly represented; in Glamorganshire it appears between Cardiff and Pyle, west of Bridgend and at Sutton and Southerndown. Rhaetic beds have been traced at Merton, Dryton, Salop, near Audlem, Cheshire; Rugby and Stratford-on-Avon, Warwickshire; Leominster, Hereford; Needham Forest in Staffordshire, and in Nottinghamshire and Yorkshire as far as the coast. They have not yet been proved beneath the Lias of Cumberland. Rhaetic fossils have been found in great numbers in fissures in the Carboniferous limestone of the Mendips. On the western side of Scotland Rhaetic rocks occur at Applecross, Ardnurchan, Morven, Mull, Raasay and Skye. In Strathlandshire sandstone and conglomerate and large transported masses occur, one of them, at Linksfield, carries a bone bed. Here the black shales of the English type fall; sandstones with coaly layers and well-developed corals, oolitic limestones take their place. In Antrim a small outcrop of black shales with *Avicula contorta* occurs near Port Rush.

On the European continent the Rhaetic rocks are most thickly developed in the Alpine regions; and, as in the case of the older Triassic formations, calcareous and dolomitic strata predominate here and in the Mediterranean province. In the Alpine district the main divisions are the Rhaetic Dachstein limestone and the Kössener beds; shales, marls and limestones. In the northern tract the following subdivisions have been recognized in descending order: beds with *Christiferos Marschi*; Starheim passage beds; *Rhynchonella* beds; *Lithodendron* limestone; *Avicula contorta*; *Tereratulina gregaria*; beds with *Avicula contorta*; "Platten Kalk" with *Rhynchonella alpina*. In the southern tract the subdivisions are: Conchodus dolomite (*Conchodus infrafrassiacus* = *Lycodius cor.*); *Lithodendron* limestone, Azzarola beds, *Contorta* marls, "Plattenkalk." Much limestone is of the "reef" type. In Germany the rocks are mainly fine, clean yellow sands, suggesting littoral or dune conditions, with bituminous clays and marls. The formation is often missing in south-west Germany. Similar beds occur in Lorraine and Luxembourg (gros de Vic, gres de Kédange, gres de Mortinari). In Coirentine are dolomitic sandstones and marl; round the central plateau of France the rocks are coarse sands, arkoses, and conglomerates; while in the south of France the sandy and calcareous facies occur intermixed. In Spain limestones and dolomites occur up to 300 metres in thickness; in Portugal sandy beds recur. The Rhaetic of Scania, south Sweden, consists mainly of sandstone and shales with beds of coal up to one metre thick. Only the upper beds contain marine fossils; the bulk of the formation is of lacustrine or estuarine origin, with plant remains and insects. In Italy the formation is well developed in the north and at Rotzo, Spezia and Carrara; and yields the famous statuary marble and the black variegated marble of *Belvedere*. Rhaetic limestones have been recognized in Sardinia, Corsica, Sicily, in the Balkan Peninsula and Greece; in Asia Minor, Afghanistan, Turkistan, Persia, Siberia and India (limestones and dolomites of Niti and the Mahaveda beds, sandstones and conglomerates, nearly 10,000 feet thick in Satpura); in China, Japan and Tongking (with coal beds). In Australasia the Wanamatta beds of New South Wales, the Bellarine beds of Victoria, the Ipswich and Tivoli beds of Queensland, and the Jerusalem beds of Tasmania, and beds on a similar horizon in New Zealand, have been regarded as equivalents of the Rhaetic. In Africa the Stormberg beds of the Karoo series and the Molteno beds

of the Cape have been assigned to this epoch. In America Rhaetic rocks are recognized in N. Carolina, Connecticut, California, Mexico, Bolivia and Chile; the formation is also recorded from Spitzbergen, Franz Joseph Land and elsewhere in the Arctic regions.

For the English Rhaetic see L. Richardson, "The Rhaetic Rocks of North-west Gloucestershire," *Proc. Cotswold Club*, xiv, p. 127 (Gios. 1901-1903). (J. A. H.)

RHAMNUS PURSHIANA, or Californian buckthorn, a plant the bark of which is used in medicine under the name of cascara sagrada. An active principle anthra-gluco-sagradin has been isolated by Tschirch. The preparations of it contained in the British pharmacopoeia are: (1) *Extractum cascarae sagradae* (extractum rhamni purshianae, United States pharmacopoeia), dose 2 to 8 grs.; (2) *Extractum cascarae sagradae liquidum*, dose $\frac{1}{2}$ to 1 fl. dr. From the latter is prepared *syrupus cascarae aromaticus*, dose $\frac{1}{2}$ to 2 fl. dr. In this preparation the bitter taste of the cascara sagrada is disguised by the addition of tincture of orange, cinnamon water and syrup. In the United States pharmacopoeial preparation *Fluid extractum rhamni purshianae aromaticum*, does 10 to 30 minims, the taste is similarly obscured. Cascara sagrada is one of the most useful of all laxatives, since not only does it empty the bowel of faecal matter, but it acts as a tonic to the intestine and tends to prevent future constipation. It is largely used in the treatment of chronic constipation. A single full dose of the liquid extract may be taken at bedtime, or divided doses, 10 to 15 minims, three times a day before meals. When a strong purgative is required some drug other than cascara sagrada should be employed, but its use in gradually decreasing doses is indicated after evacuation has been effected by podophyllin or rhubarb. Cascara sagrada is the principal constituent of most of the proprietary laxatives on the market.

RHAMPSINITUS, a Greek corruption of Ra-messu-pa-ner, the popular name of Rameses III., king of Egypt of the XXth Dynasty. He is well known in connexion with the story of his treasure house told by Herodotus (i. 121), which greatly resembles that of Agamenes and Trophonius. (See EGYPT, History.)

RHANKAVES (commonly also RHANGABE), **ALEXANDROS RHIZOS** (1810-1892), Greek savant, poet and statesman, was born at Constantinople of a Phanariot family on the 25th of December 1810. He was educated at Odessa and the military school at Munich. Having served as an officer of artillery in the Bavarian army, he returned to Greece, where he held several high educational and administrative appointments. He subsequently became ambassador at Washington (1867), Paris (1868), and Berlin (1874-1886), and was one of the Greek plenipotentiaries at the congress of 1878. After his recall he lived at Athens, where he died on the 20th of June 1892. He was the chief representative of a school of literary men whose object was to restore as far as possible the ancient classical language. Of his various works, *Hellenic Antiquities* (1842-1855, of great value for epigraphical purposes), *Archaeologia* (1865-1866), an illustrated *Archaeological Lexicon* (1888-1891), and a *History of Modern Greek Literature* (1877) are of the most interest to scholars. He wrote also the following dramatic pieces: *The Marriage of Kairules* (comedy), *Dukas* (tragedy), *The Thirty Tyrants*, *The Eve* (of the Greek revolution); the romances, *The Prince of Morea*, *Leila*, and *The Notary of Argostoli*; and translated portions of Dante, Schiller, Lessing, Goethe and Shakespeare.

A complete edition of his philological works in nineteen volumes was published at Athens (1874-1890), and his *Ἀπομνημονεύματα* (Memoirs) appeared posthumously in 1894-1895.

RHAPSODIST (Gk. *Rhapsōidos*), originally an epic poet who recited his own poetry; then, one who recited the poems of others (see HOMER).

RHATANY or **KRAMERIA ROOT**, in medicine, the dried root either of *Para rhatany* or of Peruvian rhatany. The action of rhatany is due to the rhatanian-tannic acid, and resembles that of tannic acid, being a powerful astringent. An infusion is used as a gargle for relaxed throats; and lozenges, particularly those containing rhatany and cocaine, are useful

in similar cases. Like tannic acid, the powdered extract may be applied as a local haemostatic. All preparations of rhatany taken internally are powerful astringents in diarrhoea and intestinal haemorrhage.

RHAYADER (*Rhaiadr-Gwy*), a market town of Radnorshire, Wales, situated amid wild and beautiful scenery on the left bank of the Wye, about 1½ m. above its confluence with the Elan. Pop. (1901) 1215. Rhayader is a station on the Cambrian railway. A stone bridge over the Wye connects the town with the village and parish church of Cwmdaeddwr. Rhayader has for some centuries been an important centre for Welsh mutton and wool, and its sheep fairs are largely attended by drovers and buyers from all parts. Near Rhayader are the large reservoirs constructed (1805) by the corporation of Birmingham in the Elan and Claerwen valleys.

Rhayader, built close to the Falls of the Wye (whence its name), owes its early importance to the castle erected here by Prince Rhys ap Griffith of South Wales, c. 1179, in order to check the English and advance up the Wye Valley. Seized by the invaders, castle and town were later retaken in 1231 by Prince Llewelyn ap Iorwerth who burned the fortress and slew its garrison. Scarcely a trace of the castle exists, although its site near St Clement's church is locally known as Tower Hill. With the erection of Maccsfyfed into the shire of Radnor in 1536 Rhayader was named as assize-town for the newly formed county in conjunction with New Radnor; but in 1542, on account of a local riot, the town was deprived of this privilege in favour of Presteigne. Rhayader constituted one of the group of boroughs comprising the Radnor parliamentary district until the Redistribution Act of 1885.

RHEA, a goddess of the Greeks known in mythology as the daughter of Uranus and Gaia, the sister and consort of Kronos, and the mother of Zeus. In Homer she is the mother of the gods, though not a universal mother like Cybele, the Phrygian Great Mother, with whom she was later identified. The original seat of her worship was in Crete. There, according to legend, she saved the new-born Zeus, her sixth child, from being devoured by Kronos by substituting a stone for him and entrusting the infant god to the care of her attendants the Curetes (*q.v.*). These attendants afterwards became the bodyguard of Zeus and the priests of Rhea, and performed ceremonies in her honour. In historic times the resemblances between Rhea and the Asiatic Great Mother, Phrygian Cybele, were so noticeable that the Greeks accounted for them by regarding the latter as only their own Rhea, who had deserted her original home in Crete and fled to the mountain wilds of Asia Minor to escape the persecution of Kronos (Strabo 469, 12). The reverse view was also held (Virgil, *Aen.* iii. 111), and it is probably true that a stock of Asiatic origin formed part of the primitive population of Crete and brought with them the worship of the Asiatic Great Mother, who became the Cretan Rhea. (See GREAT MOTHER OF THE GODS.) (G. SN.)

RHEA, the name given in 1752 by P. H. G. Möhring¹ to a South American bird which, though long before known and described by the earlier writers—Nieremberg, Marcgrav and Piso (the last of whom has a recognizable but rude figure of it)—had been without any distinctive scientific appellation. Adopted a few years later by M. J. Brisson, the name has since passed into general use, especially among English authors, for what their predecessors had called the American ostrich; but on the European continent the bird is commonly called *Nandu*,² a word corrupted from a name it is said to have borne among the aboriginal inhabitants of Brazil, where the Portuguese settlers called it *ema* (see EMU). The resemblance of the rhea to the ostrich (*q.v.*) was at once perceived, but the differences between them are also very evident. The former, for instance, has three instead of two toes on each foot, it has no apparent tail, its wings are far better developed, and when folded cover the body, and its head and neck are clothed with feathers, while internal distinctions of still deeper significance have since been

¹ What prompted his bestowal of this name, so well known in classical mythology, is not apparent.

² The name *Touyou*, also of South American origin, was applied to it by Brisson and others, but erroneously, as Cuvier shows, since, by that name, or something like it, the jabiru (*q.v.*) is properly meant.

dwelt upon by T. H. Huxley (*Proc. Zool. Society*, 1867, pp. 420-422) and W. A. Forbes (*op. cit.*, 1881, pp. 784-87). There can be little doubt that they should be regarded as types of as many orders—*Struthionies* and *Rheae*—of the subclass *Ratitae*. Structural characters no less important separate the rheas from the emeus; the former can be readily recognized by the rounded form of their contour-feathers, which want the *hyporrhachis* or after-shaft that in the emeus and cassowaries is so long as to equal the main shaft, and contributes to give these latter groups the appearance of being covered with shaggy hair. The feathers of the rhea have a considerable market value, and for the purpose of trade in them it is annually killed by thousands, so that its total extinction as a wild animal is probably only a question of time. It is polygamous, and the male performs the duty of incubation, brooding more than a score of eggs, the produce of several females—facts known to Niereberger



Rhea.

more than two hundred and fifty years since, but hardly accepted by naturalists until recently. No examples of this bird seem to have been brought to Europe before the beginning of the present century, and accordingly the descriptions previously given of it by systematic writers were taken at second hand and were mostly defective if not misleading. In 1803 J. Latham issued a wretched figure of the species from a half-grown specimen in the Leverian Museum, and twenty years later said he had seen only one other, and that still younger, in Bullock's collection (*Gen. Hist. Birds*, viii. p. 379).² A bird living in confinement at Strassburg in 1806 was, however, described and figured by Hammer in 1808 (*Ann. du Muséum*, xii. pp. 427-

¹ J. E. Harting, in his *De Mesenthal's Ostriches and Ostrich Farming*, from which the woodcut here introduced is by permission copied, gives (pp. 67-72) some portentous statistics of the destruction of rheas for the sake of their feathers, which, he says, are known in the trade as "Vautour" to distinguish them from those of the African bird.

² The ninth edition of the *Companion* to this collection (1810, p. 121) states that the specimen "was brought alive" [?to England].

433, pl. 39). In England the *Report* of the Zoological Society for 1833 announced the rhea as having been exhibited for the first time in its gardens during the preceding twelvemonth. Since then many other living examples have been introduced, and it has bred both there and in many private parks in Britain.

Though considerably smaller than the ostrich, and wanting its fine plumes, the rhea in general aspect far more resembles that bird than the other *Ratitae*. The feathers of the head and neck, except on the crown and nape, where they are dark brown, are dingy white, and those of the body ash-coloured tinged with brown, while on the breast they are brownish-black, and on the belly and thighs white. In the course of the memorable voyage of the "Beagle," C. Darwin came to hear of another kind of rhea, called by his informants *Avestruz petise*, and at Port Desire on the east coast of Patagonia he obtained an example of it, the imperfect skin of which enabled J. Gould to describe it (*Proc. Zool. Society*, 1837, p. 35) as a second species of the genus, naming it after its discoverer. *Rhea darwini* differs in several well-marked characters from the earlier known *R. americana*. Its bill is shorter than its head; its tarsi are reticulated instead of scutellated in front, with the upper part feathered instead of being bare; and the plumage of its body and wings is very different, each feather being tipped with a distinct whitish band, while that of the head and neck is greyish-brown. A further distinction is also asserted to be shown by the eggs—those of *R. americana* being of a yellowish-white, while those of *R. darwini* have a bluish tinge. Some years afterwards P. L. Slater described (*op. cit.*, 1860, p. 207) a third and smaller species, closely resembling the *R. americana*, but having apparently a longer bill, whence he named it *R. macrohyncha*, more slender tarsi, and shorter toes, while its general colour is very much darker, the body and wings being of a brownish-grey mixed with black. The precise geographical range of these three species is still undetermined. While *R. americana* is known to extend from Paraguay and southern Brazil through the La Plata region to an uncertain distance in Patagonia, *R. darwini* seems to be the proper inhabitant of the country last named, though M. Claraz asserts (*op. cit.*, 1885, p. 324) that it is occasionally found to the northward of the Rio Negro, which had formerly been regarded as its limit, and, moreover, that flocks of the two species commingled may be very frequently seen in the district between that river and the Rio Colorado. On the "pampas" *R. americana* is said to associate with herds of deer (*Cariacus campestris*), and *R. darwini* to be the constant companion of guanacos (*Lama huanaco*)—just as in Africa the ostrich seeks the society of zebras and antelopes. As for *R. macrohyncha*, it was found by W. A. Forbes (*Ibis*, 1881, pp. 360, 361) to inhabit the dry and open "sertões" of north-eastern Brazil, a discovery the more interesting since it was in that part of the country that Marçgr and Piso became acquainted with a bird of this kind, though the existence of any species of rhea in the district had been long overlooked by or unknown to succeeding travellers.

Besides the works above named and those of other recognized authorities on the ornithology of South America such as Azara, Prince Max of Wied, Professor Burmeister and others, more or less valuable information on the subject is to be found in Darwin's *Voyage*, Dr Böcking's "Monographie des Nandu" in (Wiegmann's) *Archiv für Naturgeschichte* (1863, i. pp. 213-41); R. O. Cunningham's *Natural History of the Strait of Magellan* and paper in the *Zoological Society's Proceedings* for 1871 (pp. 105-110), as well as H. F. Gadow's still more important anatomical contributions in the same journal for 1885 (pp. 308 seq.).

(A. N.)

RHEINBERGER, JOSEPH GABRIEL (1839-1901), German composer, was born at Vaduz, Liechtenstein, on the 17th of March 1839. His musical abilities were manifested so early that he was appointed organist of the parish church when he was but seven years old. A three-part Mass composed by him was performed in the following year. He was taught at first by Philipp Schmutzer, choir director at Feldkirch; he entered the Munich Conservatorium in 1851, and remained there till 1854

as a pupil of Professor E. Leonhard for piano, Professor Herzog for organ and J. J. Maier for counterpoint. After leaving the school he had private lessons from Franz Lachner, and was appointed a professor in the conservatorium in succession to Leonhard in 1850. In 1860 he became professor of composition, and was appointed organist of the Michelskirche, a post he held till 1866. In 1877 he succeeded Wüllner as Hofkapellmeister, and from that time his attention was largely devoted to sacred music. His compositions include works of importance in every form, from the operas *Die sieben Raben* (Munich, 1866) and *Türmers Töchterlein* (Munich, 1873) and the oratorio *Christoforus*, op. 120, to the well-known quartet for piano and strings in E flat, op. 38, the nonet for wind and strings, op. 130, and the seventeen organ sonatas, which form notable additions to the literature of the instrument. He died in November 1901.

RHEINE, a town of Germany, in the Prussian province of Westphalia, situated on the Ems, at the point where it becomes navigable, 29 m. W. by rail of Osnabrück, and at the junction of main lines to Münster, Rotterdam and Emden. Pop. (1905) 12,801. It is an old-fashioned town with a pronounced Dutch aspect, and has pretty gardens and promenades. Rheine is the seat of cotton industries, has manufactures of jute, machinery, tobacco and flour, and a considerable river trade in agricultural produce. It received municipal rights in 1327. About a mile north of Rheine is the castle of Bentlage, the family seat of the princes of Rheina-Wolbeck.

RHENANUS, BEATUS (1485-1547), German humanist, was born in 1485 at Schlettstadt in Alsace, where his father, named Bild, a native of Rheinau (hence the surname *Rhenanus*), was a prosperous butcher. He received his early education at the famous Latin school of Schlettstadt, and afterwards (1503) went to Paris, where he came under the influence of Jacobus Faber Stapulensis, an eminent Aristotelian. In 1511 he removed to Basel, where he became intimate with Desiderius Erasmus, and took an active share in the publishing enterprises of Joannes Froben (q.v.). In 1526 he returned to Schlettstadt, and devoted himself to a life of learned leisure, enlivened with epistolary and personal intercourse with Erasmus (the printing of whose more important works he personally superintended) and many other scholars of his time. He died at Strassburg on the 20th of July 1547.

His earliest publication was a biography of Geller of Kaisersberg (1510). Of his subsequent works the principal are *Rerum Germanicarum Libri III.* (1531), and editions of *Velleius Paterculus* (ed. princeps, from a MS. discovered by himself, 1522); *Tacitus* (1519, exclusive of the *Histories*); *Livius* (1535); and *Erasmus* (with a life, 9 vols. fol., 1540-41).

See A. Horawitz, *Beatus Rhenanus* (1872), and by the same, *Des Beatus Rhenanus literarische Tätigkeit* (2 vols., 1872); also the notice by R. Hartfelder in *Allgemeine Deutsche Biographie*.

RHETICUS, or **RHAETICUS** (1514-1576), a surname given to GEORGE JOACHIM, German astronomer and mathematician, from his birth at Feldkirch in that part of Tirol which was anciently the territory of the Rhaeti. Born on the 15th of February 1514, he studied at Tiguri with Oswald Mycone, and afterwards went to Wittenberg where he was appointed professor of mathematics in 1537. Being greatly attracted by the new Copernican theory, he resigned the professorship in 1539, and went to Frauenberg to associate himself with Copernicus (q.v.), and superintended the printing of the *De Orbium Revolutione* which he had persuaded Copernicus to complete. Rheticus now began his great treatise, *Opus Palatinum de Triangulis*, and continued to work at it while he occupied his old chair at Wittenberg, and indeed up to his death at Cassovia in Hungary, on the 4th of December 1576. The *Opus Palatinum* of Rheticus was published by Valentine Otho, mathematician to the electoral prince palatine, in 1596. It gives tables of sines and cosines, tangents, &c., for every 10 seconds, calculated to ten places. He had projected a table of the same kind to fifteen places, but did not live to complete it. The sine table, however, was afterwards published on this scale under the name of *Thesaurus*

Mathematicus (Frankfort, 1613) by B. Pitiscus (1561-1613), who himself carried the calculation of a few of the earlier sines to twenty-two places. He also published *Narratio de Libris Revolutionum Copernici* (Gedenum, 1540), which was subsequently added to editions of Copernicus's works; and *Ephemérides* until 1551, which were founded on the Copernican doctrines. He projected numerous other works, as is shown by a letter to Peter Ramus in 1568, which Adrian Romanus inserted in the preface to his *Idea of Mathematics*.

RHETORIC (Gr. *ῥητορικὴ τέχνη*, the art of the orator), the art of using language in such a way as to produce a desired impression upon the hearer or reader. The object is strictly persuasion rather than intellectual approval or conviction; hence the term, with its adjective "rhetorical," is commonly used for a speech or writing in which matter is subservient to form or display. So in grammar, a "rhetorical question" is one which is asked not for the purpose of obtaining an answer, but simply for dramatic effect. The power of eloquent speech is recognized in the earliest extant writings. Homer describes Achilles as a "speaker of words, as well as a doer of deeds": Nestor, Menelaus and Odysseus are all orators as well as statesmen and soldiers. Again the brilliant eloquence of Pericles is the theme of Aristophanes and Eupolis. Naturally the influence wielded by the great orators led to an investigation of the characteristics of successful rhetoric, and especially from the time of Aristotle the technique of the art ranked among the recognized branches of learning.

A lost work of Aristotle is quoted by Diogenes Laërtius (viii. 57) as saying that Empedocles "invented" (*εἰπέειν*) rhetoric; Zeno, dialectic (*i.e.* logic, the art of making a logical argument, apart from the style). This is certainly not to be understood as meaning that Empedocles composed the first "art" of rhetoric. It is rather to be explained by Aristotle's own remark, cited by Laërtius from another lost treatise, that Empedocles was "a master of expression and skilled in the use of metaphor"—qualities which may have found scope in his political oratory, when, after the fall of Thrasydades in 472 B.C., he opposed the restoration of a tyranny at Agrigentum. The founder of rhetoric as an art was Corax of Syracuse (c. 466 B.C.). In 466 a democracy was established in Syracuse. One of the immediate consequences was a mass of litigation on claims to property, urged by democratic exiles who had been dispossessed by Thrasylbulus, Hiero or Gelo. Such claims, going many years back, would often require that a complicated series of details should be stated and arranged. It would also, in many instances, lack documentary support, and rely chiefly on inferential reasoning. Hence the need of professional advice. The facts known as to the "art" of Corax perfectly agree with these conditions. He gave rules for arrangement, dividing the speech into five parts,—proem, narrative, arguments (*ἀγῶνες*), subsidiary remarks (*παρεμβασίς*) and peroration. Next he illustrated the topic of general probability (*εἰκός*), showing its two-edged use: e.g., if a puny man is accused of assaulting a stronger, he can say, "Is it likely that I should have attacked him?" If vice versa, the strong man can argue, "Is it likely that I should have committed an assault where the presumption was sure to be against me?" This topic of *εἰκός*, in its manifold forms, was in fact the great weapon of the earliest Greek rhetoric. It was further developed by Tisias, the pupil of Corax, as we see from Plato's *Phaedrus*, in an "art" of rhetoric which antiquity possessed, but of which we know little else. Aristotle gives the *εἰκός* a place among the topics of the fallacious enthymeme which he enumerates in *Rhet.* ii. 24, remarking that it was the very essence of the treatise of Corax; he points out the fallacy of omitting to distinguish between abstract and particular probability, quoting the verses of Agatho,—“Perhaps one might call this very thing a probability, that many improbable things will happen to men.” Gorgias (q.v.) of Leontini captivated the Athenians in 427 B.C. by his oratory (Diod. xii. 53), which, so far as we can judge, was

Early
Greek
rhetoric
—Corax.

The
topic
of *εἰκός*.

Tisias.

Gorgias.

characterized by florid antithesis, expressed in short jerky sentences. But he has no definite place in the development of rhetoric as a system. It is doubtful whether he left a written "art"; and his mode of teaching was based on learning prepared passages by heart,—diction (λέξις), not invention or arrangement, being his great object.

The first extant Greek author who combined the theory with the practice of rhetoric is the Athenian Antiphon (q.v.), the first of the Attic orators, and the earliest representative at Athens of a new profession created by the new art of rhetoric—that of the *λογογράφος*, the writer of forensic speeches for other men to speak in court. His speeches show the art of rhetoric in its transition from the technical to the practical stage, from the school to the law court and the assembly. The organic lines of the rhetorical pleader's thought stand out in bold relief, and we are enabled to form a clear notion of the logographer's method. We find a striking illustration of the fact that the topic of "probability" is the staple of this early forensic rhetoric. Viewed generally, the works of Antiphon are of great interest for the history of Attic prose, as marking how far it had then been influenced by a theory of style. The movement of Antiphon's prose has a certain grave dignity, "impressing by its weight and grandeur," as a Greek critic in the Augustan age says, "not charming by its life and flow." Verbal antithesis is used, not in a diffuse or florid way, but with a certain sledge-hammer force, as sometimes in the speeches of Thucydides. The imagery, too, though bold, is not florid. The structure of the periods is still crude; and the general effect of the whole, though often powerful and impressive, is somewhat rigid.

Antiphon represents what was afterwards named the "austere" or "rugged" style (*ἀντηρή ἀρμονία*), Lysias was the model of an artistic and versatile simplicity. But while Antiphon has a place in the history of rhetoric as an art, Lysias, with his more attractive gifts, belongs only to the history of oratory. Ancient writers quote an "art" of rhetoric by Isocrates, but its authenticity was questioned. It is certain, however, that Isocrates taught the art as such. He is said to have defined rhetoric "as the science of persuasion" (Sext. Empir. *Adv. Mathem.* ii. § 62, p. 301 seq.). Many of his particular precepts, both on arrangement and on diction, are cited, but they do not give a complete view of his method. The *φιλοσοφία* ("theory of culture") which Isocrates expounds in his discourses *Against the Sophists* and on the *Antidosis*, was in fact rhetoric applied to politics. First came technical expositions: the pupil was introduced to a list of artistic aids which compose composition employs (*τὰς ἰδέας ἀτάσας αἰς ὃ λόγος τυγχάνει χρώμενος*, *Antid.* § 183). The same term (*ἰδέαι*) is also used by Isocrates in a narrower sense, with reference to the "figures" of rhetoric, properly called *σχήματα* (*Panath.* § 2); sometimes, again, in a sense still more general, to the several branches or styles of literary composition (*Antid.* § 11). When the technical elements of the subject had been learned, the pupil was required to apply abstract rules in actual composition, and his essay was revised by the master. Isocrates was unquestionably successful in forming speakers and writers. His school was famous during a period of some fifty years (390 to 340 B.C.). Among the statesmen whom it trained were Timotheus, Leodamas of Acharnae, Lycurgus and Hyperides; among the philosophers or rhetoricians were Speusippus, Plato's successor in the Academy, and Isaeus; among the historians, Ephorus and Theopompus. Cicero and through him all subsequent oratory owed much to the ample prose of the Isocraean school.

In the person of Isocrates the art of rhetoric is thus thoroughly established, not merely as a technical method, but also as a practical discipline of life. If Plato's mildly ironical reference in the *Euthydemus* to a critic "on the borderland between philosophy and statesmanship" was meant, as is probable, for Isocrates, at least there was a wide difference between the measure of acceptance accorded to the earlier Sophists, such as Protagoras, and the influence which the school of Isocrates exerted through the men whom it had trained. Rhetoric had won its place in

education. It kept that place through varying fortunes to the fall of the Roman empire, and resumed it, for a while, at the revival of learning.

Plato in the *Gorgias* and the *Phaedrus* satirized the ordinary textbooks of rhetoric, and himself gave directions for a higher standard of work; but the detailed study of the art begins with Aristotle. Aristotle's *Rhetoric* belongs to the generation after Isocrates, having been composed (but see ARISTOTLE) between 330 and 322 B.C. As controversial allusions sometimes hint it holds Isocrates for one of the foremost exponents of the subject. From a purely literary point of view Aristotle's *Rhetoric* (with the partial exception of book iii.) is one of the driest works in the world. From the historical or scientific point of view it is one of the most interesting. If we would seize the true significance of the treatise it is better to compare rhetoric with grammar than with its obvious analogue, logic. A method of grammar was the conception of the Alexandrian age, which had lying before it the standard masterpieces of Greek literature, and deduced the "rules" of grammar from the actual practice of the best writers. Aristotle in the latter years of the 4th century B.C. held the same position relatively to the monuments of Greek oratory which the Alexandrian methodizers of grammar held relatively to Greek literature at large. Abundant material lay before him, illustrating how speakers had been able to persuade the reason or to move the feelings. He therefore sought thence to deduce rules and so construct a true art. Aristotle's practical purpose was undoubtedly real. If we are to make persuasive speakers, he believed, this is the only sound way to set about it. But the enduring interest of his *Rhetoric* is mainly retrospective. It attracts us as a feat in analysis by an acute mind—a feat highly characteristic of that mind itself, and at the same time strikingly illustrative of the field over which the materials have been gathered.

The *Rhetoric* is divided into three books. It deals in great detail with the minutiae of the rhetorical craft. Book I. discusses the nature and object of rhetoric. The means of persuasion (*πίστευσις*) are classified into the "artificial" (*ἰσχυραίαι*), the objects of which are external to the art, documents, laws, depositions,—and "artificial" (*ἰσχυραίαι*), the latter subdivided into logical (the popular syllogism or "enthymeme," the "example," &c.), ethical, and emotional. Aristotle next deals with the "topics" (*τόποι*), i.e. the commonplaces of rhetoric, general or particular arguments which the rhetorician must have ready for immediate use. Rhetoric is then broadly divided into:—(1) *deliberative* (*συμβουλευτική*), concerned with exhortation or dissuasion, and with future time, its end (*ἔσθός*) being the advantage or detriment of the persons addressed; (2) *forensic* (*δικαστική*), concerned with accusation and defence and with time past, its standard being justice; (3) *epideictic*, the ornamental rhetoric of display, concerned with praise and blame, usually with the present time, its standard being honour and shame. Each of these kinds is discussed, and the book ends with a brief analysis of the "inartificial proofs." In book II. Aristotle returns to the "artificial" proofs—those which rhetoric itself provides. The "logical" proof having been discussed in book I., he turns to the "ethical." He shows how the speaker may so indicate his own character and the goodness of his motive as to prepossess the audience in his favour, and proceeds to furnish materials to this end. The "emotional" proof is then discussed, and an analysis is given of the emotions on which the speaker may play. A consideration follows of the "universal commonplaces" (*κοινὰ τόποι*) which are suitable to all subjects. The book ends with an appendix dealing with the "example" (*παράδειγμα*), the general moral sentiments (*γνώμαι*) and the enthymeme. In book III. Aristotle considers expression (*μίξις*), including the art of delivery (*ὑπόκρισις*), and arrangement (*τάξις*). Composition, the use of prose rhythm, the periodic style (the "periodic" style, *κατεστραμμένη*), being contrasted with the "running" (*ἀφωρμή*) are all analysed, and the types of style literary (*ὑπόθεσις*) and oral (*ἑπιμαρτυρία*) are differentiated. Under "arrangement" he concludes with the parts of a speech, poem, narrative, proofs and epilogue.

It is necessary briefly to consider Aristotle's general view of rhetoric as set forth in book I. Rhetoric is properly an art. This is the proposition from which Aristotle sets out. It is so because when a speaker persuades, it is possible to find out why he succeeds in doing so. Rhetoric is, in fact, the popular branch of logic. Hitherto, Aristotle says, the essence of rhetoric has been neglected for the accidents. Writers on rhetoric have hitherto concerned themselves mainly with "the exciting or prejudicing of pity, of anger, and soul-like emotions of the soul." All this is very well, but "it has not gone to do with the matter in hand; it has regard

to the judge." The true aim should be to *prove* your point, or seem to prove it.

Here we may interpolate a comment which has a general bearing on Aristotle's *Rhetoric*. It is quite true that, if we start from the conception of rhetoric as a branch of logic, the phantom of logic in rhetoric claims precedence over appeals to passion. But Aristotle does not sufficiently regard the question—What, as a matter of experience, is most persuasive? Logic may be more persuasive with the more select hearers of rhetoric; but rhetoric is for the many, and with the many appeals to passion will sometimes, perhaps usually, be more effective than syllogism. No formulation of rhetoric can correspond with fact which does not leave it absolutely to the genius of the speaker whether reasoning (or its phantom) is to be what Aristotle calls it, the "body of proof" (*σώμα πείρας*), or whether the stress of persuading effort should not be rather addressed to the emotions of the hearers.

But we can entirely agree with Aristotle in his next remark, which is historical in its nature. The deliberative branch of rhetoric had hitherto been postponed, he observes, to the forensic. We have, in fact, already seen that the very origin of rhetoric in Hellas was forensic. The relative subordination of deliberative rhetoric, however unscientific, had thus been human. Aristotle's next statement, that the master of logic will be the master of rhetoric, is a truism if we concede the essential primacy of the logical element in rhetoric. Otherwise it is a paradox; and it is not in accord with experience, which teaches that speakers incapable of showing even the ghost of an argument have sometimes been the most completely successful in carrying great audiences along with them. Aristotle never assumes that the hearers of his rhetorician are as *οὐλοῖες*, the cultivated few; on the other hand, he is apt to assume tacitly—and here his individual bent comes out—that these hearers are not the great surging crowd, the *ὄχλος*, but a body of persons with a decided, though imperfectly developed, preference for sound logic.

What is the use of an art of rhetoric? It is fourfold, Aristotle replies. Rhetoric is useful, first of all, because truth and justice are naturally stronger than their opposites. When awards are not duly given, truth and justice must have been worsted by their own fault. This is worth correcting.

Rhetoric is then (1) *corrective*. Next, it is (2) *instructive*, as a popular vehicle of persuasion for persons who could not be reached by the severer methods of strict logic. Then it is (3) *suggestive*. Logic and rhetoric are the two impartial arts; that is to say, it is a matter of indifference to them, as arts, whether the conclusion which they draw in any given case is affirmative or negative. Suppose that I am going to plead a cause, and have a sincere conviction that I am on the right side. The art of rhetoric will suggest to me what might be urged on the other side; and this will give me a stronger grasp of the whole situation. Lastly, rhetoric is (4) *defensive*. Mental effort is more distinctive of man than bodily effort; and "it would be absurd that, while incapacity for physical self-defence is a reproach, incapacity for mental defence should be no reproach." Rhetoric, then, is corrective, instructive, suggestive, defensive. But what if it be urged that this art may be abused? The objection, Aristotle answers, applies to all good things, except virtue, and especially to the most useful things. Men may abuse strength, health, wealth, generalship.

The function of the medical art is not necessarily to cure, but to make such progress towards a cure as each case may admit. Similarly it would be inaccurate to say that the function of rhetoric is to persuade. Rather must rhetoric be defined as "the faculty of discerning in every case the available means of persuasion." Suppose that among these means of persuasion is some process of reasoning which the rhetorician himself knows to be unsound. That belongs to the province of rhetoric all the same. In relation to logic, a man is called a "sophist" with regard to his moral purpose (*σπουδαίως*), i. e. if he knowingly used a fallacious syllogism. But rhetoric takes no account of the moral purpose. It takes account simply of the faculty (*δύναμις*)—the faculty of discovering any means of persuasion.

Aristotle's *Rhetoric* is incomparably the most scientific work which exists on the subject. It may also be regarded as having determined the main lines on which the subject was treated by nearly all subsequent writers. The extant treatise on rhetoric (also by Aristotle?) entitled "Ῥητορικὴ πρὸς Ἀλέξανδρον," formerly ascribed to Anaximenes of Lampsacus, was written at latest by 340 B.C. The introductory letter prefixed to it is probably a late forgery. Its relation towards Aristotle's *Rhetoric* is discussed in the article on ARISTOTLE.

During the three centuries from the age of Alexander to that of Augustus the fortunes of rhetoric were governed by the new conditions of Hellenism. Aristotle's scientific method lived on in the Peripatetic school. Meanwhile the fashion of florid declamation or strained conceits prevailed in the rhetorical schools of Asia, where, amid mixed populations, the pure traditions of the best Greek taste had been dissociated from the use of the Greek language. The "Asianism" of style which thus came to be constricted with "Atticism" found imitators at Rome, among whom must be reckoned the orator Hortensius (c. 95 B.C.). Hermagoras of Temnos in Aeolis (c. 110 B.C.) claims mention as having done much to revive a higher conception. Using both the practical rhetoric of the time before Aristotle and Aristotle's philosophical rhetoric, he worked up the results of both in a new system,—following the philosophers so far as to give the chief prominence to "invention." He thus became the founder of a rhetoric which may be distinguished as the scholastic. Through the influence of his school, Hermagoras did for Roman eloquence very much what Isocrates had done for Athens. Above all, he counteracted the view of "Asianism," that oratory is a mere knack founded on practice, and recalled attention to the study of it as an art.¹

Cicero's rhetorical works are to some extent based on the technical system to which he had been introduced by Molon at Rhodes. But Cicero further made an independent use of the best among the earlier Greek writers, Isocrates, Aristotle and Theophrastus. Lastly, he could draw, at least in the later of his treatises, on a vast fund of reflection and experience. Indeed, the distinctive interest of his contributions to the theory of rhetoric consists in the fact that his theory can be compared with his practice. The result of such a comparison is certainly to suggest how much less he owed to his art than to his genius. Some consciousness of this is perhaps implied in the idea which pervades much of his writing on oratory, that the perfect orator is the perfect man. The same thought is present to Quintilian, in whose great work, *De Institutione Oratoria*, the scholastic rhetoric receives its most complete expression (c. A.D. 90).

Quintilian treats oratory as the end to which the entire mental and moral development of the student is to be directed. Thus he devotes his first book to an early discipline which should precede the orator's first studies, and his last book to a discipline of the whole man which lies beyond them. Some notion of his comprehensive method may be derived from the circumstance that he introduces a succinct estimate of the chief Greek and Roman authors, of every kind, from Homer to Seneca (bk. x. §§ 46-131). After Quintilian, the next important name is that of Hermogenes of Tarsus, who under Marcus Aurelius made a complete digest of the scholastic rhetoric from the time of Hermagoras of Temnos (110 B.C.). It is contained in five extant treatises, which are remarkable for clearness and acuteness, and still more remarkable as having been completed before the age of twenty-five. Hermogenes continued for nearly a century and a half to be one of the chief authorities in the schools. Longinus (c. A.D. 260) published an *Art of Rhetoric* which is still extant; and the more celebrated treatise *On Sublimity* (*περὶ ὑψους*), if not his work, is at least of the same period. In the latter half of the 4th century Aphthonius (q.v.) composed the "exercises" (*προγυμνάσματα*) which superseded the work of

¹ See Jebb's *Attic Orators*, ii. 445.

The
Rhet-
oric 'to
Alex-
ander.'

The
period
from
Alex-
ander
to
August-
us.

Herm-
ago-
ras.

Cicero.

Quin-
tilian.

Hermo-
genes.

Other
writers.

Hermogenes. At the revival of letters the treatise of Aphononius more became a standard text-book. Much popularity was enjoyed also by the exercises of Aelius Theon (of uncertain date; see THEON). (See further the editions of the *Rhetores Graeci* by L. Spengel and by Ch. Walz.)

During the first four centuries of the empire the practice of the art was in greater vogue than ever before or since. First, there was a general dearth of the higher intellectual interests: politics gave no scope to energy; philosophy was stagnant, and literature, as a rule, either arid or frivolous. Then the Greek schools had poured their rhetoricians into Rome, where the same tastes which revelled in coarse luxury welcomed tawdry declamation. The law-courts of the Roman provinces further created a continual demand for forensic speaking. The public teacher of rhetoric was called "sophist," which was now an academic title, similar to "professor" or "doctor."

In the 4th century B.C. Isocrates had taken pride in the name of *σοφιστής*, which, indeed, had at no time wholly lost the good, or neutral, sense which originally belonged to it. The academic meaning which it acquired under the early empire lasted into the middle ages (see Du Cange, s.v., who quotes from Baldricus, "Egregius Doctor magnusque Sophista Geraldus"). While the word *rhetor* still denoted the faculty, the word *sophistes* denoted the office or rank to which the rhetor might hope to rise. So Lucian ("Teacher of Rhetoricians," § 1) says: "You ask, young man, how you are to become a rhetor, and attain in your turn to the repute of that most impressive and illustrious title, sophist." Lucian also satirizes the discussions of the nature of rhetoric in his parody the *Parasite* (cf. also his *Bis Accusatus*).

Vespasian (70-79 A.D.), according to Suetonius, was the first emperor who gave a public endowment to the teaching of rhetoric. Under Hadrian and the Antonines (A.D. 117-180)

the public chairs of rhetoric became objects of the highest ambition. The complete constitution of the schools at Athens was due to Marcus Aurelius. The Philosophical school had four chairs (*θρόνοι*)—Platonic, Stoic, Peripatetic, Epicurean. The Rhetorical school had two chairs, one for "sophistic," the other for "political" rhetoric. By "sophistic" was meant the academic teaching of rhetoric as an art, in distinction from its "political" application to the law-courts. The "sophistical" chair was superior to the "political" in dignity as in emolument, and its occupant was invested with a jurisdiction over the youth of Athens similar to that of the vice-chancellor in a modern university. The Antonines further encouraged rhetoric by granting immunities to its teachers. Three "sophists" in each of the smaller towns, and five in the larger, were exempted from taxation (*Dig.* xxvii. 1, 6, § 2). The wealthier sophists affected much personal splendour. Polemon (c. A.D. 130) and Adrian of Tyre (c. A.D. 170) are famous examples of extravagant display. The aim of the sophist was to impress the multitude. His whole stock-in-trade was style, and this was directed to astonishing by *lours de force*. The scholastic declamations were chiefly of two classes. (1) The *suasoriae* were usually on historical or legendary subjects, in which some course of action was commended or censured (cf. *Juv. Sat.*). These *suasoriae* belonged to deliberative rhetoric (the *βουλευτικὸν γένος, deliberativum genus*). (2) The *controversiae* turned especially on legal issues, and represented the forensic rhetoric (*δικαιτικὸν γένος, judiciale genus*). But it was the general characteristic of this period that all subjects, though formally "deliberative" or "forensic," were treated in the style and spirit of that third branch which Aristotle distinguished, the rhetoric of *ἐπίδειξις* or "display." The oratory produced by the age of the academic sophists can be estimated from a large extant literature. It is shown under various aspects, and presumably at its best, by such writers as Dio Chrysostom at the end of the 1st century, Aelius Aristides (see ARISTIDES, AELIUS) in the 2nd, the chief rhetorician under the Antonines, Themistius, Himerius and Libanius in the 4th. Amid much which is

tawdry or vapid, these writings occasionally present passages of true literary beauty, while they constantly offer matter of the highest interest to the student.

In the medieval system of academic studies, grammar, logic and rhetoric were the subjects of the trivium, or course followed during the four years of undergraduateship. Music, arithmetic, geometry and astronomy constituted the quadrivium, or course for the three years from the B.A. to the M.A. degree. These were the seven liberal arts. In the middle ages the chief authorities on rhetoric were the latest Latin epitomists, such as Martianus Capella (5th cent.), Cassiodorus (5th cent.) or Isidorus (7th cent.).

After the revival of learning the better Roman and Greek writers gradually returned into use. Some new treatises were also produced. Leonard Cox (d. 1549) wrote *The Art or Craft of Rhetorike*, partly compiled, partly original, which was reprinted in Latin at Cracow. *The Art of Rhetorique*, by Thomas Wilson (1553), afterwards secretary of state, embodied rules chiefly from Aristotle, with help from Cicero and Quintilian. About the same time treatises on rhetoric were published in France by Tonquelin (1555) and Courcelles (1557). The general aim at this period was to revive and popularize the best teaching of the ancients on rhetoric. The subject was regularly taught at the universities, and was indeed important.

At Cambridge in 1570 the study of rhetoric was based on Quintilian, Hermogenes and the speeches of Cicero viewed as works of art. An Oxford statute of 1588 shows that the same books were used there. In 1620 George Herbert was delivering lectures on rhetoric at Cambridge, where he held the office of public orator. The decay of rhetoric as a formal study at the universities set in during the 18th century. The function of the rhetoric lecturer passed over into that of correcting written themes; but his title remained long after his office had lost its primary meaning. If the theory of rhetoric fell into neglect, the practice, however, was encouraged by the public exercises ("acts" and "opponencies") in the schools. The college prizes for "declamations" served the same purpose.

The fortunes of rhetoric in the modern world, as briefly sketched above, may suffice to suggest why few modern writers of ability have given their attention to the subject. Perhaps one of the most notable modern contributions towards the art is the collection of commonplaces framed (in Latin) by Bacon, "to be so many spools from which the threads can be drawn out as occasion serves," a truly curious work of that acute and fertile mind. He called them "Antitheta." A specimen is subjoined:—

UXOR ET LIBERI

<p>For.</p> <p>"Attachment to the state begins from the family."</p> <p>"Wife and children are a discipline in humanity. Bachelors are morose and austere."</p> <p>"The only advantage of celibacy and childlessness is in case of exile."</p>	<p>Against.</p> <p>"He who marries, and has children, has given hostages to fortune."</p> <p>"The immortality of brutes is in their progeny; of men, in their fame, services, and institutions."</p> <p>"Regard for the family too often overrides regard for the state."</p>
--	---

This is quite in the spirit of Aristotle's treatise. The popularity enjoyed by Blair's *Rhetoric* in the latter part of the 18th and the earlier part of the 19th century was merited rather by the form than by the matter. Campbell's *Philosophy of Rhetoric*, which found less wide acceptance than its predecessor, was superior to it in depth, though often marred by an imperfect comprehension of logic. But undoubtedly the best modern book on the subject is Whately's *Elements of Rhetoric*. Starting from Aristotle's view, that rhetoric is "an offshoot from logic," Whately treats it as the art of "argumentative composition." He considers it under four heads: (1) the address to the understanding (= Aristotle's *λογικὴ ρητορική*); (2) the address to the will, or persuasion (= Aristotle's *ῥητορική* and

παθητικῆ πύοσις; (3) style; (4) elocution, or delivery. But when it is thus urged that—

“All a rhetorician’s rules
But teach him how to name his tools,”

the assumption is tacitly made that an accurate nomenclature and classification of these tools must be devoid of practical use. The conditions of modern life, and especially the invention of printing, have to some extent diminished the importance which belonged in antiquity to the art of speaking, though modern democratic politics and forensic conditions still make it one which may be cultivated with advantage.

Among more modern works are J. Bascom, *Philosophy of Rhetoric* (New York, 1885); and numerous books on voice culture, gesture and elocution. For ancient rhetoric see Sir R. C. Jebb’s translation of Aristotle’s *Rhetoric* (ed. J. E. Sandys, 1909), and his *Attic Orators* (1876); also Spengel, *Artium Scriptores* (1828); Westermann, *Gesch. der Beredsamkeit* (1833–35); Cope, in the *Cambridge Journal of Classical and Sacred Philology* (1855–57); introductions to Cicero’s *De Oratore* (A. S. Wilkins) and *Orator* (J. E. Sandys); Volkemann, *Die Rhetorik der Griechen und Römer in system. Übersicht* (ed. 2, 1885). (R. C. J.; X.)

RHEUMATISM (from Gr. *ῥέυμα*, flux), a general term for various forms of disease, now subdivided more accurately under separate names.

ACUTE RHEUMATISM or RHEUMATIC FEVER is the name given to a disease having for its chief characteristics inflammatory affections of the joints, attended by severe constitutional disturbances and frequently associated with inflammation of the pericardium and valves of the heart. The acute rheumatism of childhood differs materially from that of adults in that the articular manifestations and constitutional disturbance are usually much less severe, whereas the heart and pericardium are especially liable to be attacked. It will be advisable, therefore, in discussing the symptoms, to deal separately with the rheumatism of adults and that of childhood. There are certain points of importance in connexion with its causation which are generally agreed upon. It is essentially a disease of childhood and early adult life, being most commonly met with between the ages of ten and twenty-five and comparatively rarely after forty. Heredity is unquestionably an important predisposing cause. Climate is also a factor of considerable importance, cold and damp with sudden and wide fluctuations of temperature being especially conducive to an attack. While perhaps more common in Great Britain than elsewhere, it is met with in most parts of the globe. Exposure to cold and wet, and especially a chill after free perspiration and fatigue, are among the most common exciting causes of an attack.

Of recent years much evidence has accumulated tending to show that rheumatism is a specific infective disease due to a micro-organism, and this is now generally recognized. There is still, however, some difference of opinion as to the nature of the micro-organism by which it is produced. In 1900 F. J. Poynton and Paine isolated from eight cases of acute rheumatism in children a minute diplococcus similar to that previously described by Triboulet and by A. Wasserman, which inoculated into rabbits produced lesions of the joints and of the heart indistinguishable from those met with in acute rheumatism. They have since obtained the same micro-organism from a further large number of cases of acute rheumatism, and their results have been confirmed by Walker, Beattie and others. They therefore claim that this micro-organism, to which they have given the name *Diplococcus rheumaticus*, is the specific cause of acute rheumatism. The objections which have been raised by other competent observers against this view are: (1) That this diplococcus is not found in all cases of acute rheumatism. (2) That certain other micro-organisms when inoculated into animals will produce joint and heart affections similar to those produced by the aforesaid *Diplococcus rheumaticus*. It would be out of place here to enter into the merits of this controversy; suffice it to say that the objections raised do not appear to be cogent enough to invalidate the conclusions arrived at by the authors of the germ theory. The matter is, however, still to a certain extent *sub judice*.

In adults the affection of the joints is the most striking feature. The attack is usually ushered in by a feeling of chilliness or malaise, with pain or stiffness in one or more joints, generally those of large or medium size, such as the knees, ankles, wrists or shoulders. At first the pain is confined to one or two joints, but others soon become affected, and there is a tendency to symmetry in the order in which they are attacked, the inflammation in one joint being followed by that of the same joint on the opposite side. The affected joints are swollen, hot and excessively tender, and the skin over them is somewhat flushed. The temperature is raised, ranging from about 101° to 103° F., the pulse rapid, full and soft; the face is flushed, the tongue coated with a thick white fur, and there is thirst, loss of appetite, and constipation. The body is bathed in a profuse perspiration, which has a characteristic sour, disagreeable odour. The urine is diminished, acid and loaded with urates. The attack is of variable duration, and may pass off in a few days or last for some weeks. Relapses are not uncommon when convalescence appears to have been established. Among the complications which may arise are hyperpyrexia, or rapid and extreme rise of temperature, which may run up as high as 110° F., when death will speedily ensue unless prompt and energetic treatment by cold baths or icepacks is resorted to. Affections of the heart, pericarditis (inflammation of the fibro-serous sac investing the heart) and endocarditis (inflammation of the lining membrane and the valves of the heart), which are so frequently associated with rheumatism, should be regarded as part of the disease, rather than as complications of rheumatism. They are far more common in children than in adults, and it is the damage to the valves of the heart in children by rheumatism which lays the foundation of much chronic heart disease in later life.

In childhood the affection of the joints is usually slight, and may be confined to a little pain or stiffness in one or two joints, and is sometimes attributed by parents to “growing pains.” The constitutional symptoms are also ill-marked and there are no acid sweats, the temperature is not as a rule very high, the tongue not heavily coated, and the child does not appear to be very ill. The heart and pericardium are, however, especially liable to attack, and this may be so insidious in its onset that attention is not called to it till considerable damage has been done to the heart. It is of importance, therefore, that in children the heart should be frequently examined by a physician, when there is the slightest suspicion of an attack of rheumatism. *Chorea* or St Vitus’s dance is a common manifestation of rheumatism in children. *Subcutaneous fibrous nodules*, attached to tendons or fibrous structures beneath the skin, are a special feature of the rheumatism of childhood. They are painless, and vary in size from one-eighth to half an inch in diameter. They are not very common, but when present indicate that the rheumatism has a firm hold and that cardiac complications are to be apprehended.

The patient should be placed in bed between blankets, and should wear a light flannel or woollen shirt. The affected joints should be kept at rest as far as possible, and enveloped in cotton-wool. Salicylate of soda or salicin, first suggested by Dr Maclagan in 1876, appear to exercise a specific influence in acute rheumatism. They have a powerful effect not only in reducing the temperature, but in relieving the pain and cutting short the attack. Frequent and fairly large doses of salicylate of soda should be administered for the first twenty-four hours: the dose and interval at which it is given should then be gradually reduced till the symptoms subside. In conjunction with this, alkalies such as bicarbonate or citrate of potash should also be administered. The effect of the salicylate should be carefully watched, and the dose reduced if toxic symptoms such as delirium, deafness, and noises in the ears occur. These drugs are of less service in the rheumatism of children than in that of adults, as they do not appear to exercise any specific influence in arresting the cardiac inflammation to which children are specially liable, though they have a marked effect on the joint affections. Aspirin has

Symptoms.

Treatment.

recently come into use as a substitute for salicylates, and may succeed when salicylates fail.

Subacute rheumatism.—This term is sometimes applied to attacks of the disease of a less severe type in which the symptoms, though milder in character, are usually of longer duration and more intractable than in the acute form. It is difficult, however, to draw a hard-and-fast line between the two, but the term may perhaps be most appropriately applied to the repeated and protracted attacks of cardiac rheumatism in children.

CHRONIC RHEUMATISM.—This term has been somewhat loosely applied to various chronic joint affections, sometimes of gouty origin or the result of rheumatoid arthritis. Strictly speaking, it may be applied to cases in which the joint lesions persist after an attack of rheumatism, and chronic inflammatory thickening of the tissues takes place, so that they become stiff and deformed. It is also appropriate to certain joint affections occurring in later life in rheumatic subjects, who are liable to repeated attacks of pain and stiffness in the joints, usually induced by exposure to cold and wet. This form of rheumatism is less migratory than the acute, and is commonly limited to one or two of the larger joints. After repeated attacks the affected joints may become permanently stiff and painful, and crackling or creaking may occur on movement. There is seldom any constitutional disturbance, and the heart is not liable to be affected.

MUSCULAR RHEUMATISM.—By this is understood a painful affection of certain groups of muscles attributable to inflammation of their fibrous and tendinous attachments. It is commonly brought on by exposure to cold and wet, and especially by a chill after violent exercise and free perspiration when the clothes are not changed. Any movement of the affected muscles gives rise to severe and sharp pain which may induce a certain degree of spasm and rigidity at the time. The pain usually subsides and passes off completely while the patient is at rest, but occurs on the slightest movement of the affected muscles.

The chief varieties of muscular rheumatism are:—

1. Lumbago, in which the muscles of the lower part of the back are affected so that stooping, particularly the attempt to rise again to the erect position, induces severe pain.
2. Intercostal rheumatism, affecting the muscles between the ribs, so that taking a deep breath and certain movements of the arms give rise to pain.
3. Torticollis or stiff neck, affecting the muscles of one side of the neck.

Treatment.—Salicylates, which are of service in acute rheumatism, are not so reliable in the chronic varieties, but are sometimes of service. Aspirin, salicin, quinine and iodide of potassium may be more successful, but other active treatment is usually required. The application of heat in the form of poultices or fomentations, counter irritation by mustard leaves or blisters, are indicated in some cases. In others massage, hot douches, or electricity may be required. Mineral waters and baths of various health resorts are often of great benefit in obstinate cases, such as those of Buxton, Bath, Harrogate, Woodhall Spa, &c., in England, or of Aix-les-Bains, Wiesbaden, Wildbad, &c., and many others on the continent of Europe. Wintering abroad in warm, dry and sunny climates may be advisable in some cases when this is practicable.

(J. F. H. B.)

RHEUMATOID ARTHRITIS (OSTEO-ARTHRITIS, ARTHRITIS DEFORMANS), terms employed to designate a disease or group of diseases characterized by destructive changes in the joints. Though it is only in comparatively recent times that the disease was definitely recognized as separate clinically from either rheumatism or gout, it is certain that it prevailed in ancient times. Characteristic changes in the bones have been found in remains in tombs in Egypt attributed by Petrie to 1300 B.C., and ancient Roman as well as British graves have held bones showing distinct traces of the diseases. Of early medical writers, Paulus Aeginata observed the lesions and seemed to

consider them distinctive. Landré Beauvais in 1800 published a description of the disease under the title of *Goutte asthenique primitif*. The first endeavour, however, to separate rheumatoid arthritis as a distinct disease was made by William Heberden in 1803; while in 1805 John Haygarth recognized the difference between it and rheumatism, and suggested the term "nodosity of the joints." A wide divergence of opinion during the 19th century as to its relation to rheumatism and to gout gave rise to the unfortunate term "rheumatic gout." The name *arthritis deformans* was suggested by Virchow in 1859. Various causes, such as nervous origin, inherited arthritic diathesis, a relationship to rheumatism or gout, and reflex irritation, have been put forward as giving rise to the disease, but in the present state of medical knowledge two are most favoured. The first ascribes the disease to an infective process arising from micro-organisms. Several observers have found bacteria in the synovial fluid and membranes of affected joints.—Max Schüller finding both bacilli and cocci, while in 1896 Gilbert Bannatyne, Wohlmann and Blaxall isolated a micro-organism, a bacillus with a bipolar staining, which they stated to be almost constantly present in the joints of patients with true rheumatoid arthritis. The second view is that the disease is the result of a chronic toxæmia produced by absorption of toxins from the intestine, with perhaps some error in metabolism. In many cases there seems to be a distinct evidence of a local infection, injury being a determining factor, and some families seem to have joints which are specially liable to degeneration. The disease may begin at any age, for there is no doubt that persistent cases have been met with in quite young children; but it usually begins in early middle-age, and statistics seem to confirm the impression of the greater liability of females. Conditions which tend to lower the general health seem to act as a predisposing cause to rheumatoid arthritis, e.g. mental worry, uterine disorders and various lowering diseases, prominent among which are influenza and tonsillitis. In a number of cases in women the onset occurs about the time of the menopause.

The method of onset varies according to the form. There are four well-marked types—(1) the peri-articular form, in which the most marked changes are in the synovial membrane and peri-articular tissues, and the cartilage may be involved to a lesser degree. In this variety is found every grade of severity. The onset may be acute, resembling an attack of rheumatic fever, for which it may be mistaken; the joints, one or more, are swollen, tender and painful to the touch; the temperature elevated to 100°; 101°; but unlike rheumatic fever, sweating and hyperpyrexia are uncommon. The acute stage may then subside, a slight thickening remaining in the capsule of the joint, and the contours of the limb scarcely regaining the normal; or the attack may gradually develop into the chronic form. The pain varies greatly, and is not necessarily in ratio to the amount of arthritis present. Various joints may be involved, the spinal vertebrae not infrequently sharing in an arthritis; the most usual joints to be attacked, however, are the knee and shoulder. When the knee is attacked there is commonly effusion into the joint. Muscular atrophy is usually present, but varies greatly in its extent. In most cases it is present to a much greater degree than can be accounted for by disuse of the muscles. The skin has in these cases a curious glossy appearance, and pigmentations may be noticed. In chronic forms the onset is gradual, one joint becoming painful and swelling, and then the others successively; in these slow forms the outlook for the recovery of the joint is not so good as in the acute, and some cases may proceed to extreme deformity with little or no pain. Gradually the shape of the joint is altered; this is in a great measure due to synovial thickening, and partly to the presence of osteophytes in the joint. When the affected joint is moved a distinct crepitation can be felt. The muscles about the joint atrophy often to an extreme degree, and contractures supervene, flexing the leg upon the thigh if the knees should be affected, and the thigh upon the abdomen should the hip be affected. In extreme degrees the patient may become a complete cripple. Later, in many cases a quiescent stage of the

disease is reached, the patients cease to suffer pain, and are inconvenienced only by the deformities in the limbs, in which a considerable degree of motion may be retained. Remarkable deformities are seen in hands in which a considerable amount of usefulness still remains. Dyspepsia and anaemia are frequently associated with arthritis. Monarticular arthritis more particularly affects the aged; and when it affects the hip is known as *rheum cocxae senilis*.

(2) The atrophic form of arthritis is not very common. The chief anatomical change is due to atrophy in the bone and cartilage. The disease occurs at an earlier period in life than the peri-articular form, from which the initial symptoms do not markedly differ; but the disorganization in the joint is greater, dislocations frequently occur, and ankylosis of the joints follows. This is the most serious form of arthritis.

(3) In the hypertrophic form the anatomical changes include the formation of new bone as well as changes in the cartilage. This new-bone formation may lead to progressive ankylosis in the joints. Should the vertebral column be affected a rigid condition of the spine known as *spondylitis deformans* ("poker back") may ensue. What are termed "Heberden's nodes" are small hard knobs about the size of a pea frequently found upon the fingers near the terminal phalangeal joints; they rarely give rise to symptoms. Popularly ascribed to gout, these nodes are in reality a manifestation of arthritis.

(4) A variety of arthritis occurring in children is known as Still's disease; in which the swelling of the joints is associated with swelling of the lymph glands and of the spleen. The onset is often acute, with fever and rigors; sweating is profuse and the joints are enlarged and painful. There may be much muscular wasting and limitation of movement in the joints, and anaemia is associated with the disease.

The treatment of rheumatoid arthritis is rarely curative, once the disease has been permanently established; and it is therefore important to begin treatment before destructive changes have taken place in the joints. In the acute febrile form, which is frequently taken for rheumatism, the essential treatment is rest to the affected joints, with the application of oil of wintergreen; the joint should not be fixed but supported. In the more chronic forms medicinal treatments are usually of little value. Potassium iodide is useful in some cases by promoting absorption of the hypertrophied fibrous tissue, and guaiacol if administered for a sufficiently long time is said to be capable of arresting the disease, diminishing the size of the joint and helping movement. Where anaemia accompanies the disease iron and arsenic are of value. The general health of a patient suffering from rheumatoid arthritis must be maintained, and he should live upon a dry soil. Visits to Aix-les-Bains, Buxton, Bath or Droitwich, with their baths and shampoos, often prove useful, particularly when combined with gentle massage. It is a mistake to keep the joints entirely at rest in the chronic forms, as this tends to the formation of contractures and ankylosis. Moderate exercise without undue fatigue is desirable. Patients should go early to bed and have plenty of rest, sunshine and fresh air. It is important that the diet should be nourishing and plentiful, and should there be intestinal putrefaction fermented milk is useful. As regards the local treatment, it will be well in the majority of cases to determine by the X-rays the exact state of the affected joints. Radiant heat, vibration and hot-air baths are among the best treatments. The active hyperaemia induced by hot air favours restoration of movement and alleviates pain, but where there is pronounced destruction of bone and cartilage full restoration of a joint cannot take place. Systematic exercises of the joints tend to prevent the atrophy of the adjacent muscles, and Bier's passive hyperaemia induced by the temporary use of an elastic bandage has the same results. Should an X-ray photograph reveal the presence of spurs or loose bodies in the joints interfering with free movement their removal is called for. Sometimes the breaking down of adhesions under an anaesthetic is necessary, and gentle passive and later active movements of the joints should follow if freedom of use is to be gained. Recently

treatment by radium has taken a definite place in the therapeutics of chronic arthritis, its analgesic properties seeming of great benefit. (H. L. H.)

RHEYDT, a town of Germany, in the Prussian Rhine province, situated on the Niers, 19 m. W. of Düsseldorf, on the main line of railway to Aix-la-Chapelle, and at the junction of lines to Crefeld and Stolberg. Pop. (1905) 40,149. It has two Roman Catholic and two Evangelical churches, a handsome new town hall (1895), a gymnasium, and several technical schools. The principal products of its numerous factories are silk, cotton, woollen and mixed fabrics, velvet, iron goods, machinery, shoes, cables, soap and cigars. Dyeing and finishing, brewing and distilling, are also carried on. Rheydt is an ancient place, but its industrial importance is of very recent growth, and it only received municipal rights in 1856.

See *Rheyter Chronik. Geschichte der Herrschaft und Stadt Rheydt* (2 vols., Rheydt, 1897); and Strauss, *Geschichte der Stadt Rheydt* (Rheydt, 1897).

RHIANUS, Greek poet and grammarian, a native of Crete, friend and contemporary of Eratosthenes (275-195 B.C.). Suidas says he was at first a slave and overseer of a palaestra, but obtained a good education later in life, and devoted himself to grammatical studies, probably in Alexandria. He prepared a new recension of the *Iliad* and *Odyssey*, characterized by sound judgment and poetical taste. His bold aeteses are frequently mentioned in the scholia. He also wrote epigrams, eleven of which, preserved in the Greek anthology and Athenaeus, show elegance and vivacity. But he was chiefly known as a writer of epics (mythological and ethnographical), the most celebrated of which was the *Messeniac* in six books, dealing with the second Messenian war and the exploits of its central figure Aristomenes, and used by Pausanias in his fourth book as a trustworthy authority. Other similar poems were the *Achaica*, *Eliaca*, and *Thessalica*. The *Heracleia* was a long mythological epic, probably an imitation of the poem of the same name by Panyasis, and containing the same number of books (fourteen).

Fragments in A. Meineke, *Analecta Alexandrina* (1843); for Rhianus's work in connexion with Homer, see C. Mayhoff, *De Rhiani Studii Homericis* (Dresden, 1870); also W. Christ, *Geschichte der griechischen Literatur* (1898).

RHIGAS, CONSTANTINE, known as Rhigas of Velestinos (Pherae), or Rhigas Pheraios (1760-1798), Greek patriot and poet, was born at Velestinos, and was educated at Zagora and at Constantinople, where he became secretary to Alexander Ypsilanti. In 1786 he entered the service of Nicholas Mavrogenes, hospodar of Wallachia, at Bucharest, and when war broke out between Turkey and Russia in 1787 he was charged with the inspection of the troops at Craiova. Here he entered into close and friendly relations with a Turkish officer named Osman Passavan-Oglou (1758-1807), afterwards the famous governor of Widin, whose life he saved from the vengeance of Mavrogenes. After the death of his patron Rhigas returned to Bucharest to serve for some time as interpreter at the French Consulate. At this time he wrote the famous Greek version of the *Marseillaise*, well known in Byron's paraphrase as "sons of the Greeks, arise." He was the founder of the Hetaireia, a society formed to organize Greek patriotic sentiment and to provide the Greeks with arms and money. Believing that the influence of the French Revolution would spread to the Near East, he betook himself to Vienna to organize the movement among the exiled Greeks and their foreign supporters in 1793, or possibly earlier. He published in Vienna many Greek translations of foreign works, and presently founded a Greek press there, but his chief glory was the collection of national songs which, passed from hand to hand in MS., roused patriotic enthusiasm throughout Greece. They were only printed posthumously at Jassy in 1814. While at Vienna Rhigas entered into communication with Bonaparte, to whom he sent a snuff-box made of the root of a laurel tree taken from the temple of Apollo, and eventually he set out with a view to meeting the general of the army of Italy in Venice. But before leaving Vienna he forwarded papers, amongst which is said to have been his correspondence

with Bonaparte, to a compatriot at Istria. The papers were betrayed by Demetrios Oikonomos Kozanites into the hands of the Austrian government, and Rhigas was arrested at Trieste and handed over with his accomplices to the Turkish authorities at Belgrade. Immediately on arrest he attempted suicide. His Turkish friend, Passvan-Oglou, sought to secure his escape, and the government apparently consented to release him on the payment of a ransom of about £6000; but meanwhile the Turkish pasha commanding at Belgrade had taken the law into his own hands. Rhigas's five companions were secretly drowned, but he himself offered so violent a resistance that he was shot by two Turkish soldiers. His last words are reported as being: "I have sown a rich seed; the hour is coming when my country will reap its glorious fruits." Rhigas, writing in the popular dialect instead of in classical Greek, aroused the patriotic fervour of his contemporaries and his poems were a serious factor in the awakening of modern Greece.

See Rizos Nérofilos, *Histoire de la révolution grecque* (Paris, 1829); I. C. Balaachi, *Hommes illustres de la Grèce moderne* (Paris, 1875); and Mrs E. M. Edmonds, *Rhigas Pheraios* (London, 1890).

RHINE (Lat. *Rhenus*, Ger. *Rhein*, Fr. *Rhin*, Dutch *Rhyn*, or *Rijn*), the chief river of Germany and one of the most important in Europe. It is about 850 m. in length and drains an area of 75,000 sq. m. The distance in a direct line between its source in the Alps and its mouth in the German Ocean is 460 m. Its general course is north-west-west, but it makes numerous deflexions and at one point is found running in a diametrically opposite direction. The name Rhine, which is apparently of Celtic origin, is of uncertain etymology, the most favoured derivations being either from *der Rinnende* (the flowing), or from *Rein* (the clear), the latter being now the more generally accepted.

1. *The Swiss Portion*.—The Rhine rises in the mountains of the Swiss canton of the Grisons, and flows for 233 m. in Swiss territory, within which its drainage basin includes about 14,050 sq. m., and every canton save Geneva. The two main branches of the Rhine, the Hinter Rhine and the Vorder Rhine, unite at Reichenau, 6 m. S.W. of Coire. (1) The principal stream is considered to be that of the *Hinter Rhine*, which issues (7271 ft.) from the glaciers of the Rheinwaldhorn group, and then flows first N.E. through the Rheinwald valley, and next N. through the Schams valley, which communicates by the well-known gorge of the Via Mala with the Tomleschg valley at Thusis, whence the stream continues its N. course to Reichenau; total length $35\frac{1}{2}$ m., total fall 3711 ft. It receives a number of mountain torrents during its course, the most important being that from the Avers glen, and the Albulas, both on the right, which is itself formed by many mountain streams. (2) The *Vorder Rhine* rises in the small Toma lake (7601 ft.), S. of the Oberalp Pass, not far from the St. Gotthard Pass, and then flows N.E. past Disentis and Ilanz, which claims the honour of being the "first town on the Rhine," to Reichenau; total length 42 m., total fall 3402½ ft. Its chief affluents are the stream dignified by the name of the *Medels Rhine*, that rises in the Cadlimo glen, W. of the Lukmanier Pass, and, after flowing through the Medels glen, joins the Vorder Rhine at Disentis, and the Glenner, flowing from the Lugnetz glen, both on the right. From Reichenau the united streams flow N.E. to Coire, the capital of the canton of the Grisons, and then turn towards the N., past Ragatz, the valley broadening out, and the river being joined on the right by the Landquart and the Ill, before it expands into the Lake of Constance. Extensive "corrections" of the river bed, especially the canal of Diepoldsau, have been carried out in the lower bit of this part of the valley, while from a little north of Ragatz the right bank belongs first to Liechtenstein and then to the Austrian province of the Vorarlberg. On issuing from the Lake of Constance at Constance, the Rhine flows nearly due west to Basel, where it leaves Swiss territory, the south bank during this portion of the river being entirely Swiss, save the town of Constance, but the north shore belongs to Baden, save in the case of the Swiss town of Stein-am-Rhein and the Swiss canton of Schaffhausen. The

chief towns on its banks are Constance (S.), Schaffhausen (N.), Waldshut (N.), Laufenburg (S.), Säckingen (N.), Rheinfelden (S.), and Basel (both banks). About $\frac{1}{2}$ m. below Schaffhausen the river forms the famous Falls of the Rhine, or Falls of Schaffhausen (60 ft. high), while at Coblenz, opposite Waldshut, it receives its chief affluent, the Aar, recently swollen by the Reuss and the Limmat, and of greater volume than the river in which it loses its identity. (W. A. B. C.)

2. *The German and Dutch Portion*.—After Basel, when the Rhine turns to the north and enters Germany, its breadth is between 550 and 600 ft., while its surface now lies not more than 800 ft. above the sea, showing that the river has made a descent of 6900 ft. by the time it has traversed a third of its course. From Basel to Mainz the Rhine flows through a wide and shallow valley, bordered on the east and west by the parallel ranges of the Black Forest and the Vosges. Its banks are low and flat, and numerous islands occur. The tendency to divide into parallel branches has been curbed in the interests of navigation, and many windings have been cut off by leading the water into straight and regular channels. At Mannheim the river is nearly 1500 ft. in width, and at Mainz, where it is diverted to the west by the barrier of the Taunus, it is still wider. It follows the new direction for about 20 m., but at Bingen it again turns to the north and begins a completely new stage of its career, entering a narrow valley in which the enclosing rocky hills abut so closely on the river as often barely to leave room for the road and railway on either bank; during this portion of its course the speed of the current at a normal state of the water exceeds 6 m. an hour. This is the most beautiful part of the whole course of the river, abounding in ruined castles, romantic crags and sunny vineyards. At Coblenz the valley widens and the river is 1200 ft. broad, but the hills close in again at Andernach, and this ravine-like part of its course cannot be considered as ending till below the Siebengebirge (Seven Mountains), where the river once more expands to a width of 1300–1600 ft. Beyond Bonn and Cologne the banks are again flat and the valley wide, though the hills on the right bank do not completely disappear till the neighbourhood of Düsseldorf. Farther on the country traversed by the Rhine is perfectly level, and the current becomes more and more sluggish. On entering Holland, which it does below Emmerich, its course is again deflected to the west. Within Holland the banks are so low as to require at places to be protected by embankments against inundations. Almost immediately after entering Holland the stream divides into two arms, the larger of which, carrying off about two-thirds of the water, diverges to the west, is called the Waal, and soon unites with the Maas. The smaller branch to the right retains the name of Rhine and sends off another arm, called the Yssel, to the Zuider Zee. The Rhine now pursues a westerly course almost parallel with that of the Waal. At Wijk another bifurcation takes place, the broad Lek diverging on the left to join the Maas, while the "Kromme Rijn" to the right is comparatively insignificant. Beyond Utrecht, where it is again diminished by the divergence of the Vecht to the Zuider Zee, the river under the name of the "Oude Rijn," or Old Rhine, degenerates into a sluggish and almost stagnant stream, which requires the artificial aid of a canal and of sluices in finding its way to the sea. In Roman times the Rhine at this part of its course seems to have been a full and flowing river, but by the 9th century it had lost itself in the sands of Katwijk, and it was not until the beginning of the 19th century that its way to the sea was re-opened. Though the name Rhine thus at last attaches to a very insignificant stream, the entire district between the Waal on one side and the Yssel on the other, the *Insula Batavorum* of Caesar, is really tributaries to the delta of the famous river.

Tributaries.—The Rhine is said to receive, directly or indirectly, the waters of upwards of 12,000 tributaries of all sizes. Leaving out of account the innumerable glacier streams that swell its volume above the Lake of Constance, the most important affluents to its upper course are the Wutach, the Alb and the Wiese, descending on the right from the Black Forest, and the Aar, draining several Swiss cantons on the left. In the upper Rhenish basin, between

Basel and Mainz, the tributaries, though numerous, are mostly short and unimportant. The Ill and the Nahe on the left and the Neckar and the Main on the right are, however, notable exceptions. Before joining the Rhine the Ill runs almost parallel with it and at no great distance for upwards of 50 m. In the narrow part of the valley, between Bingen and Cologne, the Rhine receives the waters of the Lahn and the Sieg on the right, and those of the Mosel, bringing with it the Saar, and the Ahr on the left. Still lower down, but before the Dutch frontier is reached, come the Ruhr and the Lippe on the right, and the Ertz on the left. The numerous arms into which the Rhine branches in Holland have already been noticed.

Physical Geography.—The Rhine connects the highest Alps with the mud banks of Holland, and touches in its course the most varied geological periods; but the river valley itself is, geologically speaking, of comparatively recent formation. Rising amid the ancient gneiss rocks of the St Gotthard, the Rhine finds its way down to the Lake of Constance between layers of Triassic and Jurassic formation; and between that lake and Basel it penetrates the chalk barrier of the Jura. The upper Rhenish valley is evidently the bed of an ancient lake, the shores of which were formed by the gneiss and granite of the Black Forest on the one side and the granite and sandstone of the Vosges on the other. In the valleys all the alluvial deposits are recent. Between Bingen and Bonn the Rhine forces its way through a hilly and rocky district belonging to the Devonian formation. The contorted strata of slate and greywacke rock must have been formed at a period vastly anterior to that in which the lake of the upper valley managed to force an outlet through the enclosing barriers. Probably this section may be looked upon as the oldest position of the river course proper, connecting the upper Rhenish lake with the primeval ocean at Bonn. In this district, too, as has already been remarked, is the finest scenery of the Rhine, a fact due in great part to the grotesque shapes of the quartzose rocks, left denuded of the less durable slate and sandstone. All the strata intersected by the Rhine between Bingen and Bonn contain fossils of the same classes. The deposits of the actual valley here, belonging to the Miocene group of the Tertiary system, are older than the deposits either farther up or farther down the river; but they are contemporaneous with the basalts of the Rhine, which at Coblenz and in the peaks of the Seven Mountains also contribute to the scenic charm of the river. The very extensive pumice deposits at Neuwied and the lava and other volcanic rocks belong to a more recent epoch. Below Bingen the formations belong almost entirely to the Post-Tertiary period. Numerous extinct volcanoes rise near Neuwied. In the flatter parts of the valley occur large beds of loam and rubble, sometimes in terraces parallel with, but several hundred feet above, the river, probably by their disposition and appearance that the valley has been formed by the action of water.

Navigation.—The Rhine has been one of the chief waterways of Europe from the earliest times; and, as its channel is not exposed to the danger of silting up like those of the Elbe and the Oder, it has always been comparatively easy to keep it open. The Romans exerted themselves to improve the lower navigation of the river, and appointed prefects of the Rhine to superintend the shipping and to exact the moderate dues imposed to keep the channel in repair. The Franks continued the same policy and retained a system of river-dues. Afterwards, as the banks became parcelled out among a host of petty princelings, each of whom arrogated the right of laying a tax on passing vessels, the impost soon became so prejudicial as seriously to hamper the development of the shipping. Many of the riparian potentates derived the bulk of their revenue from this source, and it is calculated that in the 18th century the Rhine yielded a total revenue of £200,000, in spite of the comparatively insignificant amount of the shipping. The first proposal for a free Rhine was mooted by the French at the congress of Rastatt (1797-1799), but Holland, commanding the mouth of the river, placed every obstacle in the way of the suggestion. In 1831, on the separation of Holland and Belgium, the former had become more amenable to reason; and a system was agreed upon which practically gave free navigation to the vessels of the river states, while imposing a moderate tariff upon foreign ships. After the war of 1866, Prussia negotiated with Baden, Bavaria and Hesse-Darmstadt with a view to the removal of all tolls. It was not, however, till 1868 (see *Die Rhein-Schiffahrts Akte vom 17ten Okt., 1868*) that the last vestige of a toll disappeared and the river was thrown open without any restriction. The management of the channel and navigation is now vested in a central commission, meeting at Mannheim on the 1st of July in each year. The channel has been greatly improved and in many places made more direct since the beginning of the 19th century, large sums being annually spent in keeping it in order. Capacious river harbours have been formed at various points, twenty-nine of these being in Germany and eight in Holland. The position of the river is highly favourable for the development of its trade. It flows through the most populous regions of the continent of Europe, to discharge into one of the most frequented seas opposite Great Britain, and, besides serving as a natural outlet for Germany, Belgium and Holland, is connected with a great part of central and southern

France by the Rhine-Rhone and the Rhine-Marne canals, and with the basin of the Danube by the Ludwigs-Canal.

The introduction of steam has greatly increased the shipping on the Rhine; and small steamers ply also on the Main, the Neckar, the Maas and the Mosel. The first Rhine steamer was launched in 1817; and now the river is regularly traversed by upwards of a hundred, from the small tug up to the passenger saloon-steamer. The steamboat traffic has especially encouraged the influx of tourists, and the number of passing travellers may now be reckoned as between one and two millions annually. The river is navigable without interruption from Basel to its mouth, a distance of 550 miles, of which 150 lie within Germany. Above Spire, however, the river craft are comparatively small, but lower down vessels of 500 and 600 tons burden find no difficulty in plying. Between Basel and Strassburg the depth of water is sometimes not more than 3 ft.; between Strassburg and Mainz it varies from 5 to 25 ft.; while below Mainz it is never less than 9 or 10 ft. The deepest point is opposite the Lorelei (Lurlei) Rock near St Goar, where it is 75 ft. in depth; at Düsseldorf the depth is about 50 ft.

London, Hamburg, Bremen and the chief Baltic ports as far as Riga and St Petersburg participate in the traffic on the Rhine. The boats which ply up and down the river itself, without venturing into the open sea, are mostly craft of 200 to 250 tons, owned in the great majority of cases by the captains, men of war, or of German or Dutch nationality. This fleet is computed to number some 8500 craft, with an aggregate capacity of over 2 million tons of which about one-tenth are steamships. The traffic at the chief German ports of the river aggregated 4,480,000 tons in 1870, but by 1900 this had grown to a total of 17,000,000 tons, thus distributed: Ruhrort, 6,512,000 tons; Duisburg, 3,000,000 tons; Cologne, 1,422,000 tons; and Mannheim, 6,021,000 tons. These are not the only ports on the river; a large trade is also done at Kehl, Maxau (or Karlsruhe), Ludwigshafen, Mainz, Bonn, Rotterdam and a host of smaller places. The amount of traffic which passed the town of Emmerich near the Dutch frontier, both ways, increased from an annual average of about 6 million tons in 1881-85 to over 214 million tons in 1899. Notwithstanding the inherent difficulties of construction caused by the great variations in the level of the stream, amounting sometimes to 20 ft. or more, the chief ports of the Rhine are admirably constructed, and well equipped with modern contrivances for loading and unloading vessels. Boats carrying as much as 600 tons are often able to proceed as far up stream as Strassburg, and smaller craft get as far as Hünningen, a little above Basel. Large passenger boats ply regularly between Mainz and Düsseldorf, and sometimes extend their journeys as high up as Mannheim, and as far in the other direction as Rotterdam. The difficulty of ascending the rapids near Bingen is usually surmounted by the help of steam hauling machinery placed on the bank, though powerful tugs have also come into use for this purpose. The work of blasting out the rocks which at that spot projected in the bed of the river, begun in 1830, was continued down to the year 1887, so that now there are two navigable channels of sufficient depth for all vessels which ply up and down that part of the stream. One of the most interesting features of the Rhine navigation is afforded by the huge rafts of timber that are floated down the river. Single tree trunks sent down to the Rhine by the various tributaries are united into small rafts as they reach the main stream; and these again are fastened together to form one large raft about 400 ft. long. Though not so large as formerly, these timber rafts are still sometimes 400 or 500 ft. in length and are navigated by 200 to 400 men, who live in little huts on the raft, forming actual floating villages. On reaching Dort the rafts are broken up and sold, a single raft sometimes producing as much as £50,000. The voyage from Bingen to Dort takes from one to six weeks, and the huge unwieldy structures require to be navigated with great care. The commerce carried on by the river itself is supplemented by the numerous railways, which skirt its banks and converge to its principal towns. Before the introduction of railways there were no permanent bridges across the Rhine below Basel; but now trains cross it at about a dozen different points in Germany and Holland.

History.—Politically the Rhine has always played a great part. The whole valley seems to have been originally occupied by Celtic tribes, who have left traces of their presence on the contents of tombs and in the forms of names (Moguntiacum

or Mainz, Borbetomagus or Worms); but at the beginning of the historical period we find the Celts everywhere in retreat before the advancing Teutons. Probably the Teutonic pressure began as early as the 4th century before Christ, and the history of the next few hundred years may be summed up as the gradual substitution of a Germanic for a Celtic population along the banks of the Rhine. Its second historical period begins with the advent of the Romans, who stemmed the advancing Teutonic tide. Augustus and his successors took good care to fortify the Rhine carefully, and a large proportion of the Roman legions were constantly in garrison here. For two hundred years the Rhine formed the boundary between the Roman empire and the Teutonic hordes; and during that period the left or Roman bank made prodigious strides in civilization and culture. The wonderful Roman remains at Trier and elsewhere, the Roman roads, bridges and aqueducts, are convincing proofs of what the Rhine gained from Roman domination. This Roman civilization was, however, destined to be swamped by the current of Teutonic immigration, which finally broke down the barriers of the Roman empire and overwhelmed the whole of the Rhenish district. Under Charlemagne, whose principal residence was in Aix-la-Chapelle, the culture of the Rhine valley again began to flourish, its results being still to be traced in the important architectural remains of this period. At the partition of the domains of Charlemagne in A.D. 843 the Rhine formed the boundary between Germany and the middle kingdom of Lotharingia; but by 870 it lay wholly within the former realm. For nearly eight hundred years it continued in this position, the frontier of the German empire coinciding more or less with the line of the Rhine. During the early middle ages the bank of the Rhine formed the most cultured part of Germany, basing its civilization on its Roman past. The Thirty Years' War exercised a most prejudicial effect upon the district of the Rhine; and the peace of Westphalia gave France a footing on the left bank of the hitherto exclusively German river by the acquisition of Alsace. The violent seizure of Strassburg by France in 1681 was ratified by the peace of Ryswick in 1697, which recognized the Rhine as the boundary between Germany and France from Basel to about Germersheim. It was an easy inference for the French mind that the Rhine should be the boundary throughout and the Gaul of Caesar restored. This ideal was realized in 1801, when the whole of the left bank of the Rhine was formally ceded to France. The congress of Vienna (1815) restored the lower part of the Rhenish valley to Germany, but it was not till the war of 1870-71 that the recovery of Alsace and Lorraine made the Rhine once more "Germany's river, not Germany's frontier." In the military history of all these centuries constant allusion is made to the Rhine, its passages and its fortresses. Every general who has fought in its neighbourhood has at one time or another had to provide for a crossing of the Rhine, from Julius Caesar, who crossed it twice, down to our own time. The wars carried on here by Louis XIV. are still remembered in the Rhine district, where the devastations of his generals were of the most appalling description; and scarcely a village or town but has a tale to tell of the murder and rapine of this period.

The Rhine in Literature.—The Rhine has always exercised a peculiar sort of fascination over the German mind, in a measure and in a manner not easily paralleled by the case of any other river. "Father Rhine" is the centre of the German's patriotism and the symbol of his country. In his literature it has played a prominent part from the *Nibelungenlied* to the present day; and its weird and romantic legends have been alternately the awe and the delight of his childhood. The Rhine was the classic river of the middle ages; and probably the Tiber alone is of equal historical interest among European rivers. But of late years the beauties of the Rhine have become sadly marred; the banks in places, especially between Coblenz and Bonn, disfigured by quarrying, the air made dense with the smoke of cement factories and steam-tugs, commanding spots falling a prey to the speculative builder and villages growing into towns.

See Daniel, *Deutschland*: Beyerhaus, *Der Rhein von Strassburg bis zur holländischen Grenze* (Coblenz, 1902); Mohr, *Die Flösserei auf dem Rhein* (Mannheim, 1897); C. Eckert, *Rheinschifffahrt im 19ten Jahrhundert*; Horn, *Der Rhein, Geschichte und Sagen seiner Burgen* (Stuttgart, 1893); Treutlein, *Die neueren Deutschen Rhein-Strömungen und ihre Ergebnisse (in Ausland, 1893)*; A. Chambatu, *Die Stromveränderungen des Niederrheins seit der vorrömischen Zeit* (Cologne, 1892), and handbooks of Baedeker, Meyer and Woerl. (J. F. M.; P. A. A.)

RHINE PROVINCE, or RHINELAND, the most westerly province of the kingdom of Prussia, bounded on the N. by Holland, on the E. by the Prussian provinces of Westphalia and Hesse-Nassau, and the grand duchy of Hesse-Darmstadt, on the S.E. by the Bavarian Palatinate, on the S. and S.W. by Lorraine, and on the W. by Luxemburg, Belgium and Holland. The small district of Wetzlar in the midst of the province of Hesse also belongs to the Rhine Province, which, on the other hand, surrounds the Oldenburg principality of Birkenfeld. The extent of the province is 10,423 sq. m.; its extreme length, from north to south, is nearly 200 m., and its greatest breadth is just under 90 m. It includes about 200 m. of the course of the Rhine, which forms the eastern frontier of the province from Bingen to Coblenz, and then flows through it in a north-westerly direction.

The southern and larger part of the Rhine province, belonging geologically to the Devonian formations of the lower Rhine, is hilly. On the left bank are the elevated plateaus of the Hunsrück and the Eifel, separated from each other by the deep valley of the Mosel, while on the right bank are the spurs of the Westerwald and the Sauerland, the former reaching the river in the picturesque group known as the Seven Mountains (*Siebengebirge*). The highest hill in the province is the Walderbeskopf (2670 ft.) in the Hochwald, and there are several other summits above 2000 ft. on the left bank, while on the right there are few which attain a height of 1600 ft. Most of the hills are covered with trees, but the Eifel (*g.v.*) is a barren and bleak plateau. To the north of a line drawn from Aix-la-Chapelle to Bonn the province is flat, and marshy districts occur near the Dutch frontier. The climate varies considerably with the configuration of the surface. That of the northern lowlands and of the sheltered valleys is the mildest and most equable in Prussia, with a mean annual temperature of 50° Fahr., while on the hills of the Eifel the mean does not exceed 44°. The annual rainfall varies in the different districts from 18 to 32 inches. Almost the whole province belongs to the basin of the Rhine, but a small district in the north-west is drained by affluents of the Meuse. Of the numerous tributaries which join the Rhine within the province, the most important are the Nahe, the Mosel and the Ahr on the left bank, and the Sieg, the Wupper, the Ruhr and the Lippe on the right. The only lake of any size is the Laacher See, the largest of the "maare" or extinct crater lakes of the Eifel.

Of the total area of the Rhine province about 45% is occupied by arable land, 16% by meadows and pastures, and 31% by forests. Little except oats and potatoes can be raised on the high-lying plateaus in the south of the province, but the river-valleys and the northern lowlands are extremely fertile. The great bulk of the soil is in the hands of small proprietors, and this is alleged to have had the effect of somewhat retarding the progress of scientific agriculture. The usual cereal crops are, however, all grown with success, and tobacco, hops, flax, rape, hemp and beetroot (for sugar) are cultivated for commercial purposes. Large quantities of fruit are also produced. The vine-culture occupies a space of about 30,000 acres, about half of which are in the valley of the Mosel, a third in that of the Rhine itself, and the rest mainly on the Nahe and the Ahr. The choicest varieties of Rhine wine, however, such as Johannisberger and Steinberger, are produced higher up the river, beyond the limits of the Rhine province. In the hilly districts more than half the surface is sometimes occupied by forests, and large plantations of oak are formed for the use of the bark in tanning. Considerable herds of cattle are reared on the rich pastures of the lower Rhine, but the

number of sheep in the province is comparatively small, and is, indeed, not greatly in excess of that of the goats. The wooded hills are well stocked with deer, and a stray wolf occasionally finds its way from the forests of the Ardennes into those of the Hunsrück. The salmon fishery of the Rhine is very productive, and trout abound in the mountain streams.

The great mineral wealth of the Rhine province probably furnishes its most substantial claim to the title of the "richest jewel in the crown of Prussia." Besides parts of the carboniferous measures of the Saar and the Ruhr, it also contains important deposits of coal near Aix-la-Chapelle. Iron ore is found in abundance near Coblenz, the Bleiberg in the Eifel possesses an apparently inexhaustible supply of lead, and zinc is found near Cologne and Aix-la-Chapelle. The mineral products of the district also include lignite, copper, manganese, vitriol, lime, gypsum, volcanic stones (used for millstones) and slates. By far the most important item is coal. Of the numerous mineral springs the best known are those of Aix-la-Chapelle and Kreuznach.

The mineral resources of the Prussian Rhine province, coupled with its favourable situation and the facilities of transit afforded by its great waterway, have made it the most important manufacturing district in Germany. The industry is mainly concentrated round two chief centres, Aix-la-Chapelle and Düsseldorf (with the valley of the Wupper), while there are naturally few manufactures in the hilly districts of the south or the marshy flats of the north. The largest iron and steel works are at Essen, Oberhausen, Duisburg, Düsseldorf and Cologne, while cutlery and other small metallic wares are extensively made at Solingen, Remscheid and Aix-la-Chapelle. The cloth of Aix-la-Chapelle and the silk of Crefeld form important articles of export. The chief industries of Elberfeld-Barmen and the valley of the Wupper are cotton-weaving, calico-printing and the manufacture of turkey red and other dyes. Linen is largely made at Gladbach, leather at Malmedy, glass in the Saar district and beetroot sugar near Cologne. Though the Rhineland is *par excellence* the country of the vine, beer is largely produced; distilleries are also numerous, and large quantities of sparkling Moselle are made at Coblenz, chiefly for exportation to England. Commerce is greatly aided by the navigable rivers, a very extensive network of railways, and the excellent roads constructed during the French régime. The imports consist mainly of raw material for working up in the factories of the district, while the principal exports are coal, fruit, wine, dyes, cloth, silk and other manufactured articles of various descriptions.

The population of the Rhine province in 1905 was 6,435,778, including 4,472,058 Roman Catholics, 1,877,582 Protestants and 55,408 Jews. The Roman Catholics muster strongest on the left bank, while on the right bank about half the population is Protestant. The great bulk of the population is of Teutonic stock, and about a quarter of a million are of Flemish blood. On the north-west frontier reside about 10,000 Walloons, who speak French or Walloon as their native tongue. The Rhine province is the most thickly populated part of Prussia, the general average being 617 persons per sq. m. The province contains a greater number of large towns than any other province in Prussia. Upwards of half the population are supported by industrial and commercial pursuits, and barely a quarter by agriculture. There is a university at Bonn, and elementary education is especially successful. For purposes of administration the province is divided into the five districts of Coblenz, Düsseldorf, Cologne, Aix-la-Chapelle and Trier. Coblenz is the official capital, though Cologne is the largest and most important town. Being a frontier province the Rhineland is strongly garrisoned, and the Rhine is guarded by the three strong fortresses, of Cologne with Deutz, Coblenz with Ehrenbreitstein, and Wesel. The province sends 35 members to the German Reichstag and 62 to the Prussian house of representatives.

History.—The present Prussian Rhine province was formed in 1815 out of the duchies of Cleves, Berg, Gelderland and Jülich,

the ecclesiastical principalities of Trier and Cologne, the free cities of Aix-la-Chapelle and Cologne, and nearly a hundred small lordships and abbeys. At the earliest historical period we find the territories between the Ardennes and the Rhine occupied by the Treviri, the Eburones and other Celtic tribes, who, however, were all more or less modified and influenced by their Teutonic neighbours. On the right bank of the Rhine, between the Main and the Aahn, were the settlements of the Mattiaci, a branch of the Germani, Chatti, while farther to the north were the Usipetes and Tencteri. Julius Caesar conquered the tribes on the left bank, and Augustus established numerous fortified posts on the Rhine, but the Romans never succeeded in gaining a firm footing on the right bank. As the power of the Roman empire declined the Franks pushed forward along both banks of the Rhine, and by the end of the 5th century had regained all the lands that had formerly been under Teutonic influence. The German conquerors of the Rhenish districts were singularly little affected by the culture of the provincials they subdued, and all traces of Roman civilization were submerged in a new flood of paganism. By the 8th century the Frankish dominion was firmly established in central Germany and northern Gaul. On the division of the Carolingian realm the part of the province to the east of the river fell to the share of Germany, while that to the west remained with the evanescent kingdom of Lotharingia. By the time of Otto I. (d. 973) both banks of the Rhine had become German, and the Rhenish territory was divided between the duchies of Upper and Lower Lorraine, the one on the Mosel and the other on the Meuse. Subsequently, as the central power of the German sovereign became weakened, the Rhineland followed the general tendency and split up into numerous small independent principalities, each with its separate vicissitudes and special chronicles. The old Lotharingian divisions passed wholly out of use, and the name of Lorraine became restricted to the district that still bears it. In spite of its dismembered condition, and the sufferings it underwent at the hands of its French neighbours in various periods of warfare, the Rhenish territory prospered greatly and stood in the foremost rank of German culture and progress. Aix-la-Chapelle was fixed upon as the place of coronation of the German emperors, and the ecclesiastical principalities of the Rhine bulk largely in German history. Prussia first set foot on the Rhine in 1609 by the joint occupation of Cleves; and about a century later Upper Gelderland and Mörs also became Prussian. At the peace of Basel in 1795 the whole of the left bank of the Rhine was resigned to France, and in 1806 the Rhenish princes all joined the Confederation of the Rhine. The congress of Vienna assigned the whole of the lower Rhenish districts to Prussia, which had the tact to leave them in undisturbed possession of the liberal institutions they had become accustomed to under the republican rule of the French.

RHINOCEROS, the designation for such perissodactyle (odd-toed) ungulate mammals as carry one or more horns on the head, and their extinct relatives (see PERISSODACTYLA). Rhinoceroses are of large size and massive build, but have little intelligence, and are generally timid in disposition, though ferocious when wounded or brought to bay. The African species use the nasal horns as weapons, with which they strike and toss their assailant, but the Asiatic rhinoceroses employ their sharp lower tusks much as does a boar. Rhinoceroses are dull of sight, but their hearing and scent are remarkably acute. They feed on herbage, shrubs and leaves of trees, and, like so many other large animals which inhabit hot countries, sleep the greater part of the day, and are most active in the cool of the evening or even during the night. Some are found in more or less open plains, while others inhabit swampy districts. Members of the group have existed in both east and west hemispheres since the beginning of the Miocene period; but in America they all became extinct before the end of the Pliocene period, and in the Old World their distribution has become greatly restricted. They are, for instance, no longer found in Europe and North Asia, but only in Africa and in portions of the Indian and Indo-Malayan regions. Living rhinoceroses may be arranged in three groups: (1) With a single nasal horn, and very thick skin, which is raised into strong, definitely arranged ridges or folds. In this group there are two well-marked species. The Indian rhinoceros (*Rhinoceros unicornis*), the largest of the Asiatic forms, is the most widely known, from its being exhibited in zoological gardens. A famous rhinoceros presented to the Zoological Society of London in July 1864 lived till December 1904. This species stands from 5 ft. to 5 ft. 9 in. at the shoulder and is blackish grey in colour; the horn rarely exceeds a foot in length, but one in the British Museum measures 19 in. This species is now only met with in a wild

state in the Assam plain, though it formerly had a wider range.

The first rhinoceros seen alive in Europe since the time when these animals, in common with nearly all the large remarkable beasts of both Africa and Asia, were exhibited in the Roman shows, was of this species. It was sent from India to Emmanuel, king of Portugal, in 1513; and from a sketch taken in Lisbon, Albert Dürer composed his celebrated but fanciful engraving, which was reproduced in so many old books on natural history. This species chiefly frequents swampy grass jungle and is fond of a mud-bath. According to General A. H. Kinloch, it is hunted by "tracking the animal on a single elephant until he is at last found in his lair, or perhaps standing quite unconscious



FIG. 1.—Indian Rhinoceros (*Rhinoceros unicornis*). This and the following illustrations are reduced from drawings by J. Wolf, from animals in the London Zoological Society's Gardens.

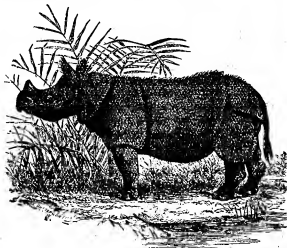

FIG. 2.—Javan Rhinoceros (*Rhinoceros sondaicus*).

of danger; or by beating him out of the jungle with a line of elephants, the guns being stationed at the points where he is most likely to break cover. In the latter case it is necessary to have reliable men with the beaters, who can exercise authority and keep them in order, for both *mahouts* and elephants have the greatest dread of the huge brute, who appears to be much more formidable than he really is." The Javan rhinoceros (*Rhinoceros sondaicus*) is distinguished by its smaller size, and a different arrangement of the skin-folds (as may be seen by comparing figs. 1 and 2). The horn in the female is little developed, if not altogether absent. This species has a more extensive geographical range than the last, being found in the Bengal Sundarbans near Calcutta, Burma, the Malay, Peninsula, Java, Sumatra and Borneo. The colour is uniform dusky grey. A female obtained in the Sundarbans

stood 5 ft. 6 in. high. This species is more an inhabitant of tree-forest than of grass jungle, and its usual habitat appears to be in hilly countries.

In the second section there is a well-developed nasal, and a small frontal horn separated by an interval. The skin is thrown into folds, but these are not strongly marked, and lower tusks are present. This group or genus is represented at the present day only by the Sumatran rhinoceros, *Rhinoceros (Diceros) sumatrensis*, with its sub-species. It is the smallest of all the species, and its geographical range is nearly the same as that of the Javan species, though not extending into Java; it has been found in Assam, Chittagong, Burma, the Malay Peninsula, Sumatra and Borneo. The colour varies from earthy brown to blackish, and the greater part of the body is thinly covered with hair, and the ears and tail are fringed. The average height of adults is from 4 ft. to 4 ft. 6 in. This species inhabits forests, and ascends hills to considerable elevations; it is shy and timid, but easily tamed even when adult. A specimen from Chittagong acquired in 1872 by the Zoological Society of London was named *R. lasiotis*, as it differed from the typical form by its larger size, paler and browner colour, smoother skin, longer, finer and redder hair, and the long fringe of hair on the ears. It is now recognized as a local race.



FIG. 3.—Black or common African Rhinoceros (*Rhinoceros (Diceros) bicornis*).

To the third group or genus (*Diceros*) belong the two African rhinoceroses, which have two horns, the skin without definite folds, and no lower tusks. The black rhinoceros (*Rhinoceros (Diceros) bicornis*) is the smaller of the two, and has a pointed prehensile upper lip. It ranges through the wooded and watered districts of Africa, from Abyssinia in the north to the Cape Colony, but its numbers are yearly diminishing, owing to the opening up of the country. It feeds exclusively on leaves and branches of bushes and small trees, and chiefly frequents the sides of wood-clad rugged hills. Specimens in which the posterior horn has attained a length as great as or greater than the anterior have been separated under the name of *R. keilloa*, but the characters of these appendages are too variable for specific distinctions. The black rhinoceros is more rarely seen in menageries in Europe than either of the Asiatic species, but one lived in the gardens of the London Zoological Society from 1868-1891.

Lastly we have the white—Burchell's, or square-mouthed—rhinoceros (*Rhinoceros (Diceros) simus*), the largest of the five, and differing from the other species in having a square truncated upper lip. In conformity with the structure of the mouth, this species lives entirely by browsing on grass, and is therefore more partial to open countries or districts where there are broad grassy valleys between the tracts of bush. In its old haunts in

the south it is practically extinct; but ten were reported from a reserve in Zululand in 1902. A detached colony exists, however, near Lado, on the Upper Nile. No specimen of this species has ever been brought alive to Europe. Mr F. C. Selous gives the following description of its habits:—

"The square-mouthed rhinoceros is a huge, ungainly looking beast, with a disproportionately large head, a large male standing 6 ft. 6 in. at the shoulder. Like elephants and buffaloes they lie asleep during the heat of the day, and feed during the night and in the cool hours of early morning and evening. Their sight is very bad; but they are quick of hearing, and their scent is very keen; they are, too, often accompanied by rhinoceros birds, which, by running about their heads, flapping their wings, and screeching at the same time, frequently give them notice of the approach of danger. When disturbed they go off at a swift trot, which soon leaves all pursuit from a man on foot far behind; but if chased by a horseman they break into a gallop, which they can keep up for some distance. However, although they run very swiftly, when their size and heavy build is considered, they are no match for an average good horse. They are, as a rule, very easy to shoot on horseback, as, if one gallops a little in front of and on one side of them, they will hold their course, and come sailing past, offering a magnificent broadside shot, while under similar circumstances a prehensile-lipped rhinoceros will usually swerve away in such a manner as only to present his hind-quarters for a shot. When either walking or running, the square-mouthed rhinoceros holds its head very low, its nose nearly touching the ground. When a small calf accompanies its mother, it always runs in front and she appears to guide it by holding the point of her horn upon the little animal's rump; and it is perfectly wonderful to note how in all sudden changes of pace, from a trot to a gallop, or vice versa, the same position is always exactly maintained. During the autumn and winter months (i.e. from March to August) the square-mouthed rhinoceros is usually very fat; and its meat is then most excellent, being something like beef, but yet having a peculiar flavour of its own. The part in greatest favour among hunters is the hump, which, if cut off whole and roasted just as it is in the skin, in a hole dug in the ground, would, I think, be difficult to match either for juiciness or flavour." (W. H. F. & R. L.)

RHINTHON (c. 323-285 B.C.), Greek dramatist, son of a potter. He was probably a native of Syracuse and afterwards settled at Tarentum. He invented the *hilarotragodia*, a burlesque of tragic subjects. Such travesties were also called *phylaces* ("fooleries") and their writers *phylacographi*. He was the author of thirty-eight plays, of which only a few titles (*Amphitryon*, *Heracles*, *Orestes*) and lines have been preserved, chiefly by the grammarians, as illustrating dialectic Tarentine forms. The metre is iambic, in which the greatest licence is allowed. The *Amphitryon* of Plautus, although probably imitated from a different writer (Archippus of the Middle Comedy), may be taken as a specimen of the manner in which such subjects were treated. There is no doubt that the hilarotragodia exercised considerable influence on Latin comedy, the *Rhithonica* (i.e. fabula) being mentioned by various authorities amongst other kinds of drama known to the Romans. Scenes from these travesties are probably represented in certain vase paintings from Lower Italy, for which see H. Heydemann, "Die Phylakendarstellungen auf bemalten Vasen," in *Jahrbuch des archäologischen Instituts*, i. (1886).

Fragments in monograph by E. Völcker (Leipzig, 1887); see also E. Sommerbrodt, *De Phylacographia Graecorum* (Breslau, 1875); W. Christ, *Geschichte der griechischen Literatur* (1898).

RHIZOPODA, the name given by Dujardin (*pro parte*, 1838) to a group of Sarcodine Protozoa. They are distinguished by their pseudopods, simple or branched, passing by wide bases into the general surface, never fine radial nor fusing into complex networks; skeleton absent or a simple shell ("test," "theca"), never (?) a calcareous shell, nor represented by a siliceous network, nor spicules. Reproduction by binary fission; by division or abstriction of buds after the body has become multi-nucleate; or by the resolution of the body into numerous uninucleate zoospores (amebulae or flagellulae) which may conjugate as gametes; plasmodium formation unknown; encystment (in "resting cysts" or "hypocysts") common. Without a knowledge of the history it is impossible to distinguish a naked Lobose from the Amoebula (pseudopodiospore) of a Myxomycete or Proteomyxan. As to the name, Dujardin included the thecate Lobosa, the Filosa, and the Reticularia or Foraminifera

(*q.v.*). The latter had already received the name Foraminifera (for their shells) from d'Orbigny; and as it is impossible to separate naked from thecate Lobosa we have merged his Amoebina (Amibiens) in the larger group. The Filosa were removed by Lang from the Reticularia; in habit and test they are inseparable from the Lobosa; and though their cytoplasm approximates to that of Reticularia, their ectosarc is much less granular, though not free from granules as stated by Lang.

The majority of Rhizopoda are fresh-water forms, some occurring in the film of water on mosses, among Sphagnum, or about the bases of grass-haulms; many, however, are exclusively marine. The aquatic forms generally may lurk among Coniferæ or higher weeds, or lie in the bottom of decomposing or excrementitious matter in still or slow-flowing waters. Of these some may become temporarily pelagic, floating up by the formation of gas vacuoles (containing probably CO₂) in the cytoplasm. It is easy to verify this by placing *Arcella* (fig. 1, 7) in a drop of water on a glass cover and inverting this over a glass ring; the *Arcella* sink to the free convex surface of the drop and escape from this most unnatural position by secreting gas-vacuoles; when they float up to contact with the glass cover, so as to touch it by the convex back of the shell, they put forth long pseudopodia which attach themselves to the glass and by their contraction turn the animal over, so that it can crawl over (i.e. under) the glass. *Amoeba* (*Entamoeba*) *histolytica*, Schaudinn, is the cause of tropical dysentery and hepatic abscess in man. *Pelomyxa* (fig. 1, 5-6) is remarkable for containing symbiotic bacteria. *Zooxanthellae* (symbiotic green cells—Algae or Flagellates) occur in several species; and *Paulinella* contains two sausage-shaped blue-green bodies, "chromatophores," which are probably symbiotic Cyanophyceae. The shell, even when not a simple membrane, has always a continuous inner membrane of a complex nitrogenous substance containing sulphur, allied to keratin and termed pseudochitin. The outer layer when present is composed of little hollow prisms (*Arcella*, fig. 1, 7), sand, or inorganic matter first swallowed by the animal (*Diffugia*, *Pseudodiffugia*), sometimes partially digested (Leccuereuxia), or else of plates secreted as "reserve plates" within the cytoplasm of the animal *Cyphoderia* (fig. 6, B), *Quadrula*, *Nebelia*, *Euglypha* (figs. 4, 6, A), &c. In *Quadrula irregularis* alone are the plates said to be calcareous; elsewhere they are always siliceous and simply refractive, so that the silica is probably hydrated (opal). The cement is possibly of silicified pseudochitin. This material is often permeated by a ferric oxide or hydrate, even when it is not coloured rusty brown. Shell formation of the membranous test is by simple surface-excretion; under budding we describe its accomplishment in the aggregated shells.

The "pylome," or aperture for the protrusion of the protoplasm, is usually single. There are two pylomes at opposite poles in several Filosa (*Ditrema*), hence united by some authors into a distinct family (fig. 7, 1, 5, 11), and in the gelatinous theca of *Trichosphaerium* (fig. 5) are numerous permanent pylomic pores. The nucleus is variable in form and character. In *Amoeba binucleata* two nuclei are always present; and some genera are permanently plurinucleate (*Pelomyxa*, *Arcella*, fig. 1, 7). It often gives forth fragments into the cytoplasm, the "chromidia" of R. Hertwig, which, as in Foraminifera (*q.v.*), may play an important part in reproductive processes. The contractile vacuole (there are two in *Arcella*, fig. 1, 7) in actively progressing Rhizopods always discharges at the hinder end. Absent or sluggish in marine forms, it is of constant occurrence in all fresh-water Rhizopods except *Pelomyxa*.

The pseudopods vary greatly in type. In *Amoeba princeps* (fig. 1, 4) they are mere promontory-like extensions of the body; in *A. radiosa* (fig. 1, 1-3) and *Trichosphaerium* (fig. 5) they are distinct slender processes, tapering, and either blunt or finely pointed at the apex; in *Pelomyxa* (fig. 1, 5, 6) as in *A. (Lithamoeba) discus* (fig. 2) they are "eruptive," hemispherical, formed apparently by the rupture of the ectoplasm, and the outpouring of the endoplasm which at once differentiates a clear outer layer as a new ectoplasm; in *Amoeba limax* during

progression the body is roughly oval with the apex truncated posteriorly and the wide anterior end forming a single anterior

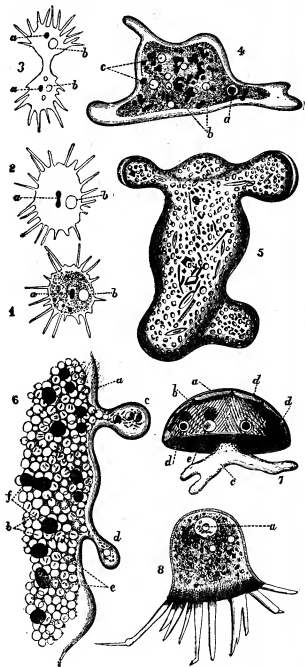

FIG. 1.—1-3, *Amoeba radiosa* (*Dactylosphaerium polypodium*), M. Schultze, in three stages of equal binary fission during fifteen minutes; *a*, nucleus; *b*, contractile vacuole (after M. Schultze). 4, *Amoeba princeps*, Ehr.; *a*, nucleus; *b*, *c*, vacuoles; food vacuoles shaded (after Auerbach). 5, 6, *Pelomyxa palustris*: 5, a small example $\frac{5}{16}$ in. in diameter, moderately extended; 6, a portion more highly magnified; *a*, ectosarc; *b*, vacuoles; *c*, *d*, pseudopods formed by eruption and containing endosarc; *e*, vesicles containing a solution of glycogen; *f*, nuclei; the numerous little pods are symbiotic bacteria. 7, *Arcella vulgaris*: *a*, shell; *b*, cytoplasm; *c*, lobose pseudopods; *d*, *d*, *d*, 3 nuclei; *e*, one of the contractile vacuoles; the dark shaded circles represent bubbles or gas vacuoles. 8, *Cochioliopodium pellicidum*: *a*, "vesicular" nucleus, with dense central mass or "karyosome" (a frequent type of Protistic nucleus). (From Lankester.)

pseudopod. Progression chiefly takes place by a rolling over of the anterior end (fig. 3—see also AMOEBIA); but it may take place by the extension of a pseudopod, its attachment at the tip,

followed by its contraction to pull up the rest of the animal, this is well shown in the thecate species. Another mode is that of *A. radiosa* (fig. 1, 1-3), which can roll over on the tips of its stiff pseudopods. The pseudopods of the Filosa (figs. 6, 7) are branched, but less rich in granules, and less viscid than those of Foraminifera; they rarely anastomose, and never coalesce to form perforated plates.

A process whose relations to reproduction are not fully made out is that of "plastogamy," where two or more individuals unite completely by their cytoplasm, the nuclei remaining distinct; it may be temporary or permanent: in the latter case

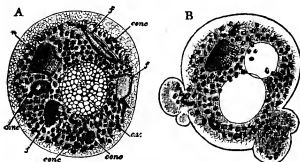
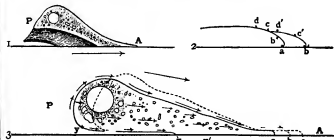

FIG. 2.—*Amoeba (Lithamoeba) discus* (after Lankester). A, quiescent; B, putting forth eruptive pseudopods. *c.v.*, contractile vacuole through which the eruptive vacuolated cytoplasm is seen; *f*, food particles; *conc.*, concretions, insoluble in dilute HCl and KHO , soluble in strong HCl; *n*, nucleus.

determining, of course, a much more rapid increase of size than that due to growth. Thanks to the labours of F. Schaudinn, we now know the full life cycles of at least half a dozen species; previously we only knew with certainty of two modes of fission—equal constriction (*Amoeba*—fig. 1, 1-3) and bud-fission (*Diffugia*). As in other Sarcodina, chromidia, or fragments of nuclear substance budded off from the nucleus into the endoplasm, play an important part in many reproductive processes. Equal binary fission is common. In the thecate forms, e.g. *Diffugia*, *Euglypha* (fig. 4), this is replaced by bud-fission; half the cytoplasm passes out through the pylome, and becomes



From Jenning's Contributions to the Study of the Behavior of Lower Organisms, by permission of the Carnegie Institution of Washington, D. C.

FIG. 3.—1, ideal perspective view of left half of a crawling Amoeba; 2, diagram showing successive position of marked points on anterior end; 3, diagrammatic section, the arrows showing directions of absolute motion—the rate being indicated by the length of the shaft.

invested with its covering there; the enclosed "reserve" skeletal elements pass to the surface in order, so that the pylome of the new shell faces that of the old; the original nucleus divides *in situ* and one daughter nucleus passes into what we may call the bud-cytoplasm; the two daughters of the original cell, which we may call the "bud-sister" and the "stock-sister" respectively, now separate. In the plurinucleate forms a true bud-formation takes place, nucleate masses of cytoplasm being constricted off at the surface. A simultaneous resolution into uninucleate cells may affect the multinucleate species (or the multinucleate state of habitually uninucleate species), this is termed schizogony.

In *Trichosphaerium* (fig. 5) it occurs at the close of two

distinct periods in the life cycle which we may call A and B; the individuals of the A period being distinguished by the brood-cells are amoebulae (pseudopodiospores) (fig. 5, 4) which grow into the multinucleate B type, with a nonspiculate theca (fig. 5, 5). The resolution of the B type is preceded by rapid multiplication of the nuclei by mitosis (fig. 5, 7), and the uninucleate cells are 2-flagellate zoospores (fig. 5, 9). These pair with zoospores of a different brood to their own (fig. 5, 10) (i.e. they are exogamous gametes); and the fusion cell (fig. 5, 11) so formed is the starting-point of the A type (fig. 5, 12). Brood formation by resolution of a multinucleate individual has been observed or conjectured in *Amoeba*, and *sluc*.

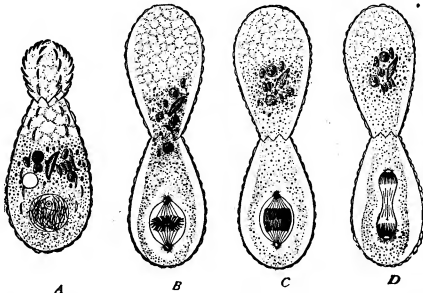

From Calkin's *Protozoa*, by permission of the Macmillan Co., New York.

FIG. 4.—Bud-fission of *Euglypha alveolata*. A, passing out of secreted plates to surface of bud. B, bud completely invested; nucleus preparing to divide by mitosis. C, D, later stages.

presence of radiating spicules of $MgCO_3$ in the gelatinous theca; the resolution of period A is simple (fig. 5, 3) and the uninucleate

swarmers, which escape as isogamous exogametes. The zygote becomes surrounded by a brown cyst. When

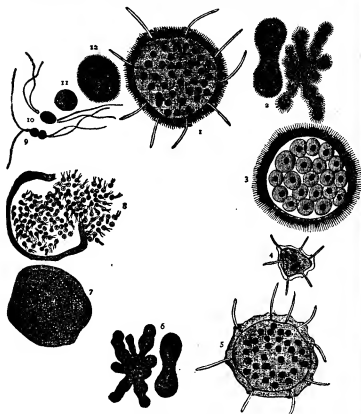

From *The Cambridge Natural History*, after Schaudinn, vol. 1, Protozoa, by permission of Macmillan & Co. Ltd.

FIG. 5.—*Trichosphaerium sieboldii*. 1, Adult of "A" form; 2, its multiplication by fission and gemmation; 3, resolution into uninucleate amoeboid zoospores; 4, development (from zoospores of "A") into "B" form (5); 6, its multiplication by fission and gemmation; 7, its resolution after nuclear bipartition into minute 2-flagellate zoospores (or exogametes); 8, liberation of gametes; 9, 10, more highly magnified pairing of gametes of different origin; 11, 12, zygote developing into "A" form.

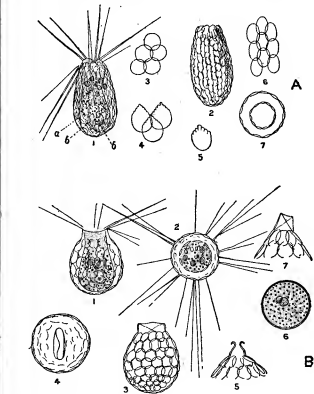

From Eugene Penard, *Faune rhizopodique du bassin du Léman*.

FIG. 6.—A, *Euglypha alveolata*. 1, Living animal; a, guitar-shaped outline of body, retracted from shell for emission of pseudopods; b, b, reserve plates in body for offspring in next bud-fission; 2, empty shell; 3, round plates; 4, 5, adoral plates with more or less marked denticulations; 6, oval plates; 7, transverse section of shell, showing circle of reserve plates within. B, *Sphenoderia lenta*. 1, Animal, lateral view; 2, same from above; 3, shell, lateral view; 4, shell, oral view of the pylome; 5, optical section through empty shell and pylome; 6, nucleus; 7, surface view of pylome (dotted lines represent its opposite side as seen at a lower focus).

swallowed by a mammal it develops, and the ordinary form is found in the excreta.

Centropixis aculeata is closely allied to *Diffugia*. It divides by fission and also at the end of a cycle by schizogony, the

species. Other types of reproduction are known, *Amoeba coli*, an inhabitant of the gut of man, showing an endogamous pairing of closely related nuclei similar to that of *Actinosphaerium* (see HELIOZOA).

CLASSIFICATION

Lobosa.—W. B. Carpenter. Cytoplasm with a clear ectosarc, not wetted by the medium; pseudopods never finely branching, usually rounded at the apex; nucleus single or multiple; shell ("test," "theca") absent, gelatinous, membranous or of cemented granules of ingested sand, &c., or plates secreted in the endosarc.

Selected genera: § 1. Naked Amoeba (*q.v.*) ("*Amibe*," Bory), with the subgenera *Dactylosphaerium*, Hertwig and Lesscr (fig. 1, 1-3), with slender, pointed pseudopods; *Lithamoeba*, Lankester, always containing inorganic granules (fig. 2); *Pelomyxa*, Greeff (fig. 1, 5, 6), with blunt, eruptive pseudopods and numerous nuclei, 15 in. or more in diameter when contracted. *Arctothrix*, Claparède and Lachmann, with one or more slender, very mobile, flagelliform pseudopods as well as the lobose ones.

§ 2. Test gelatinous, perforated by pseudopods: *Amphisonella*, Greeff; *Trichosphaerium*, Schneider (fig. 5).

§ 3. Test membranous: *Cochliopodium*, Hertwig and Lesser (fig. 1, 8).

§ 4. Test "chitinous," shagreened: *Arcella*, Stein (fig. 1, 7).

§ 5. Test of ingested particles: *Diffugia*, Leclerc; *Centropixis*, Stein; *Leaqueureuxia*, Schlumberger (shell material of diatomaceous tests fused into sausage-shaped masses).

§ 6. Test of secreted siliceous or chitinous plates: *Quadrula*, F. E. Schultze. (In *Q. irregularis* the plates are said to be calcareous.)

Filosa.—A. Lang. Cytoplasm without definite ectosarc; pseudopods branching, tapering to fine tips, somewhat granular; test present in all known species and varying as in the Lobosa.

Selected genera: § 1. Test membranous: *Gromia*, Dujardin (*pro parte*); *Mikrogromia*, Hertwig; *Diplophrys*, Barker (fig. 7, 1); *Ditrema*, Archer; *Amphitrema*, Archer (fig. 7, 11); the last three have a mouth-like aperture (pylome) at either end of the test.

§ 2. Test of ingested or incrustated particles: *Pseudodiffugia*, Schlumberger; *Diaphorodon*, Archer (fig. 7, 12).

§ 3. Test of secreted plates: *Euglypha*, Dujardin (figs. 4, 6, A); *sphenoderia lenta* (fig. 6, B); *Pauzinella*, Lauterborn.

BIBLIOGRAPHY.—E. Penard, *Faune rhizopodique du bassin du Léman* (1902), and *Les Rhizopodes des grands lacs* (1905); James Cash, *The British Freshwater Rhizopoda and Heliozoa* (Ray Society), vol. 1. (1905)—these works contain full bibliographies of older literature; L. Schlumberger, "Beiträge zur Kenntnis der Rhizopoden" (*Zeitsch. Wiss. Zoologie*, lii. (1891), and numerous papers in *Arch. Entwicklungs- und Arch. Protistenkunde*; F. Schaudinn, "Untersuch. üb. die Fortpflanzung einiger Rhizopoden" in *Arch. Kaiserl. Gesundheitsamt*, xix. (1903); S. Awerinzew, "Die chemische Zusammensetzung der Gehäuse der süßwasser-Rhizopoden," *Arch. Prot. viii.* (1906); K. Boll, "Über die Fortpflanzung von *Pelomyxa palustris*," *Arch. Prot. viii.* (1906). For bibliographies and a clear exposition we may also cite Y. Delage and E. Hérouard, *Traité de zoologie concrète*, i. (*La cellule et les protozoaires*) (1896); A. Lang, *Lehrb. d. vergleich. Anatomie d. wirbellosen Thiere* (ed. 2), i. ("Protozoa" (1909); and Marcus Hartog, "Protozoa," in *Cambridge Natural History*, i. (1906). Of the older literature, we need only cite F. Dujardin, "Sur les organismes inférieurs," *Ann. Sc. Nat. Zool.* iv. (1835), and "Zoophytes, infusoires" (1841). (M. H.A.)

RHODE ISLAND, a North Atlantic state of the American Union, belonging to the New England group, and lying between $41^{\circ} 18'$ and $42^{\circ} 3'$ N. lat. and $71^{\circ} 8'$ and $71^{\circ} 53'$ W. long.¹ It is bounded, N. and E., by the state of Massachusetts; S., by the Atlantic Ocean; and W., by the state of Connecticut, from which it is separated in part by the Pawcatuck river. Rhode Island is the smallest state in the Union, having an extreme length, N. and S., of 48 m., an extreme width, E. and W., of 37 m., and a total area of 1248 sq. m., of which 181 sq. m. are water-surface.

Topography.—The region of which Rhode Island is a part was at one time worn down to a gently rolling plain near sea-level, but has since been uplifted and somewhat dissected by stream action. As a result the topography is characterized by low, rounded hills, but is nowhere mountainous. Since the uplift and stream dissection a slight depression has allowed the sea to invade the lower portions of the river valleys, forming the bays known as Narragansett Bay, Providence "river," Sakonnet "river," &c. Glaciation has disturbed the river

¹ Block Island, over which the jurisdiction of the state extends, lies 10 m. off the coast, and is not included within these limits.

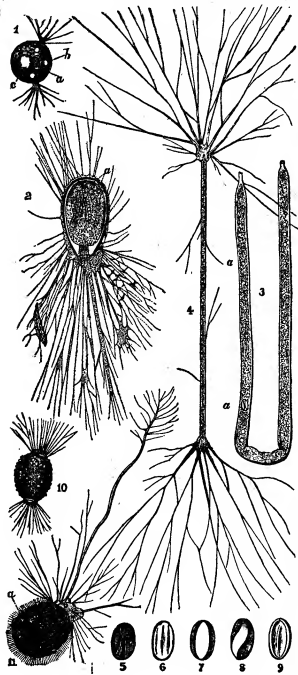

FIG. 7.—Filosa and Foraminifera of similar habit. 1, *Diplophrys archeri* (moor pools); a, nucleus; b, contractile vacuoles; c, oil drop. 2, *Allogromia fusiatisilis* (freshwater Foraminifer); a, numerous nuclei; the elongated bodies are ingested diatoms. 3, *Shephardella taeniformis* (marine Foraminifer), with retracted protoplasm; a, nucleus. 4, The same with expanded pseudopods. 5-9, Nucleus of same in various aspects as carried along in streaming protoplasm. 10, *Amphitrema wrightianum* (moor pools); shell membranous, encrusted with foreign bodies. 11, *Diaphorodon mobile* (moor pools); a, nucleus.

offspring being amoebulae. In some these acquire a shell directly; in others a second brood division into four takes place, and it is only then that shells are formed. The latter conjugate as males with the former as females; and the fusion cell encysts within the approximated shells; it emerges as a naked amoeba after a period of rest, forms a shell and assumes the type of the

systems, causing the formation of numerous lakes and of the waterfalls which determined the situation of many of the manufacturing cities of the state.

In the N.W. is Durfee Hill, which attains an elevation of 805 ft., and is the highest point within Rhode Island. The mean elevation for the entire state is 200 ft. The coast-line, including the shores of the bays and islands, is extensive; its western portion is only slightly indented, but its eastern portion is deeply indented by Narragansett Bay, a body of water varying in width from 3 to 12 m., and extending inland for about 28 m. The land surface E. of this bay is very gently rolling, but to the W. it consists of a somewhat

factories. The Providence river is really an arm of Narragansett Bay, into which flow the waters of the Pawtuxet and the Blackstone rivers. The latter stream at Pawtucket has a fall of about 50 ft., and the Pawtuxet river also has a number of falls along its course. Mount Hope Bay is a north-eastern arm of Narragansett Bay, and is also the estuary of the Taunton river. The Sakonnet river is a long bay separating Aquidneck or Rhode Island from the mainland on the E. The Pawcatuck river is the largest stream in the western half of the state, and along the lower part of its course it forms the boundary between Rhode Island and Connecticut.

Fauna and Flora.—The fauna of the state does not differ from that of southern Connecticut and eastern Massachusetts. The marine fauna is of economic importance. The woodland area of the state has been estimated (census of 1900) at 400 sq. m., or about 37% of the land area, but the trees are generally too small for timber. The most common varieties of trees are the oak, walnut and chestnut. There are a few stretches of pine forest, and in the S. the swamps are sometimes overgrown with cedar.

Climate.—Rhode Island has a more moderate climate than that of the northern sections of New England. There are no great extremes of either heat or cold, and a number of the towns and cities, especially Newport and Narragansett Pier, have become noted summer resorts. Narragansett Pier has a mean annual temperature of 49°, a mean summer temperature (for June, July and August) of 68°, and a mean winter temperature (for December, January and February) of 29°. The mean annual temperature at Providence is 50°; the mean for the summer, 72°; and for the winter, 30°; while the highest and lowest temperatures ever recorded are respectively 102° and -9°. The mean annual rainfall is about 50 in., ranging from 47.4 in. at Narragansett Pier to 53.2 in. at Kingston.

Soils.—The boulder clay or "hard pan" of which most of the surface lands are composed, forms a very indifferent support for vegetation, and consequently the state is not well adapted for the growing of crops.

Agriculture.—The acreage of improved farm land in Rhode Island decreased from 356,487 in 1850 to 137,354 in 1900, but the value of farm property (including land with improvements, implements, machinery and live stock) increased in the same period from \$19,100,640 to \$26,989,189. The number of farms remained about the same—5385 in 1850 and 5498 in 1900; but the average area decreased from 102.9 acres to 82.9 acres. The value of farm products increased from \$3,670,135 in 1879 to \$6,333,864 in 1890. The average value of farms increased from \$3547 in 1850 to \$4909 in 1900. The number of persons engaged in agricultural pursuits in 1880 was 10,986, and in 1900, 10,957.

The total acreage of cereals (barley, buckwheat, Indian corn, oats, rye and wheat) decreased from 19,575 acres in 1879 to 10,552 acres in 1899, and the total product of these crops decreased from 801,111 bu. in 1849 to 350,110 bu. in 1899.

The total number of neat cattle on farms decreased from 36,262 in 1850 to 30,696 in 1900, but the number of dairy cows increased from 18,698 to 23,660.

Fisheries.—Whaling was an established industry in Rhode Island as early as 1723, and in 1731 the colonial assembly provided for whalebone. About 1750 sperm candles were first manufactured. In 1846 about 50 whaling vessels sailed from Rhode Island ports; but by the close of the century the industry had become practically extinct. In 1905 the number of persons employed in the general fisheries industry was 2212; and the value of the catch was \$1,546,658, the largest items being: lobsters, \$64,358; squeteague (weakfish), \$86,478; scup, \$138,030; and oysters (for market), \$874,232.

Minerals.—Rhode Island's mineral wealth is relatively slight. The total value¹ of all the mineral products of the state in 1907 was \$937,384, and in 1908, \$708,694, and of these totals granite

¹ United States Geological Survey, *Mineral Resources of the United States*.

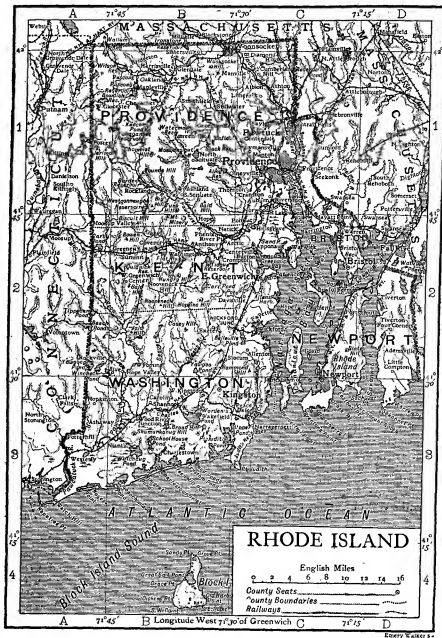

more rugged upland which slopes gradually southward. Over the whole state there is a layer of drift deposited by the glaciers which once covered this region. This glacial material is in the form of a till or boulder clay, but in the lowlands, and especially along Narragansett Bay, it is generally overlaid by stratified drift deposited by glacial streams. Within Narragansett Bay are the numerous islands characteristic of an area which has suffered comparatively recent depression, the largest being Rhode Island (or Aquidneck), Conanicut Island and Prudence Island. Of these the most important is Rhode Island, 15 m. long and 3 m. wide, which has given the state its name. Lying about 10 m. off the coast and S. of the central part of the state is Block Island, a sandy tract 6 m. long and from 1 to 4 m. wide, with a rolling surface.

The rivers of the state are short and of no great volume, but they flow swiftly and are useful in supplying power for manu-

factories. The Providence river is really an arm of Narragansett Bay, into which flow the waters of the Pawtuxet and the Blackstone rivers. The latter stream at Pawtucket has a fall of about 50 ft., and the Pawtuxet river also has a number of falls along its course. Mount Hope Bay is a north-eastern arm of Narragansett Bay, and is also the estuary of the Taunton river. The Sakonnet river is a long bay separating Aquidneck or Rhode Island from the mainland on the E. The Pawcatuck river is the largest stream in the western half of the state, and along the lower part of its course it forms the boundary between Rhode Island and Connecticut.

was valued in 1908 at \$556,774. The value of the clay products, lime and talc, decreased from \$245,378 in 1907 to \$112,815 in 1908. The mining of iron ore was begun about 1767 in the vicinity of the present Cranston, and much of the metal was used in the making of cannon during the War of Independence, but the supply was soon exhausted. Near Tiverton and Cranston graphite has been quarried.

Manufactures.—Rhode Island is essentially a manufacturing state; of the 191,923 persons in the state engaged in gainful occupations in 1900, 101,162 (or 52.7%) were employed in manufacturing and mechanical pursuits. By the middle of the 17th century boat-building had become an established industry, and large vessels were built at Newport. In 1777 the state offered a large premium for every pound of steel, similar to German steel, made within its boundaries; and in 1789 a rolling and slitting mill was built near Providence. Cotton was first imported to Providence from Spain in 1785; a company to carry on cotton-spinning, formed at Providence in 1786, established there in the following year a factory containing a spinning jenny of 28 spindles (the first machine of the kind to be used in the United States), and also a carding machine and a spinning frame with which was manufactured a kind of jean having a linen warp and a cotton filling. The fly shuttle was also apparently first introduced at Providence in 1788. The first calico printed in the United States was made at East Greenwich about 1794. The Providence Association of Mechanics and Manufacturers, incorporated in 1789, organized industrial development. The prohibition of the exportation from England of machinery, models or drawings retarded mechanical improvement, but in 1790 an industrial company was formed at Providence to carry on cotton spinning, and in December of that year there was established at Pawtucket a factory equipped with Arkwright machines constructed by Samuel Slater. This machinery was operated by water-power, then first used in the United States for the spinning of cotton thread; and from this may be dated the beginning of the factory system in Rhode Island. These machines were soon adapted to the spinning of wool, and in 1804 a woollen factory was built at Peacedale, South Kingstown. The first power-loom used in the United States was invented about 1812, and was set up at Peacedale, in 1814, for the manufacture of woollen saddlegirths and other webbing. The first power-loom for cotton manufacture was set up in North Providence in 1817. Textile manufacturing by improved methods was hardly well established in Rhode Island before 1825. The manufacture of jewelry, which was established in Providence in 1784, was greatly promoted ten years later by Nehemiah Dodge's invention of the process of "gold-filling," still further improved in 1846 by Thomas H. Lowe. The manufacture of silverware was begun in Providence soon after the close of the War of Independence.

Rhode Island's water powers have been its only natural resources which have aided in the development of its manufactures, and its transportation facilities have always been inadequate, because of shallow water at Providence and scanty railway communication; but the state's manufacturing enterprises are of great importance.

In 1900 Rhode Island ranked 17th among the states in the value of its manufactured products, but led all of the states in the value per capita (\$4.30). The total number of establishments in 1850 was 864; in 1890, 3377, and in 1900, 4189. In 1900 there were 1678 factories, and in 1905, 1617 factories.¹ The total capital invested in manufacturing in 1850 was \$129,935,676; in 1890, \$126,483,401, and in 1900, \$183,784,587, of which \$176,901,606 was in factories; in 1905 the capital invested in factories was \$215,901,375. The value of all manufactured products in 1850 was \$22,117,688; in 1890, \$142,500,625, and in 1900, \$184,074,378, of which \$165,550,382 was the value of factory products; in 1905 the value of factory products was \$202,109,583. The average number of employes in 1850 was 20,967; in 1890, 81,111; and in

1900, 98,813, of whom 88,197 were factory employes; in 1905 there were 97,318 factory employes.

Rhode Island ranked first in 1900 (\$13,229,313) and in 1905 (\$14,431,756) among the states of the United States in the value of jewelry, which was fourth in the value of the state's manufactures; second in worsted goods (1900, \$33,341,329; 1905, \$44,477,596), which were first in value in the state's manufactures; and third in dyeing and finishing textiles (1900, \$8,484,878; 1905, \$9,981,457), which ranked fifth among the state's manufactures; in the value of cotton goods (second in rank in the state) it fell from the fourth rank in 1900 (\$24,056,175) to fifth rank in 1905 (\$30,628,843), when the value of Rhode Island's product was less than that of Georgia. Other important manufactures were: combined textiles (not including flax, hemp and jute products) in 1900, \$77,998,396; in 1905, \$103,096,311; foundry and machine shop products in 1900, \$13,269,066; in 1905, \$16,338,512; woollen goods in 1900, \$5,330,550; in 1905, \$8,163,167; rubber boots and shoes in 1900, \$8,344,417; electrical machinery, apparatus and supplies in 1900, \$5,113,202; in 1905, \$5,435,474; silversmithing and silversware in 1900, \$4,249,190; in 1905, \$5,323,264; gold and silver, reducing and refining (not from ore) in 1900, \$3,484,454; in 1905, \$4,260,698; cotton small wares in 1900, \$2,379,500; in 1905, \$3,944,607; hosiery and knit goods in 1900, \$2,713,850; in 1905, \$3,344,655; silk and silk goods in 1900, \$1,311,333; in 1905, \$2,555,986. In 1905, 1146 establishments reported power, as against 1360 in 1900—a decrease of 15.7%; but the total horsepower increased from 155,545 to 190,777; or 22.7%.

Transportation.—Steam railway mileage in Rhode Island increased from 68 m. in 1850 to 209 m. in 1900, and to 221 m. on the 1st of January 1909 (the New York, New Haven & Hartford being the only railway system of any importance in the state). In 1910 a charter was granted to the Grand Trunk system. In 1902 the mileage of street and electric railways (most of them interurban) operated in the state was 336.33 m. The state has a natural water outlet in the Providence river and Narragansett Bay, but there is lack of adequate dockage in Providence harbour, and insufficient depth of water for ocean traffic. The ports of entry are Providence (by far the largest, with imports valued at \$1,893,551, and exports valued at \$12,517 in 1909), Newport and Bristol.

Population.—The total population of Rhode Island in 1880 was 276,531; in 1890, 345,506; in 1900, 428,556; and in 1910, 542,610.² The increase from 1880 to 1890 was 24.6%, from 1890 to 1900 24%, and from 1900 to 1910, 26.9%. Of the total population in 1900, 285,278 were native whites, 134,519 were foreign-born, 9992 were negroes, 366 were Chinese, 35 were Indians and 13 were Japanese. Of the foreign-born, 35,501 were Irish, 31,533 were French-Canadians and 22,832 were English. Of the total population, 275,143 were of foreign parentage, i.e. either one or both parents were foreign-born—and 81,232 were of Irish parentage, both on the father's and mother's side, and, in the same sense, 49,427 were of French-Canadian and 32,007 of English parentage. Rhode Island in 1900 had the highest percentage of urban population of any state in the Union, 91.6% of the total population living in cities of 4000 or more inhabitants. From 1890 to 1900 the urban population increased from 310,335 to 392,509 or 26.5%; while the rural population (i.e. population outside of incorporated places), increased from 35,171 to 36,047—1.1% of the total increase in population. The cities of the state, with population in 1900,³ are Providence, 175,597; Pawtucket, 39,231; Woonsocket, 28,204; Newport, 22,034; and Central Falls, 18,167. In 1906 there were in the state 264,712 communicants of various religious denominations, and of these 199,951 were Roman Catholics. Second in strength were the Baptists, who founded the colony; in 1906 they numbered 19,878, of whom 14,304 were of the Northern Convention. There were 15,443 Protestant Episcopalians, 9858 Congregationalists, 7892 Methodists. The Friends, whose influence was so strong in the early history of Providence, numbered in 1906 only 648 in the whole state.

Administration.—The state is governed under the constitution of 1842, with amendments adopted in 1854, 1864, 1886, 1888, 1889, 1892, 1893, 1900, 1903, 1909. All native or naturalized citizens of the United States residing in Rhode

¹ The populations in other census years were: (1790) 68,825; (1800) 68,122; (1810) 76,931; (1820) 83,059; (1830) 97,199; (1840) 109,830; (1850) 147,545; (1860) 174,620; (1870) 217,353.

² In 1910 the populations of the cities were: Providence, 224,326; Pawtucket, 51,622; Woonsocket, 38,125; Newport, 27,149; and Central Falls, 22,754.

³ The 1905 census of manufactures gives statistics only for establishments under the factory system, excluding the hand trades, and gives factory statistics for 1905 and for 1900. The statistics given above for 1900 in comparison with 1905 are for factory products.

Island are citizens of the state. Under an act of 1724 the suffrage was restricted to adult males who possessed a freehold of the value of \$134 (see *History*). So far as state and national elections are concerned, the privilege was extended to native non-freeholders by the constitution of 1842, to naturalized foreigners who had served in the Civil War by an amendment of the 7th of April 1886, and to all adult male citizens by the amendment of the 4th of April 1888. A curious survival of the old system exists in the provision that only those who pay taxes on \$134 worth of property may vote for members of city councils or on propositions to levy taxes or to expend public money. The working men are thus almost entirely excluded from participating in the government of the large factory towns.

Amendments to the constitution must be passed by both houses of the General Assembly at two consecutive sessions, and must then be ratified by three-fifths of the electors of the state present and voting thereon in town and ward meetings. Fifteen amendments have thus been added to the constitution of 1842. An amendment of the 7th of April 1886 forbade the manufacture and sale of intoxicating beverages, but it was badly enforced and was repealed by a subsequent amendment of the 20th of June 1889.

The powers of the governor are unusually small. Until 1909, when a constitutional amendment was adopted, he had no power of veto, and his very limited nominal powers of appointment and removal are controlled by a rotten-borough Senate. The other administrative officers are a secretary of state, an attorney-general, an auditor, a treasurer, a commissioner of public schools, a railroad commissioner, and a factory inspector, and various boards and commissions, such as the board of education, the board of agriculture, the board of health, and the commissioners of inland fisheries, commissioners of harbours and commissioners of pilots.

The legislative power is vested in the General Assembly, which consists of a Senate made up of the lieutenant-governor and one senator from each of the thirty-eight cities and townships in the state, and a House of Representatives of one hundred members, apportioned according to population, but with the proviso that each town or city shall have at least one member and none shall have more than one-fourth of the total (see *History*). Members of the legislature and all state officials are elected annually in November. A majority vote was formerly required, but the adoption of the tenth amendment (Nov. 28, 1893) a plurality vote has effected.

At the head of the judicial system is the supreme court (1747), with final revisory and appellate jurisdiction. Below this are the superior court (1905), the twelve district courts, the town councils, probate courts in the larger towns, and justices of the peace. The five judges of the supreme court, the six judges of the superior court and the district judges are elected by the General Assembly; the supreme and the superior court justices hold office until dismissed by the General Assembly or found guilty of official misdemeanour, and the district judges have three-year terms.

The town (or township) is the unit of local government, the county being recognized only for judicial purposes and to a certain extent in the appointment by central administrative boards. There are five counties and thirty-eight towns. The municipal governments of Newport and Providence present interesting features, for which see the separate articles on these cities.

Education.—The public school system of Rhode Island was established in 1800, abolished in 1803, and re-established in 1828. At the head of it is a commissioner of education, appointed by the governor and the Senate, and a board of education, composed of the governor and the lieutenant-governor *ex officio* and six other members elected by the General Assembly. Under an act of the 12th of April 1883, as amended on the 4th of April 1902, education is compulsory for children between the ages of seven and fifteen, but the maximum limit is reduced to thirteen for children who are employed at labour labour. The total enrolment in the public schools in 1905 was 71,425 and the total expenditure for public school purposes was \$1,987,751. A considerable proportion of the Irish and the French Canadians send their children to the Roman Catholic parochial schools. The chief institutions for higher educa-

tion are Brown University (1764), the State School of Design (1877), the State Normal School (reorganized 1898), and the Moses Brown School (1819), all at Providence (*q.v.*), and the State College of Agriculture and Mechanic Arts (1888) at Kingston, a land grant college under the Morrill Acts of 1862 and 1890, the Hatch Act of 1887 and the Adams Act of 1906. This institution was founded as an agricultural school in 1888 and became a college in 1892. It has departments in agriculture, engineering and science, a library of 15,000 volumes and an experimental station. There are state training-schools for teachers at Providence, Cranston, Bristol, Barrington, Central Falls, Warwick and Pawtucket.

Charitable and Penal Institutions.—A board of state charities and corrections, established in 1869, supervises and controls all of the penal, charitable and correctional institutions of the state at large and also the local almshouses. There were in 1910 nine members of the board, three from Providence county, one from each of the other counties, and one from the state at large; five were appointed by the governor with the consent of the Senate, and four were elected by the Senate. A group of institutions (under the control of the board) at Howard, in Cranston township, about 7 m. from Providence, including the Workhouse and House of Correction, the Hospital for the Insane (1869), the Almshouse, the State Prison and Providence County Jail, the Sockanosset School for Boys, and the Oaklawn School for Girls, are supported entirely or in part by the state. In addition to the institutions under the board of charities and corrections there are two for the education of the deaf and dumb, supported in part by the state, the School for the Deaf (1872) and the Home and School for Dependent and Neglected Children (1885) at Providence. The Soldiers' Home (1891) at Bristol, the Butler Hospital for the Insane (1847) at Providence, and a Sanitarium (1905) at Wallum Lake, in the township of Burrillville, also receive state aid.

Finance.—The chief sources of revenue in the order named are the general property tax, the tax on savings banks, the tax on insurance companies, and liquor licenses. There is no corporation tax. The total receipts from all sources for the year 1909 were \$2,317,512, the expenditures, \$2,345,350. The public debt, which originated in 1752, amounted to £7,000 sterling in 1764, to £4000 in 1775 and to \$698,000 in 1783. Part of the Revolutionary debt was paid in depreciated paper, part was assumed by the United States government, part was paid at various rates of depreciation between 1803 and 1820, and the remainder, \$43,971, was repudiated in 1847. Other obligations had accumulated in the meantime, however, so that the debt in 1848 amounted to \$187,000. This was gradually reduced until the Civil War, when it was increased to \$3,889,000 by 1865. A sinking fund commission was established in 1875, and the entire sum was extinguished by the 1st of August 1894. The issue of bonds for the construction of the new capitol building and other purposes has led, however, to a new debt, which at the beginning of 1910 amounted to \$4,800,000. There was at the same time a sinking fund of \$654,999. Before the adoption of the Federal constitution Rhode Island was badly afflicted with the paper money heresy. £5000 were printed in 1710, and from that time until 1751 there were nine separate issues. These were gradually retired, however, through the efforts of the mercantile classes, aided by the parliamentary statutes of 1751 and 1763, and by about 1763 the finances were again placed on a sound money basis. The influx of Continental currency gave some trouble during the War of Independence, but there were no further local issues until 1786, when £100,000 were issued.

The first banks organized in the state were the Providence Bank in 1791, the Bank of Rhode Island at Newport in 1795, and the Washington Bank at Westerly in 1800. Forty-four charters had been granted by 1837. Partly through the efforts of the state, local legislation and partly as a result of the operation of the Suffolk system of redemption in Boston, these institutions were always conservative. During practically the entire period before the Civil War their note issues constituted a smaller proportion of the capital stock than those of any other state. By an act of 1858 which is still in force, annual reports must be presented to the state auditor. On the establishment of the national banking system, 1863-65, nearly all of the banks took out national charters. Since that time the most notable features have been the rise and decadence of the national bank of the state, the rise of the trust companies. During the decade from 1890 to 1900 the deposits in the national banks increased only 5%, from \$16,700,000 to \$17,500,000; those of the trust companies increased 330%, from \$12,000,000 to more than \$40,000,000. During the period from 1890 to 1901 twenty national banks retired from business, and the total capital stock was reduced from about twenty millions to about thirteen millions of dollars.

History.—Rhode Island was founded by refugees from Massachusetts, who went there in search of religious and political freedom. The first settlements were made at Providence by Roger Williams (*q.v.*) in June 1636, and at Portsmouth on the island of Aquidneck by the Antinomians, William Coddington (1601-1678), John Clarke (1609-1676), and Anne Hutchinson (1591-1643), in March-April 1638.

¹ Under the constitution of 1842 it was provided that there should be two sessions of the General Assembly annually: one at Newport in May, and the other in October to be held at South Kingstown once in two years, and the intermediate years alternately at Bristol and East Greenwich, an adjournment from the October session being held annually at Providence. In 1854 this was amended: one session was provided for to be held in Newport in May, an adjournment being held annually at Providence. And in 1900 by another amendment Providence became the only meeting-place of the General Assembly.

Becoming dissatisfied with conditions at Portsmouth, Coddington and Clarke removed a few miles farther south on the 29th of April 1639, and established a settlement at Newport. In a similar manner Warwick was founded in January 1643 by seceders from Providence under the lead of Samuel Gorton. The union of Portsmouth and Newport, March 12, 1640, was followed by the consolidation of all four settlements, May 19, 1647, under a patent of March 14, 1644, issued by the parliamentary board of commissioners for plantations. The particularistic sentiment was still very strong, however, and in 1651 the union split into two confederations, one including the mainland towns, Providence and Warwick; the other, the island towns, Portsmouth and Newport. A reunion was effected in 1654 through the influence of Roger Williams, and a charter was secured from Charles II. on the 8th of July 1663. In the patent of 1644 the entire colony was called Providence Plantations. On the 13th of March 1644 the Portsmouth-Newport General Court changed the name of the island from Aquidneck to the Isle of Rhodes or Rhode Island. The official designation for the province as a whole in the charter of 1663, therefore, was Rhode Island and Providence Plantations. The charter was suspended at the beginning of the Andros régime in 1686, but was restored again after the Revolution of 1689. The closing years of the 17th century were characterized by a gradual transition from the agricultural to the commercial stage of civilization. Newport became the centre of an extensive business in piracy, privateering, smuggling, and legitimate trade. Cargoes of rum, manufactured from West Indian sugar and molasses, were exported to Africa and exchanged for slaves to be sold in the southern colonies and the West Indies. The passage of the Sugar Act of April 5, 1764, and the steps taken by the British government to enforce the Navigation Acts seriously affected this trade. The people of Rhode Island played a prominent part in the struggle for independence. On the 9th of June 1772 the "Gaspee," a British vessel which had been sent over to enforce the acts of trade and navigation, ran aground in Narragansett Bay and was burned to the water's edge by a party of men from Providence. Nathanael Greene, a native of Rhode Island, was made commander of the Rhode Island militia in May 1775, and a major-general in the Continental army in August 1776, and in the latter capacity he served with ability until the close of the war. In the year 1776, General Howe sent a detachment of his army under General Henry Clinton to seize Newport as a base of operations for reducing New England, and the city was occupied by the British on the 8th of December 1776. To capture this British garrison, later increased to 6000 men, the co-operation of about 10,000 men (mostly New England militia) under Major-General John Sullivan, and a French fleet carrying 4000 French regulars under Count D'Estaing, was planned in the summer of 1778. On the 9th of August Sullivan crossed to the north end of the island of Rhode Island, but as the Frenchmen were disembarking on Conanicut Island, Lord Howe arrived with the British fleet. Count D'Estaing hastily re-embarked his troops and sailed out to meet Howe. For two days the hostile fleets manoeuvred for positions, and then they were dispersed by a severe storm. On the 20th, D'Estaing returned to the port with his fleet badly crippled, and only to announce that he should sail to Boston to refit. The American officers protested but in vain, and on the 28th they decided to retreat to the north end of the island. The British pursued, and the next day there was a severe engagement in which the Americans were driven from Turkey and Quaker Hills. On the 30th the Americans, learning of the approach of Lord Howe's fleet with 5000 troops under Clinton, decided to abandon the island. The British evacuated Newport the 25th of October 1779, and the French fleet was stationed here from July 1780 to 1781.

The influence of Roger Williams's ideas and the peculiar conditions under which the first settlements were established have tended to differentiate the history of Rhode Island from

that of the other New England states. In 1640 the General Court of Massachusetts declared that the representatives of Aquidneck were "not to be capitulated withal either for themselves or the people of the isle where they inhabit," and in 1644 and again in 1648 the application of the Narragansett settlers for admission to the New England Confederacy was refused except on condition that they should pass under the jurisdiction of either Massachusetts or Plymouth. Rhode Island was one of the first communities in the world to advocate religious freedom and political individualism.

The individualistic principle was shown in the jealousy of the towns toward the central government, and in the establishment of legislative supremacy over the executive and the judiciary. The legislature migrated from county to county up to 1854, and there continued to be two centres of government until 1900. The dependence of the judiciary upon the legislature was maintained until 1860, and the governor is still shorn of certain powers which are customary in other states (see *Administration*). In the main the rural towns have adhered most strongly to the old individualistic sentiment, whereas the cities have kept more in touch with the modern nationalistic trend of thought. This was shown, for example, in the struggle for the ratification of the Federal constitution. Under the Articles of Confederation it was principally Rhode Island that defeated the proposal to authorize Congress to levy an impost duty of 5% mainly as a means of meeting the debts of the Central government. When the constitutional convention met in Philadelphia in 1787 to frame a constitution for a stronger Federal government, the agriculturists of Rhode Island were afraid that the movement would result in an interference with their local privileges, and especially with their favourite device of issuing paper money, and the state refused to send delegates, and not until the Senate had passed a bill for severing commercial relations between the United States and Rhode Island, did the latter, in May 1790, ratify the Federal constitution, and then only by a majority of two votes. Rhode Island, like the rest of New England, was opposed to the War of 1812 and the Mexican War. During the Civil War it sent 23,457 men into the service of the Union.

The economic transition of the later 17th century from the agricultural to the commercial régime was followed by a further transition to the manufacturing régime during the closing years of the 18th and the early years of the 19th centuries. Commercial interests have been almost entirely destroyed, partly because of the abolition of the slave trade and partly because of the embargo and the war of 1812, but mainly because the cities of the state are unfavourably situated to be the termini of interstate railway systems. Providence, owing to its superior water-power facilities, has therefore become one of the leading manufacturing centres of New England, whereas Newport is now known only as a fashionable summer resort. The movement as a whole was of exactly the same character as the industrial revolution in England, and it led to the same result, a struggle for electoral reform. The system of apportionment and the franchise qualifications were worked out to meet the needs of a group of agricultural communities. The charter of 1663 and the franchise law of 1724 established substantial equality of representation among the towns, and restricted the suffrage to freeholders. In the course of time, therefore, the small towns came to be better represented proportionally than the large cities, and the growing class of artisans was entirely disfranchised. The city of Providence issued a call for a constitutional convention in 1796, and similar efforts were made in 1799, 1817, 1821, 1822 and 1824, but nothing was accomplished. About 1840 Thomas W. Dorr (1805-1854), a young lawyer of Providence, began a systematic campaign for an extension of the suffrage, a reapportionment of representation and the establishment of an independent judiciary. The struggle, which lasted for several years, and in fact is not yet entirely over, was one between the cities and the country, between the manufacturers and the agriculturists. It was

also complicated by racial and religious prejudices, a large proportion of the factory operatives being foreigners and Roman Catholics, and most of the country people native Protestants. The former were in general associated with the Democratic party, the latter with the Whigs. A convention summoned without any authority from the legislature, and elected on the principle of universal manhood suffrage, met at Providence, October 4-November 18, 1841, and drafted a frame of government which came to be known as the People's Constitution. A second convention met on the call of the legislature in February 1842 and adopted the so-called Freeman's Constitution. On being submitted to popular vote the former was ratified by a large majority (December 27, 28, 29, 1841), while the latter was rejected by a majority of 676 (March 21, 22, 23, 1842). At an election held on the 18th of April 1842 Dorr was chosen governor. The supreme court of the state and the president of the United States (Tyler) both refused to recognize the validity of the People's Constitution, whereupon Dorr and a few of his more zealous adherents decided to organize a rebellion. They were easily repulsed in an attack upon the Providence town arsenal, and Dorr, after a brief period of exile in Connecticut, was convicted of high treason on the 26th of April 1844, and was sentenced to imprisonment for life. He was released by act of the Assembly in June 1845, and was restored to the full rights of citizenship in May 1851. The Freeman's Constitution, modified by another convention, which held its session at Newport and East Greenwich, September 12-November 5, 1842, was finally adopted by popular vote on November 21-23, 1842. Only a partial concession was made to the demand for reform. The suffrage was extended to non-freeholders, but only to those of American birth. Representation in the lower house of the legislature was apportioned according to population, but only on condition that no city or town should ever elect more than one-sixth of the total number of members. Each city and town without regard to population was to elect one senator. In order to perpetuate this system the method of amending the constitution was made extremely difficult (see *Administration*). Since the adoption of the constitution the conditions have become worse owing to the extensive immigration of foreigners into the large cities and the gradual decay of the rural towns. From about 1845 to 1880 most of the immigrants were Irish, but since 1880 the French-Canadians have constituted the chief element. In 1900 over 30% of the population of the state was foreign-born. A constitutional amendment of 1888 extended to them the right of suffrage in state and national elections, and an amendment of 1900 partially remedied the evils in the system of apportionment. When the last Federal census was taken in 1910, Providence, Pawtucket, Woonsocket and Newport, with a combined population of 341,222, had four senators, whereas the remainder of the state, with a population of 201,452, had thirty-four. Providence, with a population of 224,326 out of a total of 542,674, had one member in a Senate of thirty-eight and twenty-five members in a House of Representatives of one hundred. The Republican machine finds it easy with the support of the millionaire summer colony at Newport and the street railway corporations to corrupt the French-Canadians and a portion of the native element in the rural towns and maintain absolute control of the state government. The majority has occasionally protested by electing a Democratic governor, but he has not been able to accomplish a great deal, because until 1909 he did not have veto power nor effectual means to induce the Senate to ratify his appointments. Bonds were issued on the 8th of November 1892 for the construction of a new state house at Providence, the corner stone was laid in October 1896, and the building was thrown open to use on the 1st of January 1901. A constitutional amendment of 1900 dispensed with the session of the legislature at Newport.

In presidential campaigns the state has been Federalist, 1792-1800; Democratic Republican, 1804; Federalist, 1808-1812; Democratic Republican, 1816-1820; Adams (Republican), 1824-1828; National Republican, 1832; Democratic, 1836; Whig, 1840-1848; Democratic, 1852; and Republican since 1856.

GOVERNORS OF RHODE ISLAND

<i>Portsmouth</i>	
William Coddington	Judge, 1638-1639
William Hutchinson	" 1639-1640

<i>Newport</i>	
William Coddington	Judge, 1639-1640

<i>Portsmouth and Newport</i>	
William Coddington	Governor, 1640-1647

PRESIDENTS UNDER THE PATENT OF 1644	
John Coggeshall	1647-1648
Jeremy Clarke	1648-1649
John Smith	1649-1650
Nicholas Easton	1650-1651

<i>Providence and Warwick</i> ¹	
Samuel Gorton	President, 1651-1652
John Smith	" 1652-1653
Gregory Dexter	" 1653-1654

<i>Portsmouth and Newport</i>	
John Sanford	President, 1653-1654

PRESIDENTS UNDER THE PATENT OF 1644	
Nicholas Easton	1654
Roger Williams	1654-1657
Benedict Arnold	1657-1660
William Brenton	1660-1662
Benedict Arnold	1662-1663

GOVERNORS UNDER THE CHARTER OF 1663	
Benedict Arnold	1663-1666
William Brenton	1666-1669
Benedict Arnold	1669-1672
Nicholas Easton	1672-1674
William Coddington	1674-1676
Walter Clarke	1677-1678
Benedict Arnold	1678
William Coddington	1678-1680
John Cranston	1680-1683
Peleg Sanford	1683-1685
William Coddington, 2d	1685-1686
Henry Bull	1686 ²
Walter Clarke	1689-1690
John Coggeshall (acting)	1690
Henry Bull	1690-1695
John Easton	1695
Caleb Carr	1696-1698
Walter Clarke	1698-1727
Samuel Cranston	1727-1732
Joseph Jencks	1732-1733
William Wanton	1734-1740
John Wanton	1740-1743
Richard Ward	1743-1745
William Greene	1745-1746
Gideon Wanton	1746-1747
William Greene	1747-1748
Gideon Wanton	1748-1755
William Greene	1755-1757
Stephen Hopkins	1757-1758
William Greene	1758-1762
Stephen Hopkins	1762-1763
Samuel Ward	1763-1765
Stephen Hopkins	1765-1767
Samuel Ward	1767-1768
Stephen Hopkins	1768-1769
Josias Lyndon	1769-1775
Joseph Wanton	1775-1778
Nicholas Cooke	1778-1786
William Greene, 2nd	1786-1786
John Collins	1786-1790

Arthur Fenner, ³ Federalist and Democratic Republican	1790-1805
Paul Mumford (acting), Democratic Republican	1805
Henry Smith, " " " "	1805-1806
Isaac Wilbour, " " " "	1806-1807
James Fenner, Democratic Republican	1807-1811
William Jones, Federalist	1811-1817
Nehemiah R. Knight, Democratic Republican	1817-1821
William C. Gibbs,	1821-1824
James Fenner ⁴ (Democratic Republican and National Republican)	1824-1831

¹ A separation occurred in 1651 between the towns of Providence and Warwick on one side and Portsmouth and Newport on the other. They were reunited in 1654.

² The charter was suspended from 1686 to 1689, during which time the province was under the supervision of Sir Edmund Andros.

³ Arthur Fenner became a Democratic Republican about 1800.

⁴ James Fenner was a Democratic Republican to 1826, a National Republican (Adams) to 1829 and a Democrat (Jackson) to 1831.

Lemuel H. Arnold, National Republican	1831-1833
John B. Francis, Democrat and Anti-Masonic	1833-1838
William Sprague, Whig	1838-1839
Samuel W. King, Whig	1839-1843

UNDER THE CONSTITUTION OF 1842

James Fenner, Whig	1843-1845
Charles Jackson, ¹ Democrat	1845-1846
Byron Diman, Whig	1846-1847
Elisha Harris, Whig	1847-1849
Henry B. Anthony, Whig	1849-1851
Philip Allen, Democrat	1851-1853
Francis M. Dimond (acting), Democrat	1853-1854
William W. Hoppin, Whig and American	1854-1857
Elisha Dyer, Republican	1857-1859
Thomas G. Turner, Republican	1859-1860
William Sprague, ² Unionist	1860-1863
William C. Cozzens (acting), Unionist	1863
James V. Smith, Republican	1863-1866
Ambrose E. Burnside, "	1866-1869
Seth Padelford, "	1869-1873
Henry Howard, "	1873-1875
Henry Lippitt, "	1875-1877
Charles C. Zanct, "	1877-1880
Alfred H. Littlefield, "	1880-1883
Augustus O. Bourne, "	1883-1885
George P. Wetmore, "	1885-1887
John W. Davis, Democrat, "	1887-1888
Royal C. Taft, Republican, "	1888-1889
Herbert W. Ladd, "	1889-1890
John W. Davis, Democrat	1890-1891
Herbert W. Ladd, Republican	1891-1892
D. Russell Brown, "	1892-1895
Charles W. Lippitt, "	1895-1897
Elisha Dyer, "	1897-1900
William Gregory, "	1900-1901
Charles Dean Kimball, Republican	1901-1903
L. F. C. Garin, Democrat	1903-1905
George H. Utter, Republican	1905-1907
James H. Higgins, Democrat	1907-1909
Aram J. Pothier, Republican	1909-

BIBLIOGRAPHY.—For general physical description see C. T. Jackson, *Report on the Geological and Agricultural Survey of Rhode Island* (Providence, 1840); N. S. Shaler, J. B. Woodworth, and A. F. Faering, *Geology of the Narragansett Basin* (Washington, 1890); and T. Nelson Dale, *The Chief Commercial Granites of Massachusetts, New Hampshire and Rhode Island* (Ibid., 1908), being Bulletin 354 of the U.S. Geological Survey. Administration:—The charters of 1644 and 1663 and the constitution of 1842 are all given in F. N. Thorpe, *Constitutions, Charters, and Organic Laws* (Washington, 1909), vol. vi. See also the annual reports of the treasurer, the auditor, the commissioner of public schools, the board of education, and the board of state charities and corrections; W. H. Tolman, *History of Higher Education in Rhode Island* (Washington, 1894); Henry Phillips, Jr., *Historical Sketches of the Paper Currency of the American Colonies* (2 vols., Roxbury, Mass., 1865-1866); Thomas Durfee, *Gleanings from the Judicial History of Rhode Island* (Providence, 1883); and the works of Field, Richman and Mowry (see History, Bibliography).

History.—For many years the standard authority on the period before the ratification of the constitution was S. G. Arnold, *History of Rhode Island, 1636-1790* (2 vols., New York, 1859-60, 4th ed., Providence, 1894). His work has, however, been partially superseded by I. B. Richman, *Rhode Island: Its Making and Meaning, 1636-1683* (2 vols., 1902), and *Rhode Island: A Study in Separatism* (Boston and New York, 1905). Edward Field (Editor), *State of Rhode Island and Providence Plantation at the end of the Century: A History* (3 vols., Boston, 1902), is valuable for the more recent history of the state. See also Adelos Gorton, *The Life and Times of Samuel Gorton* (Philadelphia, 1908); W. B. Weedon, *Early Rhode Island: A Social History of the People* (New York, 1910); F. G. Bates, *Rhode Island and the Formation of the Union* (New York, 1898); A. M. Mowry, *The Dorr War; or the Constitutional Struggle in Rhode Island* (Providence, 1901); *Records of the Colony of Rhode Island and Providence Plantation, 1636-1792* (10 vols., Providence, 1856-65); *Rhode Island Historical Society, Collections* (10 vols., to be continued, Providence, 1827-1902); *Proceedings and Publications*, 23 numbers (Providence, 1872-1902, to be continued). *The Quarterly* (8 vols., 1892-1901, discontinued); *Rhode Island Historical Tracts*, Series I., 20 vols. (Providence, 1877-1884), Series II., 5 vols. (Providence, 1880-96). For general bibliographies see J. R. Bartlett, *Bibliography of Rhode Island* (Providence, 1864); C. R. Brigham, in *Field*, III., pp. 651-81; and Richman, in *A Study in Separatism*, pp. 353-85.

¹ Jackson was a Liberation Whig—favouring the liberation of Dorr from prison—but he was elected on the Democratic ticket.

² Sprague was elected over the radical Republican candidate through a coalition of Democrats and conservative Republicans.

RHODES, CECIL JOHN (1853-1902), British colonial and Imperial statesman, was born on the 5th of July 1853, at Bishop Stortford, in Hertfordshire. His father was a clergyman, but he claimed descent from yeoman stock. Cecil John Rhodes was the fifth son in a large family of sons and daughters. At the time of his birth his father held the living of Bishop Stortford. The boy was educated at Bishop Stortford grammar school with the intention of preparing for the Church; but at the age of sixteen his health broke down, and in the latter part of 1870 he was sent to join an elder brother, then engaged in farming in Natal. In that year diamonds were discovered in the Kimberley fields. By the end of 1871 Mr Rhodes and his brother were among the successful diggers. The dry air of the interior restored Mr Rhodes's health, and before he was nineteen he found himself financially independent, physically strong and free to devote his life to any object which commended itself to his choice.

Rhodes has left behind him an interesting record of the manner in which he was affected by the situation. He determined to return to England, and to complete his education by reading for a degree at Oxford; but before doing so, he spent eight months in a solitary journey through the then little known parts of the country lying to the north of the Orange and Vaal rivers. He went through Bechuanaland to Mafeking, thence to Pretoria, Murchison, Middelburg and back through the Transvaal to Kimberley. The journey, made in an ox-wagon at a rate of progression of some 15 to 20 miles a day, represented a walking tour of eight months through the vast spaces of rolling veld which at that time filled those regions of Southern Africa. He saw one of the healthiest countries in the world barely occupied. He knew the agricultural possibilities of Natal. He knew its mineral wealth. The effect of the combined influences on his mind, in the circumstances in which he found himself, was profound. The idea took passionate possession of him that the fine country through which he moved ought to be secured for occupation by the British race, and that no power but Great Britain should be allowed to dominate in the administration of South Africa. When he brought his self-imposed pilgrimage to an end, he had found an object to which he proposed to devote his life. It was nothing less than the governance of the world by the British race. A will exists written in Mr Rhodes's own handwriting a couple of years later, when he was still only twenty-two, in which he states his reasons for accepting the aggrandizement and service of the British empire as his highest ideal of practical achievement. It ends with a single bequest of everything of which he might die possessed, for the furtherance of this great purpose. Five-and-twenty years later his final will carried out, with some difference of detail, the same intention.

The share which he allotted to himself in the general scheme was the extension of the area of British settlement in Africa, but he did not attempt to address himself immediately to public work. He returned, in accordance with his first resolve, to Oxford, where he matriculated at Oriel. In 1873 his health again failed, and he was sent back to South Africa under what was practically a death sentence. Years afterwards he saw the entry of his own case in the diary of the eminent physician whom he consulted, with a note, "Not six months to live." South Africa again restored him to health. Three years later he was back at Oxford, and from 1876 to 1878 he kept his terms. During this period he spent the Long Vacation each year in South Africa, where his large financial interests were daily increasing in importance. He was a member of the Cape ministry when, after a further lapse of years, he kept his last term and took his degree. He did not read hard at Oxford, and was more than once remonstrated with in the earlier terms for non-attendance at lectures. But he passed his examinations; and though he was never a student in the university sense of the term, he was to the end of his life a keen devourer of books. He kept always a special liking for certain classic authors. Aristotle was the guide whom as a lad he followed in seeking the "highest object" on which to exercise the

"highest activity of the soul." Marcus Aurelius was his constant companion. There exists at Grote Schuur a copy of the *Meditations* deeply scored with Mr Rhodes's marks.

During this Oxford time, and on to 1881, Mr Rhodes was occupied with the amalgamation of the larger number of the diamond mines of Kimberley with the De Beers Company, an operation which established his position as a practical financier and gave him an important connexion and following in the business world. To many admirers who shared his ideas on public questions his connexion with the financial world and his practical success were a stumbling-block. It was often wished for him that he had "kept himself clear of all that." But this was not his own view. His ideals were political and practical. To him the making of money was a necessary preliminary to their realization, and he was proud of his practical ability in this direction. He was personally a man of most simple tastes. His immense fortune was spent in the execution of his ideals, and it has been justly said of him that he taught the world a new chapter of the romance of wealth.

In 1881 Mr Rhodes entered public life as a member of the Cape assembly. It was the year of the Majuba settlement. South Africa was convulsed with questions which had arisen between the British and the Dutch, and leaders of Dutch opinion at the Cape ventured to speak openly of the formation of a United States of South Africa under its own flag. The British party needed a rallying-ground, and Mr Rhodes took his stand on a policy of local union combined with the consolidation and expansion of Imperial interests. He offered to Dutch and British alike the ideal of a South African Federation governing itself within the empire, and extending, by its gradual absorption of native territories, the range of Imperial administration. Local self-government was, in his opinion, the only enduring basis on which the unity of the empire could be built, and throughout his life he was as keen a defender of local rights as he was of Imperial unity. There was a period somewhat later in his career when this attitude on his part gave rise to a good deal of misapprehension, and his advocacy of the elimination of direct Imperial interference in local affairs caused him to be viewed in certain quarters with suspicion as a Separatist and Independent. Those who were inclined to take this view were greatly strengthened in their suspicions by the fact that at a critical moment in the struggle for Home Rule in Ireland Mr Rhodes contributed £10,000 to the funds of the Separatist party. The subsequent publication of his correspondence on the subject with Mr Parnell, who was at that time leading the Home Rule party, demonstrated, however, the essential fact that, whatever might have been the secret intentions of the extreme Irish Home Rulers, Mr Rhodes's contribution was made strictly subject to the retention of the Irish members at Westminster. He remained of the opinion that the Home Rule movement, wisely treated, would have had a consolidating and not a disruptive effect upon the organization of the empire.

In South Africa the influence which he acquired over the local independents and over the Dutch vote was subsequently an important factor in enabling him to carry out the scheme of northern expansion which he had at heart, and which he had fully developed in his own mind at Oxford in 1878. In 1881 the Bechuana territory was a sort of no man's land through which ran the trade routes to the north. It was evident that any power which commanded the trade routes would command the unknown northern territory beyond. The Pretoria Convention of 1881 limited the westward extension of the Transvaal to a line east of the trade routes. Nevertheless, the reconstituted republic showed itself anxious to encroach by irregular overflow into native territories, and Mr Rhodes feared to see the extension of the British colonies permanently blocked by Dutch occupation. One of his first acts as a member of the Cape assembly was to urge the appointment of a delimitation commission. He served in person on the commission, and obtained from the chief Mankoroane, who claimed about half of Bechuanaaland, a formal cession of his territories to the British government of the Cape. The Cape government refused to accept the offer. In February

1884 a second convention signed in London again defined the western frontier of the Transvaal, Bechuanaaland being left outside the republic. With the consent of Great Britain, Germany had occupied, almost at the same time, the territory on the Atlantic coast now known as German South-West Africa. In August 1884 Mr Rhodes was appointed resident deputy commissioner in Bechuanaaland, where, notwithstanding the conventions to the contrary, Boers had ousted the natives from considerable areas and set up the so-called republics of Goshen and Stellaland. An old Dutchman who knew the value of the position said privately to Mr Rhodes, "This is the key of South Africa." The question at issue was whether Great Britain or the Transvaal was to hold the key. It was a question about which at that time the British public knew nothing and cared nothing. Mr Rhodes made it his business to enlighten them. President Kruger, speaking for the government of the Transvaal, professed to regard the Dutch commandoes as freebooters, and to be unable to control them. It devolved upon Great Britain to oblige them to evacuate the territory. Largely as the result of Mr Rhodes's exertions the necessary step was taken. The Warren expedition of 1884-85 was sent out. In the presence of British troops upon the frontier President Kruger recovered his controlling power over the Transvaal burghers, and without any fighting the commandoes were withdrawn. Thereupon southern Bechuanaaland was declared to be British territory, while a British protectorate was declared over the northern regions up to the 22nd parallel (September 1885).

It was the first round in the long duel fought on the field of South Africa between Mr Rhodes, as the representative of British interests, and President Kruger, as the head of the militant Dutch party. The score on this occasion was to Mr Rhodes, and the entrance to the interior was secured. But the 22nd parallel was far short of the limits to which Mr Rhodes hoped to see British influence extend, and he feared lest Germany and the Transvaal might yet join hands in the native territory beyond, and bar his farther progress towards the north. The discovery of gold on the Witwatersrand in 1886, by adding to the wealth and importance of the Transvaal, gave substance to this fear.

The territory to the north of the 22nd parallel was at that time under the domination of Lobengula, chief of the Matabele, a native potentate celebrated alike for his ability and for the despotic character of his rule. There were rumours of Dutch and German emissaries at the kraal of Lobengula, engaged in persuading that chief to cede certain portions of his territory. Portugal also was putting forward shadowy claims to the country. It was in these circumstances that Mr Rhodes conceived the idea of forming a British Chartered Company, which should occupy the territory for trading and mining purposes as far as the Zambezi, and bring the whole under the protection of Great Britain. The idea took shape in 1887, in which year Mr Rhodes's first emissaries were sent to Lobengula. The charter of the British South Africa Company was granted in October 1889. Between the two dates his conception of the possibilities to be achieved by the Company had expanded. Mr Rhodes no longer limited the sphere of his operations to the Zambezi, but, crossing the river at the back of the Portuguese settlements at its mouth, he obtained permission to extend the territories of the Chartered Company to the southern end of Lake Tanganyika, including within the sphere of its operations the British settlements already made in Nyasaland. He hoped to go farther still, and to create a connected chain of British possessions through the continent which might eventually justify the description, "Africa British from the Cape to Cairo." The treaty negotiated between Great Britain and Germany in 1890 extended the German sphere of influence from the East Coast to the frontier of the Congo Free State, and defeated this hope. But Mr Rhodes did not wholly renounce the idea. In 1892, when the question of the retention or abandonment of Uganda hung in the balance at home, he threw all the weight of his influence into the scale of retention, and undertook at his own personal expense to connect

that territory by telegraph with British possessions in the south. In the following year, 1893, it was found inevitable to fight the Matabele, and a war, prosecuted with a success that is perhaps unique of its kind, placed the country entirely in British hands. The territory thus added to the British empire covered an extent of 450,000 square miles, of which large portions consist of healthy uplands suitable for white colonization. The pioneer party who constructed the first road and founded the first British stations in the country received their orders to cross the frontier in the end of 1889. By the end of 1899, before the outbreak of the South African War, though the country had passed through the trial of a war, two native rebellions, and the scourge of rinderpest, it had become, under the name of Rhodesia, a well-settled province of the British empire, with a white population of some 12,000 to 13,000 persons.

The six years which followed the granting of the charter may be regarded as the most successful of a singularly successful life. In 1890, not many months after the granting of the charter, Mr Rhodes accepted the position of prime minister of the Cape. He was maintained in power very largely by the Dutch vote, which he spared no pains to conciliate; and having the confidence of both political sections of the colony, he found himself practically in a position to play the part of benevolent despot in South Africa. He used the position well so far as the public was concerned. While his scheme of northern expansion was making the rapid progress which has been indicated, he did much to elevate and to enlarge the field of local politics. He frankly declared and worked for the policy of uniting British and Dutch interests in South Africa; he took a keen interest in local education. He also during this period carried through some important reforms in native policy. He had the courage to restrict the franchise, introducing an educational test and limiting the exercise of voting power to men enjoying an income equal to a labourer's wage—thus abolishing, without making any distinction of colour, the abuses of what was known as the "blanket" vote.

But his native policy was far from being one of simple restriction. He liked the natives; he employed them by thousands in the mining industry, he kept native servants habitually about his person he seemed to understand their peculiarities and was singularly successful in dealing with them. The first canon of his native policy was that liquor should be kept from them; the second, that they should be encouraged to labour, and guaranteed the full possession of their earnings; the third, that they should be educated in the practical arts of peace. He appreciated the full importance of raising their territorial condition from one of tribal to individual tenure; and while he protested against the absurdity of permitting the uncivilized Kaffir to vote on questions of highly civilized white policy, he believed in applying to the native for his own native affairs the principle of self-government. Of these views some received practical embodiment in the much-disputed act known as the Glen Grey Act of 1894. In this connexion it may also be noted that he was one of the warmest and most convinced supporters of Lovedale, the very successful missionary institution for the education of natives in South Africa.

The position of benevolent despot has obvious drawbacks. In Mr Rhodes's case the dependence which the populations of Cape Colony were led to place on him had its reaction on the public in a demoralizing loss of self-reliance, and for himself it must be admitted that the effect on the character of a man already much disposed to habits of absolutism in thought and action was the reverse of beneficial. Mr Rhodes felt himself to be far stronger than any man in his own surroundings; he knew himself to be actuated by disinterested motives in the aims which he most earnestly desired to reach. He was profoundly impressed by a sense of the shortness of life, and he so far abused his power as to become intolerant of any sort of control or opposition. The inevitable result followed, that though Mr Rhodes did much of great and good work during the six years of his supreme power, he entirely failed during that period to surround himself, as he might have done, by a circle of able men fit to comprehend and to carry on the work

to which his own best efforts were directed. To work with him was practically impossible for those who were not willing to accept without demur the yoke of dogmatic authority. He had a few devoted personal friends, who appreciated his aims and were inspired by his example; but he was lacking in regard for individuals, and a great part of his daily life was spent in the company of satellites and instruments, whom he used with cynical unconcern for the furtherance of his ends.

In 1896 the brilliant period of his premiership was brought to an end by the incident which became famous under the name of the Jameson Raid. The circumstances which led to the Raid belong properly to the history of the Transvaal. It is enough to say briefly here that the large alien population which had been attracted to the Transvaal by the phenomenal wealth of the Johannesburg goldfields, conceiving themselves to have reason to revolt against the authority of the Transvaal government, resolved towards the end of 1895 to have recourse to arms in order to obtain certain reforms. Mr Rhodes, as a large mine-owner, was theoretically a member of the mining population. In this capacity he was asked to give his countenance to the movement. But as prime minister of a British colony he was evidently placed in a false position from the moment in which he became cognizant of a secret attempt to overturn a neighbouring government by force of arms. He did more than become cognizant. The subsequent finding of a Cape committee, which he accepted as accurate, was to the effect that "in his capacity as controller of the three great joint-stock companies, the British South Africa Company, the De Beers Consolidated Mines, and the Gold Fields of South Africa, he directed and controlled the combination which rendered such a proceeding as the Jameson Raid possible." He gave money, arms and influence to the movement; and as the time fixed for the outbreak of the revolution approached, he allowed Dr Jameson, who was then administrator of the British South Africa Company in Rhodesia, to move an armed force of some 500 men upon the frontier. Here Mr Rhodes's participation in the movement came to an end. It became abundantly clear from subsequent inquiry that he was not personally responsible for what followed. A cipher correspondence, seized and published by the Boers, left the civilized world in no doubt as to Mr Rhodes's share in the previous preparation, and he was for a time believed to be responsible for the Raid itself. Subsequent inquiries held by committees of the Cape parliament and of the British House of Commons acquitted him entirely of responsibility for Dr Jameson's final movement, but both committees found that he had acted in a manner which was inconsistent with his duty as prime minister of the Cape and managing director of the British South Africa Company.

He displayed, in the circumstances, characteristic qualities of luck and candour. He made no concealment of his own share in the catastrophe; he took full responsibility for what had been done in his name by subordinates, and he accepted all the consequences which ensued. He resigned his premiership of the Cape (January 1896); and, recognizing that his presence was no longer useful in the colony, he turned his attention to Rhodesia. His design was to live in that country, and to give all the stimulus of his own presence and encouragement to the development of its resources. The Matabele rebellion of March 1896 intervened to prevent the immediate realization of his plans. In June Imperial troops were sent up, and by the end of July the result of the military operations had driven the natives to the Matoppo Hills, where they held a practically impregnable position. The prospect was of continued war, with a renewal of a costly campaign in the following year. Mr Rhodes conceived the idea that he might effect single-handed the pacification which military skill had failed to compel. To succeed, it was essential that he should trust and be trusted. He accordingly moved his tent away from the troops to the base of the Matoppo Hills. He lay there quietly for six weeks, in the power of the enemy if they had chosen to attack. Word was circulated among the natives

that he had come alone and undefended to hear their side of the case. A council was held by them in the very depths of the hills, where no armed force could touch them. He was invited to attend it. It was a case of staking his life on trust. He displayed no hesitation, but mounted and rode unarmed with the messenger. Three friends rode with him. The confidence was justified. They met the assembled chiefs at the place appointed. The native grievances were laid before Mr Rhodes. At the end of a long discussion Mr Rhodes, having made and exacted such concessions as he thought fit, asked the question, "Now, for the future is it peace or is it war?" And the chiefs, laying down their sticks as a symbol of surrendered arms, declared, "We give you one word: it is peace." The scene, as described by one of the eye-witnesses, was very striking. Mr Rhodes, riding away, characterized it simply as "one of the scenes which make life worth living."

His life was drawing towards its end. He had still a few years, which he devoted with success to the development of the country which bore his name. The railway was brought to Bulawayo, and arrangements were made for carrying the line on in sections as far as the south end of Lake Tanganyika, a construction which was part of his pet scheme for connecting the Cape by a British line of communication with Cairo. He also concluded arrangements for carrying a telegraphic land line through to Egypt, and had the satisfaction of seeing the mineral development of the country fairly started. But the federal union of South Africa, to which he had always worked as the secure basis of the extension of British rule in the southern half of the continent, was not for him to see. The South African War broke out in 1899. Mr Rhodes took his part at Kimberley in sustaining the hardships of a siege; but his health was broken, and though he lived to see victory practically assured to British arms, peace had not been concluded when, on the 26th of March 1902, he died at Muizenberg, near Cape Town.

His life's work did not end actually with his death. He left behind him a will in which he dedicated his fortunes, as he had dedicated himself, exclusively to the public service. He left the bulk of his vast wealth for the purpose of founding scholarships at Oxford of the value each of £300 a year, to be held by students from every important British colony, and from every state and Territory of the United States of America. The sum so bequeathed was very large; but it was not for the munificence of the legacy that the will was received with acclamation throughout the civilized world: it was for the striking manifestation of faith which it embodied in the principles that make for the enlightenment and peace and union of mankind, and for the fine constancy of Mr Rhodes's conviction that the unity of the British Empire, which he had been proud to serve, was among the greatest of organized forces uniting for universal good. The will was drawn up some years before his death. A codicil, signed during the last days of his life, gave evidence of some enlargement of his views as to the association of races necessary in order to secure the peace of the world, and added to the original scheme a certain number of scholarships to be held at the disposal of German students.

The publication of the will silenced Mr Rhodes's detractors and converted many of his critics. It set a seal which could not be mistaken upon his completed life. The revulsion of sentiment towards him was complete, and his name passed at once in the public estimation to the place which it is probably destined to take in history, as one which his countrymen are proud to count among the great makers of the British Empire.

See the *Life* by Sir Lewis Michell (2 vols., London, 1910); consult also Sir T. E. Fuller, *Cecil John Rhodes: A Monograph and a Reminiscence* (London, 1910), and "Vindex," *Cecil Rhodes: His Political Life and Speeches* (London, 1900).

(F. L. L.)

The Rhodes Scholarships.—The scholarship system founded by the will of Cecil Rhodes provides in perpetuity for the support at Oxford, for a term of three years each, of about 175 selected scholars. Each scholar from the colonies and the United States has an allowance of £300 per annum during

the continuance of his scholarship; those from Germany, as being nearer to Oxford, an allowance of £250 each. In each province of Canada, in each state of Australia, in the four collegiate schools of Cape Colony (Rondebosch, Stellenbosch, South African College, and St Andrew's College, Grahamstown), in the dominion of New Zealand, and in the colonies of Natal, Jamaica, Bermuda and Newfoundland, a scholar is elected each year. Three scholarships annually are assigned to Rhodesia. Each state and Territory of the American Union is entitled to have two scholars in residence, so that an election takes place in two years out of three. Five scholarships are provided annually for scholars from Germany.

In his will Rhodes mentions the objects he had in view in founding the different scholarships:—

1. *Colonial.*—"I consider that the education of young colonists at one of the universities in the United Kingdom is of great advantage to them for giving breadth to their views, for their instruction in life and manners, and for instilling into their minds the advantage to the colonies as well as to the United Kingdom of the retention of the unity of the empire."

2. *American.*—"I also desire to encourage and foster an appreciation of the advantages which I implicitly believe will result from the union of the English-speaking people throughout the world, and to encourage in the students from the United States of North America who will benefit from the American scholarships to be established for the reason above given at the university of Oxford under this my will an attachment to the country from which they have sprung, but without, I hope, withdrawing them or their sympathies from the land of their adoption or birth."

3. *German.*—"I note the German emperor has made instruction in English compulsory in German schools. I leave five yearly scholarships at Oxford of £250 per annum to students of German birth, the scholars to be nominated by the German emperor for the time being. Each scholarship to continue for three years, so that each year after the first three there will be fifteen scholars. The object is that an understanding between the three Great Powers will render war impossible and educational relations make the strongest tie."

He defines as follows the principles on which he wished his scholars to be selected:—

"My desire being that the students who shall be elected to the scholarships shall not be merely bookworms, I direct that in the election of a student to a scholarship regard shall be had to (1) his literary and scholastic attainments; (2) his fondness for and success in, mainly outdoor sports such as cricket, football and the like; (3) his qualities of manhood, truth, courage, devotion to duty, sympathy for and protection of the weak, kindness, unselfishness and fellowship; and (4) his exhibition during school days of moral force of character and of instincts to lead and to take an interest in his schoolmates, for those latter attributes will be likely in after life to guide him to esteem the performance of public duties as his highest aim."

The trustees named in the will for the management of the trust were Lord Rosebery, Lord Grey, Lord Milner, Sir Lewis Michell, Dr L. S. Jameson, Mr Alfred Beit and Mr Bouchier F. Hawksley.

After consultation with the educational authorities of all the communities to which scholarships are assigned, the trustees arranged a system for the selection of scholars. This system, which is subject to such changes as experience suggests, may be summarized as follows. Every candidate, in order to become eligible, is required to pass the Responsions examination of the university of Oxford, or some examination accepted by the university as an equivalent.

In the case of communities possessing universities or colleges in affiliation with Oxford, a certain standing at those universities is accepted in lieu of Responsions. Examinations are held in two years out of three in each state of the American Union, and annually in colonies which do not have the affiliated universities or colleges referred to. German scholars are nominated by his majesty the emperor of Germany. Candidates must be unmarried—must be between the ages of 19 and 25 in Jamaica and Queensland, 18–25 in Newfoundland, 18–21; in Western Australia, 17–25), and they must be, in the colonies, British subjects—in the United States and Germany, subjects of those countries. In each British colony electing scholars and in each state of the Union there is a committee of selection, composed commonly of leading educational authorities or high public officials. To these committees all candidates who have passed the qualifying tests submit their claims. The committees are entrusted with the power of selection, but are expected to exercise this power as closely as circumstances permit, in accordance with the suggestions made by Rhodes. The trust arranges for the distribution of elected scholars among the colleges of Oxford, each of which has agreed to receive a limited number of approved candidates. (G. R. P.)

RHODES, JAMES FORD (1848–), American historian, was born in Cleveland, Ohio, on the 1st of May 1848. He

entered the university of New York as a special student in 1865, studied at the university of Chicago in 1866-67, and at the Collège de France in 1867-68, and in 1868 served as occasional Paris correspondent to the *Chicago Times*. He then took a course in metallurgy in the School of Mines, at Berlin; subsequently inspected iron and steel works in western Germany and in Great Britain; and in 1870 joined his father in the iron, steel and coal business in Cleveland, becoming a member of the firm in 1874. He retired from business with an ample fortune in 1885, and after two years devoted to general reading and travel he began his *History of the United States from the Compromise of 1850*, which, closing the narrative with the year 1877, was published in seven volumes in 1893-1906. In recognition of the merit of his work he received honorary degrees from various American universities, was elected president of the American Historical Association in 1899, and received the Loubat prize of the Berlin Academy of Sciences in 1901. In 1909 he published a volume of *Historical Essays*.

RHODES, the most easterly of the islands of the Aegean Sea, about 10 m. S. of Cape Alypo in Asia Minor. It forms, with the islands of Syme, Casos, Carpathos, Castelorzio, Telos and Charki, one of the four sanjaks into which the Archipelago vilayet of Turkey is divided. The governor-general of the vilayet resides at the town of Rhodes. The length of the island is about 45 m. from N.E. to S.W., its greatest breadth 22 m., and its area nearly 424 sq. m. The population of the island comprises 7000 Moslems, 21,000 Christians, and 2000 Jews.

The island is diversified in its surface, and is traversed from north to south by an elevated mountain range, the highest point of which is called Atairo (anc. *Atabyris* or *Atabyrium*) (4560 ft.). It commands a view of the elevated coast of Asia Minor towards the north, and of the Archipelago, studded with its numerous islands, on the north-west; while on the south-west is seen Mount Ida in Crete, often veiled in clouds, and on the south and south-east the vast expanse of waters which wash the African shore. The rest of the island is occupied in great part by ranges of moderately elevated hills, on which are found extensive woods of ancient pines, planted by the hand of nature. These forests were formerly very thick, but they are now greatly thinned by the Turks, who cut them down and take no care to plant others in their place. Beneath these hills the surface of the island falls lower, and several hills in the form of amphitheatres extend their bases as far as the sea.

Rhodes was famed in ancient times for its delightful climate, and it still maintains its former reputation. The winds are liable to little variation; they blow from the west, often with great violence, for nine months in the year, and at other times from the north; and they moderate the summer heats, which are chiefly felt during the months of July and August, when the hot winds blow from the coast of Anatolia.

Rhodes, in addition to its fine climate, is blessed with a fertile soil, and produces a variety of the finest fruits and vegetables. Around the villages are extensive cultivated fields and orchards, containing fig, pomegranate and orange trees. On the sloping hills carob trees, and others both useful and agreeable, still grow abundantly; the vine also holds its place, and produces a species of wine which was highly valued by the ancients, though it seems to have degenerated greatly in modern times. The valleys afford rich pastures, and the plains produce every species of grain.

The commerce of the island has been of late years increasing at a rapid rate. Many British manufactures are imported by indirect routes, through Smyrna, Constantinople, Beyrout and other places. Cotton stuffs, calicoes and grey linen are among the goods most in demand; they are exported to the neighbouring coast of Anatolia, between Budrum and Adalia, and thence conveyed into the interior. The expansion of the trade has been very much owing to the establishment of steam navigation direct to the island, which is now visited

regularly by French and Austrian steamers, as well as by some from England to Smyrna.

The only town of any importance in the island is the capital, Rhodes, which stands at the north-east extremity. It rises in an imposing manner from the sea, on a gentle slope in the form of an amphitheatre. It is surrounded with walls and towers, and defended by a large moated castle of great strength. These fortifications are all the work of the Knights of St John. The interior of the city does not correspond to its outward appearance. No trace exists of the splendour of the ancient city, with its regular streets, well-ordered plan and numerous public buildings. The modern city of Rhodes is in general the work of the Knights of St John, and has altogether a mediæval aspect. The picturesque fortifications also by which the city is surrounded remain almost unaltered as they were in the 15th century. The principal buildings which remain are the church of St John, which is become the principal mosque; the hospital, which has been transformed into public granaries; the palace of the grand master, now the residence of the pasha; and the senate-house, which still contains some marbles and ancient columns. Of the streets, the best and widest is a long street which is still called the Street of the Knights. It is perfectly straight, and formed of old houses, on which remain the armorial bearings of the members of the order. On some of these buildings are still seen the arms of the popes and of some of the royal and noble houses of Europe.

The only relics of classical antiquity are the numerous inscribed altars and bases of statues, as well as architectural fragments, which are found scattered in the courtyards and gardens of the houses in the extensive suburbs which now surround the town, the whole of which were comprised within the limits of the ancient city. The foundations also of the moles that separate the harbours are of Hellenic work, though the existing moles were erected by the Knights of St John.

Rhodes has two harbours. The lesser of these lies towards the east, and its entrance is obstructed by a barrier of rocks, so as to admit the entrance of but one ship at a time. It is sufficiently sheltered, but by the negligence of the Turks the sand has been suffered to accumulate until it has been gradually almost choked up. The other harbour is larger, and also in a bad condition; here small ships may anchor, and are sheltered from the west winds, though they are exposed to the north and north-east winds. The two harbours are separated by a mole which runs obliquely into the sea. At the eastern entrance is the fort of St Elmo, with a lighthouse.

History.—It is as yet difficult to determine the part which Rhodes played in prehistoric days during the naval predominance of the neighbouring island of Crete; but archaeological remains dating from the later Minoan age prove that the early Aegean culture maintained itself there comparatively unimpaired until the historic period. A similar conclusion may be drawn from the legend which peopled primitive Rhodes with a population of skilful workers in metal, the "Telchines." Whatever the racial affinities of the early inhabitants may have been, it is certain that in historic times Rhodes was occupied by a Dorian population, reputed to have emigrated mainly from Argos subsequently to the "Dorian invasion" of Greece. The three cities founded by these settlers—Lindus, Ialysus and Camirus—belonged to the "League of Six Cities," by which the Dorian colonists in Asia Minor sought to protect themselves against the barbarians of the neighbouring mainland. The early history of these towns is a record of brisk commercial expansion and active colonization. The position of Rhodes as a distributing centre of Levantine and especially of Phoenician goods is well attested by archaeological finds. Its colonies extended not only eastward along the southern coast of Asia Minor, but also linked up the island with the westernmost parts of the Greek world. Among such settlements may be mentioned Phaselis in Lycia, perhaps also Soli in Cilicia, Salapia on the east Italian coast, Gela in Sicily, the Lipari islands, and Rhoda in north-east Spain. In home waters the Rhodians exercised political control over Carpathos and other islands.

The history of Rhodes during the Persian wars is quite obscure. In the 5th century the three cities were enrolled in the Delian League, and democracies became prevalent. In 412 the island revolted from Athens and became the headquarters of the Peloponnesian fleet. Four years later the inhabitants for the most part abandoned their former residences and concentrated in the newly founded city of Rhodes. This town, which was laid out on an exceptionally fine site according to a scientific plan by the architect Hippodamus of Miletus, soon rose to considerable importance, and attracted much of the Aegean and Levantine commerce which had hitherto been in Athenian hands. In the 4th century its political development was arrested by constant struggles between oligarchs and democrats, who in turn brought the city under the control of Sparta (412-395, 391-378), of Athens (395-391, 378-357), and of the Carian dynasty of Maussollus (357-340). It seems that about 340 the island was conquered for the Persian king by his Rhodian admiral Mentor; in 332 it submitted to Alexander the Great. Upon Alexander's death the people expelled their Macedonian garrison, and henceforth not only maintained their independence but acquired great political influence. The expansion of Levantine trade which ensued in the Hellenistic age brought especial profit to Rhodes, whose standard of coinage and maritime law became widely accepted in the Mediterranean. Under a modified type of democracy, in which the chief power would seem to have rested normally with the six *πρωτάρεις*, or heads of the executive, the city enjoyed a long period of remarkably good administration. The chief success of the government lay in the field of foreign politics, where it prudently avoided entanglement in the ambitious schemes of Hellenistic monarchs, but gained great prestige by energetic interference against aggressors who threatened the existing balance of power or the security of the seas. The chief incidents of Rhodian history during this period are a memorable siege by Demetrius Poliorcetes in 304, who sought in vain to force the city into active alliance with King Antigonos by means of his formidable fleet and artillery; a severe earthquake in 227, the damages of which all the other Hellenistic states contributed to repair, because they could not afford to see the island ruined; some vigorous campaigns against Byzantium, the Pergamene and the Pontic kings, who had threatened the Black Sea trade-route (220 sqq.), and against the pirates of Crete. In accordance with their settled policy the Rhodians eagerly supported the Romans when these made war upon Philip V. of Macedon and Antiochus III. of Syria on behalf of the minor Greek states. In return for their more equivocal attitude during the Third Macedonian War they were deprived by Rome of some possessions in Lycia, and damaged by the partial diversion of their trade to Delos (167). Nevertheless during the two Mithradatic wars they remained loyal to the republic, and in 88 successfully stood a siege by the Pontic king. The Rhodian navy, which had distinguished itself in most of these wars, did further good service on behalf of Pompey in his campaigns against the pirates and against Julius Caesar. A severe blow was struck against the city in 43 by C. Cassius, who besieged and ruthlessly plundered the people for refusing to submit to his exactions. Though Rhodes continued a free town for another century, its commercial prosperity was crippled and a series of extensive earthquakes after A.D. 155 completed the ruin of the city.

In the days of its greatest power Rhodes became famous as a centre of pictorial and plastic art; it gave rise to a school of eclectic oratory whose chief representative was Apollonius Molon, the teacher of Cicero; it was the birthplace of the Stoic philosopher Panaetius; the home of the poet Apollonius Rhodius and the historian Posidonius. Protagoras embellished the city with his paintings, and Chares of Lindus with the celebrated colossal statue of the sun-god, which was 105 ft. high. The colossal stood for fifty-six years, till an earthquake prostrated it in 224 B.C. Its enormous fragments continued to excite wonder in the time of Pliny, and were not removed till A.D. 656, when Rhodes was conquered by the Saracens, who sold the remains for old metal to a dealer, who employed nine hundred camels to carry them away. The notion that the colossal once stood astride over the entrance to the harbour is a medieval fiction. During the later Roman empire Rhodes was the capital of the province of the islands. Its

history under the Byzantine rule is uneventful, but for some temporary occupations by the Saracens (653-658, 717-718), and the gradual encroachment of Venetian traders since 1082. In the 13th century the island stood as a rule under the control of Italian adventurers, who were, however, at times compelled to acknowledge the overlordship of the emperors of Nicea, and failed to protect it against the depredations of Turkish corsairs. In 1309 it was conquered by the Knights Hospitallers of St. John of Jerusalem at the instigation of the pope and the Genoese, and converted into a great fortress for the protection of the southern seas against the Turks. Under their mild and just rule both the native Greeks and the Italian residents were able to carry on a brisk trade. But the piratical acts of these traders, in which the knights themselves sometimes joined, and the strategic position of the island between Constantinople and the Levant, necessitated its reduction by the Ottoman sultans. A siege in 1480 by Mahomet II. led to the repulse of the Turks with severe losses; after a second investment, during which Sultan Suleiman I. is said to have lost 90,000 men out of a force of 200,000, the knights evacuated Rhodes under an honourable capitulation (1522). The population henceforth dwindled in consequence of pestilence and emigration, and although the island recovered somewhat in the 18th century under a comparatively lenient rule it was brought to a very low ebb owing to the severity of its governor during the Greek revolution. The sites of Lindus, Ialysus, and Camirus, which in the most ancient times were the principal towns of the island, are clearly marked, and the first of the three is still occupied by a small town with a medieval castle, both of them dating from the time of the knights, though the case of Camirus is the site of the ancient acropolis, the walls of which considerable remains are still visible. There are no ruins of any importance on the site of either Ialysus or Camirus, but excavations at the latter place have produced valuable and interesting results in the way of ancient vases and other antiquities, which are now in the British Museum. Rhodes was again famous for its pottery in medieval times; this was a lustre ware at first imitated from Persian, though it afterwards developed into an independent style of fine colouring and rich variety of design.

See Pindar, *7th Olympian Ode*; Diodorus v. 55-59, xiii-xx, *passim*; Polybius iv. 46-52, v. 88-90, xvi. 2-9, xvii-xxix, *passim*; C. Torr, *Rhodes in Ancient Times* (Cambridge, 1882); *Rhodes in Modern Times* (Cambridge, 1887); C. Schumacher, *De republica Rhodiorum commentatio* (Heidelberg, 1886); V. van Gelder, *Geschiede der alten Rhodier* (Hague, 1900); B. H. Head, *Historia Numorum* (Oxford, 1887), pp. 539-542; and Baron de Balabre, *Rhodes of the Knights* (1909).

(E. H. B.; E. Gr.; M. O. B. C.)

RHODESIA (so named after Cecil Rhodes), an inland country and British possession in South Central Africa, bounded S. and S.W. by the Transvaal, the Bechuanaland Protectorate and German South-West Africa; W. by Portuguese West Africa. N.W. by Belgian Congo; N.E. by German East Africa; E. by the British Nyasaland Protectorate and Portuguese East Africa. It covers an area of about 450,000 sq. m., being larger than France, Germany and the Low Countries combined. It is divided into two parts of unequal size by the middle course of the Zambezi.

Southern Rhodesia, with an area of 148,575 sq. m., consists of Matabeleland and Mashonaland, the western and eastern provinces, while the trans-Zambezi regions are divided into North-Western Rhodesia (or Barotseland) and North-Eastern Rhodesia.

Physical Features.—Rhodesia forms part of the high tableland which constitutes the interior of Africa south of the Congo basin. Hydrographically the greater part of the country belongs to the basin of the Zambezi (*q.v.*), but in the N.E. it includes the eastern headstreams of the Congo, and in the S. and S.E. it is drained by the tributaries of the Limpopo, the Sabi and the Pungwe. The Limpopo forms the boundary between Southern Rhodesia and the Transvaal. The north-western regions, drained by the upper Zambezi and its affluents, are described under BAROTSELAND, and North-Eastern Rhodesia, together with the adjacent Nyasaland Protectorate, under BRITISH CENTRAL AFRICA. The highest portion of the tableland of Southern Rhodesia runs from the S.W. to the N.E. and forms a broad watershed between the tributaries of the Zambezi flowing north and the rivers flowing south and east. It is along this high plateau that the railway runs from Bulawayo to Salisbury and onwards to Portuguese East Africa. The elevation of the railway varies from 4500 ft. to 5500 ft. There is a gradual sloping away of the plateau to the N.W. and S.E., so

that only a small portion of Southern Rhodesia is under 3000 ft. The eastern boundary, along Portuguese East Africa, forms the edge of the tableland; the height of the edge is accentuated by a series of ridges, so that the country here assumes a mountainous appearance, the grass-clad heights being reminiscent of the Cheviot Hills of Scotland or the lower Alps of Switzerland.

Geology.—The geology of this region is very imperfectly known. Metamorphic rocks extend over immense areas, but these and the other formations are to a great extent hidden beneath superficial deposits. Conglomerates and banded ironstone rocks are found in the metamorphic areas around Bulawayo and the borders of Katanga; but to what extent these represent the different formations older than the Karroo and newer than the Swaziland schists (see TRANSVAAL) has not been satisfactorily determined. Certain gold-bearing conglomerates are regarded as the equivalents of the Witwatersrand series, but the main sources of gold are the veins of quartz and igneous rocks developed in the metamorphic series. The Karroo formation is well represented, and covers extensive areas in the Zambezi basin. The Dwyka conglomerate

Climate.—As Southern Rhodesia extends between 16° S. and 22° S., and is thus within the tropics, it might be expected that the climate would be trying for Europeans, but owing to the elevation of the country the temperature is rarely too high for comfort. Another factor that renders the climate equable is that the rainy season coincides with the summer months, and the winter months are dry. The nights are always cool, so that the climate approximates to the ideal. On the high tableland which forms the great proportion of the country the temperature in the shade rarely reaches 100° and there is just sufficient frost in the winter to be useful to farmers. The winter months are June, July and August, and the hottest months are the spring months of September, October and November, just before the rains begin. A temperature of 110° is sometimes reached in the low-lying district of Tuli (elevation 1890 ft.), and in the Zambezi valley. There is a striking difference between the minimum temperatures on the ground and those registered 4 ft. from the ground. The latter rarely reach freezing-point, but the ground temperature is sometimes as low as 24°. Frost is most noticeable in the vleis and low-lying areas. The period known as the rainy season extends from September to March, but the greatest amount falls in the last three months of that period. The mean annual rainfall for various stations in the eastern half of Rhodesia ranges from 24 to 44 in., the greatest rainfall being along the eastern border. For the western half the mean ranges from 19 to 27 in., but in the south-west corner it is much drier, the rainfall so far recorded never reaching 18 in. There is a certain excess of rain for all summer crops, but winter crops, such as wheat, must be assisted by irrigation. Malaria is prevalent in certain districts during the wet season, but this is now preventable and the country is very healthy, children, especially in towns and on the high veld, growing sturdily. The death-rate amongst Europeans is only about 15 per 1000.

Fauna.—Rhodesia is rich in the larger graminivorous animals, especially in antelope, which number about twenty-five varieties, including kudu, eland, hartebeest, reedbuck, wildebeest and impala. The most common are the duiker, the stembok and the reitbok. Other herbivorous animals found in the country are the buffalo, giraffe, zebra, elephant, hippopotamus, rhinoceros (black and white), warthog, and various baboons and monkeys. The buffalo is now rare, having been almost exterminated by the rinderpest in 1896. The carnivora include the lion, leopard, cheetah, and various wild cats, foxes, wolves, jackals and dogs. There are at least five varieties of the mongoose. Amongst the rodents are squirrels, dormice, rats (eleven kinds), the porcupine, the Cape hare and the rock hare. Of insectivora the ant-eater, the ant-bear, the hedgehog and various shrews may be mentioned. Bats number eleven varieties. Snakes are numerous, the most important being the python, the puff-adder and the cobra. Crocodiles and iguanas are found in most of the rivers, and chameleons and lizards are very common. Rhodesia abounds in beetles, butterflies and moths, and new varieties are frequently discovered in the wet season. Mention ought to be made of white ants (termites) and locusts. The ants are a serious pest, attacking all cut timber resting in or on the ground. They gradually envelop the dead wood in a mound of earth and consume it wholly, so that all poles and house-timber have to be carefully protected either by chemical preparations or by raising them clear from contact with the earth. The mounds which the white ants erect often reach a height of many feet. There are several kinds, the black-headed nigger ant, chiefly found in the west, being the most destructive. Locusts are particularly dreaded in their wingless state, when they clean off every green leaf, every bit of vegetation, as they march on in their hundreds of thousands. The rivers are not very plentiful in fish, but occasional sport is afforded by barbel, bream and tiger-fish.

Birds to the number of about 400 varieties have been found in Rhodesia. The largest of these are the ostrich, the stork (four), the paauw, the koorhaan, cranes (three varieties), cranes (bird), vultures (six) and eagles (eight). The chief birds that attract sportsmen, besides the paauw and the koorhaan already mentioned, are the guinea-fowl (three kinds), partridge and francolin (seven kinds), wild goose, duck and teal. Some of the most interesting birds are the weaver-birds (eighteen), the ox-peckers, which find their food on the backs of cattle, the kingfishers (eight), the hornbills (five), the parrots, lovebirds, the polygamous widow birds—whose females are of insignificant appearance, but whose males develop a brilliant plumage and lengthy tails during the

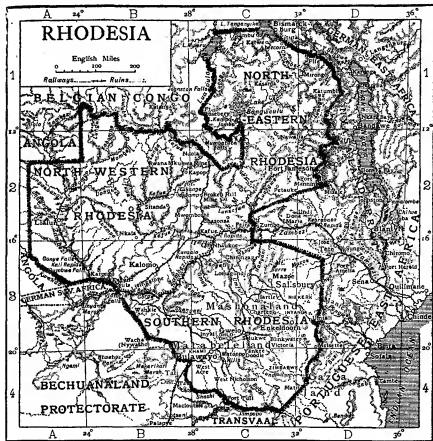

appears to be developed in the Tuli district. The coal-bearing strata of Tuli and Wankies are certainly of Karroo age. They have yielded the fossil remains of fishes *Acrolepis molyneuxi*, the freshwater mollusc *Palaemonitella*, a few reptilian bones, and species of *Glossopteris* among plants.

The age of a widely distributed series of red-white sandstones, named by Molyneux the Forest Sandstone, remains uncertain. Molyneux considers them Tertiary, but it is not improbable that sandstones of various ages from Karroo to those of Recent date are represented. They contain numerous interbedded sheets of basalt, but it is doubtful if any of these are of so recent a date as Tertiary. Rocks of Karroo age occur round Lake Bangweulu, and contain numerous fossil plants and a few small shells. The age of the wide, thick sheet of basalt, through which the Zambezi has cut the Batoka gorge between the Victoria Falls and Wankies, remains uncertain.¹

¹ For geology see F. H. Hatch, "Notes on the Geology of Mashonaland and Matabeleland," *Geol. Mag.*, 1895; A. J. C. Molyneux, "The Sedimentary Deposits of Rhodesia," *Quart. Journ. Geol. Soc.*, vol. lix. (1903); F. P. Mennel, "Geology of Rhodesia," *British Association Handbook* (Cape Town, 1905); G. W. Lamplugh, *British Assoc. Rep.*, South African Meeting, 1905.

breeding season, when they are on guard over their harems of from ten to fifteen wives—the sunbirds, with their long curved beaks that search out the nectar of flowers, and the honey-guides, which, with their agitated “chuck, chuck,” lead the wayfarer to birds’ nests with expectation of joining in the plunder. The small birds of Rhodesia are usually very brilliantly coloured, the most distinguished being what is known as the blue jay, with its bright, iridescent, light blue plumage.

Flora.—The vegetation of the territory is luxurious and mainly subtropical, but in the lower valleys the flora assumes a tropical aspect. The country is well wooded and in this respect differs from the high tablelands farther south. The trees as a rule attain no greater height than about 20 ft., but in some districts, such as South Melssetter and Wankies, there are remains of forests of large timber. The small growth of the trees is said to be due to the annual wild fires, and it is noticeable that native trees that are protected attain a much greater height. As a rule the wood is either very hard or very soft, so that timber for building has still to be imported, although the existing timber is useful for mining purposes. One of the hardest woods is the so-called Rhodesian teak (native *Ikusi*), which is about 50% harder than real teak (*Tectona grandis*). The trees most commonly met with are mapane, used for poles; umkamba, resembling mahogany; m’lanji cedar, chiefly found along the eastern border; umassa, used for firewood; impachia, the native wisteria. Among other trees are the baobab with its enormous very soft trunk, the fruit being a large nut containing citrate of magnesia, which natives use to make a cooling drink; the umvazog—or blood-wood—which issues a blood-coloured juice when cut, and the umkuna, or hissing tree, which hisses when an incision is made. The barks of the umassa, the umhondo, and the umgosa are much used by natives for binding fibres in making tuffs and are also used for tanning. The bark of the baobab yields a fine fibre which natives use in making excellent game nets and fishing nets. The native fruit-bearing trees are the fig (many varieties), the mahobohobe or umjanje, resembling the loquat, the Kaffir plum, very sour and totally different from the Kaffir plum of Cape Colony, and the Kaffir orange. Among the shrubs the proteas, or sugar bushes, with their nectar-stored flowers, are the most frequent. The mimosa there, although more of the nature of a tree, grows in dense masses, chiefly in the western province.

The period of the year when flowers begin to bloom is rather remarkable. After the long spell of dry weather, lasting from five to seven months, and before any rain has fallen, blooms appear all over the veld. Most of such flowers are those of bulbous plants or plants with large roots that have been stored with nourishment during the previous growing wet season. The flowers are sustained by this stock of food until the rains appear again to replenish the roots. Even grass sprouts green over the earth before the rains appear, and the hard-baked veld is pierced by the shoots of the gladiolus, the orchid, the asparagus, the solanum, the convolvulus and many other flowers. When the rains are far advanced, the annuals shoot rapidly, and make a second show of bloom. A peculiarity of the early spring shoots on trees and shrubs is that they have not the green tints of the colder regions, but are all shades of brown and orange and red and yellow.

One of the chief features of Rhodesia is the vast stretches of grass-covered veld, the grasses varying from a few inches to 15 ft. in height and numbering about 100 different varieties. Along the rivers are to be found palms, tree ferns, bananas, dracaenas and other hot climate plants. Rubber, indigo and cotton are indigenous and there are groves of lemon trees, but these were most probably introduced by early settlers. Tobacco, which grows luxuriantly, may also have been introduced.

Inhabitants.—In Southern Rhodesia about half the European population, which in 1909 was approximately 16,500, is British born or born of British parents, and about one-third is South African born. There are about 11,500 males and 5000 females, and the population is equally divided between the urban and rural areas. In rural areas the chief occupations are mining and agriculture. Industrial pursuits, including mining, engage about 25% of the population, 8% are employed in agriculture, and 15% in commerce. Mashonaland has 7500 white inhabitants, and Matabeleland 9000. There are about 2000 Asiatics in Southern Rhodesia.

The Natives of Rhodesia belong to the Bantu-Negro stock and are roughly divisible into two groups; those long settled in the country, and the Amazulu, who during the 19th century left Zululand and, passing through the more southern regions, overran Rhodesia and settled in Matabeleland. The Barotse (*q.v.*) are mainly settled in North-West Rhodesia. In Southern Rhodesia, in spite of incursions from Portuguese territory and from the north, the natives can be still clearly divided into Mashona and Matabele, living in the eastern and western pro-

vinces respectively. The name Mashona is not used by the natives but is useful as distinguishing the allied tribes of the eastern division from the Matabele in the west. The languages of the Mashona tribes are allied and are distinct from that of the Matabele (or Zulu), but it is uncertain whether these Mashona tongues should be regarded merely as different dialects, or languages as different as those of the various nations of Europe (but see BANTU LANGUAGES). The tribes round Salisbury and extending as far as Marondella in the east and about 100 m. north are clearly branches of the Vasezuru people, that is, the people from “higher up,” the “higher up” being a region in the south-east. Their history can be traced from about the beginning of the 18th century; but there is a great lack of tradition amongst this class of native, which is distinctly inferior in type to the Matabele in the west.

Farther north there are the Makorikori and the Mabudja or Mabushia. It would appear that the country in which these people now dwell was formerly in the possession of the Barotse, and some of the present chiefs obtained their positions by permission of the Barotse. Previously, according to Portuguese documents of the 16th and 17th centuries, the Makaranga or Makalanga now located in the south round about Victoria had possession of the country as far north as the Zambezi. Their language is allied to that of the present inhabitants, but in many respects is widely different and of late has become more so owing to intercourse with the Matabele. Along the eastern border two more tribes can be distinguished, namely, Umata’s people in the north and those speaking the Chindawo language in the south. Their languages are merely variants of the language spoken in the Salisbury and Mازه districts.

All the tribes in the eastern province have very similar habits and customs. Their huts are circular with a wall a foot or two high, made of poles and *daga* (mud) surmounted by a conical thatched roof. They thus differ from the beehive huts of the Zulus. They are built indiscriminately together and are not surrounded by stockades. The whole family dwells in the same hut along with dogs, goats and fowls, and sometimes even with cattle, though there are usually separate kraals for their cattle. The kraals are as a rule filthy, but the inside of the hut is kept clean. There is a special place for a fire, and a raised portion of the mud floor on which to sleep, but no furniture. Their mealie fields are usually some distance from the place of abode, but their tobacco gardens are near their huts. Their main object in life seems to be to grow sufficient grain for food and beer. The grain they store in granaries, resembling small huts, placed on rocks or on stakes, out of the reach of white ants and secure from the depredations of animals. They amuse themselves occasionally by making earthenware pots which are very soft and easily broken, or by engaging in iron-work or brass-wire work for ornamentation. In the south they are quite clever in making water-tight baskets from rushes grown by the Sabi river. In their religious beliefs spirits play a great part. Above all there is a vague idea of a Supreme Being whom they call *Mwari*. They have a fixed belief in the spirits of their ancestors, the spirits of the witch-doctors, the spirits of the Matabele, the spirits of old women, the spirits of the foolish, the spirits of baboons, &c. Every occurrence is attributed to the influence of a spirit, and if the occurrence is an evil one a feast and dance of propitiation are held. Feasts of thanksgiving are also held on such occasions as the gathering of the first-fruits, the harvest festival, or on the return from a long and dangerous journey. Of the tribes already mentioned the most advanced are Umata’s people and the Makaranga. The probable connexion of the tribes now inhabiting Mashonaland with the architects of the ancient stone buildings which are scattered over the country is discussed in the section *Archaeology*. Of these ruins the most extensive are situated near Victoria and are known as Zimbabwe (*q.v.*).

In the western province the Matabele, or rather Amandabele, are the descendants of the Zulus who trekked under the

leadership of the famous Mosilikatze up through the Transvaal, whence they were driven by the Boers. Mosilikatze died in 1868, and his son Lobengula, after a fight with a brother, assumed sway in 1870. His people were divided into three main sections: the Abenzani (who were the aristocrats), the Abenhla and the Amaholi. The Amaholi or Holi were the inhabitants of the land at the time of the invasion and thereafter were practically in the position of bondsmen and rarely allowed to possess cattle. The great spirit of the Holis was the Milimo, who was practically the spirit of the nation. Among the Holi tribes are the Abashangwe, the Abanyai, the Batonke (near the Zambezi), the Abanzwa of the Wankie district, the Ababiro of the Tuli district, and the Abasili, a nomadic tribe chiefly subsisting on game. There is a small tribe in the Belingwe district called the Abalemba, which would appear to have been in touch with the Arabs in early times. Their customs include circumcision and the rejection of pork as food.

The natives in Southern Rhodesia number about 700,000, and of these 10,000 work on the mines and 20,000 are engaged in farm, railway and household work under Europeans.

Chief Towns.—Salisbury, which lies 4880 ft. above the sea, is the capital of Southern Rhodesia, being the seat of government, and is situated in the eastern province (Mashonaland). There are about 1700 white inhabitants and 3000 natives. It is the commercial centre for an extensive mining and farming district. The principal buildings include churches, public library, hospital, schools, banks, post office and numerous hotels. There are a considerable number of government offices, and the administrator and resident commissioner live here. The only industries are a brewery and a tobacco factory for grading and packing the tobaccos of the local growers.

Bulawayo (n.s.), situated 4469 ft. above the sea, is the largest town and is in the western province, Matabeleland. It is 301 m. by rail S.W. of Salisbury, and 1362 m. N.E. of Cape Town. The population is some 4000 Europeans and about the same number of natives. The town has the advantage of a good pipe water supply and a service of electric light. It was the ancient capital of the Matabele king, Lobengula. There is a Government house which is occasionally occupied, and was the residence of Cecil Rhodes. It is from Bulawayo that the World's View, the burial-place of Rhodes in the Matopos Hills, is usually visited.

The other towns are Umtali, on the eastern border, pop. 800 whites; Gwelo, centre for numerous large and small gold mines; Victoria, the central town, about midway between Salisbury and Bulawayo, 370 whites; Victoria and Melsetter in the south, centres of farming districts. Victoria, near which are the famous Zimbabwe ruins, is reached by mail cart (80 m.) from Selukwe, and Melsetter by mail cart (95 m.) from Umtali. There are also small townships at Hartley, Selukwe, Enkeldoorn and Gwanda. Bulawayo and Salisbury are managed by town councils, the other towns have sanitary boards.

Communications.—The Rhodesian railway system connects the chief towns and mining centres with one another and all the other South African countries. The main line is a continuation of the railway from Cape Town through Kimberley and Mafeking. It runs from Mafeking in a general N.E. direction to Bulawayo, whence it goes N.W. to the Zambezi, which is crossed a little below the Victoria Falls. The bridging of the river was completed in April 1905. Thence the railway is continued N.E. (92 m.) to Kalomo, Barotseland, and onward to the Katanga district of Belgian Congo. The section from Kalomo to Broken Hill (261 m.) was completed in 1907, and the extension to the frontier of Belgian Congo (126 m.) in 1909. This main line forms the southern link in the Cape to Cairo railway and steamboat service. From Bulawayo a line goes N.E. by Gwelo to Salisbury and thence S.E. to the Portuguese port of Beira. From Bulawayo another line (120 m. long) runs S.E. to the West Nicholson Mine. From Gwelo a railway (40 m.) goes S.E. to Yankee Doodle, and from this there branches a line (50 m. long) in an easterly direction to Blinkwater. From Salisbury a line runs N.W. to Lomagundi (84 m.). The last-named has a 2 ft. gauge. The other railways are of the standard gauge of South Africa—3 ft. 6 in. The distances from Bulawayo to the following places are:—Gwelo, 113 m.; Salisbury, 301 m.; Umtali, 471 m.; Beira, 675 m.; Mafeking, 490 m.; Kimberley, 713 m.; Cape Town, 1362 m.; Port Elizabeth, 1199 m.; East London, 1260 m.; Bloemfontein, 800 m.; Johannesburg, 931 m.; Pretoria, 977 m.; Lourenço Marques, 1307 m.; Durban, 1238 m. (the last four places all via Fortunes Streams, a junction 48 m. N. of Kimberley), and Victoria Falls, 282 m.

About 4000 m. of roads have been built and are maintained by government. The telegraph and telephone system is very complete, there being for the whole of Rhodesia about 8000 m. of wires. This total includes the police telephone wires and part of the African

Transcontinental system, and is served by about ninety telegraph offices. In Southern Rhodesia there are about eighty post offices. A post office savings bank was brought into operation on the 1st of January 1905. Over 2,500,000 letters, post-cards and parcels are despatched annually.

Agriculture.—The country is well adapted for agriculture. Chief attention has been paid by farmers to the growing of maize, the annual produce being about half a million bushels. It is a very easily grown cereal, especially in such a fertile country as Rhodesia, and is extensively grown by natives, but the improved methods of the whites easily secure a yield of from twice to eight times that of the native. The average yield by European farmers is about eight bags of 200 lb per acre, but ten to fifteen bags is quite a common crop. Wheat, barley and oats are grown with success under irrigation in the winter time, but the moisture with attendant rust is too excessive for these crops in summer. Tobacco promises to be a great source of wealth to the territory. Both the Turkish and the Virginian tobaccos have been raised and cured and put on the market where they were easily disposed of. They are of better quality than those grown elsewhere in South Africa. In 1908 only about 500 acres were under cultivation, but there are large tracts of land suitable for this industry.

Fruits of very extensive variety thrive in Rhodesia; they include plums, bananas, grapes, guavas, papuvas, figs, loquats, pine-apples, Cape gooseberries, mulberries, tree tomatoes, rosellas, granadillas, all kinds of citrus fruits. The most flourishing are the citrus fruits and the Japanese plums, but in the higher altitudes pears and apples are also very successful. Vegetables of nearly all kinds can be grown, especially potatoes, tomatoes, asparagus, sweet potatoes, yams, &c. Coffee produces as much as 4 lb of beans to the acre in certain parts.

Cattle thrive well in Rhodesia, and stock-raising promises to be the chief agricultural industry of the future. During the early period of European occupation rinderpest and at a later date East Coast fever decimated the country, but the prevention of these diseases is now thoroughly understood and, since the rinderpest of 1896 swept away large herds, cattle have been increasing rapidly in number. There is hardly any portion of the territory which is not suitable for cattle, and the rapid natural increase indicates a speedy prosperity in cattle ranching. Goats and woolless sheep number about 800,000 in the territory. Donkeys and mules thrive abundantly, and are very liable to horse-sickness towards the end of the rainy season.

Mining.—When Rhodesia was first opened up to European occupation, attention was immediately called to the large number of gold workings made by unknown former inhabitants of the country. These workings were only carried on to a limited extent, being stopped probably by the presence of water and the lack of suitable machinery. European enterprise has resulted in the discovery of a large number of mines situated in widely scattered areas. The chief mines are the Globe and Phoenix in the Selukwe area, the Wanderer in the Gwelo district, the Giant in the Hartley district; the Jumbo in the Mazoe district; the Ayrshire in the Lomagundi district; the Penhalonga and the Rezende in the Umtali district, while there are numerous smaller mines in the Gwanda, Insiza, Gwelo, Hartley and Umtali districts. The output of gold increased in value from £308,000 in 1900 to £2,623,000 in 1909, about one-third of this being produced by small workers whose individual output is not over 1500 oz. a month. As efforts have been restricted mainly to extracting the ore indicated by ancient workings, it is probable that many gold reefs still await discovery. The mineral wealth of Rhodesia is very varied and includes silver to the value of 262,000 oz. were produced in 1909; coal, 170,000 tons (1909), and lead, 965 tons. Extensive discoveries of chrome iron have been made in the Selukwe district. There is a steady export of this metal, of which the output in 1909 was over 25,000 tons. Besides these, small quantities of copper, wolframite and diamonds have been exported, while scheelite and asbestos have been discovered in payable quantities.

Commerce.—Taking the average for a series of years ending 1908, the total imports amounted to about £1,500,000 per annum, 55% of which were manufactured articles, including £250,000 of textile goods and wearing apparel and £120,000 of machinery. Imports of food and drink amounted to £330,000. In 1909 the import amounted to £2,214,000, the chief items being food and drink (£422,000), machinery, animals and cotton goods. Exports consist almost entirely of minerals. In 1909 they were valued at £3,178,000. Included in the total is £342,000 goods imported and re-exported.

Administration.—The administration of Rhodesia is carried on by the British South Africa Company under an order in council of 1898, amended by orders in council of 1903 and 1905. The company is called upon to appoint for Southern Rhodesia an administrator or administrators. The company also appoints an executive council of not fewer than four members to advise the administrator upon all matters of importance in administration. An order in council of 1903 provided for a

legislative council consisting of the administrator, who presides, seven nominees of the company approved by the secretary of state, and seven members elected by registered voters (the number of registered voters in 1908 was 5291). In 1907 it was agreed to reduce the company's nominees by one, so that the elected members should form the majority of the council. The secretary of state appoints a resident commissioner, who sits on both executive and legislative councils without vote. The duty of the resident commissioner is to report to the high commissioner upon all matters of importance. Ordinances passed by the legislative council are submitted to the high commissioner for consent or otherwise, but may be disallowed by the secretary of state.

For the administration of justice there is a High Court with two judges having civil and criminal jurisdiction. There are seven magistrates' courts throughout the territory. For the administration of native affairs there are appointed a secretary for native affairs, two chief native commissioners, twenty-eight native commissioners and six assistant native commissioners. Natives suffer no disabilities or restrictions which do not equally apply to Europeans except in respect of the supply of arms, ammunition and liquor. Native commissioners may exercise jurisdiction in native affairs not exceeding that exercisable by magistrates. The company has to provide land, usually termed Native Reserves, sufficient and suitable for occupation by natives and for their agricultural and industrial requirements.

Revenue.—The administrative revenue of Southern Rhodesia was at first much less than the cost of administration. The figures for 1809-1900 were: revenue, £325,000; expenditure, £702,000. Since that date revenue has increased and expenditure decreased, and from 1905-6 (in which year the revenue exceeded £500,000) the cost of administration has been met out of revenue. For 1909-10 the revenue was approximately £600,000, the two main items being customs duty, £190,000, and native tax, £200,000. The native tax is £1 per head for every adult male and 10s. for every wife after the first.

Education.—Besides a few private schools, there were in 1909 34 schools for Europeans, 26 of which were wholly financed by government, the remainder being aided. The aided schools are as a rule connected with some religious body, and aid is given to the extent of half the salaries of the teachers and half the cost of school requisites. Loans are also given to assist in school building. A system of boarding grants has been instituted to enable children in the outlying districts to attend school. Education is not free except for poor children, but the fees in government schools do not exceed £6 a year. In 1910 several schools had reached the stage of preparing pupils for matriculation at the Cape University and similar examinations. The number of pupils in 1909 in European schools was 1212, being more than double what it had been four years previously. The education of natives is in the hands of various religious bodies, but financial aid is given by government to native schools which comply with certain easy conditions. In 1909, 80 native schools with an enrolment of 7622 pupils earned grants.

Military Forces.—The military force in Southern Rhodesia is styled the British South African Police, and numbers about 40 officers, 400 non-commissioned officers and men, and 550 native police. The force is under a commandant-general, who, with the subordinate officers, is appointed by the secretary of state, and is under the direct control and authority of the high commissioner. The commandant-general is paid by the British parliament. The offices of commandant-general and resident commissioner were combined in 1905.

The Southern Rhodesia Volunteers, in two divisions, eastern and western, under command of colonels, number altogether 86 officers and 1700 non-commissioned officers and men.

Medical.—There are, including cottage hospitals, ten hospitals in towns and townships, and thirteen district surgeries have been established. (G. Du.)

Archaeology.—Between the Zambezi and the Limpopo, and extending from the coast to which 27° E., may be found the traces of a large population which inhabited Southern Rhodesia and Portuguese East Africa in bygone times. Apart from numerous mines, some of which are being successfully re-worked at the present day, ruins of stone buildings have been found in several hundred distinct places. Few of these have been explored systematically, but investigations in 1905, though confined to a small number of sites, determined at

least the main questions of date and origin. The fanciful theories of popular writers, who had ascribed these buildings to a remote antiquity, and had even been so audacious as to identify their founders with the subjects of King Solomon or of his contemporary the queen of Sheba, are now seen to be untenable. J. T. Bent's *Ruined Cities of Mashonaland* (1892) is now interesting only for its illustrations, and his theories are obsolete. Positive archaeological evidence demonstrates that the "Great Zimbabwe" itself, the most famous and the most imposing of the misnamed "Ruined Cities," was not built before medieval times, and that the earliest date which can be assigned to any of the sites explored is subsequent to the 11th century A.D. Moreover, the complete identity of custom, revealed no less by the details of the dwellings than by the type of the articles found within them, proves that the tribe that built these structures was one closely akin to if not actually identical with the present Bantu inhabitants of the country.

These ruins, even when stripped of their false romance, are of extreme interest; but their nature and appearance have been much misunderstood, and the skill and intelligence required for their erection have been grossly overestimated. It should be clearly stated, therefore, that the methods of the old Rhodesians evince their complete ignorance of all the devices employed in the architecture of civilized peoples. They have not attempted to solve the problems of supporting weight and pressure by the use of pillar, arch or beam; the ingenuity of the builders goes no further than the dexterous heaping up of stones. Indeed, their most finished and elaborate work must be compared with nothing more ambitious than the dry-built walls which serve to enclose the fields in certain parts of England. The material is the local granite or diorite obtainable in the immediate neighbourhood. Stone-hewing has not been practised; and was unnecessary, since the natural flaking of the boulders provides an abundance of ready-made slabs which need only be detached from the parent rock and broken to the required size. At most the blocks thus obtained have been very roughly trimmed with one or two blows, and any apparent regularity in the fitting has been obtained merely by judicious selection. Mortar has seldom been used; the courses are never laid with any approach to exactness; walls merely abut on one another without being bonded, and the same line often varies greatly in thickness at different parts.

The main principle of the ground plan is invariably circular or elliptical, though it is carried out with a conspicuous lack of symmetry or exactness. Straight lines are unknown, and even accidental approximations to an angle are rare. This is eminently characteristic of the Bantu, whose huts are commonly built in circular form. Indeed, it is the round Bantu hut which has been the original model for even the finest of these stone constructions. The connexion between the two, however, goes beyond mere resemblance. The stone walls are always accompanied by huts; they are mere partitions or ring-fences enclosing and structurally inseparable from platforms of clay or cement on which stand the remains of precisely the same dwellings that the Makalanga make at the present day. Buildings such as those at Dhlo Dhlo, Nantali and Khami in Matabeleland, or at Zimbabwe in southern Mashonaland, are merely fortified kraals; remarkable indeed as the work of an African people, but essentially native African in every detail, not excepting the ornamentation.

The best-known and the most attractive of the Rhodesian ruins are those situated in the more central and southern region. In the north-east, however, the remains are even more numerous, though the single units are less remarkable. Over the whole of Inyanga and the Mazoe region are distributed hill-forts, pit-dwellings and intrenchments which are more primitive in character though of the same generic type as those found farther south. The inhabitants of these northern districts were occupied more in agriculture than in gold-mining, and one of the most striking features of their settlements is the

irrigation system. There are no aqueducts such as Europeans or Arabs might have built, but water furrows have been carried on admirably calculated gradients for miles along the hill-sides. The amount of labour which has been expended on the great villages between Inyanga and the Zambezi is astounding. On one site, the Niekirk Ruins, an area of fully 50 sq. m. is covered with uninterrupted lines of walls. It is an interesting question which may be solved by future explorations whether these settlements do not extend north of the Zambezi. Intrenchments like those of the Niekirk Ruins have been reported from the south-east of Victoria Nyanza, and Major Powell Cotton has published a photograph from the Nandi country which exhibits a structure precisely similar to the hill forts of Inyanga. (See also ZIMBABWE; MONOMOTAPA.)

See D. Randall-MacIver, *Medieval Rhodesia* (London, 1906); R. N. Hall and W. G. Neal, *The Ancient Ruins of Rhodesia* (London, 1902); *Zeitschrift für Ethnologie*, 1875 and 1876; *Journal of the R.G.S.*, 1890, 1893, 1899, 1906; *Journal of Anthropol. Inst.*, vols. xxxi., xxxv. (D. R.-M.)

History.—There is evidence that from the 10th or 11th centuries onward the lands now forming Rhodesia were inhabited by Bantu-negroes who had made some progress in civilization and who traded with the Arab settlements at Sofala and elsewhere on the east coast (see *Archaeology* above). From the 15th century, if not earlier, until about the close of the 18th century, a considerable part of this area was ruled by a hereditary monarch known as the Monomotapa, whose *zimbabwe* (capital) was, in the earlier part of the period indicated, in what is now Mashonaland. Some of the Monomotapas during the 16th and 17th centuries entered into political and commercial relations with the Portuguese (see MONOMOTAPA and ZIMBABWE). The Monomotapa "empire" included many vassal states, and probably fell to pieces through intertribal fighting, which greatly reduced the number of inhabitants. In the early years of the 19th century the tribes appear to have lost all cohesion. The people were mainly agriculturists, but the working of the gold-mines, whence the Monomotapas had obtained much of their wealth, was not wholly abandoned.

The modern history of the country begins with its invasion by the Matabele, an offshoot of the Zulus. Mosilikatze, their first chief, was a warrior and leader who served under the Zulu despot Chaka. Being condemned to death by Chaka, Mosilikatze fled, with a large division of the Zulu army. About 1817 he settled in territories north of the Vaal, not far from the site of Pretoria; and in 1836 a treaty of friendship was entered into with him by the governor of Cape Colony. In the same year a number of the "trek Boers" had crossed the Vaal river, and came in contact with the Matabele, who attacked and defeated them, capturing a large number of Boer cattle and sheep. In November 1837 the Boers felt themselves strong enough to assail Mosilikatze, and they drove him and his tribe north of the Limpopo, where they settled and occupied the country subsequently known as Matabeleland. In 1868 Mosilikatze died. Kuruman, son and recognized heir of the old chieftain, had disappeared years before, and though a Matabele who claimed to be the missing heir was brought from Natal he was not acknowledged by the leading indunas, who in January 1870 invaded Lobengula, the next heir, with the chieftainship. Those Matabele who favoured the supposed Kuruman were defeated in one decisive battle, and thereafter Lobengula, whose kraal was at Bulawayo, reigned unchallenged. At this time the Matabele power extended north to the Zambezi, and eastward over the land occupied by the Mashona and other Makalanga tribes. North of the Zambezi the western districts were ruled by the Barotse (*q.v.*), while the eastern portion had been overrun by other tribes of Zulu-Xosa origin, among whom the Agoni were the most powerful. The explorations of David Livingstone, Thomas Baines (1822-1875), Karl Mauch, and other travellers, had made known to Europe the general character of the country and the existence of great mineral wealth. Lobengula was approached by several "prospectors" for the grant of concessions; among them two Englishmen, Baines in 1871

and Sir John Swinburne in 1872, obtained cessions of mineral rights, but little effort was made to put them in force. In 1882 President Kruger, who was then bent on extending the boundaries of the Transvaal in every direction, endeavoured to make a treaty with Lobengula, but without success. The Warren expedition of 1884 to Bechuanaland (*q.v.*), while it checked for a time the encroachments of the Transvaal Boers, and preserved to Great Britain the highway to the north through Bechuanaland, also served to encourage colonists to speculate as to the future of the interior. At this time, too, the struggle between the nations of western Europe for the unappropriated portions of Africa had begun, and while the Boers, foiled in Matabeleland, endeavoured to get a footing in Mashonaland, both Portuguese and Germans were anxious to secure for their countries as much of this region as they could. In 1887 a map was laid before the Portuguese cortes showing the territories in Africa claimed by Portugal. They stretched across the continent from sea to sea, and included almost the whole of what is now Rhodesia, as well as the British settlements on Lake Nyasa. To the claim of a transcontinental domain Portugal had succeeded in gaining the assent of Germany and France, though Germany, which had secured a footing in south-west Africa, still dreamed of extending her sway over Matabeleland. By the instructions of Lord Salisbury, then foreign secretary, the British representative at Lisbon informed the Portuguese government that except on the seacoast and on portions of the Zambezi river there was not a sign of Portuguese authority or jurisdiction in the districts claimed by them, and that the British government could not recognize Portuguese sovereignty in territory not effectively occupied by her.

This protest, so far as southern Rhodesia is concerned, might have been ineffective save for the foresight, energy and determination of Cecil Rhodes, who had been instrumental in saving Bechuanaland from the Boers, and who as early as 1878 had conceived the idea of extending British influence over central Africa.¹ At this time gold prospecting was being feverishly undertaken all over South Africa as a result of the discoveries at Barberton and on the Rand, and Lobengula was besieged for all sorts of concessions by both Portuguese and Boers, as well as by other adventurers from all parts of the world. If the country was to be secured for Britain immediate action was necessary. Sir Sidney Shippard, who had succeeded Rhodes as commissioner in Bechuanaland and who shared his views, kept up a friendly correspondence with Lobengula, while at Bulawayo Mr J. S. Moffat was British resident. At the end of 1887 Sir Sidney urged the high commissioner, Lord Rosmead (then Sir Hercules Robinson), to allow him to conclude a treaty with Lobengula, but unavailingly, until Rhodes, by taking upon himself all pecuniary responsibility, succeeded in obtaining the required sanction. On the 11th of February 1888, Moffat and Lobengula signed an agreement, whereby the Matabele ruler agreed that he would refrain from entering into any correspondence or treaty with any foreign state or power without the previous knowledge and sanction of the British high commissioner for South Africa. Shortly after the conclusion of this treaty, representatives of influential syndicates directed by Rhodes, in which Alfred Beit and C. D. Rudd were large holders, were sent, with the knowledge of the British government and the high commissioner, to negotiate with Lobengula, and on the 30th of October of the same year he concluded an arrangement with Messrs Rudd, Rochfort Maguire and F.R. Thomson, by which, in return for the payment of £100 a month, together with 1000 Martini-Henry rifles and 100,000 rounds of ammunition, he gave the syndicate complete control over all the metals and minerals in his kingdom, with power to exclude from his dominions "all persons seeking land, metals, minerals or mining rights therein," in which action, if necessary, he promised to render them assistance. The position of the envoys was one of considerable danger, as Lobengula had around him many white advisers strongly antagonistic to

The
country
secured
for Great
Britain.

¹ See article "Bechuanaland" by Sir Henry Shippard in *British Africa* (London, 1899).

Rhodes's scheme. The arrival at Bulawayo of Dr L. S. Jameson, who had previously attended Lobengula professionally, and who strongly supported Rudd and his companions, appears to have been the factor which decided Lobengula to sign the concession. This concession once obtained, Rhodes proceeded with rapidity to prosecute his great enterprise. He extinguished the claims of earlier concessionaires by purchase (giving, for instance, £10,046 for the Baines and Swinburne grants), and united all interests in the British South Africa Company, with a share capital of £1,000,000.

Following the example of Sir George Goldie in West Africa and of Sir William Mackinnon in East Africa, Rhodes determined to apply to the British government for a charter for the newly formed company, whose original directors were, in addition to Rhodes and Beit, the duke of Abercorn, the duke of Argyll, Lord Gifford, Albert (afterwards 4th earl) Grey and George Cawston. In applying for a charter (in April 1889) the founders of the company stated their objects to be the following: (1) To extend northwards the railway and telegraph systems in the direction of the Zambezi; (2) to encourage emigration and colonization; (3) to promote trade and commerce; (4) to develop and work minerals and other concessions under the management of one powerful organization, thereby obviating conflicts and complications between the various interests that had been acquired within these regions, and securing to the native chiefs and their subjects the rights reserved to them under the several concessions. In making this application the boundaries in which they proposed to work were purposely left somewhat vague. They were described to be the region

The B.S.A. Co.'s charter.
of South Africa lying immediately north of British Bechuanaland, north and west of the South African Republic, and west of the Portuguese dominions on the east coast. The government, having ascertained the substantial nature of the company's resources and the composition of the proposed directorate, and also that they were prepared to begin immediately the development of the country, granted the charter, dated the 29th of October 1889. From this date onward the company was commonly known as "the Chartered Company."

A few points in the charter itself deserve to be noted. In the first place, it gave considerable extension to the terms of the original concessions by Lobengula. In short, it transformed the rights of working minerals and metals, and preventing others from doing so, into rights practically sovereign over the regions in which the company's activity was to be employed. These rights the crown granted directly itself, not merely confirming a previous grant from another source. By Article X. the company was empowered to make ordinances (to be approved by the secretary of state), and to establish and maintain a force of police. A strict supervision was provided for, to be exercised by the secretary of state over the relations between the company and the natives. The British government reserved to itself entire power to repeal the charter at any time that it did not consider the company was fulfilling its obligations or endeavouring duly to carry out the objects for which the charter was granted. The sphere of operations of the company was not stated with any greater precision than had been indicated in the application for the charter; but by agreements concluded with Germany in 1900, with Portugal in 1891 and with the Congo State in 1894, the international boundaries were at length defined (see AFRICA, § 5). The agreements, while they took the British sphere north to Lake Tanganyika, disappointed Rhodes in that they prevented the realization of the scheme he had formed by the time the charter was granted, namely, for securing a continuous strip of British territory from the Cape to Egypt—a scheme which was but an enlargement of his original conception as formulated in 1878.

Much, however, had happened before the boundaries of the British sphere were fixed. While the railway from Cape Town was being continued northward as rapidly as possible, the determination was taken to occupy immediately part of the sphere assigned to the company, and Mashonaland was selected

as not being in actual occupation by the Matabele but the home of more peaceful tribes. A pioneer force was sent up in June 1890 under Colonel Pennefather, consisting of five hundred mounted police and a few hundred pioneers. Accompanying this force as guide was the well-known traveller, F. C. Selous. The work of transport was attended with considerable difficulty, and roads had to be cut as the expedition advanced. Nevertheless, in a few months the expedition, without firing a shot, had reached the site of what is now the town of Salisbury, and had also established on the line of march small forts at Tuli, Victoria and Charter. Archibald Ross Colquhoun was chosen as the first administrator. He had not long been in office when, in May 1891, difficulties arose with the Portuguese on their north-west frontier, both parties claiming a tract of territory in which a Portuguese trading station had been established. The result was a skirmish, in which a small company of British South Africa police were victorious. In 1891 Dr Jameson, who had joined the pioneer force, was appointed administrator in succession to Colquhoun. The Boers for several years had been planning a settlement north of the Limpopo, and they now determined, in spite of the Moffat treaty and the British occupation, to carry out their object. An expedition known as the Bannayland Trek was organized under the leadership of Colonel Ferreira, and two large parties of Boers proceeded to the banks of the Limpopo. Information of the intended trek had been conveyed to Cape Town, and Sir Henry (afterwards Lord) Loch (the high commissioner) at once sent a strong protest to President Kruger, informing him that any attempt to invade the Chartered Company's territories would be an act of hostility against the British Crown; and Kruger issued a proclamation forbidding the trekkers to proceed. Meanwhile, however, a party had already reached the Limpopo, where they were met by Jameson in command of the British South Africa Company's forces. He told them that they would not be allowed to proceed except as private individuals, who might obtain farms on application to the Chartered Company. Colonel Ferreira was arrested and detained for a few days, and the expedition then broke up and dispersed.

The pioneers, who were granted farms and mining claims, having been settled in Mashonaland, Rhodes recognized the extreme importance of giving the country a port nearer than that provided by Cape Town. On his initiative proposals were made to Portugal, and the treaty concluded in 1891 between Great Britain and Portugal provided that a railway might be built from Beira in Portuguese territory to Salisbury, on condition that Portugal received a duty not exceeding 3% on the value of the goods imported. The treaty further stipulated for the free navigation of the Zambezi and the construction of telegraphs. Prospecting operations were at once started, and various gold mines were discovered containing traces of old workings. Fresh gold reefs were also opened up. The prospects of the country seemed promising, and although a good deal of fever occurred in the low-lying valleys under the conditions of camp life, the health of the community soon improved as more suitable habitations were erected. In two years a white population of 3000 people had settled in the newly opened country.

Though the company was now free from international rivalry it was soon faced by serious native trouble. The first pioneers had deliberately chosen Mashonaland as their place of settlement. Ever since the advent of Mosilikatze north of the Limpopo the unfortunate Mashonas had been the prey of the Matabele; they therefore readily accepted the British occupation. The Matabele, however, were loth to abandon their predatory excursions among the Mashonas, and in July 1893 a large *impi* (native force) was sent into Mashonaland, and entered not only native kraals, but also the streets of the new township of Victoria. An attempt was made to preserve the peace, but it was evident from the attitude taken by the Matabele that nothing short of the authority which only superior force could command would settle the question. The Matabele were

Mashonaland occupied —A Boer trek prevented.

a proud and fearless race of warriors; the men of that generation had never come in conflict with Europeans, and had never been defeated in their conflicts with native foes. Jameson's forces were slender, and Rhodes, on being consulted, urged him by telegram to "Read Luke fourteen, thirty-one." On obtaining a Bible, Jameson read the words: "Or what king, going to make war against another king, sitteth not down first, and consulteth whether he be able with ten thousand to meet him that cometh against him with twenty thousand?" He telegraphed in reply: "All right. I have read Luke fourteen, thirty-one." The position, though dangerous, admitted of no delay, and Jameson determined to risk an expedition with the forces at his command. His success on this occasion doubtless weighed with him on another and less fortunate one. The force available consisted of about 700 volunteers and 225 British Bechuanaland police, with some 700 natives. Jameson determined to march to Bulawayo, the headquarters of Lobengula and the capital of Matabeleland. The force was divided into two columns, and was to be met by a further column of Bechuans marching from the south under Khama, the most influential of the Bechuan chiefs and a loyal friend of the British. The first engagement took place on the Shangani river, where the two columns which had started from Fort Charter and Fort Victoria were both engaged. Majors Forbes and Allan Wilson commanded in these engagements; and after a hot contest with between 4000 and 5000 Matabele, the latter were repulsed, machine guns being used with terrible effect upon the enemy. On the 1st of November a second fight occurred on the high ground, in which it was estimated that 7000 of the Matabele attacked the laager of the two columns. The oldest and most tried regiments of Lobengula dashed right up to the muzzles of the guns, but were swept down before the modern rifles and machine guns with which the invaders were armed. Meanwhile the column of Khama's men from the south had reached the Tati, and won a victory on the Singuesi river on the 2nd of November. On the 3rd of November Bulawayo was reached, and the columns from Mashonaland, accompanied by Jameson and Sir John Willoughby, entered the town, Lobengula, and his followers being in full flight towards the Zambezi.

Matabeleland conquered. An endeavour was made to induce Lobengula to surrender; but as no replies were received to the messages, Major Forbes, on the 13th of November, organized a column and started in pursuit.¹ The pursuing party were delayed by difficult roads and heavy rains, and did not come up with Lobengula until the 3rd of December. Major Allan Wilson, in command of thirty-four troopers, crossed the Shangani river in advance, and bivouacked close to Lobengula's quarters. In the night the river rose, and reinforcements were unable to join him. During the early morning the Matabele surrounded the little band, and after fighting most gallantly to the last, Major Allan Wilson and all his followers, with the exception of three messengers, who had been sent back, were killed.

In January 1894 Lobengula died—from fever, or as the result of a wound, accounts differ—at a spot about forty miles south of the Zambezi. After his death his *indunas* submitted to the Chartered Company's forces, and the war, which cost the company over one hundred lives and £110,000, was thus ended. An order in council of the 18th of July following defined the administrative power of the company over Matabeleland. Charges were made against the company of having provoked the Matabele in order to bring on the war and thus secure their territory, but after inquiry the company was expressly exonerated from the charge by Lord Ripon, then colonial secretary. With the close of the war the Matabele appeared to be crushed, and for over two years there was no serious trouble with the natives. The country was at once thrown

¹ Lobengula had in fact sent to the Forbes patrol gold dust worth about £1000, and intimated his desire to surrender; but two troopers to whom the gold and message were entrusted kept the gold and suppressed the message. Their crime was afterwards discovered and the troopers sentenced to fourteen years' penal servitude.

open to white settlers. Close to the site of Lobengula's kraal the new town of Bulawayo was founded, and rapidly grew in importance. Among the new settlers were many Dutch farmers. The Roman-Dutch law was chosen as that of the new colony, a land commission was established and commissioners appointed to look after the interests of the natives.

Considerable development in the part of the company's territory north of the Zambezi had meantime taken place. Between 1889 and 1891 a large number of tribes in the region between lakes Nyasa and Tanganyika and the Zambezi had entered into treaty relations with the company, and a settlement named Abercorn had been founded at the south end of Tanganyika. This work was undertaken in part to forestall German action, as before the signature of the agreement of July 1890 German agents entertained the design of penetrating west of Lake Nyasa to the Congo State frontier. The company further acquired the property of the African Lakes Company—which had done much to secure British predominance in the Nyasa region—and on the organization of Nyasaland as an imperial protectorate the South Africa Company contributed £10,000 a year for three years (1891–92–93) towards the cost of the administration, the imperial commissioner during this period acting as administrator for the adjacent territories belonging to the company (see BRITISH CENTRAL AFRICA). Farther west, Lewanika, the king of the Barotse, signed, on the 27th of June 1890, a treaty placing his country under the protection of the Chartered Company, which, while obtaining all mineral rights, undertook not to interfere in the internal administration of Barotseland. In securing a position thus early in Barotseland, Rhodes's aim was to prevent the farther extension eastward of the Portuguese province of Angola. The subsequent development of Barotseland had little direct connexion with the events in other parts of Rhodesia (see BAROTSE and LEWANIKA). The growth of territory and the outlay on Matabeleland led to a great increase of expenditure, and the capital of the company was raised to £2,000,000 in November 1893, and to £2,500,000 in July 1895.

In every step taken by the company the guiding hand was that of Cecil Rhodes, a fact which received recognition when, by a proclamation of the 3rd of May 1895, the company's territory received officially the name of "Rhodesia." During this year there was great activity in exploiting Matabeleland. "Stands" or plots were sold at extraordinary prices in Bulawayo; 539 fetched a total of £153,312, about £285 a stand. In within nine months Bulawayo had a population of 1900 whites, and in the various goldfields there were over 2000 prospectors. The construction of telegraphs proceeded with rapidity and by the end of 1895, 500 m. of new lines had been constructed, making about 1500 in all. A new company, the African Transcontinental Company, had been founded under the auspices of Rhodes, with the ultimate purpose of connecting the Cape with Cairo. By the end of 1895, 133 m. of these lines had been laid. At this time too, the railway from Cape Town had passed Mafeking and was approaching the Rhodesian frontier, while on the east coast the line to connect Salisbury with Beira was under construction.

In November 1895 the crown colony of British Bechuanaland was annexed to Cape Colony, and the Chartered Company desired to take over the administration of the Bechuanaland protectorate, which stretched between the newly annexed portion of Cape Colony and Matabeleland, and through which the railway to Bulawayo had to pass. The British government consented, and arrangements were made for the transfer. The company's police were moved down to a camp in the protectorate at Pitsani Potlogo. It was from this place that on the 29th of December Jameson crossed the Transvaal border and marched on Johannesburg, in his disastrous attempt to upset President Kruger's administration. The "Jameson Raid" put an end to the proposed transfer of the protectorate to the Chartered Company, and caused a serious crisis in its affairs. Rhodes resigned his position as managing director, and Alfred Beit

retired from the directorate in London. Jameson was, on the 9th of January 1896, officially removed from his office of administrator of the company's territories, and was succeeded by Earl Grey. Just at this time rinderpest made its appearance in southern Rhodesia, carrying off large herds of cattle, and this was followed in March 1896 by a revolt of the Matabele, while in June the Mashona also rebelled. The occasion, but not the cause, of the Matabele rising was the withdrawal of the greater part of the company's force to take part in the Jameson Raid. The Matabele had various grievances, chiefly that after the war of 1893 they were treated as a conquered people. All able-bodied young men were required to work for the white farmers and miners a certain number of months per annum at a fixed rate of pay—a most irksome regulation, enforced, on occasions, by the native police in a tyrannical fashion. Another grievance was the seizure by the company, after the death of Lobengula, of the cattle of the Matabele—their chief source of wealth. Not only was there a first confiscation after the war, but subsequently there was a periodical taking away of cattle in small numbers—the company acting under the belief that nearly all the cattle in Matabeleland belonged to the king and were therefore lawfully theirs. However, before the end of 1895 the company had settled the question in agreement with the indunas, two-fifths of the cattle to go to the company and the remainder to become the absolute property of the natives. But it was neither the action of the company in the confiscation of cattle, nor the labour regulations, that induced the mass of the people to rebel; they were induced to act by chiefs who chafed under their loss of power and

The rebellions of 1896. position and imagined themselves strong enough to throw off the yoke of the conquerors. In the manner customary among savages the Matabele began hostilities by the murder of defenceless white settlers—men, women and children. Bulawayo was threatened, and soon all the country south of the Zambezi was in a state of rebellion. Imperial troops under Sir Frederick Carrington were hurried up to the assistance of such police as the British South Africa Company still had at its command. Volunteers were enrolled, and much fierce fighting followed. Rhodes hastened to Bulawayo, and after conferences with the military and other authorities he determined to go, with Dr Hans Sauer and Mr J. Colenbrander, a well-known hunter and pioneer intimately acquainted with the natives, and interview the chiefs. They went (September 1896) unarmed into the heart of the Matoppo Hills, and there arranged terms of peace with the indunas. The interview involved grave danger to the emissaries, and depended for its success entirely upon Rhodes's personality and influence over the native races, but it terminated what promised to be a long and disastrous native war. The Matabele, whose legitimate grievances were acknowledged and met, ceased the war after the indaba with Rhodes; the Mashona revolt continued, and was not finally crushed until October 1897, though all danger to settlers was over six months previously. At this time the rinderpest had carried off nearly all the cattle in the country—a disaster which, together with the destruction of grain during the war, had brought the natives almost to starvation—and steps had to be taken to supply their needs. Many of the white settlers too were reduced to sore straits and required assistance. The rebellions had cost the company fully £2,500,000, and to meet the debt incurred an additional capital of £1,500,000 was raised in 1898. At the meeting of the company in April 1898, at which this step was taken, Rhodes was re-elected a director.

The events of 1896—the Jameson Raid and the rebellions—caused the imperial government to remodel the constitution of Rhodesia. The armed forces of the company had already been placed under the direct control of the crown, and on the 20th of October 1898 an order in council was passed providing for the future regulation of the country. An imperial resident commissioner was appointed, who was also to be *ex officio* a member of the executive and legislative councils; and there was to be a legislative council, consisting of five nominated

and four elected members. The first meeting of the newly appointed council took place at Salisbury on the 15th of May 1899. Other changes, in the direction of giving more power to the non-official element, were made subsequently (see above, *Administration*).

While these political changes were being made the company and the settlers set to work to repair the losses by war and plague. In particular the policy of railway development was pushed forward, and in November 1897 the line from Cape Town reached Bulawayo. The Mashonaland railway connecting Salisbury with Beira was completed in May 1899. In the same year gold-mining on a considerable scale began, the output for the year being over 65,000 oz. In the early part of 1899 Rhodes visited London and Berlin in furtherance of his schemes for the transcontinental telegraph extension from Cape Town to Cairo, and the transcontinental railway. He endeavoured to obtain from the British Government the guarantee of a loan for extending the railway, to be raised at 3%, but was unsuccessful. He received, however, the support of various companies in Rhodesia, who amongst them subscribed £252,800 at 3% for the immediate extension of the railway for 150 miles; and in May he stated, at a meeting of the Chartered Company, that the Rhodesia Railways Limited would raise another £3,000,000 at 4%, to be guaranteed by the Chartered Company. In this way he hoped that the remaining 1050 miles of railway from Bulawayo to the frontier of German East Africa might be constructed. In Berlin, Rhodes had an interview with the German Emperor, when arrangements were arrived at for the passage of telegraph lines over German territory, and also in certain contingencies for the continuation of the transcontinental railway through German East Africa.

In many respects the country recovered rapidly from the disasters of 1896, one of the most important measures taken being the compulsory inoculation for rinderpest, which finally stamped out the disease in 1898-99. By the last balance-sheet issued by the company previous to the outbreak of the Boer War it would appear that the revenue of Rhodesia for the year ending the 31st of March 1898 amounted to £260,516 net, of which amount the sale of land plots accounts for £63,628; stamps and licences, £69,658; and posts and telegraphs, £46,745; so that the machinery of civilized life was already in full activity where eight years previously the only white inhabitants had been a few missionaries, hunters and traders. The government buildings were estimated in March 1898 to be worth £165,672, and the assessed value of the town property at Bulawayo was £2,045,000 and that at Salisbury £750,000. (Both those towns had been granted municipal government in 1897.) Education was arranged under the supervision of government inspectors, and various religious communities were also engaged in educational work. The country appeared indeed in 1899 to be starting on the road to industrial and agricultural prosperity, but an almost complete stop to progress resulted from the outbreak of the Boer War in October of that year. The company could point with satisfaction to the fact that Rhodesia contributed nearly 1500 men to the forces serving in the war, 12½% of the European population. Rhodesia itself was not subjected to invasion, but the withdrawal of so large a number of able-bodied men seriously interfered with the development of the country, the war not ending until June 1902. Throughout this period the natives, with few exceptions, remained peaceful and gave the administration no serious trouble.

Before the war ended, Cecil Rhodes, whose chief work during the period since the Raid had been the building up of the country which bore his name, was dead (26th of March 1902). Alfred Beit, who had in 1898 refused to rejoin the directorate, now consented (June 1902) to return to the board of the Chartered Company, on which he remained until his death in July 1906. The loss of Rhodes's guiding mind and inspiring personality was, however, manifest, and among the Rhodesians there arose

Agitation for self-government.

a feeling of discontent at the company's conduct of affairs. The company was willing on proper terms to hand over the administration to the colonists, and they secured the services of Sir George Goldie to examine the situation and report on what terms the transfer could be made. Sir George visited Rhodesia in 1903-4, and drew up a scheme which included the taking over by Rhodesia of the administrative liabilities incurred by the company, which would thus become a public debt. After consultation between leading Rhodesians and the directors of the company the scheme was abandoned, the Rhodesians considering the financial burden proposed too great for an infant colony. The company therefore continued the administration, devoting attention to the development of agriculture and mining. The two railway systems were linked together by a line from Bulawayo to Salisbury, and several short lines to mining properties were built. From Bulawayo the main line was continued to the Wankie coal-fields, thence to the Zambezi, bridged in 1905 just below the Victoria Falls. From the Zambezi the line went north-east, so as to render accessible the mineral wealth of Barotseland and that of Katanga on the Rhodesian-Congo frontier. Although Rhodesia was affected by the commercial depression which prevailed in South Africa for some years after the close of the war, its industries showed considerable vitality. In 1906 the gold output exceeded 500,000 oz., and in the financial year 1905-6 the revenue of Southern Rhodesia slightly exceeded the expenditure.

Only once (1895-96) in the first fifteen years following the settlement of the country had the company's annual revenue exceeded the amount expended in the same period. As a commercial undertaking, the company therefore was during this period of no pecuniary advantage to the shareholders. This was due in part to unforeseen and unavoidable causes, but it is also true that the founders of the company had other than commercial aims. Rhodes's chief ambition was to secure the country for Britain and to open it up to the energies of her peoples, and he succeeded in this aim. He acted more quickly, and in many ways more effectively, than the imperial government would have been able to act had it at the outset taken over the country. To the sturdy colonists Rhodes made available a land rich not only in gold, but in coal and other minerals, and with very great agricultural and pastoral resources, and all this was done without the cost of a penny to the imperial exchequer. Despite all drawbacks, an area (reckoning Southern Rhodesia only) considerably larger than that of the United Kingdom had in less than twenty years been endowed with all the adjuncts of civilization and made the home of thousands of settlers.

The progress made by the country in the five years 1906-10 demonstrated that the faith Rhodes and his colleagues had placed in it was not ill-founded. Although the white population increased but slowly, in all other respects healthy development took place, the element of speculation which had characterized many of the first attempts to exploit the land being largely eliminated. In 1906 Lord Selborne (the high commissioner) visited Rhodesia. He inquired into the various grievances of the settlers against the Chartered Company; held an indaba with Matabele indunas in the Matoppo Hills, and at Bulawayo had a conference with Lewanika, the paramount chief of the Barotse. In 1907 Dr Jameson and other directors of the Chartered Company travelled through Rhodesia, and the result was to clear up some of the matters in dispute between the settlers and the company. Southern Rhodesia had become self-supporting, and the essentially temporary nature of the existing system of government was recognized. But the company held that the time was not yet ripe for Southern Rhodesia to become a self-governing colony. The directors, however, adopted a more liberal land policy, the increased attention given to agriculture being a marked and satisfactory feature of the situation. Mining and railway development were also pushed on vigorously.

The movement for the closer union of the British South

African colonies excited lively interest in Southern Rhodesia. The territory, not possessing self-government, could not take part in the national convention which met at Durban in October 1908 on equal terms with the delegates of the Cape, &c. It was, however, represented by three delegates on the understanding that Rhodesia would not, for the time being at least, be included in any agreement which might be reached. The convention resulted in the union (on the 31st of May 1910) under one government of the Cape, Transvaal, Natal and Orange River colonies. The position of Rhodesia with respect to the Union was set forth in the South Africa Act 1909. It provides that "the king, with the advice of the Privy Council, may on addresses from the Houses of Parliament of the Union admit into the Union the territories administered by the British South Africa Company on such terms and conditions as to representation and otherwise in each case as are expressed in the addresses and approved by the king."

In Rhodesia itself at this time there was a widespread feeling that there was no urgency as to the territory joining the Union, and the opinion was held by many that a separate existence as a self-governing community would be preferable. A section of the settlers were content for the present to remain under the government of the Chartered Company.

BIBLIOGRAPHY.—1. Works dealing with the country before the establishment of British authority: David Livingstone, *Missionary Travels* (1857); T. Baines, *The Gold Regions of S.E. Africa* (1877); R. Gordon Cumming, *Five Years of a Hunter's Life in S.A.* (1890); K. Mauch, *Reisen im Inneren von Süd-Afrika* (1864); (Gotha, 1874); E. Holub, *Seven Years in South Africa* (1881); E. Mohr, *Two Years in Victoria Falls of the Zambezi* (1876); F. C. Selous, *A Hunter's Wanderings in Africa* (1881), and *Travel and Adventure in S.E. Africa* (1893); T. M. Thomas, *Eleven Years in Central South Africa* (n.d. [1872]); L. P. Bowler, *Facts about the Matabele, Mashona, &c.* (Pretoria, 1889); Rev. D. Carnegie, *Among the Matabele* (1894).

2. Since the British occupation: Bishop Knight-Bruce, *Memories of Mashonaland* (1895); J. C. Chadwick, *Three Years with Lobengula* (1894); D. C. de Waal, *With Rhodes in Mashonaland* (London, 1894); W. A. Wells and L. T. Collingridge, *The Downfall of Lobengula* (1894); A. R. Colquhoun, *Matabeleland* (n.d. [1894]); C. H. Donovan, *With Wilson in Matabeleland* (1894); A. G. Lenard, *How we made Rhodesia* (1896); Lord R. Churchill, *Men, Mines and Minerals in S.A.* (1895); E. Foa, *La Traversée de l'Afrique* (Paris, 1900); F. C. Selous, *Sunshine and Storm in Rhodesia* (the Matabele rising) (1896); R. S. S. Baden-Powell, *The Matabele Campaign, 1896* (1897); E. A. H. Alderson, *With the Mounted Infantry* (in Mashonaland) (1898); S. J. du Toit, *Rhodesia Past and Present* (1897); H. Hensman, *History of Rhodesia* (1900); H. P. N. Muller, *De Zuid-Afrikaansche Republiek en Rhodesia* (The Hague, 1896); W. H. Brown, *On the South African Frontier* (1899).

3. Economics, &c.: P. F. Ho, *Southern Rhodesia* (1909); *The Annual Reports of the British S.A. Co.*; C. T. Roberts, *The Future of Gold Mining in Mashonaland* (Salisbury, Rhodesia, 1898); *Southern Rhodesia; Information for Settlers* (1907); D. E. Hutchins, *Report . . . on Trees in Rhodesia* (Cape Town, 1903); *Handbook for Tourists and Sportsmen* (1907); A. H. Keane, *The Gold of Ophir* (1901); C. Peters, *The Eldorado of the Ancients* (1902); E. de Renty, *La Rhodesia* (Paris, 1907); *Proceedings of the Rhodesian Scientific Association* (1899—) (1st vol., Bulawayo, 1903); *The Rhodesian Agricultural Journal* (1st vol., Salisbury, Rhodesia, 1903). All treaties, &c., respecting Rhodesia, should be found in Hertlett's *Map of Africa by Treaty* (1909 ed.). For Blue Books concerning Rhodesia consult the *Colonial Office List* (annually). The best general map of S. Rhodesia is that published by the administration in 1909-10 (7 sheets on the 1:500000 scale).

For general works including Rhodesia see SOUTH AFRICA. § *Bibliography*. See also authorities cited under BRITISH CENTRAL AFRICA, BAROTSE, &c. (A. P. H.; F. R. C.)

RHODIUM [symbol Rh; atomic weight 102.9 (O=16)], in chemistry, a metallic chemical element found, associated with the other elements of the platinum group, in crude platinum ore, wherein it was discovered in 1803 by W. H. Wollaston (*Phil. Trans.*, 1804, p. 419). It may be obtained from the residues of platinum ore after treatment with aqua regia and removal of the platinum as chloroplatinate. The mother liquors are decomposed by treatment with metallic iron, the precipitate obtained being warmed with concentrated nitric acid and heated in an iron crucible with concentrated caustic potash. The residue thus obtained is mixed with salt and

¹ Unless otherwise stated, the place of publication is London.

heated in a current of chlorine, any iridium present being converted into its chloride by treatment with nitric acid and precipitated by ammonium chloride, whilst rhodium ammonium chloride goes into solution with its characteristic rose-red colour (C. E. Claus, *Jour. prakt. Chem.*, 1843-1845). For other methods of extraction see Gibbs, *ib.*, 1861, 84, p. 65; 1865, 94, p. 10; T. Wilm, *Bull. soc. chim.*, 1880 (2), 34, p. 679; E. Frémy, *Comptes rendus*, 1854, 38, p. 1008, &c.). The metal itself is best obtained by the reduction of chlorpurore rhodium chloride, $(Cl_2Rh_2 \cdot 10NH_3) \cdot Cl_4$, in a current of hydrogen, the metal after reduction being cooled in a stream of carbon dioxide (S. M. Jørgensen, *Zeit. anorg. Chem.*, 1903, 34, p. 82). It somewhat resembles aluminium in colour; its specific gravity varies from 11 to 12.1; and its specific heat is 0.05527 (V. H. Regnault, *Ann. chim. phys.*, 1861, 63, p. 15). It is less fusible than platinum. It oxidizes superficially when heated, and may be distilled in the electric furnace. It is insoluble in acids, but forms a soluble sulphate when fused with potassium bisulphate (a reaction which distinguishes it from the other metals of the platinum group). It oxidizes when fused with potassium hydroxide and potassium nitrate, to the dioxide, Rh_2O_3 . It absorbs hydrogen readily. Rhodium black is obtained by reducing rhodium salts with formic acid; by alcohol in the presence of alkali; or by precipitation with zinc and iron. A colloidal rhodium may be prepared by reducing the sesquichloride with hydrazine hydrate. Rhodium salts may be recognized by their characteristic reaction with freshly prepared sodium hypochlorite solution. A yellow precipitate is obtained, which on shaking for some time with acetic acid gradually dissolves to an orange-coloured solution. This solution after a short time deposits a grey precipitate, and the supernatant liquid becomes azure blue in colour (E. Demarçay, *Comptes rendus*, 1885, 101, p. 951).

Several oxides of rhodium are known. The monoxide, RhO , formed when the hydrated sesquioxide is heated (Claus) or when finely divided rhodium is heated in a current of air (Wilm), is a grey powder which is insoluble in acids. The sesquioxide, Rh_2O_3 , is a black insoluble powder, formed when the corresponding hydrate is heated. This hydrate, $Rh(OH)_3$, is obtained as a yellow powder, by decomposing rhodium salts (not the sulphate) with dilute solutions of the caustic alkalis. It is soluble in acids, and in the moist condition is also soluble in concentrated alkalis. A hydrated rhodium dioxide, $Rh_2O_2 \cdot 2H_2O$, is formed when chlorine is passed into a solution of the sesquioxide in concentrated caustic potash, or by adding an alkaline hypochlorite to a concentrated alkaline solution of rhodium and sodium chlorides. It is a greenish-black powder which is soluble in hydrochloric acid. Rhodium chloride, Rh_2Cl_6 , is obtained impure by heating the metal to red redness in a current of chlorine, or purer, by heating an alloy of rhodium and tin in chlorine or by heating the double ammonium rhodium chloride in chlorine at 440° C. (E. Leidié, *Ann. chim. phys.*, 1889, (6), 17, p. 265; *Comptes rendus*, 1899, 129, p. 1249). It is a red powder, which decomposes at a red heat, leaving a residue of the metal. It is insoluble in water and acids, but dissolves in concentrated solutions of potassium cyanide. The hydrate form $Rh_2Cl_6 \cdot 8H_2O$ is obtained impure by dissolving the hydrated sesquioxide in hydrochloric acid, by the action of hydrofluosilicic acid on potassium rhodium chloride, and by the action of chlorine on rhodium in the presence of sodium chloride. In the last method the product is dissolved in a dilute hydrochloric acid (1:1), and the solution saturated with hydrochloric acid gas at 0° C., allowed to stand for some time, decanted, and finally evaporated in vacuo (Leidié, *loc. cit.*). It forms a very deliquescent, red, crystalline form, which decomposes on exposure. It is very soluble in water, forming a yellow solution. It forms double salts with the alkaline chlorides.

Rhodium monosulphide, RhS , is formed when rhodium or rhodium ammonium chloride are heated with sulphur, and also by precipitating rhodium salts with sulphuretted hydrogen, the precipitate being dissolved in ammonium sulphide and thrown down again by dilute sulphuric acid (Lecoq de Boisbaudran, *Ber.*, 1883, 16, p. 579). It is a dark-coloured powder which is insoluble in acids and other solvents. It fuses at all its sulphur when heated in air. The disulphide, Rh_2S_2 , is prepared by heating anhydrous rhodium chloride, Rh_2Cl_6 , in a current of sulphuretted hydrogen at 360° C., or by passing the gas into a boiling solution of the chloride. It is a black powder which is insoluble in acids and in alkaline sulphides. It decomposes when strongly heated. Rhodium sulphate, $Rh_2(SO_4)_3$, is prepared by oxidizing the sulphide, by fusing the metal with acid potassium sulphate, or by the action of concentrated sulphuric acid on an alloy of rhodium and lead, or on the hydrated sesquioxide. It is a red powder which decomposes when heated or when boiled with much

water. It forms alums (Leidié, *Comptes rendus*, 1888, 107, p. 234). Rhodium potassium alum, $Rh_2(SO_4)_3 \cdot K_2SO_4 \cdot 24H_2O$, is obtained by dissolving the sesquioxide in sulphuric acid and adding two-thirds of the calculated amount of potassium sulphate to the solution (A. Piccini and L. Marino, *Zeit. anorg. Chem.*, 1901, 27, p. 62). It crystallizes in cubes. Rhodium cyanide, $Rh_3(CN)_6$, is a carmine-red powder formed when rhodium potassium cyanide is boiled with acetic acid. Rhodium potassium cyanide, $K_3Rh_3(CN)_6$, is formed when the sesquioxide is dissolved in caustic potash and an excess of hydrocyanic acid added gradually, the solution being then evaporated in vacuo. It is a colourless crystalline solid soluble in water, and isomorphous with the corresponding iron, cobalt, chromium and manganese compounds.

The rhodium ammonia salts correspond almost with the similar cobalt compounds and may be divided into three series—namely, hexammine salts (hexa-ammonia), $[Rh(NH_3)_6]X_3$; aquopentamine salts (roseo-salts), $[Rh(NH_3)_5 \cdot H_2O]X_3$; and pentamine salts (purore-salts), $[Rh(NH_3)_4 \cdot 2H_2O]X_3$. (See S. F. Jørgensen, C. W. Blomstrand, *Jour. prakt. Chem.*, 1882, et seq.)

The atomic weight of rhodium has been determined by S. F. Jørgensen (*Jour. prakt. Chem.*, 1883, 27, p. 486), by the analysis of chlorpurore rhodium chloride, the mean value obtained being 103; whilst K. Scharf and K. Kobbé (*Zinn.*, 1890, 260, p. 314), by analysis of the double chloride and sulphate, obtained as a mean value 102.86.

RHODOCHROSITE, a mineral species consisting of manganese carbonate, $MnCO_3$, crystallizing in the rhombohedral system and isomorphous with calcite. It usually occurs as cleavable, compact or botryoidal masses, distinct crystals being somewhat rare; these often have the form of the primitive rhombohedron, parallel to the faces of which there are perfect cleavages. When pure, the mineral contains 47.7% of manganese, but this is usually partly replaced by varying amounts of iron, and sometimes by calcium, magnesium, zinc, or rarely cobalt (cobalt-manganese-spar). With these variations in chemical composition the specific gravity varies from 3.45 to 3.60; the hardness is 4. The colour is usually rose-red, but may sometimes be grey to brown. The name rhodochrosite, from the Greek $\rho\acute{o}\delta\omicron\chi\rho\omicron\varsigma$ (rose-coloured), has reference to the characteristic colour of the mineral: manganese-spar and dialogite are synonyms. It is found in mineral veins with ores of silver, lead, copper, &c., or in deposits of manganese ore. Crystals have been met with in the mines at Kapnik-Bánya and Nagyág near Déva in Transylvania and at Diez in Nassau, but by far the best specimens are from Colorado. The mineral is used to a limited extent in the manufacture of spiegeleisen and ferromanganese.

RHODODENDRON. Classical writers, such as Dioscorides and Pliny, seem, from what can be ascertained, to have called the oleander (*Nerium Oleander*) by this name, but in modern usage it is applied to a large genus of shrubs and trees belonging to the order of heaths (Ericaceae). No adequate distinction can be drawn between this genus and *Asalea* (q.v.)—the proposed marks of distinction, however applicable in particular cases, breaking down when tested more generally. The rhododendrons are trees or shrubs, never herbs, with simple, evergreen or deciduous leaves, and flowers in terminal clusters surrounded in the bud by bud-scales but not as a rule by true leaves. The flowers are remarkable for the frequent absence or reduced condition of the calyx. The funnel- or bell-shaped corolla, on the other hand, with its five or more lobes, is usually conspicuous, and in some species so much so as to render these plants greatly prized in gardens. The free stamens are usually ten, with slender filaments and anthers opening by pores at the top. The ovary is five- or many-celled, ripening into a long woody pod which splits from top to bottom by a number of valves, which break away from the central placenta and liberate a large number of small branlike seeds provided with a membranous wing-like appendage at each end. The species are for the most part natives of the mountainous regions of the northern hemisphere, extending as far south as the Malay Archipelago and New Guinea, but not hitherto found in South America or Australia. None are natives of Britain. They vary greatly in stature, some of the alpine species being mere pygmies with minute leaves and tiny blossoms, while some of the Himalayan species are moderate-sized trees with superb flowers. Some are

epiphytal, growing on the branches of other trees, but not deriving their sustenance from them. The varieties grown in gardens are mostly grafted on the Pontic species (*R. ponticum*) and the Virginian *R. catalwbiense*. The common Pontic variety is excellent for game-covert, from its hardness, the shelter it affords, and the fact that hares and rabbits rarely eat it. Variety of colour has been infused by crossing or hybridizing the species first named, or their derivatives, with some of the more gorgeously coloured Himalayan-American varieties. In many instances this has been done without sacrifice of hardihood.

Some of the finest hybrids for the open air, especially in favoured spots, are *ataleucera* (scarlet); *Harrisii* (rosy crimson); *Kevense* (rose); *Luscombei* (rose-pink); *Manglessi* (white); *nobleanum* (crimson), one of the first to flower after Christmas; *praecox* (rose-purple); and *Shilsoni* (crimson). There are almost countless colour variations of these, but one of the most exquisite of late years is that known as *Pink Pearl*, with large clear rosy-pink blossoms of great purity. What are termed greenhouse rhododendrons are derivatives from certain Malayan and Javanese species, and are consequently much more tender. They are characterized by the possession of a cylindrical (not funnel-shaped) flower-tube and other marks of distinction. The foliage of rhododendrons contains much tannin, and has been used medicinally. Whether the honey mentioned by Xenophon as poisonous was really derived from plants of this genus as alleged is still an open question.

Cultivation.—The hardy evergreen kinds are readily propagated by seed, by layers, and by grafting. Grafting is resorted to only for the propagation of the rarer and more tender kinds. Loamy soil containing a large quantity of peat or vegetable humus is essential, the roots of all the species investigated being associated with a fungus partner (*mycorrhiza*). An excess of lime or chalk in the soil proves fatal to rhododendrons and their allies sooner or later—a fact overlooked by many amateurs. The hardy deciduous kinds are valuable for forcing, and withstand cold-storage treatment well. The tender Malayan and Javanese species thrive in warm greenhouse temperature, but are difficult to cultivate where the water is very alkaline.

RHODONITE, a member of the pyroxene group of minerals, consisting of manganese metasilicate, $MnSiO_3$, and crystallizing in the anorthic system. It commonly occurs as cleavable to compact masses with a rose-red colour; hence the name, from the Greek $\rho\acute{o}\delta\omicron\nu$ (a rose). Crystals often have a thick tabular habit; there are perfect cleavages parallel to the prism faces with an angle of $8^\circ 31\frac{1}{2}'$. The hardness is 5½–6½, and the specific gravity 3.4–3.68. The manganese is often partly replaced by iron and calcium, which may sometimes be present in considerable amounts; a greyish-brown variety containing as much as 20% of calcium oxide is called "bustamite"; "fowlerite" is a zinciferous variety containing 7% of zinc oxide. Rhodonite is a mineral liable to alteration, with the formation of manganese carbonate, hydrous silicate or oxides. The compact material, which is cut and polished for ornamental purposes, is often marked in a striking manner by veins and patches of these black alteration products. At Syedelnikova, near Ekaterinburg in the Urals, compact material of a good colour occurs in a clay-slate and is extensively quarried; boulders of similar material found at Cummington in Massachusetts ("cummingtonite") have also been worked as an ornamental stone. In the iron and manganese mines at Pajsbjerg near Filipstad and Långban in Vermland, Sweden, small brilliant and translucent crystals ("pajsbjergite") and cleavage masses occur. Fowlerite occurs as large, rough crystals, somewhat resembling pink feldspar, with franklinite and zinc ores in granular limestone at Franklin Furnace in New Jersey.

RHOECUS, a Samian sculptor of the 6th century B.C. He and his son Theodoros were especially noted for their work in bronze. Herodotus says that Rhoecus built the temple of Hera at Samos. In the temple of Artemis at Ephesus was a marble figure of night by Rhoecus. His name has been found on a fragment of a vase which he dedicated to Aphrodite at Naucratis. His sons Theodoros and Telesmos made a statue of the Pythian Apollo for the Samians.

RHONDDA (formerly YSTRADYFODWG), an urban district and parliamentary division of Glamorganshire, South Wales. It is 12 m. long by about 4½ m. across at its widest part, and comprises two main valleys, named after their respective rivers,

Rhondda Fawr (9½ m.) and Rhondda Fach, or the lesser (6½ m.), running S.E. and S.W. respectively till their junction at Porth, and thence the single valley for upwards of a mile farther down the boundary of the Pontypridd urban district at Trehafod. The valleys are narrow and tortuous, and their lateral boundaries are formed by steep hills varying in height from about 500 ft. on either side of Trehafod to 1340 ft. on the N.E. of Maerdy in the lesser Rhondda and 1742 ft. on the S.W. of Treherbert in the main valley, while the mountains at the upper end of the latter valley culminate in Carn Moesen (1950 ft.). The two valleys are separated by the steep ridge of Cefn-rhondda, which ranges from 600 ft. high above Porth to 1690 ft. near the upper end of the district. There are a few tributary valleys of which Cwmparc, Clydach Vale and Cymmer are the chief. Though the urban district measures 23,884 acres, the area built upon is generally a narrow strip on either side of each river except at Treorky and Ton, where the valley of the Rhondda Fawr opens out a little. In 1877 the ancient parish of Ystradyfodwg (with the omission of the township of Rhigos, which lies beyond the mountains to the north) was formed into an urban district bearing the parish name, the area having previously been part of a rural district under the Pontypridd rural sanitary authority. In October 1879, portions of the parishes of Llanwonno and Llantrisant, comprising over 5000 acres, were added to the urban area, the whole being consolidated in 1894 into one civil parish. In 1897, the name of the urban district was changed into Rhondda. The Taff Vale railway runs up each of the two valleys from a junction at Porth (16 m. N.W. of Cardiff), and has five stations in the main valley and four in the lesser one. From Porth it runs to Pontypridd, whence there is communication with Cardiff, Barry and Newport. The Rhondda and Swansea Bay railway (authorized in 1882, opened in 1890, and now worked by the Great Western) connects the upper end of the main valley, where it has a station, Blaen-rhondda, with Port Talbot, Neath and Swansea (31 m. distant) by means of a line which has a tunnel 3443 yds. long.

The district occupies almost the centre of the eastern division of the South Wales coal-field, and its coal, upon which the inhabitants are almost entirely dependent, is unsurpassed for its steam-raising properties. In common with other East Glamorgan coal it became commercially known as Cardiff coal from the fact that Cardiff was at first its only port of shipment. The development of the Rhondda coal-field was later in date than those of Aberdare and Merthyr, and it received its chief impetus from the American Civil War. Thus the population of the parish (excluding Rhigos), which was 576 in 1811, 951 in 1851 and 3035 in 1861, increased to 16,914 in 1871. When the boundaries of the district were extended in 1879 the population of the enlarged area was calculated by the registrar-general to be 23,950 in 1871, but it reached 55,632 in 1881, and 113,735 in 1901, showing an increase of 104% in the previous twenty years. In 1901, 35.4% of the population of three years of age and upwards spoke English only, 11.4% spoke Welsh only, the remainder being bilingual.

Ecclesiastically the parish of Ystradyfodwg was an ancient chapelry dependent on Llantrisant. The old parish church at Ton Pentre (in substitution for which a new church was built in 1893–94) served the whole parish till past the middle of the 19th century. Between 1879 and 1900 the ancient parish (excluding Rhigos) was divided into seven ecclesiastical parishes, the six new ones being Llwyn-y-pia (1879), Tylorstown (1887), Ynysuir (1887), Treherbert (1893), Cwmparc (1898) and Ferndale (1900). The additional area brought into the urban district in 1879 comprises two other ecclesiastical parishes, Cymmer and Porth (1894), and Dinas and Penygraig (1901). These nine parishes, comprised in the urban district, have twenty churches and eighteen mission-rooms, with accommodation for about 12,000 persons. This area, together with Pontypridd, Glyntaff and Llanwonno, form the rural deanery of Rhondda in the archdeaconry and diocese of Llandaff. There were at the end of 1905 over one hundred and fifty nonconformist chapels and mission rooms, with accommodation for over 85,000 persons, of which provision nearly two-thirds was in chapels with Welsh services. There is a Roman Catholic church at Tonypanyd. The public buildings include the council house and offices of the district council, erected in 1883–84 for the local board at Pentre, libraries and workmen's institutes at Ystrad (1895), and Cymmer

(1893), Maerdy (1905), Dinas (1893), and Fernalde public halls, the property of a private company at Treherbert (1872), and Tonymandy (1891) and a county intermediate school at Porth. By means of a tunnel about 2100 yds. long water is obtained for the greater part of the main valley from the lake of Llyn Fawr on the Neath side of the mountain range which shuts in the valley on the north. This lake has been converted into a storage reservoir of about 167 million gallons capacity. The rest of the district is supplied from the Pontypridd Water Company's works above Maerdy in the lesser valley.

The ancient parish (excluding Rhigos) was formed into a parliamentary constituency with one member in 1885. The present urban district substantially corresponds to the ancient territorial division of Glyn-rhondda, one of the four commotes of the cantred of Penychen, and subsequently, in Norman times, one of the twelve "members" of the lordship of Glamorgan. Its Welsh lords enjoyed a large measure of independence and had their own courts, in which Welsh law was administered down to 1535, when the lordship was fully incorporated in the county of Glamorgan. On the ridge of Cefn-rhondda between the two valleys was the Franciscan monastery of Penrhys, famous for its image of the Virgin and for its holy well which attracted large pilgrimages. It was dissolved about 1415, probably owing to its having supported Glyndwr in his rebellion. Edward II. came here from Neath Abbey and was captured on the 16th of November 1326, either at Penrhys, or between it and Llantrisant. (D. L. T.)

RHONE (Fr. *Rhône*, Lat. *Rhodanus*), one of the most important rivers in Europe, and the chief of those which flow directly into the Mediterranean. It rises at the upper or eastern extremity of the Swiss canton of the Valais, flows between the Bernese Alps (N.) and the Lepontine and Pennine Alps (S.) till it expands into the Lake of Geneva, winds round the southernmost spurs of the Jura range, receives at Lyons its principal tributary, the Saône, and then turns southward through France till, by many mouths, it enters that part of the Mediterranean which is rightly called the Golfe du Lion (sometimes wrongly the Gulf of Lyons). Its total length from source to sea is 504½ m. (of which the Lake of Geneva claims 45 m.), while its total drainage area is 37,798 sq. m., of which 2772 sq. m. are in Switzerland (405 sq. m. of the Swiss portion being composed of glaciers), and its total fall 5808 ft. Its course (excluding the Lake of Geneva, *q.v.*) naturally falls into three divisions: (1) from its source to the Lake of Geneva, (2) from Geneva to Lyons, and (3) from Lyons to the Mediterranean.

1. From its source to the lake the Rhone is a purely Alpine river, flowing through the great trench which it has cut for itself between two of the loftiest Alpine ranges, and which (save a bit at its north-west end) forms the Canton of the Valais. Its length is 105½ m., while its fall is 4679 ft. It issues as a torrent, at the height of 5909 ft., from the great Rhone glacier at the head of the Valais, the recent retreat of this glacier having proved that the river really flows from beneath it, and does not take its rise from the warm springs that are now at some distance from its shrunken snout. It is almost immediately joined on the left by the Mutt torrent, coming from a small glacier to the S.E., and then flows S.W. for a short distance past the well-known Gletsch Hotel (where the roads from the Grimsel and the Furka Passes unite). But about half a mile from the glacier the river turns S.E. and descends through a wild gorge to the more level valley, bending again S.W. before reaching the first village, Oberwald. It preserves this south-westerly direction till Martigny. The uppermost valley of the Rhone is named Goms (Fr. *Conches*), its chief village being Münster, while Fiesch, lower down, is well known to most Swiss travellers. As the river rolls on, it is swollen by mountain torrents, descending from the glaciers on either side of its bed—so by the Geren (left), near Oberwald, by the Eginen (left), near Ulrichen, by the Fiesch (right), at Fiesch, by the Binna (left), near Grogliens, by the Massa (right), flowing from the great Aletsch glaciers, above Brieg. At Brieg the Rhone has descended 3678 ft. from its source, has flowed 28 m. in the open, and is already a considerable stream when joined (left) by the Saltine, descending from the Simplon Pass. Its course below Brieg is less rapid than

before and lies through the alluvial deposits which it has brought down in the course of ages. The valley is wide and marshy, the river frequently overflowing its banks. Further mountain torrents (of greater volume than those higher up) fall into the Rhone as it rolls along in a south-westerly direction towards Martigny: the Visp (left), coming from the Zermatt valley, falls in at Visp, at Gampel the Lonza (right), from the Lötschen valley, at Leuk the Dala (right), from the Gemmi Pass, at Sierre the Navizen (left), from the Einfish or Anniviers valley, at Sion, the capital of the Valais, the Borgne (left) from the Val d'Hérens; soon the Rhone is joined by the Morgé (right), flowing from the Sanetsch Pass, and the boundary in the middle ages between Episcopus Valais to the east and Savoyard Valais to the west, and at Martigny by the Dranse (left), its chief Alpine tributary, from the Great St Bernard and the Val de Bagnes. At Martigny, about 50 m. from Brieg, the river bends sharply to the N.W., and runs in that direction to the Lake of Geneva. It receives the Salanfe (left), which forms the celebrated waterfall of Pissevaux, before reaching the ancient town and abbey of St Maurice (93m.). Henceforward the right bank is in the canton of Vaud (conquered from Savoy in 1475) and the left bank in that of the Valais (conquered similarly in 1536), for St Maurice marks the end of the historical Valais. Immediately below that town the Rhone rushes through a great natural gateway, a narrow and striking defile (now strongly fortified), which commands the entrance of the Valais. Beyond, the river enters the wide alluvial plain, formerly occupied by the south-eastern arm of the Lake of Geneva, but now marshy and requiring frequent "correction." It receives at Bex the Avançon (right), flowing from the glaciers of the Diablerets range, at Monthey the Vièze (left), from Champéry and the Val d'Illicz, and at Aigle the Grande Eau (right), from the valley of Ormonts-dessus. It passes by the hamlet of Port Valais, once on the shore of the lake, before expanding into the Lake of Geneva, between Villeneuve (right) and St Gingolph (left). During all this portion of its course the Rhone is not navigable, but a railway line runs along it from Brieg in about 72 m. to either Villeneuve or Le Bouveret.

2. On issuing at Geneva from the lake the waters of the Rhone are very limpid and blue, as it has left all its impurities in the great settling vat of the lake, so that Byron might well speak of the "blue rushing of the arrowy Rhone" (*Childe Harold*, canto iii. stanza 71). But about half a mile below Geneva this limpidity is disturbed by the pouring in of the turbid torrent of the Arve (left), descending from the glaciers of the Mont Blanc range, the two currents for some distance refusing to mix. The distance from Geneva to Lyons by the tortuous course of the Rhone is about 124 m., the fall being only about 689 ft. The characteristic feature of this portion of the course of the Rhone is the number of narrow gorges or *cuses* through which it rushes, while it is forced by the southern spur of the Jura to run in a southerly direction, till, after rounding the base of that spur, it can flow freely westwards to Lyons. About 12 m. S. of Geneva the Rhone enters French territory, and henceforth till near Lyons forms first the eastern, then the southern boundary of the French department of the Ain, dividing it from those of Haute Savoie and Savoie (E.) and that of the Isère (S.). Soon after it becomes French the river rushes furiously through a deep gorge, being imprisoned on the north by the Crédo and on the south by the Vuache, while the great fortress of l'Écluse guards this entrance into France. The railway pierces the Crédo by a tunnel. In the narrowest portion of this gorge, not far from Bellegarde at its lower end, there formerly existed the famous *Perte du Rhône* (described by Saussure in his *Voyages dans les Alpes*, chapter xvii.), where for a certain distance the river disappeared in a subterranean canal; but this natural phenomenon has been destroyed, partly by blasting, and partly by the diversion of the water for the use of the factories of Bellegarde. At Bellegarde the Valserine flows in (right), and then the river resumes its southerly direction, from which the great gorge had deflected it for a while. Some way below Bellegarde, between Le Parc and Pymont, the

Rhone becomes officially "navigable," though as far as Lyons the navigation now consists all but wholly of the floating of flat-bottomed boats, named *rigues*, laden chiefly with stone quarried from the banks of the river. Above Seyssel (11 m. from Bellegarde) the Usses (left) joins the Rhone, while just below that village the Fier (left) flows in from the Lake of Annecy. Below the junction of the Fier the hills sink on either side, the channel of the river widens, and one may say that it leaves the mountains for the plains. At Culoz (41½ m. by rail from Geneva) the railway from Geneva to Lyons (105 m.) quits the Rhone in order to run west by a direct route past Ambérieu. The Rhone continues to roll on southwards, but no longer (as no doubt it did in ancient days) enters the Lac du Bourget, of which it receives the waters through a canal, and then leaves it on the east in order to run along the foot of the last spur of the Jura. It flows past Yenne (left) and beneath the picturesque fortress (formerly a Carthusian monastery) of Pierre Châtel (right) before it attains the foot of the extreme southern spur of the Jura, at a height of 606 ft., not far from the village of Cordon, and just where the Guiers flows in (left) from the mountains of the Grande Chartreuse. This is nearly the last of the *côtes* through which the river has to make its way. The very last is at the Pont du Saut or Sault, a little S. of Lagnieu. The river now widens, but the neighbouring country is much exposed to inundations. It receives (right) its most important tributary in this part of its course, the Ain, which descends from the French slope of the Jura and is navigable for about 60 m. above its junction with the Rhone. Farther down the Rhone meanders for a time with shifting channels in a bed about 2 m. broad, but it gathers into a single stream before its junction with the Saône, just below Lyons. The Saône (*q.v.*), which has received (left) the Doubs, is the real continuation of the Rhone, both from a geographical and a commercial point of view, and it is by means of canals branching off from the course of the Saône that the Rhone communicates with the basins of the Loire, the Seine, the Rhine and the Moselle. In fact, up to Lyons, the Rhone (save when it expands into the Lake of Geneva) is a huge and very unruly mountain torrent rather than a great European river.

3. Below Lyons, however, the Rhone becomes one of the great historical rivers of France. It was up its valley that the first Greek, then Latin civilization penetrated from the Mediterranean to Lyons, as well as in the 10th century the Saracen bandits from their settlement at La Garde Freinet, near the coast of Provence. Then, too, from Lyons downwards, the Rhone serves as a great medium of commerce by which central France sends its products to the sea. Its length from Lyons to the sea is some 230 m., though its fall is but 530 ft. But during this half of its course it can boast of having on its left bank (the right bank is very poor in this respect) such historical cities as Vienne, Valence, Avignon, Tarascon and Arles, while it receives (left) the Isère, the Drôme and the Durance rivers, all formed by the union of many streams, and bringing down the waters that flow from the lofty snowy Dauphiné Alps. The Ardèche is the only considerable affluent from the right. Near Arles, about 25 m. from the sea, and by rail 175½ m. from Lyons, the river breaks up into its two main branches, the Grand Rhone running S.E. and the Petit Rhone S.W.; they enclose between them the huge delta of the Camargue, which is cultivated on the banks of the river only, but elsewhere is simply a great alluvial plain, deposited in the course of ages by the river, and now composed of scanty pasturages and of great salt marshes. Between Lyons and the sea, the Rhone divides four departments on its right bank (Rhône, Loire, Ardèche and Gard) from as many on its left bank (Isère, Drôme, Vaucluse and Bouches du Rhône).

Consult in general Ch. Lenthéric, *Le Rhône—histoire d'un fleuve*, 2 vols. (Paris, 1892). (W. A. B. C.)

RHÔNE, a department of south-eastern France, formed in 1793 from the eastern portion of the department of Rhône-et-Loire, and comprising the old districts of Beaujolais, Lyonnais, Franc-Lyonnais, Forez and a small portion of Dauphiné. Pop.

(1906) 858,907. Area, 1104 sq. m. Rhône is bounded N. by the department of Saône-et-Loire, E. by Ain and Isère and S. and W. by Loire. The Saône and the Rhone form its natural boundary on the east. The department belongs almost entirely to the basin of the Rhone, to which it sends its waters by the Saône and its tributary the Azergues, and by the Gier. The mountains which cover the surface of the department constitute the watershed between the Rhone and the Loire, and from north to south form four successive groups—the Beaujolais Mountains, the highest peak of which is 3320 ft.; the Tarare group; the Lyonnais Mountains (nearly 3000 ft.); and Mont Pilat, the highest peak of which belongs to the department of Loire. The lowest point of the department (460 ft. above sea-level) is at the egress of the Rhone. The meteorological conditions vary greatly with the elevation and exposure. Snow sometimes lies in the mountains from November to April, while at Lyons and in the valleys the mean temperature in winter is 36° F. and in summer 70°, the annual mean being 53°. The average rainfall is somewhat higher than is general over France owing to the amount of the precipitation on the hilly region.

Good agricultural land is found in the valleys of the Saône and Rhone, but for the most part the soil is stony and only moderately fertile. Wheat, oats, rye and potatoes are extensively cultivated, but their importance is less than that of the vine, the hills of the Beaujolais on the right bank of the Saône producing excellent wines. Fruit trees, such as peaches, apricots, walnuts and chestnuts, grow well, but the wood in general is little more than copse and brushwood. Good pasture is found in the valleys of the Azergues and its affluents. Mines of iron-pyrites and coal and quarries of freestone are worked. The production of silk fabrics, the chief branch of manufacture, that of chemicals and machinery, together with most of the other industries of the department, are concentrated in Lyons (*q.v.*) and its vicinity. Tarare is a centre for the manufacture of muslin and embroidery. Oullins has large railway workshops belonging to the Paris-Lyon-Méditerranée railway, and there are important glass works at Givors. Cotton-spinning and weaving are carried on in several localities. The products of its manufactures, together with wine and brandy, form the bulk of the exports of the department; its imports comprise chiefly the raw material for its industries. It is served by the Paris-Lyon railway. The Rhone and the Saône and in the extreme south the canal of Givors are its navigable waterways. Lyons the capital is the seat of an archbishop and of a court of appeal and centre of an educational division (*académie*). The department is divided amongst the districts of the VII., VIII., XII., XIII. and XIV. army corps. There are two arrondissements (Lyons and Villefranche) subdivided into 29 cantons and 269 communes. The principal places besides Lyons are Givors, Tarare and Villefranche, which receive separate treatment.

RHONGEBIRGE, or DIE RHÖN, a mountain-chain of central Germany, running in a north-westerly direction from the Bavarian province of Lower Franconia to the Prussian province of Hesse-Nassau and the grand duchy of Saxe-Weimar, and divided by the Werra from the Thuringian Forest on the N. The other sides are bounded by the Fulda on the W. and the Sinn and Frankish Saab on the E. and S. Its length is 50 m., breadth 5-7 m., and its mean elevation 1900 ft. This district is divided into three groups—the southern, the high (Hohe) and the nearer (Vordere) Rhön. Of these the southern, a continuation of the Spessart, largely consists of flat conical masses and reaches its highest point in the Heiliger Kreuzberg (2900 ft.). The Hohe Rhön, beginning immediately to the north-west of the latter mountain, is a high plateau of red sandstone, covered with fens and basalt peaks. It is a wild, dreary, inclement tract of country, covered with snow for six months in the year and visited by frequent fogs and storms. It is said of it that whoever desires to experience a northern winter can spare himself a journey to the North Cape or Siberia, and find it in his native Rhön. There is little vegetation, and the inhabitants eke out a scanty sustenance from the cultivation of potatoes

and flax. The highest inhabited place is Frankenhausen, lying at a height of 2350 ft. with 6383 inhabitants (1900). The nearer (Vordere) Rhön, forming the northern side of the range, is more attractive, with forests and deep and fertile valleys.

See Lenk, *Zur geologischen Kenntnis der südlichen Rhön* (Würzburg, 1887); Scheidterwey, *Die Rhön und ihre wirtschaftlichen Verhältnisse* (Frankfurt, 1887); and Daniel, *Deutschland* (5th ed., Leipzig, 1898).

RHOXOLANI, a Sarmatian tribe defeated in the Crimea by Diophantus, general of Mithradates, c. 100 B.C., and by the Romans on the lower Danube c. A.D. 60, and also under M. Aurelius. They seem to have finally succumbed to the Goths.

RHUBARB. This name is applied both to a drug and to a vegetable.

1. The drug has been used in medicine from very early times, being described in the Chinese herbal *Pen-king*, which is believed to date from 2700 B.C. The name seems to be a corruption of *Rheum barbarum* or *Reu barbarum*, a designation applied to the drug as early as the middle of the 6th century, and apparently identical with the $\rho\eta\rho\rho$ or $\rho\acute{\epsilon}$ of Dioscorides, described by him as a root brought from beyond the Bosphorus. In the 14th century rhubarb appears to have found its way to Europe by way of the Indus and Persian Gulf to the Red Sea and Alexandria, and was therefore described as "East Indian" rhubarb. Some also came by way of Persia and the Caspian to Syria and Asia Minor, and reached Europe from the ports of Aleppo and Smyrna, and became known as "Turkey" rhubarb. Subsequently to the year 1653, when China first permitted Russia to trade on her frontiers, Chinese rhubarb reached Europe chiefly by way of Moscow; and in 1704 the rhubarb trade became a monopoly of the Russian government, in consequence of which the term "Russian" or "crown" rhubarb came to be applied to it. Urga was the great depot for the rhubarb trade in 1710, but in 1728 the depot was transferred to Kiachta. All rhubarb brought to the depot passed through the hands of the government inspector; hence Russian rhubarb was invariably good and obtained a remarkably high price. This severe supervision naturally led, as soon as the northern Chinese ports were thrown open to European trade, to a new outlet being sought; and the increased demand for the drug at these ports resulted in less care being exercised by the Chinese in the collection and curing of the root, so that the rhubarb of good quality offered at Kiachta rapidly dwindled in quantity, and after 1860 Russian rhubarb ceased to appear in European commerce. Owing to the expense of carrying the drug across the whole breadth of Asia, and the difficulty of preserving it from the attacks of insects, rhubarb was formerly one of the most costly of drugs. In 1542 it was sold in France for ten times the price of cinnamon and four times that of saffron, and in an English price list bearing date of 1657 it is quoted at 16s. per lb, opium being at that time only 6s. and scammony 12s. per lb.

The dose of rhubarb is anything from $\frac{1}{2}$ up to 30 grains, according to the action which is desired. The British Pharmacopoeia contains seven preparations, only one of which is of any special value. This is the Pulvis Rhei Compositus, or Gregory's powder, which is composed of 2 parts of rhubarb, 6 of heavy or light magnesia and 1 of ginger. The dose is 20 to 60 gr.

Rhubarb is used in small doses— $\frac{1}{2}$ to 2 gr.—as an astringent tonic, since it stimulates all the functions of the upper part of the alimentary canal. In many cases of torpid dyspepsia it is very efficient when combined with the subnitrate of bismuth and the bicarbonate of sodium. The more characteristic action of rhubarb, however, is purgation, which it causes in doses of 15 gr. and upwards. The action occurs within seven or eight hours, a soft, pulpy motion of a yellow colour being produced. The colour is due to the chrysoarobin, which is also the purgative constituent of the drug. Rhubarb is also a secretory cholagogue, increasing the amount of bile formed by the liver. The drug is apt to cause colic, and should therefore never be given alone. The ginger in Gregory's powder averts this unpleasant consequence of the aperient properties of rhubarb. The drug is peculiar in that the purgation is succeeded by definite constipation, said to be due to the rheotannic acid. This explanation is hardly satisfactory, however, since it is difficult to see how the rheotannic acid can be retained in the bowel during the process of purgation. Rhubarb has, therefore, definite indications and

contra-indications. It is obviously worse than useless in the treatment of chronic constipation, which it only aggravates. On the other hand, it is very valuable in children and others, when diarrhoea has been caused by an unsuitable dietary. The drug removes the indigestible residue of the food and then gives the bowel rest. Rhubarb is also useful in the weaning of infants, since it is partly excreted in the maternal milk, and gives it a bitter taste which has a distasteful effect on the child.

Some chrysoarobin is absorbed and is excreted in the urine, which it slightly increases and colours a reddish brown. The colour is discharged by the addition of a little dilute hydrochloric acid to the urine.

The botanical source of Chinese rhubarb cannot be said to have been as yet definitely cleared up by actual identification of plants observed to be used for the purpose. *Rheum palmatum*, *R. officinale*, *R. palmatum*, var. *langticum*, *R. colimianum* and *R. Franzensbachii* have been variously stated to be the source of it, but the roots produced by these species under cultivation in Europe do not present the characteristic network of white veins exhibited by the best specimens of the Chinese drug.

Chemistry.—The most important constituent of this drug, giving it its purgative properties and its yellow colour, is chrysoarobin, $C_{20}H_{20}O_6$, formerly known as rhein or chrysoflavin. The rhubarb of commerce also contains chrysoarobin acid, a dioxyethyl anthraquinone, $C_{14}H_8(CH_3O)_2(OH)_2$, of which chrysoarobin is a reduction product. Nearly 40% of the drug consists of calcium oxalate, which gives it its characteristic bitterness. There is also present rheotannic acid, which is of some practical importance. There are numerous other constituents, such as emodin, $C_{15}H_{10}O_5$, mucilage, resins, rheuonic acid, $C_{20}H_{20}O_6$, aporphetin, &c.

Production and Commerce.—Rhubarb is produced in the four northern provinces of China proper (Chih-li, Shan-se, Shen-se and Ho-nan), in the north-west provinces of Kan-suh, formerly included in Shen-se, but now extending across the desert of Gobi to the frontier of Tibet, in the Mongolian province of Tsing-hai, including the salt lake Koko-nor, and the districts of Tang-hai, Sifan and Tun-hua, in a mountainous part of the western provinces of Sze-chuen. Two of the most important centres of the trade are Siping-fu in the province of Kan-suh, and Kwanchien in Sze-chuen. From Shen-se, Kan-suh and Sze-chuen the rhubarb is forwarded to Hawkow, and thence carried to Shanghai, whence it is shipped to Europe. Lesser quantities are shipped from Tien-tsin, and occasionally the drug is exported from Canton, Amoy, Fuh-chow and Ning-po.

Very little is known concerning the mode of preparing the drug for the market. According to Mr Bell, who on a journey from St Petersburg to Peking had the opportunity of observing the plant in a growing state, the root is not considered to be mature until it is six years old. It is then dug up, usually in the autumn, and deprived of its cortical portion and smaller branches, and the larger pieces are divided in half longitudinally; these pieces are bored with holes and strung up on cords to dry, in some cases being previously subjected to a preliminary drying on stone slabs heated by fire underneath. In Bhutan the root is said to be hung up in a kind of drying room, in which a moderate heat is regularly maintained. The effect produced by the two drying processes is very different: when dried by artificial heat, the exterior of the pieces becomes hardened before the interior has entirely lost its moisture, and consequently the pieces decay in the centre, although the surface may show no change. These two varieties are technically known as kiln-dried and sun-dried; and it was on account of this difference in quality that the Russian officer at Kiachta had every piece examined by boring a hole to its centre.

European Rhubarb.—As early as 1608 Prosper Alpinus of Padua cultivated as the true rhubarb a plant which is now known as *Rheum rhaponticum*, a native of southern Siberia and the basin of the Volga. This plant was introduced into England through Sir Matthew Lister, physician to Charles I., who gave seed obtained by him in Italy to the botanist Parkinson. The culture of this rhubarb for the sake of the root was commenced in 1777 at Banbury, in Oxfordshire, by an apothecary named Hayward, the plants being raised from seed sent from Russia in 1762, and with such success that the Society of Arts awarded him a silver medal in 1789 and a gold one in 1794. The cultivation subsequently extended to Somersetshire, Yorkshire, and Middlesex, but is now chiefly carried on at Banbury. English rhubarb root is sold at a cheaper rate than Chinese rhubarb, and forms a considerable article of export to America, and is said to be used in Britain in the form of powder, which is of a finer yellow colour than that of Chinese rhubarb. The Banbury rhubarb appears to be a hybrid between *R. rhaponticum* and *R. undulatum*—the root, according to E. Colin, not presenting the typical microscopic structure of the former. More recently very

¹ According to Mr F. Newcombe, *Med. Press and Circ.*, August 2, 1882, the Chinese esteem the Shen-se rhubarb as the best, that coming from Kanchow being the most prized of all; Sze-chuen rhubarb has a rougher surface and little flavour, and brings only about half the price; Chung-chi rhubarb also is greatly valued, while the Chi-chuang, Tai-huang and Shan-huang varieties are considered worthless.

good rhubarb has been grown at Banbury from *Rheum officinale*, but these two varieties are not equal in medicinal strength to the Chinese article, yielding less extract—Chinese rhubarb affording, according to H. Seier, 58% English rhubarb 21% and *R. officinale* 17%. In France the cultivation of rhubarb was commenced in the latter half of the 18th century—*R. compactum*, *R. palmatum*, *R. rhaiponticum* and *R. undulatum* being the species grown. The cultivation has, however, now nearly ceased, small quantities only being prepared at Avignon and a few other localities.

The culture of *Rheum compactum* was begun in Moravia in the beginning of the present century by Frikyl, an apothecary in Auspitz, and until about fifty years ago the root was largely exported to Lyons and Milan, where it was used for dyeing silk. As a medicine 5 parts are stated to be equal to 4 of Chinese rhubarb. Rhubarb root is also grown at Auspitz in Moravia and at Ilmitz, Krennritz and Frauenkirchen in Hungary; *R. emodi* is said to be cultivated for the same purpose in Silesia.

Rhubarb is also prepared for use in medicine from wild species in the Himalayas and Java.

2. The rhubarb used as a vegetable consists of the leaf stalks of *R. rhaiponticum* and its varieties, and *R. undulatum*. It is known in America as pie-plant. Plants are readily raised from seed, but strong plants can be obtained in a much shorter time by dividing the roots. Divisions or seedlings are planted about 3 ft. apart in ground which has been deeply trenched and manured, the crowns being kept slightly above the surface. Rhubarb grows freely under fruit-trees, but succeeds best in an open situation in rich, rather light soil. The stalks should not be pulled during the first season. If a top-dressing of manure be given each winter a plantation will last good for several years. Forced rhubarb is much esteemed in winter and early spring, and forms a remunerative crop. Forcing under glass or in a mushroom house is most satisfactory, but open-ground forcing may be effected by placing pots or boxes over the roots and burying in a good depth of stable litter and leaves. Several other species, such as *R. palmatum*, *R. officinale*, *R. nobile* and others, are cultivated for their fine foliage and handsome inflorescence, especially in wild gardens, margins of shrubberies and similar places. They succeed in most soils, but prefer a rich soil of good depth. They are propagated by seeds or by division.

RHYL, a watering-place and urban district of Fint, N. Wales, practically equidistant by rail from Bangor (20½ m.) and Chester (30 m.), and 209 m. from London on the London & North-Western railway. Pop. (1901) 8473. It is situated near the mouth of the Clwyd. Formerly, like Llandudno, a small fishing village, the town has now all the appointments of a popular resort. In winter the gales often fill the streets to the depth of several feet, with drifts of sand from the surrounding dunes, which, however, are noted in summer for the dry and bracing air. The neighbouring country is interesting from its scenery and antiquities. Among the institutions of the town may be mentioned the Queen Alexandra Hospital (1902), and several hydropathic establishments and convalescent homes. The estuary harbours coasting vessels, and some shipbuilding is carried on. On the beach towards Prestatyn can be seen the remains of a submerged forest.

RHYME, more correctly spelt RIME, from a Provençal word *rim* (its customary English spelling is due to a confusion with *rhythm*), a literary ornament or device consisting of an identity of sound in the terminal syllables of two or more words. In the art of versification it signifies the repetition of a sound at the end of two or more lines in a single composition. This artifice was practically unknown to the ancients, and, when it occurs, or seems to occur, in the works of classic Greek and Latin poets, it must be considered to be accidental. The natural tendency of the writer of verse unconsciously to repeat a sound, however, is shown by the fact that there have been discovered nearly one thousand lines in the writings of Virgil where the final syllable rhymes with a central one, thus—

Bella per Emathios plus quam civilia campos.

It is more than doubtful, however, whether the difference of stress would not prevent this from sounding as a rhyme in an antique ear, and the phenomenon results more from the

contingencies of grammar than from intention on the part of the poet. Conscious rhyme belongs to the early medieval periods of monkish literature, and the name given to lines with an intentional rhyme in the middle is *Leonine verse*, the invention being attributed to a probably apocryphal monk Leoninus or Leonius, who is supposed to be the author of a history of the Old Testament preserved in the Bibliothèque Nationale of Paris. This "history" is composed in Latin verses, all of which rhyme in the centre. Another very famous poem in Leonine rhyme is the "De Contemptu Mundi" of Bernard of Cluny, which was printed at Bremen in 1595. Rhyme exists to satisfy the ear by the richness of repeated sound. In the beginnings of modern verse, alliteration, a repetition of a consonant, satisfied the listener. A further ornament was discovered when assonance, a repetition of the vowel-sounds, was invented. Finally, both of these were combined to procure a full identity of sound in the entire syllable, and rhyme took its place in prosody. When this identity of sound occurs in the last syllable of a verse it is the typical end-rhyme of modern European poetry. Recent criticism has been inclined to look upon the African church-Latin of the age of Tertullian as the starting-point of modern rhyme, and it is probable that the ingenuities of priests, invented to aid worshippers in hearing and singing long pieces of Latin verse in the ritual of the Catholic church produced the earliest conscious poems in rhyme. Moreover, not to give too great importance to the Leonine hexameters which have been mentioned above, it is certain that by the 4th century a school of rhymed sacred poetry had come into existence, classical examples of which we still possess in the "Stabat Mater" and the "Dies Irae." In the course of the middle ages, alliteration, assonance and end-rhyme held the field without a rival in vernacular poetry. There is no such thing, it may broadly be said, as medieval verse in which one or other of these distinguishing ornaments is not employed. After the 14th century, in the north of Europe, and indeed everywhere except in Spain, where assonance held a powerful position, end-rhyme became universal and formed a distinctive indication of metrical construction. It was not until the invention of Blank Verse (*q.v.*) that rhyme found a modern rival, and in spite of the successes of this instrument rhyme has held its own, at all events for non-dramatic verse, in the principal literature of Europe. Certain forms of poetry are almost inconceivable without rhyme. For instance, efforts have been made to compose rhymeless sonnets, but the result has been, either that the piece of blank verse produced is not in any sense a sonnet, or else that by some artifice the appearance of rhyme has been retained. In the heyday of Elizabethan literature a serious attempt was made in England to reject rhyme altogether, and to return to the quantitative measures of the ancients. The prime mover in this heresy was not a poet at all, but a pedantic grammarian of Cambridge, Gabriel Harvey (1545?–1630). He considered himself a great innovator, and for a short time he actually seduced no less melodious a poet than Edmund Spenser to abandon rhyme and adopt a system of accented hexameters and trimeters. Spenser even wrote largely in those measures, but the greater portion of his experiments in this kind, of which *The Dying Pelican* is supposed to have been one, have disappeared. From 1576 to 1579 the genius of Spenser seems to have been obscured by this error of taste, but he shook it off completely when he composed *The Shepherd's Calendar*. Harvey considered Richard Stonyhurst (1547–1618) the most loyal of his disciples, and this author published in 1582 four books of the *Aeneid* translated into rhymeless hexameters on Harvey's plan. The result remains, a portent of ugliness and cacophony. A far greater poet, Thomas Campion (1575–1620), returned to the attack, and in a tract published in 1602 advocated the remission of rhyme from lyrical poetry. He, by dint of a prodigious effort, produced some unrhymed odes which were not without charm, but the best critics of the time, such as Daniel, repudiated the innovation, and rhyme continued to have no serious rival except blank verse.

There have, from time to time, been made experiments of a similar nature, notably by Tennyson, but rhyme has retained its sway as an essential ornament of all English poetry which is not in blank verse. There have been not a few poems composed, principally in the nineteenth century, in rhymeless hexameters, and even the elegiac couplet has been attempted. The experiments of Longfellow, Clough, Kingsley and others demand respectful notice, but it is more than doubtful whether any one of these, even the mellifluous *Andromeda* of the last-named writer, is really in harmony with the national prosody.

In Germany a very determined attack on rhyme was made early in the seventeenth century, particularly by a group of aesthetic critics in the Swiss universities. They attacked rhyme as an artless species of sing-song, which deaden and destroyed the true movement of melody in the rhythm. The argument of this group of critics had a deep influence in German practice, and led to the composition of a vast number of works in unrhymed measures, in few of which, however, is now found a music which justifies the experiment. Lessing recalled the German poets to a sense of the beauty and value of rhyme, but the popularity of Klopstock and his imitators continued to exercise a great influence. Goethe and Schiller, without abandoning rhyme altogether, permitted themselves a great liberty in the employment of unrhymed measures and in imitation of classic metres. This was carried to still greater lengths by Platen and Heine, the rhymeless rhythm of the last of whom was imitated in English verse by Matthew Arnold and others, not without an occasional measure of success. In France, on the other hand, the empire of rhyme has always been triumphant, and in French literature the idea of rhymeless verse can scarcely be said to exist. There the *rima pleine* or *riche*, in which not merely the sound but the emphasis is perfectly identical, is insisted upon, and a poet who rhymed as Mrs Browning did, or made "flying" an equivalent in sound to "Zion," would be deemed illiterate.

In French, two species of rhyme are accepted, the feminine and the masculine. Feminine rhymes are those which end in a mute *e* masculine those which do not so end. The Alexandrine, which is the classical metre in French, is built up on what are known as *rimés croisés*, that is to say a couplet of masculine rhymes followed by a couplet of feminine, and that again by masculine. This rule is unknown to the medieval poetry of France.

In Italian literature the excessive abundance and facility of rhyme has led to a rebellion against its use, which is much more reasonable than that of the Germans, whose strenuous language seems to call for an emphatic uniformity of sound. But it was the influence of German aesthetics which forced upon the notice of Leopardi the possibility of introducing rhymeless lyrical measures into Italian verse, an innovation which he carried out with remarkable hardihood and success. The rhymeless odes of Carducci are also worthy of admiration, and may be compared by the student with those of Heine and of Matthew Arnold respectively. Nevertheless, in Italian also, the ear demands the pleasure of the full reiterated sound, and the experiments of the eminent poets who have rejected it have claimed respect rather than sympathy or imitation. At the close of the 19th century, particularly in France, where the rules of rhyme had been most rigid, an effort to modify and minimise these restraints was widely made. There is no doubt that the laws of rhyme, like other artificial regulations, may be too severe, but there is no evidence that the natural beauty which pure rhyme introduces into poetry is losing its hold on the human ear or is in any real danger of being superseded by accent or rhythm.

See Joseph B. Mayer, *A Handbook of Modern English Metre* (Cambridge, 1903); J. Minor, *Neuhochdeutsche Metrik* (Strassburg, 1893); J. B. Schütze, *Versuch einer Theorie des Reimes nach Inhalt und Form* (Magdeburg, 1802). (E. G.)

RHYMNEY, an urban district in the western parliamentary division of Monmouthshire, England, on the borders of Glamorganshire, 22 m. N. by W. of Cardiff, on the Rhymney, the London & North-Western, and the Brecon & Merthyr railways. Pop. (1901), 7015. The Rhymney river, in the upper valley of which this town lies, forms almost throughout its course, to the estuary of the Severn near Cardiff, the boundary between England and Wales (Monmouthshire and Glamorganshire).

In its upper part the valley, like others adjacent and parallel to it, is populous with mining townships, and the town of Rhymney owes its importance to the neighbouring coal-mines and to its iron and steel works, which employ nearly the whole population. The works of the Rhymney Iron Company, including blast furnaces and rolling mills, are among the largest of the kind in England.

RHYOLITE (Gr. *ῥέειν*, to flow, because of the frequency with which they exhibit fluxion structures), the group name of a type of volcanic rock, occurring mostly as lava flows, and characterized by a highly acid composition. They are the most siliceous of all lavas, and, with the exception of the dacites, are the only lavas which contain free primary quartz. In chemical composition they very closely resemble the granites which are the corresponding rocks of plutonic or deep-seated origin; their minerals also present many points of similarity to those of granite though they are by no means entirely the same. Quartz, orthoclase and plagioclase feldspars, and biotite are the commonest ingredients of both rocks, but the quartz of rhyolites is full of glass enclosures and the potash feldspar is pellicular sanidine, while the quartz of granite contains dust-like fluid cavities of very minute size and its potash feldspar is of the turbid variety which is properly called orthoclase. The granites also are holocrystalline, while in the rhyolites there are usually porphyritic crystals floating in a fine ground-mass. Rhyolites have also been called liparites because many of the lavas of the Lipari Islands are excellent examples of this group. Above all rocks they have a disposition to assume vitreous forms, as when fused they crystallize with great difficulty. Hence it has long baffled experimenters to produce rhyolite synthetically by fusion; it is stated that these difficulties have now been overcome, but geologists believe that the presence of steam and other gases in the natural state expedite crystallization. In crucibles these cannot be retained at the temperatures employed; when the rocks are melted the gases escape and on cooling a pure glass is formed. The vitreous forms of rhyolite are known as obsidian, perlite and pumice (*qq.*).

The minerals of the first generation, or phenocrysts, of rhyolite are generally orthoclase, oligoclase, quartz, biotite, augite or hornblende. The feldspars are usually glassy clear, small but of well-developed crystalline form: the potash feldspar is sanidine, usually Carlsbad twinned; the soda-lime feldspar is almost always oligoclase, with characteristic polysynthetic structure. Both of these may be corroded and irregular in their outlines; their cleavage and twinning then distinguish them readily from quartz. Glass enclosures, sometimes rectangular with small immobile bubbles, are frequent. The quartz occurs as blebs or sub-rounded grains, which are corroded double hexagonal pyramids. Its glass enclosures are many and nearly always rounded or elliptical in section. No proper cleavage is seen in the quartz, though arcuate (conchoidal) fractures may often be noticed; they may have been produced by strain on cooling. Phenocrysts of micropegmatite are known in some rhyolites; they may have the shape of feldspar or of quartz crystals; in the former case, Carlsbad twinning is by no means uncommon, but in other cases hour-glass structure is very conspicuous. Biotite is always deep brown or greenish brown, in small hexagonal tablets, generally blackened at their edges by magmatic corrosion. Muscovite is not known in rhyolites. Hornblende may be green or brown; in the quartz-pantalierites it sometimes takes the form of strongly pleochroic brown coarsite. Like biotite it is eumorphic but often corroded in a marked degree. Augite, which is equally common or more common than the other ferro-magnesian minerals, is always green; its crystals are small and perfectly shaped, and corrosion phenomena are very rarely seen in it. Zircon, apatite and magnetite are always present in rhyolites, their crystals being often beautifully perfect though never large. Olivine is never a normal ingredient, but occurs in the hollow spherulites or lithophysae of some rhyolites with garnet, tridymite, topaz and other minerals which indicate pneumatolytic action. Among the less common accessory minerals of the rhyolites are cordierite in crystals which resemble hexagonal prisms but break up under polarized light into six radiating sectors owing to complicated twinning; they weather to green aggregates of chlorite and muscovite (pinite); garnet, sphene and orthite may also be met with in rhyolites.

The ground-mass of rhyolitic rocks is of three distinct types which are stages in crystalline development, viz. the vitreous, the felsitic or cryptocrystalline, and the microcrystalline. Hence some authorities have proposed to subdivide the group

into the *sitrophyres*, the *felsophyres* and the *granophyres*, but this is not now in use, and the last of these terms has obtained a significance quite different from that originally assigned to it. Mixtures of the different kinds occur; thus a vitreous rhyolite has often felsitic areas in its ground-mass, and in the same lava flow some parts may be vitreous while others are felsitic. The vitreous rhyolites are identical in most respects with the obsidians, from which they can only be separated in an artificial classification; and in their glassy base the banded or eutaxitic, spherulitic and perlitic structures of pure obsidians are very frequently present (see OBSIDIAN; PERLITE). The felsiparites or liparites with stony ground-mass are especially common among the pre-Tertiary igneous rocks (see QUARTZ-PORPHYRY), as liparite glass is unstable and experiences devitrification in course of time. Many of these felsites have fluxion banding, spherulites and even perlitic cracks, which are strong evidence that they were originally glassy. In other cases a hyaloparite, obsidian, or pitchstone becomes felsitic along its borders and joint planes, or even along perlitic cracks, and we may assume that the once fibrous rock has changed into felsite under the action of percolating moisture or even by atmospheric decomposition. In many rhyolites the felsite is original and represents an incipient crystallization of the vitreous material which took place before the rock was yet cold. The felsite in turn is liable to change; it becomes a fine mosaic of quartz and alkali felspar; and in this way a matrix of the third type, the microcrystalline, may develop. This is proved by the occurrence of the remains of spherulitic and perlitic structures in rocks which are no longer felsitic or glassy. Many microcrystalline rhyolites have a ground-mass in which much felsitic matter occurs; but as this tends to recrystallize in course of time, the older rocks of this group show least of it. Whilst no quartz-bearing rhyolites are known to have been erupted in recent years, Lacroix proved that portions of the "dome" which rose as a great tower or column out of the crater of Mont Pelée after the eruption in 1906 contained small crystals of quartz in the ground-mass. The rock was an acid andesite, and it was ascribed by Lacroix to the action of steam retained in the rock under considerable pressure. The microcrystalline ground-mass of rhyolites is never micrographic as in the porphyries (granophyres); on the other hand it is often micropikilitic, consisting of small felspars, often sub-rectangular, embedded in little rounded or irregular plates of quartz.

The ground-mass of rhyolites is liable to other changes, of which the most important are silicification, kaolinization and sericitization. Among the older rocks of this group it is the exception to find that secondary quartz has not been deposited in some parts of them. Often indeed the matrix is completely replaced by silica in the form of finely crystalline quartz or chalcedony, and these rocks on analysis prove to contain over 90% of silica. In the recent rhyolites of Hungary, New Zealand, &c., the deposit of coarse opal in portions of the rock is a very common phenomenon.

Kaolinization may be due to weathering, and the stony dull appearance of the matrix of many microcrystalline rhyolites is a consequence of the decomposed state of the felspar grains in them; it is even more typically developed by fumarole action, which replaces the felspars with soft, cloudy white products which belong to a mineral of the kaolin group. Sericitization, or the development of fine white mica after felspar, is usually associated with shearing, and is commonest in the older rhyolites.

Vesicular structure is very common in rhyolites; in fact the pumiceous obsidians have this character in greater perfection than any other rocks (see PUMICE); but even the felsophyrites are very often vesicular. The cavities are usually lined with opal and tridymite; in the older rocks they may be filled with agate and chalcedony. The "mill-stone porphyries," extensively used in Germany for grinding corn, are porous rhyolites; the abundance of quartz makes them hard, and their rough surfaces render them peculiarly suitable for this purpose. In some of them the cavities are partly

secondary. These rocks are obtained in the Odenwald, Thuringerwald and Fichtelgebirge.

In Britain a pale grey Tertiary rhyolite occurs at Tardree, Antrim (the only British rock containing tridymite), and in Skye. Felsitic rhyolites occur among the Old Red rocks of Scotland (Pentlands Hills, Lorne, &c.), in Devonshire, and in large numbers in North Wales. The Cornwarian rhyolites are often much altered and silicified; many of them have a nodular structure which is very conspicuous on weathered surfaces. The spheroids may be two or three inches in diameter; some of them are built up of concentric shells. Rhyolites are also known from Fishguard, Malvern, Westmorland and Co. Waterford. One of the oldest volcanic rocks of Britain (pre-Cambrian, Uriconian) is the spherulitic rhyolite of the Lea Rock near Wellington in Shropshire. It shows bright red spherulites in great numbers and is probably an obsidian completely devitrified. Perlitic structure is also visible in it.

In other parts of Europe rhyolites have a fairly wide distribution though they are not very numerous. In Hungary (Hlinik, &c.) there are many well-known examples of this class. They extend along the margin of the Carpathians and are found also in Siebenbürgen. In Italy they occur in the Euganean Hills and the Lipari Islands; the latter being the principal source of pumice at the present day. Rhyolites of Recent age occur in Iceland (Myvatn, &c.), where they are characterized by the frequent absence of quartz, and the presence of much plagioclase and pyroxene. Some of these rocks have been called trachyte-obsidians, but they seem to be rhyolites which contain an exceptionally large amount of soda. The older rhyolites, which are generally called quartz-porphories in Germany, are mostly of Permian or Carboniferous age and are numerous in the Vosges, Odenwald, Thuringerwald, &c. They are often accompanied by basic rocks (melaphyres). Permian rhyolites occur also at Lugano in Italy. Rhyolites are known also in Asia Minor and the Caucasus, in New Zealand, Colorado, Nevada and other parts of western North America. In the Yellowstone National Park there is a well-known cliff of obsidian which shows remarkably perfect columnar jointing. Some of the rhyolites of Nevada are exceedingly rich in porphyritic minerals, so that they appear at first sight to be holocrystalline rocks, since the ground-mass is scanty and inconspicuous. To this type the name *nevadite* has been given, but it is rare and local in its distribution.

In the island of Pantellaria, which lies to the south-west of Sicily, there are rocks of rhyolitic affinities which present so many unusual features that they have been designated *pantellarites*. They contain less silica than aluminas and more alkalis and iron than ordinary rhyolites. Their felspars are of the anorthoclase group, being rich in soda together with potash, and are very variable in crystalline development. Aggrine-augite and forms of soda-amphibole are also characteristic of these rocks: dark brown aegirine or cosyrite often occur in them. Quartz is not very plentiful; other ingredients are olivine, arfvedsonite and tridymite. The ground-mass varies much, being sometimes quite vitreous, at other times a glass filled with swarms of microoliths, while in certain *pantellarites* it is a microcrystalline aggregate of quartz and alkali felspar. The absence of plagioclase and biotite are marked distinctions between these rocks and the rhyolites, together with the scarcity of quartz and the prevalence of soda-bearing pyroxenes and amphiboles.

Among the Palaeozoic volcanic rocks of Germany there is a group of lavas, the quartz-keratophyres, which are of acid composition and rich in alkali felspar. Their dominant alkali is soda: hence their felspars are albite and cryptoperthite, not sanidine as in rhyolites. Quartz occurs sometimes as corroded phenocrysts, but is often scarce even in the ground-mass. Porphyritic biotite or augite are very rare, but occur in the matrix along with felspars and quartz. Micropegmatite is not infrequent in these rocks, and they may be silicified like the rhyolites. As quartz-keratophyres mostly occur in districts where there has been a good deal of folding, they are often crushed and more or less sericitized. They are best known from the Devonian rocks of Westphalia and the Harz, but are also found in Queensland, and similar rocks have been described (as soda-felsites) from Ireland. The rocks which they accompany are usually diabases and spilites.

The other group of rhyolitic rocks rich in alkali felspars and soda pyroxenes and amphiboles are the comendites. They are often porphyritic, with crystals of quartz, sanidine, microperthite or albite; the ground-mass is microcrystalline or rarely micrographic, and often filled with spongy growths of aggrine and riebeckite. They are known from the recent eruptive districts of East Africa, from Sardinia and Texas, and very similar rocks occur as intrusive masses which may be grouped with the porphyries.

The following analyses show the composition of some of the principal types of rhyolites:

	SiO ₂	Al ₂ O ₃	Fe ₂ O ₃	FeO	CaO	MgO	K ₂ O	Na ₂ O	H ₂ O
I.	76.34	12.50	1.93	1.85	0.21	3.67	2.84	0.61	
II.	72.15	13.50	3.12	0.93	0.16	4.94	4.20	0.85	
III.	77.59	12.75	0.67	n.f.	0.03	0.16	3.94	2.56	1.54
IV.	67.48	9.70	7.42	2.21	1.45	0.77	2.94	7.21	0.99
V.	70.97	13.84	3.21	0.78	1.26	0.20	1.57	6.27	0.74
VI.	74.76	11.60	3.50	0.19	0.02	0.18	4.92	4.35	0.64

- I. Rhyolite, Telki Banya, Hungary.
- II. do. Mafahlid, Iceland.
- III. do. Omahu, New Zealand.
- IV. Pantellarite, Pantellaria.
- V. Quartz-keratophyre, Muhienthal, Harz.
- VI. Comendite, Sardinia.

We note in the rhyolites I.-III. the very high silica, with alkalis and alumina also in considerable amount, while lime, magnesia and iron are very low. In the pantellarite, keratophyre and comendite the silica tends to be less abundant, while the alkalis, especially soda, increase; they have less alumina but are richer in iron and magnesia. It is easy to see why the latter types contain less quartz, felspar often very rich in soda, and ferrous minerals which contain iron and alkalis in notable amounts such as aegirine, riebeckite and arfvedsonite.

(J. S. F.)

RHYTHM (Greek *ῥυθμός*, from *ῥέω*, to flow), the measured flow of movement, or beat, in verse, music or by analogy in other connexions, e.g. "rhythm of life." The early critic of prosody, Aristoxenus, distinguished as the three elements out of which rhythm is composed, the spoken word, *λέξις*, the tune of music and song, *ῥυθμός*, and the bodily motion, *κίνησις σωμάτων*. The art of the early Greek poets was devoted to a harmonious combination of these three elements, language, instrument and gesture uniting to form perfect rhythm. Aristoxenus proceeds to define the rhythm so produced as an arrangement of time-periods, *ῥάξω χρόνων*, but other early theorists make not the time but the syllable the measurement of poetic speech. Both music and poetry depend, and have depended from the earliest times, on rhythm. But in music melody and harmony have to be taken into consideration, whereas in poetry the rhythmical value of the tone is modified by the imaginative value and importance of the words themselves. In earliest times the fundamental unity of the two arts was constantly manifest, but as the world has progressed, and they have ramified into countless forms, the difference between them has been emphasized more and more.

Rhythm in Verse.—Professor Jakob Minor has adduced a figure, valuable in helping us to realize what poetic rhythm is, when he remarks that to strike a bell twelve times, at exactly equal intervals, is to produce what may be called, indeed, a rhythmic effect, but not to awaken anything resembling the sensation of poetical rhythm. Into the idea of poetic rhythm enters an element of life, of pulse, of a certain inequality of time based upon an equality of tone. Rhythm ceases to be poetic rhythm if it is mechanical or lifeless. Aristotle, from whom a definition might be expected, is very vague in dealing with the subject, and most of the old rhetorical writers darken counsel with statements that are obscure or irrational. The fact is that rhythm is an expression of the instinct for order in sound which naturally governs the human ear, and little practical knowledge is gained by following Suidas when he says that rhythm is the father of metre, or Quintilian in his epigram that rhythm is male and metre is female. These definitions arise from a rhetorical desire to measure a delicate instinct by rule of three, and, as a matter of fact, Greek criticism on this subject often lost itself in arithmetical absurdities. It is sufficient to say that rhythm is the law which governs the even and periodical progress of sounds, in harmony with the exigencies of human emotion. For the passions, as expressed in verse, various movements are appropriate. Joy demands that the voice should leap and sing; sorrow that it should move solemnly and slowly; and poetry, which is founded on rhythm, requires that the movement of words should respond to this instinctive gradation of sounds. The finer the genius of the metrist the more exquisitely does his rhythm convey, as upon an instrument, the nature of the passion which burdens his verses. Ecstasy takes a quick, eager, rising movement:—

"Give him the nectar!
Pour out for the poet,
Hebe, pour free!

Quicken his eyes with celestial dew,
That Styx the detested no more he may view."

Mystery and suspense demand a faint, languid and throbbing movement:—

"There is not wind enough in the air
To move away the ringlet curl
From the lovely lady's cheek—
There is not wind enough to twirl
The one red leaf, the last of its clan,
That dances as often as dance it can."

An overpowering sadness interprets itself in rhythm that is full and slow and emphatic:—

"My genial spirits fail,
And what can these avails
To lift the smothering weight from off my breast?
It were a vain endeavour,
Though I should gaze for ever
On that green light that lingers in the west:
I may not hope from outward forms to win
The passion and the life, whose fountains are within."

The rhythm so produced, intimately linked, almost beyond the disintegrating power of analysis, with human feeling, may depend either on *accentuation* or *quantity*. The latter forms the principle upon which all classic metre was composed, while the former is dominant in nearly every description of modern verse. Greek and Latin verse depends entirely upon the relation of syllables, long or short. It was a question of time with the ancients, of stress or weight with us. It is an error to say, as is often done, that ancient verse did not recognize accent, and that in modern verse there is no place for quantity. These statements are generally true, but there are various exceptions to both rules. Schipper, in his *Englische Metrik*, specially points out that "long and short syllables have no constant length, no constant relation, but they depend on their place in the verse, and on the context; though they do not determine the rhythm of verse, they still act as regulators of our metre in a very important degree." Pauses take an essential importance in the construction of modern rhythm, of the variety and vitality of which they are the basis. They are introduced for the purpose of relieving the monotony of successive equal groups of syllables. The pause often takes the place of a light syllable, and there are instances in the verse of Shakespeare and Milton where it is even allowed to fill up the space of a heavy syllable. But still more often the pause does not imply the dropping of a syllable at all, but simply dictates a break in the sound, equivalent to a break in the sense. The following extract from a "Psalm" in Crashaw's *Steps to the Temple* (1646), in which the pauses are numerous and energetic, will exemplify the variety of this artifice:—

"On the proud banks of great Euphrates' flood, |
There we sat | and there we wept: |
Our harps | that | now | no music understood, |
Nodding | on the willows slept |
While | unhappy captiv'd | we
Lovely Sion | thought on thee."

In the blank verse of Milton the free use of pauses constitutes the principal element in the amazing metrical art of the poet, and is the source of the sublime originality of his music. In speaking of rhythm, it is customary to think of the formal rules which govern the fixed cadence of feet in poetry, but there is also a rhythm in prose, which imitates the measured movements of the body in stately speech. According to Renan, the rhythm of the ancient poetry of the Hebrews is solely founded on this prose movement, which differs, in fact, from that of modern European poetry merely in its undefined and indeterminate character.

See J. Minor, *Neuhochdeutsche Metrik* (Strassburg, 1893); W. Christ, *Die Metrik der Griechen* (Leipzig, 1874); Roderick Benadix, *Das Wesen des deutschen Rhythmus* (Leipzig, 1862); Jakob Schipper, *Englische Metrik* (Leipzig, 1895); Edwin Guest *History of English Rhythms* (London, 1878; and ed. 1882); Théodore de Banville, *Petit Traité de la poésie française* (Paris, 1881); F. B. Gummere, *Handbook of Poetics* (Boston, 1902). (E. G.)

Rhythm in Music.—The rhythm of modern music began to develop through the attempts of learned medieval musicians to adapt the rhythms of spoken language to the necessities of choral singing; but before the process had gone far, certain much more ancient and powerful principles, always manifest in folk-song and dance, gained ascendancy, so that even the

simplest classical music has a rhythm for which no criteria of poetic metre can be made adequate. From the musical point of view, the rhythm of speech, whether in prose or verse, is very subtle and almost uniformly fluent. The metrical feet which constitute the details of poetic rhythm are musically very minute; and the exaggerated forms in which music represents them are many and varied. On the other hand, the groups of metrical feet which constitute any one kind of verse are of a uniformity which for music on a large scale would be intolerable. Artistic music is soon compelled to draw upon infinite resources of its own, which preserve an appropriate accentuation of the sense and feeling, while obliterating or hugely exaggerating the poet's rhythmic effects. Musical rhythm cannot be studied on a sound basis unless its radical divergences from speech-rhythm are recognized from the outset.

In the earliest extant musical settings of poetry the treatment of accent and quantity was strictly arithmetical; and purely aesthetic requirements were satisfied by *ex post facto* inference from the arithmetical laws, rather than treated as the basis of the laws. Accent, when translated into music, is a rhythmic sensation resembling the stress we put on the left foot in marching; while quantity rarely suggests any bodily movement at all, since it can correspond only to variations in the length of steps. Now in modern music a sense akin to that of bodily movement is of overwhelming importance. Changes of *tempo*, and of the grouping of musical beats, are incidents as obvious in their effect as changes in the pace of a running horse. One consequence is that the laws of musical accent are simple and cogent, while the laws of musical quantity, if such exist, are far beyond analysis. Fluent speech and energetic physical exercise cannot be carried on simultaneously by the same person; and hence the laws of quantity belong to speech rather than to dance. Before we could form adequate notions of the musical rhythms of classical Greece, we should need to settle, firstly, how far the dancing in Greek drama included movements other than idealized dramatic gesticulation; secondly, how much bodily energy was involved in all dancing that may have gone beyond this; and lastly, how much dancing of any kind was executed by the singers while singing. What is certain is that ancient Greek musical rhythms were exact translations of verse rhythms, with the quantities interpreted arithmetically.

The extant fragments of Greek music are, whether we have read them correctly or not, undoubtedly very different in rhythm from the system of discant on which European music of the 12th and 13th centuries first developed; but they resemble discant in so far as the modern sense of rhythm is absent and its place is supplied by a sense of the rhythmic expression of unusually slow and emphatic speech. In ordinary speech there is an important difference between long syllables and short; but it is not naturally regulated by an exact rhythm, and the art by which it is organized in verse admits (or indeed demands) considerable freedom on the part of the reciter in varying his pace within such limits as do not destroy the structure of the lines. But when a chorus is made to sing words, it must, if the words are to reach the hearer, sing them slowly; and moreover, it must sing them exactly together, unless, as in much classical music, it can repeat them until they are either understood or dismissed from the mind as a mere pretext for the employment of voices in a merely musical design. In any case, if a chorus is to sing well together, the contrast between short and long syllables must be placed on an arithmetical basis, the simpler the better. Now the sole function of ancient Greek music was to enhance the emotional effect of poetic words by regulating their rise and fall in a musical scale and their length in a metrical scheme; and it was natural and right that its rhythms should, though accurate, have no stronger ictus than those of the words. To make them as rigid and forcible as the rhythms of a non-vocal music would produce an effect as intolerable to a Greek ear as a schoolboy's worst jog-trotting scansion of poetry. We need not, then, imagine that the human sense of rhythm has suffered any mysterious change, when our best attempts at deciphering the extant fragments of ancient Greek music yield us a rhythm

which scholars can explain by the structure of Greek verse, but which gives us no musical sense. Neither here nor in such strange harmonic phenomena as our complete inversion of medieval harmonic ideas as to the treatment of "perfect concords" (see HARMONY) do we find any principle involved which is not as true at the present day as it ever was. Ancient musical rhythm shared in the general qualities of that "Flatland" which we know ancient music to have been; modern musical rhythm, like harmony, belongs, as it were, to a three-dimensional musical space with the vast artistic resources of a consistent perspective.

Indeed, we need much the same kind of mental gymnastic in studying the origins of musical rhythm as we need for the much more abstruse subject of harmonic origins. The two subjects soon begin to show interaction. During the period of discant we find metrical conceptions already strongly modified by two purely musical factors. Firstly, the attempt to make voices produce a harmony from different simultaneous melodies (instead of from combinations conceived as disguised unison) brought with it the necessity for differences of length enormously larger than any possible metrical differences. The metrical influence, however, still so predominated, even in the 14th century, as to produce a rhythm based almost exclusively on what would now be called triple time. Secondly, that sense of bodily movement, for which the less clumsy term "dance-rhythm" is far too narrow, gained ground as the only means powerful enough to hold the various rhythms of the new and growing polyphony together. In the later stages of discant the old metrical conceptions struggled against the grain of the polyphony for awhile, only to succumb in a tangle of inextricable technicality; and the new art, which became coherent in the 15th century, disregarded poetic metre, with little or no loss in capacity to interpret words if the composer had leisure or desire to do so; since, after all, poetic rhythm in its highest forms has a subtle freedom which renders mechanical musical translation worse than useless, while the rhythmic swing of the lighter forms of poetry was soon discovered by the composers of the "Golden Age" to be practically identical with the refined dance-rhythm which they in their lighter moments idealized from folk-music.¹

By the middle of the 15th century polyphony attained such independence that the only rhythms which would hold the flow of independent melodious voices together were those in which a steadily duple or steadily triple rhythm (either of which might be subdivided by the other or by itself) could be felt as an absolutely regular musical tread. Such a rhythm is capable of expressing every poetic foot, either by the difference of stress between notes or by a difference in their length. Moreover, emphasis may be obtained by the pitch of the note, or, again, by its harmonic significance. All these forms of emphasis combine and counteract each other in an infinite variety, till the sense of musical movement becomes as remote from crude dance-rhythm as it is from poetic metre. But though the part thus played by accent was already of paramount importance in the "Golden Age" of music, it was not allowed to become evident to the ear except in the lighter and more coarse-grained art-forms. Its highest purpose was served as soon as the listener was able to lose all crude rhythmic impulses in a secure feeling that the mass of polyphonic harmony was held together by a general grouping of the rhythmic beats in fours or threes; and individual parts were at least as free to indulge in other rhythms across the main rhythm as they are in the most complex modern music, so long as the harmony was held together by the average grouping, or "time," as we now call it. Hence the rhythmic variety of 16th-century

¹ It would be interesting and fruitful to consider how far the growing preference, in modern European languages, of accent to quantity, may not only have modified the conception of musical rhythm, but may itself have been enhanced by the rhythmic tendencies of popular song, which had so great an influence on the learned music of the middle ages. And it can hardly be said that the subject of musical rhythm has yet been so clearly treated on these lines as to shed the light it seems capable of shedding upon many vexed questions in poetic rhythm.

music is exactly like the harmonic variety, and the limitations and waywardness of the one are no more archaic than those of the other.

When the resources of later music and the treatment of instruments necessitated the publishing of music in score as well as in separate parts, it became necessary to guide the eye by drawing vertical lines ("bars") at convenient distances. Hence the term "score" (Ger. *Partitur*, Fr. *partition*). These divisions naturally coincided with the main rhythmic groups, and eventually became equidistant. This purely practical custom has co-operated with the great increase of rhythmic firmness necessary for the coherence of those large modern forms which decree the shape rather than the texture of the music, until our notions of rhythm may fairly be described as bar-ridden. And, since the vast majority of our musical rhythms absorb the utmost complexity of detail into the most square and symmetrical framework possible, we are taught to regard the "4-bar period" as a normal (or even ultimate) rhythmic principle, instead of contenting ourselves with broader conceptions which treat symmetry and proportion in time as freely as they are treated in space. It cannot be too strongly emphasized that the bar indicates no universal musical principle. The havoc wrought by mechanical teaching on this point is incalculable, especially in the childish crudeness of current ideas as to the declamation of words in classical and modern music: ideas which mislead even some composers who might have been expected to know better.

As rhythm is contemplated in larger measures, it becomes increasingly difficult to say where the sense of rhythm ends and the sense of proportion begins. The same melody that may be felt as a square and symmetrical piece of proportion in a four-bar rhythm if it is taken slowly, will be equally rational as a single bar of "common time" (see below) if it is taken very quickly; and between these two extremes there may be insensible gradations. All that can be laid down is that composers are apt to use short bars where they demand constant strong accent, while long bars will imply smoother rhythms. For example, if the scherzo of Beethoven's Ninth Symphony were written in $\frac{12}{8}$ instead of $\frac{3}{4}$ bars, then the passages now marked *Ritmo di tre battute* would have to appear in $\frac{1}{4}$ time, and so the changes of rhythm would be much more visible on paper. But the tendency to put a strong accent on the first beat of every bar would make this notation an undesirable substitute for Beethoven's, since it would lead to a neglect of the subordinate accents (all of them bar-accent, as Beethoven writes them). The trio of this scherzo shows the opposite case in the fact that Beethoven first intended to write it in $\frac{3}{4}$ time, but, in order to indicate a more tranquil flow at the same pace, doubled the quantity contained in a bar, substituting *alla breve* bars, each equal to two of the preceding $\frac{3}{4}$ bars. The alteration produced a discrepancy in the metronome marks, which has always caused controversy among conductors, but the facts admit of only one interpretation. It is clear, then, that the only sound theory of musical rhythm will be that, in which accent, beat, bar, and even form and proportion are relative terms.

The kinds of *time* (i.e. rhythmic groups forming, as it were, invariable molecules in the structure of any continuous piece of music) that are used in all music from the 15th century onwards are nowadays classified as *duple* and *triple*, and each of these may be *simple* or *compound*. Simple time is that in which the normal subdivision of its beats is by two, whether the number of the beats themselves is duple or triple. Compound time is that in which the beats are regularly divided by three, which three subdivisions are reckoned as subordinate beats. The beats are in all kinds of time reckoned as halves, quarters, 8ths, 16ths or even 32nds of the standard note in modern music, the semibreve; and the time-signature placed at the beginning of a piece of music is really a fraction, of which the numerator expresses the number of beats in a bar, while the denominator expresses the size of a beat. Thus $\frac{3}{4}$ signifies three crotchets in a bar. Compound time is expressed, not by using normal fractions of a semibreve as main beats and dividing them into triplets,¹ but by using dotted beats. A dot after

a note adds another half to its value, and so not only do we obtain the means of expressing a great variety of rhythmic effects (especially quantitative effects of iambic and trochaic character) in all kinds of time, but we are able to use normal fractions of a semibreve as the subordinate beats of compound time. Thus $\frac{3}{4}$ is the compound time obtained by dotting the two crotchets of $\frac{3}{8}$ time, and is thus totally different in accent and meaning from $\frac{3}{4}$ time, though that also contains six quavers in a bar. The most highly compound times in classical music are to be found in the last movement of Beethoven's Sonata, Op. 111. He begins by dividing bars of $\frac{3}{4}$ into their usual compound time $\frac{9}{8}$. He then divides the six half-beats of $\frac{9}{8}$ time by three, producing $\frac{3}{16}$ (which he incorrectly calls $\frac{3}{8}$), and lastly he divides the 12 quarter-beats by 3, producing $\frac{4}{16}$ (which he calls $\frac{1}{4}$). The special signatures C for $\frac{3}{4}$ time, and C for $\frac{3}{8}$ time are the last survivals of the time system of the middle ages (see MUSICAL NOTATION). That complicated system of *modus*, *time* and *prolatio* was capable of expressing even more highly compound rhythms than our usual time-signatures, though the complexity was in most cases unreal, since the small rhythmic ictus of ecclesiastical polyphony renders little but the general distinction between duple and triple rhythm audible; especially as the more compound rhythms were not subdivisions but multiples, involving lengths better measurable by an eight-day clock than by human ears. The second Kyrie of Palestrina's *Missa L'Homme Armé* is one of the rare cases which remain both rhythmic and complex when transcribed in modern score.² For genuine articulate complexity the ballroom scene in Mozart's *Don Giovanni* has never been surpassed. So real are its three simultaneous rhythms of *mauet*, *contredanse*, and *waltz* that the persons on the stage actually dance to whichever suits their character. Anomalous measures such as $\frac{3}{4}$ and $\frac{3}{8}$ time, whether divisible into alternations of $\frac{3}{8}$ and $\frac{3}{4}$ or not, are aesthetically best regarded not as rhythmic units, but as extreme cases of unsymmetrical phrase-rhythms erected into a system for special effect. They tend, however, to group themselves into musical sentences of reactionary squareness; and the $\frac{3}{4}$ movement of Tschaikevsky's *Pathetic Symphony* consists of twenty 8-bar phrases (twenty-four, counting the repeats) before an unpaired 4-bar phrase is heard in the short coda. Even the last bar is not odd, though it is the 179th, for the rhythm ends with an unwritten 180th bar of silence.

There is, no doubt, a germ of truth in current doctrine as to the fundamental character of 4-bar phrase-rhythms, inasmuch as the human anatomy has a bilateral symmetry with either limb on one side slightly stronger than that on the other. This is probably the basis of our natural tendency to group rhythmic units in pairs, with a stress on the first of each pair; and hence, if our attention is drawn to larger groups, we put more stress on the first of the first pair than on the first of the second; and so with still greater groups, until our immediate and unanalysed sense of rhythm merges into a sense of proportion distributed through time with a clear consciousness of past, present and future. The point at which this merging takes every ordinary purpose of musical rhythm, being capable of expressing clear distinctions far more minute than have ever been regulated in speech. It is impossible to pronounce a syllable in less than a tenth of a second; but it is easy to play 16 notes in a second on the pianoforte. (That is to say, musical rhythm continues to be measurable up to the point at which atmospheric vibrations coalesce in the ear as one musical note.) In a series of such rapid notes a single break twice in a second would have a very obvious rhythmic effect directly measured by the ear. If the broken series were levelled into an even series of fourteen notes a second, the rhythmic effect would be entirely different, though the actual difference of pace would be only $\frac{1}{14}$ of a second. The special sign for triplets is readily adapted to other subdivisions where necessary; but such adaptation generally indicates rather a freedom of declamatory rhythm than any abstruse arithmetical accuracy. Among the worst barbarisms in musical editing is the persistent reduction of Chopin's septoles, groups of 13 and other indeterminables, into *non-ceter* or *frills*. A natural freedom in performance is as necessary for the minutiae of musical rhythm as it is in speech; but where all but the finest players fail is in basing this freedom on the superlative accuracy of the rhythmic notation of the great composers.

¹ In the critical edition of Palestrina's complete works, vol. xii. p. 177 (Breitkopf and Härtel), the editor has violently simplified it. He is justified in using the ordinary $\frac{3}{4}$ bars to hold the piece together, and he is not called upon to reproduce the riddles of the original notation; but some secondary time signatures ought to have been added to indicate the strong swing of the music in its connecting shapes; and there is no justification, in a full score intended for scholars, in supplanting the true rhythm of the *quintus* by a rough practical compromise.

¹ Triplets are groups of three equal notes crowded into the time normally taken by two. Binary and ternary subdivision answer

place depends on the extent to which these larger groups can dominate the details of the rhythm, and this again depends on the listener's capacity for grasping large and slow rhythms. In any case, the only "ultimate" rhythmic element is the tendency to mark off rhythmic beats into pairs, with a stress on the first of each pair. Where this tendency is resisted, the mind will follow the line of least resistance, which will vary according to the pace and detail of the music. Thus in rapid triple time it is easier to seek duple rhythm in the grouping of bars than in the details within the bars; but if the groups of bars are also triple, or irregular, the mind will fix on the first recurring salient feature for a secondary beat, regardless of inequality in length; rather than, so to speak, hop on one leg indefinitely. On this principle there is a distinct tendency in moderate and slow triple times to throw a secondary accent on the third beat; or sometimes on the second, as in the springing step of the mazurka, where the spring gives energy to the first beat and the descent from it gives poise to the second.

The tendency of small rhythmic groups to build themselves into large and square ones, such as 8-bar, 16-bar and even 32-bar periods, is doubtless important; but the converse tendency of large phrase-rhythms to break up in a tapering series is far more significant, since even in its most regular forms it not only produces more variety the further it goes, but always increases in obvious effect, until the subdivisions attain the minuteness (and therewith the expression) of speech rhythms. (A crude example of the device is Diabelli's waltz, on which Beethoven wrote his gigantic 33 variations. See VARIATIONS, where the point is illustrated by a diagram.) Regularly expanding rhythm, on the other hand, not only becomes imperceptible as it is carried further, but tends merely to make musical proportions resemble those of a chess-board. In great music the expanding principle is therefore always contrasted with or modified by the tapering principle, which can indeed exist simultaneously with it and with any other. For, to take only three categories, the harmonic changes of a passage may be designed in tapering rhythm while the melodic phrases expand, and the entries of instruments or parts occur on some third principle, regular or irregular. Such interplay need produce no feeling of complexity; indeed, it is an art most neglected by those composers who most rely on the effect of complex rhythm. It is the main discoverable source of that almost dramatic sense of movement that distinguishes the great musical styles from the academic methods which play for safety, and from the anti-academic novelties which end in monotony.

Square rhythms become desirable at climaxes where physical energy dominates thought. Strong final cadences accordingly require that the last chord should fall on an accent; and if the pace is rapid the final chord will probably be not only on an accented beat but on an accented bar. Thus it is quite obvious that there is by a mere oversight one bar too many in the four bars of tremolo quavers at the end of the first movement of Beethoven's Fourth Symphony; for they are followed by an important bar leading to the last three chords, which chords can only mean (counting bars as beats)—"ONE, two, THREE" ("four" being silent and therefore unwritten). A fifth bar of tremolo would correct the rhythm in a more vigorous but more vulgar way by bringing the last chord onto "ONE" of the next imaginary group of four. The former correction is so obviously right that the imagination makes it in spite of the presence of the superfluous bar, which is instinctively ignored as an accidental prolongation of the tremolo. Where the composer writes in bars so short as to be permanently less than the phrases of the piece (as in Beethoven's scherzos), or in bars that are frequently longer than the phrases (as in most of Mozart's movements in slow or moderate common time), it sometimes becomes impossible to construe the music without carefully calculating where the accents come; and this calculation is most easily made on the assumption that the strongest cadences bring the tonic chord on an accent. Thus, in Beethoven's Sonata in E flat, Op. 27, No. 1, the first bar of the second movement must be preliminary

and the first accent must come on the second bar, since the piece refuses to make sense in any other way. Indeed, Beethoven has written some notes twice over in order to bring his double-bars and repeat-marks where they will indicate the true rhythmic joints to the eye. (A double-bar is a mere graphic indication of some important sectional division, not necessarily rhythmic or even coincident with a normal bar-stroke.)

Theorists, however, have developed a tendency to assume that all cadences must be strong. More than one critic has told us that the scherzo of Beethoven's Sonata, Op. 28, is in the same predicament as that of Op. 27, No. 1; though it not only makes excellent sense with its cadences in the light and weak form in which they appear, but, when reconstructed on the "strong cadence" theory, entirely fails in its middle portion to uphold that theory or to make any other rhythmic sense. And when Professor Prout tells us that the overture to *Figaro* begins with a silent bar, and that Schubert's *Imromptu* in B flat is positively ungrammatical in its cadences unless it is entirely rebarred, and when Dr Riemann turns half the ritornello of a Bach concerto from $\frac{3}{4}$ into $\frac{3}{8}$ time, simply in order to make the sequences coincide with the hardest possible accents; then we can only protest that this is regulating musical aesthetics by criteria too crude for the aesthetics of bricklaying. An edition of *Paradise Lost*, in which the lines were so rearranged as to bring all punctuation marks (except perhaps commas) at the end of the line, would be on precisely the same level of ingenious barbarity.

Few technical terms are entirely peculiar to the subject of musical rhythm; but some obvious terms of syntax, such as *phrase, period and section* are used with varying degrees of system by all writers on music; and the whole terminology of prosody has been annexed—with such success that we are told in Grove's *Dictionary* (article "Metre") that "the theme of Weber's *Rondo brillante* in E flat (Op. 62) is in Anapaestic Tetrameter Brachycatalectic, very rigidly maintained."

One important term has acquired a special significance in music: viz. *Syncope*. It means a cross-accent of such strength as to equal or even suppress the main accent; but the use of the term is generally restricted to cases in which the cross-accent is produced by shifting the notes of a melody or a formula so that they fall between the beats instead of upon them. From what we have said as to the almost physical energy of musical rhythm it is obvious that such a phenomenon is of far greater effect and importance in music than it could possibly be in verse; and, to whichever subject the term may belong by priority, extreme caution is needed in extending any musical notion of it to the structure of poetry. (D. F. T.)

RHYTINA, a name applied to the northern sea-cow (*Rhytina gigas*, or *stelleri*), a gigantic relative of the manati and dugong, which formerly inhabited Bering and Copper Islands, in the North Pacific, where it was discovered during Bering's voyage in 1741, and subsequently described by Steller, who accompanied that expedition as a naturalist. Bering's half-starved sailors soon reduced the numbers of these comparatively helpless creatures; and it was not long after—probably about the year 1768—that the species, which was the sole representative of its genus, became completely exterminated. The *Rhytina* was the largest member of the order Sirenia, attaining a length of nearly twenty feet; and had a very thick, rugged, bark-like skin. The jaws, which are bent downwards to a moderate extent, are unprovided with teeth, but in life carried ridged horny plates. The tail was very deeply forked; and the flippers were short and truncated, lacking apparently the terminal joints of the digits.

When first discovered, this Sirenian was extremely numerous in the bays of Bering Island, where it browsed upon the abundant sea-tangle. Its extirpation is due to the Russian sailors and traders who visited the island in pursuit of seals and sea-otters, and who subsisted on its flesh. Numbers of bones have been discovered in the soil of Bering and Copper Islands, from which more or less nearly perfect skeletons have been reconstructed, so that the osteology of this interesting animal is well represented in most of the larger museums. (R. L.)*

RIANSARES, AUGUSTIN FERNANDEZ MUÑOZ, DUKE OF (1808 or 1810-1873),morganatic husband of Maria Christina, queen and regent of Spain, was born at Tarancón, in the province of Cuenca, in New Castile. His father was the keeper of an "estanco" or office for the sale of the tobacco of the government monopoly. He enlisted in the bodyguard, and attracted the attention of the queen. According to one account, he distinguished himself by stopping the runaway horses of her carriage; according to another, he only picked up her handkerchief; a third and scandalous explanation of his fortune has been given. It is certain that the queen married him privately, very soon after the death of her husband on the 20th of September 1833. By publishing her marriage, Maria Christina would have forfeited the regency; but her relations with Muñoz were perfectly well known. When on the 13th of August 1836 the soldiers on duty at the summer palace, La Granja, mutinied and forced the regent to grant a constitution, it was generally, though wrongly, believed that they overcame her reluctance by seizing Muñoz, whom they called her "gusapo," or fancy man, and threatening to shoot him. When in 1840 the queen found her position intolerable and fled the country, Muñoz went with her and the marriage was published, and on the overthrow of Espartero in 1843 the couple returned. In 1844 Queen Isabella II., who was now declared to be of age, gave her consent to her mother's marriage, which was publicly performed. Muñoz was created duke of Riansares and made a knight of the Golden Fleece. By Louis Philippe, king of the French, he was created duke of Mont-Morot and Grand Cross of the Legion of Honour. Until his wife was finally driven from Spain by the revolutionary movement of 1854, the duke is credibly reported to have applied himself to making a large fortune out of railway concessions and by judicious stock exchange speculations. Political ambitions he had none, and it is said that he declined the offer of the crown of Ecuador. All authorities agree that he was not only good-looking, but kindly and well-bred. He died five years before his wife at L'Adresse, near Havre, on the 11th of September 1873. Several children were born of the marriage.

RIAZ PASHA (c. 1835-), Egyptian statesman; born about 1835, was of a Circassian family, but said to be of Hebrew extraction. Little is known of his early life save that until the accession of Ismail Pasha to the vice-royalty of Egypt in 1863 he occupied a humble position. Ismail, recognizing in this obscure individual a capacity for hard work and a strong will, made him one of his ministers, to find, to his chagrin, that Riaz was also an honest man possessed of a remarkable independence of character. When Ismail's financial straits compelled him to agree to a commission of inquiry Riaz was the only Egyptian of known honesty sufficiently intelligent and patriotic to be named as a vice-president of the commission. He filled this office with distinction, but not to the liking of Ismail. The khedive, however, felt compelled, when as a sop to his European creditors he assumed the position of a constitutional monarch, to nominate Riaz as a member of the first Egyptian cabinet. For the few months this government lasted (September 1878 to April 1879) Riaz was minister of the interior. When Ismail dismissed the cabinet and attempted to resume autocratic rule, Riaz had to flee the country. Upon the deposition of Ismail, June 1879, Riaz was sent for by the British and French controllers, and he formed the first ministry under the khedive Tewfik. His administration, marked by much ability, lasted only two years, and was overthrown by the agitation which had for figure-head Arabi Pasha (q.v.). The beginnings of this movement Riaz treated as of no consequence. In reply to a warning of what might happen he said, "But this is Egypt; such things do not happen; you say they have happened elsewhere, perhaps, but this is Egypt." On the evening of the 9th of September 1881, after the military demonstration in Abdin Square, Riaz was dismissed; broken in health he went to Europe, remaining at Geneva until the fall of Arabi. After

that event Riaz, subordinating his vanity to his patriotism, accepted office as minister of the interior under Sherif Pasha (q.v.). Had Riaz had his way Arabi and his associates would have been executed forthwith, and when the British insisted that clemency should be extended to the leaders of the revolt Riaz refused to remain in office, resigning in December 1882. He took no further part in public affairs until 1888, when, on the dismissal of Nubar Pasha (q.v.), he was summoned to form a government. He now understood that the only policy possible for an Egyptian statesman was to work in harmony with the British agent (Sir Evelyn Baring—afterwards Lord Cromer). This he succeeded in doing to a large extent, witnessing if not initiating the practical abolition of the *corvée* and many other reforms. The appointment of an Anglo-Indian official as judicial adviser to the khedive was, however, opposed by Riaz, who resigned in May 1891. In the February following he again became prime minister under Abbas II., being selected as comparatively acceptable both to the khedival and British parties. In April 1894 Riaz finally resigned office on account of ill-health. Superior, probably, both intellectually and morally to his great rival Nubar, he lacked the latter's broad statesmanship as well as his pliability. Riaz's standpoint was that of the benevolent autocrat; he believed that the Egyptians were not fitted for self-government and must be treated like children, protected from ill-treatment by others and prevented from injuring themselves. In 1889 he was made an honorary G.C.M.G. A worthy tribute to Riaz was paid by Lord Cromer in his farewell speech at Cairo on the 4th of May 1907. "Little or no courage is now required," said Lord Cromer, "on the part of a young Egyptian who poses as a reformer, but it was not always so. Ismail Pasha had some very drastic methods of dealing with those who did not bow before him. Nevertheless, some thirty years ago Riaz Pasha stood forth boldly to protest against the maladministration that then prevailed in Egypt. He was not afraid to bell the cat."

RIB (from O. Eng. *ribb*; the word appears in many Teutonic languages, cf. Gr. *Rippe*, Swed. *reb*), in anatomy, the primary meaning, one of the series of elastic arched bones (*costae*) which form the casing or framework of the thorax (see SKELETON: *Axial*). The word is in meaning transferred to many objects resembling a rib in shape or function. In architecture, it is thus used of the arches of stone which in medieval work constitute the skeleton of the vault, and carry the shell or web. Although in the Roman vault the rib played an important element in its construction, it was generally hidden in the thickness of the vault and was made subservient to its geometrical surfaces. The Gothic masons, on the other hand, reversed the process, and not only made the vaulting surface subservient to the rib, but by mouldings rendered the latter a highly decorative feature. The principal ribs are the transverse (*arc doubleaux*), the diagonal (*arc ogive*) and the wall rib (*formeret*). Those of less importance are the intermediate, the ridge and lierne ribs. The ridge-rib is one first introduced into the vault to resist the thrust of the intermediate ribs between the wall and diagonal ribs; it also served to mark the junction of the filling-in or web of vaults in those cases where the courses dipped toward the diagonal rib. (See VAULT.) A lierne rib (the term is borrowed from the French) is a short rib, introduced into the vaulting in the Early Perpendicular period, which coupled together the transverse and intermediate ribs; in the later period the "lierne" rib becomes one of the chief features of the "stella" vault (see further VAULT).

RIBADENEIRA, PEDRO A. (1527-1611), hagiologist, was born at Toledo on the 1st of November 1527. As a lad he repaired to Rome for study, and there on the 18th of September 1540 was admitted by Ignatius Loyola, in his thirtieth year, as one of the Society of Jesus, which had not yet received papal sanction. He pursued his studies at Paris (1542) in philosophy and theology. Loyola, in 1555, sent him on a mission to Belgium; in pursuance of it he visited England in

1558. A later result of his visit was his *Historia Ecclesiastica del scisma del Reyno de Inglaterra* (1588-1594), often reprinted, and used in later editions of N. Sander's *De Origine et Progressu Schismatis Anglicani*. In 1560 he was made Provincial of the Society of Jesus in Tuscany, thence transferred as Provincial to Sicily in 1563, again employed in Flanders, and from 1571 in Spain. In 1574 he settled in Madrid, where he died on the 20th of September 1611. His most important work is the *Life of Loyola* (1572), which he was the first to write. In his first edition of the *Life*, as also in the second enlarged issue (1587), Ribadeneira affirmed that Loyola had wrought no miracle, except the foundation of his Society (thus making his claim parallel with that of Mahomet, whose only miracle, originally, was the Koran). In the process for the canonization of Loyola, a narrative published by Ribadeneira in 1609 exhibited miracles; and these are recorded in an abridgment of the *Life* by Ribadeneira (published posthumously in 1612) with a statement by Ribadeneira that he had known of them in 1572 but was not then satisfied of their proof. For this change of opinion he is taken to task by Bayle. That Ribadeneira was, though an able, a very credulous writer, is shown by his lives of the successors of Loyola in the generalship of the Society, Lainez and Borgia; and especially by his *Flos Sanctorum* (1599-1610), a collection of saints' lives, entirely superseded by the labours of the Bollandists. His other works are numerous but of little moment, including his *Tratado de la religion* (1595), intended as a refutation of Machiavelli's *Prince*.

See his autobiography in his *Bibliotheca Scriptorum Societatis Jesu* (1602 and 1608, supplemented by P. Alegambe and N. Sotwell in 1676); N. Antonio, *Biotheca Hispana Nova* (1788); *Biographie Universelle* (Michaud) (1842-1865).

RIBALD, a word now only used in the sense of jeering, irreverent, abusive, particularly applied to the uses of low, offensive or mocking jests. It has an interesting early history, of which Du Cange (Gloss. s.v. *Ribaldus*) gives a full account. It is one of those words, like the Greek *ῥιπαριος*, an unconstitutional ruler, and the Latin *lauro*, a hired soldier, mercenary, later robber, which have acquired a degraded and evil significance. The *ribaldi* were light-armed soldiers, on whom fell the duty of being first in attack, the *enfants perdus* or "forlorn hope" of the armies of the French kings; thus Rigordus, in his contemporary history of the reign of Philip Augustus, for the year 1180, speaks of the *Ribaldi* . . . *qui primos impetus in expugnandis munitionibus facere consueverunt*. Later we find the *ribaldi* among the rabble of camp-followers of an army, and Giovanni Villani, in his 16th-century *Chronicle* (11, 130), speaks of *ribaldi et i raguazzi del hoste*, and Froissart of the *ribaux* as the lowest ranks in an army. *Ribaldus* (*ribaut*) was thus a common name for everything ruffianly and abandoned, and Matthew Paris (*Ann.* 1251) says: *Fures, exules, fugitivi, excommunicati, quos omnes Ribaldos Francia vulgariter consuevit appellare*. The name (*ribaldus* or *ribaldi*) was particularly applied to prostitutes, brothel-keepers and all who frequent haunts of vice, and there was at the French court from the 12th century an official, known as *Rex Ribaldorum*, king of the *ribalds*, changed in the reign of Charles VI. to *Præpositus Hospitii Regis*, whose duty was to investigate and hold judicial inquiry into all crimes committed within the precincts of the court, and control vagrants, prostitutes, brothels and gambling-houses. The etymology of the word has been much discussed, and no certainty can be arrived at. The termination *-ald*—points to a Teutonic origin, and connexion has been suggested with O.H.Ger. *Hripā*, M.H.Ger. *Ribe*, prostitute, with Ger. *reiben*, rub, or with *rauben*, rob. Neither Skeat nor the *New English Dictionary* find any relation to the English "bawd," proccress, pander.

RIBAUT (or RIBAUT), JEAN (c. 1520-1565), French navigator, famous for his connexion with the early settlement of Florida, was born at Dieppe, probably about 1520. Appointed by Admiral Coligny to the command of an expedition to prepare an asylum for French Protestants in America, Ribault sailed

on the 18th of February 1562, with two vessels, and on the 1st of May landed in Florida at St John's river, or, as he called it, Rivière de Mai. Having settled his colonists at Port Royal Harbour (now Paris Island, South Carolina), and built Fort Charles for their protection, he returned to France to find the country in the throes of the Civil War. In 1563 he appears to have been in England and to have issued *True and Last Discoverie of Florida* (Hakluyt Soc., vol. vii.). In April 1564 Coligny was in a position to despatch another expedition under René de Laudonnière, but meanwhile Ribault's colony had come to an untimely end—the unfortunate adventurers, destitute of supplies from home, having revolted against their governor and attempted to make their way back to Europe in a boat which was happily picked up, when they were in the last extremities, by an English vessel. In 1565 Ribault was again sent out to satisfy Coligny as to Laudonnière's management of his new settlement, Fort Caroline, on the Rivière de Mai. While he was still there the Spaniards, under Menendez de Aviles, though their country was at peace with France, attacked the French ships at the mouth of the river. Ribault set out to retaliate on the Spanish fleet, but his vessels were wrecked by a storm near Matanzas Inlet and he had to attempt to return to Fort Caroline by land. The fort had by this time fallen into the hands of the Spaniards, who had slaughtered all the colonists except a few who got off with two ships under Ribault's son. Induced to surrender by false assurances of safeguard, Ribault and his men were also put to the sword in October 1565. The massacre was avenged in kind by Dominique de Gourgues (d. 1583) two years later.

See E. and E. Haag, *La France protestante* (1846-1859); and F. Parkman, *Pioneers of France in the New World* (new ed., 1899).

RIBBECK, JOHANN CARL OTTO (1827-1898), German classical scholar, was born at Erfurt in Saxony on the 23rd of July 1827. Having held professorial appointments at Kiel and Heidelberg, he succeeded his tutor Ritschl in the chair of classical philology at Leipzig, where he died on the 18th of July 1898. Ribbeck was the author of several standard works on the poets and poetry of Rome, the most important of which are the following: *Geschichte der römischen Dichtung* (2nd ed., 1894-1900); *Die römische Tragödie im Zeitalter der Republik* (1875); *Scenicae Romanorum Poesis Fragmenta*, including the tragic and comic fragments (3rd ed., 1897). As a textual critic he was distinguished by considerable rashness, and never hesitated to alter, rearrange or reject as spurious what failed to reach his standard of excellence. These tendencies are strikingly shown in his editions of the *Epistles* and *Ars Poetica* of Horace (1869), the *Satires* of Juvenal (1859) and in the supplementary essay *Der echte und unechte Juvenal* (1865). In later years, however, he became much more conservative. His edition of Virgil (2nd ed., 1894-1895), although only critical, is a work of great erudition, especially the Prolegomena. His biography of Ritschl (1879-1881) is one of the best works of his kind. The influence of his tutor may be seen in Ribbeck's critical edition of the *Miles Gloriosus* of Plautus, and *Beiträge zur Lehre von den lateinischen Partikeln*, a work of much promise, which causes regret that he did not publish further results of his studies in that direction. His miscellaneous *Reden und Vorträge* were published after his death (Leipzig, 1899). He took great interest in the monumental *Thesaurus Linguae Latinae*, and it was chiefly owing to his efforts that the government of Saxony was induced to assist its production by a considerable subsidy.

The chief authority for his life is *Otto Ribbeck; ein Bild seines Lebens aus seinen Briefen* (1901), ed. by Emma Ribbeck.

RIBBON-FISHES (Trachypteridae), a family of marine fishes readily recognized by their long, compressed, tape-like body, short head, narrow mouth and feeble dentition. A high dorsal fin occupies the whole length of the back; an anal is absent, and the caudal, if present, consists of two fascicles of rays of which the upper is prolonged and directed upwards. The pectoral fins are small, the ventrals composed of several rays, or of one long ray only. Ribbon-fishes possess all the characteristics of fishes living at very great depths. They are

extremely fragile when found floating on the surface or thrown ashore, and rarely in an uninjured condition; the rays of their

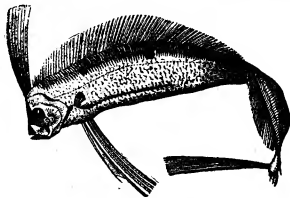

FIG. 1.—*Trachipterus laenia*.

fins especially, and the membrane connecting them, are of a very delicate and brittle structure. In young ribbon-fishes some of the fin-rays are prolonged in an extraordinary degree, and sometimes provided with appendages (see fig. 2). There

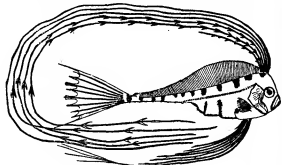

FIG. 2.—Young *Trachipterus*.

are only two genera in the family, *Regalecus*, the oar-fish, and *Trachipterus*. In the former the length of the body is about fifteen times its depth. The head likewise is compressed, short, resembling in its form that of a herring; the eye is large; the mouth is small, and provided with very feeble teeth. A long many-rayed dorsal fin, of which the very long anterior rays form a kind of high crest, extends from the top of the head to the end of the tail; the anal and perhaps the caudal fins are absent; but the ventrals (and by this the oar-fish is distinguished from the other ribbon-fishes) are developed into a pair of long filaments, which terminate in a paddle-shaped extremity, but are too flexible to assist in locomotion. The whole body is covered with a layer of silvery epidermoid substance, which easily comes off and adheres to other objects.

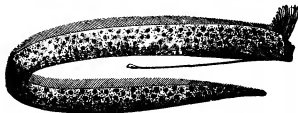

FIG. 3.—Oar-fish.

Oar-fishes are the largest deep-sea fishes known, the majority of the specimens observed measuring 12 ft. in length; but some are recorded to have exceeded 20 ft. Their range in the great depths of the ocean seems to extend over all seas, but, however numerous they may be in the depths which are their home, it is only by rare accident that specimens reach the surface. Thus from the coasts of Great Britain only about twenty captures are known in the long space of a century and a half, and not more than thirteen from those of Norway. Oar-fishes have been considered by naturalists to have

given rise to some of the tales of "sea-serpents," but their size as well as the facility with which they are secured when observed render this solution of the question of the existence of such a creature improbable. When they rise to the surface of the water they are either dead or in a helpless and dying condition. The ligaments and tissues by which the bones and muscles were held together whilst the fish lived under the immense pressure of great depths have then become loosened and torn by the expansion of the internal gases; and it is only with difficulty that the specimens can be taken entire out of the water, and preserved afterwards. Every specimen found has been more or less mutilated; and especially the terminal portion of the tail, which seems to end in a delicate tapering filament, has never been perfect;—it is perhaps usually lost as a useless appendage at a much earlier period of the life of the fish. Of *Trachipterus*, specimens have been taken in the Atlantic, the Mediterranean, at Mauritius and in the Pacific. The species from the Atlantic has occurred chiefly on the northern coasts, Iceland, Scandinavia, Orkneys and Scotland. It is known as *T. arcticus*, in English the deal-fish; its Icelandic name is *Vagmeir*. Its length is 5 to 8 ft. Specimens seem usually to be driven to the shore by gales in winter, and are sometimes left by the tide. S. Nilsson, however, in Scandinavia observed a living specimen in two or three fathoms of water moving something like a flat-fish with one side turned obliquely upwards.

RIBBONISM, the name given to an Irish secret-society movement, which began at the end of the 18th century in opposition to the Orangemen (*g.n.*), and which was represented by various associations under different names, organized in lodges, and recruited all over Ireland from the lowest classes of the people. The actual name of Ribbonism (from a green badge worn by its members) became attached to the movement later, about 1826; and, after it had grown to its height about 1855, it declined in force, and was practically at an end in its old form when in 1871 the Westmeath Act declared Ribbonism illegal. See also under IRELAND: *History*.

RIBBONS. By this name are designated narrow webs, properly of silk, not exceeding nine inches in width, used primarily for binding and tying in connexion with dress, but also now applied for innumerable useful, ornamental and symbolical purposes. Along with that of tapes, fringes and other small-wares, the manufacture of ribbons forms a special department of the textile industries. The essential feature of a ribbon loom is the simultaneous weaving in one loom frame of two or more webs, going up to as many as forty narrow fabrics in modern looms. To effect the conjoined throwing of all the shuttles and the various other movements of the loom, the automatic action of the power-loom is necessary; and it is a remarkable fact that the self-acting ribbon loom was known and extensively used more than a century before the famous invention of Cartwright. A loom in which several narrow webs could be woven at one time is mentioned as having been working in Dantzic towards the end of the 16th century. Similar looms were at work in Leiden in 1620, where their use gave rise to so much discontent and rioting on the part of the weavers that the states-general had to prohibit their use. The prohibition was renewed at various intervals throughout the century, and in the same interval the use of the ribbon loom was interdicted in most of the principal industrial centres of Europe. About 1676, under the name of the Dutch loom or engine loom, it was brought to London; and, although its introduction there caused some disturbance, it does not appear to have been prohibited. In 1745, John Kay, the inventor of the fly-shuttle, obtained, conjointly with Joseph Stoll, a patent for improvements in the ribbon loom; and since that period it has benefited by the inventions applied to weaving machinery generally.

Ribbon-weaving is known to have been established near St Étienne (dep. Loire) so early as the 11th century, and that town has remained the headquarters of the industry. During the Huguenot troubles, ribbon-weavers from St Étienne settled at Basel and there established an industry which in modern times has rivalled that of the original seat of the trade. Crefeld is the centre of the German ribbon industry, the manufacture of black velvet ribbon being there a specialty. In England Coventry is the most important seat of ribbon-making, which is also prosecuted at Norwich and Leicester.

RIBEIRA, a town of north-western Spain, in the province of Corunna, on the extreme south-west of the peninsula formed between the river of Muros y Noya and Arosa Bay. Pop. (1900) 12,218. Ribeira is in a hilly country, abounding in wheat, wine, fruit, fish and game. Its port is Santa Eugenia de Ribeira, on Arosa Bay. The population is chiefly occupied in agriculture, cattle-breeding and fisheries.

RIBEIRO, BERNARDIM (1482-1552), the father of bucolic prose and verse in Portugal, was a native of Torrão in the Alemtejo. His father, Damião Ribeiro, was implicated in the conspiracy against King John II. in 1484, and had to flee to Castile, whereupon young Bernardim and his mother took refuge with their relations Antonio Zagalo and D. Ignez Zagalo at the Quinta dos Lobos, near Cintra. When King Manoel came to the throne in 1495, he rehabilitated the families persecuted by his predecessor, and Ribeiro was able to leave his retreat and return to Torrão. Meanwhile D. Ignez had married a rich landowner of Estremoz, and in 1503 she was summoned to court and appointed one of the attendants to the Infanta D. Beatriz. Ribeiro accompanied her, and through her influence the king took him under his protection and sent him to the university of Lisbon, where he studied from 1506 to 1512. When he obtained his degree in law, the king showed him further favour by appointing him to the post of *Escrivão da Camara*, or secretary, and later by bestowing on him the habit of the military order by São Thiago. Ribeiro's poetic career commenced with his coming to court, and his early verses are to be found in the *Cancioneiro Geral* of Garcia de Resende (*q.v.*). He took part in the historic *Serões do Paço*, or palace evening entertainments, which largely consisted of poetical improvisations; there he met and earned the friendship of the poets Sá de Miranda (*q.v.*) and Christovão Falcão (*q.v.*), who became his literary comrades and the confidants of his romance, in which hope deferred and bitter disappointment ended in tragedy. Ribeiro had early conceived a violent passion for his cousin, D. Joanna Zagalo, the daughter of his protectress, D. Ignez; but, though she seems to have returned it, her family opposed her marriage to a singer and dreamer with small means and prospects, and finally compelled her to wed a rich man, one Pero Gato. When the latter met a violent death shortly afterwards, D. Joanna retired to a house in the country, and it is alleged that Ribeiro visited her, and that their amour resulted in the birth of a child. All we know positively, however, is that in 1521 the lady went into seclusion in the convent of St Clare at Estremoz, where she fell a victim to a violent form of insanity, and that she died there some years later. It is further alleged that Ribeiro's conduct had caused a scandal which led the king to deprive him of his office and exile him. But the loss of position and income can have added very little to the poignant grief of such a true lover and profound idealist as Bernardim Ribeiro. He had poured out his heart in five beautiful eclogues, the earliest in Portuguese, written in the popular octosyllabic verse; and now, hopeless of the future and broken in spirit, he decided to go to Italy, for a poet the land of promise. He started early in 1522, and travelled widely in the peninsula, and during his stay he wrote his moving knightly and pastoral romance *Menina e Moça*, in which he related the story of his unfortunate passion, personifying himself under the anagram of "Bimnarder," and D. Ignez under that of "Aonia." When he returned home in 1524, the new king, John III., restored him to his former post, and it is said that he paid a last visit to his love at St Clare's convent and found her in a fit of raving madness. This no doubt preyed on a mind already unhinged by trouble, and hastened the decline of his mental powers, which had already commenced. About 1534 a long illness supervened, and the years that elapsed between that year and his death may be described as the night of his soul. He was quite unable to fulfil the duties of his office, and in 1540 the king bestowed upon him a pension for his support; but he did not live long to enjoy it, for in 1552 he died insane in All Saints Hospital in Lisbon.

The *Menina e Moça* was not printed until after Ribeiro's death, and then first in Ferrara in 1554. On its appearance

the book made such a sensation that its reading was forbidden, because, though it contained nothing heterodox, it disclosed a family tragedy which the allegory could not hide. It is divided into two parts, the first of which is certainly the work of Ribeiro, while as to the second opinion is divided, though Dr Theophilo Braga considers it genuine and explains its progressive lack of lucidity and order by the mental illness of the author. The first part has been ably edited by Dr José Pessanha (Oporto, 1891). Ribeiro's verses, including his five eclogues, which for their sincerity of feeling, simple diction and chaste form are unsurpassed in Portuguese literature, were reprinted in a limited edition de luxe by Dr Xavier da Cunha (Lisbon, 1886).

AUTHORITIES.—Visconde Sanches de Baena, *Bernardim Ribeiro* (Lisbon, 1895); Dr Theophilo Braga, *Bernardim Ribeiro e o Bucolismo* (Oporto, 1897), containing a full analysis of Ribeiro's novel (sometimes called the *Sauvades*, though it is more commonly described, as here, by the initial words of the story, *Menina e Moça*). (E. Pr.)

RIBERA, GIUSEPPE (1588-1656), commonly called **Lo SPAGNOLETTO**, or the Little Spaniard, a leading painter of the Neapolitan or partly of the Spanish school, was born near Valencia in Spain, at Xativa, now named S. Felipe, on 12th January 1588. His parents intended him for a literary or learned career; but he neglected the regular studies, and entered the school of the Spanish painter Francisco Ribalta. Fired with a longing to study art in Italy, he somehow made his way to Rome. Early in the 17th century a cardinal noticed him in the streets of Rome drawing from the frescoes on a palace façade; he took up the ragged stripling and housed him in his mansion. Artists had then already bestowed upon the alien student, who was perpetually copying all sorts of objects in art and in nature, the nickname of *Lo Spagnoletto*. In the cardinal's household Ribera was comfortable but dissatisfied, and one day he decamped. He then betook himself to the famous painter Michelangelo da Caravaggio, the head of the naturalist school, called also the school of the Tenebrosi, or shadow-painters, owing to the excessive contrasts of light and shade which marked their style. The Italian master gave every encouragement to the Spaniard, but not for long, as he died in 1609. Ribera, who had in the first instance studied chiefly from Raphael and the Caracci, had by this time acquired so much mastery over the tenebroso style that his performances were barely distinguishable from Caravaggio's own. He now went to Parma, and worked after the frescoes of Correggio with great zeal and efficiency: in the museum of Madrid is his "Jacob's Ladder," which is regarded as his *chef-d'œuvre* in this manner. From Parma Spagnoletto returned to Rome, where he resumed the style of Caravaggio, and shortly afterwards he migrated to Naples, which became his permanent home.

Ribera was as yet still poor and inconspicuous, but a rich picture-dealer in Naples soon discerned in him all the stuff of a successful painter, and gave him his daughter in marriage. This was the turning-point in the Spaniard's fortunes. He painted a "Martyrdom of St Bartholomew," which the father-in-law exhibited from his balcony to a rapidly increasing and admiring crowd. The popular excitement grew to so noisy a height as to attract the attention of the Spanish viceroy, the Count de Monterey. From this nobleman and from the king of Spain, Philip IV., commissions now flowed in upon Ribera. With prosperity came grasping and jealous selfishness. Spagnoletto, chief in a triumvirate of greed, the "Cabal of Naples," his abettors being a Greek painter, Belisario Corenzio, and a Neapolitan, Giambattista Caracciolo, determined that Naples should be an artistic monopoly; by intrigue, terrorizing and personal violence on occasion they kept aloof all competitors. Annibale Caracci, the Cavalier d'Arpino, Guido, Domenichino, all of them successively invited to work in Naples, found the place too hot to hold them. The cabal ended at the time of Caracciolo's death in 1641.

The close of Ribera's triumphant career has been variously related. If we are to believe Dominici, the historian of Neapolitan art, he totally disappeared from Naples in 1648 and

was no more heard of—this being the sequel of the abduction by Don John of Austria, son of Philip IV., of the painter's beautiful only daughter Maria Rosa. But these assertions have not availed to displace the earlier and well-authenticated statement that Ribera died peaceably and wealthy in Naples in 1656. His own signature on his pictures is constantly "Jusepe de Ribera, Español." His daughter, so far from being disgraced by an abduction, married a Spanish nobleman who became a minister of the viceroy.

The pictorial style of Spagnoletto is extremely powerful. In his earlier style, founded (as we have seen) sometimes on Caravaggio and sometimes on the wholly diverse method of Correggio, the study of Spanish and Venetian masters can likewise be traced. Along with his massive and predominating shadows, he retained from first to last great strength of local colouring. His forms, though ordinary and partly gross, are correct; the impression of his works gloomy and startling. He delighted in subjects of horror. Salvator Rosa and Luca Giordano were his most distinguished pupils; also Giovanni Do, Enrico Fiammingo, Michelangelo Pracanzani, and Aniello Falcone, who was the first considerable painter of battle-pieces. Among Ribera's principal works should be named "St Januarius Emerging from the Furnace," in the cathedral of Naples; the "Descent from the Cross," in the Neapolitan Certosa, generally regarded as his masterpiece; the "Adoration of the Shepherds" (a late work, 1650), now in the Louvre; the "Martyrdom of St Bartholomew," in the museum of Madrid; the "Pieta," in the sacristy of S. Martino, Naples. His mythologic subjects are generally unpleasant—such as the "Silenus," in the Studj Gallery of Naples, and "Venus Lamenting over Adonis," in the Corsini Gallery of Rome. The Louvre contains altogether twenty-five of his paintings; the National Gallery, London, two—one of them, a "Pieta," being an excellent though not exactly a leading specimen. He executed several fine male portraits; among others his own likeness, now in the collection at Alton Towers. He also produced twenty-six etchings, ably treated. For the use of his pupils, he drew a number of elementary designs, which in 1650 were etched by Francisco Fernandez, and which continued much in vogue for a long while among Spanish and French painters and students.

Besides the work of Dominici already referred to (1840-46), the *Dictionnaire Historique* of Cean Bermudez is a principal authority regarding Ribera and his works; also E. de Laing, "Ribera" (in *Histoire de quatre grands peintres*), 1868. (W. M. R.)

RIBOT, ALEXANDRE FÉLIX JOSEPH (1842—), French statesman, was born at St Omer on 7th February 1842. After a brilliant career at the university of Paris, where he was *lauréat* of the faculty of law, he rapidly made his mark at the bar. He was secretary of the conference of advocates and one of the founders of the *Société de législation comparée*. During 1875 and 1876 he was successively director of criminal affairs and secretary-general at the ministry of justice. In 1877 he made his entry into political life by the conspicuous part he played on the committee of legal resistance during the Broglie ministry, and in the following year he was returned to the chamber as a moderate republican member for Boulogne, in his native department of Pas-de-Calais. His impassioned yet reasoned eloquence gave him an influence which was increased by his articles in the *Parlement* in which he opposed violent measures against the unauthorized congregations. He devoted himself especially to financial questions, and in 1882 was reporter of the budget. He became one of the most prominent republican opponents of the Radical party, distinguishing himself by his attacks on the short-lived Gambetta ministry. He refused to vote the credits demanded by the Ferry cabinet for the Tongking expedition, and shared with M. Clémenceau in the overthrow of the ministry in 1885. At the general election of that year he was one of the victims of the Republican rout in the Pas-de-Calais, and did not re-enter the chamber till 1887. After 1889 he sat for St Omer. His fear of the Boulangist movement converted him to the policy of "Republican Concentration," and he entered office in 1890 as

foreign minister in the Freycinet cabinet. He had an intimate acquaintance and sympathy with English institutions, and two of his published works—an address, *Biographie de Lord Erskine* (1866), and *Étude sur l'acte du 5 avril 1873 pour l'établissement d'une cour suprême de justice en Angleterre* (1874)—deal with English questions; he also gave a fresh and highly important direction to French policy by the understanding with Russia, which was declared to the world by the visit of the French fleet to Cronstadt in 1891, and which subsequently ripened into a formal treaty of alliance. He retained his post in the Loubet ministry (February–November 1892), and on its defeat became himself president of the council, retaining the direction of foreign affairs. The government resigned in March 1893 on the refusal of the chamber to accept the Senate's amendments to the budget. On the election of Félix Faure as president of the Republic in January 1895, M. Ribot again became premier and minister of finance. On the 10th of June he was able to make the first official announcement of a definite alliance with Russia. On the 30th of October the government was defeated on the question of the Chemin de fer du Sud, and resigned office. The real reason of its fall was the mismanagement of the Madagascar expedition, the cost of which in men and money exceeded all expectations, and the alarming social conditions at home, as indicated by the strike at Carmaux. After the fall of the Méline ministry in 1898 M. Ribot tried in vain to form a cabinet of "conciliation." He was elected, at the end of 1898, president of the important commission on education, in which he advocated the adoption of a modern system of education. The policy of the Waldeck-Rousseau ministry on the religious teaching congregations broke up the Republican party, and M. Ribot was among the seceders; but at the general election of 1902, though he himself secured re-election, his policy suffered a severe check. He actively opposed the policy of the Combes ministry and denounced the alliance with M. Jaurès, and on the 13th of January 1905 he was one of the leaders of the opposition which brought about the fall of the cabinet. Although he had been most violent in denouncing the anti-clerical policy of the Combes cabinet, he now announced his willingness to recognize a new régime to replace the Concordat, and gave the government his support in the establishment of the *Associations cultuelles*, while he secured some mitigation of the severities attending the separation. He was re-elected deputy for St Omer in 1906. In the same year he became a member of the French Academy in succession to the duc d'Audiffret-Pasquier; he was already a member of the Academy of Moral and Political Science. In justification of his policy in opposition he published in 1905 two volumes of his *Discours politiques*.

RIBOT, THÉODOLE (1823–1891), French painter, was born at Breteuil, in Eure, in 1823, and died at Bois Colombes, near Paris, in September 1891. A pupil nominally of Glaise, but more really of Ribera, of the great Flemings and of Chardin, Théodule Ribot had yet conspicuously his own noble and personal vision, his own intensity of feeling and rich sobriety of performance. Beginning to work seriously at art when he was no longer extremely young, and dying before he was extremely old, Ribot crowded into some thirty or thirty-five years of active practice very varied achievements; and he worked in at least three mediums, oil paint, pencil or crayon draughtsmanship and the needle of the etcher. His drawings were sometimes "complete in themselves," and sometimes fragmentary but powerful preparations for painted canvases. The etchings, of which there are only about a couple of dozen, are of the middle period of his practice; they show a diversity of method as well as of theme; the work in the well-nigh Velazquez-like "Prière"—a group of girl children—contrasting strongly with that process almost of outline alone, which he employed in the brilliant little group of prints which record his vision of the character and humours of cooks and kitchen-boys. In etching, the method varied with the theme—not with the period. It is quite otherwise with the paintings. Here the earlier work, irrespective of its subject, is the drier

and the more austere; the later work, irrespective of its subject, the freer and broader. But even in that which is quite early there is a curious and impressive intensity of conception and presentation. His visions of elderly women and young girls remain upon the memory. His women, wrinkled and worn, have had the experience of a hard and grinding world; his children, his young girls, are the quintessence of innocence and happy hopefulness, and life is a jest to his boys. His religious pieces, in which Ribera affected him, have conviction and force. Into portraits and into character studies, but more especially into *genre* subjects, Ribot was apt to introduce Still-life, and to make much of it. Herein, as in his sense of homeliness, he resembled Chardin. But again, Chardin-like, he painted Still-life for its own sake, by itself, and always with an extraordinary sense of the solidity and form, the texture and the hue, and, it must be added also, the very charm of matter. (F. WE.)

RIBOT, THÉODORE ARMAND (1839—), French psychologist, was born at Guingamp on the 18th of December 1839, and was educated at the Lycée de St Briec. In 1856 he began to teach, and was admitted to the École Normale Supérieure in 1862. In 1885 he gave a course of lectures on "Experimental Psychology" at the Sorbonne, and in 1888 was appointed professor of that subject at the College of France. His thesis for his doctor's degree, republished in 1882, *Hérédité: étude psychologique* (5th ed., 1889), is his most important and best known book. Following the experimental and synthetic methods, he has brought together a large number of instances of inherited peculiarities; he pays particular attention to the physical element of mental life, ignoring all spiritual or non-material factors in man. In his work on *La Psychologie anglaise contemporaine* (1870), he shows his sympathy with the sensationist school, and again in his translation of Herbert Spencer's *Principles of Psychology*. Besides numerous articles, he has written on Schopenhauer, *Philosophie de Schopenhauer* (1874; 7th ed., 1896), and on the contemporary psychology of Germany (*La Psychologie allemande contemporaine*, 1870; 13th ed., 1898), also four little monographs on *Les Maladies de la mémoire* (1881; 13th ed., 1898); *De la volonté* (1883; 14th ed., 1899); *De la personnalité* (1885; 8th ed., 1899); and *La Psychologie de l'attention* (1888), which supply useful data to the student of mental disease.

Other works by him are:—*La Psychologie des sentiments* (1896); *L'Évolution des idées générales* (1897); *Essai sur l'imagination créatrice* (1900); *La Logique des sentiments* (1904); *Essai sur les passions* (1906). Of the above the following have been translated into English:—*English Psychology* (1873); *Heredity: a Psychological Study of its Phenomena, Laws, Causes, and Consequences* (1875); *Diseases of Memory: An Essay in the Positive Psychology* (1882); *Diseases of the Will* (New York, 1884); *German Psychology of to-day*, tr. J. M. Baldwin (New York, 1886); *The Psychology of Attention* (Open Court Publishing Company, Chicago, 1890); *Diseases of Personality* (Chicago, 1895); *The Psychology of the Emotions* (1897); *The Evolution of General Ideas*, tr. F. A. Welby (Chicago, 1899); *Essay on the Creative Imagination*, tr. A. H. N. Baron (1906).

RICARDO, LOUIS GUSTAVE (1823—1873), French painter, was born in Marseilles in 1823, and studied first under Auber in his native town, and subsequently under Coignet in Paris. The formation of his masterly, distinguished style in portraiture was, however, due rather to ten years' intelligent copying of the old masters at the Louvre and at the Italian galleries, than to any school training. He was a master of technique, and his portraits—about two hundred—reveal an extraordinary insight into the character of his sitters. Nevertheless, for some time after his death his name was almost forgotten by the public, and it is only of quite recent years that he has been conceded the position among the leading masters of the modern French school which is his due. A portrait of himself, and one of Alfred de Musset, are at the Luxembourg Gallery. Among his best known works are the portrait of his mother, and those of the painters Fromentin, Heilbruth and Chaplin.

See *Gustave Ricard*, by Camille Mauclair (Paris, Librairie de l'art).

RICARDO, DAVID (1772—1823), English economist, was born in London on the 19th of April 1772, of Jewish origin. His father, who was of Dutch birth, bore an honourable character and was a successful member of the Stock Exchange. At the age of fourteen Ricardo entered his father's office, where he showed much aptitude for business. About the time when he attained his majority he abandoned the Hebrew faith and conformed to the Anglican Church, a change which seems to have been connected with his marriage to Miss Wilkinson, which took place in 1793. In consequence of the step thus taken he was separated from his family and thrown on his own resources. His ability and uprightiness were known, and he at once entered on such a successful career in the profession to which he had been brought up that at the age of twenty-five, we are told, he was already rich. He now began to occupy himself with scientific pursuits, and gave some attention to mathematics as well as to chemistry and mineralogy; but, having met with Adam Smith's great work, he threw himself with ardour into the study of political economy.

His first publication (1809) was *The High Price of Bullion a Proof of the Depreciation of Bank Notes*. This tract was an expansion of a series of articles which the author had contributed to the *Morning Chronicle*. It gave a fresh stimulus to the controversy, which had for some time been discontinued, respecting the resumption of cash payments, and indirectly led to the appointment of a committee of the House of Commons, commonly known as the Bullion Committee, to consider the whole question. The report of the committee asserted the same views which Ricardo had put forward, and recommended the repeal of the Bank Restriction Act. Notwithstanding this, the House of Commons declared in the teeth of the facts that paper had undergone no depreciation. Ricardo's first tract, as well as another on the same subject, attracted much attention.

In 1811 he made the acquaintance of James Mill, whose introduction to him arose out of the publication of Mill's tract entitled *Commerce Defended*. Whilst Mill doubtless largely affected his political ideas, he was, on his side, under obligations to Ricardo in the purely economic field; Mill said in 1823 that he himself and J. R. McCulloch were Ricardo's disciples, and, he added, his only genuine ones.

In 1815, when the Corn Laws were under discussion, he published his *Essay on the Influence of a Low Price of Corn on the Profits of Stock*. This was directed against a recent tract by Malthus entitled *Grounds of an Opinion on the Policy of Restraining the Free Importation of Foreign Corn*. The reasonings of the essay are based on the theory of rent which has often been called by the name of Ricardo; but the author distinctly states that it was not due to him. "In all that I have said concerning the origin and progress of rent I have briefly repeated, and endeavoured to elucidate, the principles which Malthus has so ably laid down on the same subject in his *Inquiry into the Nature and Progress of Rent*." We now know that the theory had been fully stated, before the time of Malthus, by Anderson; it is in any case clear that it was no discovery of Ricardo. Ricardo states in this essay a set of propositions, most of them deductions from the theory of rent, which are in substance the same as those afterwards embodied in the *Principles*, and regarded as characteristic of his system, such as that increase of wages does not raise prices; that profits can be raised only by a fall in wages and diminished only by a rise in wages; and that profits, in the whole progress of society, are determined by the cost of the production of the food which is raised at the greatest expense. It does not appear that, excepting the theory of foreign trade, anything of the nature of fundamental doctrine, as distinct from the special subjects of banking and taxation, is laid down in the *Principles* which does not already appear in this tract. We find in it, too, the same exclusive regard to the interest of the capitalist class, and the same identification of their interest with that of the whole nation, which are generally characteristic of his writings.

In the *Proposals for an Economical and Secure Currency* (1816) he first disposes of the chimera of a currency without a specific standard, and pronounces in favour of a single metal, with a preference for silver, as the standard.

Ricardo's chief work, *Principles of Political Economy and Taxation*, appeared in 1817. The fundamental doctrine of this work is that, on the hypothesis of free competition, exchange value is determined by the labour expended in production,—a proposition not new, nor, except with considerable limitation and explanation, true, and of little practical use, as "amount of labour" is a vague expression, and the thing intended is incapable of exact estimation. Ricardo's theory of distribution has been briefly enunciated as follows: "(1) The demand for food determines the margin of cultivation; (2) this margin determines rent; (3) the amount necessary to maintain the labourer determines wages; (4) the difference between the amount produced by a given quantity of labour at the margin and the wages of that labour determines profit." These theorems are too absolutely stated, and require much modification to adapt them to real life. His theory of foreign trade has been embodied in the two propositions: "(1) International values are not determined in the same way as domestic values; (2) the medium of exchange is distributed so as to bring trade to the condition it would be in if it were conducted by barter."

A considerable portion of the work is devoted to a study of taxation, which requires to be considered as a part of the problem of distribution. A tax is not always paid by those on whom it is imposed; it is therefore necessary to determine the ultimate, as distinguished from the immediate, incidence of every form of taxation. Smith had already dealt with this question; Ricardo develops and criticizes his results. The conclusions at which he arrives are in the main as follows: a tax on raw produce falls on the consumer, but will also diminish profits; a tax on rents on the landlord; taxes on houses will be divided between the occupier and the ground landlord; taxes on profits will be paid by the consumer, and taxes on wages by the capitalist.

In 1819 Ricardo, having retired from business and become a landed proprietor, entered parliament as member for Portlinton. He was at first diffident and embarrassed in speaking, but gradually overcame these difficulties, and was heard with much attention and deference, especially when he addressed the House on economic questions. He probably contributed in a considerable degree to bringing about the change of opinion on the question of free trade which ultimately led to the legislation of Sir Robert Peel on that subject.

In 1820 he contributed to the supplement of the *Encyclopaedia Britannica* (6th ed.) an "Essay on the Funding System." In this besides giving an historical account (founded on Dr Robert Hamilton's valuable work *On the National Debt*, 1813, 3rd ed., 1818) of the several successive forms of the sinking fund, he urges that nations should defray their expenses, whether ordinary or extraordinary, at the time when they are incurred, instead of providing for them by loans.

In 1822 he published a tract *On Protection to Agriculture*, which is an able application to controversy of the general principles laid down in his systematic work. Its arguments and conclusions are therefore subject to the same limitations which those fundamental principles require.

In his *Plan for the Establishment of a National Bank*, published posthumously in 1824, he proposes that the issue of the paper currency should be taken out of the hands of the Bank of England and vested in commissioners appointed by the government. The tract describes in detail the measures to be adopted for the introduction and working of the system. A certain step towards realizing the objects of his scheme, though on different lines from Ricardo's, was taken in Sir Robert Peel's act of 1844, by which the discount business of the bank was separated from the issue department.

Ricardo died on the 11th of September 1823, at his seat

(Gatcomb Park) in Gloucestershire, from a cerebral affection resulting from disease of the ear. James Mill, who was intimately acquainted with him, says (in a letter to Napier of November 1818) that he knew not a better man, and on the occasion of his death published a highly eulogistic notice of him in the *Morning Chronicle*. A lectureship on political economy, to exist for ten years, was founded in commemoration of him, M'Culloch being chosen to fill it.

In forming a general judgment respecting Ricardo, we must have in view not so much the minor writings as the *Principles*, in which his economic system is expounded as a whole. By a study of this work we are led to the conclusion that he was an economist only, not at all a social philosopher in the wider sense, like Adam Smith or John Mill. He had great acuteness, but little breadth. For any large treatment of moral and political questions he seems to have been alike by nature and preparation unfitted; and there is no evidence of his having had any but the most ordinary and narrow views of the great social problems. He shows no trace of that hearty sympathy with the working classes which breaks out in several passages of the *Wealth of Nations*; we ought, perhaps, with Held, to regard it as a merit in Ricardo that he does not cover with fine phrases his deficiency in warmth of social sentiment. The idea of the active capitalist having any duties towards his employes never seems to occur to him; the labourer is, in fact, merely an instrument in the hands of the capitalist, a pawn in the game he plays.

He first introduced into economics on a great scale the method of deduction from a priori assumptions. The conclusions so arrived at have often been treated as if they were directly applicable to real life, and indeed to the economic phenomena of all times and places. But the truth of Ricardo's theorems is now by his warmest admirers admitted to be hypothetical only. Bagehot seems right in believing that Ricardo himself had no consciousness of the limitations to which his doctrines are subject. Be this as it may, we now see that the only basis on which these doctrines could be allowed to stand as a permanent part of economic science is that on which they are placed by Roscher, namely, as a stage in the preparatory work of the economist, who, beginning with such abstractions, afterwards turns from them, not in practice merely, but in the completed theory, to real life and men as they actually are or have been.

The criticisms to which Ricardo's general economic scheme is open do not hold with respect to his treatment of the subjects of currency and banking. These form precisely that branch of economics into which moral ideas (beyond the plain prescriptions of honesty) can scarcely be said to enter, and where the operation of purely mercantile principles is most immediate and invariable. They were, besides, the departments of the study to which Ricardo's early training and practical habits led him to give special attention; and they have a lasting value independent of his systematic construction.

Ricardo's collected works were published, with a notice of his life and writings, by J. R. M'Culloch in 1846.

The *Principles* have been edited (with an introduction, bibliography and notes) by E. C. K. Gonner, 1891. See also *Letters to H. Trener and Others*, ed. J. Bonar and J. H. Hollander, 1899; *Letters to J. R. M'Culloch*, ed. J. H. Hollander, 1895; *Letters to T. R. Malthus*, ed. J. Bonar, 1887. A French translation of the *Principles* by Constancio, with notes by Say, appeared in 1818; the whole works, translated by Constancio and Fonteyraud, form vol. xiii. (1847) of the *Collection des principaux économistes*, where they are accompanied by the notes of Say, Malthus, Sismondi, Rossi, &c. The *Principles* was first "naturalized" in Germany, says Roscher (though another version by Von Schmalz had previously appeared), by Edward Baumstark in his *David Ricardo's Grundgesetze der Volkswirtschaft und der Besteuerung übersetzt und erläutert* (1837), which Roscher highly commends, not only for the excellence of the rendering, but for the value of the explanations and criticisms which are added.

RICASOLI, BETTINO, BARON (1800-1880), Italian statesman, was born at Broglio on the 19th of March 1800. Left an orphan at eighteen, with an estate heavily encumbered, he was by special decree of the grand duke of Tuscany declared of age, and

entrusted with the guardianship of his younger brothers. Interrupting his studies, he withdrew to Broglio, and by careful management disencumbered the family possessions. In 1847 he founded the journal *La Patria*, and addressed to the grand duke a memorial suggesting remedies for the difficulties of the state. In 1848 he was elected Gonfaloniere of Florence, but resigned on account of the anti-Liberal tendencies of the grand duke. As Tuscan minister of the interior in 1859 he promoted the union of Tuscany with Piedmont, which took place on the 12th of March 1860. Elected Italian deputy in 1861, he succeeded Cavour in the premiership. As premier he admitted the Garibaldian volunteers to the regular army, revoked the decree of exile against Mazzini, and attempted reconciliation with the Vatican; but his efforts were rendered ineffectual by the *non possumus* of the pope. Disdainful of the intrigues of his rival Rattazzi, he found himself obliged in 1862 to resign office, but returned to power in 1866. On this occasion he refused Napoleon III.'s offer to cede Venetia to Italy, on condition that Italy should abandon the Prussian alliance, and also refused the Prussian decoration of the Black Eagle because Lamarmora, author of the alliance, was not to receive it. Upon the departure of the French troops from Rome at the end of 1866 he again attempted to conciliate the Vatican with a convention, in virtue of which Italy would have restored to the Church the property of the suppressed religious orders in return for the gradual payment of £24,000,000. In order to mollify the Vatican he conceded the *exequatur* to forty-five bishops inimical to the Italian régime. The Vatican accepted his proposal, but the Italian Chamber proved refractory, and, though dissolved by Ricasoli, returned more hostile than before. Without waiting for a vote, Ricasoli resigned office and thenceforward practically disappeared from political life, speaking in the Chamber only upon rare occasions. He died at Broglio on the 23rd of October 1880. His private life and public career were marked by the utmost integrity, and by a rigid austerity which earned him the name of the "iron baron." In spite of the failure of his ecclesiastical scheme, he remains one of the most noteworthy figures of the Italian Risorgimento.

See Tabarrini and Gotti, *Lettere e documenti del barone Bettino Ricasoli*, 10 vols. (Florence, 1886-1894); Passerini, *Genealogia e storia della famiglia Ricasoli* (*ibid.* 1861); Gotti, *Vita del barone Bettino Ricasoli* (*ibid.* 1894).

RICCATI, JACOPO FRANCESCO, COUNT (1676-1754), Italian mathematician, was born at Venice on the 8th of May 1676, and died at Treviso on the 15th of April 1754.

He studied at the university of Padua, where he graduated in 1696. His favourite pursuits were scientific, and his authority on all questions of practical science was referred to by the senate of Venice. He corresponded with many of the European savants of his day, and contributed largely to the *Acta Eruditorum* of Leipzig. He was offered the presidency of the academy of science of St Petersburg; but he declined, preferring the leisure and independence of life in Italy. Riccati's name is best known in connexion with his problem called Riccati's equation, published in the *Acta Eruditorum*, September 1724. A very complete account of this equation and its various transformations was given by J. W. L. Glaisher in the *Phil. Trans.* (1881).

After Riccati's death his works were collected by his sons and published (1758) in four volumes. His sons, Vincenzo (1707-1775) and Giordano (1709-1790), inherited his talents. The former was professor of mathematics at Bologna, and published, among other works, a treatise on the infinitesimal calculus. Giordano was distinguished both as a mathematician and an architect.

RICCI, MATTEO (1552-1610), Italian missionary to China, was born of a noble family at Macerata in the March of Ancona on the 7th of October 1552. After some education at a Jesuit college in his native town he went to study law at Rome, where in 1571, in opposition to his father's wishes, he joined the Society of Jesus.

In 1577 Ricci and other students offered themselves for the East Indian missions. Ricci, without visiting his family to take

leave, proceeded to Portugal. His comrades were Rudolfo Acquaviva, Nicolas Spinola, Francesco Pasio and Michele Ruggieri, all afterwards, like Ricci himself, famous in the Jesuit annals. They arrived at Goa in September 1578. After four years spent in India, Ricci was summoned to the task of opening China to evangelization.

Several fruitless attempts had been made by Xavier, and since his death, to introduce the Church into China,—as by Melchior Nunes of the Jesuit Society operating from Sanchian¹ in 1555; by Gaspar da Cruz, a Dominican, in that or the following year; by the Augustinians under Martin Herrada, 1575; and in 1579 by the Franciscans led by Pedro d'Alfaro. In 1571 a house of the Jesuits had been set up at Macao (where the Portuguese were established in 1557), but their attention was then occupied with Japan, and it was not till the arrival at Macao of Alessandro Valignani on a visitation in 1582 that work in China was really taken up. For this object he had obtained the services first of M. Ruggieri and then of Ricci. After various disappointments they found access to Chow-king-fu on the Si-Kiang or West River of Canton, where the viceroy of the two provinces of Kwang-tung and Kwang-si then had his residence, and by his favour were able to establish themselves there for some years. Their proceedings were very cautious and tentative; they excited the curiosity and interest of even the more intelligent Chinese by their clocks, their globes and maps, their books of European engravings, and by Ricci's knowledge of mathematics, including dialling and the projection of maps. They conciliated some influential friends, and their reputation spread widely in China. This was facilitated by the Chinese system of transfer of public officers from one province of the empire to another, and in the later movements of the missionaries they frequently met with one and another of their old acquaintances in office, who were more or less well disposed. Eventually troubles at Chow-king compelled them to seek a new home; and in 1589, with the viceroy's sanction, they migrated to Chang-chow in the northern part of Kwang-tung, not far from the well-known Melling Pass.

During his stay here Ricci was convinced that a mistake had been made in adopting a dress resembling that of the bonzes, a class who were the objects either of superstition or of contempt. With the sanction of the visitor it was ordered that in future the missionaries should adopt the costumes of Chinese literates, and, in fact, they before long adopted Chinese manners altogether.

Chang-chow, as a station, did not prove a happy selection, but it was not till 1595 that an opportunity occurred of travelling northward. For some time Ricci's residence was at Nan-chang-fu, the capital of Kiang-si; but in 1598 he was able to proceed under favourable conditions to Nan-king, and thence for the first time to Peking, which had all along been the goal of his missionary ambition. But circumstances were not then propitious, and the party had to return to Nan-king. The fame of the presents which they carried had, however, reached the court, and the Jesuits were summoned north again, and on the 24th of January 1601 they entered the capital. Wan-li, the emperor of the Ming dynasty, in those days lived in seclusion, and saw no one but his women and the eunuchs. But the missionaries were summoned to the palace; their presents were immensely admired, and the emperor had the curiosity to send for portraits of the fathers themselves.

They obtained a settlement, with an allowance for subsistence, in Peking, and from this time to the end of his life Ricci's estimation among the Chinese was constantly increasing, as was at the same time the amount of his labours. Visitors thronged the mission house incessantly; and inquiries came to him from all parts of the empire respecting the doctrines which he taught, or the numerous Chinese publications which he issued. This in itself was a great burden, as Chinese composition, if wrong impressions are to be avoided, demands extreme care and accuracy. As head of the mission, which now had four stations

¹ The island (properly Chang-chuen) on which the Portuguese had a temporary settlement before they got Macao, and on which F. Xavier died in 1552.

in China, he also devoted much time to answering the letters of the priests under him, a matter on which he spared no pains or detail. New converts had to be attended to—always welcomed, and never hustled away. Besides these came the composition of his Chinese books, the teaching of his people and the maintenance of the record of the mission history which had been enjoined upon him by the general of the order, and which he kept well up to date. Thus his labours were wearing and incessant. In May 1610 he broke down, and after an illness of eight days died on the 11th of that month. His colleague Pantoja applied to the emperor for a burying-place outside the city. This was granted, with the most honourable official testimonies to the reputation and character of Ricci; and a large building in the neighbourhood of the city was at the same time bestowed upon the mission for their residence.

Ricci's work was the foundation of the subsequent success attained by the Roman Catholic Church in China. When the missionaries of other Roman Catholic orders made their way into China, twenty years later, they found great fault with the manner in which certain Chinese practices had been dealt with by the Jesuits, a matter in which Ricci's action and policy had given the tone to the mission in China—though in fact that tone was rather inherent in the Jesuit system than the outcome of individual character, for controversies of an exactly parallel nature arose two generations later in southern India, between the Jesuits and Capuchins, regarding what were called "Malabar rites."¹ The controversy thus kindled in China burned for considerably more than a century with great fierceness.² The chief points were (1) the lawfulness and expediency of certain terms employed by the Jesuits in naming God Almighty, such as *Tien*, "Heaven," and *Shang-ti*, "Supreme Ruler" or "Emperor," instead of *Tien-Chu*, "Lord of Heaven," and in particular the erection of inscribed tablets in the churches, on which these terms were made use of; (2) in respect to the ceremonial offerings made in honour of Confucius, and of personal ancestors, which Ricci had recognized as merely "civil" observances; (3) the erection of tablets in honour of ancestors in private houses; and (4), more generally, sanction and favour accorded to ancient Chinese sacred books and philosophical doctrine, as not really trespassing on Christian faith.

Probably no European name of past centuries is so well known in China as that of *Li-ma-teu*, the form in which the name of Ricci (*Ricci Mal-teo*) was adapted to Chinese usage, and by which he appears in Chinese records.³ The works which he composed in Chinese are numerous; a list of them (apparently by no means complete, however) will be found in Kircher's *China Illustrata*, and also in Abel Rémusat's *Nouveaux Mélanges Asiatiques* (ii. 213-15). They are said to display an aptitude for clothing ideas in a Chinese dress very rare and remarkable in a foreigner. One of the first which attracted

¹ The list of the literature of this controversy occupies forty-one columns in M. Cordier's excellent *Bibliographie de la Chine*.

² Compare Browning, *The Ring and the Book*, x., The Pope, 1589-1603.

³ The name comes forward prominently in the mouth of the emperor Kang-hi, in a dialogue which took place between him and Monsgr. Maigrot, the leader of the anti-Jesuit movement (mentioned in Browning's lines referred to above), at the summer residence in Tartary, August 1706—a dialogue which the Jesuits have reported with not a little malice:—

"Emperor. "Tell me why do the people call me *Van-sui* (10,000 years). *The Most Reverend* (i.e. Maigrot), 'To express their desire for your Majesty's long life.' *Emp.* 'Good. You see, then, Chinese words are not always to be taken literally. We pay cult to Confucius and to the dead to express our respect for them. How is that inconsistent with your religion? When did it begin to be so? Is it since Ly-Matthew's time? Hast thou ever read Ly-Matthew?' *The Most Reverend*, turning to P. Parenin, whispers, 'Who's he?' and learning that it was P. Matteo Ricci, . . . answered the emperor: 'I have not read that book.' *Emp.* 'Ly-Matthew and his fellows came hither some two centuries ago; and before their time China never heard anything of the Incarnation, anything of *Tien-chu*, who had not become incarnate in this part of the world. Why then, if it was lawful to call God *Tien* before Ly-Matthew's time, should it be improper now?'—*Epistola de Evento Apostolica Legationis, scripta a PP. Missionariis . . . ad Praespositum Generalem S. J.*, An. 1706; 1 Novembris.

attention and reputation among Chinese readers was a Treatise upon Friendship, in the form of a dialogue containing short and pithy paragraphs; this is stated in the *De Expeditione* to have been suggested during Ricci's stay at Nan-chang by a conversation with the prince of Kien-ngan, who asked questions regarding the laws of friendship in the West.

In the early part of his residence at Peking, when enjoying constant intercourse with scholars of high position, Ricci brought out the *T'ien-chu shih-i*, or "Veritable Doctrine of the Lord of Heaven," which deals with the divine character and attributes under eight heads. "This work," says A. Wylie, "contains some acute reasoning in support of the propositions laid down, but the doctrine of faith in Christ is very slightly touched upon. The teachings of Buddhism are vigorously attacked, whilst the author tries to draw a parallel between Christianity and the teachings of the Chinese literati."

In 1604 Ricci completed the *Erh-shih-wu yen*, a series of short articles of moral bearing, but exhibiting little of the essential doctrines of Christianity. *Chi-jên shih pien* is another of his productions, completed in 1608, and consisting of a record of ten conversations held with Chinese of high position. The subjects are: (1) Years past no longer ours; (2) Man a sojourner on earth; (3) Advantage of frequent contemplation of eternity; (4) Preparation for judgment by such contemplation; (5) The good man not desirous of talking; (6) Abstinence, and its distinction from the prohibition to take life; (7) Self-examination and self-reproof inconsistent with inaction; (8) Future reward and punishment; (9) Prying into futurity hastens calamity; (10) Wealth with covetousness more wretched than poverty with contentment. To this work is appended a translation of eight European hymns, with elucidations, written in 1609.

Some of the characteristics thus indicated may have suggested the bitterness of attacks afterwards made upon Ricci's theology. An example of these is found in the work called *Anecdotes sur l'état de religion dans la Chine* (Paris, 1733-35), the author of which (Abbé Villers) speaks of the *T'ien-chu shih-i* in this fashion: "The Jesuit was also so ill versed in the particulars of the faith that, as the holy bishop of Conon, Monsgr. Maigrot, says of him, one need merely read his book on the true religion to convince oneself that he had never imbibed the first elements of theology." . . .

Ricci's pointed attacks on Buddhism, and the wide circulation of his books, called forth the opposition of the Buddhist clergy. One of the ablest who took their part was Chu-hang, a priest of Hang-chow, who had abandoned the literary status for the Buddhist cloister. He wrote three articles against the doctrine of the missionaries. These were brought to Ricci's notice in an ostensible tone of candour by Yu-chun-he, a high mandarin at the capital. This letter, with Ricci's reply, the three Buddhist declamations and Ricci's confutation, were published in a collected form by the Christian Sen-Kwang-K'e.

Another work of Ricci's which attracted attention was the *Hsi-kuo fa*, or "Art of Memory as practised in the West." Ricci was himself a great expert in *memoria technica*, and astonished the Chinese by his performances in this line. He also wrote or edited various Chinese works on geography, the celestial and terrestrial spheres, geometry and arithmetic. And the detailed history of the mission was drawn out by him, which after his death was brought home by P. Nicolas Trigault, and published at Augsburg, and later in a complete form at Lyons under the name *De Expeditione Christiana apud Sinas Suscepita, ab Soc. Jesu*, Ex P. Mat. Ricci ejusdem Societatis Commentariis, Trigault himself adding many interesting notes on China and the Chinese.

Among the scientific works which Ricci took into China was a set of maps, which at first created great interest, but afterwards disgust when the Chinese came to perceive the insignificant place assigned to the "Middle Kingdom," thrust, as it seemed, into a corner, instead of being set in the centre of the world like the gem in a ring. Ricci, seeing their dissatisfaction, set about constructing a map of the hemisphere on a great scale, so adjusted that China, with its subject states, filled the central

area, and, without deviating from truth of projection, occupied a large space in proportion to the other kingdoms gathered round it. All the names were then entered in Chinese calligraphy. This map obtained immense favour, and was immediately engraved at the expense of the viceroy and widely circulated.

In the accompanying cut we have endeavoured to portray this map. The projection adopted is a perspective of the hemisphere



of the poles would be seen, whilst the exaggeration of China would have been too gross for a professed representation of the hemisphere.

The chief facts of Ricci's career are derived from Trigault; some contemporary works on the rites controversy have also been consulted; in the notice of Ricci's Chinese writings valuable matter has been derived from *Notes on Chinese Literature* by A. Wylie (London and Shanghai, 1867). A number of Ricci's letters are extant in the possession of the family, and access to them was afforded to Giuseppe La Farina, author of the work called *La China, considerata nella sua Storia*, &c. (Florence, 1843), by the Marchese Amico Ricci of Macerata, living at Bologna. La Farina's quotations contain nothing of interest. There is a curious Chinese account of Ricci published by Dr Breitschneider in the *China Review*, iv. 391 sq. (H. Y.)

RICCIARELLI, DANIELE (1509-1566), Italian artist, generally called, from the place of his birth, DANIELE DA VOLTERRA, studied painting under Sodoma and Peruzzi. Settling in Rome, he received abundant encouragement. His constant friend, Michelangelo, recommended him on all possible occasions, and he was commissioned to beautify with works of art a chapel in the church of the Trinità, to paint in the Farnese Palace, to execute certain decorations in the Palazzo de' Medici at Navona, and to begin the stucco work and the pictures in the Hall of the Kings. Towards the close of his life he turned his attention to statuary. His last work was a bronze horse intended for an equestrian statue of Henry II. of France. He died in 1566. The principal extant works of Ricciarelli are at Rome. These are a "St John the Baptist" in the picture gallery of the Capitol, a "Saviour bearing the Cross" in the Palazzo Rospigliosi, and a "Descent from the Cross," his masterpiece, in the church of Trinità de Monti. There is also an "Elijah" at Volterra.

RICCOBONI, MARIE JEANNE (1714-1792), whose maiden name was Laboras de Mézières, was born at Paris in 1714. She married in 1735 Antoine François Riccoboni, a comedian and dramatist, from whom she soon separated. She herself was an actress, but did not succeed on the stage. Her works are *Lettres de mistress Fanny Butler* (1757); the remarkable *Histoire du marquis de Cressy* (1758); *Milady Juliette Catesby* (1759-1760), like her other books, in letter form; *Ernestine* (1798), which La Harpe thought her masterpiece; and three series of *Lettres* in the names of *Adelaide de Dammartin* (*comtesse de Sancerre*) (2 vols., 1766), *Elizabeth Sophie de Vallière* (2 vols., 1772), and *Milord Rivers* (2 vols., 1776). She obtained a small pension from the crown, but the Revolution deprived her of it, and she died on the 6th of December 1792 in great

indigence. Besides the works named, she wrote a novel (1762) on the subject of Fielding's *Amelia*, and supplied in 1765 a continuation (but not the conclusion sometimes erroneously ascribed to her) of Marivaux's unfinished *Marianne*.

All Madame Riccoboni's work is clever, and there is real pathos in it. But it is among the most eminent examples of the "sensibility" novel, of which no examples but Sterne's have kept their place in England, and that not in virtue of their sensibility. A still nearer parallel may be found in the work of Mackenzie. Madame Riccoboni is an especial offender in the use of mechanical aids to impressiveness—italics, dashes, rows of points and the like. The principal editor of her complete works is that of Paris (6 vols., 1818). The chief novels appear in a volume of Garnier's *Bibliothèque amusante* (Paris, 1865).

See Julia Kavanagh, *French Women of Letters* (2 vols., 1862), where an account of her novels is given; J. Fleury, *Marivaux et le marivaudage* (Paris, 1881); J. M. Quérard, *La France littéraire* (vol. vii., 1835); and notices by La Harpe, Grimm and Diderot prefixed to her *Œuvres* (9 vols., Paris, 1826).

RICE, EDMUND IGNATIUS (1762-1844), Irish philanthropist, founder of the "Irish Christian Brothers," was born at Westcourt, near Callen, Kilkenny, on the 1st of June 1762. He entered the business of his uncle, an export provision merchant in Waterford, in 1779 and succeeded him in 1790. In 1796 he established an organization for visiting and relieving the poor, and in 1802 began to educate the poor children of Waterford, renting a school and supporting two teachers. In 1803 he gave up his business and, joined by a number of friends, began to systematize his plans. Others, like-minded, opened schools at Dungarvan and Carrick-on-Suir. The little society numbered nine in 1808, and meeting at Waterford took religious vows from their bishop, assumed a "habit" and adopted an additional Christian name, by which, as by the collective title "Christian Brothers," they were thenceforth known. Schools were established in Cork (1811), Dublin (1812), and Thurles and Limerick (1817). In 1820 Pope Pius VII. issued a brief sanctioning the order of "Religious Brothers of the Christian Schools (Ireland)," the members of which were to be bound by vows of obedience, chastity, poverty and perseverance, and to give themselves to the free instruction, religious and literary, of male children, especially the poor. The heads of houses were to elect a superior general, and Rice held this office from 1822 to 1838, during which time the institution extended to several English towns (especially in Lancashire), and the course of instruction grew out of the primary stage. Rice died on the 20th of August 1844. The Irish Christian Brothers have some hundred houses in Ireland with 300 attached schools and over 30,000 pupils. There are also industrial schools and orphanages, and the institute has branches in Australia, India, Gibraltar and Newfoundland.

RICE, JAMES (1843-1882), English novelist, was born at Northampton on the 26th of September 1843. Educated at Queens' College, Cambridge, where he graduated in law in 1867, he was called to the bar at Lincoln's Inn in 1871. In the meantime (1868) he had bought *Once a Week*, which proved a losing venture for him, but which brought him into touch with Walter Besant, a contributor to Besant's preface to the Library Edition (1887) of *Ready-money Moriboy*. There ensued a close friendship and a literary partnership between the two men which lasted ten years until Rice's death, and resulted in a large number of successful novels. The first of them, published anonymously, Rice being responsible for the central figure and the leading situation, was *Ready-money Moriboy* (1872), dramatized by them later and unsuccessfully produced at the Court Theatre in 1874. In rapid succession followed *My Little Girl* (1873); *With Harp and Croon* (1874); *This Son of Vulcan* (1876); *The Golden Butterfly* (1876), the most popular of their joint productions; *The Monks of Thelema* (1878); *By Celia's Arbour* (1878); *The Seamy Side* (1880); *The Chaplain of the Fleet* (1881); *Sir Richard Whittington* (1881), and a large number of short stories, some of them reprinted in *The Case of Mr. Lucaft*, &c. (1876), *'Twas in Trafalgar's Bay*, &c. (1879), and *The Ten Years' Tenant*, &c. (1881).

James Rice died at Redhill on the 26th of April 1882.

RICE (Greek *ὀρύζα*, Latin *oryza*, French *riz*, Italian *riso*, Spanish *arroz*, derived from the Arabic), a well-known cereal, botanical name *Oryza sativa*. According to Roxburgh, the great Indian botanist, the cultivated rice with all its numerous varieties has originated from a wild plant, called in India Newaree or Nivara, which is indigenous on the borders of lakes in the Circars and elsewhere in India, and is also native in tropical Australia. The rice plant is an annual grass with long linear

glabrous leaves, each provided with a long sharply pointed ligule. The spikelets are borne on a compound or branched spike, erect at first but afterwards bent downwards. Each spikelet contains a solitary flower with two outer small barren glumes, above which is a large tough, compressed, often awned, flowering glume, which partly encloses the somewhat similar pale. Within these are six stamens, a hairy ovary surmounted by two feathery styles which ripens into the fruit (grain), and which is invested by the husk formed by the persistent glume and pale. The cultivated varieties are extremely numerous, some kinds being adapted for marshy land, others for growth on the hillsides. The cultivators make two principal divisions according as the sorts are early or late. Rice has been cultivated from time immemorial in tropical countries. According to Stanislas Julien a ceremonial ordinance was established in China by the emperor Chin-nung 2800 years B.C., in accordance with which the emperor sows the rice himself while the seeds of four other kinds may be sown by the princes of his family. This fact, joined to other considerations, induced Alphonse de Candolle to consider rice as a native of China. It was very early cultivated in India, in some parts of which country, as in tropical Australia, it is, as we have seen, indigenous. It is not mentioned in the Bible, but its culture is alluded to in the Talmud. There is proof of its culture in the Euphrates valley and in Syria four hundred years before Christ. Crawford, on philological grounds, considers that rice was introduced into Persia from southern India. The Arabs carried the plant into Spain. Rice was first cultivated in Italy near Pisa in 1468. It was not introduced into S. Carolina until 1700, and then, it is said, by accident, although at one time the southern United States furnished a large proportion of the rice introduced into commerce. Rice sports into far more varieties than any of the corns familiar to Europeans; for some varieties grow in the water and some on dry land; some come to maturity in three months, while others take four and six months to do so. A very full account of the cultivation of rice in India will be found in Sir George Watt's

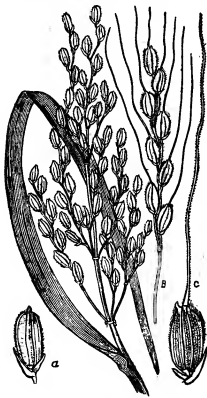

Rice (*Oryza sativa*).

A, spikelet (enlarged); B, bearded variety; C, spikelet of B (enlarged).

the sorts are early or late. Rice has been cultivated from time immemorial in tropical countries. According to Stanislas Julien a ceremonial ordinance was established in China by the emperor Chin-nung 2800 years B.C., in accordance with which the emperor sows the rice himself while the seeds of four other kinds may be sown by the princes of his family. This fact, joined to other considerations, induced Alphonse de Candolle to consider rice as a native of China. It was very early cultivated in India, in some parts of which country, as in tropical Australia, it is, as we have seen, indigenous. It is not mentioned in the Bible, but its culture is alluded to in the Talmud. There is proof of its culture in the Euphrates valley and in Syria four hundred years before Christ. Crawford, on philological grounds, considers that rice was introduced into Persia from southern India. The Arabs carried the plant into Spain. Rice was first cultivated in Italy near Pisa in 1468. It was not introduced into S. Carolina until 1700, and then, it is said, by accident, although at one time the southern United States furnished a large proportion of the rice introduced into commerce. Rice sports into far more varieties than any of the corns familiar to Europeans; for some varieties grow in the water and some on dry land; some come to maturity in three months, while others take four and six months to do so. A very full account of the cultivation of rice in India will be found in Sir George Watt's *Dictionary of the Economic Products of India*.

Rice constitutes one of the most important articles of food in all tropical and subtropical countries, and is one of the most prolific of all crops. The rice yields best on low lands subject to occasional inundations, and thus enriched by alluvial deposits. An abundant

rainfall during the growing season is also a desideratum. Rice is sown broadcast, and in some districts is transplanted after a fortnight or three weeks. No special rotation is followed: indeed the soil best suited for rice is ill adapted for any other crop. In some cases little manure is employed, but in others abundance of manure is used. No special tillage is required, but weeding and irrigation are requisite. Rice in the husk is known as "paddy." On cutting across a grain of rice and examining it under the microscope, first the flattened and dried cells of the husk are seen, and then one or two layers of cells elongated in a direction parallel to the length of the seed, which contain the gluten or nitrogenous matter. Within these, and forming by far the largest part of the seed, are large polygonal cells filled with very numerous and very minute angular starch grains. Rice is not so valuable as a food as some other cereals, inasmuch as the proportion of nitrogenous matter (gluten) is less. Payen gives only 7% of gluten in rice as compared with 22% in the finest wheat, 14 in oats and 12 in maize. The percentage of potash in the ash is as 18 to 23 in wheat. The fatty matter is also less in proportion than in other cereals. Rice, therefore, is chiefly a farinaceous food, and requires to be combined with fatty and nitrogenous substances, such as milk or meat gravy, to satisfy the requirements of the system.

A large proportion of the rice brought to Europe is used for starch-making, and some is taken by distillers of alcohol. Rice is also the source of a drinking spirit in India, known as arrack, and the national beverage of Japan—sake—is prepared from the grain by means of an organic ferment.

RICE PAPER. The substance which has received this name in Europe, through the mistaken notion that it is made from rice, consists of the pith of a small tree, *Aralia papyrifera*, which grows in the swampy forests of Formosa. The cylindrical core of pith is rolled on a hard flat surface against a knife, by which it is cut into thin sheets of a fine ivory-like texture. Dyed in various colours, rice paper is extensively used for the preparation of artificial flowers, while the white sheets are employed by native artists for water-colour drawings.

RICH, BARNABE (c. 1540–1617), English author and soldier, was a distant relative of Lord Chancellor Rich. He fought in the Low Countries, rising to the rank of captain, and afterwards served in Ireland. He shared in the colonization of Ulster, and spent the latter part of his life near Dublin. In the intervals of his campaigns he produced many pamphlets on political questions and romances. In 1606 he was in receipt of a pension of half a crown a day, and in 1616 he was presented with a gift of £100 as being the oldest captain in the service. He died on the 10th of November 1617. His best-known work is *Riche his Farewell to Militarie Profession containing verie pleasant discourses fit for a peaceable tyme* (1581). Of the eight stories contained in it, five, he says, "are forged only for delight, neither credible to be believed, nor hurtful to be perused." The three others are translations from the Italian. He claims as his own invention the story of *Apolonius and Silla*, the second in the collection, from which Shakespeare took the plot of *Twelfth Night*. It is, however, founded on the tale of Nicola and Lattantio as told by Matteo Bandello. The eighth, *Phylotus and Emilia*, a complicated story arising from the likeness and disguise of a brother and sister, is identical in plot with the anonymous play, *Philotus*, printed in Edinburgh in 1603. Both play and story were edited for the Bannatyne Club in 1835. In the conclusion to his collection Rich tells a story of a devil named Balthaser, who possesses a king of Scots, prudently changed after the accession of James I. to the "Grand Turk." *The Strange and Wonderful Adventures of Don Simonides* (1581), with its sequel (1584), is written in imitation of Lyly. Among his other romances should be mentioned *The Adventures of Brusanus, prince of Hungaria* (1592). His authenticated works number twenty-four, and include works on Ireland, the troubles of which were, according to him, due to the religion of the people and to the lack of consistency and firmness on the part of the English government. Such are: *Alarme to England* (1578); *A New Description of Ireland* (1610); *The Irish Hubbub, or the English Hue and Cry* (1617), in which he also inveighs against the use of tobacco.

See "Introduction" to the Shakespeare Society's reprint of *Riche his Farewell* (1846); P. Cunningham's "Introduction" to *Rich's Honesty of this Age* (reprinted for the Percy Society, 1844); and the life by S. Lee in the *Dictionary of National Biography*.

RICH, CLAUDIUS JAMES (1787–1821), English traveller and scholar, was born near Dijon on the 28th of March 1787. His youth was spent at Bristol. He early developed a gift for languages, becoming familiar not only with Latin and Greek but also with Hebrew, Syriac, Persian, Turkish and other Eastern tongues. In 1804 Rich went to Constantinople, where, and at Smyrna, he stayed some time, perfecting himself in Turkish. Proceeding to Alexandria as assistant to the British consul-general there, he devoted himself to Arabic and its various dialects, and made himself master of Eastern manners and usages. On leaving Egypt he travelled by land to the Persian Gulf, disguised as a Mameluke, visiting Damascus, and entering the great mosque undetected. At Bombay, which he reached in September 1807, he was the guest of Sir James Mackintosh, whose eldest daughter he married in January 1808, proceeding soon after to Bagdad as resident. There he began his investigations into the geography, history and antiquities of the district. He explored the remains of Babylon, and projected a geographical and statistical account of the pashalik of Bagdad. The results of his work at Babylon appeared first in the Vienna serial *Mines de l'orient*, and in 1815 in England, under the title *Narrative of a Journey to the Site of Babylon in 1811*. In 1813–14 Rich spent some time in Europe, and on his return to Bagdad devoted himself to the study of the geography of Asia Minor, and collected much information in Syrian and Chaldaean convents concerning the Yezidis. During this period he made a second excursion to Bahyoun, and in 1820 undertook an extensive tour to Kurdistan—from Bagdad north to Sulimania, eastward to Sinna, then west to Nineveh, and thence down the Tigris to Bagdad. The narrative of this journey, which contained the first accurate knowledge (from scientific observation) regarding the topography and geography of the region, was published by his widow under the title, *Narrative of a Residence in Koordistan and on the site of Ancient Nineveh*, &c. (London, 1836). In 1821 Rich went to Basora, whence he made an excursion to Shiraz, visiting the ruins of Persepolis and the other remains in the neighbourhood. At Shiraz he died of cholera on the 5th of October 1821. His fine collections of manuscripts and coins was purchased by the British Museum.

RICH, JOHN (1692–1761), English actor, the “father of English pantomime,” was the son of Christopher Rich (d. 1714), the manager of Drury Lane, with whose quarrels and tyrannies Colley Cibber's *Apology* is much occupied. John Rich opened the new theatre in Lincoln's Inn Fields left unfinished by his father, and here, in 1716, under the stage name of Lun, he first appeared as Harlequin in an unnamed entertainment which developed into an annual pantomime (q.v.). By this departure he made successful headway in his competition with the stronger company at Drury Lane, including Cibber, Wilks and Booth. Rich was less happy in his management of Covent Garden, which he opened in 1733, until Garrick's arrival (1746), when a most prosperous season ensued, followed by a bad one when Garrick went to Drury Lane. During Rich's management occurred the rival performances of *Romeo and Juliet*—Barry and Mrs Cibber at Covent Garden, and Garrick and Miss Bellamy at Drury Lane—and the subsequent competition between the two rival actors in *King Lear*. Rich died on the 26th of November 1761. Garrick's lines show that his acting was pantomime pure and simple, without words:—

“When Lun appeared, with matchless art and whim,
He gazed the power of speech to every limb;

The' masked and mute, conveyed his quick intent,
And told in irolc gesture what he meant.”

RICH, PENELOPE, LADY (c. 1562–1607), the Stella of Sir Philip Sidney's *Astrophel and Stella*, was the daughter of Walter Devereux, 1st Earl of Essex. She was a child of fourteen when Sir Philip Sidney accompanied the queen on a visit to Lady Essex in 1576, on her way from Kenilworth, and must have been frequently thrown into the society of Sidney, in consequence of the many ties between the two families. Essex died at Dublin in September 1576. He had sent a message to Philip

Sidney from his death-bed expressing his desire that he should marry his daughter, and later his secretary wrote to the young man's father, Sir Henry Sidney, in words which seem to point to the existence of a very definite understanding. Penelope's great-grandmother was a sister of Anne Boleyn, and she and her brother Robert were therefore distantly connected with Elizabeth. Perhaps the marriage of Lady Essex with the earl of Leicester, which destroyed Sidney's prospects as his uncle's heir, had something to do with the breaking off of the proposed match with Penelope. Her relative and guardian, Henry Hastings, earl of Huntingdon, secured Burghley's assent in March 1581 for her marriage with Robert Rich, 3rd Baron Rich. Penelope is said to have protested in vain against the alliance with Rich, who is represented as a rough and overbearing husband. The evidence against him is, however, chiefly derived from sources as interested as Sir Philip Sidney's violent denunciation in the twenty-fourth sonnet of *Astrophel and Stella*, “Rich fooles there be whose base and filthy hart.” Sidney's serious love for Penelope appears to date from her marriage with Rich. The earlier sonnets are in praise of her beauty, or treat of the conventional topic of the struggle between reason and love, while the later ones are marked by unmistakable passion. The eighth song of *Astrophel and Stella* narrates Stella's refusal to accept Sidney as a lover. Lady Rich was the mother of six children by her husband when she contracted in 1595 an open liaison with Charles Blount, 8th Lord Mountjoy, a brilliant courtier and favourite of Elizabeth, to whom she had long been attached. Rich took no steps against his wife during her brother's lifetime, and she nursed him through an illness in 1600, but they obtained a legal separation in 1601, and Mountjoy acknowledged her five children born after 1595. Mountjoy was created earl of Devonshire on the accession of James I., and Lady Rich was in high favour at court. In 1605, however, they legitimized their connexion by a marriage celebrated by William Laud, the earl's chaplain. This proceeding, carried out in defiance of canon law, was followed by the disgrace of both parties, who were banished from court. Devonshire died on the 3rd of April 1606, and his wife within a year of that date. Her eldest son by Lord Rich, who became earl of Warwick in 1618, was Robert Rich, 2nd earl of Warwick (1587–1658). The second, Henry Rich, earl of Holland, was beheaded in 1649 for his share in the second Civil War. Her eldest son by Mountjoy, Mountjoy Blount, Baron Mountjoy and earl of Newport (c. 1597–1665) also figured in the Civil War.

See the editions of *Astrophel and Stella* by Dr A. B. Grosart, E. Arber and A. W. Pollard; also the various lives of Sir Philip Sidney, and Mrs Aubrey Richardson's *Famous Ladies of the English Court* (London, 1899). John Ford's *Broken Heart* has been alleged to have been founded on the history of Lady Rich. Richard Barnfield dedicated his *Affectionate Shepherd* (1594) to her; Bartholomew Yonge his *Diana of George of Montemayor* (1598); and sonnets are addressed to her by John Davies of Hereford and by Henry Constable.

RICH, RICHARD (fl. 1610), English soldier and adventurer, the author of *News from Virginia*, sailed from England on the 2nd of June 1609 for Virginia, with Captain Christopher Newport and the three commissioners entrusted with the foundation of the new colony. In his verse pamphlet he relates the adventures undergone by the expedition, and describes the resources of the new country, with the advantages offered to colonists. The title runs: *News from Virginia. The lost Flocke Triumphant. With the happy Arrivall of that famous and worthy Knight Sr. Thomas Gates: and the well-reputed and valiant Captaine Mr. Christopher Newport, and others, into England. With the manner of their distresse in the Iland of Devils (otherwise called Bermouthawes), where they remained 42 weeks, and builded two Pynaces, in which they returned into Virginia.* By R. Rich, Gent., one of the Voyage (1610). The only known copy of this tract is in the Huth Library. A reprint edited by J. O. Halliwell-Phillips appeared in 1865 (another ed., 1874). The adventures related by Rich are supposed to have been in Shakespeare's mind when he wrote *The Tempest*. Another tract by Rich mentioned in the Stationers' Register, *Good Speed to Virginia*, is unknown.

RICH, RICHARD, 1ST BARON RICH (1490?–1567), lord chancellor, was born of a Hampshire family about 1490, in the parish of St Laurence Jewry, London. His great-grandfather, Richard Rich, was a wealthy mercer and sheriff of the city of London in 1441. Probably Lord Rich's father was also a mercer, but he sent his son to the Middle Temple, where Sir Thomas More was among his acquaintances. More told him at the time of his trial that he was reputed light of his tongue, a great dicier and gamester, and not of any commendable fame; but he was a commissioner of the peace in Hertfordshire in 1528, and in the next autumn became reader at the Middle Temple. Other preferments followed, and in 1533 he was knighted and became solicitor-general, in which capacity he was to act under Thomas Cromwell as a "lesser hammer" for the demolition of the monasteries, and to secure the operation of Henry VIII's act of supremacy. He had an odious share in the trials of Sir Thomas More and Bishop Fisher. In both cases he made use in his evidence against the prisoner of admissions made in a professedly friendly conversation, and in More's case the words he had used were misreported and received a misconstruction that could hardly be other than wilful. More expressed his opinion of the witness in open court with a candour that might well have dismayed Rich. Rich became the first chancellor (April 19, 1536) of the Court of Augmentations established for the disposal of the monastic revenues. His own share of the spoil, acquired either by grant or purchase, included Leez (Leighs) Priory and about a hundred manors in Essex. He was Speaker of the House of Commons in the same year, and advocated the king's policy. In spite of the share he had taken in the suppression of the monasteries, and of the part he was to play under Edward VI., his religious convictions remained Roman Catholic. His testimony helped the conviction of Thomas Cromwell, and he was a willing agent in the Catholic reaction which followed. Anne Askew stated that the Chancellor Wriothesley and Rich screwed the rack at her torture with their own hands.

Rich was one of the executors of the will of Henry VIII., on which so much suspicion has been thrown, and on the 26th of February 1548 he became Baron Rich of Leez. In the next month he succeeded Wriothesley as chancellor, an office in which he found full scope for the business and legal ability he undoubtedly possessed. He supported Protector Somerset in his subversive reforms in church matters, in the prosecution of his brother Lord Seymour of Sudley, and in the rest of his policy until the crisis of his fortunes in October 1549, when he deserted to Warwick (afterwards Northumberland), and presided over the trial of his former chief. His daughter had married Warwick's son, and both men were at heart no friends to the reformed religion. Nevertheless, Rich took part in the prosecution of bishops Gardiner and Bonner, and in the harsh treatment accorded to the Princess Mary. Possibly this harshness was exaggerated, for Mary on her accession showed no ill-will to Rich. He retired from the chancellorship on the ground of ill-health in the close of 1551, at the time of the final breach between Northumberland and Somerset. He was now sixty years old, and there is no reason to suspect the sincerity of his plea. There is an improbable story, however, to the effect that Rich warned Somerset of his danger in the Tower, and that the letter was delivered by mistake to the duke of Norfolk, who handed it to Northumberland.

Lord Rich took an active part in the restoration of the old religion in Essex under the new reign, and was one of the most active of persecutors. His reappearances in the privy council were rare during Mary's reign; but under Elizabeth he served on a commission to inquire into the grants of land made under Mary, and in 1566 was sent for to advise on the question of the queen's marriage. He died at Rochford, Essex, on the 12th of June 1567, and was buried in Felsted church. In Mary's reign he had founded a chaplaincy with provision for the singing of masses and dirges, and the ringing of bells in Felsted church. To this was added a Lenten allowance of herrings to the inhabitants of three parishes. These donations were transferred

in 1564 to the foundation of a grammar-school at Felsted for instruction, primarily for children born on the founder's manors, in Latin, Greek and divinity. The patronage of the school remained in the family of the founder until 1851. By his wife Elizabeth Jenks, or Gyngkes, he had fifteen children. The eldest son Robert (1537?–1581), second Baron Rich, supported the Reformation, and his grandson Robert, third lord, was created earl of Warwick in 1618.

The chief authorities are the official records of the period covered by his official life, calendared in the Rolls Series. See also A. F. Pollard, *England under Protector Somerset* (1900); P. Moran, *History of Essex* (2 vols., 1768); R. W. Dixon, *History of the Church of England* (6 vols., 1878–1902); and lives in J. Sargeant's *History of Felsted School* (1889), Lord Campbell's *Lives of the Lord Chancellors* (1845–69), and C. H. & T. Cooper's *Athenae Cantabrigienses* (2 vols., 1858–61).

RICHARD, ST. of Wyche (c. 1197–1253), English saint and bishop, was named after his birthplace, Droitwich in Worcestershire. Educated at Oxford, he soon began to teach in the university, of which he became chancellor, probably after he had studied in Paris and in Bologna. About 1235 he became chancellor of the diocese of Canterbury under Archbishop Edmund Rich, and he was with the archbishop during his exile in France. Having returned to England some time after Edmund's death in 1240 he became vicar of Deal and chancellor of Canterbury for the second time. In 1244 he was elected bishop of Chichester, being consecrated at Lyons by Pope Innocent IV. in March 1245, although Henry III. refused to give him the temporalities of the see, the king favouring the candidature of Robert Passelewe (d. 1252). In 1246, however, Richard obtained the temporalities. The new bishop showed much eagerness to reform the manners and morals of his clergy, and also to introduce greater order and reverence into the services of the church. His term of office was also marked by the favour which he showed to the Dominicans, a house of this order at Orleans having sheltered him during his stay in France, and by his earnestness in preaching a crusade. He died at Dover in April 1253. It was generally believed that miracles were wrought at his tomb in Chichester cathedral, which was long a popular place of pilgrimage, and in 1262 he was canonized at Viterbo by Pope Urban IV. Richard furnished the chronicler, Matthew Paris, with material for the life of Edmund Rich, and instituted the offerings for the cathedral at Chichester which were known later as "St Richard's pence."

His life by his confessor, Ralph Bocking, is published in the *Acta Sanctorum* of the Bollandists, where a later and shorter life by John Capgrave is also to be found.

RICHARD (d. 1184), archbishop of Canterbury, was a Norman, who became a monk at Canterbury, where he acted as chaplain to Archbishop Theobald and was a colleague of Thomas Becket. In 1173, more than two years after the murder of Becket, it was decided to fill the vacant archbishopric of Canterbury; there were two candidates, Richard, at that time prior of St Martin's, Dover, and Odo, prior of Canterbury, and in June Richard was chosen, although Odo was the nominee of the monks. Objections were raised against this election both in England and in Rome, but in April 1174 the new archbishop was consecrated at Anagni by Pope Alexander III., and he returned to England towards the close of the year. The ten years during which Richard was archbishop were disturbed by disputes with Roger, archbishop of York, over the respective rights of the two sees, and in 1175, at a council held in London, there was a free fight between their partisans. Henry II. arranged a truce for five years between the rival prelates, but Richard was soon involved in another quarrel, this being with Roger, abbot of St Augustine's, Canterbury, whose action also trenchd upon the privileges of the archbishop. Richard was more acceptable to Henry II. than Becket had been; he attended the royal councils, and more than once he was with the king in Normandy. Henry probably preferred him because he insisted less on the rights of the clergy than his great predecessor had done; but the monastic writers and the followers of Becket regarded this attitude as a sign of weakness. Richard died at Rochester on the 16th of February 1184 and was

buried in his cathedral. See the article by W. Hunt in the *Dict. Nat. Biog.* vol. xlviii. (1896); and W. F. Hook, *Lives of the Archbishops of Canterbury*.

RICHARD, earl of Cornwall and king of the Romans (1209–1272), was the second son of the English king John by Isabella of Angoulême. Born in 1209, Richard was the junior of his brother, Henry III., by fifteen months; he was educated in England and received the earldom of Cornwall in 1225. From this date to his death he was a prominent figure on the political stage. In the years 1225–27 he acted as governor of Gascony; between 1227 and 1238, owing to quarrels with his brother and dislike of the foreign favourites, he attached himself to the baronial opposition and bade fair to become a popular hero. But in 1240 he took the command of a crusade in order to escape from the troubled atmosphere of English politics. He was formally reconciled with Henry before his departure; and their amity was cemented on his return by his marriage with Sancha of Provence, the sister of Henry's queen (1243). Henceforward Richard, though by no means blind to the faults of the government, was among the most constant supporters of Henry III. While affecting to remain neutral in the quarrels of the barons with the Poitevins and Savoyards he constantly assisted the king with loans, and thus enabled him to withstand the pressure of the Great Council for reform. In 1257 a bare majority of the German electors nominated Richard as king of the Romans, and he accepted their offer at Henry's desire. He was elected partly on account of his wealth, but also because his family connexion with the Hohenstaufen and his friendly relations with the papacy made it probable that he would unite all German parties. In the years 1257–68 Richard paid four visits to Germany. He obtained recognition in the Rhineland, which was closely connected with England by trade relations. Otherwise, however, he was unsuccessful in securing German support. In the English troubles of the same period he endeavoured to act as a mediator. On the outbreak of civil war in 1264 he took his brother's side, and his capture in a windmill outside Lewes, after the defeat of the royalist army, is commemorated in the earliest of English vernacular satires; he remained a prisoner till the fall of Montfort. But after Evesham he exerted himself, not without success, to obtain reasonable terms for those who had suffered from the vengeance of the royalist party. He died on the 2nd of April 1272. His end is said to have been hastened by grief for his eldest son, Henry of Almain, who had been murdered in the previous year by the sons of Simon de Montfort at Viterbo. The earldom of Cornwall passed to Richard's eldest surviving son Edmund, who was guardian of England from 1286 to 1289. On Edmund's death, in October 1300, it became extinct.

Authorities.—The original sources and general works of reference are the same as for the reign of Henry III.: G. C. Gebauer's *Leben und Thaten Herrn Richards von Cornwall* (Leipzig, 1744); H. Koch's *Richard von Cornwall, 1209–1257* (Strassburg, 1888); and A. Busson's *Doppelwahl des Jahres, 1257* (Münster, 1866) are useful monographs. (H. W. C. D.)

RICHARD I. (1157–1199), king of England, nicknamed "Cœur de Lion" and "Yea and Nay," was the third son of Henry II. by Eleanor of Aquitaine. Born in September 1157, he received at the age of eleven the duchy of Aquitaine, and was formally installed in 1172. In his new position he was allowed, probably from regard to Aquitanian susceptibilities, to govern with an independence which was studiously denied to his brothers in their shares of the Angevin inheritance. Yet in 1173 Richard joined with the young Henry and Geoffrey of Brittany in their rebellion; Aquitaine was twice invaded by the old king before the unruly youth would make submission. Richard was soon pardoned and reinstated in his duchy, where he distinguished himself by crushing a formidable revolt (1175) and exacting homage from the count of Toulouse. In a short time he was so powerful that his elder brother Henry became alarmed and demanded, as heir-apparent, that Richard should do him homage for Aquitaine. Richard having scornfully rejected the demand, a fratricidal war ensued; the young Henry invaded Aquitaine and attracted to his standard many

of Richard's vassals, who were exasperated by the iron rule of the duke. Henry II. marched to Richard's aid; but the war terminated abruptly with the death of the elder prince (1183).

Richard, being now the heir to England and Normandy, was invited to renounce Aquitaine in favour of Prince John. The proposal led to a new civil war; and, although a temporary compromise was arranged, Richard soon sought the help of Philip Augustus, to whom he did homage for all the continental possessions in the actual presence of his father (Conference of Bonmoullins, 18th of November 1188). In the struggle which ensued the old king was overpowered, chased ignominiously from Le Mans to Angers, and forced to buy peace by conceding all that was demanded of him; in particular the immediate recognition of Richard as his successor.

But the death of Henry II. (1189) at once dissolved the friendship between Richard and Philip. Not only did Richard continue the continental policy of his father, but he also refused to fulfil his contract with Philip's sister, Alais, to whom he had been betrothed at the age of three. An open breach was only delayed by the desire of both kings to fulfil the crusading vows which they had recently taken. Richard, in particular, sacrificed all other interests to this scheme, and raised the necessary funds by the most reckless methods. He put up for auction the highest offices and honours; even remitting to William the Lion of Scotland, for a sum of 15,000 marks, the humiliating obligations which Henry II. had imposed at the treaty of Falaise. It is true that Richard indemnified himself on his return by resuming some of his most important grants and refusing to return the purchase money; but it is improbable that he had originally planned this repudiation of his ill-considered bargains. By such expedients he raised and equipped a force which may be estimated at 4000 men-at-arms and as many foot-soldiers, with a fleet of 100 transports (1191).

Richard did not return to his dominions until 1194. But his stay in Palestine was limited to sixteen months. On the outward journey he wintered in Sicily, where he employed himself in quarrelling with Philip and in exacting satisfaction from the usurper Tancred for the dower of his widowed sister, Queen Joanna, and for his own share in the inheritance of William the Good. Leaving Messina in March 1191, he interrupted his voyage to conquer Cyprus, and only joined the Christian besiegers of Acre in June. The reduction of that stronghold was largely due to his energy and skill. But his arrogance gave much offence. After the fall of Acre he inflicted a gross insult upon Leopold of Austria; and his relations with Philip were so strained that the latter seized the first pretext for returning to France, and entered into negotiations with Prince John (see JOHN, king of England) for the partition of Richard's realm. Richard also threw himself into the disputes respecting the crown of Jerusalem, and supported Guy of Lusignan against Conrad of Montferrat with so much heat that he incurred grave, though unfounded, suspicions of complicity when Conrad was assassinated by emissaries of the Old Man of the Mountain. None the less Richard, whom even the French crusaders accepted as their leader, upheld the failing cause of the Frankish Christians with valour and tenacity. He won a brilliant victory over the forces of Saladin at Arsuf (1191), and twice led the Christian host within a few miles of Jerusalem. But the dissensions of the native Franks and the crusaders made it hopeless to continue the struggle; and Richard was alarmed by the news which reached him of John's intrigues in England and Normandy. Hastily patching up a truce with Saladin, under which the Christians kept the coast-towns and received free access to the Holy Sepulchre, Richard started on his return (9th October 1192).

His voyage was delayed by storms, and he appears to have been perplexed as to the safest route. The natural route overland through Marseilles and Toulouse was held by his enemies; that through the empire from the head of the Adriatic was little safer, since Leopold of Austria was on the watch for him. Having adopted the second of these alternatives, he was cap-

tured at Vienna in a mean disguise (December 20th, 1192) and strictly confined in the duke's castle of Dürenstein on the Danube. His mishap was soon known to England, but the regents were for some weeks uncertain of his whereabouts. This is the foundation for the tale of his discovery by the faithful minstrel Blondel, which first occurs in a French romantic chronicle of the next century. Early in 1193 Leopold surrendered his prize, under compulsion, to the emperor Henry VI., who was aggrieved both by the support which the Plantagenets had given to the family of Henry the Lion and also by Richard's recognition of Tancred in Sicily. Although the detention of a crusader was contrary to public law, Richard was compelled to purchase his release by the payment of a heavy ransom and by doing homage to the emperor for England. The ransom demanded was 150,000 marks; though it was never discharged in full, the resources of England were taxed to the utmost for the first instalments; and to this occasion we may trace the beginning of secular taxation levied on movable property.

Richard reappeared in England in March 1194; but his stay lasted only a few weeks, and the remainder of his reign was entirely devoted to his continental interests. He left England to be governed by Hubert Walter (q.v.), and his personal authority was seldom asserted except by demands for new subsidies. The rule of the Plantagenets was still popular in Normandy and Aquitaine; but these provinces were unable or unwilling to pay for their own defence. Though Richard proved himself consistently the superior of Philip in the field, the difficulty of raising and paying forces to resist the French increased year by year. Richard could only stand on the defensive; the keystone of his later policy is given by the building of the famous Château Gaillard at Les Andelys (1196) to protect the lower courses of the Seine against invasion from the side of France. He did not live to see the futility of such bulwarks. In 1199 a claim to treasure-trove embroiled him with the viscount of Limoges. He harried the Limousin and laid siege to the castle of Châlus; while directing an assault he was wounded in the shoulder by a crossbow bolt, and, the wound mortifying from unskilful treatment or his own want of care, he died on the 6th of April 1199. He was buried by his own desire at his father's feet in the church of Fontevault. Here his effigy may still be seen.¹ Though contemporary, it does not altogether agree with the portraits on his Great Seal, which give the impression of greater strength and even of cruelty. The Fontevault bust is no doubt idealized.

The most accomplished and versatile representative of his gifted family, Richard was, in his lifetime and long afterwards, a favourite hero with troubadours and romancers. This was natural, as he belonged to their brotherhood and himself wrote lyrics of no mean quality. But his history shows that he by no means embodied the current ideal of chivalrous excellence. His memory is stained by one act of needless cruelty, the massacre of over two thousand Saracen prisoners at Acre; and his fury, when thwarted or humbled, was ungovernable. A brave soldier, an experienced and astute general, he was never happier than when engaged in war. As a ruler he was equally profuse and rapacious. Not one useful measure can be placed to his credit; and it was by a fortunate accident that he found, in Hubert Walter, an administrator who had the skill to mitigate the consequences of a reckless fiscal policy. Richard's wife was Berengaria, daughter of Sancho VI., king of Navarre, whom he married in Cyprus in May 1197. She was with the king at Acre later in the same year, and during his imprisonment passed her time in Sicily, in Rome and in France. Husband and wife met again in 1195, and the queen long survived the king, residing chiefly at Le Mans. She died

soon after 1230. Berengaria founded a Cistercian monastery at Espau.

AUTHORITIES.—The more important of the general chronicles are: the *Gesta Henrici Secundi*, ascribed to Benedict of Peterborough (Rolls Series, 2 vols., 1867); the *Chronica* of Roger of Hoveden (Rolls Series, 4 vols., 1868-71); the *Chronica* of Gervase of Canterbury (Rolls Series, 1870); the *Imagines Historiarum* of Ralph of Diceto (Rolls Series, 2 vols., 1876); the *Historia Rerum Anglicarum* of William of Newburgh (in *Chronicles of the Reigns of Stephen, &c.*, Rolls Series, 2 vols., 1884-85); the *De rebus gestis Ricardi Primi*, of Richard of Devizes (in *Chronicles of the Reigns of Stephen, &c.*, vol. iii., Rolls Series, 1886); the *Chronicon Anglicanum* of Ralph of Coggeshall (Rolls Series, 1875); the *Flores Historiarum* of Roger of Wendover (Rolls Series, 3 vols., 1886-89); the *Gesta Philippi Augusti* of Breton (*Société de l'histoire de France*, Paris, 1882) and of Guillaume le Breton (*op. cit.*); a detailed narrative of Richard's crusade is given in *L'Estoire de la guerre sainte*, a rhyming French chronicle by the minstrel Ambroise (ed. Gaston Paris, Paris, 1897), and in the Latin prose version known as the *Itinerarium O. Peregrinorum et gesta Regis Ricardi*; this last, with some valuable historical letters, is printed in W. Stubbs's *Chronicles and Memorials of the Reign of Richard I.* (Rolls Series, 2 vols., 1864-65). Of modern works the following are useful: W. Stubbs's preface to vols. iii. and iv. of Hoveden; the same author's *Constitutional History of England*, vol. 1. (Oxford, 1897); Miss K. Norgate's *England under the Angevin Kings*, vol. ii. (London, 1887); Sir H. Ramsay's *Angevin England* (London, 1903); R. Röhricht's *Geschichte des Königreichs Jerusalem* (1898); W. B. Stevenson's *Crusaders in the East* (Cambridge, 1907); A. Cartellieri's *Philipp II. August* (Leipzig, 1899, &c.).

(H. W. C. D.)

RICHARD II. (1367-1400), king of England, younger son of Edward the Black Prince by Joan "the Fair Maid of Kent," was born at Bordeaux on the 6th of January 1367. He was brought to England in 1371, and after his father's death was, on the petition of the Commons in parliament, created prince of Wales on the 20th of November 1376. When Edward III. died, on the 21st of June 1377, Richard became king. Popular opinion had credited John of Gaunt with designs on the throne. This was not justified; nevertheless, the rivalry of the boy-king's uncles added another to the troubles due to the war, the Black Death and the prospect of a long minority. At first the government was conducted by a council appointed by parliament. The council was honest, but the difficulties of the situation were too great. The ill-considered poll-tax of 1381 was the occasion, though not the real cause, of the Peasants' Revolt in that year. The ministers were quite unequal to the crisis, and when Wat Tyler and his followers got possession of London, it was Richard who showed a precocious tact and confidence in handling it. It was the boy-king who met and temporized with the rebels on the 13th of June at Mile End, and again next day at Smithfield; and he who, with courageous presence of mind, saved the situation when Tyler was killed, by calling on them to take him for their leader. From this time Richard began to assert himself. His chief ministers, appointed by parliament in 1382, were the earl of Arundel and Michael de la Pole. Arundel Richard disliked, and dismissed next year, when he began his personal government. Pole, whom he retained as chancellor and made earl of Suffolk, was a well-chosen adviser. But others, and especially his youthful favourite Robert de Vere, promoted by unheard-of honour to be marquis of Dublin and duke of Ireland, were less worthy. Further, Richard made his own position difficult by lavish extravagance and unseemly outbursts of temper. He chafed under the restraint of his relatives, and therefore encouraged John of Gaunt in his Spanish enterprise. This gave the less scrupulous Thomas of Gloucester his opportunity. Gloucester, supported by Arundel, attacked his nephew's ministers in the parliament of 1386, and by open hints at deposition forced Richard to submit to a council of control. When Richard, with the aid of his friends and by the advice of subservient judges, planned a reversal of the parliament, Gloucester, at the head of the so-called lords appellant, anticipated him. Richard had been premature and ill-advised. Gloucester had the advantage of posing as the head of the constitutional party. The king's friends were driven into exile or executed, and he himself forced to submit to the loss of all real power (May 1388). Richard changed his

¹ The remains of Richard, together with those of Henry II. and his queen Eleanor, were removed in the 17th century from their tombs to another part of the church. They were rediscovered in 1910 during the restoration of the abbey undertaken by the French government.

methods, and when the lords appellant had lost credit, asserted himself constitutionally by dismissing Gloucester's supporters from office, and appointing in their place well-approved men like William of Wykeham. In the next parliament of 1390 the king showed himself ready to meet and conciliate his subjects. The simultaneous return of John of Gaunt from Spain put a check on Gloucester's ambition. For seven years Richard ruled constitutionally and on the whole well. The opposition was quiescent except for two outbreaks by Arundel: the first was a violent attack on John of Gaunt, which rather strengthened Richard's position; the second was a wanton insult to the king at the funeral of his queen.

In January 1383 Richard had married Anne of Bohemia (1366-1394), daughter of the emperor Charles IV. The marriage, though childless, was happy; had Anne lived or borne a son the course of events might have been different. Her death on the 7th of June 1394 was a great shock to Richard, and incidentally had important consequences. Richard sought distraction by an expedition to Ireland, the first visit of an English king for more than two centuries. In his policy there he showed a wise statesmanship. At the same time he was negotiating for a permanent peace with France, which was finally arranged in October 1396 to include his own marriage with Isabella, daughter of Charles VI., a child of seven. Gloucester criticized the peace openly, and there was some show of opposition in the parliament of February 1397. But there was nothing to foreshadow the sudden stroke by which in July Richard arrested Gloucester and his chief supporters, the earls of Arundel and Warwick. The others of the five lords appellant, Henry of Bolingbroke afterwards King Henry IV., and the earl of Nottingham, now supported the king. Richard's action was apparently in deliberate revenge for the events of 1387-88. Gloucester, after a forced confession, died in prison at Calais, smothered by his nephew's orders. Arundel in a packed parliament was condemned and executed; his brother Thomas archbishop of Canterbury was exiled. The king's friends, including Nottingham and Bolingbroke, made dukes of Norfolk and Hereford, were all promoted in title and estate. Richard himself was rewarded for ten years' patience by the possession of absolute power. He might perhaps have established it if he could have exercised it with moderation. But he declared that the laws of England were in his mouth, and supported his court in wanton luxury by arbitrary methods of taxation. By the exile of Norfolk and Hereford in September 1398 he seemed to have removed the last persons he need fear. He was so confident that in May 1399 he paid a second visit to Ireland, taking with him all his most trusted adherents. Thus when Henry landed at Ravenspur in July he found only half-hearted opposition, and when Richard himself returned it was too late. Ultimately Richard surrendered to Henry at Flint on the 19th of August, promising to abdicate if his life was spared. He was taken to London riding behind his rival with indignity. On the 30th of September he signed in the Tower a deed of abdication, wherein he owned himself insufficient and useless, reading it first aloud with a cheerful mien and ending with a request that his cousin would be good lord to him. The parliament ordered that Richard should be kept close prisoner, and he was sent secretly to Pontefract. There in February 1400 he died: no doubt of the rigour of his winter imprisonment, rather than by actual murder as alleged in the story adopted by Shakespeare. The mystery of Richard's death led to rumours that he had escaped, and an impostor pretending to be Richard lived during many years under the protection of the Scottish government. But no doubt it was the real Richard who was buried without state in 1400 at King's Langley, and honourably reinterred by Henry V. at Westminster in 1413.

Richard II. is a character of strange contradictions. It is difficult to reconcile the precocious boy of 1381 with the wayward and passionate youth of the next few years. Even if it be supposed that he dissembled his real opinions during the period of his constitutional rule, it is impossible to believe that

the apparent indifference which he showed in his fall was the mere acting of a part. His violent outbursts of passion perhaps give the best clue to a mercurial and impulsive nature, easily elated and depressed. He had real ability, and in his Irish policy, and in the preference which he gave to it over continental adventure, showed a statesmanship in advance of his time. But this, in spite of his lofty theory of kingship, makes it all the more difficult to explain his extravagant bearing in his prosperity. His fall was due to the triumph of national right over absolute government, but it was his personal conduct which made it inevitable. In appearance Richard was tall and handsome, effeminate. He had some literary tastes, which were shown in fitful patronage of Chaucer, Gower and Froissart. His fancy for splendid dress may have been due to an artistic sense, which found better expression in his great buildings of Westminster Hall and Abbey. Richard's second queen, Isabella (1389-1409), was born in Paris on the 9th of November 1389, and was married to the English king at Calais in October, or November, 1396, but on account of the bride's youth the marriage was never consummated. When Richard lost his crown in 1399 Isabella was captured by Henry IV.'s partisans and sent to Sonning, near Reading, while her father, Charles VI., asked in vain for the restoration of his daughter and of her dowry. In 1401 she was allowed to return to France; in 1406 she became the wife of the poet, Charles, duke of Orleans, and she died on the 13th of September 1409.

BIBLIOGRAPHY.—The best contemporary authorities are the *Chronicon Anglie* down to 1388, Walsingham's *Historia Anglicana*, the *Annales Ricardi II.*, Knighton's *Chronicle* (all these in the Rolls Series), the *Vita Ricardi II.* by a Monk of Evesham (ed. T. Hearne), and the *Chronique de la traison et mort* (English Hist. Soc.), and Froissart wrote from some personal knowledge. A metrical account of Richard's fall, probably written by a French knight called Creton, is printed in *Archaeologia*, xx. The chief collections of documents are the *Rolls of Parliament* and the *Calendar of Patent Rolls*. H. A. Wallon's *Richard II.* (Paris, 1864) is the fullest life, though now somewhat out of date. For other modern accounts see W. Stubbs, *Constitutional History*, and C. W. C. Oman, *The Political History of England*, vol. iv., and *The Great Revolt of 1381*. (C. L. K.)

RICHARD III. (1452-1485), king of England, youngest son of Richard, duke of York, by Cicely Neville, was born at Fotheringhay on the 2nd of October 1452. After the second battle of St Albans in February 1461, his mother sent him with his brother George for safety to Utrecht. They returned in April, and at the coronation of Edward IV. Richard was created duke of Gloucester. As a mere child he had no importance till 1469-1470, when he supported his brother against Warwick, shared his exile and took part in his triumphant return. He distinguished himself at Barnet and Tewkesbury; according to the Lancastrian story, after the latter battle he murdered the young Edward of Wales in cold blood; this is discredited by the authority of Warkworth (*Chronicle*, p. 18); but Richard may have had a share in Edward's death during the fighting. He cannot be so fully cleared of complicity in the murder of Henry VI., which probably took place at the Tower on the night of the 21-22 of May, when Richard was certainly present there. Richard shared to the full in his brother's prosperity. He had large grants of lands and office, and by marrying Anne (1456-1485), the younger daughter of Warwick, secured a share in the Neville inheritance. This was distasteful to George, duke of Clarence, who was already married to the elder sister, Isabel. The rivalry of the two brothers caused a quarrel which was never appeased. Richard does not, however, seem to have been directly responsible for the death of Clarence in 1478; Sir Thomas More, who is a hostile witness, says that he resisted it openly "howbeit somewhat (as men deemed) more faintly than he that were heartily minded to his health." Richard's share of the Neville inheritance was chiefly in the north, and he resided usually at Middleham in Yorkshire. In May 1480 he was made the king's lieutenant-general in the north, and in 1482 commanded a successful invasion of Scotland. His administration was good, and brought him well-deserved popularity. On Edward's death he was kept informed of events in London by William, Lord Hastings, who shared his dislike of the Woodville influence.

On the 29th of April 1483, supported by the duke of Buckingham, he intercepted his nephew at Stony Stratford and arrested Lord Rivers and Richard Grey, the little king's half-brother. It was in Richard's charge that Edward was brought to London on the 4th of May. Richard was recognized as protector, the Woodville faction was overthrown, and the queen with her younger children took sanctuary at Westminster. For the time the government was carried on in Edward's name, and the 22nd of June was appointed for his coronation. Richard was nevertheless gathering forces and concerting with his friends. In the council there was a party, of whom Hastings and Bishop Morton were the chief, which was loyal to the boy-king. On the 13th of June came the famous scene when Richard appeared suddenly in the council baring his withered arm and accusing Jane Shore and the queen of sorcery; Hastings, Morton and Stanley were arrested and the first-named at once beheaded. A few days later, probably on the 25th of June, Rivers and Grey were executed at Pontefract. On the 22nd of June Dr Shaw was put up to preach at Paul's Cross against the legitimacy of the children of Edward IV. On the 25th a sort of parliament was convened at which Edward's marriage was declared invalid on the ground of his precontract with Eleanor Talbot, and Richard rightful king. Richard, who was not present, accepted the crown with feigned reluctance, and from the following day began his formal reign.

On the 6th of July Richard was crowned at Westminster, and immediately afterwards made a royal progress through the Midlands, on which he was well received. But in spite of its apparent success the usurpation was not popular. Richard's position could not be secure whilst his nephews lived. There seems to be no reasonable doubt that early in August Edward V. and his brother Richard (whom Elizabeth Woodville had been forced to surrender) were murdered by their uncle's orders in the Tower. Attempts have been made to clear Richard's memory. But the report of the princes' death was believed in England at the time, "for which cause king Richard lost the hearts of the people" (*Chronicles of London*, 191), and it was referred to as a definite fact before the French states-general in January 1484. The general, if vague, dissatisfaction found its expression in Buckingham's rebellion. Richard, however, was fortunate, and the movement collapsed. He met his only parliament in January 1484 with some show of triumph, and deserves credit for the wise intent of its legislation. He could not, however, stay the undercurrent of disaffection, and his ministers, Lovell and Catesby, were unpopular. His position was weakened by the death of his only legitimate son in April 1484. His queen died also a year later (March 16, 1485), and public opinion was scandalized by the rumour that Richard intended to marry his own niece, Elizabeth of York. Thus the feeling in favour of his rival Henry Tudor strengthened. Henry landed at Milford Haven on the 7th of August 1485, and it was with dark forebodings that Richard met him at Bosworth on the 22nd. The defection of the Stanleys decided the day. Richard was killed fighting, courageous at all events. After the battle his body was carried to Leicester, trussed across a horse's back, and buried without honour in the church of the Greyfriars.

Richard was not the villain that his enemies depicted. He had good qualities, both as a man and a ruler, and showed a sound judgment of political needs. Still it is impossible to acquit him of the crime, the popular belief in which was the chief cause of his ruin. He was not a monster; but a typical man in an age of strange contradictions of character, of culture combined with cruelty, and of an emotional temper that was capable of high ends, though unscrupulous of means. Tradition represents Richard as deformed. It seems clear that he had some physical defect, though not so great as has been alleged. John Stow told Buck that old men who remembered Richard described him as in bodily form comely enough. Extant portraits show an intellectual face characteristic of the early Renaissance, but do not indicate any deformity.

BIBLIOGRAPHY.—The chief original authorities are Sir Thomas More's *History of Richard III.*, based on information supplied by Archbishop Morton, and therefore to be accepted with caution; the

more trustworthy *Continuation of the Croyland Chronicle* in Fulman's *Scriptores*, the *History of Polydore Vergil*, written in a Tudor spirit; the *Chronicle of London* (ed. C. L. Kingsford, 1905), and its biased expansion in Fabyan's *Chronicle*. See also *Letters and Papers Illustrative of the Reigns of Richard III. and Henry VII.*, ed. J. Gairdner, in Rolls Series. Of later accounts those in *Stow's Annals* (preserving some oral tradition) and George Buck's *Richard III.* sp. Kennet *History of England* deserve mention. Horace Walpole attempted a vindication in his *Historic Doubts* (1768). The best modern account is James Gairdner's *Life of Richard III.* (2nd ed., 1898). The latest and fullest defence is given in Sir Clements Markham's *Richard III., His Life and Character* (1906); G. B. Churchill's *Richard the Third up to Shakespeare* (*Palaestra X.*, 1900) is a valuable digest of material. (C. L. K.)

RICHARD, FRANÇOIS MARIE BENJAMIN (1819–1908), archbishop of Paris, French prelate, was born at Nantes on the 1st of March 1819. Educated at the seminary of St Sulpice he became successively vicar-general of Nantes, bishop of Belley, and in 1875 coadjutor of Paris. In 1886 the death of Archbishop Guibert was followed by Mgr. Richard's appointment to the see of Paris, and in 1889 he received a cardinal's hat. In January 1900 the trial of the Assumptionist Fathers resulted in the dissolution of their society as an illegal association. Next day an official visit of the archbishop to the Fathers was noted by government as an act of a political character, and Mgr. Richard was officially censured. His attitude was in general exceedingly moderate, he had no share in the extremist policy of the Ultramontanes, and throughout the struggle over the law of Associations and the law of Separations he maintained his reasonable temper. He presided in September 1906 over an assembly of bishops and archbishops at his palace in the rue de Grenelle, a few days after the papal encyclical forbidding French Catholics to form associations for public worship, but it was then too late for conciliation. In December he gave up the archiepiscopal palace to the government authorities. He was then an old man of nearly ninety, and his "eviction" evoked great sympathy. Cardinal Richard died on the 29th of January 1908.

RICHARD, HENRY (1812–1888), Welsh politician, was the son of the Rev. Ebenezer Richard (1781–1837), a Calvinistic Methodist minister, and was born on the 3rd of April 1812. Educated at Llangetho grammar school, he also studied at a college at Highbury, and in 1835 he became minister of a Congregational church in the Old Kent Road, London, a position which he retained for fifteen years. Richard is chiefly known as an advocate of peace and international arbitration. In 1848 he became secretary of the Peace Society, and in this capacity he helped to organize a series of congresses in the capitals of Europe, and was partly instrumental in securing the insertion of a declaration in favour of arbitration in the treaty of Paris in 1856. He resigned this post in 1885. In 1868 Richard was elected member of parliament for the Merthyr boroughs, and he remained in the House of Commons until his death at Treborth, near Bangor, on the 20th of August 1888. In parliament he was a leading member of the party which advocated the removal of Nonconformist grievances and the disestablishment of the church in Wales; in 1877 he was chairman of the Congregational Union of England and Wales. Among Richard's writings may be mentioned: *Defensive War* (1846, and again 1890); *Memoirs of Joseph Sturge* (1864); *Letters on the Social and Political Condition of the Principality of Wales* (1866, and again 1884); and *The Recent Progress of International Arbitration* (1884). He also prepared some of the material for the life of his friend and associate, Richard Cobden, which was written by Mr John, now Lord, Morley; and he did some journalistic work in the *Morning Star* and the *Evening Star*.

See C. S. Miall, *Henry Richard, M.P.* (1889); L. Appleton, *Memoirs of Henry Richard* (1889); and articles in *Cymru Fydd* for 1888.

RICHARD OF CIRENCESTER (c. 1335–c. 1401), historical writer, was a member of the Benedictine abbey at Westminster, and his name ("Circestre") first appears on the chamberlain's list of the monks of that foundation drawn up in the year 1355. In the year 1391 he obtained a licence from the abbot to go to Rome, and in this the abbot gives his testimony to Richard's

perfect and sincere observance of religion for upwards of thirty years. In 1400 Richard was in the infirmary of the abbey, where he died in the following year. His only known extant work is *Speculum Historiale de Gestis Regum Angliæ*, 447-1066. The MS. of this is in the university library at Cambridge, and has been edited for the Rolls Series (No. 30) by Professor J. E. B. Mayor (2 vols., London, 1863-69). It is in four books, and at the conclusion of the fourth book Richard expresses his intention of continuing his narrative from the accession of William I., and incorporating a sketch of the Conqueror's career from his birth. This design he does not, however, appear to have carried into effect. The value of the *Speculum* as a contribution to our historical knowledge is but slight, for it is mainly a compilation from other writers; while even in transcribing these the compiler is guilty of great carelessness. He gives, however, numerous charters relating to Westminster Abbey, and also a very complete account of the saints whose tombs were in the abbey church, and especially of Edward the Confessor. The work was, however, largely used by historians and antiquaries, until, with the rise of a more critical spirit, its value became more accurately estimated. Besides the *Speculum* Richard also wrote, according to the statement of William of Woodford in his *Answer to Wycliffe* (Edward Brown, *Fasciculum Rerum expediendarum*, p. 103), a treatise *De Officiis*; and there was formerly in the cathedral library at Peterborough another tractate from his pen, entitled *Super Symbolum*. Of neither of these works, however, does any known copy now exist.

The *Speculum* affords the most conclusive proof of the spuriousness of another work attributed to Richard and long accepted by the learned world as his. This was the *De Situ Britannicæ*, an elaborate forgery relating to the antiquities of Roman Britain, which first appeared at Copenhagen in the year 1747. It was printed with the works of Gildas and Nennius, under the editorship of Charles Julius Bertram, professor of English in the academy of Copenhagen in the middle of the 18th century, with the following special title: "Richardi Corinensis monachi Westmonasteriensis de situ Britannicæ libri duo. E. Codici MS. descriptum, Notisque et Indice adornavit Carolus Bertram."

This forgery was accepted as genuine by a well-known antiquary of the 18th century, Dr William Stukeley, and under the sanction of his authority continued for a long time to be regarded in the same light by numerous scholars and antiquaries, including Gibbon and Lingard. On the other hand, critics of a later date gave expression, on various grounds, to a contrary conclusion. All doubt on the subject may, however, be held to have been effectually set at rest by the masterly exposure of the whole fraud drawn up by Professor Mayor in the preface to the edition above referred to of the *Speculum*. He has there not only demonstrated, from the external and internal evidence alike, the spuriousness of the whole treatise, but in a collation (extending to nearly a hundred pages) of numerous passages with corresponding passages in classical medieval authorities, has also traced out the various sources whence Bertram derived the terminology and the facts which he reproduced in the *De Situ*. (J. B. M.)

RICHARD OF DEVIZES (fl. 1191), English chronicler, was a monk of St Swithin's house at Winchester. His birthplace is probably indicated by his surname, but of his life we know nothing. He is credited by Bale with the composition of the *Annales de Wintonia*, which are edited by Luard in the second volume of the *Annales Monastici*. If this statement be correct, then the chronicler survived King Richard I. But the *Chronicon de rebus gestis Ricardæ Primi*, by which Richard of Devizes is chiefly known, only covers the first three years of that king's reign; it is practically an account of events in England and the Holy Land during the Third Crusade. For the events of the crusade itself, Richard is a poor authority. But his account of the preparations for the crusade, and of English affairs in the king's absence, is valuable, in spite of some inaccuracies. The author is intensely conservative, steeped in the prejudices of his order, and particularly hostile to the Jews and to the chancellor, William Longchamp. He writes in a vivid and epigrammatic style; his Latin shows the effect of the 12th-century renaissance in its polish and in its reminiscences of classical poets.

See the editions of the *Chronicon de rebus gestis Ricardæ Primi* by J. Stevenson (Eng. Historical Soc., 1838) and by R. Howlett in

Chronicles of the Reigns of Stephen, Henry II. and Richard I., vol. iii. (Rolls Series, 1886); the *Annales de Wintonia* in H. R. Luard's *Annales Monastici*, vol. ii. (Rolls Series, London, 1864-69). (H. W. C. D.)

RICHARD OF HEXHAM (fl. 1141), English chronicler, became prior of Hexham about 1141, and died between 1163 and 1178. He wrote *Brevis Annotatio*, a short history of the church of Hexham from 674 to 1138, for which he borrowed from Bede, Eddius, and Simeon of Durham. This is published by J. Raine in *The Priory of Hexham, its Chroniclers, Endowments and Annals* (Durham, 1864-65). More important is his *Historia de gestis regis Stephani et de bello Standardii*, very valuable for the history of the north of England during the earlier part of the reign of Stephen, and especially for the battle of the Standard. This history, which is a contemporary one, covers the period from the death of Henry I. in 1135 to early in 1139. It has been edited for the Rolls Series by R. Howlett in the *Chronicles of the Reigns of Stephen, Henry II. and Richard I.*, vol. iii. (1886); and has been translated by J. Stevenson in the *Church Historians of England*, vol. iv. (1856).

RICHARD OF ILCHESTER (d. 1188), English statesman and prelate, was born in the diocese of Bath, where he obtained preferment. Early in the reign of Henry II., however, he is found acting as a clerk in the king's court, probably under Thomas Becket, and he was one of the officials who assisted Henry in carrying out his great judicial and financial reforms. In 1162, or 1163, he was appointed archdeacon of Poitiers, but he passed most of his time in England, although in the next two or three years he visited Pope Alexander III. and the Emperor Frederick I. in the interests of the English king, who was then engaged in his struggle with Becket. For promising to support Frederick against Alexander he was excommunicated by Becket in 1166. Before this event, however, Richard had been appointed a baron of the exchequer, his great industry and exceptional abilities as an accountant being recognized by giving him a special seat at the exchequer table, and from 1168 until his death he frequently acted as one of the itinerant justices. Although totally immersed in secular business he received several rich ecclesiastical offices, and in May 1173 he was elected bishop of Winchester, being consecrated at Canterbury in October 1174. Richard still continued to serve Henry II. In 1176 he was appointed justiciar and seneschal of Normandy, and was given full control of all the royal business in the duchy. He died on the 21st or 22nd of December 1188, and was buried in Winchester cathedral. Richard owes his surname to the fact that Henry II. granted him a mill at Ilchester; he is also called Richard of Toctlyve.

See the article by Miss K. Norgate in the *Dict. Nat. Biog.*, vol. xlviii. (1896); and W. R. W. Stephens and W. W. Capes, *The Bishops of Winchester* (1907).

RICHARD OF ST VICTOR (d. 1173), theologian and mystic of the 12th century. Very little is known of his life; he was born in Scotland or in England, and went to Paris, where he entered the abbey of St Victor and was a pupil of the great mystic, Hugh of St Victor. He succeeded as prior of this house in 1162, and was continually contesting the tyrannical authority of the abbot Ervisius. His writings, some of which are still in manuscript, are very numerous, the best known being his mystical treatises: *De statu hominis interioris*, *De præparatione animi ad contemplationem*, *De gratia contemplationis*, *De gradibus caritatis*, *De arcana nupticia*, and his two works on the Trinity: *De trinitate libri sex*, *De tribus appropriatis personis in Trinitate*. As is the case with all the Victorines, his mysticism was a reaction against the philosophy of the schools of his time, a perpetual justification of contemplation as opposed to logical reasoning. According to him, six steps lead the soul to contemplation: (1) contemplation of visible and tangible objects; (2) study of the productions of nature and of art; (3) study of character; (4) study of souls and of spirits; (5) entrance to the mystical region which ends in (6) ecstasy. His theory of the Trinity is chiefly based on the arguments of Anselm of Canterbury, although a certain deification of the social sense is evident.

His style is most affected, and the influence of the neo-Platonist terminology as well as of the works of the pseudo-Dionysius can be clearly detected. In the *Paradis* Dante has placed Richard de St Victor, whose books were much read by his contemporaries, among the greatest teachers of the Church. His writings seem to have come into favour again in the 16th and 17th centuries, six editions of his works having been printed between 1506 and 1650.

BIBLIOGRAPHY. *Œuvres*, edited in the *Patrologia latina* by Migne, vol. ccxvi.; W. Kaulich, "Die Lehren des Hugo und Richard von St. Victor" (*Abhandlungen der K. böhmischen Gesellschaft der Wissenschaften*, V. Folge, vol. xiii. (2nd ed. Paris, 1905), p. 231 (Prague, 1864); P. C. F. Daunou, article in *Histoire littéraire de la France*, tome xiii. (Paris, 1869); G. Buonamici, *Riccardo da S. Vittore* (Alatri, 1899); DeWulf, *Histoire de la philosophie médiévale* (2nd ed. Paris, 1905), p. 231.

RICHARDIA, a small genus of the nat. ord. Araceae, native in South Africa, to which the "arum lily" belongs. They are all greenhouse herbaceous plants of handsome appearance, with thick underground stems and large, more or less fleshy, long-stalked, arrow-shaped leaves and white or yellow flower spathes. They are readily propagated by division of the shoot, also by seed. Water should be given abundantly at all times, and the soil for potting should be rich and retentive. Potting is best effected in spring, and from the end of June to the end of August they should be plunged in a sunny spot out of doors. They will not withstand frost, and should be wintered in a warm greenhouse. They flower throughout the year.

RICHARDS, ALFRED BATE (1820–1876), English journalist, was born in Worcestershire on the 17th of February 1820, and was educated at Westminster School and Exeter College, Oxford. After taking his degree in 1841 he published, anonymously, *Oxford Unmasked*, a denunciation of abuses in the university. Between 1845 and 1848 he wrote several dramas and some poetry, and in the latter year became editor of a weekly newspaper, the *British Army Despatch*. His temperament was strongly Imperialist; he opposed Cobden and the Manchester school of politicians, and in a volume entitled *Britain Redeemed and Canada Preserved* predicted, thirty years before the event, the construction of the Canadian Pacific railway. In 1855 he was appointed the first editor of the London *Daily Telegraph*, and through the medium of that journal strongly urged the formation of volunteer rifle corps. The National and Constitutional Defence Association was established in 1858 to carry out the idea. Richards himself raised a regiment of a thousand working men in London, becoming major and subsequently colonel of the corps. In 1870 he was appointed editor of the London *Morning Advertiser*, and retained this position till his death on the 12th of June 1876.

RICHARDS, HENRY BRINLEY (1819–1865), English pianist and composer, was born at Carmarthen, and educated at the Royal Academy of Music in London, where later he was a professor. He took much interest in Welsh music and in the Eisteddfod gatherings. He was a prolific composer, but is perhaps principally remembered for writing the song "God bless the Prince of Wales" (1862), which has been adopted as an English national anthem.

RICHARDS, WILLIAM TROST (1833–1905), American marine painter, was born at Philadelphia, Pennsylvania, on the 14th of November 1833. He was a pupil of Paul Weber in his native city, and lived much in France, Italy and London. He was a member of the Pennsylvania Academy of the Fine Arts, and of the American Water Colour Society. Examples of his work are in the collections of the Pennsylvania Academy of the Fine Arts, Philadelphia, Penn.; the Metropolitan Museum of Art, New York, the Corcoran Art Gallery, Washington, D.C., and the Schaub Gallery, Hamburg. He died at Newport, Rhode Island, on the 8th of November 1905. His daughter ANNA M. RICHARDS (b. 1870), figure and landscape painter, was a pupil of John La Farge and Benjamin Constant.

RICHARDSON, GEORGE, English 18th-century architect and designer. The dates of birth and death of this distinguished contemporary and rival of the brothers Adam are not ascertained, but he is conjectured to have been born about 1736

and to have died in 1817. Richardson spent three years—from 1760 to 1763—travelling in Dalmatia and Istria, in the south of France and in Italy. During that period he imbibed the inspiration of a lifetime, and acquired the material for its practical application. He soon began to show remarkable skill in adapting classical ideals to the uses of his time, and in 1765 he won a premium offered by the Society of Arts for a design of a street in the classical manner. Richardson's work is so closely allied to that of the brothers Adam that it is often difficult to distinguish between them, and if it possessed less freedom and variety, and bore to a smaller extent the impress of an original mind, it was in the main exceedingly admirable and satisfying. Richardson was an especially successful designer of ceilings and chimneypieces. He published in 1776 a *Book of Ceilings in the Style of the Antique Grottesque*. Many of its drawings are of exquisite taste. Nor is his fireplace work, as represented by his *Collection of Chimneypieces Ornamented in the Style of the Etruscan, Greek and Roman Architecture* (1781), less attractive. Richardson's chimneypieces are still to be found in considerable numbers in town and country houses. They are mostly of marble, but examples in wood are not uncommon. He made extensive use of coloured marbles, and the effect is constantly that of the sumptuous balancing the austere. Like the Adams, Richardson often worked with composition enrichments, and his *New Designs in Architecture* (1792) contains many drawings of interior friezes and columns to be executed either in this medium or painted to suit the wall hangings. His versatility was considerable, as the titles of his works, a dozen in number, suggest. For many years he exhibited at the Royal Academy as well as in the Galleries of the Society of Arts. Why such a man should have fallen into penury in his old age we have no means of ascertaining, but we know that his necessities were relieved by Nollekens.

His principal works in addition to those already mentioned were, in chronological order: *Aedes Pembrochianae* (1774); *Icomology* (2 vols.), with plates by Bartolozzi and other engravers (1778–1779); *New Designs in Architecture* (1792); *Original Designs for Country Seats or Villas* (1795); *The New Virianus Britannicus*, a sequel to Colin Campbell's *Virianus Britannicus*, 2 vols. (1802); *Ornaments in the Grecian, Roman and Etruscan Tastes* (1816). He also published volumes dealing with vases and tripods, antique friezes and other architectural and decorative details.

RICHARDSON, HENRY HOBSON (1838–1886), American architect, was born in the parish of St James, Louisiana, on the 29th of September 1838, of a rich family, his mother being a granddaughter of the famous Dr Priestley, the English dissenting refugee and man of science. He was graduated from Harvard University in 1859, and going immediately to Paris to study architecture, entered the *École des Beaux-Arts*. The Civil War, which broke out in the United States while he was in the school, prevented his return to Louisiana, and stripped his family of their possessions, so that Richardson provided for his own support by working in the offices of practising architects in Paris, till the fall of 1865. Coming back, he established himself in New York, where he soon made his way into practice as an architect. In 1878 he moved to Boston, where he passed the remaining years of his life, designing there most of the work that made his reputation. He had married in 1867 Miss Julia Gorham Hayden of Boston; he died on the 27th of April 1886, not yet forty-eight years old.

Richardson's career was short, and the number of his works was small indeed compared with the attention they attracted and the influence he left behind him. The most important and characteristic are: Trinity church and the so-called Brattle Square church, in Boston; the alterations in the State Capitol at Albany; the county buildings at Pittsburg; town halls at Albany, Springfield and North Easton; town libraries at Woburn, North Easton, Quincy, Burlington and Malden; Sever Hall and Austin Hall at Harvard University; the Chamber of Commerce at Cincinnati. Trinity church, the Pittsburg buildings and the Capitol at Albany were works of great importance, which have had a strong influence on men

who followed him and brought him wide acknowledgment. It is notable that American architects who have studied in Europe, especially in Paris, are apt to drift either into a pathless eclecticism or into the English current. Richardson did neither. The Romanesque that he saw in Europe, especially in the middle and south of France, appealed so strongly to his sense for mass and broad picturesqueness that he soon followed its leading, away from the style he had learned in Paris. His earliest work was modern French in style; his first church, in Springfield, a startlingly independent version of English Gothic. Yet half a dozen buildings made the transition to that derivative of Romanesque to which afterwards in all his buildings he steadfastly adhered. In Trinity church, his first monumental work, perhaps his finest, he broke away absolutely from the prevailing English Gothic fashion. Instead of the long Latin cross with aisles and transepts, he made a wide cross almost Greek in plan, with short arms fifty feet broad and aisles that are only passages, a narthex flanked by two western towers, a nave of one double bay, an eastern arm prolonged into a great apse of the full width of the crossing, over which sits a massive square tower. The arms of the church are barrel-vaulted in wood; under the great tower is a flat coffered ceiling a hundred feet above the floor. The style, though mixed, shows his surrender to the attraction of the churches in Auvergne, which have furnished the material for the design of the apse. The central tower is a reminiscence of the noble lantern of the old cathedral of Salamanca, but the square outline is insisted on instead of the polygonal, and the forms are in other ways much changed. The alteration of the Capitol at Albany, half a dozen years later, shared with Leopold Eidlitz, was a compromise in style, and so lacks the sure handling of his best work, except in that part of the interior in which he was untrammelled, the Senate Chamber and the great staircase. In the buildings at Pittsburg, on the other hand, he was free from interference, and these satisfied him more than any other of his buildings. His great design for the new cathedral at Albany, an adaptation of the Romanesque forms of Auvergne to a large modern problem, would have displayed his mature manner, and been perhaps his greatest work; but the plan did not lend itself to the tradition or the ritual of the Anglican Church, and it was rejected, to his great disappointment.

At first the breadth of his compositions was offset by a richness of ornament which he afterwards called flamboyant, but there was a continual growth in simplicity. Some of his imitators have abused his example, running into mere baldness and brutality, but his own work never lost the fitness of quality which he began, nor the adequacy of its detail.

Richardson's uncommon personality so embodied itself in his works that it cannot be overlooked. He had an inexhaustible energy of body and mind, an enthusiasm more genial than combative, but so abounding and at times vehement that few men and few bodies of men could resist him.

Abounding energy he had, but not health. A serious bodily injury, and later a chronic malady, made his last years a constant struggle with suffering and infirmity, borne with indomitable cheerfulness, but at last fatal.

It is likely that the small number of his designs enhanced their quality. He put twice the labour into his work that the average architect would have given to it, and often twice the time, but the result was apt to be twice as good. He found American architecture restless, incoherent and exuberant; his example did much to turn it back to simplicity and repose. He came as near to establishing a style as it is given to any one man to come; but the tendency of the time was too strong, and the classic styles, reasserting themselves, once more drove out the mediæval.

The best known book about Richardson is Mrs Schuyler van Rensselaer's *H. H. Richardson and his Works* (Boston, 1888).

(W. P. L.)

RICHARDSON, SIR JOHN (1787-1865), British naturalist, was born at Dumfries on the 5th of November 1787. He studied

medicine at Edinburgh, and became a surgeon in the navy in 1807. In 1819 he was appointed surgeon and naturalist to Franklin's first arctic expedition (1819-22), and he served in the same capacity to the second (1825-26). The scientific results of these expeditions he described in contributions to Franklin's *Narratives*, and especially in the four quarto volumes of his *Fauna Boreali-Americana* (1829-37). He was knighted in 1846, and in the following year was chosen commander of the Franklin search expedition (1848-49), the journal of which he published in 1851 under the title of *An Arctic Searching Expedition*. In 1855 he retired to Grasmere, where he died on the 5th of June 1865. He also wrote accounts dealing with the natural history, and especially the ichthyology, of several other arctic voyages, and was the author of *Icones Piscium* (1843), *Catalogue of Apodal Fish in the British Museum, translated from the German MS.* (1856), the second edition of Yarrell's *History of British Fishes* (1860), and *The Polar Regions* (1861), expanded from an article with the same title which he wrote for the *Encyclopaedia Britannica*.

A *Life* by John Macraith was published in 1868.

RICHARDSON, SAMUEL (1689-1761), English novelist, is a notable example of that "late-flowering" sometimes applied to Oliver Goldsmith. Born under William and Mary, the reign of the second George was well advanced before, at fifty years of age, he made his first serious literary effort—an effort which was not only a success, but the revelation of a new literary form. He was the son of a London joiner, who, for obscure reasons, probably connected with Monmouth's rebellion, had retired to an unidentified town in Derbyshire, where, in 1689, Samuel was born. At first intended for holy orders, and having little but the common learning of a private grammar school—for the tradition that upon the return of the family to the metropolis he went to Christ's Hospital cannot be sustained—he was eventually, as some compensation for a literary turn, apprenticed at seventeen to an Aldersgate printer named John Wilde. Here, like the typical "good apprentice" of his century, he prospered; became successively compositor, corrector of the press, and printer on his own account; married his master's daughter according to programme; set up newspapers and books; dabbled a little in literature by compiling indexes and "honest dedications," and ultimately proceeded Printer of the Journals of the House of Commons, Master of the Stationers' Company, and Law-Printer to the King. Like all well-to-do citizens, he had his city house of business and his "country box" in the suburbs; and, after a thoroughly "respectable" life, died on the 4th of July 1761, being buried in St Bride's Church, Fleet Street, close to his shop (now demolished), No. 11 Salisbury Court.

To this uneventful and conventional career one would scarcely look for the birth and growth of a fresh departure in fiction. And yet, although Richardson's manifestation of his literary gift was deferred for half a century, there is no life to which the Horatian "qualis ab incepto" can be more appropriately applied. From his youth this moralist had moralized; from his youth—nay, from his childhood—this letter-writer had written letters; from his youth this supreme delineator of the other sex had been the confidant and counselor of women. In his boyhood he was secretary-general to all the love-sick girls of the neighbourhood; at eleven he addressed a hortatory epistle, stuffed with texts, to a scandal-loving widow; and whenever it was possible to correspond with any one he was as "corresponding" as even Horace Walpole could have desired. At last, when he was known to the world only as a steady business man, who was also a "dab at an index" and an invaluable compiler of the "puff prefatory," it occurred to Mr Rivington of St Paul's Churchyard and Mr Osborn of Paternoster Row, two book-selling friends who were aware of his epistolary gifts, to suggest that he should prepare a little model letter-writer for such "country readers" as "were unable to indite for themselves." Would it be any harm, he suggested in answer, if he should also "instruct them how they should think and act in common cases"? His friends were all the more anxious that he should

set to work. And thus originated his first novel of *Pamela; or, Virtue Rewarded*.

But not forthwith, as is sometimes supposed. Proceeding with the compilation of his model letter-writer, and keeping, in his own words, "to instruct handsome girls, who were obliged to go out on service . . . how to avoid the snares that might be laid against their virtue"—a danger which appears to have always abnormally preoccupied him—he came to recollect a story he had heard twenty years earlier, and had often proposed to other persons for fictitious treatment. It occurred to him that it would make a book of itself, and might moreover be told wholly in the fashion most congenial to himself, namely, by letters. Thereupon, with some domestic encouragement, he completed it in a couple of months, between the 10th of November 1739 and the 10th of January 1740. In November 1740 it was issued by Messrs Rivington & Osborn, who, a few weeks afterwards (January 1741), also published the model letter-writer under the title of *Letters written to and for Particular Friends, on the most Important Occasions*. Both books were anonymous. The letter-writer was noticed in the *Gentleman's Magazine* for January, which also contains a brief announcement as to *Pamela*, already rapidly making its way without waiting for the reviewers. A second edition, it was stated, was expected; and such was its popularity, that not to have read it was judged "as great a sign of want of curiosity as not to have seen the French and Italian dancers"—i.e. Mme Chateaufeuil and the Fausans, who were then delighting the town. In February a second edition duly appeared, followed by a third in March and a fourth in May. At public gardens ladies held up the book to show they had got it; Dr Benjamin Stoccock of Southwark openly commended it from the pulpit; Pope praised it; and at Slough, when the heroine triumphed, the enraptured villagers rang the church bells for joy. The other volume of "familiar letters" consequently fell into the background in the estimation of its author, who, though it went into several editions during his lifetime, never acknowledged it. Yet it scarcely deserves to be wholly neglected, as it contains many useful details and much shrewd criticism of lower middle-class life.

For the exceptional success of *Pamela* there was the obvious excuse of novelty. People were tired of the old "mouthy" romances about impossible people doing impossible things. Here was a real-life story, which might happen to any one—a story which aroused curiosity and arrested attention—which was not exclusively about "high life," and which had, in addition, a moral purpose, since it was avowedly "published in order to cultivate the principles of virtue and religion in the minds of the youth of both sexes." Whether it had exactly this effect, or owed its good fortune chiefly to this proclamation, may be doubted. The heroine in humble life who resists the licentious advances of her master until he is forced to marry her, does not entirely convince us that her watchful prudence and keen eye for the main chance have not, in the long run, quite as much to do with her successful defence as her boasted innocence and purity. Nor is the book without passages which more than smack of an unpleasant prudency. Nevertheless, in its extraordinary gift of minute analysis; in its intimate knowledge of feminine character; in the cumulative power of its shuffling, loose-shod style, and, above all, in the unquestionable earnestness and sincerity of the writer, *Pamela* had qualities which—particularly in a dead season of letters—sufficiently account for its favourable reception by the contemporary public.

Such a popularity, of course, was not without its drawbacks. That it would lead to *Anti-Pamelas*, censures of *Pamela* and all the spawn of pamphlets which spring round the track of a sudden success, was to be anticipated. One of the results to which its rather sickly morality gave rise was the *Joseph Andrews* (1742) of Fielding (q.v.). But there are two other works prompted by *Pamela* which need brief notice here. One is the *Apology for the Life of Mrs Shamela Andrews*, a clever and very gross piece of railery which appeared in

April 1741, and by which Fielding is supposed to have precluded to *Joseph Andrews*. Fielding's own works contain no reference to *Shamela*. But Richardson in his *Correspondence*, both printed and unprinted, roundly attributes it to the writer who was to be his rival; and it is also assigned to Fielding by other contemporaries (*Hist. MSS. Commn.*, Rept. 12, App. Pt. IX. p. 204). All that can be said is, that Fielding's authorship cannot be proved. If it could, it would go far to justify the after animosity of Richardson to Fielding—much farther, indeed, than what Richardson described as the "lewd and ungenerous engraftment" of *Joseph Andrews*. The second noteworthy result of *Pamela* was *Pamela's Conduct in High Life* (September 1741), a spurious sequel by John Kelly of the *Universal Spectator*. Richardson tried to prevent its appearance, and, having failed, set about two volumes of his own, which followed in December, and professed to depict his heroine "in her exalted condition." But the public interest in *Pamela* had practically ceased with her marriage, and the author's continuation, like other continuations—particularly continuations prompted by extraneous circumstances—attracted no permanent attention.

About 1744 we begin to hear something of the progress of Richardson's second and greatest novel, *Clarissa; or, the History of a Young Lady*, usually miscalled *Clarissa Harlowe*. The first edition was in seven volumes, two of which came out in November 1747, two more in April 1748 and the last three in December. Upon the title-page of this, of which the mission was as edifying as that of *Pamela*, its object was defined as showing the distresses that may attend the misconduct both of parents and children in relation to marriage. Virtue, in *Clarissa*, is not "rewarded," but hunted down and outraged. The heroine, no longer an opportunist servant-girl, is a most pure, refined and beautiful young woman, invested with every attribute to attract and charm, while her pursuer, Lovelace, the libertine hero of the book—a personage of singular dash and vivacity, in spite of his worthlessness—is drawn with extraordinary tenacity of power. The wronged *Clarissa* eventually dies of grief, and her cold-blooded betrayer, whom strict justice would have hanged, is considerably killed in a duel by her soldier cousin. Of the genius of the story there can be no doubt. Nor is there any doubt as to the ability shown in the delineation of the two chief characters, to whom the rest are merely subordinate. The chief drawbacks of *Clarissa* are its merciless prolixity (seven volumes, which only cover eleven months); the fact that (like *Pamela*) it is told by letters; and a certain haunting and uneasy feeling that many of the heroine's obstacles are only molehills which should have been readily surmounted. As to its success, accentuated as this was by its piecemeal method of publication, there has never been any question. *Clarissa's* sorrows set all England sobbing, and her fame and her fate spread rapidly to the Continent.

Between *Clarissa* and Richardson's next work appeared the *Tom Jones* of Fielding—a rival by no means welcome to the elder writer, although a rival who generously (and perhaps penitently) acknowledged *Clarissa's* rare merits.

"Pectus inaniter angit
Irritat, mulcet, falsis terroribus implet
Ut Magus,"

Fielding had written in the *Jacobite's Journal*. But even this could not console Richardson for the popularity of the "spurious brat" whom Fielding had made his hero, and his next effort was the depicting of a genuine fine gentleman—a task to which he was incited by a chorus of feminine worshippers. In the *History of Sir Charles Grandison*, "by the Editor of *Pamela* and *Clarissa*" (for he still preserved the fiction of anonymity), he essayed to draw a perfect model of manly character and conduct. In the pattern presented there is, however, too much buckram, too much ceremonial—in plain words, too much priggishness—to make him the desired exemplar of propriety in *excessis*. Yet he is not entirely a failure, still less is he to be regarded as no more than "the

condescending suit of clothes" by which Hazlitt unfairly defines Miss Burney's Lord Orville. When Richardson delineated Sir Charles Grandison he was at his best, and his experiences and opportunities for inventing such a character were infinitely greater than they had ever been before. And he lost nothing of his gift for portraying the other sex. Harriet Byron, Clementina della Porretta and even Charlotte Grandison, are no whit behind Clarissa and her friend Miss Howe. *Sir Charles Grandison*, in fine, is a far better book than *Pamela*, although M. Taine regarded the hero as only fit to be stuffed and put in a museum.

Grandison was published in 1753, and by this time Richardson was sixty-four. Although the book was welcomed as warmly as its predecessors, he wrote no other novel, contenting himself instead with indexing his works, and compiling an anthology of the "maxims," "cautions" and "instructive sentiments" they contained. To these things, as a professed moralist, he had always attached the greatest importance. He continued to correspond relentlessly with a large circle of worshippers, mostly women, whose counsels and fertilizing sympathy had not a little contributed to the success of his last two books. He was a nervous, highly strung little man, intensely preoccupied with his health and his feelings, hungry for praise when he had once tasted it, and afterwards unable to exist without it; but apart from these things, well meaning, benevolent, honest, industrious and religious. Seven vast folio volumes of his correspondence with his lady friends, and with a few men of the Young and Aaron Hill type, are preserved in the Forster Library at South Kensington. Parts of it only have been printed. There are several good portraits of him by Joseph Highmore, two of which are in the National Portrait Gallery.

Richardson is sometimes styled the "Father of the English Novel," a title which has also been claimed for Defoe. It would be more accurate to call him the father of the novel of sentimental analysis. As Sir Walter Scott has said, no one before had dived so deeply into the human heart. No one, moreover, had brought to the study of feminine character so much prolonged research, so much patience of observation, so much interested and indulgent apprehension, as this twittering little printer of Salisbury Court. That he did not more materially control the course of fiction in his own country was probably owing to the new direction which was given to that fiction by Fielding and Smollett, whose method, roughly speaking, was synthetic rather than analytic. Still, his influence is to be traced in Sterne and Henry Mackenzie, as well as in Miss Burney and Miss Austen, both of whom, it may be noted, at first adopted the epistolary form. But it was in France, where the sentimental soil was ready for the dressing, that the analytic process was most warmly welcomed. Extravagantly eulogized by the great critic, Diderot, modified with splendid variation by Rousseau, copied (unwillingly) by Voltaire, the vogue of Richardson was so great as to tempt some modern French critics to seek his original in the *Marianne* of a contemporary analyst, Marivaux. As a matter of fact, though there is some unconscious consonance of manner, there is nothing whatever to show that the little-lettered author of *Pamela*, who was also ignorant of French, had the slightest knowledge of Marivaux or *Marianne*. In Germany Richardson was even more popular than in France. Gellert, the fabulist, translated him; Wieland, Lessing, Hermes, all imitated him, and Coleridge detects him even in the *Robbers* of Schiller. What was stranger still, he returned to England again under another form. Having given a filip to the French *comédie larmoyante*, that comedy crossed the channel as the sentimental comedy of Cumberland and Kelly, which, after a brief career of prosperity, received its death-blow at the hands of Goldsmith and Sheridan.

A selection from Richardson's *Correspondence* was published by Mrs A. L. Barbauld in 1804, in six volumes, with a valuable Memoir. Recent lives are by Miss Clara L. Thomson, 1900, and by Austin Dobson ("Men of Letters"), 1902. A convenient reprint of the novels, with copies of the old illustrations by Stothard, Edward

Burney and the rest, and an introduction by Mrs E. M. McKenna, was issued in 1901 in 20 volumes. (A. D.)

RICHELIEU, ARMAND EMMANUEL SOPHIE SEPTE-MANIE DU PLESSIS, DUC DE (1766-1822), French statesman, was born in Paris on the 25th of September 1766, the son of Louis Antoine du Plessis, duc de Fronsac and grandson of the marshal de Richelieu (1696-1788). The comte de Chinon, as the heir to the Richelieu honours was called, was married at fifteen to Rosalie de Rochechouart, a deformed child of twelve, with whom his relations were never more than formal. After two years of foreign travel he entered the Queen's dragoons and next year received a place at court, where he had a reputation for Puritan austerity. He left Paris in 1790 for Vienna, and in company with his friend Prince Charles de Ligne joined the Russian army as a volunteer, reaching the Russian headquarters at Bender on the 21st of November. He was present at the capture of Ismailia and received from the empress Catherine the cross of St George and a golden sword. By the death of his father in February 1791, he succeeded to the title of duc de Richelieu. He returned to Paris shortly afterwards on the summons of Louis XVI., but he was not sufficiently in the confidence of the court to be informed of the projected flight to Varennes. In July he obtained a passport from the National Assembly for service in Russia. In the Russian army he obtained the grade of general-major, only to be forced by the intrigues of his enemies to resign. The accession of Alexander I. brightened his prospects. His erasure from the list of *émigrés*, which he had failed to secure from Napoleon, was accorded on the request of the Russian government, and in 1803 he became governor of Odessa. Two years later he became governor general of the Chersonese, of Ekaterinoslav and the Crimea, then called New Russia. In the eleven years of his administration, Odessa rose from a miserable village to an important city. He commanded a division in the Turkish War of 1806-7, and was engaged in frequent expeditions to the Caucasus.

Richelieu returned to France in 1814; on the triumphant return of Napoleon from Elba he accompanied Louis XVIII. in his flight as far as Lille, whence he went to Vienna to join the Russian army, believing that he could best serve the interests of the monarchy and of France by attaching himself to the headquarters of the emperor Alexander. Richelieu's character and antecedents alike marked him out as valuable support of the monarchy after its second restoration. Though the bulk of his confiscated estates were lost beyond recall, he did not share the resentment of the mass of the returned *émigrés*, from whom and their intrigues he had held aloof during his exile, and was far from sharing their delusions as to the possibility of undoing the work of the Revolution. As the personal friend of the Russian emperor his influence in the councils of the Allies was likely to be of great service. He refused, indeed, Talleyrand's offer of a place in his ministry, pleading his long absence from France and ignorance of its conditions; but after Talleyrand's retirement he consented to follow him as prime minister, though—as he himself said—he did not know the face of one of his colleagues.

The events of Richelieu's tenure of office are noticed elsewhere (see FRANCE: History). Here it need only be said that it was mainly due to his efforts that France was so early relieved of the burden of the allied army of occupation. It was for this purpose mainly that he attended the congress of Aix-la-Chapelle in 1818. There he had been informed in confidence of the renewal by the Allies of their treaty binding them to interfere in case of a renewal of revolutionary trouble in France; and it was partly owing to this knowledge that he resigned office in December of the same year, on the refusal of his colleagues to support a reactionary modification of the electoral law. After the murder of the duc de Berry and the enforced retirement of Decazes, he again became president of the council (21st February 1821); but his position was untenable owing to the attacks of the "Ultras" on the one side and the Liberals on the other, and on the 12th of December he again resigned. He died of apoplexy on the 17th of May 1822.

Great part of Richelieu's correspondence with Pozzo di Borgo, Capo d'Istria and others, with his journal of his travels in Germany and the Turkish campaign, and a notice by the duchesse de Richelieu, is published by the Imperial Historical Society of Russia, vol. 54. There is an exhaustive study of his career by L. de Crousaz-Crétet, *Le Duc de Richelieu en Russie et en France* (1897), with which compare an article by L. Rioult de Neuville in the *Revue des questions historiques* (Oct. 1897). See also R. de Cisternes, *Le Duc de Richelieu, son action aux conférences d'Aix-la-Chapelle* (1898), containing copies of documents.

RICHELIEU, ARMAND JEAN DU PLESSIS DE, CARDINAL (1585-1642), French statesman, was born of an ancient family of the lesser nobility of Poitou. The original name of the family was Du Plessis, but in the 15th century a younger branch obtained by marriage the estate of Richelieu with its strong castle surrounded by the waters of the Mable, and took the name of Du Plessis de Richelieu. The family produced not a few turbulent warriors during the Hundred Years' War, and the cardinal's father, François du Plessis, seigneur de Richelieu, began his career by killing the murderer of his elder brother and then fighting through the wars of religion, first as a favourite of Henry III., and after his death under Henry IV. He was a typical fighting gentleman of the period. The mother of the cardinal, Susanne de La Porte, belonged to a family of the magistrature, her father, François de La Porte, being one of the first advocates of the parlement of Paris. Armand was the third son and was born in Paris on the 9th of September 1585. When he was five years old his father died while assisting at the siege of Paris (on the 10th of July 1590); and his mother was left with five children and the estate heavily in debt. By care and economy, however, aided by generous royal grants, she was enabled to pay off mortgages and to bring up the children in a way befitting their rank. At the age of nine Armand was sent to Paris to the College of Navarre, where he passed with credit the regular courses in grammar and philosophy, and then entered a "finishing academy" which prepared the sons of nobles for the life of a courtier or a cavalier. But his training for a military career was suddenly cut short by the refusal of his elder brother, Alphonse, to accept the office of bishop of Luçon. The right of preferment to that see had been given to the Richelieu family by Henry III. as a reward for the services of Armand's father, and the family drained its revenues for private use. When the cathedral chapter found courage to oppose this and opened suit to recover the ecclesiastical revenues for ecclesiastical purposes, Richelieu's mother proposed to make her second son, Alphonse, bishop. He defeated this scheme, however, by becoming a monk of the Grande Chartreuse, and Armand, whose health was rather feeble in any case for a military career, was induced to propose himself for the priesthood.

In 1606, at the age of twenty-one, Richelieu was nominated bishop of Luçon by Henry IV. As he was almost five years under the canonical age, he was obliged to go to Rome to obtain a dispensation and was consecrated there in April 1607. In the winter of 1608 Richelieu went out to his poverty-stricken little bishopric, and for the next six years devoted himself seriously to his episcopal duties. He became favourably known among the zealous reformers of the church, and it was during this stage of his career that he made a friend of Father Joseph. Meanwhile he was impatiently waiting for an opening to a larger career. This came in 1614 when he was elected by the clergy of Poitou to the last States-general which met before the Revolution. In this he attracted the favourable attention of Marie de' Medici, the queen-mother, and was chosen at its close to present the address of the clergy embodying its petitions and resolutions. After the States-general was dissolved he remained in Paris, and the next year he became almoner to Anne of Austria, the child-queen of Louis XIII. Then, by adroit courtly intrigue and faithful service to Concini, he was appointed in 1616 a secretary of state to the king. But he owed all to Concini, and his taste of power ended with the murder of his patron on the 24th of August 1617.

The reign which Richelieu was to dominate so absolutely began

with his exile from the court. He had, however, already shown his ability, his firmness, and his diplomatic skill, and conducted the negotiations on the part of the queen-mother with Luynes, the king's representative. Then, as he had incurred too much of the odium of a creature of Concini to hope for royal favour, he resigned himself to the post of chief adviser to Marie de' Medici in her exile at Blois. Here he sought to ingratiate himself with Luynes and the king by reporting minutely the actions of Marie and by protestations of loyalty. As this ungrateful work brought no reward, Richelieu, in spite of the earnest entreaties of the queen-mother, retired once more to his bishopric. But the king, while approving his conduct, was still suspicious of him, and he was exiled to Avignon, along with his brother and brother-in-law, on the 7th of April 1618. There he lived in discreet, if melancholy retirement, writing "A Defence of the Main Principles of the Catholic Faith," and had apparently little hope of a further political career when the escape of Marie de' Medici from Blois, on the 22nd of February 1619, again opened paths for his ambition. Luynes and the king recalled him to the post at Angoulême with the queen-mother, who received him ungraciously but who soon yielded to his judgment and allowed him to sign the treaty of Angoulême with the Cardinal de la Rochefoucauld, acting for the king. By this treaty Marie was given liberty to live wherever she wished, and the government of Anjou and of Normandy with several castles was entrusted to her. The bishop of Luçon was led to believe that the king would recommend him for a cardinalate, but, if we may trust the evidence, Luynes secretly opposed the request, and it was not until after his death that Richelieu was made a cardinal by Pope Gregory XV., on the 5th of September 1621. His rank in the church was due to his skill in intrigue with Marie de' Medici.

Luynes's death on the 15th of December 1621 made possible a reconciliation a month later between the king and his mother. Although Louis still distrusted her at heart, and disliked her dominating minister more, he allowed her to take up her residence in the Luxembourg palace in Paris, thus rendering intercourse possible. Richelieu seized his opportunity. He furnished Marie de' Medici with political ideas and acute criticisms of the king's ministry, especially of the Brularts. Marie zealously pushed her favourite towards office, and had gone so far as to absent herself from court for three months on account of the king's persistent refusal, when Charles, duc de La Vieuville, then head of the council, in need of her aid in his negotiations with reference to the marriage of her daughter Henriette Marie, finally agreed to force Richelieu's appointment to office upon the king, Louis XIII. La Vieuville thought to compromise by forcing the cardinal into a "council of despatches," with merely the privilege of advising the king's council but entrusted with no power. Richelieu raised many objections to such a partial realization of his ambition, but the king ended them in April 1624 by naming him as a member of his council. By August Vieuville's worst fears were realized; he was arrested on the 13th of the month for corrupt practices in office, and the intriguing cardinal who had caused his overthrow became chief minister of Louis XIII. His advent was hailed with joy by both the Catholic party and the patriotic party, eager for the overthrow of Habsburg supremacy in Europe.

For the next eighteen years the biography of Richelieu is the history of France, and to a large degree that of Europe. His work was directed toward a twofold aim: to make the royal power—his power—absolute and supreme at home, and to crush the rival European power of the Habsburgs. At home there were two opponents to be dealt with: the Huguenots and the feudal nobility. The former were crushed by the siege of La Rochelle and the vigorous campaign against the duc de Rohan. But the religious toleration of the edict of Nantes was reaffirmed while its political privileges were destroyed, and Huguenot officers fought loyally in the foreign enterprises of the cardinal. The suppression of the independence of the feudal aristocracy was inaugurated in 1626 by an edict calling for the destruction of all fortified castles not needed for defence against invasion.

The local authorities proceeded to carry this out with a zeal due to long suffering, and the ruined medieval châteaux of France still bear witness to the action of Richelieu. Still there was no serious opposition to the new minister. The first serious conspiracy took place in 1626, the king's brother, Gaston of Orleans, being the centre of it. His governor, Marshal D'Ornano, was arrested by Richelieu's orders, and then his confidant, Henri de Talleyrand, marquis de Chalais and Vendôme, the natural sons of Henry IV. Chalais was executed and the marshal died in prison. The overthrow of the Huguenots in 1629 made Richelieu's position seemingly unassailable, but the next year it received its severest test. Marie de' Medici had turned against her "ungrateful" minister with a hatred intensified, it is said, by unrequited passion. In September 1630, while Louis XIII. was very ill at Lyons, the two queens, Marie and Anne of Austria, reconciled for the time, won the king's promise to dismiss Richelieu. He postponed the date until peace should be made with Spain. When the news came of the truce of Regensburg Marie claimed the fulfilment of the promise. On the 10th of November 1630 the king went to his mother's apartments at the Luxembourg palace. Orders were given that no one should be allowed to disturb their interview, but Richelieu entered by the unguarded chapel door. When Marie had recovered breath from such audacity she proceeded to attack him in the strongest terms, declaring that the king must choose between him or her. Richelieu left the presence feeling that all was lost. The king gave a sign of yielding, appointing the brother of Marillac, Marie's counsellor, to the command of the army in Italy. But before taking further steps he retired to Versailles, then a hunting lodge, and there, listening to two of Richelieu's friends, Claude de Saint-Simon, father of the memoir writer, and Cardinal La Valette, sent for Richelieu in the evening, and while the salons of the Luxembourg were full of expectant courtiers the king was reassuring the cardinal of his continued favour and support. The "Day of Dupes," as this famous day was called, was the only time that Louis took so much as a step toward the dismissal of a minister who was personally distasteful to him but who was indispensable. The queen-mother followed the king and cardinal to Compiègne, but as she refused to be reconciled with Richelieu she was left there alone and forbidden to return to Paris. The next summer she fled across the frontiers into the Netherlands, and Richelieu was made a duke. Then Gaston of Orleans, who had fled to Lorraine, came back with a small troop to head a rebellion to free the king and country from "the tyrant." The only great noble who rose was Henri, duc de Montmorenci, governor of Languedoc, and his defeat at Castelnaudary on the 1st of September 1632 was followed by his speedy trial by the parlement of Toulouse, and by his execution. Richelieu had sent to the block the first noble of France, the last of a family illustrious for seven centuries, the feudal head of the nobility of Languedoc; then, unmoved by threats or entreaties, inexorable as fate itself, he cowed all opposition by his relentless vengeance. He knew no mercy. The only other conspiracy against him which amounted to more than intrigue was that of Cinq Mars in 1642, at the close of his life. This vain young favourite of the king was treated as though he were really a formidable traitor, and his friend, De Thou, son of the historian, whose sole guilt was not to have revealed the plot, was placed in a boat behind the stately barge of the cardinal and thus conveyed up the Rhone to his trial and death at Lyons. The voyage was symbolical of Richelieu's whole pitiless career.

Richelieu's foreign policy was as inflexible as his home policy. To humble the Habsburgs he aided the Protestant princes of Germany against the emperor, in spite of the strong opposition of the disappointed Catholic party in France, which had looked to the cardinal as a champion of the faith. The year of Richelieu's triumph over the Huguenots (1629) was also that of the Emperor Ferdinand's triumph in Germany, marked by the Edict of Restitution, and France was threatened by a united Germany. Richelieu, however, turned against the Habsburgs young Gustavus Adolphus of Sweden, paying him a subsidy of a

million livres a year by the treaty of Bärwald of the 23rd of January 1631. The dismissal of Wallenstein, which is often attributed to the work of Father Joseph, Richelieu's envoy to the diet of Regensburg in July and August of 1630, was due rather to the fears of the electors themselves, but it was of double value to Richelieu when his Swedish ally marched south. After the treaty of Prague, in May 1635, by which the emperor was reconciled with most of the German princes, Richelieu was finally obliged to declare war, and, concluding a treaty of offensive alliance at Compiègne with Oxenstierna, and in October one at St Germain-en-Laye with Bernard of Saxe-Weimar, he proceeded himself against Spain, both in Italy and in the Netherlands. The war opened disastrously for the French, but by 1642, when Richelieu died, his armies—risen from 12,000 men in 1621 to 150,000 in 1638—had conquered Roussillon from Spain; they held Catalonia, which had revolted from Philip IV. of Spain, and had taken Turin and forced Savoy to allow French troops on the borders of the Milanese. In Germany Torstensson was sweeping the imperialist forces before him through Silesia and Moravia. The lines of the treaty of Westphalia, six years later, were already laid down by Richelieu; and its epochal importance in European history is a measure of the genius who threw the balance of power from Habsburg to Bourbon. The predominance of Louis XIV. in European politics was largely due to the statesman who prepared France for his absolutism at home.

The magnitude of Richelieu's achievement grows when one considers his relations with the king. Louis XIII. cordially disliked him, and would gladly have got rid of him if he had not been able to convince the king of the wisdom of everything he did. Thus obliged to assume the unpleasant rôle of tutor when delicate flattery was often most needful, the minister lectured and cajoled his master, always, until towards the last, giving credit to the king for his own successes, and over-awing opposition by his imperious presence even when Louis was dabbling in plots against him (as in the case of Cinq Mars) behind his back. The king's consciousness of his weakness was combined with a sense of duty, and it was upon these two chords that Richelieu played. Besides, he was eternally on the alert. Spies in every salon in Paris and every court in Europe kept the grim courtier informed of every change in his master's disposition and every intrigue against himself. The piquant comments of his platonic friend, Mademoiselle de Hautefort, upon Richelieu were relished by the king until he was informed of others said to have been made by her upon himself. Then it was easy to supplant her with another favourite, Mademoiselle de Lafayette. When this devout maiden began to denounce the ungodly cardinal who was allied with heretics, her confessor—in Richelieu's service—succeeded in inducing her to become a nun. Father Causin, the king's confessor, ventured the same comments, and Louis plotted like a schoolboy to turn his devotions into secret criticisms of state policies. Causin was sent into Brittany, and the judicious and learned Jesuit, Jacques Sirmond, who succeeded him, kept clear of politics. Such was the atmosphere of the court in which Richelieu had to maintain his authority.

His own personality was his strongest ally. The king himself quailed before that stern, august presence. His pale, drawn face was set with his iron will. His frame was sickly and wasted with disease, yet when clad in his red cardinal's robes, his stately carriage and confident bearing gave him the air of a prince. His courage was mingled with a mean sort of cunning, and his ambition loved the outward trappings of power as well as its reality; yet he never swerved from his policy in order to win approbation, and the king knew that his one motive in public affairs was the welfare of the realm—that his religion, in short, was "reason of state." A clear conscience, not less than a sense of his own superiority to others at the court of Louis XIII., made the cardinal haughtily assert his ascendancy, and the king shared his belief in both.

No courtier was ever more assertive of his prerogatives. He claimed precedence over even princes of the blood, and one

like Condé was content to draw aside the curtains for him to pass, and to sue for the hand of Richelieu's niece for his son, the "Great Condé." His pride and ambition were gratified by the foundation of a sort of dynasty of his nephews and nieces, whose hands were sought by the noblest in the realm. Like all statesmen of his time, Richelieu made money out of politics. He came to court in 1617 with an income of 25,000 livres from his ecclesiastical benefices. In the later years of his life it exceeded 3,000,000 livres. He lived in imperial state, building himself the great Palais Cardinal, now the Palais Royal, in Paris, another at Rueil near Paris, and rebuilding his ancestral château in Poitou. His table cost him a thousand crowns a day, although he himself lived simply. He celebrated his triumphs to the full with gorgeous fêtes in his palace, especially with lavish theatrical representations. In January 1641 the tragedy of *Mirame*, said to have been his own, was produced with great magnificence. Richelieu was anxious for literary fame, and his writings are not unworthy of him. But more important than his own efforts as an author were his protection and patronage of literary men, especially of Corneille, and his creation of the French Academy in 1635. His influence upon French literature was considerable and lasting. Hardly less important was his rebuilding of the Sorbonne and his endowments there. When he died, on the 4th of December 1642, he was buried in the chapel of the Sorbonne, which still stands as he built it. His tomb, erected in 1694, though rifled at the Revolution, still exists.

Many writings are attributed to Richelieu, although owing to his habit of working with substitutes and assistants it is difficult to settle how much of what passes under his name is authentic. *Les Thuilleries*, *La Grande Pastorale*, *Mirame*, and the other plays, over whose fate he trembled as over the result of an embassy or a campaign, have long been forgotten; but a permanent interest attaches to his *Mémoires* and correspondence: *Mémoire d'Armand du Plessis de Richelieu, évêque de Luçon, écrit de sa main, en l'année 1609 ou 1610, alors qu'il méditait de paraître à la cour*, edited by Armand Baschet (1880); *Histoire de la mère et du fils* (i.e. of Marie de Medici and Louis XIII.), sometimes attributed to Mézeray, published at Amsterdam in 1730 and, under the title *Histoire de la régence de reine Marie de Médicis, femme de Henry IV.*, at the Hague in 1743; *Mémoires sur le règne de Louis XIII.*, extending from 1610 to 1638, and of which the earlier portion is a reprint of the *Histoire de la mère et du fils*, published in Petitot's collection (Paris, 1823 seq.); *Testament politique d'Armand du Plessis, cardinal de Richelieu* (Amsterdam, 1687 seq.); *Journal de 1630-31* (Paris, 1645); "Lettres, instructions diplomatiques, et papiers d'état," published by G. d'Avenel in the *Coll. de doc. inéd.* (Paris, 1853-77); and "Maximes d'état et fragments politiques," published by G. Hanotaux in *Mélanges historiques: Choix de doc. iii.*, in the same collection.

See G. Hanotaux, *Cardinal Richelieu* (1893), one volume of the four then promised, an exhaustive history of the period down to 1614; and G. d'Avenel, *Richelieu et la monarchie absolue* (4 vols., 1895). The most important sources for Richelieu's statesmanship are the "Lettres, instructions diplomatiques, et papiers d'état," mentioned above, and Richelieu's *Mémoires* (1610-38) may be consulted in Petitot's 410 J. F. Michaud and J. Poujoulat's collections. Innumerable memoirs of the time also bear upon his life, e.g. those of Madame de Motteville, Mathieu Molé, De Brienne, and Bassompierre. In English there are short biographies by Richard Lodge (in the Foreign Statesmen series, 1896) and by J. B. Perkins (in *Heroes of the Nations* series, 1900). (J. T. S.)*

RICHELIEU, LOUIS FRANÇOIS ARMAND DU PLESSIS, DUC DE (1606-1788), marshal of France, was a grandnephew of Cardinal Richelieu, and was born in Paris on the 13th of March 1696. Apart from his reputation as a man of exceptionally loose morals, he attained, in spite of a deplorably defective education, distinction as a diplomatist and general. As ambassador to Vienna (1725-29) he settled in 1727 the preliminaries of peace; in 1733-34 he served in the Rhine campaign. His real public career began ten years later. He fought with distinction at Dettingen and Fontenoy, where he directed the grapeshot upon the English columns, and three years afterwards he made a brilliant defence of Genoa; in 1756 he expelled the English from Minorca by the capture of the San Felipe fortress; and in 1757-58 he closed his military career by those pillaging campaigns in Hanover which procured him the sobriquet of *Petit Père de la Marouée*. After the wars he plunged again into court intrigue, favoured

the comtesse du Barry and supported his nephew the duc d'Aiguillon. Louis XVI., however, was not favourably inclined to him. In his early days he was thrice imprisoned in the Bastille: in 1711 at the instance of his stepfather, in 1716 in consequence of a duel, and in 1719 for his share in Alberoni's conspiracy against the regent Orleans. He was thrice married: first, against his will, at the age of fourteen to Anne Catherine de Noailles; secondly, in 1734, by the intrigues (according to the witty Frenchman's own account) of Voltaire, to Marie Elisabeth Sophie, Mademoiselle de Guise; and thirdly, when he was eighty-four years old, to an Irish lady. He died in Paris on the 8th of August 1788. Marshal Richelieu's *Mémoires*, published by J. L. Soulaive in nine volumes (1790), are partially spurious.

See H. Noel Williams, *The Fascinating Duc de Richelieu* (1910). **RICHEPIN, JEAN** (1849—), French poet, novelist and dramatist, the son of an army doctor, was born at Medea (Algeria) on the 4th of February 1849. At school and at the École normale he gave evidence of brilliant, if somewhat undisciplined, powers, for which he found physical vent in different directions—first as a *franco-tireur* in the Franco-German War, and afterwards as actor, sailor and stevedore—and an intellectual outlet in the writing of poems, plays and novels which vividly reflected, his erratic but unmistakable talent. A play, *L'Étoile*, written by him in collaboration with André Gill (1840-1885), was produced in 1873; but Richepin was virtually unknown until the publication, in 1876, of a volume of verse entitled *Chanson des gueux*, when his outspokenness resulted in his being imprisoned and fined for *outrage aux mœurs*. The same quality has characterized his succeeding volumes of verse: *Les Coresses* (1877), *Les Blasphèmes* (1884), *La Mer* (1886), *Mes paradis* (1894), *La Bombarde* (1899). His novels have been developed in style from the morbidity and brutality of *Les Morts bizarres* (1876), *La Glu* (1881) and *Le Pape* (1883) to the more thoughtful psychology of *Madame André* (1878), *Sophie Monnier* (1884), *Césaire* (1888), *L'Aimé* (1893), *Grandes amoureuses* (1896) and *Logibasse* (1899), and the more simple portrayal of life in *Miarika* (1883), *Les Braves Gens* (1886), *Truandailles* (1890), *La Miseloque* (1892) and *Flamboche* (1895). His plays, though occasionally marred by his characteristic proneness to violence of thought and language, constitute in many respects his best work. The most notable are *Nana Sahib* (1883), *Monsieur Scopin* (1886), *Le Filibustier* (1888), *Pur gloire* (1892), *Vers la joie* (1894), *Le Chemineau* (1897), *Le Chien de garde* (1898), *Les Truands* (1899), *Don Quichotte* (1905), most of which were produced at the Comédie française. He also wrote *Miarika* (1905), adapted from his novel, for the music of Alexandre Georges, and *Le Mage* (1897) for the music of Jules Massenet.

His son, Jacques Richepin (b. 1880), the author of *La Reine de Tyr* (1899), *La Cavalière* (1901), *Cadet-Roussel* (1903) and *Falstaff* (1904), based on Shakespeare's *Henry IV.*, gave promise of making his mark as a dramatist.

RICHERUS, monk of St Remi at Reims, and a chronicler of the 10th century, son of Rodulf, a trusty councillor and captain of Louis IV. He studied at Reims under Gerbert, afterwards Pope Silvester II., who taught him mathematics, history, letters and eloquence. He was also well versed in the medical science of his time, and in 991 travelled to Chartres to consult the medical MSS. there. He was still living in 998, but there is no mention of him after that date. In spite of his violent partisanship,—for Richerus was an ardent upholder of the Carolings and French supremacy,—of great defects of style, and of an utter disregard of accuracy and truth, his *Historiae* has a unique value as giving us the only tolerably full account by a contemporary of the memorable revolution of 987, which placed the Capets on the throne of France. The *History*, in four books, begins with Charles the Fat and Eudes, and goes down to the year 995. From 969 onwards Richerus had no earlier history before him, and his work is the chief source for the period. It was first edited in Pertz's *Monumenta Germaniae*, vol. iii.

306 RICHFIELD SPRINGS—RICHMOND, EARLS AND DUKES OF

There are French translations by Guadet (Paris, 1845, Soc. de l'hist. de France); Poinsongn (Reims, 1855, pub. de l'Académie de Rheims); and a German version by K. Freiherr v. der Osten-Sacken (Berlin 1854). Cf. Molinier, *Sources de l'histoire de France*, i. 284 (ed. 1901).

RICHFIELD SPRINGS, a village of Richfield township, Otsego county, New York, U.S.A., about 22 m. S.E. of Utica and $\frac{1}{2}$ m. N. of Schuyler (or Candarago) lake. Pop. (1890) 1623; (1900) 1537; (1905) 1684; (1910) 1503. It is served by the Delaware, Lackawanna & Western railway, and by the Oneonta & Mohawk Valley electric line connecting with the New York Central railway at Herkimer. The village is situated in a farming country, about 1700 ft. above sea-level. Knit goods are manufactured, but the importance of the place is due to its sulphur springs, the waters of which are used for the treatment of skin diseases, gout, rheumatism, etc., and to the tonic air and fine scenery. In 1908 a Welsh eisteddfod was held here in Earlington Park. The first hotels were built between 1820 and 1830. A post office was established here in 1820, and the village was incorporated in 1861.

RICH HILL, a city of Bates county, Missouri, U.S.A., situated near the Osage (Marais des Cygnes) river, in the west central part of the state, about 75 m. S. by E. of Kansas City. Pop. (1900) 4033, of whom 255 were foreign-born; (1910) 2755. It is served by the Missouri Pacific and the St. Louis & San Francisco railway systems. The city has two public parks, and is a trading centre for the surrounding fertile farming country. Coal is mined in the vicinity. There are lead and zinc smelters, and a large vitrified brick and tile factory. The municipality owns and operates its waterworks and gas and electric-lighting plants; the city is supplied with natural gas. The original Rich Hill was platted in 1867 somewhat north-west of the site of the present city, which was platted in 1880 by an association that bought out the old settlement. The new settlement was incorporated as a village in 1880, and chartered as a city in 1881.

RICHMOND, EARLS AND DUKES OF. The title earl of Richmond appears to have been in existence in England a considerable time before it was held in accordance with any strict legal principle. Alan, surnamed "Le Roux," and his brother Alan (c. 1040-1089), surnamed "Le Noir," relatives of Geoffrey, count of Brittany, and kinsman of William the Conqueror, took part in the latter's invasion of England; and Le Roux obtained grants of land in various parts of England, including manors formerly held by Earl Edwin in Yorkshire, on one of which he built the castle of Richmond, his possessions there being formed into the honour of Richmond, to which his brother Alan Le Noir, or Alan Niger (c. 1045-1093), succeeded in 1089. The latter was in turn succeeded as lord of the honour of Richmond by Stephen (d. 1137), count of Penthièvre, who was either his son or another brother. These Breton counts, being territorial barons of great importance in England, and lords of the honour of Richmond where their castle was situated, are often reckoned as earls of Richmond, though they were not so in the strict and later sense. The same should perhaps be said of Stephen's son Alan Niger II. (c. 1116-1146), though he was styled earl of Richmond by John of Hexham. This Alan married Bertha, daughter and heiress of Conan, reigning count of Brittany; and his son Conan (c. 1138-1171), who married Margaret, sister of Malcolm IV. of Scotland, asserted his right to Brittany, and transferred it in his lifetime to his daughter Constance (c. 1162-1201). As he left no sons the honour of Richmond and his other English possessions passed to the king in 1171, though Constance is also loosely spoken of as countess of Richmond in her own right. Constance was three times married, and each of her husbands in turn assumed the title of earl of Richmond, in conjunction with that of count, or duke of Brittany. They were: Geoffrey Plantagenet (1158-1186), son of Henry II., king of England; Randolph de Blundevill, earl of Chester (c. 1172-1232), the marriage with whom Constance treated as null on the ground of consanguinity; and Guy de Thouars (d. 1213), who survived his wife for twelve

years. The only son of the first marriage, Arthur of Brittany (1187-1203), was styled earl of Richmond in his mother's lifetime, and on his murder at the hands of his uncle, King John, the earldom was resumed by the crown.

By her third husband Constance had two daughters, the elder of whom, Alice, was given in marriage by Philip Augustus, king of France, to Peter de Braine in 1213, after which date Peter was styled duke of Brittany and earl of Richmond till about 1235, when he renounced his allegiance to the king of England and thereupon suffered forfeiture of his English earldom.

In 1241 Henry III. granted the honour of Richmond to Peter of Savoy (1203-1268), uncle of Queen Eleanor, who was thereafter described as earl of Richmond by contemporary chroniclers, though how far he was strictly entitled to the designation has been disputed. By his will he left the honour of Richmond to his niece, the queen consort, who transferred it to the crown. In the same year (1268) Henry III. granted the earldom specifically to John, duke of Brittany (1217-86), son of Peter de Braine, in whose family the title continued—though it frequently was forfeited or reverted to the crown and was re-granted to the next heir—till 1342, when it was apparently resumed by Edward III. and granted by that sovereign to his son John of Gaunt, who surrendered it in 1372. It was then given to John de Montfort, duke of Brittany, but on his death without heirs in 1399, or possibly at an earlier date through forfeiture, it reverted to the crown. The earldom now became finally separated from the duchy of Brittany, with which it had been loosely conjoined since the Conquest, although the dukes of Brittany continued to assume the title till a much later date. From 1414 to 1435 the earldom of Richmond was held by John Plantagenet, duke of Bedford, and in 1453 it was conferred on Edmund Tudor, uterine brother to King Henry VI., whose wife, Margaret Beaufort, was the foundress of St John's College, Cambridge, and of the "Lady Margaret" professorships of divinity at Oxford and Cambridge (see RICHMOND AND DERBY, MARGARET, COUNTESS OF). When Edmund Tudor's son Henry ascended the throne as Henry VII. in 1485, the earldom of Richmond merged in the crown, and for the next forty years there was no further grant of the title; but in 1525 Henry Fitzroy, natural son of Henry VIII. by Elizabeth Blount, was created duke of Richmond and Somerset and earl of Nottingham, all these titles becoming extinct at his death without children in 1536.

Ludovic Stuart, 2nd duke of Lennox (1574-1624), who also held other titles in the peerage of Scotland, was created earl of Richmond in 1613 and duke of Richmond in 1623. These became extinct at his death in 1624, but his Scottish honours devolved on his brother Esmé, who was already earl of March in the peerage of England (see MARCH, EARLS OF; and LENNOX). Esmé's son, James, 4th duke of Lennox (1612-1655), was created duke of Richmond in 1641, the two dukedoms as well as the lesser English and Scottish titles thus becoming again united. In 1672, on the death of his nephew Charles, 3rd duke of Richmond and 6th duke of Lennox, whose wife was the celebrated beauty called "La Belle Stuart" at the court of Charles II. (see RICHMOND AND LENNOX, FRANCES TERESA, DUCHESS OF), his titles became extinct.

In 1675 Charles II. created his illegitimate son Charles duke of Richmond, earl of March and baron Settrington, and a few weeks later duke of Lennox, earl of Darlington and baron Torbolton. This Charles (1672-1723), on whom his father the king bestowed the surname of Lennox, was the son of the celebrated Louise de Keroualle, duchess of Portsmouth. His son Charles, 2nd duke (1701-1750), added to the titles he inherited from his father that of duke of Aubigny in France, to which he succeeded in 1734 on the death of his grandmother the duchess of Portsmouth; and all these honours are still held by his descendant the present duke of Richmond.

The seven dukes of Richmond of the Lennox line have all borne the Christian name of Charles. The 2nd duke, by his marriage with Sarah, daughter of the 1st Earl Cadogan, was father of Lady Caroline Lennox, who eloped with Henry Fox,

and was the mother of Charles James Fox, and of the beautiful Lady Sarah Lennox (1745-1826) with whom George III. fell in love and contemplated marriage, and who afterwards married, first, Sir Thomas Bunbury, from whom she was divorced, and secondly, George Napier, by whom she was the mother of Generals Sir Charles and Sir William Napier.

Charles, 3rd duke of Richmond (1735-1806), was one of the most remarkable men of the 18th century, being chiefly famous for his advanced views on the question of parliamentary reform. Having succeeded to the peerage in 1750, he was appointed British ambassador extraordinary in Paris in 1765, and in the following year he became a secretary of state in the Rockingham administration, resigning office on the accession to power of the earl of Chatham. In the debates on the policy that led to the War of American Independence Richmond was a firm supporter of the colonists; and he initiated the debate in 1778 calling for the removal of the troops from America, during which Chatham was seized by his fatal illness. He also advocated a policy of concession in Ireland, with reference to which he originated the phrase "a union of hearts" which long afterwards became famous when his use of it had been forgotten. In 1779 the duke brought forward a motion for retrenchment of the civil list; and in 1780 he embodied in a bill his proposals for parliamentary reform, which included manhood suffrage, annual parliaments and equal electoral areas. Richmond sat in Rockingham's second cabinet as master-general of ordnance; and in 1784 he joined the ministry of William Pitt. He now developed strongly tory opinions, and his alleged desertion of the cause of reform led to a violent attack on him by Lauderdale in 1792, which nearly led to a duel between the two noblemen. Richmond died in December 1806, and, leaving no legitimate children, he was succeeded in the peerage by his nephew Charles, son of his brother, General Lord George Henry Lennox.

The 4th duke (1764-1819) and his wife Charlotte, daughter of the 4th duke of Gordon, were the givers of the famous ball at Brussels on the night before the battle of Quatre Bras, immortalized in Byron's *Child Harold*. Their son, the 5th duke (1791-1860), while still known by the courtesy title of earl of March, served on Wellington's staff in the Peninsula, being at the same time member of parliament for Chichester. He was afterwards a vehement opponent in the House of Lords of Roman Catholic emancipation, and at a later date a leader of the opposition to Peel's free trade policy. In 1836, on inheriting the estates of his maternal uncle, the 5th and last duke of Gordon, he assumed the name of Gordon before that of Lennox. On his death in 1860 he was succeeded in his titles by his son Charles Henry, 6th duke of Richmond (1818-1903), a statesman who held various cabinet offices in the Conservative administrations of Lord Derby, Disraeli and the marquis of Salisbury; and who in 1876 was created earl of Kinrara and duke of Gordon. These honours in addition to the numerous family titles of more ancient creation passed on his death in 1903 to his son Charles Henry Gordon-Lennox (b. 1845), 7th duke of Richmond and Lennox and 2nd duke of Gordon.

See Sir Robert Douglas, *The Peerage of Scotland*, edited by Sir J. B. Paul; G. E. C., *Complete Peerage*, vol. vi. (London, 1895); Lady Elizabeth Cust, *Some Account of the Stuarts of Aubigny in France* (London, 1801). For the dukes of the creation of 1675 see also, Anthony Hamilton, *Memoirs of Grammont*, edited by Sir W. Scott, new edition (2 vols., London, 1885); Horace Walpole, *Letters*, edited by P. Cunningham (9 vols., London, 1801), and *Memoirs of the Reign of George III.*, edited by G. F. R. Barker (4 vols., London, 1894); the earl of Albemarle, *Memoirs of Rockingham and his Contemporaries* (2 vols., London, 1852); *The Grenville Papers*, edited by W. J. Smith (4 vols., London, 1852); Earl Stanhope, *Life of William Pitt* (4 vols., London, 1861); Lord Edmond Fitzmaurice, *Life of William Earl of Shelburne* (3 vols., London, 1875); the duke of Richmond, *The Right of the People to Universal Suffrage and Annual Parliaments* (London, 1817), being an edition of the 3rd duke's famous "Letter to Lieut.-Colonel Sharrman," originally published in 1783; Lord William Pitt Lennox, *Memoir of Charles Gordon-Lennox, 5th Duke of Richmond* (London, 1862). (R. J. M.)

RICHMOND, LEGH (1772-1827), English divine, was born on the 29th of January 1772, at Liverpool. He was educated at Trinity College, Cambridge, and in 1798 was appointed to

the joint curacies of Brading and Yaverland in the Isle of Wight. He was powerfully influenced by William Wilberforce's *Practical View of Christianity*, and took a prominent interest in the British and Foreign Bible Society, the Church Missionary Society and similar institutions. In 1805 he became assistant-chaplain to the Lock Hospital, London, and rector of Turvey, Bedfordshire, where he remained till his death on the 8th of May 1827. The best known of his writings is *The Dairyman's Daughter*, of which as many as four millions in nineteen languages were circulated before 1849. A collected edition of his stories of village life was first published in 1814 under the title of *Annals of the Poor*. He also edited a series of Reformation biographies called *Fathers of the English Church* (1807-12).

See *Memoirs* by T. S. Grimshawe (1828); *Domestic Portraits* by T. Fry (1833).

RICHMOND, SIR WILLIAM BLAKE (1842-), English painter and decorator, was born in London on the 20th of November 1842. His father, George Richmond, R.A. (1809-1896), himself the son of a successful miniature painter, was a distinguished artist, who painted the portraits of the most eminent people of his day, and played an important part in society. At the age of fourteen William Richmond entered the Royal Academy schools, where he worked for about three years. A visit to Italy in 1859 gave him special opportunity for studying the works of the old masters, and had an important effect upon his development. His first Academy picture was a portrait group (1861); and to this succeeded, during the next three years, several other pictures of the same class. In 1865 he returned to Italy, and spent four years there, living chiefly at Rome. To this period belongs the large canvas, "A Procession in Honour of Bacchus," which he exhibited at the Academy in 1869 when he came back to England. His picture, "An Audience at Athens," was exhibited at the Grosvenor Gallery in 1885. He became Slade professor at Oxford, succeeding Ruskin, in 1878, but resigned three years later. He was elected an Associate of the Royal Academy in 1888 and Royal Academician in 1895; he received the degree of D.C.L. in 1896, and a knighthood of the Bath in 1897, and became professor of painting to the Royal Academy. Apart from his pictures, he is notable for his work in decorative art, his most conspicuous achievement being the internal decoration and the glass mosaics of St Paul's Cathedral. Sir William Richmond also took a keen interest in social questions, particularly in smoke-prevention in London.

RICHMOND, a city of Bourke county, Victoria, Australia, 2 m. S.E. of and suburban to Melbourne. It is one of the pleasantest of the metropolitan suburbs, having numerous parks and public gardens. There are a number of prosperous industries in the city. Pop. (1901) 37,722.

RICHMOND, a city and the county-seat of Wayne county, Indiana, U.S.A., on the E. branch of the Whitewater river, about 68 m. E. of Indianapolis. Pop. (1890) 16,608; (1900) 18,226, of whom 1467 were foreign-born and 1009 negroes; (1910 census) 22,324. It is served by the Chicago, Cincinnati & Louisville, the Grand Rapids & Indiana and the Pittsburg, Cincinnati, Chicago & St Louis railways, and by the Terre Haute, Indianapolis & Eastern and the Ohio electric interurban railways. Richmond has broad well-shaded streets, several parks, including Glen Miller (139 acres), and handsome public buildings. Its public institutions include the Morrison-Reeves (public) Library (1864), one of the largest (39,000 volumes in 1909) and oldest in the state, an art gallery, the Reid Memorial Hospital, a Home for Friendless Women, the Margaret Smith Home for Aged Women (1888), the Wernle Orphans' Home (1879; Evangelical Lutheran), and the Eastern Indiana Hospital for the Insane (1890). Just west of the city limits is **Earham College** (co-educational), opened in 1847, chartered in 1859 and controlled by the Society of Orthodox Friends; in 1908-9 it had 30 instructors, 620 students and a library of 18,000 bound volumes. Richmond was for many years the centre, west of Philadelphia, of the activities of the Society of Friends. It is an important railway and commercial centre,

trade in hardware being especially large. Among its manufactures are agricultural machinery (especially seeding machines) and tools, automobiles, pianos, lawn-mowers, roller-skates, foundry and machine-shop products, furniture, burial caskets, and flour. In 1905 its factory product was valued at \$6,731,740, an increase of 41.6% since 1900. Pipe lines supply the city with natural gas. The municipality owns and operates the electric-lighting plant. In 1806 Friends from North Carolina and Pennsylvania settled near here, and Richmond was platted in 1816. Its growth was slow until the opening of the National Road, which entered Indiana near the city, and the construction of railways. Richmond was incorporated as a village in 1818 and chartered as a borough in 1834 and as a city in 1840.

RICHMOND, a city and the county-seat of Madison county, Kentucky, U.S.A., about 95 m. S.E. of Louisville. Pop. (1890) 5073; (1900) 4653, of whom 2087 were negroes; (1910) 5340. It is served by the Louisville & Atlantic and the Louisville & Nashville railways. It is situated in the "Blue Grass Region," near the foothills of the Cumberland Mountains. It is the seat of Madison Institute for girls (1856) and of the Eastern Kentucky State Normal School (1906). From 1874 to 1901 it was the seat of Central University, which in the latter year was consolidated with Centre College at Danville, Ky. (q.v.). The surrounding country is devoted largely to the cultivation of tobacco, Indian corn and wheat, and the breeding of fine horses and cattle; and Richmond is an important live-stock market. Among the manufactures are bricks, flour, tobacco and cigars, and carriages. On the 30th of August 1862 a Confederate force of about 7000 men under General Edmund Kirby Smith won a decisive victory here over a Union force of a nearly equal number under Generals Mahlon D. Manson (1820-1895) and William Nelson.

RICHMOND, a municipal borough in the Kingston parliamentary division of Surrey, England, 9 m. W.S.W. of Charing Cross, London. Pop. (1891) 26,875; (1901) 31,672. It lies on the right bank of the Thames, which is here crossed by a bridge carrying the road to Twickenham. Through its pleasant situation Richmond has grown into a large residential suburb of the metropolis. The town was anciently called *Syenes* and afterwards *Schene* and *Sheen* (a name preserved in the village of East Sheen, adjacent on the London side) until the name was in 1500 changed to Richmond by command of Henry VII., who was earl of Richmond in Yorkshire. It grew up round the royal manor house, which became a frequent residence of sovereigns, but of which nothing more than a gateway remains. Edward I. received the Scotch commissioners at his manor of Sheen in 1300. The palace was rebuilt by Edward III., who died here in 1377. It was frequently used by Richard II., and here his wife Anne of Bohemia died, upon which he cursed the place and "caused it to be thrown down and defaced." By Henry V., however, it was rebuilt, and a great tournament was held here in 1492 by Henry VII., who after its destruction by fire in 1498 restored it. Henry VIII. gave it to Wolsey to reside in, after the latter presented him with the new palace of Hampton Court. James I. settled it on his son Henry, prince of Wales, who restored and embellished it at great expense. Charles I. added to it the new deer park generally known as Richmond Park, 2253 acres in extent, which is surrounded by a wall 11 m. in length. After the execution of the king, the parliament presented the park to the citizens of London, who again presented it to Charles II. at the Restoration. Though partly dismantled, the palace was the residence of the queen dowager till 1665, and by James II. it was used as a nursery for the young prince; but, gradually falling into decay, it was parcelled into tenements about 1720. In the old deer park extending northwards from the site of the palace, Kew Observatory was erected in 1769, occupying the site of a Carthusian convent founded by Henry V., and a dwelling-house in which Swift for some time resided. The White Lodge was built by George I., and has been a residence of various members of the royal family. To the south-east of the town, at the entrance to Richmond Park, is Richmond Hill, from which is seen a

famous view of the Thames with the surrounding country to the west. This view was secured to the public by an agreement, sealed on the 7th of February 1896, between the corporation and the trustees of the earl of Dysart, by an act of Parliament of 1902, and by the acquisition in the same year, by the London County Council, with the assistance of the borough of Richmond and other interested local authorities, of the Marble Hill Estate and other property on the Middlesex shore. The church of St Mary Magdalen is of considerable antiquity, but almost entirely rebuilt; it contains a large number of monuments to celebrated persons. A theatre, first established in 1719, was during his later years leased by Edmund Kean. The town has a Wesleyan theological college, founded in 1834. Richmond, which was incorporated in 1890, is governed by a mayor, 10 aldermen and 30 councillors. The borough includes Kew (q.v.), Petersham and North Sheen. Area, 2401 acres.

RICHMOND, a market town and municipal borough in the Richmond parliamentary division of the North Riding of Yorkshire, England, 50 m. N.W. from York, the terminus of a branch of the North-Eastern railway. Pop. (1901) 3837. It is finely situated on the left bank of the Swale, the valley of which is narrow and the banks steep. The interest of the town centres in the castle founded about 1071 by Alan Rufus, a son of Odo, count of Ponthièvre in Brittany, who is also said to have rebuilt the town on obtaining from William the Conqueror, among other possessions, the estates of the Saxon earl Edwin, embracing some two hundred manors of Richmond and extending over nearly a third of the North Riding. This tract, comprising five wapentakes, was called Richmondshire at this time, but the date of the creation of the shire is uncertain. When Henry VII. came to the throne these possessions reverted to the crown. Henry VIII. gave them to his son Henry, afterwards duke of Richmond, by a daughter of Sir John Blount, and Charles II. bestowed the title of duke of Richmond on his son by the duchess of Portsmouth. The castle is situated on a perpendicular rock rising about 100 ft. above the Swale, and from its great strength was considered impregnable. Originally it covered an area of 5 acres, but the only portions of it remaining are the Norman keep, with pinnacled tower and walls 100 ft. high by 11 ft. thick, and some other smaller towers. The view from the keep is very fine, extending westward up the bold valley and over the hills which wall it, and eastward over the rich plain of the centre of the county. The church of St Mary is transitional Norman, Decorated and Perpendicular, and is largely restored. The church of the Holy Trinity retains only the nave and the detached tower. The building is ancient but was restored to use from ruins. Close to the town are ruins of Easby Abbey, a Premonstratensian foundation by Roldal, constable of Richmond Castle in 1152, beautifully situated by the river. The remains, which are considerable, include a Decorated gateway, an Early English chapel and fragments of the transepts and choir of the church, with sufficient portions of the domestic buildings to enable the complete plan to be traced. For the free grammar-school founded by Elizabeth a Gothic building was erected in 1850, in memory of the Rev. James Tate, a former master. The tower of a Franciscan abbey founded in 1258 remains. The chief modern buildings are the town hall, market hall and the mechanics' institute. The principal trade is in agricultural produce, but there are a paper mill and an iron and brass foundry. An annual meeting is held on the racecourse in September. In 1889 Richmond became the seat of a suffragan bishop in the diocese of Ripon. The town is governed by a mayor, 4 aldermen and 12 councillors. Area, 2520 acres.

The name of Richmond (*Richemont*, *Richemund*) has not been traced further back than 1145. But it is probable that there was a settlement on the site of the present town before that date. Possibly it was the Hindrelaghe of the Domesday Survey, a place which, although large enough to have a church in 1086, appears to have vanished before the close of the 12th century. As far as is known the earliest charter was granted in 1145. But a later charter (1146) shows that the burgesses had enjoyed some municipal

liberties at an earlier period. The charter of 1145 gave the burgesses the borough of Richmond to hold for ever in fee farm at an annual rent of £29. Other charters were granted by Earl Conan in 1150, by Earl John II. in 1268 and by Edward III. (the first royal charter) in 1328, and confirmed in subsequent reigns. A charter of incorporation was granted by Queen Elizabeth under the title of aldermen and burgesses in 1576, and another by Charles II. in 1608 under the name of mayor and aldermen. This last, though superseded later, was restored in the reign of James II. and, until the passing of the Municipal Reform Act of 1835, was regarded as the governing charter of the borough. Although Richmond received a summons as early as 1328, it was not represented in parliament until 1584, from which time it usually sent two members. In 1867 the number was reduced to one. Since 1885 the representation has been merged in the Richmond division of the North Riding. The charter of Earl John II. points to the existence of a market before 1268, but there is no grant of it extant. In 1278, Edward I. granted the same earl a yearly fair to be held at Richmond from the 3rd to the 16th of September inclusive. Queen Elizabeth granted the burgesses a market every Saturday, a market every fortnight for animals and a fair have been as many as four annual fairs. There is now only one, which takes place on the 2nd and 3rd of November. The weekly market is still held on Saturday, and there is a fortnightly market for cattle. In the middle ages Richmond had an important market for corn and wool. There is evidence later of traffic in lead, and also of a flourishing manufacture of hand-knitted stockings. As the town possesses the only railway station in Swaledale, the market is still of consequence. But the stocking industry decayed with the introduction of machinery. William the Lion of Scotland was imprisoned in the castle in the reign of Henry II., but otherwise the town owes its importance chiefly to its lords. The honour was a valuable possession in the middle ages, and it was usually in royal or semi-royal hands.

See R. Gale, *Registrum Honoris de Richmond* (London, 1722); C. Clarkson, *The History and Antiquities of Richmond* (Richmond, 1821); T. D. Whitaker, *A History of Richmondshire* (London, 1823); *Victoria County History, Yorkshire*.

RICHMOND, the capital of Virginia, U.S.A., the county-seat of Henrico county, and a port of entry, on the James river (at the head of navigation), about 100 m. S. by W. of Washington, D.C., and about 125 m. by water from the Atlantic Ocean. Pop. (1850) 27,570; (1860) 37,910; (1870) 51,038; (1880) 63,600; (1890) 81,388; (1900) 85,050, of whom 32,230 were negroes and 2865 were foreign-born; (1910 census) 127,628. Richmond is served by the Atlantic Coast Line, the Chesapeake & Ohio, the Seaboard Air Line, the Southern and the Richmond, Fredericksburg & Potomac railways, and by the Old Dominion, the Virginia Navigation and the Chesapeake steamship lines. The city has a beautiful situation on the hilly ground (maximum elevation, about 250 ft. above sea-level) along the north and east banks of the James, at a bend where the river changes its south-easterly course for one almost due south. It occupies seven hills, from which fact it has been called "the Modern Rome." The western stretch of the river, opposite the city, breaks into rapids which have a fall of about 116 ft. in 9 m. and provide abundant water power. Belle Isle (the site of a Confederate prison camp during the Civil War), about $\frac{1}{2}$ m. long by about $\frac{1}{4}$ m. wide, is in this part of the river; a little farther down stream are a group of small islets, and opposite the south-eastern boundary of the city is Mayo's Island. Within the city's lines the river is crossed by two bridges (to Manchester) for vehicles and pedestrians, and three railway bridges. The river has been improved by Federal engineers since 1870; in June 1909 (up to which time \$1,799,033 had been expended for improvements) there was a channel 100 ft. wide and 18 ft. deep, nearly continuously from Hampton Roads to the Richmond wharf, and the maximum draft at low water was 16-1 ft.

About three-fourths of the city's total street mileage (120 m.) is paved, Belgium block or macadam being used in the principal thoroughfares. About 637-8 acres are devoted to city parks, among which are William Byrd Park (300 acres), in the western part of the city, Joseph Bryan Park (262-6 acres), Chimborazo Park (29 acres), near its eastern boundary, Gambles Hill Park (8-8 acres), Monroe Square ($\frac{7}{8}$ acres), Jefferson Park (6-3 acres) and Marshall Square (7 acres). The State Capitol Square (10 acres) is not owned by the city. Half a mile N.W. of the city are the Fair Grounds, where a state fair is held annually.

Of Richmond's public buildings, several have great historic interest. St John's Episcopal church, built in 1740 (and sub-

sequently much enlarged), is noted especially as the meeting-place of the Virginia Convention of March 1775, before which Patrick Henry made a famous speech, ending, "I know not what course others may take, but as for me, Give me liberty, or give me death!" The Capitol (begun in 1785 and completed in 1792—the wings were added in 1906) was designed from a model and plans of the Maison Carrée, at Nîmes, supplied by Thomas Jefferson, while he was minister to France. Aaron Burr was tried for treason and then for misdemeanour in this building in 1807, the Virginia secession convention met here in 1861, and during the Civil War the sessions of the Confederate Congress were held here. In its rotunda is Jean Antoine Houdon's full-length marble statue of Washington, provided for by the Virginia General Assembly in 1784, and erected in 1796; its base bears a fine inscription written by James Madison. In a niche is a Houdon bust of Lafayette, a replica of the original presented to the city of Paris by the state of Virginia. The Old Stone House (the oldest building in the city) was erected as a residence in 1737, and is now used for a museum. Masons' Hall, whose corner-stone was laid in 1785, is said to be the oldest exclusively Masonic building in the United States. The Executive Mansion of the Confederate States of America, built in 1819, purchased by the city in 1862, and leased to the Confederate government and occupied by President Jefferson Davis in 1862-65, was acquired in 1890 by the Confederate Memorial Library Society, and is now a Confederate Museum with a room for each state of the Confederacy and a general library in the "Solid South" room; it has valuable historical papers, collected by the Southern Historical Society, and the society has published a *Calendar of Confederate Papers* (1908). The former residence of Chief-Justice John Marshall, built in 1795, is still standing; and the Lee Mansion, which was the war-time residence of General Robert E. Lee's family, has been occupied, since 1893, by the Virginia Historical Society (organized 1831; reorganized 1847) as the repository of a valuable library and collection of portraits of historical interest. Libby Prison, which stood on the northern bank of a canal, near the river, in the eastern part of the city, was taken down in 1888-89, and its materials removed to Chicago, where it was reconstructed, in as nearly as possible its original form, and became the Libby Prison War Museum.¹ The Valentine Museum is in a house on Eleventh and Clay Streets, in which Aaron Burr was entertained while he was on trial, and which with \$50,000 and his collections was devised to a board of trustees in 1892 by Mann S. Valentine. The museum includes 3300 books, many being of the 15th and 16th centuries, a department of engravings, a Virginia Room with portraits and relics, some tapestries, an excellent collection of casts and valuable American archaeological specimens.

The more modern buildings include the City Hall, a fine granite structure (completed in 1893), with a tower 180 ft. tall; the Library building which houses the state library (about 80,000 volumes, with many portraits and a valuable collection of old manuscripts), the State Law Library and also the offices of most of the state officials; the Post-Office and Customs House; the State Penitentiary; the Chamber of Commerce; and, among the religious edifices, the Sacred Heart Cathedral (Roman Catholic), presented to the city by Mr and Mrs Thomas F. Ryan; the Monumental Church, built on the site of the Richmond Theatre, in the burning of which, in 1811, Acting-Governor George W. Smith and fifty-nine others lost their lives; and St Paul's Church, where Jefferson Davis was attending services, on the 2nd of April 1865, when he received news from

¹ As built in Richmond in 1845 by Luther Libby, it was a brick structure, three storeys high in front and four in the rear. It had six rooms, each about 100x45 ft., was used as a tobacco warehouse and a ship-chandlery until 1861, and then until the capture of Richmond was used as a prison, chiefly for Federal officers. Frequently it was terribly overcrowded (by as many as 1200 prisoners at a time), the inmates often suffered great privations, and many died or were physically disabled for the remainder of their lives.

General Lee that General Grant had broken through the lines at Petersburg and that Richmond must be evacuated. Rosemary Library was given to the city by Thomas Nelson Page in memory of his wife, who died in 1888.

Richmond has many fine monuments and statues of historic interest and artistic merit, the most noteworthy of the former being the Washington Monument, in Capitol Square. In 1850 the commission accepted the model submitted by Thomas Crawford (1814-1857), an American sculptor, the corner-stone of the monument was laid in that year, and the equestrian statue of Washington, with sub-statues of Patrick Henry and Thomas Jefferson, was unveiled on the 22d of February 1858. Thereafter were added sub-statues of Chief-Justice John Marshall and George Mason (1726-1792) by Crawford, and statues of Andrew Lewis (1730-1781) and Thomas Nelson (1738-1789), and six allegorical subjects, by Randolph Rogers (1825-1892), the monument being completed in 1869, at a cost of about \$260,000, of which about \$47,000 represented private gifts and the interest thereon. The greatest height of the monument is 60 ft., and the diameter of its base is 86 ft. In Capitol Square are also a marble statue of Henry Clay, by Joel T. Hart (1810-1877), a bronze statue of Stonewall Jackson, by John Henry Foley (1818-1874), an English sculptor, "presented to the city by English gentlemen" (Hon. A. J. Beresford-Hope and others) and unveiled in 1875; a statue of Hunter Holmes McGwire (1835-1900), a famous Virginia surgeon; and a statue of William Smith (1796-1887), governor of Virginia in 1846-49 and in 1864-65. In Monroe Park is a statue by E. V. Valentine of Brig.-General Williams Carter Wickham (1820-1888) of the Confederate army. Another noteworthy monument is the noble equestrian statue of General Robert E. Lee, surmounting a lofty granite pedestal at the head of Franklin Street. This statue, by Marius Jean Antonin Mercié (b. 1845), was unveiled in 1890. Adjacent is an equestrian statue of General J. E. B. Stuart, by Frederick Moynihan, and at the west end of Monument Avenue is the Jefferson Davis Monument, by W. C. Nowland, in front of which is a statue of Jefferson Davis, by E. V. Valentine. On Libby Hill, in the south-eastern part of the city, is a monument to the private soldiers and sailors of the Confederacy.

In Hollywood Cemetery (dedicated in 1849) are the graves of many famous men, including presidents James Monroe and John Tyler; Jefferson Davis, John Randolph of Roanoke, the Confederate generals, A. P. Hill, J. E. B. Stuart and George E. Pickett; Commodore Matthew F. Maury (1806-1873); James A. Seddon (1815-1880), Secretary of War of the Confederate States in 1862-64; and John R. Thompson (1823-1873), widely known in his day as a poet and as the editor of the *Southern Literary Messenger* in 1847-59. Here, too, are buried about 16,000 Confederate soldiers (to whose memory there is a massive pyramid of undressed granite, 40 ft. sq. at the base and 90 ft. high). In the north-eastern part of the city is Oakwood Cemetery, in which are the graves of about 18,000 Confederate soldiers. Two miles north-east of the city is the National Cemetery, with graves of 6571 Federal soldiers (5700 unknown) most of whom were killed in the actions near Richmond.

Richmond is the seat of Richmond College (opened in 1832; chartered in 1840; and co-educational since 1898), which in 1909-10 had 21 instructors and 341 students, of whom 55 were in the School of Law (established 1870; re-established 1890); the Woman's College (Baptist; opened in 1854), which in 1909-10 had 20 instructors and 275 students; the Virginia Mechanics' Institute (1856), including a Night School of Technology; the Union Theological Seminary in Virginia (Presbyterian; opened in 1824 and removed to Richmond in 1898 from Hampden-Sidney), which in 1909-10 had 7 instructors and 80 students; the Medical College of Virginia, (founded in 1838), which has medical, dental and pharmaceutical departments, and in 1909-10 had 50 teachers and 253 students; the University College of Medicine (1893), which has departments of medicine, dentistry and pharmacy, and in 1909-10 had 57 teachers and 220 students; the Harshorn Memorial College (Baptist), for women; and, for negroes, Virginia Union University, founded in 1869.

Many periodicals (including several religious weeklies) are published in Richmond. The principal newspapers are the *Times-*

Dispatch (Democratic; *Dispatch*, 1850; *Times*, 1886; consolidated in 1903) and the *News-Leader* (Democratic, 1899). Among the city's clubs are the Westmoreland and the Commonwealth.

The city's charitable institutions include the Memorial (1903), Virginia Sheltering Arms (1880) and St Luke's hospitals, the Retreat for the Sick (1877), the Eye, Nose, Ear and Throat Infirmary (1880), the Confederate Soldiers' Home (1884), supported jointly by the state and the city, a Home for Needy Confederate Women (1900), the City Almshouse and Hospital, and several orphanages and homes for the aged.

Richmond is the leading manufacturing city of Virginia, the value of its factory products in 1905 being \$28,202,607, an increase of 22.4% since 1900 and nearly 19% of the value of the state's factory products in this year. The chief industry is the manufacture of tobacco for smoking and chewing, of cigars and cigarettes and of snuff. There are large iron and steel works here, notably the Tredgar Iron Works. Other important manufactures, with their product-values in 1905, are lumber and planing-mill products, \$508,953; fancy and paper boxes and wooden packing boxes, \$432,523; coffee and spices, \$245,689; foundry and machine-shop products, \$238,576; and saddlery and harness, \$235,839. Richmond is the port of entry for the District of Richmond; in 1907 its imports were valued at \$913,234 and its exports at \$158,275; in 1909, its imports at \$693,822 and its exports at \$24,390. The city has a large jobbing and retail trade.

Richmond is governed under a charter of 1870 with amendments. The mayor is elected for two years and has the powers and authority in criminal cases of a justice of the peace. The city council is composed of a common council (five members from each ward, elected for two years) and of a board of aldermen (three members from each ward to be elected for four years). Other elective officers are the mayor, city treasurer, city sergeant, commonwealth attorney, city collector, city auditor, sheriff and high constable, elected for four years; and clerks of the various courts elected for eight years. The commissioner of the revenue is appointed for a term of four years by the judge of the corporation court. Three justices of the peace are elected from each ward for a term of two years. The city council appoints an attorney for the corporation, a city engineer, a city clerk, a police chief, a board of fire commissioners and a board of police commissioners, one from each ward, who have control of the fire and police departments, respectively, and a number of other officers. The city owns its gas works, water works and an electric-lighting plant (1910) for municipal lighting. The debt limit is set by the city charter at 18% of the assessed value of the taxable real estate of the city. In 1909 the taxable real estate and personal property was valued at \$108,663,716, and the city had no floating debt; on the 1st of February 1910, there were \$10,706,318 worth of bonds outstanding, and the sinking fund was \$2,011,857.

An exploring party from Jamestown, under command of Captain Christopher Newport (c. 1565-1617), and including Captain John Smith, sailed up the James river in 1607, and on the 3rd of June erected a cross on one of the small islands opposite the site of the present city. The first permanent settlement within the present limits of the city was made in 1609 in the district long known as Rockett's. Later in the same year Captain Smith bought from the Indians a tract of land on the east bank of the river, about 3 m. below this settlement, and near the site of the present Powhatan. This tract he named "None-such," and here he attempted to establish a small body of soldiers who had occupied a less favourable site in the vicinity; but they objected to the change and, being attacked by the Indians, sought the protection of Smith, who made prisoners of their leaders, with the result, apparently, that the settlement was abandoned. In 1645 Fort Charles was erected at the falls of the James as a frontier defence. In 1676, during "Bacon's Rebellion," a party of Virginians under Bacon's command killed about 150 Indians who were defending a fort on a hill a short distance east of the site of Richmond in the "Battle of Bloody Run," so called because the blood of the slain savages is said to have coloured the brook (or "ruu") at the base of the hill. Colonel William Byrd,¹ who owned much land along the

¹The Byrds and their ancestors, the Steggs, were conspicuous in the early history of Virginia. The first of the family was Thomas Stegg (or Stegge) (d. 1651), born in England, who became an Indian trader on the James river as early as 1637, and had his home near what is now the village of Westover, Charles City county. He left his estate to his son Thomas (d. 1670), who settled at the falls of the James in 1661, and was auditor-general in 1664-1670. He was succeeded by his nephew, William Byrd (1652-1704), who was born in London, went to Virginia about 1670, became a successful Indian trader, was a member of the House of Burgesses in 1677-1682, was a supporter of Nathaniel Bacon at the beginning of

James river, at the falls, visited the tract in September 1733, and decided to found there the town of Richmond, at the same time selecting and naming the present site of Petersburg. The name Richmond was suggested probably by the similarity of the site to that of Richmond on the Thames. The settlement was laid out in April 1737 by Major William Mayo (c. 1685-1744), and was incorporated as a town in 1742. The public records of the state were removed thither in 1777 from Williamsburg, and in May 1779 Richmond was made the capital. On the 5th of January 1781 the town was partly burned by a force of about 800 British troops under Gen. Benedict Arnold, the 200 or 300 Virginians offering little resistance, and much of the damage being done by Lieutenant-Colonel John G. Simcoe's celebrated Rangers. Richmond was first chartered as a city in 1782, and in 1788 it was allowed a representative in the House of Delegates.

The importance of Richmond during the Civil War was principally due to its having been made the capital of the Confederate States (by act of the Provisional Government on the 8th of May 1861). Its nearness to Washington, the material and manufacturing resources concentrated in it, and the moral importance attached to its possession by both sides, caused it to be regarded as the centre of gravity of the military operations in the east to which the greatest leaders and the finest armies were devoted from 1861 to 1865. (See AMERICAN CIVIL WAR.) The city's system of defences, which began to take form in May 1861, included a line of 17 heavy batteries, completely encircling it at an average distance of about 2 m.; another line of smaller batteries and trenches, from about a mile (or less) to about 2 m. beyond the heavy batteries, and practically unbroken from the north bank of the James (west of the city) to about 1 m. west of that river (south of the city); and the outer works, approximately paralleling the inner line, at distances of from 2 to 3 m. from this line north and east of the city. There was much confusion and lawlessness in Richmond during the earlier stages of the war. The city's police force was unable to cope with the situation created by the influx of soldiers, gamblers and adventurers, and on the 1st of March 1862 President Davis (by authority of a secret Act of the Confederate Congress passed on the 2nd of February) declared martial law in the city and the country within a radius of 10 m., suspended the writ of *habeas corpus*, and appointed General John H. Winder (1800-1865) to enforce military rule. General Winder's arbitrary exercise of his power was, however, resented so vigorously by the citizens that on the 10th of April the Confederate Congress materially modified the law under which he received these powers from the president. The opening of McClellan's Peninsula Campaign (see YORKTOWN; SEVEN DAYS, &c.) in 1862 caused great apprehension in Richmond, and in May 1862 some of the government records were packed up and preparations made to ship them to a place of safety. The approach of the "Monitor" and the Union gunboats up the James river caused a partial and temporary panic; President Davis appointed a day for prayer, and the families of some of the cabinet secretaries and many citizens fled the city precipitately; but confidence, restored by

"Bacon's Rebellion," was auditor-general of the colony from 1687 until his death, and was a member of the committee which founded the College of William and Mary. His residence, within the limits of the present city of Richmond, was preserved until about 1850. His son William (1674-1744), the founder of Richmond—and above referred to—was educated in England; returned to Virginia in 1696; succeeded his father as auditor-general of the colony, and was receiver-general in 1705-1716. In 1727 he was appointed one of the commission (of which William Fitzwilliams and William Dandridge were the other members) to mark the boundary between North Carolina and Virginia, concerning which he undertook the work (probably in 1737) *The History of the Dividing Line*. This with his other publications, *A Journey to the Land of Eden* and *A Progress to the Mines*, was published at Petersburg, Va., in 1841, and again (New York, 1901) as *The Writings of Colonel William Byrd of Westover in Virginia*, edited by John S. Bassett, and including an extended sketch of the Byrd family. Concerning Byrd's style as a writer, Professor Bassett says: "It would be hard to find before Franklin a better master of the art of writing clear, forceful and charming English."

the checking of the fleet at Drewry's Bluff (Fort Darling), about 8 m. below the city, on the 15th of May 1862, was increased by the battle of Fair Oaks and the Seven Days, after which the Army of the Potomac retreated. Unsuccessful attempts were made in February and March 1864 to free the Federal prisoners in Richmond by means of cavalry raids. The most important of these was that of General H. Judson Kilpatrick, a portion of whose force, under Col. Ulric Dahlgren (b. 1842), was annihilated, Dahlgren being killed (2nd March).

General U. S. Grant began the final campaign against Richmond in May 1864 (see WILDERNESS and PETERSBURG). Sheridan's cavalry, during the "Richmond Raid," carried the city's outer defences (May 12), but found the riverline too strong to be taken by assault and moved away. In June Grant's army crossed the James and attacked Lee in Petersburg. Then followed many months of unintermittent pressure upon both Petersburg and Richmond. General Benjamin F. Butler captured the southern outer line of the Richmond defences on the 29th of September 1864. On the 2nd of April 1865 Petersburg fell. Richmond was evacuated that night, after the ironclads, the bridges and many of the military and tobacco store-houses had been set on fire by order of General R. S. Ewell, so that when the Federal troops, under General Godfrey Weitzel (1835-1884) entered the city on the following morning (3rd April) a serious conflagration was under way, which was not extinguished until about one-third of the city, including several of its historic buildings, had been destroyed. During the war the principal iron foundry of the Confederacy (Tredegar Iron Works) was in Richmond, and here most of the cannon used by the Confederate armies were cast. In 1910 the city of Manchester was annexed.

See William W. Henry, "Richmond on the James" in *Historic Towns of the Southern States* (New York, 1900), edited by Lyman P. Powell; and Samuel Mordecai, *Richmond in By-Gone Days* (Richmond, 1856; 2nd ed., 1860).

RICHMOND AND DERBY, MARGARET, COUNTESS OF (1443-1509), mother of the English king, Henry VII., and foundress of St John's and Christ's colleges at Cambridge, was the daughter and heiress of John Beaufort, duke of Somerset, and was born on the 31st of May 1443. In 1455 she married Edmund Tudor, earl of Richmond, who died in the following year; she then took for her husband Henry (d. 1482), son of Humphrey Stafford, duke of Buckingham, and later Thomas Stanley, afterwards earl of Derby. She was in constant communication with her son, the future king, during his exile in Brittany, and with her husband, Lord Stanley, aided him to gain the crown in 1485. The countess was very pious and charitable, and under the influence of her confessor, John Fisher, afterwards bishop of Rochester, she founded the Lady Margaret professorships of divinity at the universities of Oxford and Cambridge. She completed the foundation of Christ's College, Cambridge, and after her death, in accordance with her wishes, much of her wealth was devoted to building and endowing St John's College in the same university. She survived her son, whose title to the English throne was derived through her, and died on the 29th of June 1509. The countess translated some devotional books into English, and Fisher said of her, "All England for her death had cause of weeping."

See C. H. Cooper, *Memoir of Margaret, Countess of Richmond and Derby* (1874).

RICHMOND AND LENNOX, FRANCES TERESA STEWART, DUCHESS OF (1648-1702), daughter of Walter Stewart, or Stuart, a physician in the household of Queen Henrietta Maria when in exile after 1649, was born in 1648 and was brought up in France. Notwithstanding the desire of Louis XIV. to keep her at his court, she was sent to England by Henrietta Maria in 1683, when she was appointed maid of honour to Catherine of Braganza, Queen of Charles II. Pepys describes her at this time as the greatest beauty he had ever seen, and Henrietta Maria called her the prettiest girl in the world. Charles II., who is said to have first seen "La belle Stewart" in the apartments of his mistress Lady Castlemaine (afterwards duchess of Cleveland), quickly became enamoured of her; but for some

time Miss Stewart resisted the king's importunities, though her behaviour was far from modest and "she had no aversion to scandal." She had numerous suitors, including the duke of Buckingham and Francis Digby, son of the earl of Bristol, whose unrequited love for her was celebrated by Dryden. Her beauty appeared to her contemporaries to be only equalled by her childish silliness; but her letters to her husband, preserved in the British Museum, are not devoid of good sense and feeling. The king's infatuation was so great that when the queen's life was despaired of in 1663, it was reported that he intended to marry Miss Stewart, and four years later he was considering the possibility of obtaining a divorce to enable him to make her his wife. This was at a time when Charles feared he was in danger of losing her as his mistress, her hand being sought in marriage by Charles Stuart, duke of Richmond and Lennox. The duchess of Cleveland, who was losing her hold on the king's affections, is reported by Hamilton to have led the king to Miss Stewart's apartment at midnight when Richmond was closeted with her, and the duke was immediately expelled from court. In March 1667 the lady eloped from Whitehall with Richmond and married him secretly in the country. The king, who was greatly enraged, suspected Clarendon of being privy to the marriage, and, according to Burnet, deprived him of office for this offence. The duchess of Richmond, however, soon returned to court, where she remained for many years; and although she was disfigured by small-pox in 1668, she retained her hold on the king's affections. Her husband was sent as ambassador to Denmark, where he died in 1672. The duchess was present at the birth of the prince of Wales, son of James II., in 1688, being one of those who signed the certificate before the council. She died in 1702, leaving a valuable property to her nephew the earl of Blantyre, whose seat was named Lennoxvale after her.

BIBLIOGRAPHY.—Gibert Burnet, *History of my own Time* (6 vols., Oxford, 1833); Samuel Pepys, *Diary*, 9 vols. (London, 1829—1899, and numerous editions); Anthony Hamilton, *Memoirs of Grammont*, translated by Boyer, edited by Sir W. Scott (2 vols., London, 1885, 1890); Anna Jameson, *Memoirs of the Countess of the Court of Charles II., with their Portraits* (2nd ed., London, 1838); Jules J. Jusserand, *A French Ambassador at the Court of Charles II.* (London, 1892); Edmund Ludlow, *Memoirs, 1625-72*, edited by C. H. Firth (2 vols., Oxford, 1894). (R. J. M.)

RICHTER, ADRIAN LUDWIG (1803-1884), German painter and etcher, was born at Dresden in 1803, the son of the engraver Karl August Richter, from whom he received his training; but he was strongly influenced by Erhard and Chodowiecki. He was the most popular, and in many ways the most typical German illustrator of the middle of the 19th century. His work is as typically German and homely as are the fairy-tales of Grimm. Richter visited Italy from 1823-26, and his "Thunderstorm in the Sabine Mountains" at the Staedel Institute in Frankfurt is one of the rare Italian subjects from his brush. In 1828 he worked as designer for the Meissen factory, and in 1841 he became professor and head of the landscape atelier at the Dresden Academy. The Dresden Gallery owns one of his best and most characteristic paintings in the "Bridal Procession in a Spring Landscape." He died at Loschwitz near Dresden in 1884.

RICHTER, ERNST FRIEDRICH EDUARD (1808-1879), German musical theorist, was born at Grosshönaun in Zittau, on the 24th of October 1808. He first studied music at Saxony, and afterwards at Leipzig, where he attained so high a reputation that in 1843 he was appointed professor of harmony and counterpoint at the conservatorium of music, then newly founded by Mendelssohn. On the death of Hauptmann on the 3rd of January 1868, he was elected cantor of the Thomasschule, which office he retained until his death on the 9th of April 1879. He is best known by three theoretical works—*Lehrbuch der Harmonie, Lehre vom Contrapunct* and *Lehre von der Fuge*—valuable textbooks known to English students through the excellent translation by Franklin Taylor.

RICHTER, EUGEN (1839-1906), German politician, was born on the 30th of July 1839 at Düsseldorf. After attending the universities of Bonn, Heidelberg and Berlin, he entered the

government service, being stationed in his native town. In 1864 he was chosen burgomaster of Neuwied; but he was already known for his Liberal opinions, and the government refused to confirm the appointment. He was hereupon transferred to Bromberg, in East Prussia, which to an inhabitant of the Rhineland was the worst form of exile, and in consequence he resigned his place in the public service. He now went to Berlin, where he earned his living as a journalist. He was the most consistent advocate of those doctrines of *laissez faire* and individual liberty which the Germans call *Manchesterism*. He was also keenly interested in the attempts made at that period to create co-operative societies among the working men, and wrote a work on co-operative stores. It was not long before he came into conflict with the government; an electioneering pamphlet published in 1867 was confiscated; he was put on his trial but acquitted. In 1867 he was elected a member of the newly formed Reichstag, and in 1869 of the Prussian parliament. He soon became one of the most influential politicians in Germany. A member of the Progressive party, in 1880 one of the founders, and eventually the leader, of the *Freisinnige*, he was always in opposition. Next to Windthorst (*q.v.*) he was Bismarck's most dangerous opponent. After the great change of policy in 1878, for a time his influence was a great impediment to the government; as a consistent adherent to free trade, he was the leader of the opposition to the introduction of protection, to the new colonial policy, and to State Socialism. It was after 1880 that he raised the cry *Bismarck muss fort*. He always took a great part in debates on the military and naval establishments, in vain opposing the constant increase of army and navy. It was his refusal to support the government proposals in 1893 for an increase of the army which led to the break up of his party; he was left with only eleven followers; and, except among the middle class of Berlin and some other Prussian cities, the old Radical party, of which he was the chief representative, from that time had little influence in the country. In 1885 he founded the *Freisinnige Zeitung*, which he edited himself; of his numerous brochures the most successful was his attack on Socialism, entitled *Sozialdemokratische Zukunftsbilder* (Berlin, 1891), a clever and successful satire on the Socialist state of the future. This has been translated into the English. He also wrote much on Prussian finance, and under the title *Das politische A, B, C Buch* compiled a very useful political handbook for Radical voters. He also published in 1892 reminiscences of his youth (*Jugend-erinnerungen*), and two volumes of parliamentary reminiscences (*Im alten Reichstag, 1894-1896*).

He died at Jena on the 26th of January 1906.

RICHTER, HANS (1843-), Hungarian musical conductor, born at Raab on the 4th of April 1843, was the son of the kapellmeister at the cathedral, and of his wife, *née* Josephine Caszinsky, who was the first to perform Venus in *Tannhäuser* at Vienna. Young Hans sang either soprano or alto in the cathedral choir, according to requirement, and occasionally played the organ. But his public *début* was made as a drummer in Haydn's *Passenmesse*. In 1853, at the age of ten, he appeared in a concert as pianist in Hummel's E flat quintet; and in 1854, after his father's death, went to the choristers' school, the Convikt (where Schubert was educated) in Vienna, and there became chorister in the Court Chapel. For five years from 1860 Richter studied under Heisserl and Sechter in the Vienna Conservatorium, and he learnt the horn under Kleinecke. A year and a half after his first lesson he became hornist in the old Kärnthnertheater at £3 a month. Meanwhile he had devoted time to conducting. It was not till August 1868 that Richter made his first appearance as a conductor, at the Hof Theater, Munich (where he had just been appointed), in *William Tell*; but in the next year he resigned this post, went first to Paris, then to Brussels, and finally to Triebeschen, where he copied *Der Ring des Nibelungen* for Wagner. In April 1871 Richter took up his new duties as conductor of the Hungarian National Opera at Budapest, where he remained four years, until he began in May 1875 his long connexion with the Vienna Opera, which terminated only with the century. In 1876 Richter

directed the rehearsals and performances of *Der Ring* at Bayreuth, and in 1877 paid his first visit to England to conduct the Wagner Festival at the Albert Hall. There in 1879 he founded the Richter Concerts, which were a revelation to London musical circles of the masterly personality of the conductor, and his influence upon the orchestra; in 1885 he became conductor of the Birmingham Triennial Festival, and was created Mus. Doc. Oxon. *honoris causa*. In 1882 Richter also conducted a famous series of performances of Wagner's works (including the first in England of *Die Meistersinger* and *Tristan*) at Drury Lane, and in 1900 became conductor of the Hallé Orchestra in Manchester. He had established his position as one of the most richly gifted and the most experienced of modern conductors, supreme in the interpretation of Beethoven, Wagner and Brahms.

RICHTER, JEREMIAS BENJAMIN (1762-1807), German chemist, was born at Hirschberg in Silesia on the 10th of March 1762, became a mining official at Breslau in 1794, and in 1800 was appointed assessor to the department of mines and chemist to the royal porcelain factory at Berlin, where he died on the 4th of April 1807. To him belongs the merit of carrying out some of the earliest determinations of the quantities by weight in which acids saturate bases and bases acids, and of arriving at the conception that those amounts of different bases which can saturate the same quantity of a particular acid are equivalent to each other. He was thus led to conclude that chemistry is a branch of applied mathematics and to endeavour to trace a law according to which the quantities of different bases required to saturate a given acid formed an arithmetical, and the quantities of acids saturating a given base a geometrical, progression. His results were published in his *Anfangsgründe der Stöchiometrie oder Messkunst chemischer Elemente* (1792-94), and *Über die neueren Gegenstände in der Chemie* (1792-1802), but it was long before they were properly appreciated, or he himself was accorded due credit for them. This was partly because some of his work was wrongly ascribed to C. F. Wenzel by Berzelius through a mistake which was only corrected in 1841 by Germain Henri Hess (1802-1850), professor of chemistry at St Petersburg, and author of "the laws of constant heat-sums and of thermoneutrality" (see **THERMOCHEMISTRY**).

RICHTER, JOHANN PAUL FRIEDRICH (1763-1825), usually called **JEAN PAUL**, famous German humorist, was born at Wunsiedel, in Bavaria, on the 21st of March 1763. His father was a schoolmaster and organist at Wunsiedel, but in 1765 he became a pastor at Joditz near Hof, and in 1776 at Schwarzenbach, where he died in 1779. After attending the gymnasium at Hof, Richter went in 1781 to the university of Leipzig. His original intention was to enter his father's profession, but theology did not interest him, and he soon devoted himself wholly to the study of literature. Unable to maintain himself at Leipzig he returned in 1784 to Hof, where he lived with his mother. From 1787 to 1789 he served as a tutor at Töpen, a village near Hof; and afterwards he taught the children of several families at Schwarzenbach.

Richter began his career as a man of letters with *Gründliche Prozesse und Auswahl aus des Teufels Papieren*, the former of which was issued in 1783-84, the latter in 1789. These works were not received with much favour, and in later life Richter himself had little sympathy with their satirical tone. His next book, *Die unsichtbare Loge*, a romance, published in 1793, had all the qualities which were soon to make him famous, and its power was immediately recognized by some of the best critics of the day. Encouraged by the reception of *Die unsichtbare Loge*, he sent forth in rapid succession *Hesperus* (1795), *Biographische Belustigungen unter der Gehirnschale einer Riesin* (1796), *Leben des Quintus Fixlein* (1796), *Blumen-Frucht- und Dornenstücke, oder Ehestand, Tod und Hochzeit des Armenadvokaten Siebenkürs* (1796-97), *Der Jubelseniör* (1797), and *Das Kampaner Tal* (1797). This series of writings won for Richter an assured place in German literature, and during the rest of his life every work he produced was welcomed by a wide circle of admirers.

After his mother's death he went in 1797 to Leipzig, and in the following year to Weimar, where he had much pleasant intercourse with Herder, by whom he was warmly appreciated. He did not become intimate with Goethe and Schiller, to both of whom his literary methods were repugnant; but in Weimar, as elsewhere, his remarkable conversational powers and his genial manners made him a favourite in general society. In 1801 he married Caroline Meyer, whom he met in Berlin in 1800. They lived first at Meiningen, then at Coburg; and finally, in 1804, they settled at Bayreuth. Here Richter spent a quiet, simple and happy life, constantly occupied with his work as a writer. In 1808 he was fortunately delivered from anxiety as to outward necessities by the prince-primate, K. T. von Dalberg, who gave him a pension of a thousand florins. Before settling at Bayreuth, Richter had published his most ambitious novel, *Titan* (1800-3); and this was followed by *Flegeljähre* (1804-5), two works which he himself regarded as his masterpieces. His later imaginative works were *Dr Katzenbergers Badereise* (1809), *Des Feldpredigers Schmelze Reise nach Flätz* (1809), *Leben Fibels* (1812), and *Der Komödiant, oder Nikolaus Marggraf* (1820-22). In *Vorschule der Aesthetik* (1804) he expounded his ideas on art; he discussed the principles of education in *Levana, oder Erziehungslehre* (1807); and the opinions suggested by current events he set forth in *Friedenspredigt* (1808), *Dämmerungen für Deutschland* (1809), *Mars und Phöbus Thronwechsel im Jahre 1814* (1814), and *Politische Fastenpredigten* (1817). In his last years he began *Wahrheit aus Jean Pauls Leben*, to which additions from his papers and other sources were made after his death by C. Otto and E. Förster. In 1821 Richter lost his only son, a youth of the highest promise; and he never quite recovered from this shock. He died of dropsy, at Bayreuth, on the 14th November 1825.

Schiller said of Richter that he would have been worthy of admiration "if he had made as good use of his riches as other men made of their poverty." And it is true that in the form of his writings he never did full justice to his great powers. In working out his conceptions he found it impossible to restrain the expression of any powerful feeling by which he might happen to be moved. He was equally unable to resist the temptation to bring in strange facts or notions which occurred to him. Hence every one of his works is irregular in structure, and his style lacks directness, precision and grace. But his imagination was one of extraordinary fertility, and he had a surprising power of suggesting great thoughts by means of the simplest incidents and relations. The love of nature was one of Richter's deepest pleasures; his expressions of religious feelings are also marked by a truly poetic spirit, for to Richter visible things were but the symbols of the invisible, and in the unseen realities alone he found elements which seemed to him to give significance and dignity to human life. His humour, the most distinctive of his qualities, cannot be dissociated from the other characteristics of his writings. It mingled with all his thoughts, and to some extent determined the form in which he embodied even his most serious reflections. That it is sometimes extravagant and grotesque cannot be disputed, but it is never harsh nor vulgar, and generally it springs naturally from the perception of the incongruity between ordinary facts and ideal laws. Richter's personality was deep and many-sided; with all his wilfulness and eccentricity he was a man of a pure and sensitive spirit, with a passionate scorn for pretence and an ardent enthusiasm for truth and godness.

Richter's *Sämtliche Werke* appeared in 1826-28 in 60 vols., to which were added 5 vols. of *Literarischer Nachlass* in 1836-38; a second edition was published in 1840-42 (33 vols.); a third in 1860-62 (34 vols.). The last complete edition is that edited by R. Gottschall (60 parts, 1879). Editions of selected works appeared in 16 vols. (1865), in Kirschner's *Deutsche Nationalliteratur* (edited by P. Nerlich, 6 vols., 1884-87), &c. The chief collections of Richter's correspondence are: *Jean Pauls Briefe an F. H. Jacobi* (1828); *Briefwechsel Jean Pauls mit seinem Freunde C. Otto* (1829-33); *Briefwechsel zwischen H. Voss und Jean Paul* (1833); *Briefe an eine Jugendfreundin* (1858); P. Nerlich, *Jean Pauls Briefwechsel mit seiner Frau und seinem Freunde Otto* (1902). See further

the continuation of Richter's autobiography by C. Otto and E. Förster (1826-33); H. Döring, *J. P. F. Richters Leben und Charakteristik* (1830-32); R. O. Spazier, *J. P. F. Richter: ein biographischer Kommentar zu dessen Werken* (5 vols., 1833); E. Förster, *Denkwürdigkeiten aus dem Leben von J. P. F. Richter* (1863); P. Nerlich, *Jean Paul und seine Zeitgenossen* (1876); J. Firmery, *Étude sur la vie et les œuvres de J. P. F. Richter* (1886); P. Nerlich, *Jean Paul, sein Leben und seine Werke* (1889); F. J. Schneider, *Jean Pauls Altersdichtung* (1901); by the same, *Jean Pauls Jugend und erstes Auftreten in der Literatur* (1906). All Richter's more important works have been translated into English, *Quintus Fixlein and Schmeldes Reise*, by Carlyle; see also Carlyle's two admirable essays on Richter.

RICHTHOFEN, FERDINAND, BARON VON (1833-1905), German geographer and traveller, was born near Karlsruhe, Silesia, on the 5th of May 1833. He was educated at Breslau and Berlin, and in 1856 carried out geological investigations in the Tirol, subsequently extending them to Transylvania. In 1859 he accompanied as geologist the Prussian diplomatic mission to the Far East under Count von Eulenburg, and visited Ceylon, Japan, Formosa, the Philippines and Java, subsequently making an overland journey from Bangkok to Moulemein and reaching Calcutta in 1862. No important work resulted from these travels, for much of Richthofen's records and collections was lost. China was at the time inaccessible owing to the Taiping rebellion, but Richthofen was impressed with the desirability of exploring it, and after a visit to California, where he remained till 1868, he returned to the East. In a remarkable series of seven journeys he penetrated into almost every part of the Chinese Empire. He returned home in 1872, and a work comprising three large volumes and an atlas, which, however, did not cover the entire field or complete the author's plan, appeared at Berlin in 1877-85 under the title of *China; Ergebnisse eigener Reisen und darauf gegründeter Studien*. In this standard work the author deals not only with geology but with every subject necessary to a general geographical treatise. Notably he paid close attention to the economic resources of the country he traversed; he wrote a valuable series of letters to the Shanghai Chamber of Commerce, and first drew attention to the importance of the coalfields of Shantung, and of Kiaochow as a port. In 1875 Richthofen was elected professor of geology at Bonn, but being fully occupied with his work in China he did not take up professorial duties till 1879; in 1883 he became professor of geography at Leipzig, and in 1886 was chosen to the same office at Berlin, and held it till his death. His lectures attracted numerous students who subsequently became eminent in geographical work, and in order to keep in touch with them he established his weekly geographical "colloquium." Of his written works, besides that on China, there may be mentioned "Die Kalkalpen von Voralberg und Nordtirol" in *Jahrbuch der geologischen Reichsanstalt* (1859-1861); "Die Metallproduktion Kaliforniens" in *Petermanns Mitteilungen* (1865); *Natural System of Volcanic Rocks* (San Francisco, 1867); *Aufgaben und Methoden der heutigen Geographie* (an address delivered at Leipzig, 1883); *Führer für Forschungsreisende* (Berlin, 1886); *Triebkräfte und Richtungen der Erdkunde in neunzehnten Jahrhundert* (address on his election as rector, Berlin, 1903). He was for many years president of the German Geographical Society, and he founded the Berlin Hydrographical Institute. He died on the 16th of October 1905.

RICIMER (d. 472), master of the Roman Empire in the West during part of the 5th century, was the son of a prince of the Suebi and the daughter of Wallia, king of the Visigoths. His youth was spent at the court of Valentinian III., and he won distinction under Aetius. In 456 he defeated the Vandals in a sea-fight near Corsica, and on land near Agrigentum in Sicily, and backed by the popularity thus acquired, Ricimer then gained the consent of the Roman senate to an expedition against the emperor Avitus, whom he defeated in a bloody battle at Piacenza on the 16th of October 456. Avitus was taken prisoner and made bishop of Piacenza, and shortly afterwards sentenced to death. Ricimer then obtained from

Leo I., emperor at Constantinople, the title patrician, but in 457 set up Majorianus as his own emperor in the West, and induced Leo to give his consent. When, however, Majorianus tried to rule by himself, Ricimer forced him to abdicate and caused his assassination on the 7th of August 461. The successor whom Ricimer placed upon the throne was Libius Severus, who proved to be more docile than Majorianus, but had to face the rivalry of Leo in the East and Aegidius in Gaul. Upon his death in 465—said to be due to the poison of Ricimer—this emperor-maker ruled the West for eighteen months without an emperor, and then accepted Leo's candidate Anthemius, diplomatically married his daughter, and for some time lived in peace with him. Before long, however, Ricimer moved to Milan, ready to declare war upon Anthemius. St Epiphanius, bishop of Milan, patched up a truce, but in 472 Ricimer was again before Rome with an army of Germans, proclaimed as emperor Olybrius, whom Leo had sent to pacify the two enemies, and after three months' siege took the city, on the 1st of July 472. Anthemius was massacred and Rome was a prey to Ricimer's soldiers. He himself, however, died on the 18th of August 472, of malignant fever.

RICINA, an ancient town of Picenum, Italy, 3 m. N.W. of the modern Macerata, on the banks of the river Potenza, in a fertile valley. It was probably a *municipium* until it was refounded by Pertinax and Septimius Severus, after which it bore the name Colonia Helvia Ricina Pertinax. The site is now deserted, but considerable ruins of a theatre and remains of baths and other buildings (all in brickwork of the imperial period) still exist; also the fragments of an ancient bridge over the Potenza.

RICKETS, a constitutional disease of childhood characterized chiefly by a softened condition of the bones and by other evidences of perverted nutrition. It was first described in 1649 by Arnold de Boot, a Frisian physician practising in Ireland. Its nature and causation are discussed under METABOLIC DISEASES. The name "rickets" is from the Old English *wrickken*, to twist; the more technical medical term, *rachitis*, which comes from Greek *ῥάχης*, the spine, was suggested by Francis Glisson in 1650, both from similarity of sound and from the part of the body which is one of the first to be affected.

Rickets can seldom be recognized until several months after birth, and it most commonly attracts attention at about the end of the first year. The symptoms which precede the outward manifestation of the disease are marked disorders of the digestive and alimentary functions. The child's appetite is diminished, and there is frequent vomiting, together with diarrhoea or irregularity of the bowels, the evacuations being clay-coloured and unhealthy. Along with this there is a falling away in flesh. Importance is to be attached to certain other symptoms present in the early stages, namely, profuse sweating of the head and upper parts of the body, particularly during sleep, with at the same time dry heat of the lower parts and a tendency in the child to kick off all coverings and expose the limbs. At the same time there is great tenderness of the bones, as shown by the pain produced on moving or handling the child. Gradually the changes in the shape of the bones become visible, at first chiefly noticed at the ends of the long bones, as in those of the arm, causing enlargements at the wrists, or in the ribs, producing a knobbed appearance at the junction of their ends with the costal cartilages. The bones also from their softened condition tend to become distorted and misshapen, both by the action of the muscles and by the superincumbent weight of the body. Those of the limbs are bent outwards and forwards, and the child becomes "bow-legged" or "in-kneed" often to an extreme degree. The trunk of the body likewise shows various alterations and deformities owing to curvatures of the spine, the flattening of the lateral curves of the ribs, and the projection forwards of the sternum. The cavity of the chest may thus be contracted and the development of the thoracic organs interfered with as well as their functions more or less embarrassed. The pelvis undergoes distortion, which may reduce its capacity to a

degree that in the female may afterwards lead to serious difficulties in parturition. The head of the rickety child is large-looking in its upper part, the individual bones of the cranium sometimes remaining long ununited, while the face is small and ill-developed, and the teeth appear late and fall out or decay early. The constitutional conditions of ill-health continue, and the nutrition and development of the child are greatly retarded.

The disease may terminate in recovery, with more or less of deformity and dwarfing, the bones although altered in shape becoming firmly ossified, and this is the common result in the majority of instances. On the other hand, during the progress of the disease, various intercurrent ailments are apt to arise which may cause death, such as the infectious fevers, bronchitis and other pulmonary affections, chronic hydrocephalus, convulsions, laryngismus stridulus, &c.

An acute form of rickets of rare occurrence (really a form of *scorvy*, *q.v.*) has been described by writers on diseases of children, in which all the symptoms are of more rapid development and progress, the result in many instances being fatal.

The treatment of rickets is necessarily more hygienic than medicinal, and includes such preventive measures as may be exercised by strict attention to personal health and nutrition on the part of mothers, especially where there appears to be any tendency to a rickety development in any members of the family. Very important also is the avoidance of too prolonged nursing, which by its weakening effects upon the mother's health is calculated to engender the disease in any succeeding children. At the same time it must be admitted that, when the mother is healthy, her milk abundant, and nursing discontinued before the lapse of the first year, there is no better means of preventing the occurrence of rickets than this method of feeding an infant, the disease, as is well known, being far more frequently met with in children brought up by hand. The management of the child exhibiting any tendency to rickets is of great importance, but can only be alluded to in general terms. The digestive disorders characteristic of the setting in of the disease render necessary the greatest care and watchfulness as to diet. Thus, if the child be not nursed but fed artificially, fresh milk should be almost the only article of diet for at least the first year, and the chief element for the next. When not digested well, as may at times be shown by its appearance as a curd in the evacuations, it may be diluted with water or lime water, or else discontinued for a short time, carefully-made gruel or barley water being substituted. Many of the so-called "infants' foods" which are now so extensively used appear to be well adapted for their purpose, but when employed too abundantly and to the exclusion of the due amount of milk are often productive of digestive and intestinal disorders, probably from their containing a greater amount of starchy matter than can be utilized. From the end of the first year light animal soups may occasionally be given with advantage. The medicinal remedies most to be relied on are those which improve the digestive functions and minister to nutrition, and include such agents as the preparations of iron, quinine, and especially cod-liver oil and phosphorus, and the cautious use of extract of thyroid gland has been advocated by Hensch. Of no less importance, however, are abundance of fresh air, cleanliness, warm clothing, and attention to the general hygiene of the child and to regularity in all its functions.

When the disease is showing evidence of advancing, it is desirable to restrain the child from walking, as far as possible. But this precaution may be to some extent rendered unnecessary by the use of splints and other apparatus as supports for the limbs and body, enabling the child to move about without the risk of bending and deformity of the bones which otherwise would probably be the result.

The condition formerly known as foetal rickets (achondroplasia or chondrodystrophia foetalis) is now classed as a separate disease. Its chief characteristics are dwarfism with shortening of the limbs and enormous enlargement of the articulations.

RICKMAN, THOMAS (1776-1841), English architect, was born on the 8th of June 1776 at Maidenhead, Berkshire, where he assisted his father (a Quaker) in business as a grocer and druggist until 1797. He was then engaged in various businesses until 1818. All his spare time was spent in sketching and making careful measured drawings, till he gained a knowledge of architecture which was very remarkable at a time when little taste existed for the beauties of the Gothic styles. In 1811 alone he is said to have studied three thousand ecclesiastical buildings. When in 1818 a large grant of money was made by the government to build new churches, Rickman sent in a design of his own which was successful in an open competition; thus he was fairly launched upon the profession of an architect, for which his natural gifts strongly fitted him. Rickman then moved to Birmingham, and by 1830 became one of the most successful architects of his time. He built churches at Hampton Lucy, Ombersley, and Stretton-on-Dunsmore, St George's at Birmingham, St Philip's and St Matthew's in Bristol, two in Carlisle, St Peter's and St Paul's at Preston, St David's in Glasgow, Grey Friars at Coventry, and many others. He also designed the new court of St John's College, Cambridge, a palace for the bishop of Carlisle, and several large country houses. These are all in the Gothic style, but show more knowledge of the outward form of the mediæval style than any real acquaintance with its spirit, and are little better than dull copies of old work, disfigured by much poverty of detail. Rickman nevertheless played an important part in the revival of taste for mediævalism perhaps second only to Pugin. His *Attempt to discriminate the Styles of Architecture in England* shows painstaking research, and ran through many editions. Rickman died at Birmingham on the 4th of January 1841. He was married three times: first to his cousin, Lucy Rickman of Lewes; secondly to Christiana Hornor; thirdly to Elizabeth Miller of Edinburgh, by whom he had a son and a daughter.

RICKMANSWORTH, an urban district in the Watford parliamentary division of Hertfordshire, England; 17½ m. N.W. of London by the Metropolitan & Great Central joint railway; served also by a branch of the London & North Western railway from Watford. Pop. (1901) 5627. It lies in a pleasant valley at the junction of the Chess with the Colne, and on the Grand Junction canal. The church of St Mary, with the exception of the tower a modern reconstruction, contains some French stained glass of the 16th century. The chief industries are brewing and art-printing. The Colne here holds large trout, which are carefully preserved. The grounds of Moor Park to the south-east are finely wooded, and the mansion, belonging to Lord Ebury, is a good example of the period of George I. The estate counts among its former owners such famous names as the Botelers; George Neville, archbishop of York; John de Vere, earl of Oxford in Henry VII.'s time; Walsley in the next reign; Robert Carey, earl of Monmouth, and the duke of Monmouth.

RICOCHET, a military term expressing the rebound of a projectile that strikes on a hard surface. The origin of the French word *ricochet* is unknown. Its earliest known use (14th and 15th centuries) was in the sense of "repetition," e.g. *chanson du ricochet*, "an oft-told tale." Hence it came to be applied to the rebound of a flat stone skimmed along the surface of water, known familiarly in English as "ducks and drakes," and so finally in the military sense defined above, which found its way into the English language.

The use of the now obsolete "ricochet fire" in war is well illustrated by "ducks and drakes." The shot, striking the ground at a small angle, described for the remainder of its course a succession of leaps and falls. The discovery of this species of fire, usually attributed to Vauban (siege of Ath in 1697), had the greatest influence both on sieges and on operations in the field. In siege warfare, ricochet, especially when combined with enfilade, i.e. when directed along the enemy's line of defence, soon became the principal weapon of the besieger, and with the system of parallels (*q.v.*) gave the attack a superiority so complete that a siege came to be considered as the most

certain operation of war. Enfilade fire by itself was neutralized by traverses (*q.v.*) in the defences, but by the new method a shot could be so aimed as to skip over each successive traverse and thus to search ground that was immune from direct fire. The application of ricochet fire to operations in the field came somewhat later. In the 18th century field artillery, which was not, before Napoleon's time, sufficiently mobile to close with the enemy, relied principally upon the ricochet of round shot, which, sweeping a considerable depth of ground, took effect upon several successive lines of hostile troops. But once artillery was able to gallop up to the enemy and to use its far more terrible close-range projectile, case-shot, ricochet fire came to be used less and less, until finally, with the general adoption of shell (which, of course, burst at the first contact with the ground), the round shot disappeared altogether from the battlefield. Similarly in siege warfare, as soon as high-angle fire with shells became sufficiently accurate, there was no further need of round shot and ricochet.

The term "ricochet" is now only applied, in modern rifle shooting, to the graze of a bullet that has struck short. A modern bullet that has ricocheted inflicts a very severe wound, as its nickel or other hard envelope is torn and jagged by its contact with the ground. With its high remaining velocity it is dangerous even after more than one ricochet, except at extreme ranges.

RICOLD OF MONTE CROCE (1242–1320), Italian Dominican missionary, was born at Monte Croce, near Florence. In 1267 he entered the Dominican house of Santa Maria Novella in Florence, and in 1272 that of St Catherine in Pisa. He started for Acre with a papal commission to preach in 1286 or 1287; in 1288 or 1289 he began to keep a record of his experiences in the Levant; this record he probably reduced to final book form in Bagdad. Entering Syria at Acre, he crossed Galilee to the Sea of Tiberias; thence returning to Acre he seems to have travelled down the coast to Jaffa, and so up to Jerusalem. After visiting the Jordan and the Dead Sea he quitted Palestine by the coast road, retracing his steps to Acre and passing on by Tripoli and Tortosa into Cilicia. From the Cilician port of Lajazzo he started on the great high road to Tabriz in north Persia. Crossing the Taurus he travelled on by Sivas of Cappadocia to Erzerum, the neighbourhood of Ararat and Tabriz. In and near Tabriz he preached for several months, after which he proceeded to Bagdad via Mosul and Tekrit. In Bagdad he stayed several years, studying the Koran and other works of Moslem theology, for controversial purposes, arguing with Nestorian Christians, and writing. In 1301 Ricold again appeared in Florence: some time after this he proposed to submit his *Confutatio Alcorani* to the pope, but did not. He died on the 31st of October 1320. As a traveller and observer his merits are conspicuous. His account of the Tatars and his sketch of Moslem religion and manners are especially noteworthy. In spite of strong prejudice, he shows remarkable breadth of view and appreciation of merit in systems the most hostile to his own.

Of Ricold's *Itinerary* (*Itinerarius* [*sic*]) fifteen MSS. exist, of which the chief are: (1) Florence, Laurentian Library, Fineschi, 326; (2) Paris, National Library, Lat. 4955, fols. 46–55; (3) Wolfenbüttel, Cod. Weissenb. 40, fols. 73 B.–94 B. (all of 14th century). Of his *Epistles* there is one MS., viz. Rome, Vatican, 37.7, fols. 249 A.–267 A. The best edition of the *Itinerary* is by J. C. M. Laurent, in *Peregrinatores Medii Aevi Quatuor*, pp. 105 (101)–41 (Leipzig, 1864 and 1873). The *Epistles* have been edited by R. Röhrich in *Archives de l'orient latin*, vol. ii, part ii. (Documents) pp. 258–96 (Paris, 1884). The *Confutatio Alcorani*, printed at Seville in 1500, at Venice in 1607, adds hardly anything to the sections of the *Itinerary* devoted to Moslem belief, &c. Ricold's *Libellus contra Nationes Orientales et Contra errores Judeorum* have never been printed. See also C. Raymond Beazley, *Dawn of Modern Geography*, iii. 190–202, 218, 390–91, 547, 554–564.

RICOTTI-MAGNANI, CESARE (1822–), Italian general and knight of the Annunziata, was born at Borgo Lazzevoro on the 30th of June 1822. As artillery lieutenant he distinguished himself and was wounded at the siege of Peschiera in 1848, and in 1852 gained further distinction by his efforts

to prevent the explosion of a burning powder magazine. After serving from 1856 to 1859 as director of the Artillery School, he became general of division in 1864, commanding the 5th division at the battle of San Martino. In the war of 1866 he stormed Borgoforte, to open a passage for Cialdini's army. Upon the death of General Govone in 1872 he was appointed minister of war, and after the occupation of Rome bent all his efforts to army reform, in accordance with the lessons of the Franco-German War. He shortened the period of military service; extended conscription to all able-bodied men; created a permanent army, a mobile militia and a reserve; commanded the renewal of armaments; and placed Italy in a position to put 1,800,000 men on a war footing. Ricotti fell from power with the Right in 1876, but returned to office with Depretis in 1884, and amended his previous scheme of reform. Resigning in April 1887, he became a member of the senate in 1890, but took little part in public life until 1896, when, after the battle of Adowa, he was entrusted by King Humbert with the formation of a cabinet. Having constructed his ministry, he made over the premiership to the marquis di Rudini, retaining for himself the portfolio of war, and seeking to satisfy popular demands for the reduction of military expenditure by consolidating the tactical structure of the army without weakening its fighting power. Rudini, however, finding that Ricotti's ideas, which he himself shared, were not acceptable at court, obliged him to resign office. His prestige as creator of the modern Italian army remained unimpaired, and his views on army consolidation enjoyed a large measure of technical and public favour.

RIDDING, GEORGE (1828–1904), English headmaster and bishop, was born at Winchester College, of which his father, the Rev. Charles Ridding, vicar of Andover, was a fellow, on the 16th of March 1828. He was educated at Winchester and Balliol College, Oxford. He became a fellow of Exeter College and was a tutor from 1853 to 1863. In 1853 he married Mary Louisa Moberly, who died within a year of her marriage. He was appointed second master of Winchester College in 1863, and on the retirement of his father-in-law, Dr Moberly, he succeeded to the headmastership. During the tenure of this office (1867–1884) he carried out successfully a series of radical reforms in the organization of the school, resulting in a great increase both in its reputation and numbers. In 1884 he became the first bishop of Southwell, and brought his powers of organization and conspicuous tact and moderation to bear on the management of the new diocese. He took an active share in its educational and social work, and was materially assisted in these respects by his second wife, Lady Laura Palmer, daughter of the 1st earl of Selborne. He resigned his see a short time before his death, which took place on the 30th of August 1904.

See *Church Quarterly Review* (July 1905).

RIDDLES (A.S. *raedan*, to interpret), probably the oldest extant form of humour. They spring from man's earliest perception that there are such things as analogies in nature. Man observes an example of analogy, puts his observations in the form of a question, and there is the riddle ready made. Some Boeotian humorist, for example, detected the analogy between the life of humanity—the child on all fours, the man erect on two legs, old age with its staff—on one side, and on the other the conception of an animal with a varying number of limbs. Put this in a question and it is the riddle of the Sphinx. Another instance is the question, "What we caught we threw away, what we could not catch we kept." Homer is said to have died of vexation at not being able to discover the answer to this riddle, still current on the coast of Brittany, in Germany and in Gascony. After inventing the riddle, men began to use it in a kind of game; bets were staked on the answer and sides were made, each side backing its champion. These sports in Marriner's time were common in Tonga; they are no less popular among the African Woloffs. Samson's riddle set to the Philistines is an instance of the sport in a Semitic country. In märchen and ballads, the hero's chance of

winning his beloved, or of escaping threatened punishment, is often made to turn on his power of answering riddles. It follows from the artless and primitive character of the riddle that regular popular riddles (*Devinettes*) are widely distributed, like popular tales, popular songs and popular customs. The Wolfos asks, "What flies for ever, and rests never?" Answer, The wind. The Basutos put this riddle, "What is wingless and legless, yet flies fast and cannot be imprisoned?" Answer, The voice. The German riddle runs, "What can go in face of the sun yet leave no shadow?" Answer, The wind. In riddles may perhaps be noticed the animistic or personalizing tendency of early human thought, just beginning to be conscious of itself. The person who asked these riddles had the old sense of wind, for example, as a person, yet probably, unlike the bushmen, he would never expect to see the personal wind. He knew the distinction between the personal and impersonal well enough to be sure that his enigma would present some difficulty. The riddle, to be brief, is an interrogatory form of the fable, and like the fable originates among rude people, and is perpetuated in the folklore of peasantry.

Probably the best book on the riddle (a subject less frequently studied than the *märchen* or the myth) is Eugène Rolland, *Devinettes ou énigmes populaires*, with a preface by M. Gaston Paris. The power of answering riddles among the people who invented the legend of Solomon and the queen of Sheba seems to have been regarded as a proof of great sagacity. The riddle proper is all but extinct outside folklore and savage life, and has been replaced by the conundrum, which is a pun in the interrogative form.

OLD ENGLISH RIDDLES.—A number of interesting poetical riddles in old English are contained in the *Exeter Book*, written about A.D. 1000. According to the numbering in the only complete edition (in Grein-Wülker, *Bibliothek der Angelsächsischen Poesie*, vol. iii, pp. 184-238), there would appear to be 95 of them; but No. 1 in the monotonous line *Wulf and Eadwacer*, which was included among the riddles by a mistake of the first editor of the *Exeter Book*, B. Thorpe; No. 9 is not in Old English, but in Latin; and several others are mere unintelligible fragments. There remain about 85 that have been preserved either entire or with sufficient approach to completeness for their general drift to be perceived.

The riddles Nos. 2-60 occupy 15 folios in the middle of the MS.; Nos. 62-95 occupy the last 7 folios, and No. 61 and a mutilated and divergent copy of No. 31 are placed by themselves among poems of a different kind. Attempts have been made to show that the two main groups are distinguished from each other by special characteristics that may indicate difference of authorship or date; but there seems to be no good reason for attaching any significance to the arrangement of the MS. Some of the riddles almost certainly were written in Northumbria in the early part of the 8th century; a copy of one of them (No. 36), in Anglian dialect, has been preserved in a MS. at Leiden. Whether all the riddles are the work of one author, or whether they belong to different periods and districts, remains at present uncertain. For the reasons stated in the article *CYNEWULF* the attribution of the whole collection to that poet, once almost universally accepted, is now no longer tenable; and there is no overwhelming probability that he is the author of any portion of it.¹

The investigations of F. Dietrich and A. Ebert have established the fact that a few of the riddles are imitated from the Latin enigmas of Symposius and Aldhelm. No. 36 is a translation of Aldhelm's riddle *De Loricæ*, and No. 41 is founded on the same writer's riddle *De Centauro*. The dependence of the Old English riddles on Latin originals has, however, been greatly exaggerated, especially by A. Prehn (*Komposition und Quellen der Rätsel des Exeterbuches*, 1883), who goes so far as to maintain that every one of them contains reminiscences of one or more of the compositions of Symposius, Aldhelm, Tatwine and Eusebius. The correspondences alleged are in most cases slight, if not purely fanciful, and it is even doubtful whether the two writers last named were known at all to the authors of the vernacular riddles. All the Englishmen who wrote riddles in the 8th and following centuries, whether they wrote in their native tongue or in Latin, may be said to belong to one school, and their work has many features in common. But except in a few instances the riddles written in Old English are probably not less but more original than those of the Latin school, and in poetical merit they are generally superior. A good notion of their character and style may be gained from Mr Stoptford Brooke's spirited (though not minutely accurate) translations of many of them in his *History*

of *Early English Literature*, vol. i. (1892). Mr Brooke's interpretation of No. 11 (the Barnacle Goose) is original, and no doubt correct: in some other instances the solutions he has adopted are somewhat more questionable than they would appear to be from his translations.

Unlike the Latin riddles of Aldhelm, the riddles of the Exeter Book are unaccompanied with solutions. In some of them, however, the answer is indicated by an anagram, usually expressed in runic characters. Thus No. 24 begins with the words "AgoF is my name reversed," where the West Saxon scribe, in accordance with the phonetic laws of his own dialect, has substituted F for the final B of his Anglian original; the word is an anagram of *hoga*, "bow." In No. 25 the mimic skill of the magpie is described, and at the conclusion the name of the bird (*higora*) is indicated by the six letters G, A, R, O, H, I.

The solution of nearly all the riddles was attempted by F. Dietrich, in the 11th and 12th volumes of Haupt's *Zeitschrift für deutsches Alterthum*. In many cases Dietrich was certainly right, but in many others his conjectures are strangely perverse, owing to misleading comparisons with supposed Latin originals. Subsequent scholars have been much more successful in refuting Dietrich's explanations than in replacing them by others more satisfactory. The most copious contributor of new interpretations has been Prof. M. Trautmann, in several articles in *Anglia*, and also in Bonner *Beiträge zur Anglistik*, No. 19 (1902); but very few of his interpretations can be considered even plausible, and he sometimes rejects the solutions of his predecessors when they are probably right. One riddle (No. 51, Fire) was independently solved by Prof. Trautmann and G. Herzfeld (*Die Rätsel des Exeterbuches und ihr Verfasser*, 1890). The articles on the subject by F. Tupper, Jr., in *Modern Philology*, vol. ii. (1903), and in *Modern Language Notes* for 1903 and 1906, are extremely valuable, though the author's original explanations do not appear convincing. After all that has been done, the meaning of a considerable number of the riddles is still uncertain. In some instances this may be due to the corrupt state of the text; in others the terms in which the object is described are so vague that several solutions are equally plausible. (H. BR.)

RIDGE, WILLIAM PETER (1864—), English author, was born at Chartham, near Canterbury, and was educated at Marden, Kent, and at the Birkbeck Institute, London. He was for some time a clerk in the Railway Clearing House, and began about 1891 to write humorous sketches for the *St James's Gazette* and other papers. He secured his first striking success, in volume form, with *Mord Em'ly* (1898), an excellent example of his ability to draw humorous portraits of lower class life. His later books include *A Son of the State* (1899), *A Breaker of Laws* (1900), *Lost Property* (1902), *Erb* (1903), *Mrs Caler's Business* (1905), *The Wickhamses* (1906), &c.

RIDGE (a word common to many Teutonic languages, meaning "back," whether of a man or an animal, cf. German *Rücke*), the word applied to many objects resembling the projecting line of an animal's back, such as the strip of soil thrown up by a plough between furrows, the elevations or protuberances on bones which serve for the attachment of muscles or ligaments, &c. In architecture the ridge (Fr. *faîte*, *crête*; Gr. *First*; Ital. *asinello*) is the highest portion of a roof, which is covered with lead, slate, or tiles, and sometimes decorated with a cresting in terra-cotta or metal-work. The term is also applied to the meeting of the common rafters on each side of a roof, which are sometimes butted against an upright board known as the ridge-piece. For the ridge-rib see Rib.

RIDING, the art or practice of locomotion on the back of an animal or in a vehicle (the verb *to ride* originally meant "to travel," or "go," as the derived noun *road* means "a way"), where no vehicle is specified (e.g. "riding a bicycle"), the word is associated with horseback riding, for exercise or pleasure.

The origin of the use of the horse as a means of transport goes back to prehistoric times. The fable of the centaurs, if the derivation from *κέντρειν*, to goad, *ταύρος*, bull, be accepted (but see CENTAUR), would indicate the early existence of pastoral peoples living on horseback, like the modern cowboys (cp. "cow-punchers") or *gauchos* of North and South America. Archaeological discoveries in India, Persia, Assyria and Egypt show that in the polished stone age quaternary man had domesticated the horse, while a Chinese treatise, the *Gooi-jeotse*, the fifth book of the *Yueking*, a sort of military code dating from the reign of the emperor Hoang-Ti (2637 years B.C.), places the cavalry on the wings of the army. The Hebrews understood

¹ For the linguistic arguments against Cynewulf's authorship of the Riddles see especially A. Madert, *Die Sprache der altenglischen Rätsel des Exeterbuches und die Cynewulf-Frage* (1900).

the use of the horse in war (Job xxxix. 18-25), as did the Persians (Cyrus at the battle of Thymbra), Greeks and Romans. The Greeks and Romans, especially the former, were skilled horsemen, and feats on horseback were a feature of their games. They used no stirrup, but had both bridle and bit. They rode bareback, or on a cloth or skin strapped to the horse.

When roads were poor and vehicles cumbersome horseback was almost the only method of travel for both sexes. With the introduction of steam-locomotion and the improvement of roads, however, riding has become to a large extent a sport, rather than a necessity. There are different styles of riding adapted to the different purposes for which horses are ridden—on the road, in the school, hunting, racing, steeple-chasing and in the cavalry service—just as there are different horses more suitable by conformation, breeding and training for each.

In western civilization there is a traditional difference between the riding of men and women, in this particular, that men ride astride and women on a side-saddle. But in the following observations we deal generally with the more important features of riding as practised astride.

After securing an animal of the right height, weight and disposition, with a saddle of a length of treecand a breadth of seat that fits the rider and that is lined to fit the back of the horse, with a bridle bitted to his mouth, the first step is to mount. Having taken up the reins, the rider should stand at his horse's near (left) shoulder, facing towards the tail, and in that position hold the stirrup with his right hand for the reception of his left foot. By standing at the shoulder the rider is out of harm's way in the event of the horse kicking while he mounts. Ladies generally have the aid of a block or a groom's or escort's hand beneath the left foot. But a woman should be able to mount without aid, by lowering her stirrup, so that she can reach it from the ground, and then raising it again when she is seated in the saddle. Riding astride is sometimes recommended for women. The chief argument in its favour—symmetrical development of the figure—is, however, lost if the growing girl be taught to ride on a side-saddle of which the pommels can be shifted to the off side on alternate days.

Having gained the saddle, the necessity arises for *seat* and *hands*. Here good instruction is imperative at the outset. The great desideratum in a seat on horseback is that it should be firm. A rider with an insecure seat is apt to be thrown by any unexpected movement the horse may make; and, without a firm seat, the acquirement of good hands is well-nigh hopeless, because, when the balance is once disturbed the insecure rider will have to depend on something else for the maintenance of his seat, and this generally takes the shape of "riding on the horse's mouth," a practice as cruel as it is ugly.

Having gained the saddle, the rider should adjust the stirrups to the proper length, depending on the kind of riding, the length of his leg and the roughness of the horse's trot. Sitting well in the middle of the saddle, the thighs turned in, and the heels drawn somewhat back, the stirrup leathers may be let out or taken up until the tread of the stirrup is on a level with the inner ankle bone, and at this length, when the rider stands up, his fork will easily clear the pommel of the saddle. For maintaining his seat the horseman should depend upon his thighs and knees only, and not upon the knee and calf; a proper seat should be a mixture of balance and grip; a man riding by balance only is sure to be thrown, while to grip with all one's might during an hour's ride is to undertake as much exertion as should last for a whole day. The position of the foot exercises much influence on the security of the seat; it should be opposite the girth, parallel with the barrel of the horse, with the heels depressed. A good seat on a horse should not be strong merely; it should be graceful; above the loins the body should be loose, so as readily to adapt itself to every motion of the horse, but it should be upright.

Beginners are advised to practise riding with and without stirrups; thus, let the pupil who has ridden half an hour in a saddle with stirrups have a cloth substituted for the saddle for about ten minutes, care being taken to observe the rules already

laid down for the position of the legs; in this way the proper seat will be strengthened.

The proper adjustment of the reins is the next thing to be attended to, and as the management of these depends so much upon the seat being firm and independent of the bridle the acquisition of a firm seat is certainly half-way towards the acquirement of good hands. An excellent way to start a pupil is on a sure-footed horse without bridle, the master governing him by a leading rein until the pupil has acquired a firm seat and can be trusted with reins. Assuming that a double-reined bridle is used, the third finger of the left hand should be first inserted between the snaffle reins; then the little, third and second fingers should be between the curb reins, the two outside reins being the curb, and the two inside ones the snaffle. In this manner of holding the reins the snaffle is not so likely to slip, while the curb can be easily slackened or drawn tighter. As military riders use the curb only the position of snaffle and curb as just explained is reversed in the cavalry service. The snaffle reins should be drawn up gently until the rider feels that he has an equal and light hold of his horse's mouth on both sides, with just so much pressure that the slightest movement of the left or right rein would cause him to turn to the left or right respectively. The arms from the shoulder to the elbow should hang naturally, close to the sides, and the arms from elbow to wrist should be about parallel to the ground, the wrist being kept loose, so as to yield gently with every motion of the horse. The rider sitting in the position described, square to the front, with his shoulders well back, will be riding with fairly long reins, one of the secrets of good hands.

When the horse is in motion the hands should not be held rigid; as the horse's mouth would thereby become dead, and the horse would lean unpleasantly on the hand; but the rider should give and take, without, however, entirely relaxing the hold.

In order to encourage the horse to walk the head must not be confined, but a light feeling of the horse's mouth must be kept up. Should the horse, unasked, break into a trot, never snatch at his mouth, but restrain him gently. To trot, press the legs to the saddle, and raise the bridle hand a little, and, after a moment's sitting close, begin to rise ("pose") in cadence with the action of the horse. The rising to the trot should be performed easily; the legs must not swing backwards and forwards, nor should the hands be jerked up and down. To start the canter, which should always be done from the walk and not the trot, take up the curb rein a little and turn the horse's head slightly to the right, at the same time pressing the left leg behind the girth; the horse will then lead with the off (right) fore leg, which is generally preferred; but a well-broken hack should lead with either leg at command, and if he be cantered in a circle to the left he must lead with the near leg, as otherwise an ugly fall is likely to result from the leg being crossed. Galloping is a pace not to be generally indulged in by road or park riders; when it is, the hands should be kept low, the body thrown back, and an extra grip taken with the knees, as nearly all horses pull more or less when extended.

Hitherto only road or park riding has been considered. When a person has become a fair road rider he has made some progress towards being a hunting man. But if his first principles are disregarded, and a follower of hounds believes in the system "it doesn't matter how you ride so long as you stick on," he will not only always be a "sight" but a menace in the hunting field. Few self-taught riders attain to excellence; they may keep a good place in hunting, if possessed of plenty of courage, and mounted on a bold and not too tender-mouthed horse, but they never will be riders in the proper sense of the word.

Hunting and Riding to Hounds.—For practical purposes the chief difference between a park seat and a hunting seat consists in the shortening of the stirrups some two or three holes. The seat of the hunting man is the most important of any connected with amusement; he must sit firm, so as not to be thrown off when his horse leaps, or makes a mistake, and he must be able to save his horse under all circumstances, and to make as much of him as possible. As with road riding, so with hunting, the actual

length of the stirrups will depend a good deal upon the shape and action of the horse, but the nature of the animal and the peculiarities of the country ridden over will also have something to do with their adjustment. A puller will compel the rider to shorten his leathers one or perhaps two holes—a course that may also be rendered necessary in a hilly country, for, in going down hill, the stirrups, if kept at the ordinary length, will generally feel a great deal too long. The rider's body must be always close to the saddle in jumping, for if he were jerked up, the weight of his body, a ro-stone man coming down on the heels a couple of seconds after he has negotiated a large fence is sufficient to throw the animal down. Nothing but actual practice with hounds can teach a man how to ride where all kinds of going and obstacles of various sorts, natural and artificial, have to be encountered in a day's hunting. For example, the country gone over is seldom level springy turf; it is up hill and down dale, across ridge and furrow, over ground studded with ant-hills (which, unlike mole-hills, are often very hard), over ploughed or boggy land. Each of these varieties requires a different method of riding over, and nearly every horse will require different handling under similar circumstances. It will therefore be seen that much depends on the rider having good hands. This qualification, though generally understood, is difficult to define. A rider with good hands never depends upon his reins for retaining his seat; nor does he pull at the horse's mouth so as to make him afraid to go up to his bit; nor again does he ever use more force than is necessary for the accomplishment of what he desires to perform. But besides all this, there is an unaccountable sympathetic something about the man with good hands that cannot be described. Fullers appear to renounce pulling, refusers take to jumping and are found to become horses as readily as a trick horse in a circus. Though hands can to a great extent be acquired by care and practice, yet in the highest form this is a gift and cannot be learned.

There are different kinds of "fences," as all obstacles are generically called. First, there is timber, such as gates, stiles and rails; the first two are, nine times out of ten, awkward jumps, as the take off is either poached by cattle, or else is on the ascent or descent. Hedges vary according to the custom of the country in which they are found: they either grow in the soil of the field, and are protected by a ditch on one side, or are planted on a bank with a ditch on one side or sometimes on both. Then again there are such large banks as are found in Wales, Devon and Cornwall. Lastly, there come water jumps, which are met with in two forms: the water is either within an inch or two of the top of the bank, so as to be about on a level with the field through which it flows, or there may be a space of some 6 or 7 ft. from the bank to the water. For the successful negotiation of brooks a bold horse is required, ridden by a bold man. No fence that is ever encountered stops such a large proportion of the field as water; even a clear 6 ft. of it will prove a hindrance to some, while anything over 10 or 12 ft. will in general be crossed only by a very few. Some horses, good performers over any description of fence, will not jump water under any circumstances; while the chance of a ducking deters many from riding at it; and, however bold the horse may be, he will soon refuse water if his rider be perpetually in two minds when approaching it.

The pace at which a hunter should be ridden at his fences depends upon the nature of the fence, and the peculiarities of each individual horse. With some very good jumpers—they can hardly be called good hunters—to steady them is to bid for a fall, while with some very clever hunters to hurry them is to bring them to grief. With ordinary horses, however, it is a good general rule to ride at fences of all descriptions as slowly as the nature of the obstacle admits. In grass countries, where flying fences are found, the rate of gallop must be maintained as steadily as when riding at a fence. A Devonshire bank of some 7 ft. high, but even at a flying fence the rider should steady his horse so as to contract the length of his stride, in order that he may measure the distance for taking off with greater accuracy. Flying fences consist of a hedge with or without a post and rail, and with or without a ditch on one or both sides; consequently a horse has to jump both high and wide to clear them. But in jumping a gate, or a flight of rails, as ordinarily situated, there is no width to be covered, and to make a horse go through the exertion of jumping both high and wide when he need only do one is to waste his power, added to what is to be expended at timber, unless very low with a ditch on the landing side, is highly dangerous.

All hedges on banks, banks and doubles must be ridden at slowly; they are usually of such a size as to make flying them impossible, or at least undesirable. Horses jump them on and off, and in taking them at a moderate pace there is a chance of stopping on the top and choosing a better place to jump from, or, if needs be, of returning and taking the fence at another place. Cramped places will have to be jumped from a walk or even at a stand; for instance, a tree may be in a line with and close to the only practical place for a fence; the fence then becomes necessary to go round the tree before a run at the place can be managed. So, too, with places that have to be crawled over between trees, and with dykes to be crawled down.

In jumping an ordinary hedge or ditch at moderate speed, there is of course a moment of time during which the horse is on his

hind legs, and in theory the rider should then lean forward, but, in practice, this position is so momentary, and the lash out of the hind legs in the spring is so powerful, that it is best not to lean forward at all, because of the difficulty, if not impossibility, of getting back in time for the reverse movement, when the rider should be preparing to render the horse some assistance with the bridle as his feet touch the ground.

When a line of willows indicates the whereabouts of a brook, the horse should be well collected, a clear place selected, so far as circumstances allow, and the pace increased, though in short strides, up to the very brink. If the hounds jump at the brook, even though they fail to clear it, the rider may take it for granted that at that place the leap is within the capacity of any ordinary hunter in his stride; hence if, when going at three parts speed, a horse's feet come just right to take off, the mere momentum of his body would take him over a place 15 ft. wide.

The experience of a single day's hunting will teach the novice that gates are far oftener opened than jumped; it is therefore necessary that a hunter should be handy at opening them. Many accidents have arisen from horses rushing through a gateway directly the latch is released, or from their jumping a gate at which they have been pulled up to enable the rider to open it. The horse should be taught to obey the leg as well as the hand, and, by a slight pressure of the leg, should throw his haunches round to the left or right as occasion may require.

Racing (see also HORSE-RACING).—The qualities possessed by a good jockey, either on the flat or across-country, show the value of early instruction in riding. After having been some time in a training stable, a lad is put on a quiet horse at exercise; his stirrups are adjusted, and the reins knotted for him at a proper length. He subsequently rides other horses, each with some peculiarity perhaps, and, to keep his place in the string, a slugging must be kept going, and an impetuous one restrained; they cannot both be ridden alike, but they must both be ridden as a jockey should ride them. In this way the lad learns the principle of holding a puller, getting pace out of a lazy one, and leaving well alone with a nice free but temperate mover; he learns to do everything in a horsemanlike manner, and when he has raised himself to the pitch of a "fashionable" jockey, he will frequently be called upon to ride several horses a day at race meetings. A jockey must therefore, more than any other civilian rider, have a hand for all sorts of horses, and in the case of two and three-year olds a very good hand it must be. The same ability to adapt himself to circumstances must be possessed by the steeple-chase jockey, who should possess fine hands to enable him to handle his horse while going at his fences at three-quarter speed. In most details the nearer a hunting man approaches to a steeple-chase jockey the better; but in the matter of the seat it must be remembered that a jockey's exertions last but a few minutes, while none can tell when the hunting man may finish his day's work; the jockey can therefore ride with more absolute grip during his race than the rider to hounds.

See also HORSEMANSHIP; HUNTING; CAVALRY; RACING AND STEEPLE-CHASE; and POLO.

RIDINGS are the three districts into which from ancient times Yorkshire has been divided for administrative purposes. Formerly there were similar districts in Lindsey in Lincolnshire. The word riding was originally written as *thriding* or *thriding*, but the initial *th* has been absorbed in the final *th* or *t* of the words north, south, east and west, by which it was normally preceded. Ridings are Scandinavian institutions. In Iceland the third part of a *thing* which corresponds roughly to an English county was called *thringjungur*; in Norway, however, the *thringjungur* seems to have been an ecclesiastical division. According to the 12th-century compilation known as the "laws of Edward the Confessor," the riding was the third part of a county (*provincia*); to it cases were brought which could not be determined in the wapentake, and a matter which could not be determined in the riding was brought into the court of the shire. There is abundant evidence that riding courts were held after the Norman Conquest. A charter which Henry I. granted to the Church of St Peter's at York mentions wapentacmot, tridingmot and shiresmot, and exemptions from suit to the thriding or riding may be noticed frequently in the charters of the Norman kings. As yet, however, the jurisdiction and functions of these courts have not been ascertained. It seems probable from the silence of the records that they had already fallen into disuse early in the 13th century.

Each of the ridings of Yorkshire has its own lord lieutenant and commission of the peace, and under the Local Government Act of 1885 forms a separate administrative county. They are distinguished as the north, east and west ridings, but the ancient

divisions of Lindsey were known as the north, south and west ridings respectively.

See Felix Liebermann, *Die Gesetze der Angelsachsen* (Hallé, 1888-89); William Stubbs, *Constitutional History of England*; Richard Cleasby, *Icelandic Dictionary*; *New English Dictionary*; and William Dugdale, *Monasticon Anglicanum*, vol. vi., edited by John Cayley and others (1846). (G. J. T.)

RIDLEY, NICHOLAS (c. 1500-1555), English bishop and martyr, was descended from an old Northumberland family. The second son of Christopher Ridley of Unthank Hall, near Willemoteswick, in that county, he was born in the beginning of the 16th century. From a school at Newcastle-on-Tyne he was sent about 1518 to Pembroke Hall, Cambridge, being supported there by his uncle, Dr Robert Ridley (d. 1536), and specially distinguishing himself in Greek. Having graduated M.A. in 1526, he went to study at the Sorbonne in Paris and at Louvain, and on his return to Cambridge he was appointed junior treasurer of his college. In 1534 he was one of the university proctors, and he signed the decree of the university against the jurisdiction of the pope in England. About this time Ridley, who was now chaplain to the university, began to distinguish himself as an orator and a disputant, and to show leanings to the reformed faith. Having proceeded B.D. in 1537, he was appointed by Thomas Cranmer, archbishop of Canterbury, one of his chaplains, and in April 1538 the same prelate instituted him to the vicarage of Herne in Kent. In 1540 he was chosen master of Pembroke Hall; in 1541 he became chaplain to Henry VIII. and canon of Canterbury. In 1543 he was accused of heretical teaching and practices, but he managed to allay the suspicions of the royal commissioners, although just after his exculpation he finally abandoned the doctrine of transubstantiation.

In 1547 Ridley was presented by his college to the Cambridge-shire living of Soham, and in September of the same year he was nominated bishop of Rochester. Edward VI. was now on the throne and the new bishop was in high favour. He was one of the visitors who were appointed to establish protestantism in the university of Cambridge; in 1548 he helped to compile the English prayer book; and in 1549 he was one of the commissioners who examined Bishops Gardiner and Bonner. He concurred in their deprivation and succeeded Bonner in the see of London. Having signed the letters patent settling the English crown on Lady Jane Grey, Ridley, in a sermon preached at St Paul's cross on the 9th of July 1553, affirmed that the princesses Mary and Elizabeth were illegitimate and that the succession of the former would be disastrous to the religious interests of England. When Lady Jane's cause was lost, however, he went to Framlingham to ask Queen Mary's pardon, but at once he was arrested and sent to the Tower of London. From his prison he wrote in defence of his religious opinions, and early in 1554 he, with Cranmer and Latimer, was sent to Oxford to be examined. He defended himself against a number of divines, but was declared a heretic, and this was followed by his excommunication. He refused to recant, and in October 1555 he was tried for heresy under the new penal laws, being degraded and sentenced to death. With Cranmer and Latimer he met his end at the stake in Oxford on the 16th of October 1555.

Ridley was a voluminous writer, but many of his writings have been lost. The *Works of Nicholas Ridley D.D.* were edited for the Parker Society by the Rev. Henry Christmas in 1841. His *Life* was written by Dr Gloucester Ridley in 1763, and there is a memoir of him in H. C. G. Moule's edition of the bishops' *Declaration of the Lord's Supper* (1895). See also John Foxe's *Acts and Monuments* (new ed., 1877); J. Strype's *Memorials of Cranmer* (new ed., Oxford, 1840); G. Burnett's *History of the Reformation* (new ed., Oxford, 1865); J. A. Froude's *History of England* (1881 fol.); and J. Lingard's *History of England* (1854-55).

RIDOLFI, or RIDOLFO, ROBERTO DI (1531-1612), Italian conspirator, belonged to a famous family of Florence, where he was born on the 18th of November 1531. As a banker he had business connexions with England, and about 1555 he settled in London, where he soon became a person of some importance, and consorted with William Cecil and other prominent men.

During the early years of Elizabeth's reign he began to take a more active part in politics, associating with the discontented Roman Catholics in England and communicating with their friends abroad. In 1570 he set to work on the plot against the queen which is usually associated with his name. His intention was to marry Mary, queen of Scots, to the duke of Norfolk and to place her on the English throne. With the aid of John Lesley, bishop of Ross, he gained the consent of these high personages to the conspiracy, and then in 1571 he visited the duke of Alva at Brussels, Pius V. at Rome, and Philip II. at Madrid to explain to them his scheme and to gain their active assistance thereto. His messenger, by name Charles Baillic (1542-1625), was, however, seized at Dover, and in other ways the English government heard of the intended rising. Consequently, Norfolk and Lesley were arrested, the former being condemned to death in January 1572. Ridolfi, who was then in Paris, could do nothing when he heard this news, and his scheme collapsed. Afterwards he served the pope, but much of his later life was spent in Florence, where he became a senator and where he died on the 18th of February 1612.

RIEGER, PHILIPP FRIEDRICK VON (1818-1903), Bohemian politician and publicist, was born on the 18th of December 1818 at Semil in the circle of Jičín, Bohemia. He first came into prominence as one of the Czech leaders in the revolution of 1848. He was returned by seven constituencies to the *Reichstag* at Vienna, where he was the leader of the Czech party. In 1853 he married a daughter of the historian Palacky. In 1858 he started the *Slovník naučný*, the Czech national encyclopaedia, the first volume of which was published in 1859, the 11th and last in 1874. He was also instrumental in founding the first Czech political daily newspaper published in Prague, which appeared on the 1st of January 1861, and of which he was for awhile the editor. After the issue of the "October diploma" of 1860, Rieger, with his father-in-law, Palacky, undertook the leadership of the reconstituted Czech party, and after the decision of this party in 1863 no longer to attend the Austrian *Reichsrath*, he led the agitation in favour of the restoration of the Bohemian kingdom. In 1871 he conducted the negotiations with the Hohenwarth ministry for a federal constitution of the empire, which broke down owing to his extreme attitude in the matter of Bohemian independence. On the reappearance of the Czechs in the Bohemian diet (1878) and the Austrian *Reichsrath* (1879) Rieger was one of the leaders of the federalist majority supporting Count Taaffe's government and the chief of the so-called "Old Czechs." On his seventieth birthday (December 10, 1888) he received a national gift of 100,000 gulden; but, in spite of this evidence of his popularity, his conservatism, his close connexion with the Bohemian nobility and his clerical tendencies brought him into conflict with the growing influence of the radical "Young Czech" party, and in 1891, together with the other "Old Czechs," he was defeated at the poll. In March 1897 he was created a baron (*Freiherr*) and given a seat in the Upper House. He continued occasionally to interfere in politics; but his influence was now at an end, though when he died, on the 3rd of March 1903, his funeral at Prague was made the occasion of a magnificent demonstration of respect.

RIEGO NUÑEZ, RAFAEL DEL (1784-1823), Spanish army officer, who has the melancholy distinction of having begun the long series of political military mutinies—*pronunciamientos*—in Spain, was born at Santa Maria de Tuna in Asturias on the 2nd of April 1784. He was educated for the legal profession at Oviedo, and passed the necessary examinations. But in 1807 he enlisted in the guard. When the French invasion took place in 1808 he was employed by the junta of Asturias and placed in command of a newly raised battalion. He was taken prisoner at the battle of Espinosa de los Monteros, on the 10th and 11th of November 1808, and was sent to France. During his years of imprisonment he, like many others of his countrymen, was converted to liberalism on the French model. Riego had the good fortune to escape and to reach England after various wanderings in Switzerland and Germany. In England

he was incorporated with other rescued or escaped Spaniards, in a corps equipped by the British government, and was sent to Spain in 1814. He continued in service as a military officer, and was commandant of the second battalion of the regiment "Asturias," which formed part of the army collected at Cadiz to be sent to South America in 1819. Service in America was unpopular with the soldiers, and there was much discontent in the country with the government of King Ferdinand VII. A conspiracy was formed among the officers to use the army for the purpose of forcing the king to grant a constitution. They were betrayed by a general who at first professed to sympathize with them, and many were arrested. Riego was apparently not suspected, and he decided to act on his own account. On New Year's Day 1820 he made his *pronunciamiento* with his regiment at the village of Cabezas de San Juan. He proclaimed for the constitution drawn up by the Cortes in 1812, which was unworkable, and which the chiefs of the conspiracy did not propose to restore. He hoped to seize Cadiz, but it was held by a loyal officer, and for a time no popular movement took place. Riego now started on a revolutionary propaganda through Andalusia at the head of his regiment. The country proved hostile or at the best indifferent. His following gradually melted away, and he was about to flee to Portugal when Galicia revolted. The rebellion extended rapidly, and the king was compelled to yield. When the liberals were in possession of power they would gladly have kept Riego in a subordinate place. But he came to the capital, where he was soon the most popular spokesman of the extreme parties. There he discredited himself by his vanity, and shocked even the populace of Madrid by appearing drunk at the theatre. He was at last persuaded to accept the military command in Aragon, which he thought below his merits. He began intrigues and agitations. The government was strong enough to put him under arrest at Lérida. When the new Cortes was elected in 1822, he was chosen deputy for his native city Oviedo, and the radicals selected him as president of the chamber on the 17th of February 1823. The unceasing intrigues of the king, the incapacity of the moderate parties and the hysterical excitement of the mob combined to make anarchy worse daily. Riego was the noisiest shouter of all. When the French intervention took place, he helped to carry the king to Cadiz, and he fought a few unsuccessful skirmishes with the invaders. He was at last captured at a farmhouse near Arguillos in the province of Jaen. Unfortunately for him, he fell into the hands of the royalist volunteers, by whom he was carried to the capital. On his way he was repeatedly mobbed and had many narrow escapes from being torn to pieces. He was hanged at Madrid in the Plaza de la Cebada on the 7th of November 1823. At the end he professed abject repentance for his impiety and disloyalty. The popular revolutionary tune of Spain, the "himno de Riego," is named after him, and his picture is hung in the Cortes, but he was a poor creature, and a bad example of the light-headed military agitators who have caused Spain much misery.

H. Baumgarten, *Geschichte Spaniens* (Berlin, 1865-1871).

RIEHM, EDUARD KARL AUGUST (1830-1888), German Protestant theologian, was born at Diersburg in Baden on the 20th of December 1830. He studied theology and philology at Heidelberg and later at Halle under Hermann Hupfeld, who persuaded him to include Arabic, Syriac and Egyptian. Entering the ministry in 1853, he was made vicar at Durlach soon afterwards, and became a licentiate in the theological faculty at Heidelberg. In 1854 he was appointed garrison-preacher at Mannheim; and in 1858 he was licensed to lecture at Heidelberg, where in 1861 he was made professor extraordinary. In 1862 he obtained a similar post at Halle, and in 1866 was promoted to the rank of professor ordinarius. Throughout his life he followed Hupfeld's plan in his scientific treatment of the Old Testament—that of reconciling the results of a free criticism with a belief in divine revelations. His practical experience of pastoral work also proved of service to him when he became a professor of theology, for "if there is one quality more striking

than another in the writings of Riehm, it is that of sympathy with orthodox believers" (T. K. Cheyne). In 1865 Riehm was made a member of the commission for the revision of Luther's translation of the Bible, and became one of the editors of the quarterly review, *Theologische Studien und Kritiken*. He died on the 5th of April 1888.

His works include: *Die Gesetzgebung Moses im Lande Moab* (1854), in which the Deuteronomic law book is assigned to the second half of the reign of Manasse; *Der Lehrbegriff des Hebräerbriefts* (1858-59, 2nd ed. 1867); Hermann Hupfeld, *Lebens- und Charakterbild eines deutschen Professors* (1867); *Die Messianische Versetzung* (1875, 2nd ed. 1883; Eng. trans. 1890); *Religion und Wissenschaft* (1881); and the well-known *Handwörterbuch des biblischen Altertums* (2 vols., 1884; 2nd ed. revised by F. Baethgen, 1892-94). After his death were published the *Einleitung in das Alte Testament* (1889, ed. by A. Brandt), in which the date of the Deuteronomic law book is placed earlier than in his book on the legislation of Moses—shortly before or at the beginning of the reign of Hezekiah; and his *Alttestamentliche Theologie* (1889, ed. by Pahncke). See Herzog-Hauck, *Realencyclopädie*, and T. K. Cheyne, *Founders of Old Testament Criticism*.

RIEL, LOUIS (1844-1885), Canadian agitator, son of Louis Riel and Julie de Lagemaundière, was born at St Boniface, on the 23rd of October 1844, according to his own account, though others place his birth in 1847. Though known as a half-breed, or Métis, and though with both Indian and Irish ancestors, his blood was mainly French. From July 1866 he worked for two years at various occupations in Minnesota, returning in July 1868 to St Vital, near St Boniface. In 1869 the transfer of the territorial rights of the Hudson's Bay Company to the dominion of Canada gave great uneasiness to the Métis, and in October 1869 a party led by Riel turned back at the American frontier the newly appointed Canadian governor; in November they captured Fort Garry (Winnipeg), the headquarters of the Company, and called a convention which passed a bill of rights. In December a provisional government was set up, of which on the 29th of December Riel was made president, and which defeated two attacks made on it by the English-speaking settlers of the vicinity. So far the Métis had been within their rights, but Riel was flighty, vain and mystical, and his judicial murder on the 4th of March 1870 of Thomas Scott, an Orangeman from Ontario, roused against him the whole of English-speaking Canada. An expedition was equipped and sent out under Colonel Garnet, later Lord, Wolseley, which captured Fort Garry on the 24th of August 1870, Riel decamping. (See STRATHCONA, LORD.) He was not arrested, and on the 4th of August 1871 urged his countrymen to combine with the Canadians against a threatened attack from American Fenians, for which good service he was publicly thanked by the lieutenant-governor. In 1872 for religious reasons he changed his name to Louis David Riel. In October 1873 he became member of the Dominion parliament for Provencher, came to Ottawa and took the oath, but did not sit. On the 16th of April 1874 he was expelled the House, but in September was again elected for Provencher; on the 10th of February 1875 he was outlawed, and the seat thereby again vacated. In 1877-78 he was for over a year a patient in the Beauport asylum for the insane, but from 1879 to 1884 he lived quietly in Montana, where in 1881 he married Marguerite Bellimeure. In 1884 in response to a deputation from the Métis, who had moved west to the forks of the Saskatchewan river, he returned to Canada to win redress for their wrongs. His own rashness and the ineptitude of Canadian politicians and officials brought on a rineping, which was crushed after some hard fighting, and on the 15th of May 1885 Riel surrendered. He was imprisoned at Regina, was tried and on the 1st of August found guilty of treason, and on the 16th of November was hanged at Regina, meeting his fate with courage. His death was the signal for a fierce outburst of racialism in Quebec and Ontario, which nearly overthrew the Conservative government of the Dominion.

See J. S. Willison, *Sir Wilfrid Laurier*, vol. i.; George Bryce, *History of the Hudson's Bay Company* (1900); and the Canadian daily press for 1885.

RIEMANN, GEORG FRIEDRICH BERNHARD (1826-1866), German mathematician, was born on the 17th of September

1826, at Breselenz, near Dannenberg in Hanover. His father, Friedrich Bernhard Riemann, came from Mecklenburg, had served in the war of freedom, and had finally settled as pastor in Quickborn. Here with his five brothers and sisters Riemann spent his boyhood and received, chiefly from his father, the elements of his education. He showed at an early age well-marked mathematical powers, and his progress was so rapid in arithmetic and geometry that he was soon beyond the guidance not only of his father but of schoolmaster Schulz, who assisted in the mathematical department of his training.

In 1840 he went to Hanover, where he attended the lyceum, and two years later he entered the Johanneum at Lüneburg. The director, Schmalfluss, encouraged him in his mathematical studies by lending him books (among them Leonhard Euler's works and Adrien Marie Legendre's *Theory of Numbers*), which Riemann read, mastered and returned within a few days. In 1846 Riemann entered himself as a student of philology and theology in the university of Göttingen. This choice of a university career was dictated more by the natural desire of his father to see his son enter his own profession, and by the poverty of his family, than by his own preference. He attended lectures on the numerical solution of equations and on definite integrals by M. A. Stern, on terrestrial magnetism by Goldschmidt, and on the method of least squares by K. F. Gauss. It soon became evident that his mathematical studies, undertaken at first probably as a relaxation, were destined to be the chief business of his life. He proceeded in the beginning of 1847 to Berlin, attracted thither by that brilliant constellation of mathematical genius whose principal stars were P. G. L. Dirichlet, C. G. J. Jacobi, J. Steiner and F. G. M. Eisenstein. He appears to have attended Dirichlet's lectures on theory of numbers, theory of definite integrals, and partial differential equations, and Jacobi's on analytical mechanics and higher algebra. It was during this period that he first formed those ideas on the theory of functions of a complex variable which led to most of his great discoveries. One stirring social incident at least marked this part of his life, for, during the revolutionary insurrection in March 1848, the young mathematician, as a member of a company of student volunteers, kept guard in the royal palace from 9 o'clock on the morning of the 24th of March till 1 o'clock on the afternoon of the following day.

In 1850 he returned to Göttingen and began to prepare his doctor's dissertation, busying himself meanwhile with "Naturphilosophie" and experimental physics. This double cultivation of his scientific powers had the happiest effect on his subsequent work; for the greatest achievements of Riemann were effected by the application in pure mathematics generally of a method (theory of potential) which had up to this time been used solely in the solution of certain problems that arise in mathematical physics.

In November 1851 he obtained his doctorate, the thesis being "Grundlagen für eine allgemeine Theorie der Functionen einer veränderlichen complexen Grösse." This memoir excited the admiration of Gauss, and at once marked its author's rank as a mathematician. The fundamental method of research which Riemann employed has just been alluded to; the results will be best indicated in his own words:—

"The methods in use hitherto for treating functions of a complex variable always started from an expression for the function as its definition, whereby its value was given for every value of the argument; by our investigation it has been shown that, in consequence of the general character of a function of a complex variable, in a definition of this sort one part of the determining conditions is a consequence of the rest, and the extent of the determining conditions has been reduced to what is necessary to effect the determination. This essentially simplifies the treatment of such functions. Hitherto, in order to prove the equality of two expressions for the same function, it was necessary to transform the one into the other, i.e. to show that both expressions agreed for every value of the variable; now it is sufficient to prove their agreement to a far less extent" [merely in certain critical points and at certain boundaries].

The time between his promotion to the doctorate and his habilitation as *Privatdozent* was occupied by researches undertaken for his Habilitationsschrift, by "Naturphilosophie,"

and by experimental work. The subject he had chosen for his Habilitationsschrift was the "Representation of a Function by Means of a Trigonometrical Series," a subject which Dirichlet had made his own by a now well-known series of researches. It was fortunate, no doubt, for Riemann that he had the kind advice and encouragement of Dirichlet himself, who was then on a visit at Göttingen during the preparation of his essay; but the result was a memoir of such originality and refinement as showed that the pupil was fully the equal of the master. Of the customary three themes which he suggested for his trial lecture, that "On the Hypotheses which form the Foundation of Geometry" was chosen at the instance of Gauss, who was curious to hear what so young a man had to say on this difficult subject, on which he himself had in private speculated so profoundly (see GEOMETRY, NON-EUCLIDIAN).

In 1855 Gauss died and was succeeded by Dirichlet, who along with others made an effort to obtain Riemann's nomination as extraordinary professor. In this they were not successful; but a government stipend of 200 thalers was given him, and even this miserable pittance was of great importance, so straitened were his circumstances. But this small beginning of good fortune was embittered by the deaths of his father and his eldest sister, and by the breaking up of the home at Quickborn. Meantime he was lecturing and writing the great memoir (*Borchardt's Journal*, vol. liv., 1857) in which he applied the theory developed in his doctor's dissertation to the Abelian functions. It is amusing to find him speaking jubilantly of the unexpectedly large audience of eight which assembled to hear his first lecture (in 1854) on partial differential equations and their application to physical problems.

Riemann's health had never been strong. Even in his boyhood he had shown symptoms of consumption, the disease that was working such havoc in his family; and now under the strain of work he broke down altogether, and had to retire to the Harz with his friends Ritter and R. Dedekind, where he gave himself up to excursions and "Naturphilosophie." After his return to Göttingen (November 1857) he was made extraordinary professor, and his salary raised to 300 thalers. As usual with him, misfortune followed close behind; for he lost in quick succession his brother Wilhelm and another sister. In 1859 he lost his friend Dirichlet; but his reputation was now so well established that he was at once appointed to succeed him. Well-merited honours began to reach him; and in 1860 he visited Paris, and met with a warm reception there. He married Elise Koch in June 1862, but the following month he had an attack of pleurisy which proved the beginning of a long illness that ended only with his death. His physician recommended a sojourn in Italy, for the benefit of his health, and Weber and Sartorius von Waltershausen obtained from the government leave of absence and means to defray the cost of the journey. At first it seemed that he would recover; but on his return in June 1863 he caught cold on the Spölggen Pass, and in August of the same year had to go back to Italy. In November 1865 he returned again to Göttingen, but, although he was able to live through the winter, and even to work a few hours every day, it became clear to his friends, and clearest of all to himself, that he was dying. In order to husband his few remaining days he resolved in June 1866 to return once more to Italy. Thither he journeyed through the confusion of the first days of the Austro-Prussian War, and settled in a villa at Selasca near Intra on Lago Maggiore. Here his strength rapidly ebbed away, but his mental faculties remained brilliant to the last. On the 19th of July 1866 he was working at his last unfinished investigation on the mechanism of the ear. The day following he died. Few as were the years of work allotted to him, and few as are the printed pages covered by the record of his researches, his name is, and will remain, a household word among mathematicians. Most of his memoirs are masterpiece—full of original methods, profound ideas and far-reaching imagination.

The collected works of Riemann were published by H. Weber, assisted by R. Dedekind (8vo, Leipzig, 1876; 2nd ed., 1892).

At the end of this volume there is a touching account of his life by the latter.

(G. Ch.)

RIENZI, COLA DI (c. 1313-1354), tribune of the Roman people, was born in Rome, being the son of a tavern-keeper named Lorenzo Gabriini. His father's Christian name was shortened to Rienzo, and his own, Nicholas, to Cola; hence the Cola di Rienzi, or Rienzo, by which he is generally known. His early years were passed at Anagni. Having devoted much time to the study of the Latin writers, historians, orators and poets, and filled his mind with stories of the glories and the power of ancient Rome, he turned his thoughts to the task of restoring his native city to its pristine greatness, his zeal for this work being quickened by the desire to avenge his brother, who had been killed by a noble, a member of the ruling class. He became a notary and a person of some importance in the city, and was sent in 1343 on a public errand to Pope Clement VI. at Avignon. He discharged his duties with ability and success, and although the boldness with which he denounced the aristocratic rulers of Rome drew down upon him the enmity of powerful men, he won the favour and esteem of the pope, who gave him an official position at his court. Returning to Rome about April 1344 he worked for three years at the great object of his life, the restoration of the city to its former position of power. He gathered together a band of supporters, plans were drawn up, and at length all was ready for the rising. On the 19th of May 1347 heralds invited the people to a parliament on the Capitol, and on the 20th, the day being Whit-Sunday, the meeting took place. Dressed in full armour and attended by the papal vicar, Cola headed a procession to the Capitol; here he addressed the assembled crowd, speaking "with fascinating eloquence of the servitude and redemption of Rome." A new series of laws was published and accepted with acclaim, and unlimited authority was given to the author of the revolution. Without striking a blow the nobles left the city or went into hiding, and a few days later Rienzi took the title of tribune (*Nicholaus, severus et demens, libertatis, pacis iusticiaeque tribunus, et sacre Romane Respublice liberator*).

His authority quickly and quietly accepted by all classes, the new ruler governed the city with a stern justice which was in marked contrast to the recent reign of licence and disorder. In great state the tribune moved through the streets of Rome, being received at St Peter's with the hymn *Veni Creator spiritus*, while in a letter the poet Petrarch urged him to continue his great and noble work, and congratulated him on his past achievements, calling him the new Camillus, Brutus and Romulus. In July in a sonorous decree he proclaimed the sovereignty of the Roman people over the empire, but before this he had set to work upon his task of restoring the authority of Rome over the cities and provinces of Italy, of making the city again *caput mundi*. He wrote letters to the cities of Italy, asking them to send representatives to an assembly which would meet on the 1st of August, when the formation of a great federation under the headship of Rome would be considered. On the appointed day a number of representatives appeared, and after some elaborate and fantastic ceremonies Rienzi, as dictator, issued an edict citing the emperor Louis the Bavarian and his rival Charles, afterwards the emperor Charles IV., and also the imperial electors and all others concerned in the dispute, to appear before him in order that he might pronounce judgment in the case. On the following day the festival of the unity of Italy was celebrated, but neither this nor the previous meeting had any practical result. Rienzi's power, however, was recognized in Naples, whence both Queen Joanna and her bitter foe, King Louis of Hungary, appealed to him for protection and aid, and on the 15th of August he was crowned tribune with great pomp, wreaths of flowers being placed on his head. Gregorovius says this ceremony "was the fantastic caricature in which ended the imperium of Charles the Great. A world where political action was represented in such guise was ripe for overthrow, or could only be saved by a great mental reformation." He then seized, but soon released, Stephen Colonna and some other barons who had spoken

disparagingly of him. But his power was already beginning to wane. His extravagant pretensions only served to excite ridicule. His government was costly, and to meet its many expenses he was obliged to lay heavy taxes upon the people. He offended the pope by his arrogance and pride, and both pope and emperor by his proposal to set up a new Roman empire, the sovereignty of which would rest directly upon the will of the people. In October Clement gave power to a legate to depose him and bring him to trial, and the end was obviously in sight. Taking heart, the exiled barons gathered together some troops, and war began in the neighbourhood of Rome. Rienzi obtained aid from Louis of Hungary and others, and on the 20th of November his forces defeated the nobles in a battle just outside the gates of Rome, a battle in which the tribune himself took no part, but in which his most distinguished foe, Stephen Colonna, was killed. But this victory did not save him. He passed his time in feasts and pageants, while in a bull the pope denounced him as a criminal, a pagan and a heretic, until, terrified by a slight disturbance on the 15th of December, he abdicated and fled from Rome. He sought refuge in Naples, but soon he left that city and spent over two years in an Italian mountain monastery.

Emerging from his solitude Rienzi journeyed to Prague, which he reached in July 1350, and threw himself upon the protection of the emperor Charles IV. Denouncing the temporal power of the pope he implored the emperor to deliver Italy, and especially Rome, from their oppressors; but, heedless of his invitations, Charles kept him in prison for more than a year in the fortress of Raudnitz, and then handed him over to Clement, who had been clamouring for his surrender. At Avignon, where he appeared in August 1352, Rienzi was tried by three cardinals, and was sentenced to death, but this judgment was not carried out, and he remained in prison in spite of appeals from Petrarch for his release. Freedom, however, was at hand. In December 1352 Clement died, and his successor, Innocent VI., anxious to strike a blow at the baronial rulers of Rome, and seeing in the former tribune an excellent tool for this purpose, pardoned and released his prisoner. Giving him the title of senator, he sent him to Italy with the legate, Cardinal Albornoz, and having collected a few mercenary troops on the way, Rienzi entered Rome in August 1354. He was received with great rejoicings and quickly regained his former position of power. But this latter term of office was destined to be even shorter than his former one had been. Having vainly besieged the fortress of Palestrina, he returned to Rome, where he treacherously seized the soldier of fortune, Fra Monreale, who was put to death, and where, by other cruel and arbitrary deeds, he soon lost the favour of the people. Their passions were quickly aroused and a tumult broke out on the 8th of October. Rienzi attempted to address them, but the building in which he stood was fired, and while trying to escape in disguise he was murdered by the mob. Rienzi was the hero of one of the finest of Petrarch's odes, *Spirito gentil*, and also of some beautiful verses by Lord Byron. He was a man of vivid, but disordered, imagination, without possessing any conception of statesmanship. In 1887 a statue of the tribune was erected at the foot of the Capitoline Hill in Rome.

Rienzi's life and fate have formed the subject of a famous novel by Bulwer Lytton, of an opera by Wagner and of a tragedy by Julius Moser. His letters, edited by A. Gabrielli, are published in vol. vi. of the *Fonti per la storia d'Italia* (Rome, 1890). See also Papenrodt, *Cola di Rienzo und seine Zeit* (Hamburg, 1841); Auriac, *Étude historique sur N. Rienzi* (Amiens, 1885); E. Rodocanachi, *Cola di Rienzi* (Paris, 1888); Kühn, *Die Entwicklung der Bündnispläne Cola di Rienzis im Jahre 1347* (Berlin, 1905); A. von Reumont, *Geschichte der Stadt Rom* (1867-70); and F. Gregorovius, *Geschichte der Stadt Rom im Mittelalter*, vol. vi. (Eng. trans. by A. Hamilton, 1898).

RIESA, a town of Germany, in the kingdom of Saxony, pleasantly situated on the left bank of the Elbe, 30 m. N.W. of Dresden, on the main line of railway to Leipzig, and at the junction of lines to Chemnitz, Elsterwerda and Nossen. Pop. (1905) 14,073. The river is here crossed by a fine bridge, a

sandstone and iron structure, carrying both railway and road, and replacing the one carried away by floods in 1875. The town contains two Evangelical churches, a castle, formerly a convent and now used as a town hall, and several schools. There is a harbour with quays and a dockyard, also rolling-mills and saw-mills, ironworks and sandstone quarries. Other industries are the manufacture of furniture, beer, soap, carriages and bricks. The most important shipping station on the Elbe in Saxony, Riesa is the lading-place for goods to and from Bavaria, and a mart for herrings, petroleum, wood, coal and grain. A constant passenger steamboat communication is maintained with Meissen and Dresden; and, owing to the artillery practice ranges at Zeithain, on the right bank of the Elbe, Riesa has become of recent years one of the chief depots of the Saxon army. Riesa received municipal rights in 1632, and after a period of decay was again raised to the rank of a town in 1859.

RIESENER, JEAN HENRI (1734-1806), French cabinet-maker of the Louis XVI. period, was born at Gladbach near Cologne. At an early age he went to Paris, where he entered the workshop in the Arsenal of Jean François Oeben (*q.v.*). When that great master died, Rieseener became foreman of the works; two years later he married Mme. Oeben, and in 1768 was admitted "maitre-ouvrier-ébéniste." His wife died in 1776, and in 1782 he espoused, as his second wife, Anne Grezel, daughter of a *bourgeois* of Paris. The union was unhappy, and when, under the first Republic, divorce was legalized, the marriage was dissolved. When Rieseener contracted his first marriage he possessed little or nothing; his second contract of marriage recited that in cash and in the money due to him by Louis XVI. he was worth more than £20,000, without counting the finished work in hand, bronze models, jewels and personal effects and invested funds. Thus in fifteen years he had accumulated a fortune amounting in all to about £40,000. By that time there had been conferred upon him the title, formerly enjoyed by Oeben, of "Ébéniste du Roi." He died on the 6th of January 1806, in the Enclos des Jacobins, leaving an only son, Henri François (1767-1828), a distinguished portrait-painter of the First Empire. Rieseener was unquestionably the greatest of the Louis Seize cabinet-makers. His name is stamped upon the Bureau du Roi in the Louvre, and although the original conception of that master-work was due to Oeben, it cannot be doubted that its consummate finish and perfect achievement must in great measure be attributed to the man who completed it. Occasionally there may, perhaps, be some lack of spontaneity in his forms, but his work is generally at once bold and graceful. His marquetry presents an extraordinary finish; his chiselled bronzes are of the first excellence. He was especially distinguished for his cabinets, in which he employed many European as well as exotic woods. Wreaths and bunches of flowers form the centres of the panels; on the sides are often diaper patterns in quiet colours. Yet despite his distinction as a maker of cabinets his high-water mark was reached in the Bureau du Roi, finished in 1769 and consequently belonging rather to the Louis Quinze than the Louis Seize period, and a not altogether dissimilar cylinder bureau believed to have been made for Stanislas Leszczyński, king of Poland, now in the Wallace Collection. Stanislas died in 1766, but the desk was not completed until February 20, 1769, as appears by the inscription accompanying the maker's signature. Upon its completion it passed into the possession of the French crown and was included in a sale of the royal furniture which took place in Holland. It was purchased by Sir William Hamilton, then British Minister at the Hague, and appears to have passed out of his hands when he left Naples, where it was purchased by Sir Richard Wallace. At Buckingham Palace there is a third bureau on the same lines. These pieces are triumphs of marquetry. They are inlaid with trophies of musical instruments, doves, bouquets and garlands of flowers; the bronze vases and "galleries" are exquisite—they may possibly be the work of Gouthière, but are more probably from the hands of Duplessis. For several years this great artist appears to have used the models of his master Oeben, but there was a gradual transition to a style more individual, more

delicately conceived, with finer but hardly less vigorous lines. By the time he had been working alone for ten years he had completely embraced the Louis Seize manner—he had, perhaps, some responsibility for it. One of the most distinguished of his achievements for the court was the famous flat writing-table now at the Petit Trianon, for which he received only £200. The extent of these royal orders may be gauged from the fact that between 1775 and 1785 Rieseener received 500,000 livres from the Garde Meubles, notwithstanding that during the whole of this period Gondouin the architect was the official designer of furniture for the royal palaces. Like so many other artists he was condemned in the end to sacrifice to the false taste of his day, and a certain number of his creations, otherwise delightful, were vitiated by being mounted with panels of Sèvres, Wedgwood and other china. The beautiful little secretaire in the Jones collection in the Victoria and Albert Museum suffers seriously by this lapse.

RIESENGEBIRGE (Bohemian *Krkonoše*), or Giant Mountains, a lofty and rugged group on the boundary of Silesia and Bohemia, between the upper courses of the Elbe and the Oder. They form the highest portion of the Sudetic system which separates south-east Prussia from the Austrian empire, and finds its natural continuation towards the N.W. in the Erzgebirge, the Thuringian Forest and the Harz Mountains. Adjoining the Isergebirge and the Lausitzgebirge on the W., and the Eulengebirge and the Adlergebirge on the E. and S.E., the Riesengebirge proper runs S.E. and N.W. between the sources of the Zacken and the Bober, for a distance of 23 m., with a breadth of 14 m. They cover an area of about 425 sq. m., three-fourths of which is in Austrian, and the remainder in Prussian territory. The boundary line follows the crest of the principal chain or ridge (Riesenkamm), which stretches along the northern side of the group, with an average height of over 4000 ft. The principal peaks are the Reifträger (4430 ft.), the Hohe Ra (4968 ft.), the Great Sturmhaube (4862 ft.), the Little Sturmhaube (4626 ft.), and, near the east extremity, the Schneekoppe or Riesenkoppe (5266 ft.), the loftiest mountain in northern or central Germany. Roughly parallel to this northern ridge, and separated from it by a long narrow valley known as the Siebengründe, there extends on the S. a second and lower chain, of broad massive "saddles," with comparatively few peaks. The chief heights here are Kesselkoppe (4708 ft.), the Krkonose (4849 ft.), the Ziegenritcken and the Brunnenberg (5072 ft.). From both ridges spurs of greater or less length are sent off at various angles, whence a magnificent view is obtained from Breslau to Prague; the lowlands of Silesia, watered by the Oder, and those of Bohemia, intersected by the Elbe and the Moldau, appearing to lie mapped in relief. The summit is crowned by a chapel dedicated to St Lawrence, which once also served as a traveller's shelter. Since 1850 the chapel has been restored to its religious use, and a hotel for the accommodation of tourists is built close by. A remarkable group of isolated columnar rocks are those known as the *Adersbacher Felsen* in a valley on the Bohemian side of the Riesengebirge, 9 m. W.N.W. of Braunau.

On its northern side this mountain group rises ruggedly and precipitously from the Hirschberg valley; but on its southern side its slope towards Bohemia is very much more gradual. The scenery is in general bold and wild. The Bohemian ridge is cleft about the middle by a deep gorge through which pour the headwaters of the river Elbe, which finds its source in the Siebengründe. The Iser, Bober, Aupa, Zacken, Queiss, and a great number of smaller streams also arise among these mountains or on their skirts; and small lakes and tarns are not unfrquent in the valleys. The Great and Little Schneegruben—two deep rocky gorge-like valleys in which snow remains all the year round—lie to the north of the Hohe Ra.

Nearly the whole of the Riesenkamm and the western portion of the southern chain are granite; the eastern extremity of the main ridge and several mountains to the south-east are formed of a species of gneiss; and the greater part of the Bohemian chain, especially its summits, consists of mica-slate. Blocks of these minerals lie scattered on the sides and ridges of the mountains and

in the beds of the streams; and extensive turf moors occupy many of the mountain slopes and valleys. The lower parts of the Riesengebirge are clad with forests of oak, beech, pine and fir; above 1600 ft. only the last two kinds of trees are found, and beyond about 3950 ft. only the dwarf pine (*Pinus Pumilio*). Various alpine plants are found on the Riesengebirge, some of them having been artificially introduced on the Schneekoppe. Wheat is grown at an elevation of 1800 ft. above the sea-level, and oats as high as 2700 ft. The inhabitants of this mountain region, who are tolerably numerous, especially on the Bohemian side, live for the most part, not in villages, but in scattered huts called "Bauden." They support themselves by the rearing of cattle, tillage, glass-making and linen-weaving. Mining is carried on only to a small extent for arsenic, although there are traces of former more extensive workings for other metals.

The Riesengebirge has of late years been made easily accessible by railway, several branches from the main lines, both on the Silesian and Bohemian side, penetrating the valleys, and thus many spots in the Riesengebirge are a good deal frequented in the summer. The Schneekoppe and other summits are annually visited by a considerable number of travellers, notably the spas of Warmbrunn (near Hirschberg) and Flinsberg on the Gneis, and Görbersdorf, known as a climate health resort for consumptives. The Riesengebirge is the legendary home of Number Nipke (Rübezahl), a half-mischievous, half-friendly goblin of German folklore, and various localities in the group are more or less directly associated with his name.

See Beemann's *Oratio de monte Giganteo* (Frankfurt a. O. 1679); Daniel, *Deutschland*, vol. i. pp. 277-78; and Gebauer, *Länder- und Völkerkunde*, vol. i.

RIETI (anc. *Reate*), a city and episcopal see of Italy, in the province of Perugia, 25½ m. by rail and 15 m. direct S.E. of Terni, which is 70 m. by rail from Rome. Pop. (1901) 14,145 (town), 17,716 (commune). It occupies a fine position 1318 ft. above sea-level on the right bank of the Velino (a torrent tributary to the Tiber), which at this point issues from the limestone plateau; the old town occupies the declivity and the new town spreads out on the level. While with its quaint red-roofed houses, its old town walls (restored about 1250), its castle, its cathedral (13th and 15th centuries), its episcopal palace (1283), and its various churches and convents Rieti has no small amount of medieval picturesqueness; it also displays a good deal of modern activity in vine and olive growing and cattle-breeding. The fertility of the neighbourhood is celebrated both by Virgil and by Cicero. A Roman bridge over the Turano, and the Palazzo Vincentini by Vignola deserve to be mentioned.

Reate was reached from Rome by the Via Salaria (q.v.), which may originally have ended there, and a branch road ran from it to Interamna. While hardly mentioned in connexion with the Punic or Civil Wars, Reate is described by Strabo as exhausted by these long contests. Its inhabitants received the Roman franchise at the same time with the rest of the Sabines (290 B.C.), but it appears as a *praefectura* and not as a *municipium* down to the beginning of the empire. It was never made a *colonia*, though veterans of the Praetorian guard and of the eighth (Augusta) and ninth legions were settled there by Vespasian, who belonged to a Reatine family and was born in the neighbourhood. For the contests of the Reatines with the people of Interamna see **TERNI**. In 1148 the town was besieged and captured by Roger I. of Sicily. In the struggle between church and empire it always held with the former; and it defied the forces of Frederick II. and Otto IV. Pope Nicholas IV. long resided at Rieti, and it was there he crowned Charles II. of Anjou king of the Two Sicilies. In the 14th century Robert, and afterwards Joanna, of Naples managed to keep possession of Rieti for many years, but it returned to the States of the Church under Gregory IX. About the year 1500, the liberties of the town, long defended against the encroachments of the popes, were entirely abolished. An earthquake in 1785 was in 1790 followed by the much more disastrous pillage of Rieti by the papal troops for a space of fourteen days.

RIETSCHEL, ERNST FRIEDRICH AUGUST (1804-1861), German sculptor, was born at Pulsnitz in Saxony. At an early age he became an art student at Dresden, and subsequently a pupil of Rauch in Berlin. He there gained an art studentship, and studied in Rome in 1827-28. After returning to Saxony he soon brought himself into notice by a colossal statue of Frederick Augustus, king of Saxony; was elected a member of the academy of Dresden, and thenceforth became one of the chief sculptors of his country. In 1832 he was elected to the Dresden professorship of sculpture, and had many foreign orders of merit conferred on him by the governments of different countries. He died at Dresden in 1861.

Rietschel's style was very varied; he produced works imbued with much religious feeling, and to some extent he occupied the same place as a sculptor that Overbeck did in painting. Other important works by him were purely classical in style. He was specially famed for his portrait figures of eminent men, treated with much idealism and dramatic vigour; among the latter class his chief works were colossal statues of Goethe and Schiller for the town of Weimar, of Weber for Dresden and of Lessing for Brunswick. He also designed the memorial statue of Luther for Worms, but died before he could carry it out. The principal among Rietschel's religious pieces of sculpture are the well-known Christ-Angel, and a life-sized *Pietà*, executed for the king of Prussia. He also worked a great deal in rilievo, and produced many graceful pieces, especially a fine series of bas-reliefs representing Night and Morning, Noon and Twilight, designed with much poetical feeling and imagination.

For a good biography of Rietschel and account of his works see Appermann, *Ernst Rietschel* (Leipzig, 1863). (J. H. M.)

RIEU, CHARLES PIERRE HENRI (1820-1902), Swiss Orientalist, was born at Geneva in 1820. He studied at Bonn University, where he received his doctor's degree in 1843. He entered the British Museum in 1847, and after twenty years of service, a new post, that of keeper of Oriental manuscripts, was created for him. He completed in 1871 the second part, dealing with Arabian MSS., of the *Catalogue codicum manuscriptorum orientaliu*, which had been begun by William Cureton, and he issued a supplementary volume in 1894. He also drew up a *Catalogue of the Turkish Manuscripts* (1888) and a *Catalogue of the Persian Manuscripts* (4 vols., 1879-95), the latter being a storehouse of information on the books and their authors. In 1895 he was made professor of Arabic in the university of Cambridge in succession to Robertson Smith. He died in London on the 19th of March 1902.

RIEVAUX, a village in the North Riding of Yorkshire, England, 3 m. W. of N. of the small town of Helmsley, which is served by a branch of the North-Eastern railway. Here, exquisitely situated in a deep wooded valley, are the ruins of Rievaulx Abbey, a foundation by Walter l'Espece in 1131 for Cistercians. The principal remains are those of the cruciform church, mainly Early English in date, and of the finest workmanship. There are considerable fragments of the refectory, and all the important domestic buildings may be traced. A beautiful prospect over the ruins and the valley is seen from the terrace on the eastern flanking hill.

RIFFIANS, the name given to the Berbers of the Rif district of Morocco, the mountain region bordering the north coast from Ceuta eastward nearly to the borders of Algeria and forming part of the Atlas range. The name, it has been suggested, is identical with Libyan or Libi. A peculiarity of the Rif dialect is the change of the Arabic "l" to "r," and this would seem to support this derivation, "b" and "f" being interchangeable through "v." The Riffians are only nominally subject to the sultan of Morocco, against whose authority they are in constant revolt. They are typical Berbers in physique, tall, well made and muscular, with European features and fair skins bronzed by the sun. In morality they are singularly superior to their neighbours. In order to prevent youthful unchastity, marriages are contracted between children of eight years old, the girl being brought home to live with the lad at his parents' home till a child is born, when a separate dwelling is provided for the youthful couple. The women are noted for their beauty. The Riffians understand and speak Arabic very little. They were among the fiercest and most cruel of the pirates of the north coast of Africa. Even now they are entirely untrustworthy in this respect. See further **BEBBERS**, **MOROCCO**, **MOORS**, **KABYLES**, **MZABITES**.

RIFLE, a firearm which may be shortly defined as a musket in which, by grooves (cf. Ger. *rieffen*, to groove) in the bore or otherwise, the projectile is forced to rotate before leaving the barrel. This rotatory motion, maintained during flight, equalizes any irregularities in the form or weight of the bullet, and so lessens the tendency to depart from a straight line, and also in a measure overcomes atmospheric resistance. Rifling was invented about 1520, by Gaspard Koller or Kollner, a gunmaker of Vienna, according to some authorities; by August Kotter of Nuremberg, according to others. It has been said

that at first the grooves were made straight, with the object of admitting a tight-fitting bullet and relieving the effects of fouling, and that the virtue of spiral grooving was subsequently discovered by accident. But this theory is unsupported. The earliest known rifle barrels have spiral grooving. The amount of turn varied in old rifles from a half or three-quarters turn to one turn in two to three feet. The form and depth of the grooving and the number of grooves also greatly varied.

Historical Development of Military Rifles.—For the chief infantry firearms that preceded the modern military rifle, see GUN, ARMS AND ARMOUR (firearms), ARQUEBUS, &c. Rifles were at first used for amusement. There are, however, instances of their occasional employment in war in the 17th and 18th centuries. In 1631 the landgrave of Hesse had a troop of riflemen. Ten years later Maximilian of Bavaria had several troops armed with rifled arquebuses. Louis XIII. armed his bodyguard with rifles. Napoleon withdrew the rifle from those of his troops to whom it had been issued during the wars of the Republic, nor did the French make any considerable use of it again until 1830, when the Chasseurs d'Orléans were armed with it for the invasion of Algeria. The British learnt the value of rifles during the American War of Independence, when the government subsidized continental *Jägers* armed with rifles to oppose the American riflemen. After the war these corps disappeared, and though they are now represented by the 60th (King's Royal) Rifles, the senior rifle corps in the British Army is the Rifle Brigade, raised in 1800 as the 95th Regiment and armed with a flint-lock weapon known as "Baker's Rifle," which weighed 9½ lb. The barrel was 2½ ft. long, its calibre 20-bore, with seven grooves making a quarter-turn in its length. A small wooden mallet was at first supplied with this rifle to make the ball enter the barrel, and it was loaded with great difficulty. In 1826 Delvigne, a French infantry officer, invented a breech with abrupt shoulders on which the spherical bullet was rammed down until it expanded and filled the grooves. The objection was that the deformed bullet had an erratic flight. Delvigne's system was subsequently improved upon by Thouvenin, who introduced into the breech an iron stem, upon which the bullet, now of conical form, rested, and was expanded by a sharp blow with the iron ramrod when loading. In William IV.'s reign the Brunswick percussion rifle¹ was introduced into the British rifle regiments. Its weight with bayonet was 11 lb 5½ oz.; length of barrel, 2 ft. 6 in., with two grooves making one turn in the length of the barrel; weight of spherical belted bullet, 557 grs.; diameter, .704 in.; charge of powder, 2½ drs. This rifle was not easily loaded, soon fouled, and shot wild beyond 400 yds.

In 1835 W. Greener produced a new expansive bullet, an oval ball, a diameter and a half in length, with a flat end, perforated, in which a cast metallic taper plug was inserted. The explosion of the charge drove the plug home, expanded the bullet, filled the grooves and prevented windage. A trial of the Greener bullet in August 1835 proved successful. The range and accuracy of the rifle were retained, while the loading was made as easy as with a smooth-bore musket. The invention was, however, rejected by the military authorities on the ground that the bullet was a compound one. In 1852 the Government awarded Minié, a Frenchman, £20,000 for a bullet of the same principle adopted into the British service. In 1857 Greener received a belated reward of £1000 for "the first public suggestion of the principle of expansion." The Minié bullet contained an iron cup in a cavity at the base of the bullet. In 1851 a rifled musket of the Minié pattern was introduced into the British army, and, though not generally issued, was used in the Kaffir War of 1851, and in the Crimea. Its weight with bayonet was 10 lb 8½ oz., length of barrel 3 ft. 3 in., with four grooves making one turn in 72 in.; diameter of bore .702 inch;

charge of powder 2½ drs., and sighted from 100 to 1000 yds. The form of its bullet was at first conoidal, afterwards changed to cylindro-conoidal, with a hemispherical iron cup. In 1855 the Enfield rifle, having in a series of trials competed favourably with the Minié and Lancaster rifles, was introduced into the British army; it was used during the latter part of the Crimean war, having there replaced the Minié rifle and the percussion musket, and remained the general weapon of the entire infantry until the introduction of the breech-loader in the year 1867. This rifle weighed, with bayonet, 9 lb 3 oz., barrel 39 in.; diameter of bore .577 in.; three-grooved, with one turn in 78 in. It fired a bullet of cylindro-conoidal form with hollow base, weighing 530 grains, made up into cartridges and lubricated as for the Minié rifle, adapted to this rifle by Pritchett, who was awarded £1000 by the Government. This bullet was wrapped in greased paper round the cylindrical part half-way up its length. Short rifles of the same pattern, with five-grooved barrels 2 ft. 9 in. long and a sword bayonet, were supplied to the 60th Rifles and to the Rifle Brigade. Two small carbines of the same principle were at this time introduced for the cavalry and artillery, also a rifled pistol.

In 1854, on the suggestion of General Lord Hardinge, Sir Joseph Whitworth, the first mechanic of the day, began to consider the subject of rifling, and after a long series of experiments the Whitworth rifle was produced with hexagonal bore, .45-in. calibre, and with one turn in 20 in. It was tried at Hythe in 1857, and completely defeated the Enfield rifle up to 1800 yds. upon a fixed rest. This trial and Whitworth's experiments proved the advantages of a sharp twist, a smaller bore, and elongated projectile; but Whitworth's rifle was never adopted into the Government service, probably because the hexagonal rifling wore badly, and owing to the difficulty of equal mechanical perfection in all similar rifles and ammunition. Several improvements were subsequently made in the sighting, grooving and some other details of the Enfield rifle. In 1855 a boxwood plug to the bullet was used.

Between 1857 and 1861 four breech-loading carbines were experimentally introduced in the cavalry—viz. Sharp's, Terry's, Green's, and Westley-Richards'. Sharp's and other breech-loading carbines and also Spencer repeating carbines were used by the Federal cavalry in the American Civil War. The general adoption of the breech-loading principle may be said to date from 1867. The Prussians were the first to see its great advantages, and about 1841 had adopted the celebrated needle-gun (*q.v.*), a bolt-action weapon. In 1864 and 1866 committees were appointed by the British War Office to report on breech-loading arms, and after protracted experiments, Jacob Snider's method of conversion of the muzzle-loading Enfield to a breech-loader (fig. 1) was adopted, with the metallic cartridge-case improved in 1867 by Colonel Boxer, R.A. All available Enfield rifles were thus converted, and new arms made with steel barrels instead of iron. Great Britain was the first to adopt for her army a breech-loading

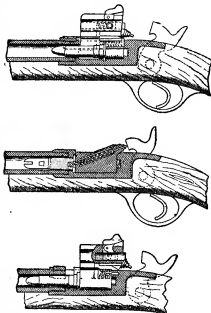

FIG. 1.—Snider Rifle. (Text Book of Small Arms, by permission of the Controller, H.M. Stationery Office.)

¹The percussion principle, invented by the Rev. Alexander John Forsyth (1768-1843) in 1805, was not accepted for military arms until the introduction of this rifle. A small and belated money grant was made to Forsyth in 1843. See Major-General A. J. F. Reid's memoir of Forsyth (1910).

rifle with metallic cartridge-case, which secured the perfect obturation of the breech. The Snider breech was a hinged block, a type much in favour at the time. The French similarly converted their muzzle-loaders, the converted weapon being known as the Tabatière or snuff-box. Other breech actions on the same principle were the Austrian Wernld and the Bavarian Podewils and Werder rifles. But these were only transitional arms. In 1866 France adopted the bolt-action Chassepôt (*q.n.*); in 1867 Sweden the Hagström, and Russia the Carte; in 1868 Italy the Carcano. All these were breech-loaders firing paper cartridges containing their own means of ignition. After further experiments by a fresh committee the Martini-Henry rifle (fig. 2) was definitely adopted by the British

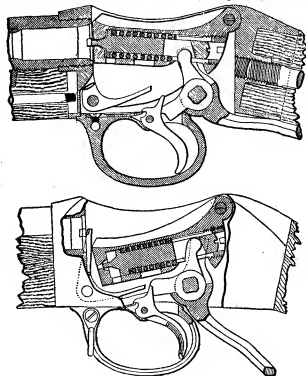

FIG. 2.—Martini-Henry.

Government in 1871, with the short chamber Boxer-Henry ammunition. This rifle was a combination of Martini's block-action breech mechanism with Henry's barrel of .45-in. calibre, firing a *papered* bullet of 480 grains from Boxer cases with a wad of wax lubrication at base of bullet, as proposed by Henry. The Henry rifling had seven grooves with one turn in 22 in.; the lands and the centres of the grooves were contained in the same circle. About the same time or a little later the various powers re-armed their infantry with breech-loaders of different patterns and names, all of which were of about 11 mm. (.433 in.) calibre, and nearly all of the bolt-action type.

The next stage in the history of military firearms was the introduction of the repeating or magazine system. The Winchester rifle, an American invention which appeared in 1865, was one of the earliest magazine rifles. This weapon was used by Turkey to some extent in the Russo-Turkish War of 1877-78, but Germany was the first great power to provide its army with a magazine rifle. In 1884 it converted the 1871 pattern Mauser of .443-in. bore into a magazine rifle, holding eight cartridges in a tube magazine in the fore end. In 1885 France followed with the Lebel, which had an enormous advantage in its smokeless powder. In 1886 the question of the best calibre for small arms was reopened in England. In this year, 1886, Austria had adopted a Mannlicher rifle, .433 bore, with a straight-pull bolt. This rifle was the first adopted by any European nation embodying Lee's box magazine, an invention patented in 1879 and 1882, and consisting of a box, in rear of and below the entrance to the chamber, containing the cartridges. Another

important improvement, the steel clip loader containing five cartridges, was also introduced with this rifle. In 1888 these rifles were converted to .315 bore, firing black powder cartridges; and in 1890, on the introduction of smokeless powder, the sights were re-graduated. In 1887 the British Small Arms Committee, after experiments with the small-calibre rifle invented in 1883 by the Swiss Major Rubin, director of the Federal laboratory at Thun, recommended the small calibre for adoption into the British service. The essential features of Rubin's system were the employment of a compound bullet with a leaden core in a copper envelope, and the use of a compressed charge of black powder. In 1888 a pattern of .303-in. calibre rifle, rifled on the Metford system and with the improved Lee bolt and magazine, was approved for trial by British troops. The Metford rifling is as follows:—diameter of bore, .303 in.; depth of rifling, .004 in.; width of lands, .023 in.; twist of rifling, one turn in 10 in. (left-hand); radial grooves, seven in number. About 1862, and later, W. E. Metford had carried out an exhaustive series of experiments on bullets and rifling. He invented the important system of light rifling, with increasing spiral with a hardened bullet. The Metford match rifle was prominent in all N.R.A. competitions from 1871 to 1894. In 1887 he laid down for the Small Arms Committee the proper proportions for the grooving, spiral and cartridge chamber of the .303 military rifle. This weapon proved satisfactory and was adopted by the War Office as the Lee-Metford rifle, Mark I., in December 1888. It had a magazine of eight cartridges. In 1891 the Mark II. pattern was approved, with a ten-cartridge magazine, a simplified bolt, and many minor improvements. A magazine carbine with barrel 21 in. long and a six-cartridge magazine, otherwise identical with the Lee-Metford Mark II., was also approved. The Lee-Metford Mark II. rifle was subsequently further improved in its rifling to resist the wear of smokeless powder, and also in its bolt action, and became known as the Lee-Enfield rifle, and under that name was officially adopted as the rifle of the British army. The number of grooves were reduced from seven to five. Neither the Lee-Metford nor the Lee-Enfield has increasing spiral grooves, which are found inconvenient for military arms from a manufacturing point of view.¹ The L.M. and L.E. carbines are similar to the shorter models of the rifles, but are covered for the whole length of the barrel by a wooden handguard and take only six cartridges; the fore-sights are protected by wings on the nose-cap, and the long-range sights are omitted. These, as also the Martini-Metford and Martini-Enfield carbines (falling-block action small-bores), have practically been replaced by the "short" rifle described below.

The efficiency of the modern small-bore magazine rifle is largely due to the production of smokeless nitro-compound powder. France was the first country to adopt, about 1885, a smokeless powder with the Lebel magazine rifle. It was known as "Vieille" powder, or "Poudre B" (after General Boulanger). Since then smokeless explosives have been universally adopted in all small-bore magazine military rifles. The smokeless explosive known as "Cordite" or "Cordite M.D." (see *CORDITE*) is used for the cartridges of the Lee-Metford and Lee-Enfield rifles and rifle-calibre machine guns. (H. S.-K.)

Military Rifles of To-day.—About 1900, the various armies were equipped with weapons of nearly equal efficiency. The weights varied between 8½ and 9½ lb., the lengths between 49 and 52 in.; the calibres were .315, .311, .303, with one or two .256. None of the rifles were sighted to less than 2000 yds., and nearly all had a "fixed" or "battle" sight. All were bolt-action rifles, and had a muzzle velocity of about 2000 f.s. (the .256 Mannlichers, about 2300 f.s.). Except France, with the tube-magazine Lebel, Denmark and the U.S.A. with the horizontal-box Krag-Jørgensen, and Great Britain, all nations used multiple-loading by clip or charger. With Lebel and Krag-Jørgensen weapons, multiple-loading is a practical impossibility, but in Great Britain the charger was deliberately rejected. It was desired to use the rifle normally as a

¹ Of all modern military rifles, the Italian 1891 weapon alone has an increasing twist.

single-loader, and to reserve the magazine (which held ten cartridges, or twice as many as the multiple-loading Mausers, Mannlichers, &c.) for emergencies. But from about 1903 this equivalence of infantry weapons began to be disturbed by two new influences: the tendency towards a "short" rifle, and the introduction of the pointed bullet.

In the first, Switzerland took the lead with the short Schmidt-Rubin in 1900. But amongst the greater powers, England and the United States alone have followed her example. At the close of the South African War Great Britain issued 1000 short Lee-Enfield rifles experimentally, and in 1903 the "short rifle" was actually approved and issued generally. Since then it has been improved in details. The barrel was shortened by 5 in., multiple-loading by charger was introduced, and by the *Musketry Regulations* of 1909 magazine fire was laid down as the normal, single-loading being forbidden. The change met with very considerable opposition, especially from target-shooting experts, who maintained that a long rifle, so perfected in details as to be equal to the short in every point except in length, must be more accurate. The view of the military authorities, which was maintained in spite of criticism, was that for service purposes, and especially for prolonged snap-shooting, the handier weapon was preferable. One important factor in the decision was the desire to give the cavalry a weapon with which, when dismounted, it could fight the infantry rifle on equal terms. A more serious objection than that of want of superfine accuracy in bull's-eye shooting was the loss of 5 in. of reach in bayonet fighting. This objection was met in 1907 by the introduction of a new pattern bayonet with a blade 5 in. longer. In 1908 the long Lee-Enfield and Lee-Metford rifles in store were converted for charger-loading (fig. 3), fitted with safety catches and



FIG. 3.—Charger-loading L.E. (*Text Book of Small Arms*, by permission.)

new sights, and issued to the infantry of the Territorial Force in 1909 and 1910. For target purposes many rifle shots prefer this converted weapon to the short rifle (fig. 4).



FIG. 4.—L.E. Short Rifle. (*Text Book of Small Arms*, by permission.)

The United States in 1904 replaced the Krag-Jørgensen (hand-loading horizontal magazine) by the short Springfield. A sort of spring bayonet was at first fitted to this rifle, but it was soon replaced by an ordinary sword bayonet.

The pointed bullet ("Spitz-geschoss" or "S") was introduced by Germany in 1905, and her example was quickly followed by France (balle D) and other powers. Its advantage is a considerable flattening of the trajectory, chiefly on account of the lessened resistance of the air. This latter allows of a reduction in the sectional density and consequently in the weight of the bullet. Thus velocities up to 2900 foot-seconds are realized, which enables the "dangerous space" to be very greatly augmented (see fig. 20). The "fixed sight" range with the "S" bullet is 700 yds., as against the Lee-Enfield's 500. It was announced in the House of Commons in 1910 that a modified bullet was being experimented with, and that some increase in the fixed-sight range was expected to be obtained, but the relatively weak breech action of the Lee-Enfield—which is due chiefly to the rearward position of the locking lugs—does not allow designers much freedom in the matter of increasing velocities, as the chamber pressure has to be kept low. It

will be seen from the table that other rifles are constructed to stand a much higher pressure.

But both these improvements are destined to be eclipsed in importance by the adoption of the automatic rifle. The application of the automatic principle to the modern high-velocity small-arm of precision has been occupying the attention of the small-arms experts of all armies and of numerous private inventors for some years past. These numerous attempts have, in the case of the rifle, been largely doomed to failure because of the necessary limitations of space and weight; although the automatic principle has been successfully applied both to machine guns (*g.v.*) and to pistols (*g.v.*). In these weapons the work of extracting the empty cartridge-case, re-loading and re-cocking, is accomplished either by the motive power of the recoil or of the gas generated by the explosion of the powder, thus enabling a rapid and continuous fire to be maintained to the full capacity of the weapon's magazine. In the case of machine guns the firing also is automatic, but self-firing rifles are not very desirable as infantry weapons and in addition are so heavy as to approximate to machine guns.

Of the recoil-operated class of automatic rifles there are two subdivisions, "short-recoil" and "long-recoil." In the former, which is most favoured by inventors, the barrel, body and bolt recoil together for a short distance, about $\frac{1}{4}$ in., in which space the bolt is unlocked, and the bolt then recoils freely in the body. The bolt is run forward in reloading by a spring. In the long-recoil type the barrel, body and bolt recoil the whole distance, and the barrel and body are run up by one spring, the bolt by another. Several such rifles have been shown at the N.R.A. meetings at Bisley; the Rexer, Mauser and Woodgate rifles being on the long-recoil; the Hallé on the short-recoil principle. Gas-operated rifles, like the Hotchkiss and Colt machine guns, have fixed barrels and are worked by a portion of the powder-gases which is allowed to escape from the barrel through a small hole near the muzzle, thence entering a cylinder and working a piston in connexion with the breech mechanism. No automatic rifle has as yet (August 1910) been issued as a service weapon by any power, the problem of ensuring certainty in action under service conditions—*i.e.* with grit and dirt in the working parts—being the principal difficulty.

Great Britain.—There are two principal types of Lee-Metford and Lee-Enfield rifles in the service, the "short" and the "charger-loading." The former is carried by all units (cavalry included) of the regular army, by the yeomanry cavalry of the Territorial Force, and by units of the Officers' Training Corps. The latter is used by the infantry of the Territorial Force. There exist, further, the older, non-charger-loading Lee-Metford and Lee-Enfield rifles, a few carbines of the same type, and some Martini-Metford and Martini-Enfield carbines which have the .303 barrel and cartridge with the falling-block Martini action. .45 Martini-Henry rifles and carbines, and even Sniders, are still used by local police forces in some of the smaller colonies.

The "long" charger-loading Lee-Enfield is converted from earlier patterns by the addition of a charger guide, the stripping of the bolt-cover, and improvements in the sighting. The action of the breech mechanism¹ is as follows (the breech mechanism of the "short" rifle being practically the same): The breech is closed by a bolt (I) which slides in a bolt-way cut in the body; the bolt-head (10) abuts against the base of the cartridge when the rifle is loaded, and when the knob is turned down the whole is locked. On the right side of the bolt is a firing rib, and on the left side a lug; these support the bolt on solid by contact with the "resisting shoulder" on the right, and the rear face of the "lug seating" on the left of the body. Underneath the bolt there are two recesses and two studs. The bolt-head is screwed to the bolt and is fitted with an extractor claw. The bolt-head, instead of being rigidly attached to the bolt, is so far independent that it remains stationary while the bolt is revolved. Inside the bolt is the arrangement of striker (V) and spring (W), and at its rear end, forming the working connexion between trigger and striker, is the "cocking-piece" (X) which is fitted with a safety-catch (not in the old pattern rifle illustrated). This cocking-piece (which cannot turn) has a long tongue projecting to the front, lying along the under side of the bolt, and the front end of this tongue (Y), called the "full-bent,"

¹ The annexed figures show the old pattern weapon. In both the existing patterns a safety catch is fitted, the magazine spring is of a different shape and there is no bolt-cover. But the essential parts of the action remain the same.

engages the nose of the trigger sear when the weapon is loaded (a groove in the tongue, called the "half-bent" (Z), serves as a half-cock arrangement, and could be used as a safety-catch if the proper safety-catch were damaged). The trigger sear (K) is a bell-crank lever, the upper long arm of which is put in and out of contact with the "full-bent," and the lower or short arm is connected to the trigger. The magazine holds ten cartridges, which rest on a platform, underneath which is the magazine spring that pushes the cartridges and cartridges up. A "cut-off" is fitted in the "long" and in some marks of the "short" rifle. This is a sort of lid to the magazine, enabling the magazine to be kept full while the rifle is being used as a single loader. But the present musketry regulations forbid single-loading, and the cut-off is now only closed for special purposes, such as unloading a single cartridge (miss-fire, &c.) without unloading the magazine. The magazine is loaded by

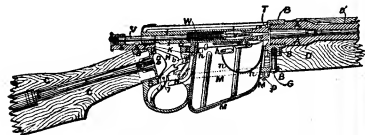
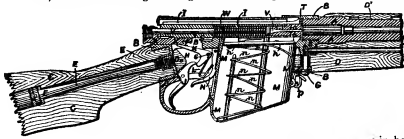

FIGS. 5 and 6.—Lee-Metford.

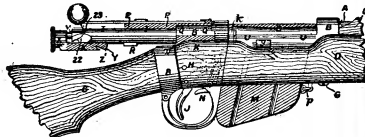
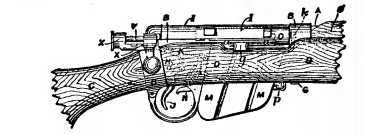

FIGS. 7 and 8.—Lee-Metford.

inserting a charger in the "charger guides" (these, attached to the body, form a sort of bridge over the bolt) and forcing down the strip of cartridges into the magazine (charger guides not shown in diagrams). The action of the mechanism is as follows: Suppose that the rifle has been fired and the magazine is full. On beginning to turn up the knob of the bolt, the latter is revolved, but the cocking-piece (the tongue being held by a groove in the body) and the bolt-head remain stationary. Soon, however, a cam on the bolt comes in contact with a stud on the cocking-piece and the latter is brought slightly to the rear, pulling in the point of the striker and partly compressing the spring. At the same time the lug on the left of the bolt, in contact with the front face of a recess in the body (both being cut slantwise to a screw pitch), forces the bolt and with it the claw of the extractor, which grips the base of the cartridge-case, to slide backwards a little. As the bolt continues to turn the rib on the right of it comes up clear of the body and the whole bolt, with the bolt-head, can thus be drawn back until the bolt-head comes against the resisting shoulder on the

right of the body and the extractor attached to it flings out the fired cartridge-case. Another cartridge then comes up from the magazine and lies in front of the bolt-head ready to be pushed home. At this moment (the beginning of loading) the striker on the cocking-piece has fallen into one of the grooves on the bolt, and as the bolt is pushed forward the tongue or full-bent comes against the nose of the trigger sear and is held there, while the rest of the bolt mechanism goes on. Thus between the moving bolt and the fixed cocking-piece the striker spring is further compressed, and when the sloping faces of the bolt lugs and ribs engage the resisting portions of the body a last forward push is given to the bolt and the spring is completely compressed, ready to propel the striker forward. The bolt is then released from the nose of the sear. Figs. 5-8 of the older pattern rifle show the working of the breech mechanism. Instead of the older single pull-off of the trigger the "short" rifle, like many Continental weapons, has a double pull-off. This is provided for by suitably shaping the portion of the trigger which is in contact with the short arm of the sear. The "short" rifle has also a somewhat different pattern of safety-catch.

The sights of British service rifles up to 1903 were of a very simple type, the fore-sight a "barleycorn" of triangular shape, and the back-sight a plain leaf with sliding bar into which a V was cut, the tip of the fore-sight seen in the middle of the V being brought on to the mark.

In the long charger-loader this form of back-sight has been greatly modified, and in the "short" rifle has been altogether abolished. The barleycorn fore-sight has been replaced

in both cases by an upright blade, protected from injury by two ears or wings, and the V by a U aperture. For elevation the long rifle has still a slide on a vertical leaf, but the movement of this slide is controlled no longer merely by its tight fit but by a clamping screw. The sight of the short rifle is larger and also quite different in appearance and principle. There is a leaf and on it a slide, but the slide (controlled by clamping studs) works on a cam-shaped bed; its position on the leaf, affecting the point of contact with the cam-shaped bed, elevates the leaf to the required amount, the actual sighting U being on the extremity of the leaf. The short rifle has also a "fine adjustment" which admits of minor changes of elevation within the usual 50 yds. graduation. Both the long and the short rifles have "wind-gauges," or mechanisms for fine lateral adjustment of the central U sighting aperture, so as to point the axis of the barrel a little to the left or right of the line of sight to compensate for wind, error of the individual rifle, &c. In both rifles, on the left side of the stock, is a long-distance sight (graduated to 2800 yds.), which consists of an aperture sight near the bolt and a dial and movable pointer near the hand-guard. The short rifle is cased from breech to muzzle in a wooden hand-guard; all patterns of long rifle have only a short wooden hand-guard just behind the back-sight bed. The bayonet in the long rifle is secured to the fore-end by a screw catch to the barrel by a ring passing over the muzzle. This traditional, and still usual, arrangement has been abandoned in the short rifle, as the vibration of the barrel on discharge is more or less checked by the extra weight of the bayonet, and therefore the shooting of the rifle differs according as it is fired with or without the bayonet fixed. With the short rifle the bayonet is fixed to two metal fastenings, a plug for the ring and a catch for the handle.

Continental European Rifles.—These are for the most part of the Mauser and the Manlicher types. The Mauser is a bolt weapon with box magazine. The bolt is simple, without separate bolt-head, and is held by two bolt-lugs at its front end engaging with recesses in the body (the German Mauser has an extra lug near the rear end). Near the rear end there is a cam-shaped recess, which, engaging with a stud on the cocking-piece, partially forces back the cocking-piece and springs it when the bolt is revolved. The bolt lever is turned up and the bolt begins to revolve, the cocking-piece and bolt plug, which together form the connexion between the bolt and the trigger, do not revolve, but are forced back slightly, so as to begin the compression of the striker spring. Then, the bolt lever being so shaped as to bear against an inclined-plane edge on the body, the bolt comes back a little, and with it the extractor jaw and the empty cartridge-case. Lastly, when the bolt has turned through a right angle and springs are opposed to the slot in the ways in the body, and the bolt can be drawn back. At the farthest rearward position of the bolt the cocking-stud on the cocking-piece is well behind the nose of the trigger sear, and is thus held when the bolt is pushed forward again, the spring being thereby compressed. All Mauser rifles have a safety-catch and a double pull-off. None have cut-off-locks, but the Turkish pattern. All are constructed for clip or charger loading, but the box magazine contains only one cartridge as against the Lee-Enfield's ten. Mauser rifles, which are perhaps the strongest and least complicated of magazine arms, are used in the German, Belgian, Spanish, Portuguese and Turkish armies, and were also used by the Boers in the South African War. The type adopted by each of these nations differs from the rest in details only. The German rifle has a long guardless sword bayonet, fixed to the fore-end only and not connected with the barrel, and a peculiar form of back-sight, which bears some resemblance to the

slide and bed arrangement of the British "short" rifle. The special feature of the Belgian Mauser is a thin steel casing for the barrel,



FIG. 9.—Belgian Mauser. (Text Book of Small Arms, by permission.)

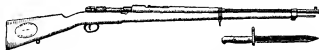

FIG. 9a.—Spanish Mauser. (Text Book of Small Arms, by permission.)

which is supposed to act as a hand-guard or cooler and to free the barrel from disturbing influences due to its connexion with the fore-end; but it is expensive, and if strong adds unduly to the weight



FIG. 10.—German Mauser, 1898. (Text Book of Small Arms, by permission.)

of the weapon. The older German magazine rifle, pattern 1888, had a barrel casing, but this was given up when the new 1898 pattern was introduced. The bayonets of the Belgian and Spanish patterns are very short knives.

The Mannlicher rifle, which is extensively used for sporting and target work, has been adopted for military purposes by various states, notably Austria-Hungary. Both the 1890 and



FIG. 11.—Austrian Mannlicher, 1895. (Text Book of Small Arms, by permission.)

1895 patterns of Austrian Mannlicher have "straight-pull" bolts; that is, bolts which are not turned for locking. The

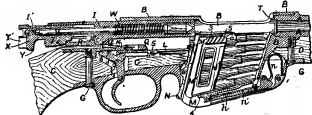

FIG. 12.—Mannlicher, 1890.

bolts are in two parts, which "telescope" into each other. In the 1890 pattern (see fig. 12), when the bolt I is home against the cartridge and the "lever cylinder" I', which carries the bolt knob, is further pushed forward, the hinged block R is caused to drop in front of the resistance-piece Q, and so locks the bolt I against the cartridge. In the 1895 pattern (see fig. 13), the final pushing forward of the lever cylinder causes the head of the bolt I to turn and projections on its head to lock into recesses SS just in rear of the breech. The turning is due to helical feathers (20) on the inside of the lever cylinder I' working in grooves in the rear of the bolt I. The 1890 pattern has a double pull-off. It will be seen from the figure that as the trigger is pulled the bearing is taken first at (8) and then at (9). This gives, owing

to the change of leverage, power at the commencement and rapidity at the end of the pull. The weapon is a clip loader. The Dutch,

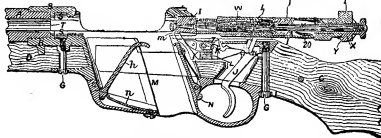

FIG. 13.—Mannlicher, 1895.

Rumanian and other Mannlichers have not straight-pull bolts, but the usual turn-over levers and locking-lugs.



FIG. 14.—Austrian Mannlicher Carbine. (Text Book of Small Arms, by permission.)

France.—The breech mechanism of this rifle (see fig. 15) calls for no special remark. Its bolt is very similar to that of the British rifle. Its special peculiarity is the once popular tube magazine under the fore-end. This has many defects as compared with the box magazine. It is more cumbersome for the same number of cartridges; its feed and cut-off mechanism is very complicated; the balance of the rifle is altered as the magazine empties; the placing of the cartridges base to point, even when the bullet has a flat point, is not unattended with danger, especially when the magazine is full and the spiral spring strongly compressed; lastly, loading by any form of charger is practically impossible.

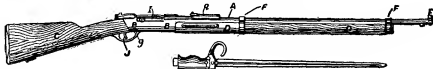

FIG. 15.—Lebel Rifle.

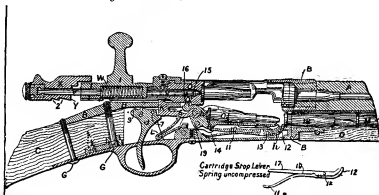

FIG. 16.—Lebel Rifle.

United States.—Up to 1904 the U.S. army had the Krag-Jørgensen rifle, in which, as shown in fig. 17, the magazine was placed horizontally under the breech action. At this time most of the second line troops had still the old-fashioned (black powder) Springfield rifle, a single loader with a hinged block similar to the rifles of the "sixties" in Europe, such as the Snider, the Tabatière and the Wernli.¹ Since 1904, however, the regular army has been re-armed with a short rifle (fig. 18) which in its action has a general resemblance to a Mauser. As at first issued, the new Springfield had a rod bayonet which, when not in use, lay within the fore-end of the stock, and when required was run forward and fastened by a catch. This novelty was, however, soon discarded in favour of a sword bayonet 16 in long. The United States navy had until about 1900 the Lee "straight-pull" rifle. The Russian "3-line" and the Japanese

¹ The Springfield was, however, a much improved model of this kind of weapon, dating from 1884 only.

"30th year" (1900) and "38th year" (1907) rifles are bolt-action weapons, with no special peculiarities. The Swiss rifle (Schmidt-Rubin) is a remarkable weapon of the straight-pull type, short, and possessing a relatively low velocity. (X.)

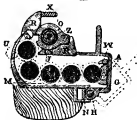
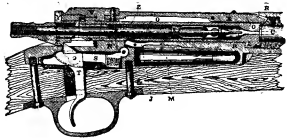

FIG. 17.—Krag-Jørgensen.

The Use of the Rifle in War.—The study of "musketry" as distinct from target shooting may be said to date from the Franco-German War. Previously military students and practical soldiers concerned themselves rather with the tactical question of fire-power—fire *versus* shock, bullet *versus* bayonet and so on—



FIG. 18.—U.S. Short Rifle. (Text Book of Small Arms, by permission.)

than with the technical question of its application. This was natural enough in the days of short-range fighting. But when bullets began to cause losses at 1000 yds. and more from the firing point, formations that presented the least vulnerable target had to be discovered and tested, aiming grew more difficult as the range increased, and firing by word of command in large units became practically impossible. The very accuracy and range of modern weapons involved new problems. The necessity, in the larger area of effective fire, of setting the sights to the distance of the mark made further demands on fire-discipline and brought up the difficult problem of judging distance. The possibilities of varying the rate of fire conferred by the magazine rifle also demanded close study. Each war, as it came, produced fresh evidence as to what was possible and what was not in matters of fire-control, the best rate of fire for effect, the range at which fire should be opened, and other half-tactical, half-technical problems. Thus, although many points still remain in the region of controversy, certain ideas and principles are almost universally accepted as the basis of service musketry.

The leading idea is that of the "cone of dispersion." A modern rifle, even fired from a fixed rest under good conditions, will not place shot after shot in the same spot, but the shot-marks on the target form a more or less close "group." When to this error of the rifle and the ammunition there is added the personal error of the marksman, the group is larger, and in the collective fire of a squad it is larger still. Now the trajectories of bullets that do not strike in the same place naturally do not coincide, and the group on the target is represented in the air by a cone or sheaf of trajectories. The bullets of this sheaf striking the ground on either side of the target form on the ground a much elongated ellipse. The ellipse containing 90% of the bullets fired is called the *beaten zone*. It is usual, however, to calculate from the "effective" zone, or that which contains 75% of bullets. Within the "effective" zone, and at its centre, is found the closely grouped "nucleus" of

50% of bullets. With the British .303 rifle in collective fire, the depths of these zones are:—

	Nucleus.	Effective.	Beaten.
500 yds.	120 yds.	220 yds.	320 yds.
1000 "	70 "	120 "	170 "
1500 "	60 "	100 "	140 "

The target aimed at and sighted for is at the centre of the zone (see fig. 19). The height of the grouping on a vertical target compared to the depth of the grouping on the ground is of course proportionate to the tangent of the angle of descent; hence, small as is the group on a vertical target at 500 yds., the beaten zone is no less than 320 yds. deep. For the same reason, as the range, and consequently the angle of descent, increases, the beaten zone diminishes in depth. Another factor is the "dangerous space." This is the space between "first catch," *i.e.* the point at which the bullet (in a sheaf, the lowest bullet) comes low enough to catch a man's head, and "first graze," that at which it strikes the ground. The extent of this dangerous space varies of course with the height of the man's head. In the case of a mounted man, at 1000 yds., it is 105 yds. (while in that of a sharpshooter lying down, it is only 13 yds., in addition of course to the beaten zone). As nowadays nearly all targets, on service, are lying or three-quarters concealed figures, the dangerous space as compared with the beaten zone is at such a range too small to count as a factor. It is, however, important at shorter ranges, 500 yds. and under (700 and under with the new pointed bullets). Here the advantages of flat trajectory make themselves felt. Within this distance the bullet is at no point in its career too high to be dangerous to a standing man or a horseman. A lying figure is in danger at any distance beyond 350 yds. if the sights are set to 500 yds. (front half of effective zone 110 yds., dangerous space 52 yds.). This is the theory underlying the 500 yds. "fixed sight" or "battle-sight," a setting which holds good for all less ranges, and can be put on the rifle instantly and without looking at the back-sight graduations.

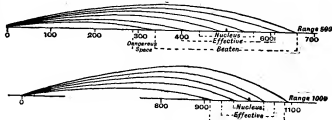

FIG. 19.—Beaten Zone.

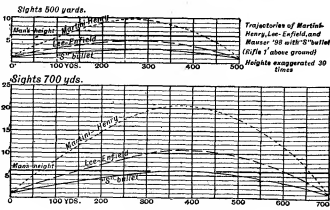

FIG. 20.—Trajectories.

These facts, taken in conjunction with the imperfections of the most skillful individual marksmanship and the chances of wrong estimation of distance, are the basis of the musketry training and practice of to-day. At the School of Musketry, Hythe, the standard of judging distance is "not more than

Country	AUSTRIA AND BULGARIA.		BELGIUM.	DENMARK.	GREAT BRITAIN.		FRANCE.	GERMANY.
	1895.	1895.	1889.	1889.	1907.	1907.	1886.	1898.
Pattern of the Year	1895.	1895.	1889.	1889.	1907.	1907.	1886.	1898.
Designation	MANLICHER.	MAUSER.	KRAG-JORGENSEN.	CHARGER LOADING LEE-ENFIELD, MARK I.	SHORT LEE-ENFIELD, MARK III.	LEEEL.	MAUSER.	
Magazine System	Box	Box	Horizontal-box	Box	Box	Tube	Box	
Number of Cartridges in Magazine	5	5	5	10	10	8	5	
Charger or Clip	Clip	Ch.	Ch.	Ch.	Ch.	No	Ch.	
Cut off	No	No	Yes	Yes	Yes	Yes	No	No
Safety Bolt	Yes	Yes	No	Yes	Yes	No	Yes	Yes
Weight:— Without bayonet	8 lb 5½ oz.	8 lb 4 oz.	9 lb 12½ oz.	9 lb 4 oz.	8 lb 2½ oz.	9 lb 3½ oz.	9 lb 14 oz.	9 lb 14 oz.
With bayonet	8 lb 15¼ oz.	9 lb 9¼ oz.	10 lb 4½ oz.	10 lb 3½ oz.	9 lb 10¼ oz.	10 lb 1½ oz.		
Length:— Without bayonet	4 ft. 1 in.	4 ft. 2½ in.	4 ft. 4-7½ in.	4 ft. 1-5 in.	3 ft. 8-5 in.	4 ft. 3-12 in.	4 ft. 1-4 in.	4 ft. 1-4 in.
With bayonet	4 ft. 11-7½ in.	4 ft. 11-7½ in.	5 ft. 3 in.	5 ft. 1-5 in.	5 ft. 1-7 in.	5 ft. 11-84 in.	5 ft. 9-7½ in.	5 ft. 9-7½ in.
Barrel:— Length	30-12	30-67	32-9	30-19	25-10	31-496	29-05	29-05
Calibre	8	7-65	8	7-7	7-7	7-303	7-9	7-9
Rifling:— Number of grooves	4	4	6	5	5	4	4	4
Twist (to right, except in Lee-Enfield and Lebel) 7 turn in calibres	31	32-5	37-5	33	33	30	30-2	30-2
Sights:— Lowest for	500 paces (410 yds.)	500 m. (547 yds.)	300 m. (328 yds.)	183 m. (200 yds.)	250 m. (273 yds.)	250 m. (273 yds.)	200 m. (210 yds.)	200 m. (210 yds.)
Highest for	2600 paces (2132 yds.)	2900 m. (3187 yds.)	1900 m. (2078 yds.)	2500 m. (2800 yds.)	2000 m. (2187 yds.)	2000 m. (2187 yds.)	2000 m. (2187 yds.)	2000 m. (2187 yds.)
Cartridge:— Length	3-0	3-055	3-0	3-05	3-05	4-47	3-225	3-225
Weight	455	441	450	475	475	447	415	431
Bullet:— Shape of point	Round	Round	Round	Round	Round	Round	Pointed	Pointed
Material of envelope	Steel, lubricated	C.N.	C.N.	C.N.	C.N.	C.N.	{ Copper zinc, no envelope	Steel, coated with C.N. {
Length	1-24	1-205	1-187	1-25	1-25	1-221	1-625	1-235
Diameter (max.)	3-288	3-1	3-23	3-21	3-21	3-228	3-27	3-23
Weight	244	219	237	215	215	231	196	227
Charge:— Weight	42-44	37	33-05	33-5	33-5	42-43	46-2	40-75
Propellant	N.C.	N.G. and N.C.	N.C.	Cordite	Cordite	N.C.	N.C.	N.C.
Muzzle Velocity	2034	2054	1968	2060	2060	2075	2380	2093
Chamber Pressure:— Tons on sq. in.	19-7	19-7	15-4	15-5	15-5	17-75	17-75	21

NOTE.—C.N. = Cupro-nickel. N.G. = Nitro-glycerine.

100 yds. wrong at any range." Now at 1000 yds. an error in judging distance of 13 yds. above or below the true range will cause all the shots of a particular rifle to fall away from the target, and the better the marksman—i.e. the closer his grip—the more necessary is perfection in judging distance, a perfection which in reality seems unattainable. The British musketry regulations therefore lay it down that the individual marksman's fire at service targets is unprofitable at ranges of more than 600 yds. Beyond that distance collective fire, controlled and directed by an officer or non-commissioned officer, is the rule. The question as to whether fire is to be opened in any given set of circumstances is decided by the fire-director, who considers first whether the probable error in judging distance is greater than half of the effective zone for the estimated range. If it is so, he must order "combined sights," i.e. half of the units under his command use one elevation, the rest another, which method artificially increases the dispersion of the bullets and thereby the probability of the target being included in the zone. This, however, makes the fire less effective, and in practice cannot profitably be used by any body of rifles of less than 80 or 100. The commander of only a single section, therefore, however tempting the target, must refrain from opening fire at all. At medium ranges, however, controlled and directed fire is effective, and at such ranges troops should still be sufficiently in

hand to execute the fire-director's orders. Within decisive ranges fire-direction has to give place to fire-control. All that the strongest commander can enforce is the opening and ceasing of fire when he gives the order, and success is sought through making the individual soldier skilful at rapid and snap shooting. Black bull's-eyes on white targets are now used only to teach men to make uniformly good shooting, which is shown by the closeness of the shot-grouping. The rest of the musketry course is fired against grey-green "head and shoulders" targets or brown silhouettes, and consists of slow, rapid and snap shooting, from behind cover, at disappearing or running targets, &c. In 1909 special attention began to be paid to visual training, both as an aid to judging distance and as an actual ingredient of fire-discipline. A method of indicating targets which originated in the French army was adopted and improved upon, consisting essentially of giving two or three conspicuous "auxiliary marks," in artillery language, and naming the target with reference to them. Judging distance is generally associated with fire-discipline practices, and men are frequently exercised in locating and ranging upon a hidden skirmisher, 300-800 yds. away. Perhaps the most important modification of musketry training, within recent years, has been the adoption of rapid fire in "bursts," as the normal procedure for infantry, instead of slow continuous fire. The complete cessation of fire at intervals enables the leaders to observe the

MILITARY MAGAZINE RIFLES.

Text Book of Small Arms, 1909.)

GREECE.	HOLLAND.	ITALY.	JAPAN.	PORTUGAL.	RUMANIA.	RUSSIA.	SPAIN.	SWITZER- LAND.	TURKEY.	UNITED STATES.
1903.	1895.	1891.	1907.	1904.	1893.	1894.	1896.	1900.	1899.	1904.
MANNLICHER- SCHONAUER.	MANNLICHER.	MANNLICHER- CARCANO.	YEAR '38.	MAUSER- VERGIERO.	MANNLICHER.	"3-LINE" NAGAT.	MAUSER.	SCHMIDT-RUBIN SHORT RIFLE.	MAUSER.	SHORT SPRINGFIELD.
Box	Box	Box	Box	Box	Box	Box	Box	Box	Box	Box
5	5	6	5	5	5	5	5	6	5	5
Ch. No Yes	Clip No Yes	Clip No Yes	Ch. No Yes	Ch. No Yes	Clip No Yes	Ch. No Yes	Ch. No Yes	Ch. No Yes	Ch. Yes Yes	Ch. Yes Yes
8 lb 5¼ oz. 9 lb	10 lb 11 oz. 10 lb 6¼ oz.	8 lb 6½ oz. 9 lb 3 oz.	8 lb 10 oz. 9 lb 9 oz.	8 lb 13 oz. 9 lb 9½ oz.	8 lb 12¾ oz. 9 lb 9¼ oz.	8 lb 15¼ oz. 9 lb 11¼ oz.	9 lb 6¼ oz. 10 lb 5¼ oz.	8 lb ¾ oz. 8 lb 10¼ oz.	9 lb 1 oz. 10 lb 8 oz.	8 lb 8 oz. 9 lb 8 oz.
4 ft. 4 ft. 10 in.	4 ft. 3 in. 5 ft. 0.75 in.	4 ft. 2.75 in. 5 ft. 2.375 in.	4 ft. 2.75 in. 5 ft. 5.75 in.	4 ft. 4 ft. 11¼ in.	4 ft. 0.5 in. 4 ft. 10.25 in.	4 ft. 3.875 in. 5 ft. 9 in.	4 ft. 0.625 in. 4 ft. 10.5 in.	3 ft. 7.12 in. 4 ft. 10.75 in.	4 ft. 0.6 in. 5 ft. 6.6 in.	3 ft. 7.22 in. 4 ft. 11.21 in.
28-56 6-5 -256	31-125 6-5 -256	30-75 6-5 -256	31-3 6-5 -256	29-08 6-5 -256	28-56 6-5 -256	31-5 7-62 -3	29-031 7 -276	23-33 7-5 -295	29-134 7-65 -301	23-79 7-62 -30
4	4	4	4	4	4	4	4	3	4	4
..	3.7-8	3.2-2	3.0-7	3.0-7	3.0-8	3.1-6	3.1-4	3.6	3.2	..
200 m. (219 yds.) 2000 m. (2187 yds.)	200 m. (219 yds.) 2000 m. (2187 yds.)	600 m. (656 yds.) 2000 m. (2187 yds.)	400 m. (437 yds.) 2000 m. (2187 yds.)	200 m. (219 yds.) 2000 m. (2187 yds.)	300 m. (327 yds.) 2000 m. (2187 yds.)	400 paces (310 yds.) 2000 paces. (2096 yds.)	400 m. (427 yds.) 2000 m. (2187 yds.)	300 m. (328 yds.) 1400 m. (1512 yds.)	250 m. (272 yds.) 2000 m. (2187 yds.)	185 m. (200 yds.) 2187 m. (2380 yds.)
3.05 348	3.05 338	3.0 331-8	2.98 348-5	3.25 ..	3.05 350	3.025 363	3.08 373-5	3.043 424	3.07 410	3.33 392
Round	Round	Round	Round	Round	Round	Round	Round	Round	Round	Pointed
{ Steel coated with C.N.	Steel coated with C.N.	C.N.	Copper	..	C.N.	C.N.	C.N.	{ Nickel plated, steel envelope over point	Steel coated with C.N.	C.N., pointed
1.124 -263 190-3	1.23 -2937 162-9	1.182 -266 165-9	1.28 -26 162-9	1.244 .. 155-3	1.244 .. 162	1.194 -308 214	1.21 -2843 172-8	1.18 -310 212-5	1.212 -311 211-3	1.08 -308 150
36 N.C.	36-26 N.C.	30-90 Ballistite	32-0 N.C.	31-8 and N.C.	36 N.C.	33 Pyrocellulose	38-35 N.C.	30-7 N.C.	40-2 N.C.	50 Pyro-cellulose
2223	2433	2395	2396	2347	2400	1985	2206	1920	2066	2600
20-18	..	17-1	17-47	22-3	17-1	19-7	19-28

N.C. = Nitro-cellulose.

progress of the engagement, to change their target, to economize ammunition, to select the ground for the next rush and the next burst of fire, and to regain control of the men, whom a prolonged fire-fight hypnotizes and rivets to the ground. The chief use of "slow" fire, which is generally employed by skirmishers working in pairs, is to keep the enemy under; the storm of well-directed "rapid fire" the fire-director should hold in his own hands, ready to release it at the right moment. Slow fire averages 3 rounds a minute, rapid (aimed) 8-12. The configuration of the ground has often a great influence on fire effect. If the target is on a sharp forward slope, the beaten zone is greatly diminished in depth, ranging errors are no longer neutralized by the flatness of trajectory and (the bullets meeting the ground at a steeper angle) the dangerous space is reduced; if, on the other hand, the slope descends gently in rear of the target so that the falling bullets instead of making a pattern upon the ground, skim along parallel to the surface, the zone is increased. For instance, at 1500 yds., if there is a reverse slope of about 5° in rear of the target the depth of the beaten zone is tenfold that of the zone for the same range on level ground. Similarly if the target is on the crest of a hill and the firers below, the "over" half of the cone of fire may graze the reverse slope or pass far above, according as the reverse slope is gentle or sharp with respect to the line of sight.

The normal position for the firing infantryman in action is

lying; the kneeling position is used for firing from behind cover, the sitting for firing down hill. Standing, formerly the usual position, is now employed chiefly for firing behind cover with the rifle rested, and for snap-shooting during an advance when it is undesirable to halt and lie down. As regards cover, it may be mentioned that well-covered or entrenched troops generally shoot less accurately than troops in the open, the soldier in security being loth to expose himself long enough to take careful aim. This was particularly noticeable in the Russo-Turkish War, and its effect is to create a zone of unaimed fire behind the assailants' fighting line, which sometimes causes serious losses to his supports and reserves. The relation between the cone of dispersion of peace-time experiments, even when these are specially designed to establish that relation (for example, series fired in France by third-class shots, after a long march without food), has never been satisfactorily established. An arbitrary figure of one-tenth or one-twentieth of peace-time effect has generally been assumed as representing war results, but some think that however the normal cone may be multiplied or divided, no relation can be found between peace and war effect, and that in battle the brave men aim and fire as if on the practice range, and the rest fire absolutely at hazard. From a musketry point of view, this brings again into the foreground the question of distance-judging, as, if the sights be wrongly set, the more accurate the fire the less its effect, and a

mistake would nullify even the small amount of aimed fire that can be reckoned upon. Peace-time experiments have their value—and it is very great—in establishing data as to the effect of fire on troops in different formations, the limits of permissible error in ranging, &c., on the principle that of two methods, that which is proved to be better in peace would in much the same proportion be found better in war. (C. F. A.)

See T. F. Fremantle, *The Book of the Rifle*; W. W. Greener, *The Gun and its Development*; the British official *Text Book of Small Arms* (1909); and *Musketry Regulations* (1909); C. B. Mayne, *Infantry Fire Tactics*; and Taffin, "Tir de Combat" (*Revue d'infanterie*, 1909).

Match or Target Rifle.—The sport or pastime of target shooting has many times changed its character, owing to the steady improvement in the rifle and the different ranges or distances at which shooting is practised. Range usually governs the construction of the target rifle, long-range rifles not being necessarily the best weapons for a short range of, say, 200 yds. Limitations—such as the amount of powder charge, weight of bullet and rifle—are also usually imposed in order to place all competitors on equal terms. The long-range match rifle is not the superior of the military rifle as a weapon, but as a scientific shooting instrument is the best small-arm produced. The ordinary target rifle is a hybrid arm, combining the points of the long-range match, modern military and best sporting rifles. The miniature match rifle is used for short-range practice.

Shooting at fixed marks has been practised continuously in Switzerland from medieval times. A club ("Société de l'arquebuse et de la Navigation") has existed in Geneva since 1474; and the Zürich "Schützen-Gesellschaft" since about the same date. It is not clear at what period rifles were introduced in these clubs. From the beginning of the 19th century up to 1844 the rifle generally used in Great Britain had a polygrooved barrel .630 in. in diameter, with spherical ball, and the arm weighed from 11 to 15 lb. It was not fired in military fashion, but had a handle extending downwards fixed in front of the trigger-guard, which was grasped by the left hand, the left arm being steadied against the body. This method of shooting is still sometimes followed by Swiss and German riflemen. Target shooting as a sport or business was rarely practised in Great Britain until after the formation of the Volunteer Force in 1859. The inauguration of the "National Rifle Association" in 1860 opened a new and most important era in the history and development of the rifle. This institution was established "for the encouragement of rifle corps and the promotion of rifle shooting throughout Great Britain. . . . As a national pastime to make the rifle what the bow was in the days of the Plantagenets, the familiar weapon of those who stand forth in the defence of their country." The first meeting of the N.R.A. was held at Wimbledon in 1860. The first shot was fired by Queen Victoria¹ from a Whitworth rifle on a machine rest, at 400 yds., and struck the bull's-eye. The Whitworth muzzle-loading rifle won many of the important prizes at this and subsequent meetings prior to 1871. Its most important features, arrived at after exhaustive experiments, were a smaller bore of .450 in., with a twist of rifling of one turn in 20 in., and an elongated mechanically fitting projectile. Long-range rifle construction is also largely indebted to Whitworth for the highly accurate and superior tools and processes introduced by him in this branch of manufacture.

In 1866 and after, Metford's system of hardened expanding bullets and shallow rifling gradually superseded the mechanically fitting system of Whitworth, and the Whitworth rifle gradually lost its position. In 1861, the Henry grooving for a cylindrical

bullet, a modification of the Whitworth, first appeared. In 1864, Rigby, with a five-grooved rifle and a mechanically fitting bullet, tied with the Whitworth rifle in the preliminary rifle trial of the N.R.A. at 1000 yds., and in a subsequent trial took the first place. By 1871 the Whitworth rifle had given place to the Metford system with hardened cylindrical bullets, shallow rifling and increasing spiral. In 1867 the modern breech-loading rifle with a metallic cartridge was first introduced. The Metford system of rifling greatly assisted its development. In this year Rigby also produced a new model long-range rifle designed on the lines followed by Metford. In 1869 the Henry barrel came to the front. In 1870 the Martini-Henry, the new service arm, won the duke of Cambridge's prize, the extreme range in this competition being 800 yds. In 1871 the Snider breech-loader replaced the Enfield muzzle-loader, and the Martini-Henry replaced the Whitworth in the later stages—800, 900 and 1000 yds.—of the Queen's prize. The Metford barrel was also used in breech-loaders, and the duke of Cambridge's prize—for the first time fired at 1000 yds.—fell to it. During the twenty-three years from 1871 to 1894 the Metford military match rifle only four times failed to win this prize, while it took a preponderating share of other prizes. The years 1872 and 1873 marked a decided advance in the military breech-loader, though for fine shooting the muzzle-loader still seemed hard to equal. In 1875 a team of American riflemen first visited Wimbledon with "army-pattern" breech-loading rifles, which were cleaned out after every shot, and met with considerable success. A feature of their shooting was the "back position," then a novelty. In 1877 the superiority of the cleansable and cleaned breech-loader over the increased fouling of the muzzle-loader was clearly demonstrated, though the muzzle-loader did not at once disappear. In 1878 the highest scores ever made with the muzzle-loader in Great Britain were recorded, greater care in cleaning the rifle after every shot being observed.

In 1883 the N.R.A. Council altered the conditions, wiping out after every shot was forbidden, but muzzle-loaders were not disqualified. The result was that the American type of rifle disappeared. The poor shooting of the Martini at 1000 yds. induced the Council to take the retrograde step of reducing the maximum range for the Queen's prize to 900 yds. In 1890 the N.R.A. first met at the new ranges at Bisley. This year was noticeable for the excellent shooting made in the "any" rifle competitions by the Gibbs-Metford match rifle, particularly at 1000 yds. range. The accepted type was .461 calibre; 7 grooves .0045 in. in depth; 80 grains of special black gunpowder, and a bullet of 570 grains. In 1892 and 1893 the Lee-Metford .303 rifle with cordite ammunition was first used by the army teams. In 1890 and later the Hon. T. F. Fremantle, Captain Gibbs and some others used Metford's copper-coated bullets in the Gibbs-Metford rifle with success. In 1895 many match rifle shots followed their example. In 1895 and 1896 the .303 was equalled, and in some instances beaten, by the smaller-calibre Mannlicher rifle. This was partly due to faulty Lee-Metford ammunition. The .303 now proved its superiority to the .450 Martini, especially at the longer ranges. The Bisley meeting of 1896 practically closed the series of contests with both the Martini and the military match rifles. The Volunteers were thenceforth armed with the .303.

The results of the Bisley meetings since 1895 have proved that rifles of the .303 class, the British .303 rifle particularly, are not so good for match rifles pure and simple as the larger bores using black powder. The light bullets are more subject to deflection by the wind at long ranges than the heavier speed-retaining bullets of the larger bores. No nitro-powder used appears to have equalled the black powder in regularity of shooting. At the same time the object of the N.R.A. competitions is to encourage the use of the military service rifle in the first place, and in the case of the "any" rifle competitions to encourage the production of weapons of the highest efficiency for military purposes. Acting on these principles the rifles allowed by the N.R.A. regulations (1907) are classed as follows:—*Class I.*—Service rifle (S.R.); government pattern .303 magazine rifles;

¹ The "Queen's" or "King's" prize is the highest distinction to which a rifle shot can attain. The competition is one of three stages, the first and second eliminating all but the best 100 competitors. The bronze medal of the N.R.A. is awarded to the highest scorer in the first stage, the silver medal to the leader in the second, and the King's prize and N.R.A. gold medal to the winner in the last stage: 71 shots in all are fired at distances up to 1000 yds., and the winners' scores of late years have been 320 to 325 out of a possible 355. Only the service rifle is allowed.

sights strictly in accordance with service pattern.¹ *Class II.*—Match rifles (M.R.): any breech-loading rifle complying with the following conditions: maximum weight of barrel, 3½ lb; maximum calibre, .325; stock sufficiently strong for service purposes, and without pad or shoe on the heelplate; minimum pull of trigger, 4 lb; sights, of any description. *Class III.*—Military breech-loading rifles (M.B.L.): any rifle, that is either (a) the regulation military rifle of any country; or (b) a breech-loading rifle complying with the following conditions: maximum weight, exclusive of bayonet, 8½ lb; maximum calibre, .315; minimum pull of trigger, 4 lb. Sights may be of any description except telescopic or magnifying, but must be fixed to the barrel and must be strong enough for military purposes. *Class IV.*—Sporting rifles: calibre, any; minimum pull of trigger, 3 lb; sights, open or such as are sanctioned by the council or committee. The Lyman back-sight and the Beech combination fore-sight have been sanctioned. No lateral adjustment of fore- or back-sight is permitted. The miniature rifles allowed fall into two classes, "military," with open sights, only, and "any," with no restrictions as to sights except that magnifying and telescopic sights are forbidden.

Modern American Target Rifles.—In America, according to some authorities, there are three recognized departments of target shooting—namely off-hand shooting; shooting from a simple rest; and shooting from a machine rest, with telescopic or any other sight. For the first two classes small-bore rifles of .380 calibre or under only are used. The usual weight is from 8 to 10 lb, with 28- or 30-in. barrel. Light charges for the shorter ranges are used. In the .380 bore only 55 grains of powder with a 350-grain bullet is employed. In the second-class contests, from a simple rest, the barrel is longer and the weight increased to just under 12 lb. The bore is generally .380. The usual range is 200 yds. The third-class shooting from a machine rest, generally with telescopic sights, is not much practised. Every kind of rifle is employed, usually of large bore and weighing from 20 to 60 lb. The long-range breech-loading match rifle, with which so much fine shooting was done when wiping out after each shot was allowed, weighed about 10 lb; the breech mechanism, any falling block, as the Sharp, Farquharson, Deeley, and Edge or Wiley, that admitted the insertion of the cleaning rod at the breech; length of barrel, 32 to 34 in.; seven or more grooves .003 to .005 in depth with a complete turn in 20 in. A sharp continual spiral and very shallow grooves constituted the feature of the American plan. Rigby's plan was similar, with one turn in 18 in. and eight grooves, the lands being about half the width of the grooves. In the Wiley the grooves were fewer and wider. The Metford is an increasing twist, starting with one turn in 60 in. and finishing with one in 20, or sharper. The usual bore of the American long-range rifle was .458 or .461; powder, 76 grains of special "fouling" rifle powder; elongated cylindrical bullet of 540 grains. The pull-off was under 3 lb. During recent years smaller-bore smokeless-powder rifles have also been used.

Continental Match Rifles.—The target rifle used by continental marksmen for medium ranges is a modification of the old pattern Swiss rifle, with scroll guard, hollowed butt plate and hair trigger. This latter, a mechanical device to free the tumbler from the sear without sufficient pull on the trigger to influence the aim, is disallowed in military arms.

Sporting Rifles.—Prior to 1845 smooth-bore guns with double charge of powder and an ounce spherical ball were generally preferred to rifles for sporting purposes and for large game; 16-bore muzzle-loading rifles were occasionally used by British sportsmen in the East Indies before that date, firing 1½ drs. of powder with a spherical ounce ball. These rifles were sighted to 200 yds., but the trajectory was high and the penetration weak; they were also difficult to load when fouled. The twist of the rifling was also too rapid, causing the bullet to strip with heavy charges of powder. According to Captain Forsyth and others, up to 1860 there was no known rifle suitable

¹ The N.R.A. have recently sanctioned the use of the aperture sight in service rifles, provided it be attached to the weapon by the hinge-pin which fastens the ordinary folding leaf.

for sporting purposes in India. Rifles of 12-bore gauge, firing a spherical ball, were subsequently made, with broad and shallow grooves making one turn in 10 ft. The bullet, of the same diameter as the bore, was loaded with a thin patch that took the grooving. These rifles proved very successful, possessing velocity equal to a smooth-bore of the same calibre, accuracy for sporting distances, flat trajectory and great striking power. In 1855 W. Greener produced the "Cape rifle" for South African sport, calibre .450 or .500; rifling, two deep grooves with one turn in 26 in., with a flanged bullet to fit the grooves; weight, 12 lb; sighted up to 1200 yds. This rifle was successful, and others were built by Purdey, who in 1856 named the pattern "Express Train." Since that date the word "express" has been generally used to denote a rifle possessing high velocity, flat trajectory and long fixed-sight range.² In America small-bore rifles were used earlier in the 19th century. The celebrated Kentucky rifles were of various sizes, firing spherical balls of 90, 60 and 40 to the lb, and were renowned for their accuracy and fixed-sight range up to 100 yds. Some maintain that the express rifle was developed from the Kentucky model. The modern express rifle may be defined as a breech-loading rifle with a height of trajectory not exceeding 4½ in. at 150 yds., with a muzzle velocity of at least 1750 f.s. These rifles are usually 5- to 7-grooved, double-barrelled, with 26- to 28-in. barrels of .360, .400, .450, .500 and .577 bores, weighing respectively from 6½ to 7 lb, 7 to 8 lb, 7½ to 9 lb, 8½ to 10 lb and 10½ to 12 lb. The respective average charges are: bullet, 150 grains; powder, 50 grains; 209 and 82; 270 and 110; 340 and 130; 520 and 160; the fixed-sight ranges, 130, 160, 150, 130 and 120 yds. Double and single express rifles of .303 bore with 26-in. barrels are also made.

Since the invention of cordite powder and the advent of the small-bore high-velocity rifle for military purposes, the variety of sporting rifles with different-sized bores has increased. Sporting cordite express rifles are now made, both single- and double-barrelled, of the following calibres: .256, .265, .276, .303, .310, .360, .370, .375, .400, .450, .500, .577 and .600. Some of these calibres, such as .500, .577 and .600, are seldom used with cordite. The .450 cordite express is the largest bore high-velocity rifle recommended.

The modern small-bore military rifle already described possesses all the best qualities of an express sporting rifle—namely accuracy, flat trajectory, high muzzle velocity and long point-blank or fixed-sight range up to 200 yds. The muzzle velocity of the .303 bore with black powder is 1850 f.s.; with cordite, 2100 f.s. The hollow-pointed or slit expanding bullet is generally used in these high-velocity rifles, as in the black-powder express, for ordinary sporting purposes, with the solid metal cartridge-case. The pointed bullet is also sometimes used, generally with the .375 and .475 calibre rifles, and gives an increased muzzle velocity of 2500 f.s. The trajectory of the cordite rifle is stated to be 10 in. flatter at 200 yds. than that of a black-powder rifle of similar calibre and corresponding charge. The variety of bores in sporting rifles is due largely to restrictions on the importation of arms of the military calibres (especially .303) into India and South Africa.

The sights of sporting express rifles are of some variety, and are usually designed and made with special care. The open V

² The term "point-blank range" is often used in this connexion. Strictly speaking, there is no such thing as "point-blank range," the bullet commencing to drop immediately it leaves the muzzle of the rifle. The path or trajectory of the bullet if fired horizontally is therefore always a downward curve. The higher the muzzle velocity the flatter is this curve. The "fixed-sight," or so-called "point-blank" range, is usually taken at such range, generally 100 yds. with black powder, and with such elevation as render the amount of drop of the bullet or curve of its path practically immaterial for sporting purposes, say a maximum of 4½ in. At shorter range this curve would therefore take the bullet so much above the line of fixed-sight aim, and must where necessary be allowed for. With the high-velocity small-bore rifle the fixed-sight range can be increased to 200 yds. for the sporting rifle; and for military purposes in the field to 500 yds. and (with pointed bullets) even more.

back-sight on an ivory pyramid with two or three leaves up to 300 yds., and the enamelled bead fore-sight, are the most usual form. The more elaborate Lyman and Beech peep-sights are also popular. One or two varieties of telescope sight, attachable to the barrel, are also made by some leading gunmakers, and have been used with success in the field. Solid-drawn brass cartridge-cases are now always used for sporting rifles, except occasionally for some of the larger bores, in which paper cartridges may be used. The peculiarity of the express bullet is its hollow point, which is intended to ensure the expansion of the projectile on impact. This diminishes its penetration, but translates its velocity or energy into "shock." If greater penetration is needed, the leaden bullet is hardened with mercury or tin, or the military nickel-coated bullet is used. Explosive bullets filled with detonating powder were at one time used in express and large-bore rifles for large game. These are now practically abandoned, owing to their uncertainty of action and the danger in handling them. The use of the large 4- and 8-bore black-powder rifles is restricted to the hunting of large and dangerous game. These are usually double-barrelled. The 4-bore weighs from 14 to 18 lb with 20-in. barrels, and fires a charge of 12 to 14 drs. of powder, with a spherical bullet of 150 grs. The great weight of this rifle is against its general use. The 8-bore rifle weighs from 11½ to 15 lb with 20- to 24-in. barrels, with a charge of 8 to 12 drs. of powder with a spherical ball. These rifles are accurate and effective up to 120 yds. Rook and rabbit rifles are usually single-barrel breech-loading rifles of from .220 to .380 bore, hammerless, ejectors. The range is ordinarily restricted to 200 yds.

Combined rifles and shot-guns are generally used in countries where the kind of game to be met with is not known beforehand, and by emigrants who can only afford one gun. These weapons are double-barrelled (.450 rifle barrel and 16-bore short barrel; or .500 rifle and 12-bore shot). Such a gun has many drawbacks, being too heavy for a shot-gun and too light for a rifle, with a bad balance. More modern combinations of the rifle and shot-gun are Holland's "Paradox," a smooth bore with the last three inches of the barrel ratchet-rifled, Lancaster's "Colindian" twisted oval bore, and Bland's "Euoplia" with "invisible" undulating rifling. All these weapons fire heavy bullets more or less accurately up to 100 yds., are also used as shot-guns, and are made double- or single-barrelled and of various calibres, 12-bore being the most common. There is also Greener's "under, and over," the rifle barrel being topmost (usually 16-bore shot-gun barrel and .450 rifle barrel). The Morris tube also enables a shot-gun to be utilized as a small-bore rifle or a large rifle as a saloon rifle for gallery practice. The automatic principle has not yet been applied to sporting rifles.

Miniature Rifles.—In 1905 a War Office miniature or cadet rifle for instruction purposes was officially adopted by the British military authorities. The details of this rifle were determined by a committee, upon which the National Rifle Association and the Society of Miniature Rifle Clubs were represented. It is a single-loading bolt-action rifle of .22 calibre with military sights (the aperture sight being barred), shooting a rim-fire cartridge having a 40-gr. bullet propelled by 5 grs. of black gunpowder or its equivalent in some smokeless explosive. It is used at ranges from 25 yds. up to a maximum of 200 yds. The official adoption of such a rifle was largely due to the civilian rifle club movement, which was the outcome of the South African War, and in which the Society of Miniature Rifle Clubs has played an important part. Until the recent official adoption of the miniature rifle, the council of the N.R.A. regarded marksmanship with the service rifle as its main object of encouragement, and the service rifle itself as the orthodox weapon. The Society of Miniature Rifle Clubs, on the other hand, makes the encouragement of the use of low-power rifles its special object, with few restrictions as to type of sights, rifle or ammunition. Numerous civilian rifle clubs have adopted the .22 calibre rifle, in many cases with aperture sights, with marked success, and British rifle-makers were encouraged to cater for this new

demand for low-power rifles. Such weapons can be far more widely and generally used than the ordinary service weapon, owing to their smaller cost, cheaper ammunition, absence of recoil, and their convenience for use at short covered ranges in crowded centres of population. In many parts of Great Britain there is practically no alternative between low-power short-range practice and no shooting at all. The N.R.A. has now admitted the miniature .22 calibre rifle upon equal terms with the service rifle. The miniature rifle has, to some extent, taken the place of the Morris tube and "adaptors" previously used for rifle practice at short ranges.¹ The Morris tube consists of a small-rifled barrel, usually chambered for the .297/.230-bore cartridge, and capable of being fitted inside the barrel of the ordinary service weapon, which thus becomes available as a miniature rifle for short-range practice. The Morris tube has been adopted by the British War Office, and affords an excellent means of training the recruit. "Adaptors" are dummy cartridge-cases fitted into the breech of the ordinary rifle, by means of which a shorter cartridge firing a lighter charge of powder, but with a bullet of the same calibre as the rifle, can be used for short-range practice. One of the first English miniature target rifles was the "Sharpshooters' Club" rifle, on the Martini principle, of .310 calibre, manufactured and introduced by W. W. Greener, and suitable for ranges from 50 to 300 yds. This rifle was adopted by many rifle clubs, and in 1901 established a record in the miniature rifle competition at Bisleigh. Miniature rifle shooting has been much encouraged throughout the United Kingdom by the establishment of the Light Rifle Championship competition under the auspices of the Society of Miniature Rifle Clubs. In 1907 Queen Alexandra presented a cup for this event. (H. S.-K.)

RIFLEMAN-BIRD, or RIFLE-BIRD, names given by the English in Australia to a very beautiful inhabitant of that country,² probably because in coloration it resembled the well-known uniform of the rifle-regiments of the British army, while in its long and projecting hypochondriac plumes and short tail a further likeness might be traced to the hanging pelisse and the jacket formerly worn by the members of those corps. The cock bird is clothed in velvety-black generally glossed with rich purple, but having each feather of the abdomen broadly tipped with a chevron of green bronze, while the crown of the head is covered with scale-like feathers of glittering green, and on the throat gleams a triangular patch of brilliant bluish emerald, a colour that reappears on the whole upper surface of the middle pair of tail-quills. The hen is greyish-brown above, the crown striated with dull white; the chin, throat and a streak behind the eye are pale ochreous, and the lower parts deep buff, each feather bearing a black chevron. According to James Wilson (*Ill. Zoology*, pl. xi.), specimens of both sexes were obtained by Sir T. Brisbane at Port Macquarie, whence, in August 1823, they were sent to the Edinburgh Museum, where they arrived the following year; but the species was first described by W. Swainson in January 1825 (*Zool. Journal*, i. 481) as the type of a new genus *Ptiloris*, more properly written *Ptilorrhis*,³ and it is generally known in ornithology as *P. paradoxus*. It inhabits the northern part of New South Wales and southern part of Queensland as far as Wide Bay, beyond which its place is taken by a kind species, the *P. victoriae* of J. Gould, which was found by John Macgillivray on the shores and islets of Rockingham Bay. Farther to the north, in York Peninsula, occurs what is considered a third species, *P. alberti*,

¹ In the military forces short-range practice now takes two forms—practice with Morris tube or miniature rifle, and practice with the full-sized rifle and ammunition on specially protected 30-yd. ranges.

² Curiously enough, its English name seems to be first mentioned in ornithological literature by Frenchmen—R. P. Lesson and Garnot—in 1828, who say (*Voy. Coquille*, *Zoologie*, p. 659) that it was applied "pour rappeler que ce fut un soldat de la garnison of New South Wales qui le tua le premier"—which seems to be an insufficient reason, though the statement as to how the first specimen was obtained may be true.

³ Some writers have amended Swainson's faulty name in the form *Ptilorrhis*, but that is a mistake.

very closely allied to and by some authorities thought to be identical with the *P. magnifica* (Vieillot) of New Guinea—the “Promerops” of many writers. From that country a fifth species, *P. wilsoni*, has also been described by Mr Ogden (*Proc. Acad. Philadelphia*, 1875, p. 451, pl. 25). Little is known of the habits of any of them, but the rifleman-bird proper is said to get its food by thrusting its somewhat long bill under the loose bark on the boles or boughs of trees, along the latter of which it runs swiftly, or by searching for it on the ground beneath. During the pairing-season the males mount to the higher branches and there display and trim their brilliant plumage in the morning sun, or fly from tree to tree uttering a note which is syllabled “yass” freely prolonged, but at the same time making, apparently with their wings, an extraordinary noise like that caused by the shaking of a piece of stiff silk stuff. Verreaux informed D. G. Elliot that he believed they breed in the holes of trees and lay white eggs; but on that score nothing is really known. The genus *Philorrhis*, thought by Gould to be allied to *Climacteris*, has been generally placed near *Epimachus*, which is now considered, with *Drepanornis* and *Scleroides*, to belong to the Passerine Paridaeidae, or birds-of-paradise, and in his *Monograph* of that family all the species then known are beautifully figured by D. G. Elliot. (A. N.)

RIGA (Esth. *Riia-Lin*), a seaport of Russia, 366 m. by rail S.W. of St Petersburg, the capital of the government of Livonia. The Gulf of Riga, 100 m. long and 60 m. in width, with shallow waters of inconsiderable salinity (greatest depth, 22 fathoms), freezes to some extent every year. The town is situated at the southern extremity of the gulf, 8 m. above the mouth of the Dvina, which brings Riga, by means of inland canals, into water communication with the basins of the Dnieper and the Volga. Below the town the river divides into several branches, among islands and sandbanks, receiving before it enters the sea the Bolderaa river, and expanding towards the east into wider lacustrine basins. Having direct railway communication with the fertile parts of southern and south-eastern Russia, Riga has become the second port for foreign trade on the Baltic, ranking next after St Petersburg. The port freezes on an average 127 days every year. The larger ships cannot reach Riga, and are unloaded at Ust-Dvinsk (formerly Dunamünde). By no means all the trade with the interior is transported by the railways; no inconsiderable portion of the goods is carried by water.

Riga consists of four parts—the old town and the St Petersburg and Moscow suburbs on the right bank of the Dvina, and the Mitau suburb on the left bank, the two sides being connected by a floating bridge, which is removed in winter, and by a viaduct, 820 ft. long. The old town still preserves its Hanseatic features—high storehouses, with spacious granaries and cellars, flanking the narrow, winding streets. The only open spaces are the market-place and two other squares, one of which, facing the citadel, is adorned with a granite column erected (1818) in commemoration of the defeat of Napoleon I. in 1812. The suburbs, with their broad and quiet boulevards on the site of the former fortifications, are steadily growing. The St Petersburg suburb is the seat of the German aristocracy and merchant community.

Few antiquities of the mediæval town remain. The oldest church, the Dom (St Mary's), founded in 1215, was burned in 1547, and the present building dates from the second half of the 16th century, but has been thoroughly restored since 1883. Its organ, dating from 1883, is one of the largest in the world. St Peter's church, with a beautiful tower 412 ft. high, was erected in 1406-9. The castle, built in 1494-1515 by the master of the Knights of the Sword, Walter von Plettenberg—a spacious building often rebuilt—is the seat of the Russian authorities. The “House of the Black Heads,” a corporation or club of foreign merchants, was founded in 1330, and subsequently became the meeting-place of the wealthier youth of the place. Of the recent erections, the polytechnic, the exchange, the monument of the German writer, Johann Gottfried von Herder, who lived at Riga towards the end of the 18th century, the

gymnasiums (schools) of Lomonosov and Alexander I. and the large bonded warehouse are worthy of notice. The esplanade (where a Greek cathedral built in 1877-84 now stands), the Wöhrmann Park and the Imperial Park are much visited. Riga gives name to an archiepiscopal see of the Orthodox Greek Church and to an episcopal see of the Roman Catholic Church, and is the headquarters of the XX. army corps. In the environs, Dubblein and the sea-bathing resorts of Bilderingshof and Majorenhof have numerous visitors in summer.

The population, which was 102,590 in 1867, increased to 168,728 in 1881 and to 282,943 in 1897, so that Riga now ranks seventh in the empire in order of population; 47% of the inhabitants are Germans, 25% Russians and 23% Letts, with a small admixture of Estonians, Jews, &c. The city has a commercial school (1903), a municipal library, the Dom museum, an art museum with picture gallery (1904-5), technical and theological middle schools and a pilot and navigation school. Industrial activity has developed and includes railway-carriage works, works for the manufacture of machinery, oil mills and breweries. Owing to its communication by water and rail with the forests of White Russia and Volhynia, Riga is a great mart for timber. Flax and linseed also occupy a prominent place, Riga being the chief Russian port for the extensive flax-producing region of north-west Russia. Owing to the great railway which crosses the country from Riga to Smolensk, afterwards dividing into two branches, to Orenburg and Tsaritsyn on the lower Volga respectively, Riga is the storehouse and place of export for hemp coming by rail from west central Russia, and for corn, Riga merchants sending their buyers as far east as Tambov. Oats, in particular, are extensively exported to England from the central provinces. Wheat, barley, eggs, butter, oilcake, hides, tallow, leather, tobacco, rugs, feathers and other items add considerably to the total value of the exports, which increased from 1½ million sterling in 1851-60 to 8-14 millions sterling in 1901-5. The imports, consisting chiefly of salt, fish, wine, cotton, metals, machinery, coal, oils, fruits and tobacco, are also rapidly increasing; whereas in 1851-60 they were valued at about 3 million sterling, in 1901-5 they reached 6-11½ millions sterling.

History.—Riga was founded in 1158, as a storehouse at the mouth of the Dvina (Dvina), by a few Bremen merchants. About 1190 the Augustinian monk Meinhard erected a monastery there, and in 1199-1201 Bishop Albert I. of Livonia obtained from Pope Innocent III. permission for German merchants to land at the new settlement, and chose for its seat, exercising his power over the neighbouring district in connexion with the Teutonic Knights. As early as the first half of the 13th century the young city obtained the right of electing its own magistracy, and enlarged the walls erected during Albert I.'s time. It joined the Hanseatic League, and from 1253 refused to recognize the rights of the bishop and the knights. In 1420 it fell once more under the rule of the bishop, who maintained his authority until 1566, when it was abolished in consequence of the Reformation. Sigismund II, king of Poland, took Riga in 1547, and in 1558 the Russians burned its suburbs and many ships in the river. In 1561 Gotthard Kettler publicly abdicated his mastership of the order of the Teutonic Knights, and Riga, together with southern Livonia, became a Polish possession; after some unsuccessful attempts to reintroduce Roman Catholicism, Stephen Bathory, king of Poland, recognized the religious freedom of the Protestant population. Throughout the 17th century Riga was a bone of contention between Sweden, Poland and Russia. In 1621 Gustavus Adolphus, king of Sweden, took it from Poland, and held it against the Poles and the Russians, who besieged it in 1656. During the Northern War between Sweden and Russia, it was courageously defended (1700), but after the battle of Poltava it succumbed, and was taken in July 1710 by the Russians. In 1781 it was made by Russia the capital of the Riga viceroyalty, but fifteen years later, the viceroyalty having been abolished, it was made the capital of Livonia. In 1812, the approach of the French being apprehended, the suburbs were burned. (P. A. K.; J. T. BE.)

RIGAUD, HYACINTHE (1650-1743), French painter, born at Perpignan on the 20th of July 1650, was the descendant of a line of artists. Having early lost his father, he was sent by his mother to Montpellier, where he studied under Pezet and was helped by Ranc, then to Lyons, and in 1681 to Paris. There, whilst following the regular course of academic instruction,

Rigaud produced a great number of portraits so good that Le Brun advised him to give up going to Rome and to devote himself wholly to this class of work. Rigaud, although he had obtained the Grand Prix, followed this advice, and for sixty-two years painted at the rate of thirty to forty portraits a year, all carried through with infinite care by his own hand. His portraits of himself, of the sculptor Desjardins (Louvre), of Mignard and of Le Brun (Louvre) may be cited as triumphs of a still more attractive, if less imposing, character than that displayed in his grand representations of Bossuet (Louvre) and Louis XIV. (Louvre), while his beautiful portraits of his mother, Marie Serre (Louvre), must for ever remain amongst the masterpieces of French art. Rigaud, although the great successes to which he owed his fame were won without exception in portrait-painting, persisted in pressing the Academy to admit him as an historical painter. This delayed his reception, and it was not until January 1700 that he succeeded in obtaining his desire. He presented as his diploma works a St Andrew (Louvre) and the portrait of Desjardins already mentioned, exhibited at the salon of 1704, and filled in turn all the various posts of academical distinction. He died on the 27th of December 1743, having never recovered from the shock of losing his wife in the previous year. He had many pupils, and his numerous works had the good fortune to be reproduced by the greatest of French engravers—Edelinck, Drevet, Willé, Audran and others.

RIGBY, RICHARD (1722-1788), English politician, was the only son of Richard Rigby (d. 1730) of Mistley Hall, Essex, a merchant who made a fortune through his connexion with the South Sea Company. Young Rigby became an associate of Frederick, prince of Wales, and entered parliament in 1745. He is chiefly known to fame through his connexion with John Russell, 4th duke of Bedford, and the "Bloomsbury gang," his audacity earning for him the title of the "brazen boatswain" of the "crew." In 1758 he became secretary to Bedford, who was lord lieutenant of Ireland, and in the following year he was given the sinecure office of master of the rolls for Ireland. Following the political fortunes of the duke he became vice-treasurer of Ireland in 1765, and in 1768 he obtained the lucrative position of paymaster-general of the forces. Rigby often spoke in parliament, and in 1769 he shared in the opposition to Wilkes. In 1784 he was obliged to resign his position as paymaster-general, and he was somewhat surprised and embarrassed when he was requested to pay over the large sum of public money which was in his possession. He left a great fortune when he died at Bath on the 8th of April 1788. A rapacious and unscrupulous politician, Wraxall says Rigby "possessed talents for addressing a popular assembly which were sustained by a confidence that nothing could abash."

RIGG, JAMES HARRISON (1821-1900), English Nonconformist divine, was born at Newcastle-on-Tyne on the 16th of January 1821. His father was a Wesleyan minister and sent his son to the Old Kingswood School, Bristol, where he subsequently became an assistant teacher. In 1845 he entered the Wesleyan ministry, and during the agitation of 1849-52 wrote successfully in exposition and defence of the polity of Methodism. In 1857 he published *Modern Anglican Theology*, an acute criticism of the writings of Coleridge, Hare, Maurice, Kingsley and Jowett. The book was timely and well received, and though Kingsley at first resented the criticism he afterwards became a cordial friend of the writer. Rigg had now become a leading figure in his own church, and in 1868 was appointed Principal of the Westminster Wesleyan Training College for day-school teachers, a post which he held with growing distinction for 35 years. In 1870 he was elected on the first School Board for London, one of the most remarkable assemblies of modern times, and took an important part in providing the syllabus of religious instruction and framing the religious settlement for teachers.

In 1873 he wrote *National Education in its Social Conditions and Aspects*. A resolute opponent of secular education, he maintained that the state ought not to compete with the churches,

but welcome their aid in the work of national education. He was also strongly against the adoption of a rigid universal code. In 1886 he sat on the Royal Commission of Education, and was brought into close contact with Matthew Arnold, and with Dean Stanley, Bishop Temple and other Anglican prelates, who held him in high esteem. In 1877 he became chairman of the second London district of Methodism, and for fourteen years helped to make the history of his church in the home counties. In 1878 he was elected president of conference—and again in 1892. From 1881 he was ministerial treasurer of the Wesleyan Missionary Society, taking an active part in its work. He resigned his principalship in 1903 and died at Brixton on the 17th of April 1900. Dr Rigg was universally honoured as the Nestor of Wesleyan Methodism, in the development of which he had taken a foremost part for over 60 years. His *Connexional Economy* is a standard work, and his *Living Wesley* a most discriminating study of the character and work of its subject. His *Oxford High Anglicanism* (1805) showed how keenly he followed modern developments in the Church of England. His lifelong principle was that Methodism is "a church friendly to all, but owing allegiance to none."

See *Life* by John Telford (London, 1909).

RIGGING (A.S. *wrgan* or *wrihan*, to clothe), the general term, in connexion with ships, for the whole apparatus of spars (including both masts and yards), sails and cordage, by which the force of the wind is utilized to move the hull against the resistance, and with the support, of the water. (See also **SHIP** and **SHIPBUILDING**). The word is often used as meaning the cordage only, but this is a too limited, and even an irrational, use of the term. A ship is not rigged until she is provided with all the spars, sails and cordage required to move and control the hull. The straight or curved pieces of wood or metal, called davits, from which the boats carried along the bulwarks are hung, belong to the rigging. All are fastened directly or indirectly to the hull, and all are required to complete her "clothing." Vessels of all classes, from the smallest sailing-boat up to the largest ship, are classed according to the particular combination of their spars, sails and cordage. "Cutter," "brig," or "ship," are only convenient abbreviations for "cutter-rigged," "brig-rigged," or "ship-rigged." They are of such or such a "rig." It is strictly correct to speak of the rigging of a mast or a yard, or of a boom, when all that is meant is the special set of ropes, of whatever size or material, required to keep them in their place, or withdraw them from it, when they have to be moved in the ship. In such cases the part is looked upon as a whole, and is mentally abstracted from the total of the vessel's rigging.

The basis of all rigging is the mast (*q.v.*), whether it be composed of one or of many pieces of wood or metal. The mast is held up and controlled by ropes, which are classed together as the "standing rigging," because they are "that part (of the whole rigging) which is made fast, and not hauled upon" (Admiral Smyth, *Sailor's Word-Book*). This must be understood subject to the restriction that in the case of a mast composed of several parts, including topmast and topgallant mast, these subdivisions may be, and often are, lowered. The backstays, and other ropes which keep the top and topgallant masts in place, are therefore only "comparative fixtures." The bowsprit, though it does not rise from the deck but projects from the bow, is in fact a mast. The masts, including the bowsprit, support all the sails, whether they hang from the "yards," which are spars slung to the mast, or from "gaffs," which are spars projecting from the mast, or, as in the case of the "jibs," are triangular sails, travelling on ropes called "stays," which go from the foremast to the bowsprit and suspended by halliards. The bowsprit is subdivided like other masts. The bowsprit proper corresponds to the lower fore-main- or mizzen-mast. The jib-boom, which is movable and projects beyond the bowsprit, corresponds to a topmast; the flying jib-boom, which also is movable and projects beyond the jib-boom, answers to a topgallant mast. The whole body of ropes by which the yards, booms and sails are manipulated

constitute the "running rigging," since they are "in constant use, to trim yards, and make or shorten sail" (Admiral Smyth, *op. cit.*). The rigging must also provide the crew with the means of going aloft, and with standing ground to do their work when aloft. Therefore the shrouds (see below) are utilized to form ladders of rope, of which the steps are called ratlines, by which the crew can mount. Near the heads of the lower masts are the tops—platforms on which men can stand—and in the same place on the topmasts are the "cross-trees," of which the main function is to extend the topgallant shrouds. The yards are provided with ropes, extending from the middle to the extremities or arms, called horses, or foot-ropes, which hang about 2 or 3 ft. down, and on which men can stand. The material of which the cordage is made has differed, and still differs greatly. Leather has been used.

must be adapted to resist two kinds of pressure, the longitudinal, whether applied by the wind or by the motion of the vessel when pitching (*i.e.* plunging head and stern alternately into the hollow of the sea), and the lateral, when the wind is blowing on the side and she is rolling. The longitudinal pressure is counteracted by the bobstays, stays and backstays. A reference to fig. 1 will show that the bobstays hold down the bowsprit, which is liable to be lifted by the tug of the jibs, and of the stays connecting it with the fore-topmast. If the bowsprit is lifted the fore-topmast loses part of its support. In the case of a small vessel, the lifting of a bowsprit would wreck her whole system of rigging in an instant. If fig. 1 is followed from the bow to the mizzenmast, it will be seen that a succession of stays connect the masts with the hull of the ship or with one another. All pull together to resist pressure from

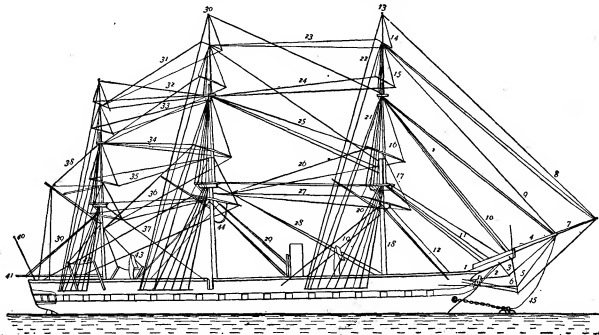

FIG. 1.—The Spars and Rigging of a Frigate. References are not repeated for each mast where the names and functions are identical. 1, bowsprit; 2, bobstays, three pairs; 3, spritsail-gaffs, projecting on each side of the bowsprit—the ropes at the extremities are jib-guys and flying jib-guys; 4, jib-boom; 5, martingale-stay, and below it the flying-jib martingale; 6, back-ropes; 7, flying jib-boom; 8, fore-royal stay, flying jib-stay and halliards; 9, fore-topgallant-stay, jib-stay and halliards; 10, two fore-topmast-stays and fore-topmast staysail halliards; 11, the fore-top-bowlines, stopped into the top and two fore-stays; 12, two fore-tacks; 13, fore-truck; 14, fore-royal mast, yard and lift; 15, topgallant mast, yard and lift; 16, fore-top mast, topsail-yard, lift and reef-tackle; 17, foretop, fore-lift, and topsail-sheet; 18, foremast and fore-shrouds, nine pairs; 19, fore-sheets; 20, fore-gaff; 21, fore-topmast backstays and topsail tye; 22, royal and topgallant backstays; 23, fore-royal-braces and main-royal-stay; 24, fore-topgallant braces and main-topgallant-stay; 25, standing parts or fore-topsail-braces and main-topmast-stays; 26, hauling parts of fore-topsail-braces and main-top-bowlines; 27, fore parts of fore-braces; 28, mainstays; 29, main-tacks; 30, main-truck; 31, main-royal mast, yard and lift; 32, mizzen-royal-stay and mizzen-royal-braces; 33, main-topgallant-braces and mizzen-topgallant-braces; 34, standing parts of main-topsail-braces and mizzen-topmast-stay; 35, mizzen-topsail-braces; 36, hauling parts of main-topsail-braces, mizzen-top-bowlines and cross-jack-braces; 37, main-braces and mizzen-stay; 38, standing part of peak halliards; 39, vangs, similar on each gaff; 40, ensign staff; 41, spanker-boom; 42, quarter-boat's davits; 43, one of the davit topping-lifts and wind-sail; 44, main-yard-tackle; 45, a bull-rope.

During historic times, however, the prevailing materials have been hemp or esparto grass (*Machrocloa*, or *Stipa tenacissima*), and in recent days chain and wire. As the whole of the rigging is divided into standing and running, so a rope forming part of the rigging is divided into the "standing part" and the "fall." The standing part is that which is made fast to the mast, deck or block. The fall is the loose end or part on which the crew haul. The block is the pulley through which the rope runs. "Standing" in sea language means "fixed"—thus the standing part of a hook is that which "is attached to block, chain or anything which is to heave the hook up, with a weight hanging to it; the part opposite the point" (Smyth, *sub voce*). "Tackle" is the combination of ropes and blocks; the combination of cables and anchors constitutes the "ground tackle."

The function of all cordage may be said to be to pull, for the purpose either of keeping the masts in their places, or of moving spars and sails. The standing rigging which supports the masts

in front. Pressure from behind is met by the backstays, which connect the topmasts and topgallant masts with the sides of the vessel. Lateral pressure is met by the shrouds and breast-backstays. A temporary or "preventer" backstay is used when great pressure is to be met. Seamen have at all times had recourse to special devices to meet particular dangers. When Dundonald, then captain of the "Pallas" frigate, was chased by a French squadron in stormy weather, he fortified his masts by ordering "all the hawsers" (large ropes a little less strong than the cables which hold the anchor) "in the ship to be got up to the mast heads, and hove taut," *i.e.* made fast to the side. Thus she was able to carry more sail than would have been possible with her normal rigging. The running rigging by which all spars and sails are hoisted, or lowered and spread or taken in, may be divided into those which lift and lower—the tacks, jeers, halliards (haulyards)—and those which hold down the lower corners of the sails—the tacks and sheets. A

long technical treatise would be required to name the many combinations of cordage and spars which make up the total rigging. All that is attempted here is to give the main lines and general principles or divisions.

The vessel dealt with here is the fully rigged ship of three or more masts. But she includes all the others and the principles are the same. The simplest of all forms of rigging is the dipping lug, a quadrangular sail hanging from a yard, and always hoisted on the side of the mast opposite to that on which the wind is blowing (the lee side). When the boat is to be tacked so as to bring the wind on the other side, the sail is lowered and rehoisted. One rope can serve as haliard to hoist the sail and as a stay when it is made fast on the weather side on which the wind is blowing. The difference between such a craft and the fully rigged ship is that between a simple organism and a very complex one; but it is one of degree, not of kind. The steps in the scale are innumerable. Every sea has its own type. Some in eastern waters are of extreme antiquity, and even in Europe vessels are still to be met with which differ very little if at all from the ships of the Norsemen of the 9th and 10th centuries. For a full account of these varieties of rigging the reader may be referred to *Mast and Sail in Europe and Asia* (London, 1906), by H. Warington Smyth.

When the finer degrees of variation are neglected the types of rigging may be reduced to comparatively few, which can be classed by the shape of their sail and the number of their masts. At the bottom of the scale is such a craft as the Norse herring boat (fig. 2).

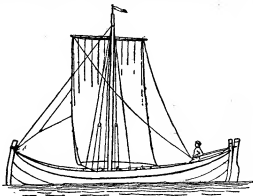

FIG. 2.—Norse Herring Boat.

She has one quadrangular sail suspended from a yard which is hung (or slung) by the middle to a single mast which is placed (or stepped) in the middle of the boat. She is the direct representative of the ships of the Norsemen. Her one sail is a "course" such as is still used on the fore and mainmasts of a fully developed ship; a topsail may be added (as in fig. 3) and then we have the beginning

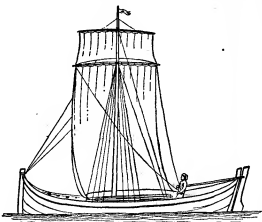

FIG. 3.—Nordland Boat.

of a fully clothed mast. A very similar craft called a Humber keel is used in the north of England. The lug sail is an advance on the course, since it is better adapted for sailing on the wind, with

the wind on the side. When the lug is not meant to be lowered, and rehoisted on the lee side, as in the dipping lug mentioned above, it is slung at a third from the end of the yard, and is called a standing lug. A good example of the lug is the Chinese junk (fig. 4). The

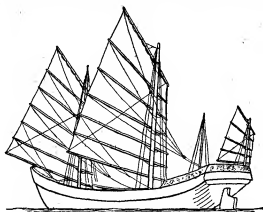

FIG. 4.—Four-masted Junk.

lug is a "lifting sail," and does not tend to press the vessel down as the fore and aft sail does. Therefore it is much used by fishing vessels in the North Sea. The type of the fore and aft rig is the schooner (fig. 5). The sails on the masts have a gaff above and a boom below. These spars have a prong called

"the jaws," which fit to the mast, and are held in place by a "jaw rope" on which are threaded beads called trucks. Sails of this shape are carried by fully rigged ships on the mizzenmast, and can be spread on the fore and main.

They are then called try-sails and are used only in bad weather when little sail can be carried, and are hoisted on the trysail mast, a small mast attached to the great one. The Lateen (Latin) sail (fig. 6) is a triangular sail akin to the lug, and is the prevailing type of the Mediterranean. These original types,

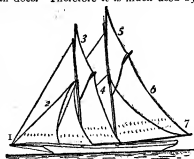

FIG. 5.—Schooner. 1, bowsprit, with martingale to the stem; 2, fore-topmast-stay, jib and stay-foresail; 3, fore-gaff-topsail; 4, foresail and mainstays; 5, main-gaff-topsail; 6, mainsail; 7, end of boom.

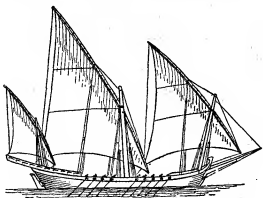

FIG. 6.—Lateen Rig.

even when unmodified by mixture with any other, permit of large variations. The number of masts of a lugger may vary from one to five, and of a schooner from two to five or even seven. A small lug may be carried above the large one, and a gaff topsail added to the sails of a schooner. A small-masted fore-and-aft-rigged vessel may be a cutter (fig. 7) or sloop. But the pure types may be combined, in topsail schooner, brigantines, barquentines and barques, when the topsail, a quadrangular sail hanging from and fastened to a yard, slung by the middle, is combined with fore and aft sails. The lateen rig has been combined with the square rig to make such a rigging as the xebec—a three-masted vessel square rigged on the main, and lateen on the fore and mizzen. Triangular sails of the

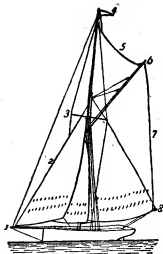
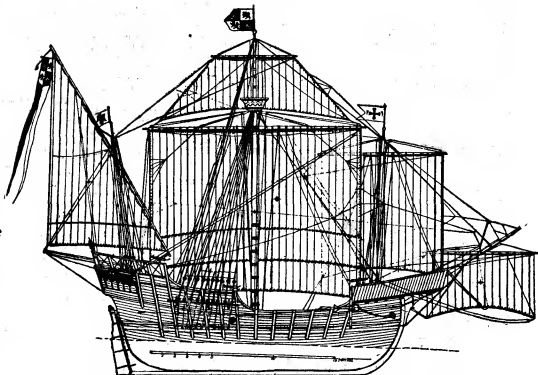

FIG. 7.—Cutter Yacht. 1, bowsprit and martingale; 2, jib—behind it is the foresail; 3, cross-trees and topmast-shroud; 4, pennant, designating the club to which she belongs; 5, gaff-top-sail; 6, peak of gaff, hoisted by peak and throat halyards; 7, mainsail; 8, end of boom and topping-lift.



From Sir George V. C. Holmes's *Ancient and Modern Ships*, Part I., by permission of the Controller of H.M. Stationery Office.
FIG. 8.—Sail Plan of the "Santa Maria."

same type as the jibs can be set on the stays between the masts of a fully rigged ship, and are then known as staysails. But it can only be repeated that the variations are innumerable. Studding-sails are pieces added to increase the breadth (spread) of sails, and require the support of special yards, booms and tackle.

The development of the rigging of ships is a very obscure subject. It was the work of centuries, and of practical men who wrote no treatises. It has never been universal. A comparison of the four-masted junk given above with the figures of ships on medieval seals shows at least much similarity. Yet by selecting a few leading types of successive periods it is possible to follow the growth of the fully rigged ship, at least in its main lines, in modern times.

Fig. 8 gives the sail plan of the "Santa Maria," the flagship of Columbus. It is a modern reconstruction, made in 1893 in Spain at the Carraca arsenal, but is based on good authority. She has only the fixed bowsprit, with a yard and a sail hanging from it, the spritsail yard and spritsail. The foremast has one course, the mainmast a course and topsail, the mizzen a lateen sail. Fig. 9 is the "Sovereign of the Seas"

"Sovereign of the Seas," a British warship of 1637. She still has only the fixed bowsprit, but a small upright mast has been erected at the end, which serves to spread a sprit topsail. In some cases at least a sprit topgallant sail was used. The mizzenmast still carries a lateen sail, but topsails have been added, and the whole rigging has multiplied and developed. Between the "Sovereign of the Seas" and the fully developed ship given in fig. 1 the most apparent differences are in the rigging of the bowsprit and the mizzenmast. The sprit topmast has disappeared, and is replaced

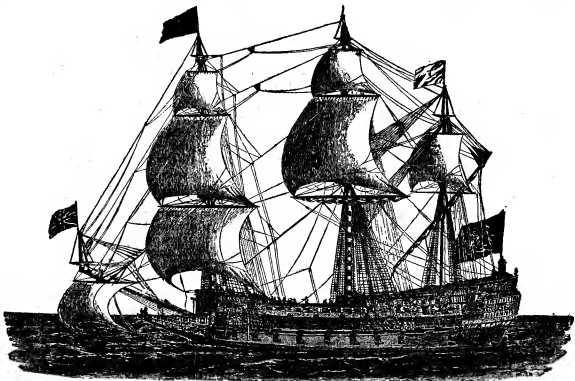

From Sir George V. C. Holmes's *Ancient and Modern Ships*, Part I., by permission of the Controller of H.M. Stationery Office.
FIG. 9.—The "Sovereign of the Seas."

by the jib-boom. The square spritsail, which could not be trained fore and aft, and was of feeble effect in keeping the ship's head from turning to windward, has been replaced by the jib. The spritsail yard (which continued in use till after 1850) has disappeared and has been replaced by the spritsail gaffs, two fixed spars which slope downwards and help to support the "jib-guys," the lateral supports of the booms. For a time, and after the use of spritsails had been given up, the spritsail yard continued to be used to discharge the function now given to the gaffs (see Smyth, *Sailor's Word-Book, Sub voce*). The changes in the mizzen have an obscure history. About the middle of the 18th century it ceased to be a pure lateen. The yard was retained, but no sail was set on the forearm. Then the yard was given up and replaced by a gaff and a boom. The new sail was called the spanker. It was, however, comparatively narrow, and when a greater spread of sail was required, a studding-sail (at first called a "driver") was added. At a later date the "spanker" and "driver" were used as synonymous terms, and the studding-sail was called a "ringail." The studding-sails are the representatives of a class of sail once more generally used. In modern times a sail is cut of the extreme size which is capable of being carried in fine weather, and when the wind increases in strength it is reefed—i.e. part is gathered up and fastened by reef points, small cords attached to the sail. Till the 17th century at least the method was often to cut the courses small, so that they could be carried in rough weather. When a greater spread of sail was required, a piece called a bonnet was added to the foot of the sail, and a further piece called a drabber could be added to that. It is an example of the tenacious conservatism of the sea that this practice is still retained by the Swedish small craft called "lodjor" in the Baltic and White Sea. It will be easily understood that no innovation was universally accepted at once. Jib and sprit topsail, lateen, mizzen and spanker, and so forth, would be found for long on the sea together.

The history of the development of rigging is one of adjustment. The size of the masts had to be adapted to the ship, and it was necessary to find the due proportion between yards and masts. As the size of the mediæval ship increased, the natural course was to increase the height of the mast and of the sail it carried. Even when the mast was subdivided into lower, top and topgallant, the lower mast was too long, and the strain of the sail racked the hull. Hence the constant tendency of the ships to leak. Sir Henry Manwaring, when giving the proper proportions of the masts, says that the Flemings (i.e. the Dutch) made them taller ("taller" and "taunt" were for long used to mean the same thing) than the English, which again forced them to make the sails less wide. A tall sail could not be cut so wide as a lower one without putting an excessive strain on the mast. He says that the Flemings found an advantage in working to windward, but that they "wronged" (i.e. racked) their ships. The English preferred a less lofty mast and a wider spread of sail.

It is very difficult to say what changes in the proportions of masts and yards took place in English ships between the early 17th and the 19th centuries. The difficulty arises largely not only from insufficient knowledge of the earlier period, but from the fact that a scale was fixed only after trials, and by degrees. Manwaring, for instance, when giving the proportion of the topmasts to lower masts, says: "The topmasts are ever half so long as the masts into which they belong; but there is no absolute proportion in these, and the like things, for if a man will have his mast short, he may the bolder make his topmast long." In some respects the change was certainly slight. In the early 17th century, in England at least, the length of the mainmast was fixed by taking four-fifths of the breadth of the ship and multiplying by three. Two centuries later the method was to take the length of the lower deck and the extreme breadth, add them together, and divide by two. If we take a 74-gun ship of about the year 1820, which was 176 ft. long on the lower deck and 48 ft. 8 in. wide, she would have, by the system then used, a mainmast of 112 ft. Manwaring's system would have given her one of 117 ft. But in the proportions of the masts to one another there was a change. In the 17th century the foremast was four-fifths of the main, and the bowsprit was of the same length as the foremast. In the 19th the foremast was eight-ninths of the mainmast, while the bowsprit was seven-eleventh of the mainmast in the largest ships, and three-fifths in the others. When we come to the relative proportions of masts and yards the difficulty increases, for the standard was not the same. The seamen of the 17th century calculated the length of the mainyard not by the size of the mast but by the length of the keel. The mainyard, which was the standard for the others, ought according to "the best and most absolute" estimate to be five-sixths of the length of the keel. But Manwaring again explains that "the proportion is not absolute." If it was followed, the yards of a 17th-century ship must have been rather longer than in a vessel of a hundred

and fifty and two hundred years later, when the mainyard was eight-ninths of the mainmast, and a regular scale was fixed throughout. Even so Manwaring's warning that "the proportion was not absolute" must be borne in mind. Changes were constant. The development of the famous American clippers made a considerable one. So has the growth of the vast four- and five-masted iron sailing ships of recent days. Individual captains have fitted ships according to ideas of their own. It has always happened that extra sails have been invented and set by ingenious devices for particular purposes. One large sail requires more men to handle it than several small ones. For this reason it is that in recent times the topsails of merchant ships have been divided into upper and lower, with a great loss of beauty, but an increase of convenience. To the same cause, the wish to economize in the size of the crew, is to be attributed the introduction of machinery for reefing sail from the deck, which is also an easier and a safer process than going aloft to reef them by hand. In a general way it may be said that the development of the rigging has been towards establishing a fair balance between the fore and after spread of canvas. Until the jib was invented in the 18th century, a ship which was sailing on the wind was subject to a disproportionate pressure aft. If she was at all given to "gripping"—that is to say, inclined to turn head to wind (and all ships are liable to have ways and manners which are mysterious in origin and not seldom incurable), the mizzen-sail could not be used, for if it had been she would never have been "out of the wind." Therefore when close-hauled (sailing with the wind on the side and somewhat from before her centre) she lost the use of part of her sail. The spritsail which could not be trained fore and aft was no use "on the wind."

A few words may be added concerning the tops. In the earlier form of ships the top was a species of crow's nest placed at the head of the mast to hold a look-out, or in military operations to give a place of advantage to archers and slingers. They appear occasionally as mere bags attached to one side of the mast. As a general rule they are round. In the 16th century there were frequently two tops on the fore- and mainmasts, one at the head of the lower, another at the head of the topmast, where in later times there have only been the two traverse beams which make the cross-trees. The upper top dropped out by the 17th century. The form was round, and so continued to be till the 18th century when the quadrangular form was introduced. In quite recent times the military tops of warships have resumed the circular form.

AUTHORITIES—The present writer is indebted to Admiral Sir Cyriac A. G. Bridge, G.C.B., whose practical acquaintance with the older type of sailing ship as well as with the modern steamship makes his authority specially valuable, for the correction or confirmation of the technical details in the above article. Among the literature of the subject, reference may be made to the following works: Sir Henry Manwaring, *The Seaman's Dictionary* (London, 1644); Darcy Lever, *The Young Sea Officer's Sheet Anchor* (London, 1808); Sir George Nares, *Seamanship* (Portsmouth, 1882); Vice-Admiral Edmond Paris, *La Musée de marine du Lowree* (Paris, 1883). (D. H.)

RIGHT ASCENSION, in astronomy, that co-ordinate of a heavenly body defined by the angle which the meridian passing through it makes with the prime meridian through the vertical equinox (see ASTRONOMY).

RIGHTS OF MAN AND OF THE CITIZEN, DECLARATION OF, a sort of manifesto issued in 1789 by the Constituent Assembly in the French Revolution, to be inscribed at the head of the constitution when it should be completed. It stated the fundamental principles which inspired the revolution. Historians have traced a connexion with the declarations of rights which preceded the constitution of some of the states of the American Union, especially of Virginia, but the situation in France at the time, and the influence of the writings of the *philosophes* made the proposal for such a statement very natural. The declaration overturned the political and social principles upon which the existent régime stood. It has served as a base for modern civil legislation and is still a force in European history. The final text voted by the Assembly was accepted by the king on the 5th of October 1789, at first conditionally, then with modifications. It contains a preamble and 17 articles. They proclaim and define political equality and liberty in its various manifestations, determine the character of the law and the conditions of its application, and state at the same time the restrictions upon the individual will which are necessary

for the benefit of society. Similar declarations were attached to the constitution of 1793 and to that of the year III.

See E. Blum, *La Déclaration des droits de l'homme et du citoyen*, text with commentary (Paris, 1902); L. Bourgeois and A. Metin, *Déclaration des droits de l'homme et du citoyen, 1789* (Paris, 1901); G. Jellinek, *Die Erklärung der Menschen und Bürgerrechte* (Leipzig, 1895). This study has been translated into English by Rudolf Tombo (New York), and has aroused considerable controversy; see E. Boutmy, "La Déclaration des droits de l'homme et du citoyen et M. Jellinek," in *Annales des sciences politiques* for the 15th of July 1902; also E. Walsh, *La Déclaration des droits de l'homme et du citoyen et l'Assemblée constituante, Travaux préparatoires* (Paris, 1903).

RIGORD (c. 1150-c. 1209), French chronicler, was probably born near Alais in Languedoc, and became a physician. Afterwards becoming a monk he entered the monastery of Argenteuil, and then that of St Denis, and described himself as *regis Francorum chronographus*. Rigor wrote the *Gesta Philippici Augusti*, dealing with the life of the French king, Philip Augustus, from his coronation in 1179 until 1206. The work, which is very valuable, was abridged and continued by William the Breton (q.v.). The earlier part of the *Gesta* speaks of the king in very laudatory terms, but in the latter part it is much less flattering in its tone. It is published in tome xvii. of Dom Bouquet's *Recueil des historiens des Gaules et de la France* (Paris, 1738-1876); and with introduction by H. F. Delaborde (Paris, 1882-85). A French translation of the *Gesta* is in tome xi. of Guizot's *Collection des mémoires relatifs à l'histoire de France* (Paris, 1825). Rigord also wrote a short chronicle of the kings of France.

See A. Potthast, *Bibliotheca historica* (Berlin, 1896); and A. Molinier, *Les Sources de l'histoire de France*, tome iii. (Paris, 1903).

RIGORISM (Lat. *rigor*, stiffness, firmness), a philosophical term applied by Kant specially to those moralists who take up an anti-hedonist or ascetic standpoint. In general the term is opposed to "latitudinarianism" or "indifferentism,"—respectively a morality of compromise and a morality of pure indifference,—and signifies insistence upon the strictest interpretation of a principle, rule or criterion. Thus, in Roman Catholic theology, a rigorist holds that in cases of conscience the proper course is to adhere to the strict wording of the law in question.

RILEY, JAMES WHITCOMB (1853—), American poet, was born in Greenfield, Indiana, in 1853. He spent several years as an itinerant sign-painter, actor and musician. During this vagabond experience he had opportunities to revise plays and compose songs, and was brought into close touch with the rural folk of Indiana, becoming familiar with their life and speech. About 1873 he first contributed verses, especially in the Hoosier dialect, to the papers, and he soon became local editor of the Anderson (Ind.) *Democrat*. In August 1877, over the initials "E.A.P.," he printed in the Kokomo (Indiana) *Dispatch* a poem, *Leonaine*, in the manner of Poe.¹ The press throughout the country copied the poem, and many critics of acknowledged authority believed it to have been actually written by Poe, until the hoax was explained by the paper in which it first appeared. To the Indianapolis *Daily Journal* Riley contributed many poems, the best known being a series in dialect which purported to have been written by one "Benjamin F. Johnson, of Boone," a farmer. These he published in book form, under the same pen-name, as *The Old Swimmer's Hole and Seven More Poems* (1883). He wrote short stories and sketches, some of unusual merit, but is known almost exclusively as a poet. Of his poems some are in conventional English, many others in the Hoosier dialect of the Middle-West. His materials are the homely incidents and aspects of village and country life,

¹ The poem was accompanied by a statement from the editor of the paper that it was "from the gifted pen of the erratic poet, Edgar Allan Poe," and by a circumstantial story to the effect that the poem had been found written on the fly-leaf of an old Latin-English dictionary then owned by "an uneducated and illiterate man" in Kokomo, who had received it from his grandfather, in whose tavern, near Richmond, Va., it had been left by "a young man who showed plainly the marks of dissipation."

especially of Indiana, and his manner is marked by delicate imagination and naïve humour and tenderness.

The bulk of his work appeared in *The Boss Girl and Other Sketches* (1886), republished in 1891 as *Sketches in Prose; Afterpieces* (1887); *Pipes of Pan at Zebachury* (1888); *Rhymes of Childhood* (1890); *Neighboring Poems* (1891); *The Flying Islands of the Night* (1891), a fantastic blank verse drama; *Green Fields and Running Brooks* (1892); *Poems Here at Home* (1893); *Armasindy* (1894), which contains the poem "Leonaine"; *A Child-World* (1896), reminiscent of his own boyhood; *The Rubáiyát of Doc Sifers* (1897); *Home Folks* (1900); *The Book of Joyous Children* (1902); *His Pa's Romance* (1903); *A Defective Santa Claus* (1904); and in several books of selections, such as *Old Fashioned Roses* (1889), published in England; *Child Rhymes* (1898); *Love Lyrics* (1899); *The Golden Year* (1899), published in England; *Farm Rhymes* (1901); *An Old Sweetheart of Mine* (1902); *Out to Old Aunt Mary's* (1904); *Songs of Cheer* (1905); *Morning* (1907); and *Songs of Summer* (1908).

RIMBAUD, JEAN ARTHUR (1854-1891), French poet and adventurer, was born at Charleville, in the Ardennes, on the 20th of October 1854. He was the second son of a captain in the French army, who in 1860 abandoned his wife and family. From early childhood Arthur Rimbaud, who was severely brought up by his mother, displayed rich intellectual gifts and a sullen, violent temperament. He began to write when he was ten, and some of the poems which now appear in his works belong to his fifteenth year. Before he was sixteen, in consequence of a violent quarrel with his mother, the boy escaped from Charleville with a packet of his verse, was arrested as a vagabond, and for a fortnight was locked up in the Mazas prison, Paris. A few days after being taken home Rimbaud escaped again, into Belgium, where he lived for some time as a tramp, almost starved, but writing verses with feverish assiduity. In February 1871 he left his mother for a third time, and made his way to Paris, where he knew no one, and whence, after very nearly dying of hunger and exposure, he begged his way back to Charleville. There he wrote in the same year the extraordinary poem of *Le Bateau ivre*, which is now hailed as the pioneer of the entire "symbolist" or "decadent" movement in French literature in all its forms. He sent it to Verlaine, who encouraged the boy of seventeen (whom he supposed to be a man of thirty) to come again to Paris. Rimbaud spent from October 1871 to July 1872 in the capital, partly with Verlaine, partly as the guest of Théodore de Banville, and served in the army of the Commune. With Verlaine he travelled for thirteen months, after the fall of the Commune, through England and Belgium, where in 1873 he published the only work which he ever printed, *Une Saison en Enfer*, in prose; in this he gives an allegorical account of his extravagant relations with Verlaine, which ended at Brussels by a double attempt of the latter to murder his young companion. On the second occasion Rimbaud was dangerously wounded by Verlaine's revolver, and the elder poet was imprisoned at Mons for two years. Meanwhile Rimbaud, deeply disillusioned, determined to abandon Europe and literature, and he ceased at the age of nineteen to write poetry. He settled for a while at Stuttgart, studying German, and in 1875 he disappeared. He set out on foot for Italy, and after extraordinary adventures found employment as a day-labourer in the docks at Leghorn. Returning to Paris, he obtained a little money from his mother, and then definitely vanished. For sixteen years nothing whatever was heard of him, but it is now known that he embarked as a Dutch soldier for the Sunda Isles, and, presently deserting, fled to Sumatra and then to Java, where he lived for some time in the forest. Returning to Europe, after a vagabond life in every capital, he obtained in 1880 some menial employment in the quarries of Cyprus, and then worked his way to Aden and up into Abyssinia, where he was one of the pioneers of European commercial adventure. Here he settled, at Harrar, as a trader in coffee and perfumes, to which he afterwards added gold and ivory; for the next eleven years, during which he led many commercial expeditions into unknown parts of northern Africa, Shoa and Harrar were his headquarters, and he lived almost entirely with the natives, and as one of themselves. From 1888 to 1891, having prospered greatly as a merchant, he became a sort of semi-independent chieftain, intriguing for France, just

outside the borders of civilization. From documents which were first produced in 1902 it appears that from 1883 to 1889 Rimbaud was in close relations with the Ras Makonnen and with Menelek, then only king of Shoa. At the death of the Negus John, in 1888, he was concerned in the formation of the empire of Ethiopia. From this time Rimbaud had a palace in the town of Harrar, and intrigued with the French government in favour of Menelek and against Italy. Meanwhile, in 1886, believing Rimbaud to be dead, Verlaine had published his poems, under the title of *Les Illuminations*, and they had created a great sensation in Paris. In this collection appeared the sonnet on the vowels, attributing a different colour to each: "A noir, E blanc, I rouge, U vert, O bleu voyelles." But the author, in his Abyssinian hut of palm-leaves, was, and remained, quite unconscious of the fact. In March 1891 a tumour in his knee obliged Rimbaud to leave Harrar and go to Europe for surgical advice. He reached Marseilles, but the case was hopeless; the leg had to be amputated, and Rimbaud died there in hospital on the 10th of November 1891. The poems of Rimbaud all belong to his earliest youth. Their violent originality, the influence which they have exercised upon younger writers, the tumultuous existence of their author, and the strange veil of mystery which still hangs over his character and adventures, have given to Rimbaud a remarkable fascination. His life has been written by M. Paterné Berrichon (1897), and valuable reminiscences by his sister, Mlle Isabella Rimbaud. His *Œuvres* were collected in 1898 by MM. Berrichon and Delahaye, and in 1901 his statue was unveiled at Charleville.

(E. G.)

See also *Lettres de Jean Arthur Rimbaud (Égypte, Arabie, Éthiopie)*, 1899, edited by P. Berrichon; Paul Verlaine, *Les Poètes maudits* (1884); George Moore, *Impressions and Opinions: The Two Unknown Poets* (1891); and A. Symons, *The Symbolist Movement in Literature* (1905).

RIME ROYAL, the name given to a strophe or stanza-form, which is of Italian extraction, but is almost exclusively identified with English poetry from the fourteenth to the early seventeenth centuries. It appears to be formed out of the stanza called *Ottava rima* (*q.e.*), by the omission of the fifth line, which reduces it to seven lines of three rhymes, arranged ababcc. It was earliest employed with skill, if not, as seems probable, invented, by Chaucer, who composed his long romantic poem of *Troilus and Cressida* in rime royal, of which the following is an example:—

"And as the new-abashed nightingale,
The sixteenth first when she begetteth sing,
When that she heareth any herd's tale,
Or in the hedges any wight stirring,
And, after, siker doth her voice out-ting,—
Right so Cresseyda, when her drede stint,
Opened her heart, and told all her intent."

The "Prioresse's Tale," in the *Canterbury Tales*, offers another particularly beautiful proof of Chaucer's skill in the use of the rime royal. In the fifteenth century this stanza was habitually used, in preference to heroic verse, by Hoccleve and Lydgate, and, with more melody and grace, by the unknown writer of *The Flower and the Leaf*. In the sixteenth century, rime royal was chosen by Hawes as the vehicle of his *Pastime of Pleasure* (1506) and by Barclay in his *Ship of Fools* (1509); it was now regarded as the almost exclusive classical form for heroic poetry in England, and it had long been so accepted in Scotland, where *The King's Quair* of King James I., the *Fables* of Henryson and *The Thistle and the Rose* of Dunbar had closely followed Chaucer's pattern. The greater part of that huge poetic miscellany, *The Mirror for Magistrates* (1559-1610), was written in rime royal, Sackville's momentous *Induction* among the rest. The seven-line stanza began to go out of fashion with the revival of Elizabethan poetry, but we find it still used in Spenser's *Hymn of Heavenly Beauty*, Shakespeare's *Lucrece* and the *Orchestra* of Sir John Davys. After the first decade of the seventeenth century rime royal went out of fashion. Since then it has been occasionally revived, but not in poems of great length or particular importance. Rime royal should always be written in iambic metre, and be formed of seven lines of equal length, each containing ten syllables.

RIMINI, a town and bishop's see of Italy, in the province of Forlì, Emilia, on the Adriatic coast, 69 m. S.E. of Bologna by rail. Pop. (1901) town, 18,022; commune, 46,801. The city is bounded on three sides by water. It faces the Adriatic to the north, has the torrent Aprusa, now called Ausa, on the east, and the river Marecchia on the west. It stands in a fertile plain, which on the southern side soon swells into pleasant slopes backed by the jagged peaks of the Umbrian Apennines. The foremost foothill of the range is the steep crag of Mons Titanus, crowned by the towers of the republic of San Marino. Rimini attracts numerous visitors for the sea-bathing at Porta Marina. It has mineral springs, and the industries comprise fisheries, ironworks and foundries, sulphur furnaces, silk-mills, rope walks, match factories, brickworks, flourmills and furniture. Its main interest, however, is historical. Apart from the ancient buildings, &c., referred to below, Rimini can boast of a good public library, founded by the jurist Gambalunza in 1677, a municipal picture gallery, an archaeological museum, a technical school (1882) and a bronze statue of Pope Paul V. The ancient castle of Sigismondo Malatesta, now dilapidated, has in recent years been used as a prison.

History.—Rimini is the ancient Ariminum (*q.v.* for its early history and remains). During the middle ages the history of Rimini has no importance. Alternately captured by Byzantines and Goths, it was rigorously besieged by the latter in A.D. 538. They were, however, compelled to retreat before the reinforcements sent by Belisarius and Narses; thus the Byzantines, after various vicissitudes, became masters of the town, appointed a duke as its governor, and included it in the exarchate of Ravenna. It afterwards fell into the power of the Longobards, and then of the Franks, who yielded it to the pope, for whom it was governed by counts to the end of the 10th century. Soon after this period the imperial power became dominant in Rimini. In 1157 Frederick I. gave it, by imperial patent, the privilege of coining money and the right of self-government; and in the 13th century we find Rimini an independent commune waging war on the neighbouring cities.

In the year 1216, Rimini, being worsted by Cesena, adopted the desperate plan of granting citizenship to two members of the powerful Malatesta tribe, Giovanni and Malatesta, for the sake of their aid and that of their vassals in the defence of the state and the conduct of the war. This family quickly struck root in the town and gave birth to future tyrants; for in 1237 Giovanni was named podestà, and this office was the first step towards the sovereign power afterwards assumed by his descendants. Meanwhile, Rimini was torn by the feuds of Guelf and Ghibelline. The latter were the dominant party in the days of Frederick II., although very unpopular on account of the grievous taxes imposed by the empire. Accordingly, the majority of the urban nobles joined the Guelfs and were driven into exile. But before long, as the Swabian power declined in Italy, the Guelf party was again predominant.

Then followed a long period of confusion, in which, by means of conspiracies and crimes of every kind, the Malatesta succeeded in becoming masters and tyrants of Rimini. Giovanni Malatesta had died in 1247 and been succeeded by his son Malatesta, born in 1212, and surnamed Malatesta da Verucchio. This chieftain, who lived to be a hundred years old, had ample time to mature his ambitious designs, and was the real founder of his house. Seizing the first suitable moment, he placed himself at the head of the exiled Guelfs, and restored them to Rimini. Then, as the empire acquired fresh strength in Italy, he quietly bided his time and, on the descent of the Angevins, again assumed the leadership of the Guelfs who now had the upper hand for a long time. Being repeatedly elected podestà for lengthy terms of office, he at last became the virtual master of Rimini. Nor was he checked by Rome. Pope Boniface VIII. was fully aware of the rights and traditional pretensions of the Holy See, but preferred to keep on good terms with one who had so largely contributed to the triumph of the Guelfs in Romagna. Accordingly he not only left Malatesta unmolested, but in 1299 conferred on him fresh honours and estates, so that

his power went on increasing to the day of his death in 1312.

Four sons had been born to Malatesta—Malatestino, Giovanni the Lame, Paolo the Handsome, and Pandolfo; but only the oldest and youngest survived him. Giovanni the Lame (*Sciancato*), a man of a daring impetuosity only equalled by his ugliness, had proved so useful a general to Giovanni da Polenta of Ravenna as to win in reward the hand of that potentate's beautiful daughter, known to history as Francesca da Rimini. But her heart had been won by the handsome Paolo, her brother-in-law; and the two lovers, being surprised by Giovanni, were murdered by him on the spot (1285). This episode of the story of the Malatesta has been immortalized in Dante's *Inferno*. Giovanni died in 1304. Thus in 1312 Malatestino became lord of Rimini, and on his decease in 1317 bequeathed the power to his brother Pandolfo.

Pandolfo died in 1326, leaving two heirs, Malatesta and Galeotto. The former was nicknamed *Guastafamiglia*, because, although at first willing to let his brother share his power, he rid himself by violence and treachery of other kinsmen who claimed their just rights to a portion of the state. His intent was to become sole lord and to aggrandize his tiny principality. But the reigning pope, Innocent VI., despatched the terrible Cardinal Albornoz to Romagna, and it was speedily reduced by fire and sword. In 1355 the Malatesta shared the fate of the other potentates of the land. Nevertheless, it was the cardinal's policy to let existing governments stand, provided they promised to act in subordination to the papal see. Thus he granted the Malatesta brothers the investiture of Rimini, Pesaro, Fano and Fossombrone, and they arranged a division of the state. *Guastafamiglia* took Pesaro, which was held by his descendants down to the brothers Carlo and Galeazzo. The former of these, who died in 1439, was father to the Parisina beheaded in Ferrara, whose tragic love story has been sung by Byron. The latter won the title of "l'Inetto" (the Incapable) by the foolish sale of his rights over Pesaro to the Sforza in 1447.

Galeotto, on the other hand, retained the lordship of Rimini, ruling tranquilly and on good terms with the popes, who allowed him to add Cervia, Cesena and Bertinoro to his states. Dying in 1385 at the age of eighty, he left two sons—Carlo, who became lord of Rimini, and Pandolfo, who had Fano for his share. Carlo (1364-1420) was energetic, valiant and a friend of the popes, who named him vicar of the church in Romagna. He was a patron of letters and the arts, and during his reign his court began to be renowned for its splendour. As he left no issue, his inheritance was added to that of his brother Pandolfo, and Fano was once more united to Rimini. Pandolfo (1370-1427) had led the life of a condottiere, taking a prominent part in the Lombard wars following on the death of Galeazzo Maria Visconti, and held rule for some time in Brescia and Bergamo. He left three natural sons who were declared legitimate by Pope Martin V. The eldest, Galeotto (1411-1432), was an ascetic, gave little or no attention to public business, and, dying early, bequeathed the state to his brother Sigismondo Pandolfo. The third son, Novello Malatesta (1418-1465) ruled over Cesena.

Sigismondo (1417-1468) is the personage to whom Rimini owes its renown during the Renaissance, of which indeed he was one of the strangest and most original representatives. He was born in Brescia, and when called to the succession, at the age of fifteen, had already given proofs of valour in the field. His knowledge of antiquity was so profound as to excite the admiration of all the learned men with whom he discoursed, even when, as in the case of Pius II., they chanced to be his personal enemies. To him is due the erection of the church of St Francis, or temple of the Malatesta, one of the rarest gems of the Renaissance and the greatest of Rimini's treasures (see below for description).

Of so dissolute a life that, although married, he had children by several mistresses at the same time, he gave vent to all his passions with a ferocity that was bestial rather than human.

And—as the crowning contradiction of his strange nature—from his youth to the day of his death he remained the devoted lover of the woman for whose sake he became a poet, whom he finally made his wife, and whom he exalted in every way, even to the point of rendering her almost divine honours. Yet this love never availed to check his excesses. On assuming power in 1432, Sigismondo was already affianced to the daughter of Count Carmagnola; but when that famous leader was arraigned as a traitor by the Venetians, and ignominiously put to death, he promptly withdrew from his engagement, under the pretext that it was impossible to marry the child of a criminal. In fact, he aimed at a higher alliance, for he espoused Ginevra d'Este, daughter of the duke of Ferrara, and his entry into Rimini with his bride in 1434 was celebrated by splendid festivities. In 1437 a son was born to him, but died within the year, and in 1440 the young mother followed it to the grave. Every one declared that she died by poison administered by her husband. This, however, was never proved. The duke of Ferrara remained his friend, nor is it known what motive Sigismondo could have for wishing to get rid of his wife. Two years afterwards he married Polissena, daughter of the famous condottiere Francesco Sforza, who in 1443 bore him a son named Galeotto Roberto. But by this time he was already madly in love with Isotta degli Atti, and this was the passion that endured to his death. The lady succeeded in gaining an absolute ascendancy over him, which increased with time. She bore him several children, but this did not prevent his having others by different concubines. Such being the nature of the man, it is not astonishing that, as his ardour for Isotta increased, he should have little scruple in ridding himself of his second wife. On the 1st June 1450 Polissena died by strangling, and on the 30th of the same month Isotta's offspring were legitimated by Nicholas V.

It is only just to record that, although Malatesta's intrigue with Isotta had long been notorious to all, and he had never sought to conceal it, no one ever accused her of either direct or indirect complicity in her lover's crimes. Isotta's history, however, is a strange one, and opens up many curious questions. She was of noble birth and seems to have attracted Sigismondo's notice as early as 1438, for at the age of twenty he produced verses of some merit in praise of her charms. She was indeed widely celebrated for her beauty and intellect, culture, firmness and prudence; and even Pope Pius II. proclaimed her worthy to be greatly loved. When Sigismondo was absent she governed Rimini wisely and well, and proved herself a match for the statesmen with whom she had to deal. The leading poets of the court dedicated to her a collection of verses entitled *Isottaei*, styled her their mistress and the chosen of Apollo. Artists of renown perpetuated her features on canvas, on marble and on many exquisite medals, one of which has a closed book graven on the reverse, with the inscription "Elegiae" in allusion to poems she was said to have written. Nevertheless, Yriarte, in his book on the Malatesta and Rimini, asserted that there was documentary evidence to prove that Isotta was unable to sign her own name. But it is not at all surprising that Isotta should have her letters written and signed by another hand, when such was by no means an uncommon practice among the princes and nobilities of her day. Lucrezia Borgia, for instance, frequently did the same. It is besides simply incredible that a woman of the Italian Renaissance of Isotta's birth, standing and reputation should have been unable to write.

Her marriage with Malatesta did not take place until 1456; but of the ardent affection that had long bound them together there are stronger proofs than the lover's juvenile verses, or than even the children Isotta had borne to him. For, more than all else, the temple of St Francis has served to transmit to posterity the history of their loves. Malatesta decided on building this remarkable church as a thankoffering for his safety during a dangerous campaign undertaken for Pope Eugenius IV. about the year 1445.

The first stone was laid in 1446, and the work was carried on

with so much alacrity that mass was performed in it by the close of 1450. Sigismondo entrusted the execution of his plans to Leo Battista Alberti, who had to encase in a shell of classic architecture a 13th-century Franciscan church. The original edifice being left intact, it was a difficult question how to deal with the windows and the Gothic arches of the interior. Alberti solved the problem with marvellous skill, blending the old architecture with the new style of the Renaissance, and giving it variety without destroying its unity of effect.

Being eager to adorn his temple with the most precious marbles, Sigismondo's veneration for antiquity did not prevent him from pillaging many valuable classical remains in Rimini, Ravenna and even in Greece. Such was the zeal with which Alberti pursued his task that the exterior of the little Rimini church is one of the finest and purest achievements of the Renaissance, and surpasses in beauty and elegance all the rest of his works. But it is much to be deplored that he should have left the upper part of the façade unfinished. Alberti came to Rimini, made his design, saw the work begun and then left it to be carried out by very skillful artists, on whom he impressed the necessity of faithfully preserving its general character so as "not to spoil that music."

The internal decorations, especially the enormous quantity of wall ornaments, consisting chiefly of scrolls and bas-reliefs, were executed by different sculptors under the personal direction of Malatesta, who, even when engaged in war, sent continual instructions about their work. It is difficult to give an exact idea of this extraordinary church to those who have no personal acquaintance with it. The vault was never finished, and still shows its rough beams and rafters. The eight side chapels alone are complete, and their pointed arches spring from Renaissance pilasters planted on black marble elephants, the Malatesta emblems, or on baskets of fruit held by children. The surface of the pilasters is divided into compartments encrusted with bas-reliefs of various subjects and styles. Everywhere—on the balustrades closing the chapels, round the base of the pilasters, along the walls, beneath the cornice of both the exterior and the interior of the church—there is one ornament that is perpetually repeated, the interwoven initials of Sigismondo and Isotta. This monogram is alternated with the portrait and arms of Malatesta; and these designs are enwreathed by festoons linked together by the tyrant's second emblem, the rose. The most singular and characteristic feature of this edifice is the almost total absence of every sacred emblem. Rather than to St Francis and the God of the Christians it was dedicated—and that while Sigismondo's second wife still lived—to the glorification of an unhallowed attachment. Nature, science and antiquity were summoned to celebrate the tyrant's love for Isotta. The bas-reliefs of one of the chapels represent Jupiter, Venus, Saturn, Mars and Diana, together with the signs of the zodiac. And these subjects are derived, it appears, from a poem in which Sigismondo had invoked the gods and the signs of the zodiac to soften Isotta's heart and win her to his arms. The pageants of Mars and Diana seem to have been suggested by the *Trionfi* of Petrarch. Elsewhere we see prophets and sibyls, personifications of the theological virtues and of the sciences. The delicate bas-reliefs of botany and medicine, history and astronomy, have been judged by some writers to be Grecian, on account of the ancient appearance of their marble, their inscriptions in Greek and Latin, and others that have never been deciphered. But a moment's examination of the sculptures is enough to destroy this hypothesis. Besides, some of the inscriptions are very easily read and record "Apollo Arimineaes" and "Jupiter Arimineaes."

In the first chapel on the left is the family tomb of the Malatesta, with sculptured records of their triumphs and of their alleged descent from Scipio Africanus. Better worthy of notice is the third chapel to the right, known as that of the Angels, on account of the angels and children carved on its pillars. It is nominally dedicated to the archangel Michael, whose statue is enshrined in it; but the figure has the face of

Isotta, the ruling deity of this portion of the church. For here is the splendid and fantastic tomb erected to this lady, during her life and previous to the death of Sigismondo's second wife. No monument, be it remarked, is raised over the burial-place of Ginevra and Polissena. The urn of Isotta's sarcophagus is supported by two elephants, and bears the inscription, "D. Isotta Ariminesi B. M. Sacrum, MCCCCL." The "D." has been generally interpreted as "Divae" and the "B. M." as "Beatae Memoriae." But some, unwilling to credit such profanity, allege that the letters stand for "Bonae Memoriae." Nevertheless, all who have seen the church must admit the improbability of similar scruples.

The numerous artists employed on the interior of the church were under the direction of the *proto-maestro* Matteo de Pasti the celebrated medallist. And indeed the peculiar and fantastic character of the sculptures in this chapel frequently recalls the designs of his famous works. All this decoration is in strange contrast with the grandly austere simplicity of the façade and outer walls of the church. There no ornament disturbs the harmony of the lines. The frieze beneath the cornice, reproducing the lovers' initials and the Malatestian ensigns, is in such very low relief that it only enhances the perfection of "that music" produced by the marvellous skill of Alberti. Also the colour of the stone, a soft creamy white, adds to the general beauty of effect. And everything both within and without contributes to the profane and pagan character which it was Sigismondo's purpose to impress on the Christian church. On each of its outer walls are seven arched recesses, intended to contain the ashes of the first literati and scientists of his court. In the first, to the right, is the urn of the poet Basinio, one of his pensioners, in the second that of Giusto de' Conti, author of some rhymes on the *Bella Mano*, while the third bore the more famous name of Gemisthus Pletho. This well-known Byzantine philosopher was the diffuser of Platonism in Florence during the time of Cosimo de' Medici, and had faith in the revival of paganism. Returning to his own people, he had died in the Morea. Sigismondo, having gone there in command of the Venetian expedition against the Turks, exhumed the philosopher's bones as holy relics, and brought them to Rimini for worthy sepulture in his Christian pantheon. All this is solemnly recorded in the inscription, which is dated 1465. The fourth sarcophagus was that of Roberto Valturio (d. 1489), the engineer, author of *De Re Militari*, who had been Sigismondo's minister and had aided him in the construction of the castle of Rimini. The other urns on this side were placed by Malatesta's successors, and the arches on the left wall remained untenant.

Sigismondo understood the science of fortification. He was also the first to discard the use of wooden bomb-shells, and substitute others cast in bronze. As a soldier his numerous campaigns had shown him to be possessed of all the best qualities and worst defects of the free captains of his time. He began his military career in 1432 in the service of Eugenius IV.; but, when this pope doubted his good faith and transferred the command to another, he sided with the Venetians against him, though at a later date he again served under him. On the decease of Filippo Maria Visconti in 1447 he joined the Aragonese against Venice and Florence; but, presently changing his flag, fought valiantly against Alphonso of Aragon and forced him to raise the siege of Piombino. In 1454 he accepted a command from the Siennese; but suddenly, after his usual fashion, he made peace with the enemies of the republic, and had to save himself by flight from arrest for his perfidy. It was then that the letters from Isotta were confiscated. After this he began scheming to hasten the coming of the Angevins, and took part in new and more hazardous campaigns against adversaries such as the duke of Urbino, Sforza of Milan, Piccinino, and, worst of all, the Siennese pope, Pius II., his declared and mortal foe. This time Sigismondo had blundered; for the cause of Anjou was hopelessly ruined in Italy. He was therefore driven to make his submission to the pope, but, again rebelling, was summoned to trial in Rome (1460) before a tribunal of hostile cardinals. All the old charges against him were now revived

and eagerly confirmed. He was pronounced guilty of rapine, incendiarism, incest, assassination and heresy. Consequently he was sentenced to the deprivation of his state (which was probably the main object of the trial), and to be burnt alive as a heretic.

This sentence, however, could not easily be executed, and Sigismondo was only burnt in effigy. But the pope marked the intensity of his hatred by causing the dummy to be carved and dressed with such lifelike resemblance that he was almost able to persuade himself that his hated enemy was really consumed in the flames. Malatesta could afford to laugh at this farce, but he nevertheless prepared in haste for a desperate defence (1462). He knew that the bishop Vitelleschi, together with the duke of Urbino and his own brother Novello Malatesta, lord of Cesena, were advancing against him in force; and, being defeated by them at Pian di Marotta, he was driven to Rome in 1463 to again make submission to the pope. This time he was stripped of all his possessions excepting the city of Rimini and a neighbouring castle, but the sentence of excommunication was withdrawn. The once mighty tyrant of Rimini found himself reduced to penury with a state chiefly composed of a single town. He therefore took service with the Venetians, and in 1464 had the command of an expedition to the Morea. Here his movements were so hampered by the interference of the commissioners of the republic that, with all his valour, he could achieve no decisive success. In 1466 he was able to return to Rimini, for Pius II. was dead, and the new pope, Paul II., was less hostile to him. Indeed, the latter offered to give him Spoleto and Foligno, taking Rimini in exchange; but Malatesta was so enraged by the proposal that he went to Rome with a dagger concealed on his person, on purpose to kill the pope. But, being forewarned, Paul received him with great ceremony, and surrounded by cardinals prepared for defence; whereupon Sigismondo changed his mind, fell on his knees and implored forgiveness. His star had now set for ever. For sheer subsistence he had to hire his sword to the pope and quell petty rebellions with a handful of men. At last, his health failing, he returned to his family, and died in Rimini on the 7th of October 1468, aged fifty-one years.

He was succeeded, according to his desire, by Isotta and his son Sallustio. But there was an illegitimate elder son by another mother, named Roberto Malatesta, a valiant and unscrupulous soldier. Befriended by the pope, this man undertook to conquer Rimini for the Holy See, but came there to further his own ends instead (20th October 1469), and, while feigning a desire to share the government with Isotta and her son, resolved, sooner or later, to seize it for himself. This aroused the pope's wrath, and Roberto instantly prepared for defence. Finding an ally in the duke of Urbino, whose eyes were now opened to the aggressive policy of the church, he was able to repulse its forces. Paul II. died soon after, and was succeeded by Sixtus IV. Roberto's position was now more secure, and in order to strengthen his recent alliance he betrothed himself to the daughter of the duke of Urbino. The next step was to dispose of his rival kindred. On the 8th of August 1470 Isotta's son was found murdered in a well belonging to the Marcheselli family; and a bloodstained sword, placed in their courtyard by Roberto, made it appear as though they had been guilty of the crime. Towards the end of the same year Isotta died also, apparently of a slow fever, but really, it was believed, by poison. Another of her sons, Valerio, born in 1453, still lived, but he was openly put to death by Roberto on a trumped-up charge of treason. In 1475 the new tyrant celebrated his nuptials with the duke of Urbino's daughter, and, being again taken into favour by the pope, valiantly defended him in Rome against the attacks of the duke of Calabria, and died there in 1482 of the hardships endured in the war. His widow was left regent during the minority of his son Pandolfo, who was nicknamed Pandolfaccio on account of his evil nature. Directly he was of age, he seized the reins of government by killing some relations who had plotted against him, and crushed another conspiracy in the same way. A

daring soldier, he distinguished himself at the battle of the Taro against the French; but his tyranny made him hated by his subjects. In 1500, when Cesare Borgia fell on Romagna with violence and fraud, this Malatesta shared the fate of other petty tyrants and had to fly for his life. After the fall of the Borgia he returned, but, being bitterly detested by his people, decided to sell his rights to the Venetians, who had long desired to possess Rimini, and who gave him in exchange the town of Cittadella, some ready money, and a pension for life.

This arrangement was naturally disapproved by Rome, and especially by Julius II.; he therefore contrived the league of Cambray on purpose to ruin the Venetians, who were crushingly defeated in 1509. Thereupon the pope, having accomplished his own ends, made alliance with the Venetians, who were now prostrate at his feet, and, with them, the Spaniards and the Swiss, fought against the French at Ravenna in 1512. Here the French were victors, but owing to their heavy losses and the death of their renowned leader, Gaston de Foix, were compelled to retreat. Thus Julius became master of Rimini and the other coveted lands. Malatesta made more than one attempt to win back his city, but always in vain, for his subjects preferred the papal rule, and in 1528 Pope Clement VII. became definite master of the town. Thus, after two hundred and fifty years, the sway of the Malatesta came to an end, and Pandolfo was reduced to beggary. He died in 1534, leaving a daughter and two sons in great poverty. The elder, Sigismondo, after various military adventures, died at Reggio d'Emilia in 1543; and Malatesta, the younger, went to fight in the Scotch and English wars, and was never heard of again. Sigismondo had left male heirs who made another attempt to regain Rimini in 1555, but Pope Paul IV. declared them deposed in perpetuity in punishment of Pandolfaccio's misdeeds.

From that time the Malatesta became citizens of Venice; their names were inscribed in the Golden Book, and they were admitted to the grand council. With the death, in 1716, of Christina Malatesta, the wife of Nicolo Boldu, the Rimini branch of the family became extinct. The descendants of Giovanni, brother of Malatesta da Verrucchio, who married one of the Sogliano, were known as the Sogliano-Malatesta. The representatives of this branch settled in Rome.

The history of Rimini practically ends with its independence. It fell into obscurity under the rule of the popes, and was not again mentioned in history until, in 1831 and 1845, it began taking a prominent part in the revolutionary movements against papal despotism and in favour of Italian independence.

BIBLIOGRAPHY.—Battaglini, *Memorie Storiche di Rimini e de' suoi signori, pubblicate con note di G. A. Zanetti* (Bologna, 1789); Fossati, *I tempi di Malatesta di Rimini* (Foligno, 1794); Moroni, *Dizionario di erudizione storico-ecclesiastica* (vol. lvii., s.v. "Rimini"); Ch. Yriarte, *Rimini: Un Condottiere au XV. Siècle: Etudes sur les lettres et les arts à la cour des Malatesta* (Paris, 1882); Tonini, *Storia di Rimini* (Rimini, 1848-62); E. Hutton, *Sigismondo Malatesta* (London, 1906).

RIMMER, WILLIAM (1816-1879), an American artist, was born in Liverpool, England, on the 20th of February 1816. He was the son of a French refugee, who emigrated to Nova Scotia, where he was joined by his wife and child in 1818, and who in 1826 removed to Boston, where he earned a living as a shoe-maker. The son learned the father's trade; at fifteen became a draughtsman and sign-painter; then worked for a lithographer; opened a studio and painted some ecclesiastical pictures; in 1840 made a tour of New England painting portraits; lived in Randolph, Mass., in 1845-55 as a shoe-maker, for the last years of the decade practising medicine; practised in East Chelsea and received a diploma from the Suffolk County Medical Society; and in 1855 removed to East Milton, where he supplemented his income by carving busts from blocks of granite. In 1860 he made his head of St Stephen (now in the Boston Athenaeum) and in 1861 his "Falling Gladiator" (since 1880 in the Boston Museum of Fine Arts), which Truman H. Bartlett calls "the most remarkable

work of sculpture that has yet [1882] been produced in this country . . . powerful, wonderful, but not alluring." Rimmer's sculptures, except those mentioned and "The Fighting Lions" (now in the Boston Art Club), "A Dying Centaur" (in the Boston Museum of Fine Arts), and a statue of Alexander Hamilton (made in 1865 for the city of Boston), were soon destroyed. He worked in clay, not modelling but building up and chiselling; almost always without models or preliminary sketches; and always under technical disadvantages and in great haste; but his sculpture is anatomically remarkable and has an "early-Greek" simplicity and strength. He published *Elements of Design* (1864) and *Art Anatomy* (1877), but his great work was in the class-room, where his lectures were illustrated with blackboard sketches. His studies in line suggest William Blake in their imaginative power. He died on the 20th of August 1879.

See Truman H. Bartlett, *The Art Life of William Rimmer* (Boston, 1882).

RIMSKY-KORSAKOV, NICOLAS ANDREIVICH (1844-1908), Russian composer, was born at Tikhvin, Novgorod, on the 18th (N.S.) of March 1844. He was one of the musical amateurs who, with Borodin, Cui and Moussorsky, gathered round Balakirev in St Petersburg in the days when Wagner was still unknown. By 1865 he had written a symphony (in E minor) which in that year was performed—the first by a Russian composer—under Balakirev's direction, and in 1873 he definitely retired from the navy, having been appointed a professor in the St Petersburg Conservatoire. The same year witnessed his marriage to a talented pianist, Nadejda Pourgold, and the production of his first opera, *Pskovitianka*. This was followed by *May Night* (1878), *The Snow Maiden* (1880), *Mlada* (1892), *Christmas Eve* (1894), *Sadko* (1895), *Mozart and Salieri* (1898), *The Tsar's Bride* (1899), *Tsar Saltana* (1900), *Servilia* (1902), *Kostchei the Immortal* (1902), *Kites* (1905). But his operas attracted less attention abroad than his symphonic compositions, which show a mastery of orchestral effect combined with a fine utilization of Russian folk-melody and a happy feeling for "programme music," his writing being peculiarly individual and distinctive in its restraint and avoidance of violent methods. Notable among these works are his first symphony, his second (Op. 9) *Antar*, his third (Op. 32), and his orchestral suites and overtures, his Spanish *Capriccio* (1887) being particularly appreciated. He also wrote a number of beautiful songs, pianoforte pieces, &c., and he eventually took Balakirev's place as the leading conductor in St Petersburg, never sparing himself in assisting in the musical development of the Russian school. He died there on the 20th of June 1908.

RINDERPEST (German for "cattle-plague," which is the English synonym), one of the most infectious and fatal diseases of oxen, sheep, goats, camels, buffaloes, yaks, deer, &c.; a virulent eruptive fever which runs its course so rapidly and attacks such a large percentage of ruminants when it is introduced into a country, that from the earliest times it has excited terror and dismay. It is an Asiatic malady, and has prevailed extensively in south Russia, central Asia, China, Indo-China, Burma, India, Persia, Ceylon and the Malay Archipelago. Thence it has at times been carried into Europe, and towards the end of the 19th century into South Africa. It appeared in Egypt in 1844 and 1865, Abyssinia in 1890, Japan in 1892, and the Philippines in 1898.

It has been noted that its irruptions into Europe in the earlier centuries of our era always coincided with invasions of barbarous tribes in the east of Europe; and even at a later period the disease accompanied the events of war, when troops with their commissariat moved from the east towards the west, or cattle, when they were carried in the same direction. One of the earliest recorded irruptions of cattle-plague into western Europe occurred in the 5th century after the sanguinary invasion of the Huns under Attila, the expulsion of the Goths from Hungary, and the fierce internecine wars of the whole Germanic population. The disease appears then to have been carried from Hungary through Austria to Dalmatia, while

by Brabant it obtained access to the Low Countries, Picardy, and so on to the other provinces of France. In the curious poem *De Mortibus Bovum* written by St Severus, who lived at that period, the course and destructiveness of the disease are specially alluded to. Many invasions of Europe are described, and in several of these Britain was visited by it—as in 809-10, 986-87, 1223-25, 1513-14, and notably in 1713, 1745, 1774, 1799. In 1865 and 1872 it was imported direct from Russia. In 1870-71 it destroyed 70,000 cattle in France, 30,000 in Alsace-Lorraine, and 10,000 in Germany. In England an outbreak occurred in 1877, when it was imported from Germany, where the disease continued until 1879.

The infective agent has not been positively identified, but it is known to exist in all the various secretions and excretions, in the flesh, blood and various organs of the body. Contagion may be direct or indirect, and the disease may be conveyed to healthy cattle by contaminated fodder, litter, water, clothing, pasture, sheds, railway wagons, hides, horns and hoofs. Attendants, cats, dogs, birds, vermin and flies may spread the infection. Definite symptoms of the disease may not be recognized until the expiration of three to six days after exposure, the period of incubation.

Symptoms.—Like some other general diseases, this does not offer any exclusive or pathognomonic symptoms, but is rather characterized by a group of functional and anatomical alterations. An exact knowledge of its symptoms and necropsical appearances is of the utmost importance, as its extension and consequent ravages can only be arrested through its timely recognition and the immediate adoption of the necessary sanitary measures. Intense fever, diarrhoea or dysentery, croupous inflammation of the mucous membranes in general, sometimes a cutaneous papular eruption, and great prostration mark the course of the affection, which is frequently most difficult to diagnose during life, especially if its presence is not suspected. Its introduction and mode of propagation can, in many instances, be ascertained only at a late period, and when great loss may already have been sustained. In the majority of cases the examination of the carcase of an animal which has died or been purposely killed is the best way to arrive at a correct diagnosis. Indeed, this is practically the only certain means of concluding as to the presence of the malady, as there are considerable variations in the chief symptoms with regard to their intensity as well as in the secondary symptoms or epiphenomena.

Among cattle indigenous to the regions in which this malady may be said to be enzootic the symptoms are often comparatively slight, and the mortality not great. So much is this the case that veterinary surgeons who can readily distinguish the disease when it affects the cattle of western Europe, can only with difficulty diagnose it in animals from Hungary, Bessarabia, Moldavia, or other countries where it is always more or less prevalent. In these the indications of fever are usually of brief duration, and signs of lassitude and debility are, in some instances, the only marks of the presence of this virulent disorder in animals which may, nevertheless, communicate the disease in its most deadly form to the cattle of other countries. Slight diarrhoea may also be present, and a cutaneous eruption, accompanied by gastric disturbance, running at the eyes, and occasional cough. In the more malignant form the fever runs high, 106° to 107° Fahr., and all the characteristic symptoms are well marked: dulness, sunken eyes, eruption on the skin, discharges from eyes, nose and mouth, shivering fits, difficult breathing, dry, harsh cough, military eruptions on the gums, accumulation of bran-like exudate within the lips, fetid breath, with certain nervous phenomena, and dysenteric dejections. Death generally occurs in four or five days, the course of the disorder being more rapid with animals kept in sheds than with those living in the open, and in summer than in winter. The post-mortem appearances are most marked in the digestive canal, and comprise red spots and erosions on the palate, lips, tongue and pharynx; intense congestion of the lining of the fourth stomach, which in places is covered with a grey or reddish pulaceous deposit, under which the membrane is deeply

ulcerated. Similar lesions are seen in the small intestine, caecum and rectum. The membrane lining the air passages is congested throughout, and the lungs are emphysematous.

In recent years much has been done in Russia and India towards the prevention of rinderpest by inoculation and the use of immunizing sera. In South Africa the bile method (or the injection of bile obtained from cattle dead of rinderpest), discovered by Koch, in 1896; bile with admixture of glycerine, recommended by Edington; the simultaneous injection of serum and rinderpest blood, introduced by Turner and Kolle in 1897, and repeated injection of fortified serum alone, have been employed, more or less successfully, in conferring immunity. But elsewhere the main line of action has been in the direction of preventing the introduction of the disease by prohibiting the importation of cattle from infected countries.

RING (O.E. *hring*; a word common to Teutonic languages,¹ and probably cognate with the Lat. *circus*, Gr. *κίρκος* or *κρίκος*, Skt. *chakra*, wheel, circ., cf. also "harangue"), in art, a band of circular shape of varying sizes, made of any material and used for various purposes, but, particularly, a circular band of gold, silver or other precious or decorative material used as an ornament, not only for the finger, but also for the ear (see **EARRING**), or even for the nose, where it is still worn by certain races in India and Africa. The word is also used of many objects which in structure take the shape of a circle or hoop, such as the tracheal rings, the circular-shaped bands of cartilage in the walls of the windpipe, the "annual rings," or concentric layers of wood produced each year in the trunks of trees, &c. In transferred senses "ring" is also applied to an enclosed space, whether circular, oval or otherwise: hence to the arena of a circus or hippodrome, the enclosure for a boxing contest, or to the place on a racecourse reserved for the bookmakers for the purpose of betting. A particular application in a transferred sense is that to a combination of persons in trade for the purpose of controlling markets, prices, etc.

In the art sense (see also **GEMS**), the English and German "ring" corresponds to the Gr. *δακτύλιος*, Lat. *annulus*, Fr. *anneau*. The enlarged part of a ring on which the device is engraved is called the "bezel," the rest of it being the "hoop." To decorate the human finger with a ring, if possible with one combining beauty, value and a distinctive character, was a widely spread natural impulse. At an early period, when the art of writing was known to but very few, it was commonly the custom for men to wear rings on which some distinguishing sign or badge was engraved (*ἐπίσημος*), so that by using it as a seal the owner could give a proof of authenticity to letters or other documents. Thus, when some royal personage wished to delegate his power to one of his officials, it was not unusual for him to hand over his signet ring, by means of which the full royal authority could be given to the written commands of the subordinate (cf. Gen. xli. 42; Esth. viii. 2). Among the Battas of Sumatra rings of a certain form are used to this day as passports.

The earliest existing rings are naturally those found in the tombs of ancient Egypt. The finest examples date from about the XVIIth to the XXth Dynasty; they are of pure gold, simple in design, very heavy and massive, and have usually the name and titles of the owner deeply sunk in hieroglyphic characters on an oblong gold bezel. Rings worn in Egypt by the poorer classes were made of less costly materials, such as silver, bronze, glass or pottery covered with a siliceous glaze and coloured brilliant blue or green with various copper oxides. Some of these had hieroglyphic inscriptions impressed while the clay was moist. Other examples have been found made of ivory, amber and hard stones, such as carnelian. Another form of ring used in the XIIth and subsequent dynasties of Egypt had a scarab in place of the bezel, and was mounted on a gold hoop which passed through the hole in the scarab and allowed it to revolve.

¹ "To ring," in the sense of to make a bell sound, is a different word. It also appears in various Teutonic languages and is probably of onomatopoeic origin, and may be akin to Lat. *clangor*.

In ancient Babylonia and Assyria finger rings do not appear to have been used. In those countries the signet took a different form, namely, that of a cylinder cut in crystal or other hard stone, and perforated from end to end. A cord like a bracelet. This way of wearing the signet is more than once alluded to in the Old Testament (Gen. xxxviii. 18, R.V., and Cant. viii. 6).

Cyllers.

ders.

Within the limits necessarily imposed by its purpose the finger-ring assumed a considerable variety of form, according to its date and place of origin.

In the Cretan and Mycenaean periods a characteristic form of ring had a broad flat bezel, not organically connected with the hoop, and having an incised design in the gold. The use of inset stones hardly occurs, but rings from Enkomi and Aegina of the late Mycenaean period have inset paste decorations.

The Phoenician type of ring was primarily intended to carry a scarab or scarabaeoid, usually in a box setting on a swivel, called for by the fact that the flat base of the scarab would be wanted for sealing purposes, but in wear would be most conveniently turned inwards. Strength being necessary, the hoop became massive. A similar arrangement of the signet-scarab is found attached to a twisted ring, which, from its shape, must have been meant to be suspended, and which is shown thus worn on some of the Cypriote terra-cottas.

The Greek ring of an early period has a characteristic flattened bezel, for an intaglio design in the gold. Such engravings attained great freedom and beauty in the 5th and 4th centuries B.C. An alternative form was a swivel ring for a scarab or scarabaeoid, imitating the Phoenician shape. When the stone was flat and inset the bezel became a mass of metal to hold it securely.

Among the Greeks signet rings were very largely worn. In Sparta a sumptuary law was passed at an early time to forbid any substance more valuable than iron to be used for signet rings; but in other parts of the Hellenic world there appears to have been no restriction of this sort.

Greek rings.

In some of the numerous tombs of Etruria and Kertch (Panticapaeum) in the Cimmerian Bosphorus gold rings of great magnificence have been discovered, apparently of the finest Greek workmanship.



FIG. 1.



FIG. 2.

Fig. 1 shows a ring from the Crimea with a finely engraved scarabaeus in gold, with an intaglio engraving on the base.

Fig. 2, also from the Crimea, has a corneian carved in lion form in place of the scarab, and has an intaglio figure on the base of a running lion.



FIG. 3.



FIG. 4.

Fig. 3 shows a Greek ring with an incised design in a plain bezel.

Fig. 4 is a ring from which the idea of a signet is entirely wanting.

² Figs. 1-6, 8 and 9 are from Dr Robert Forrer's *Reallexikon*, by permission of W. Spemann, Berlin and Stuttgart.

The Etruscans used very largely the gold swivel ring mounted with a scarab, a form of signet probably introduced from Egypt. Some found in Etruscan tombs have real Egyptian scarabs with legible hieroglyphs; others, probably the work of Phoenician or native engravers, have rude copies of hieroglyphs, either quite or partially illegible. A third and more numerous class of Etruscan signet rings have scarabs, cut usually in sard or carnelian, which are a link between the art of Egypt and that of Greece, the design cut



FIG. 5.

on the flat side being Hellenic in style, while the back is shaped like the ordinary Egyptian scarabaeus beetle. One from Etruria, now in the British Museum, is formed by two minutely modelled lions whose bodies form the hoop, while their paws hold the bezel, a scarab engraved with a lion of heraldic character. An alternative type of Etruscan ring (as in fig. 5) has an incised design on the gold bezel, or a flat stone set in the

rigid bezel. In either case the Etruscan rings tend to extravagance in size and elaboration.

The Romans appear to have imitated the simplicity of Laecadaemonia. Throughout the republic none but iron rings were worn by the bulk of the citizens, and even these were forbidden to slaves. Ambassadors were the first who were privileged to wear gold rings, and then only while performing some public duty. Next senators, consuls, equites and all the chief officers of state received the *jus annuli aurei*. In the Augustan age many valuable collections of antique rings were made, and were frequently offered as gifts in the temples of Rome. One of the largest and most valuable of the *dactylothecae* was dedicated in the temple of Apollo Palatinus by Augustus's nephew Marcellus (Pliny, *H.N.* xxxvii. 5). The temple of Concord in the Forum contained another; in this collection was the celebrated ring of Polyocrates, king of Samos, the story of which is told by Herodotus; Pliny, however, doubts the authenticity of this relic (*H.N.* xxxvii. 2).

Different laws as to the wearing of rings existed during the empire: Tiberius made a large property qualification necessary for the wearing of gold rings in the case of those who were not of free descent (Pliny, *H.N.* xxxiii. 8); Severus conceded the right to all Roman soldiers; and later still all free citizens possessed the *jus annuli aurei*, silver rings being worn by freedmen and iron by slaves. Under Justinian even these restrictions passed away.

In the rings of the Roman period the decoration is no longer an accessory of the bezel alone. It modifies the form of the hoop, which may be polygonal or angular (see fig. 6). The ring here figured is set with an eye, as an amulet, capable of turning on a swivel.

In the 3rd and 4th centuries Roman rings were made engraved with Christian symbols. Fig. 7 shows two silver rings of the latter part of the 4th century which were found in 1881 concealed in a hole in the pavement of a Roman villa at Fifthead



FIG. 6.



FIG. 7.—Roman silver rings.



FIG. 8.

Neville, Dorset, together with some coins of the same period. Both have the monogram of Christ, and one has a dove within an olive wreath rudely cut on the silver bezel. These rings are of special interest, as Roman objects with any Christian device have very rarely been found in Britain.

Fig. 8 is a choice example of a gold key-ring of the Christian

period, with good wishes inscribed in pierced gold work—*accipere dulcis, multis annis* (Brit. Mus.).



Part of FIG. 9.



Part of FIG. 9.

Fig. 9 is a gold ring from Smyrna (Brit. Mus.) with seven incised intaglio medallions, with a figure of Christ on the bezel. Assigned to the 5th century.

Large numbers of gold rings have been found in many parts of Europe in the tombs of early Celtic races. They are usually of very pure gold, often penannular in form—with a slight break, that is, in the hoop so as to form a Celtic ring. They are often of gold wire twisted into a sort of rope, or else a simple bar formed in an ornamental way. Some of the quite plain penannular rings were used in the place of coined money.

Throughout the Middle Ages the signet ring was a thing of great importance in religious, legal, commercial and private matters.

The episcopal ring¹ was solemnly conferred upon the newly made bishop together with his crozier, a special formula for this being inserted in the Pontifical. In the earliest references to rings worn by bishops, there is nothing to distinguish them from other signet rings. In A.D. 610 the first mention has been found of the episcopal ring as a well-understood symbol of dignity. It is clear that it was derived from the signet. It was only in the 12th century and onwards that it was brought into mystical connexion with the marriage ring. In the time of Innocent III. (1194) the ring was ordered to be of pure gold mounted with a stone that was not engraved; but this rule appears not to have been strictly kept. Owing to the custom of burying the episcopal ring in its owner's coffin, a great many fine examples still exist. Among the splendid collection of rings formed by the distinguished naturalist Edmund Water-ton, and now in the South Kensington Museum, is a fine gold episcopal ring decorated with niello, and inscribed with the name of Alhstan, bishop of Sherborne from 824 to 867 (see fig. 10). In many cases an antique gem was mounted in the bishop's ring, and often an inscription was added in the gold setting of the gem to give a Christian name to the pagan figure. The monks of Durham, for example, made an intaglio of Jupiter Serapis into a portrait of St Oswald by adding the legend CAPVT S. OSWALDI. In other cases the engraved gem appears to have been merely regarded as an ornament without meaning—as, for example, a magnificent gold ring found in the coffin of Sefrid, bishop of Chichester (1125-1151), in which is mounted a Gnostic intaglio. Another in the Water-ton collection bears a Roman cameo in plasma of a female head in high relief; the gold ring itself is of the 12th century. More commonly the episcopal ring was set with a large sapphire, ruby or other stone cut en cabochon, that is, without facets, and very magnificent in effect (see fig. 11). It was



FIG. 10.—Ring of Bishop Alhstan.



FIG. 11.—13th-century episcopal ring of Italian workmanship, of gold, set with a sapphire en cabochon.

¹ See a paper by Edm. Water-ton in *Arch. Jour.* xx. p. 224, also Cabrol, *Dict. d'arch. chrétienne, s.v.* "Anneaux."

worn over the bishop's gloves, usually on the forefinger of the right hand; and this accounts for the large size of the hoop of these rings. In the 15th and 16th centuries bishops often wore three or four rings on the right hand in addition to a large jewel which was fixed to the back of each glove.

The paper "Ring of the Fisherman" (*annulus piscatoris*) bears the device of St Peter in a boat, drawing a net from the water. The first mention of it, as the well-understood personal signet ring of the pope, that has been found, occurs in a letter of Clement IV. in 1265.

After the middle of the 15th century it was no longer used as the private seal of the popes, but was always attached to briefs. After the death of a pope the ring is broken. A new ring with the space for the name left blank is taken into the conclave, and placed on the finger of the newly elected pontiff, who thereupon declares what name he will assume, and gives back the ring to be engraved (see Waterton, *Archaeologia*, 40, p. 138).

The so-called papal rings, of which many exist dating from the 15th to the 17th centuries, appear to have been given by the popes to new-made cardinals. They are very large thumb rings, usually of gilt bronze coarsely worked, and set with a foiled piece of glass or crystal.

On the hoop is usually engraved the name and arms of the reigning pope, the bezel being without a device. They are of little intrinsic value, but magnificent in appearance.

The giving of a ring to mark a betrothal was an old Roman custom. The ring was probably a mere pledge, *pignus*, that the contract would be fulfilled. In Pliny's time conservative custom still required a plain ring of iron, but the gold ring was introduced in the course of the 2d century. This use of the ring, which was thus of purely secular origin, received ecclesiastical sanction, and formulae of benediction of the ring exist from the 11th century. The exact stages by which the wedding ring developed from the betrothal ring can no longer be traced.

Gemel or gimmel rings, from the Latin *gemellus*, a twin, were made with two hoops fitted together, and could be worn either together or singly; they were common in the 16th and 17th centuries, and were much used as betrothal rings.

Posy rings, so called from the "posy" or rhyme engraved on them, were specially common in the same centuries. The name "posy ring" does not occur earlier than the 16th century. A posy ring inscribed with "Love me and leave me not" is mentioned by Shakespeare (*Mer. of Ven.*, act v. sc. 1). The custom of inscribing rings with mottoes or words of good omen dates from a very early time. Greek and Roman rings exist with words such as ΖΗΛΑΙΣ, ΧΑΙΡΕ, ΚΑΛΗ, or *votis meis Claudia vivas*. In the Middle Ages many rings were inscribed with words of cabalistic power, such as *anam sapia*, or Caspar, Melchior and Balthasar, the supposed names of the Magi. In the 17th century they were largely used as wedding rings, with such phrases as "Love and obey," "Fear God and love me," "No gift can show the love I owe," "God above increase our love" or "Mulier viro subjecta esto."

In the same century memorial rings with a name and date of death were frequently made of very elaborate form, enamelled in black and white; a not unusual design was two skeletons bent along the hoop, and holding a coffin which formed the bezel.

Cramp rings were much worn during the Middle Ages as a preservative against cramp. They derived their virtue from being blessed by the king; a special form of service was used for this, and a large number of rings were consecrated at one time, usually when the sovereign touched patients for the king's evil.

Decade rings were not uncommon, especially in the 15th century; these were so called from their having ten knobs along the hoop of the ring, and were used, after the manner of rosaries, to say nine aves and a paternoster. In some cases there are only nine knobs, the bezel of the ring being counted in, and taking the place of the *goude*

in a rosary. The bezel of these rings is usually engraved with a sacred monogram or word.

In the 15th and 16th centuries signet rings engraved with a badge or trademark were much used by merchants and others; these were not only used to form seals, but the ring itself was often sent by a trusty bearer as the proof of the genuineness of a bill of demand.

At the same time private gentlemen used massive rings wholly of gold with their initials cut on the bezel, and a graceful knot of flowers twining round the letters. Other fine gold rings of this period have coats of arms or crests with graceful lambrequins.

Poison rings with a hollow bezel were used in classical times; as, for example, that by which Hannibal killed himself, and the poison ring of Demosthenes. Pliny records that, after Crassus had stolen the gold treasure from under the throne of Capitoline Jupiter, the guardian of his shrine, to escape torture, "broke the gem of his ring in his mouth and died immediately." The medieval *anello della morte*, supposed to be a Venetian invention, was actually used as an easy method of murder. Among the elaborate ornaments of the bezel a hollow point made to work with a spring was concealed; it communicated with a receptacle for poison in a cavity behind, in such a way that the murderer could give the fatal scratch while shaking hands with his enemy. This device was probably suggested by the poison fang of a snake.

A very large and elaborate form of ring is that used during the Jewish marriage service. Fine examples of the 16th and 17th centuries exist. In the place of the bezel is a model, minutely worked in gold or base metal, of a building with high gabled roofs, and frequently movable weathercocks on the apex. This is a conventional representation of the temple at Jerusalem.

Perhaps the most magnificent rings from the beauty of the workmanship of the hoop are those of which Benvenuto Cellini produced the finest examples. They are of gold, richly chased and modelled with caryatides or grotesque figures, and are decorated with coloured enamels in a very skilful and elaborate way. Very fine jewels are sometimes set in these magnificent pieces of 16th-century jewellery.

Thumb rings were commonly worn from the 14th to the 17th century. Falstaff boasts that in his youth he was slender enough to "creep into any alderman's thumb ring" (*Shakes., Hen. IV., Pt. I., act ii. sc. 4*).

The finest collections of rings formed in Britain have been those of Lord Lonsborough, Edmund Waterton (now in the Victoria and Albert Museum) and the collection in the British Museum, which was greatly augmented in 1897 by the bequest of the late Sir A. W. Franks.

Bibliography.—Licetus, *De Anulis antiquis* (Udine, 1645); Kirchmann, *De Annulis* (Schleswig, 1657); King, *Antique Gems and Rings*, 1872; Marshall, *Catalogue of Finger Rings in the British Museum*, 1907; Cabrol, *Dictionnaire d'archéologie chrétienne, s.v. "Anneaux"*; articles of Waterton in *Archaeologia* and *Archaeological Journal*. (J. H. M.; A. H. Sm.)

RING-GOAL, a game for two persons played on a ground, or indoor rink, 78 ft. long by 10 ft. wide, with a ring of split cane about 7½ in. in diameter and weighing about 3½ oz., which is propelled in the air by means of two sticks, resembling miniature billiard-cues, which are held inside the ring. The goals consist of two uprights 8 ft. high and 10 ft. apart, from which a net is stretched on an incline, so that its base will be a few feet behind the goal-line, and the object of the game is to drive the ring into these goals, each goal made scoring one point. The ring must be propelled by the server and caught by his opponent, on one or both of his sticks, if he can, and so returned alternately, and a point is scored for either player if it be stopped by his opponent in any other manner. A point is also scored for the receiver if the server, who begins the game, throw the ring so that it falls to the ground before

¹ The celebrated ring given to Essex by Queen Elizabeth was meant to be used for a similar purpose. It is set with a fine cameo portrait of Elizabeth cut in sardonyx, of Italian workmanship.

"Ring of the Fisherman."

Papal rings.

Betrothal and wedding rings.

Gemel rings.

Posy rings.

Memorial rings.

Cramp rings.

Decade rings.

Merchants' rings.

Poison rings.

Hebrew rings.

Thumb rings.

the receiver can catch it between the creases, which are lines drawn across the court 6 ft. from the goal-lines, or the ring be driven out of court. Eleven points constitute a game. Ring-goal was invented by an under-graduate of Keble College, Oxford, about 1885, and was played at Oxford, but without attracting any wide popularity.

RINGWOOD, a market town in the New Forest parliamentary division of Hampshire, England, 103½ m. S.W. by W. from London by the London & South-Western railway. Pop. (1901) 4629. It lies pleasantly on the river Avon, which here divides into numerous branches, flowing through flat meadow land. The church of SS. Peter and Paul, which was almost entirely reconstructed in 1854, the town hall and corn exchange are the chief buildings. A large agricultural trade and manufactures of agricultural implements, linen goods and woollen gloves are carried on.

RINGWORM (or *TINEA TONSURANS*), a disease of the scalp (especially common within the tropics); it consists of bald patches, usually round, and varying in diameter from half an inch up to several inches, the surface showing the broken stumps of hairs and a fine whitish powdering of desquamated epidermic scales. In scrofulous subjects matter is sometimes produced, which forms crusts, or glues the hair together, or otherwise obscures the characteristic appearance. The disease is due to a parasite, *Trichophyton tonsurans*, which exists mostly in the form of innumerable spores (with hardly any mycelium), and is most abundant within the substance of the hairs, especially at their roots. If a piece of the hair near the root be soaked for a time in dilute liquor potassae and pressed flat under a cover-glass, the microscope will show it to be occupied by long rows of minute oval spores, very uniform in size, and each bearing a nucleus.

The same fungus sometimes attacks the hairs of the beard, producing a disease called "syccosis." Sometimes it invades the hairless regions of skin, forming "tinea circinata"; circular patches of skin disease, if they be sharply defined by a margin of papules or vesicles, may be suspected of depending on the tinea-fungus. Interesting varieties of tinea are found in some of the Pacific and East Indian islands. Among the best remedial agents are various mercurial preparations. But in modern practice much success has been found in X-raying the patch in order to remove the dead and diseased hairs, thus leaving a free channel for the passage of antiseptic applications to the follicles. The exposures are followed by inunction of a mercurial preparation or of a lotion of tincture of iodine with methylated spirit.

See also *FAVUS*.

RINTOUL, ROBERT STEPHEN (1787-1858), British journalist, was born at Tibbermore, Perthshire, in 1787, and educated at the Aberdalgie parish school. After serving his apprenticeship to the printing trade he became the printer and subsequently the editor of the *Dundee Advertiser*. In 1826 he came to London, and in July 1828, with the assistance of friends, founded *The Spectator*. In it Rintoul strongly supported the Reform Bill, and to him was due the catch-phrase "The bill, the whole bill, and nothing but the bill." After conducting *The Spectator* for more than thirty years, he sold it shortly before his death, which occurred on the 22nd of April 1858.

RINUCCINI, GIOVANNI BATTISTA (1592-1653), archbishop of Ferrmo, was born in Rome on the 15th of September 1592, being the son of a senator. He studied at several Italian universities, became chamberlain to Pope Gregory XV., and in 1625 was made archbishop of Ferrmo. His participation in Irish politics, which is his chief title to fame, began during the later stages of the Civil War when Ireland was the scene of universal disorder. In 1645 Pope Innocent X. despatched him to that country as papal nuncio; he landed at Kenmare with arms and money in October 1645, and took up his residence at Kilkenny. Before this time the Roman Catholics had banded themselves together for defence. Called the Confederate Catholics, they had set up a provisional government, and when

the nuncio reached Kilkenny they were engaged in negotiating for peace with the lord lieutenant, the marquess, afterwards duke, of Ormonde. Rinuccini took part in the proceedings, but as his demands were ignored he refused to recognize the peace which was concluded in March 1646, and gaining the support of the Irish general, Owen Roe O'Neill, he used all his influence, both ecclesiastical and political, to prevent its acceptance by others. To a large extent he succeeded. Meeting at Waterford, the clergy condemned the treaty and several towns took up the same attitude. The nuncio's most pliant helper was now Edward Somerset, earl of Glamorgan, afterwards marquess of Worcester, who had been sent to Ireland by Charles I., and who had entered into communication with Rinuccini when the latter first arrived in that country. Glamorgan bound himself to carry out all the wishes of the nuncio, who intended that he should supplant Ormonde. In September 1646 Rinuccini took over the conduct of affairs. He imprisoned his opponents on the council and tried to arrange for an attack on Dublin. But there was no harmony among his subordinates, his military plans failed and soon all parties were tacitly ignoring him. Leaving Kilkenny he stayed for some time in Galway, and in February 1649 he left Ireland. After visiting Rome he returned to Ferrmo in 1650 and died on the 5th of December 1653.

See G. Aiazzi, *La Nunziatura in Irlanda* (Florence 1844), English translation as *The Embassy in Ireland*, by A. Hutton (Dublin, 1873); and S. R. Gardiner, *History of the Great Civil War*, vols. iii. and iv. (1905).

RIOBAMBA or **ROYABAMBA**, a town of Ecuador, capital of the province of Chimborazo, on the railway between Guayaquil and Quito, about 85 m. E.N.E. of the former. Pop. (1900, estimate) 12,000. It stands in a barren, sandy basin of the great central plateau, drained by the Chambo, a tributary of the Pastaza, on the old road running southward from Quito into Peru, 9030 ft. above sea-level, and in full view of the imposing heights of Chimborazo, Carahuairazo (Carguairazo), Tunguragua and Altar. Though 300 ft. lower than Quito, its climate is considerably colder, owing, perhaps, to its more exposed situation and the vicinity of so many snow-clad peaks. It is a town of unusually wide streets and one-storeyed adobe houses, being so laid out and built because of earthquakes. It has very little importance as a commercial or industrial centre, having only a small trade and a few unimportant industries. The present town dates from 1797, when the great earthquake of that year destroyed the old town then situated 12 m. W., near the existing village of Cajabamba. The ruins of the old town indicate that it was much larger and finer than its successor.

RIO CUARTO, a town of Argentina in the province of Cordoba, 119 m. S. of the city of that name, and about 500 m. N.W. of Buenos Aires. Pop. (1904, estimate) 12,000. It stands 1440 ft. above sea-level and about half-way across the great Argentine pampas, on the banks of a river of the same name which finds an outlet through the Carcarañal into the Parana near Rosario. The town is built on the open plain and is surrounded with attractive suburbs. It is the commercial centre of a large district and has a large and lucrative trade. Its geographical position gives it great strategic importance, and the government maintains here a large arsenal and a garrison of the regular army. The surrounding country belongs to the partially arid pampa region and is devoted to stock-raising—cattle, horses, sheep and goats. Irrigation is employed in its immediate vicinity. Previous to 1872 this region was overrun by the Ranqueles, a warlike tribe of Indians, but the vigorous reprisals of General Ivanovski in that year, supplemented by the tactful intervention of the Franciscan missionaries, who have a convent in this town, put an end to these hostile forays and gave full opportunity for the industrial development of the country. There are some manufacturing industries in the town. The National Andine railway passes through Rio Cuarto, and branch lines connect with the Buenos Aires and Pacific line—all of which give railway communication

with Buenos Aires, Rosario, Tucuman, Cordoba, San Luis and Mendoza.

RIO DE CONTAS, or **VILLA DE CONTAS**, a town of Brazil in the state of Bahia, 230 m. S.W. from the city of Bahia, on the Brumado (Contas-Pequeno), a head stream of the Rio de Contas (Jussipe), which rises on the eastern slope of the neighbouring Serra das Almas, and flows S.E. and E. to the Atlantic coast at Barra do Rio de Contas. Pop. (1890), including rural districts, 17,318. The surrounding country is fertile and produces sugar, cotton, mandioca and tobacco, but has lost much of its prosperity through the droughts that have devastated the interior of the state, and because of the costs of transporting produce to market. Stock-raising was at one time an important industry here. The town was founded in 1715 by some "Paulistas" who discovered gold there in the sands of the river. It became a "villa" in 1724, but was soon afterward moved down the river 5 m. to a more convenient site on the high road between Bahia and Goyaz.

RIO DE JANEIRO, a maritime state of Brazil, bounded N. by Minas Geraes, E. by Espírito Santo and the Atlantic, S. by the Atlantic, and W. by São Paulo. It is one of the smaller states of the republic and has an area of 26,635 sq.m.; pop. (1900) 926,585. The state is traversed longitudinally by the Serra do Mar, which divides it into a low, narrow, irregular coastal zone, and a broad elevated river valley through which the Parahyba flows eastward to the Atlantic. The eastern part of this valley widens out into a great alluvial plain on which are to be found some of the richest sugar estates of Brazil. The central mountainous region is heavily wooded, the coast region is hot and in places malarial, but the valleys are fertile and well watered. The Parahyba valley has long been celebrated for its fertility, and was for many years the centre of the coffee-producing industry. The exhaustion of the soil and antiquated methods of cultivation have caused a great decline in this industry, and many of its coffee plantations are now either abandoned or are producing but a fraction of earlier crops. Stock-raising has been slowly developing since the abolition of slavery (1888) and the decline in coffee production, and the state now possesses large herds of cattle and droves of swine.

The state's agricultural and pastoral products are coffee, sugar, rum, Indian corn, mandioca (both bitter and sweet), cotton, tropical fruits, cattle, hogs, butter, cheese, fresh milk and lard. The state is well watered by the Parahyba (q.v.) and its tributaries and by numerous short streams flowing from the Serra do Mar to the coast. Manufacturing has been developed largely because of the fine water power supplied by the mountain streams, and among the manufactures are cotton, woolen, silk and jute fabrics, brick, tile and rough pottery, sugar, rum, vehicles, furniture, beer and fruit conserves. The state is well provided with railways, which include the Central do Brazil, Leopoldina, Melhoramentos and Rio do Ouro. The Central line runs from the city of Rio de Janeiro N.W. across the Serra do Mar to the Parahyba valley, where it divides into two branches at the station of Barra do Pirahy, one running westward to São Paulo, and the other eastward and northward into Minas Geraes. Besides these there are a number of short railways called the Theriosopolis, União Valenciana, Rio das Flores, Bananal, and Vassouras lines. The total extension of these railways in the state in 1907 was 1445 m. Other than Nictheroy, the ports of the state are São João da Barra, Macahé or Imbetiba, Cabo Frio and Paraty, but they are visited only by the smaller coasting vessels.

The capital of the state is Nictheroy on the E. side of the Bay of Rio de Janeiro, and other cities and towns, with their populations in 1890 except where otherwise stated, are: Campos (estimate, in 1907, 35,000), on the lower Parahyba in the midst of a rich sugar-producing region; Rio Bonito (19,321); Itaboraí (17,817); Barra Mansa (14,449), on the upper Parahyba; Rezende (14,370), in a fertile district of the upper Parahyba; Petropolis (q.v.); Cantagallo (about 9000), in a rich coffee district of the Serra do Mar; Paraty (10,765), a small port on the W. side of the bay of Angra dos Reis; Valença (11,965); Vassouras (9666); São Fidelis (11,770), a river port on the lower Parahyba having steamboat communication with Campos; Macahé (about 7000 in 1900), an old port on the eastern coast of

the state at the mouth of the Macahé river whose original anchorage has been filled with silt, and that of Imbetiba, in the vicinity, with which it is connected by tramway, is now used by vessels both for the town and the Macahé and Campos railway; Barra do Pirahy (7750), an important station and junction of the Central do Brazil railway on the N. side of the Serra do Mar, with large manufacturing and commercial interests; Parahyba do Sul (7343), in a fertile, long-settled district in the N.E. part of the state; Mariçá (10,373); Cabo Frio (10,382); Pirahy (10,429); Saquarema (12,489); Nova Friburgo (9857); and Araruama (9087).

RIO DE JANEIRO (in full, SÃO SEBASTÃO DO RIO DE JANEIRO, colloquially shortened to Rio), a city and port of Brazil, capital of the republic, and seat of an archbishopric, on the western side of the Bay of Rio de Janeiro, or Guanabara, in lat. 25°54'23"S., long. 45°8'34"W. (the position of the Observatory): The city is situated in the S.E. angle of the Federal District (*Distrito Federal*) formerly known as the Neutral Municipality (*Município Neutro*), an independent district or commune with an area of 538 sq. m., which was detached from the province of Rio de Janeiro in 1834. The city stands in great part on an alluvial plain formed by the filling in of the western shore of the bay, which extends inland from the shore-line in a north-westerly direction between a detached group of mountains on the S. known as the Serra da Carioca, and the imposing wooded heights of the Serra do Mar on the N. The spurs of the Carioca range project into this plain, in some places, closely up to the margin of the bay, forming picturesque valleys within the limits of the city. Some of the residential quarters follow these valleys up into the mountains and extend up their slopes and over the lower spurs, which, with the hills covered with buildings rising in the midst of the city, give a picturesque appearance. At the entrance to the bay is the Sugar Loaf (*Pão de Assucar*), a conical rock rising 1212 ft. above the water-level and forming the terminal point of a short range between the city and the Atlantic coast. The culminating point of that part of the Carioca range which projects into and partly divides the city is the Corcovado (Hunchback), a sharp rocky peak 2329 ft. high overlooking the Botafogo suburb and approachable only on the wooded N.W. side. These spurs are covered with luxuriant vegetation, excepting their perpendicular faces and the slopes occupied by the suburbs. Considerably beyond the limits of the city on its S.W. side, but within the municipality, is the huge isolated flat-topped rock known as the Gavea, 2575 ft. high, which received its name from its resemblance to the square sail used on certain Portuguese craft. The sky-line of this range of mountains, as seen by the approaching traveller some miles outside the entrance to the bay, forms the rough outline of a huge reclining figure called "the sleeping giant," the facial profile of which is also known as "Lord Hood's nose."

The entrance to the bay, between the Sugar Loaf on the W. and the Pico on the E., with fortress of Santa Cruz on one side and the fort of São João on the other, is about a mile wide and free from obstructions. Almost midway in the channel are the little island and fort of Lage, so near the level of the sea that the spray is sometimes carried completely over it. On the W. is the semicircular bay of Botafogo, round which are grouped the residences of one of the richest suburbs; on the E., the almost land-locked bay of Jurujuba (see NICHTEROY). The bay extends northward nearly 16½ nautical miles, with a maximum breadth of 11 m. and a minimum, between the arsenal of war (*Ponta do Calabouço*) and the opposite Ponta da Gravata, of about 3500 yds. The shore-line is irregular, and has been modified by the construction of sea-walls and the filling in of shallow bays. Close to the shore are the islands of Villegaignon (occupied by a fort), Cobras (occupied by fortifications, naval storehouses, hospital and dry docks), Santa Barbara and Enxadas, the site of the Brazilian naval school. A small island just above the lower anchorage, which is occupied by port officials, was once known as Rat Island, and is now called Ilha Fiscal. There is one lake

within the urban limits, the Lagoa de Rodrigo de Freitas, near the Botanical Garden, separated from the sea by a narrow sand beach, which is being gradually filled in. Several small streams from the hills are conspicuous only in times of heavy rains.

The oldest part of the city, which includes the commercial section, lies between Castle and Santo Antonio hills on the S. and São Bento, Conceição and Livramento hills on the N., and extends inland to the Praça da Republica, though the defensive works in colonial times followed a line much nearer the bay. This section during the past century has extended southward along the bay shore in a string of suburbs known as the Cattede and Botafogo, with that of Larangeiras behind the Cattede in a pretty valley of the same name, and thence on or near the Atlantic coast as Largo dos Leões, Copacabana and Gavea, the last including the Botanical Garden. The greatest development has been northward and westward, where are to be found the suburbs of Cidade Nova, São Christovão, Engenho Novo, Pr.ª Formoso, Pedregulho, Villa Isabel, Tijuca, and a number of smaller places extending far out on the line of the Central railway. The extreme length of the city along lines of communication is little less than 20 m.

Streets.—Some of the most modern streets on the plain have been laid out with Spanish-American regularity, but much the greater part seems to have sprung into existence without any plan. Most of the streets of the old city are parallel and cross at right angles, but they are narrow and enclose blocks of unequal size. Each suburb is laid out independently, with straight streets where the ground permits, and crooked ones where the shore-line or mountain contour compels. Since the beginning of the 20th century large sums have been borrowed and expended on new avenues, the widening and straightening of old streets, and the improvement of the water-front between the Passeio Publico and the southern extremity of the Praia de Botafogo by the construction of a grand boulevard, partly on reclaimed land. One of these improvements consists of a central avenue cut across the old city from a point on the water-front near the Passeio Publico northward to the Saúde water-front. The shore-line boulevard, called the Avenida Beira-Mar, is about 4½ m. long, the wider parts being filled in with gardens. It was undertaken in 1903, during the administration of President Rodrigues Alves, as part of a vast scheme to improve the sanitary and traffic conditions of the city, including the construction of a new shore-line and filling in the shallow parts of the shore, which had long been considered one of the prime causes of the unhealthy state of the city. Another improvement was the completion and embellishment of the Mangue canal, originally designed as an entrance to a central market for the boats plying on the bay, but now destined for drainage purposes and as a public pleasure ground. This canal, as completed, is nearly 2 m. long, enclosed with stone walls, crossed by a number of iron bridges and bordered by lines of royal palms. The most famous street of the old city is the Rua do Ouvidor, running westward from the market-place to the Largo de São Francisco de Paula, and lined with retail shops, cafes and newspaper offices. It has long been a favourite promenade, and fills up the social and political life of the city. The principal business street is the Rua Primeiro de Março, formerly called Rua Direita, which extends from the Praça 15 de Novembro northward to São Bento Hill. All these old streets, excepting the last, are narrow and paved with squared granite blocks, and have their vehicle traffic regulated to go in one direction only. The side walks are very narrow, and the gas lamps are attached to the walls of the buildings. The streets and suburbs are served by five groups of tramway lines—Jardim Botânico, Santa Thereza, São Christovão, Villa Isabel, and Carris Urbanos—all using electric traction, but the last. The streets are lighted with electricity and gas, the Ouvidor and some other narrow streets having a great number of gas-pipe arches across them for decorative illumination on festival occasions.

Parks.—The public parks and gardens are numerous and include the Botanical Garden with its famous avenue of royal palms (*Oreodoxa regia*); the Passeio Publico (dating from 1783), a small garden on the water-front facing the harbour entrance; the Jardim d'Acclamação, forming part of the Praça da Republica (once known as the Campo de Sant' Anna) with its artistic walks and masses of shrubbery; the Praça Tiradentes (the old Largo do Rocio, afterwards rechristened Praça da Constituição) with its magnificent equestrian statue of Dom Pedro I. executed by the French sculptor Luiz Rochet; the Praça 15 de Novembro on the water-front facing the old city palace; and a number of smaller squares with and without gardens.

Water Supply and Sewerage Drainage.—The water supply is derived from three sources: the small streams flowing

down the mountain sides which serve small localities; the old Carioca aqueduct, dating from colonial times, which collects a considerable supply from the small streams of the Serra da Carioca and brings it into the city through a covered conduit which once crossed the gap between Santa Thereza and Santo Antonio hills on two ranges of stone arches (now used as a viaduct by the Santa Thereza Tramway Company); and the modern Rio do Ouro waterworks, which brings in an abundant supply from the Serra do Tinquá, N.W. of the city—the length of the iron mains being 33 m. between the principal collecting reservoir and the main distributing reservoir at Pedregulho, near the Ponta do Cajú. There are three other distributing reservoirs in different parts of the city, and the supply, which has been augmented since the works were inaugurated in 1885, is good and ample. An extensive system of sewers was constructed by the City Improvements Co., an English corporation, which initiated the work in 1853; and a separate system of rain-water drains. The Leicester system is used because the greater part of the sewers are below sea-level, and it is necessary to use powerful pumps.

Climate.—The climate of Rio de Janeiro is hot, humid and debilitating, the temperature ranging from 50° to 90° F. in the shade, with an average for the year of 74°, and the rainfall being about 44 in. The greater part of the city is only 2 or 3 ft. above sea-level, is surrounded by mountains, and has large areas of water, swamp and wet soil in its vicinity. But the unhealthiness of Rio de Janeiro in past years may be charged to insanitary conditions and not to the climate. Yellow fever, whose first recorded appearance was in December 1849, was for many years almost a regular yearly visitant, and the mortality from it has been terrible. Smallpox also is practically endemic, owing in great part to negligent sanitary supervision. Since 1900 there have been several mild outbreaks of bubonic plague. These dangerous diseases are slowly disappearing as sanitary conditions are improved. The death-rate from tuberculosis, however, is high, and apparently shows no abatement. This is undoubtedly due to constitutional weakness arising from bad nutrition and the habit of sleeping in closed or badly ventilated apartments. Malarial fevers are also common, and diseases of the digestive organs, in great part easily preventible, figure among the principal causes of death. According to official returns for the five years 1900-1905, the average number of deaths was 15,926, or 20.4 per 1000. Among the deaths 2789 were from tuberculosis, 1200 from smallpox, 778 from malarial diseases, 331 from *la grippe*, and 106 from beri-beri. There were no unusual epidemics during those years, and the rate given may be considered normal.

Buildings.—There remain many public edifices and dwellings of the colonial period, severely plain in appearance, with heavy stone walls and tile roofs. The old city palace facing upon Praça 15 de Novembro, once the residence of the fugitive Portuguese sovereign Dom João VI., is a good example. The 19th century brought no important modifications until near its close, when French and Italian styles began to appear, both in exterior decoration and in architectural design. The new Praça do Commercio (Merchants' Exchange) and Post Office on Rua 1ª de Março, and the national printing office near the Largo da Carioca, are notable examples. Since then exterior ornamentation and architectural eccentricities have run riot, and the city is now a mixture of the plain one-storey and two-storey buildings of the Portuguese type, and fanciful modern creations, embellished with stucco and overtopping the others by many stores. Although a metropolitan see, Rio has no cathedral, the old imperial chapel facing the Praça 15 de Novembro being used for that purpose. The foundations were once laid for a great cathedral on the Largo de São Francisco de Paula, but the building stone was taken for a neighbouring theatre, and the foundations were afterwards used for the Polytechnic School. The most noteworthy church is the Candelaria church, in the commercial district, whose twin towers and graceful dome form one of the most conspicuous landmarks of the city. It was begun in 1775, but was not finished until near the end of the 19th century. Its fine proportions, however, are concealed by commercial buildings and by the narrow streets. Among many other churches, usually plain and bare of interior decoration, are the popular São Francisco de Paula church, on the square of that name; the Carmo church in Rua 1ª de Março; the Cruz dos Militares church in the same street; the Rosario church in the

street of that name, belonging to a fraternity of negroes and once occupied by the episcopal chapter; and the prettily situated octagonal Gloria church on a hill that name overlooking the lower bay. Another church of the same name faces on the Largo do Machado and shows the peculiar combination of a Greek temple surmounted by a modern spire. The British residents have an unpretentious chapel in Rua Evaristo da Veiga, the Methodists a more modern structure on the Largo do Catete and the Presbyterians a chapel near Praça Tiradentes. There is religious toleration in Brazil, but down to the organization of the republic no non-Catholic church or chapel was permitted to have a spire or other outward symbol of a place of worship.

Among public buildings of an official character the following are noteworthy. The old city palace facing on Praça 15 de Novembro dates from 1743 and was the residence of the royal governors and Dom João VI., but is now used by the national telegraph offices. The São Christovão palace, in the suburb of that name, was the residence of the Emperor Dom Pedro II. It is a rambling structure now occupied by the National Museum. The Catete palace, on the street of that name, originally a private residence, is now the official residence of the President, richly decorated within and partly surrounded by a handsome park. The Itamaraty palace near the Praça da Republica, a typical private residence of the better class, was purchased for and occupied by the first presidents and is now occupied by the ministry of foreign affairs. The palace of justice, on Rua Primeiro de Março, is one of the finest edifices in the city; and the ministry of industry and public works, on the south side of the Praça 15 de Novembro may be noticed. The ministry of war has its offices in the immense military *quartel* (barracks) on the north side of the Praça da Republica, and the ministry of marine in the naval arsenal at the foot of São Bento Hill. The ministry of finance is in the Treasury building on Rua do Sacramento—an immense structure of no special architectural merit. The Senate occupies a plain unattractive building on the west side of the Praça da Republica, and the Chamber of Deputies an ugly colonial building in Rua da Misericordia, originally used as a city hall and jail. A new legislative palace is designed to occupy the block on the west side of the Praça Tiradentes. There are a number of theatres, but the city had no large theatre of architectural merit previous to the construction of the Municipal Theatre at the intersection of the Avenida Central with Rua 13 de Maio, with an elegant marble facade. French Renaissance horse-racing is a favourite sport, and the Jockey Club maintains a racecourse in the São Francisco Xavier suburb. Other notable buildings are the ornate Monroe palace at the intersection of the Central and Beira-Mar avenues, the Praça do Commercio (Commercial Exchange) on Rua 1° de Março, the Caixa da Amortização on the Avenida Central, the custom-house with its extensive warehouses, the terminal station of the Central railway at the N.W. angle of the Praça da Republica, and the library building of the Gabinete Portueguez da Leitura with its exquisite "Manuelino" façade of Lisbon marble.

Education.—Although much money is given to hospitals and asylums, Rio de Janeiro has no great educational institutions either public or private. The Medical School may be considered the only distinctively professional school in the city. The Polytechnic School, occupying an interesting old building on the Largo de São Francisco de Paula, is chiefly devoted to civil engineering. The Gymnasio Nacional, formerly the Collegio D. Pedro II., is a boys' college of a high school grade, located on Rua Floriano Peixoto, with an *internato* or boarding-school in Rua de S. Francisco Xavier. The college dates from 1735, when it was founded as an asylum for orphan boys destined for the Church. In 1837 it became a state institution and took the name of the Emperor Dom Pedro II. One of the most noteworthy schools of the city is the Lyceu de Artes e Officios, located on Rua 13 de Maio, opposite the opera-house; it dates from 1858 and has been the means of giving instruction to a multitude of clerks, artisans and others, through its night classes. Another important school, partly of this class, is the Instituto Benjamin Constant, located in a fine new edifice on the Praia da Saudade, Botafogo. The public schools of Rio de Janeiro are defective both in organization and administration; the non-attendance of children from the higher classes, and the antagonism of the Church to schools under purely secular administration, must be held responsible for the backwardness of these schools. The episcopal seminary on Castle Hill, called the "Seminario Episcopal de São José," founded in 1730 and devoted exclusively to the education of priests, is the best classical school in the city. There are a number of charitable institutions devoted to the education of orphans, the blind and the deaf and dumb, which are admirably

equipped and administered. Among other educational institutions are a conservatory of music, school of fine arts, normal school, a national library with upwards of 260,000 volumes and a large number of manuscripts, maps, medals and coins, the national observatory on Castle Hill, the national museum now domiciled in the São Christovão palace in the midst of a pretty park, a zoological garden in the suburb of Villa Isabel, and the famous Botanical Garden founded by Dom João VI. in 1808 and now a horticultural experiment station.

Hospitals, &c.—Rio de Janeiro is well provided with hospitals, asylums and benevolent institutions. Chief of these is the Misericordia Hospital, popularly known as the "Santa Casa," belonging to a religious brotherhood dating from 1591. In addition to a large income from rentals, the Santa Casa receives the product of certain port taxes in return for opening its wards to the crews of all vessels in port. Other public hospitals are a lepers' hospital in São Christovão, the military and naval hospitals, the São Sebastião hospital and the isolation and contagious diseases hospitals in Jurujuba. There are also a number of private hospitals maintained by church brotherhoods and charitable associations; among them are the Portuguese hospital in Rua de Santo Amaro and the Strangers' Hospital (American and British) in Botafogo. Most prominent among the asylums is the Hospicio Nacional for the insane, on the Praia da Saudade, Botafogo, which was erected in 1842-52, and is one of the most completely equipped institutions of its class in the world. There are two public cemeteries: São Francisco de Xavier, in São Christovão, and São João Baptista, in Botafogo, the former having an unconsecrated section for Protestants. Besides these there are five private cemeteries, the one belonging to the British colony being on a hill overlooking the Gambia shore-line.

Harbour, Communications and Commerce.—The port and harbour of Rio de Janeiro are the largest and most important in the republic. The entrance is open to vessels of the largest draught, and there is sufficient deep-water anchorage inside for the navies of the world. The lower anchorage, where the officers of health visit vessels, is below Ilha Fiscal, and the upper, or commercial anchorage, is in the broad part of the bay above Ilha das Cobras, the national coasting vessels occupying the shallower waters near the Saúde and Gambia districts. The custom-house occupies a considerable part of the shore-line in front of the old city, and has a protected basin for the discharge of lighters. The new port works, under construction since 1903, consist of a new water-front for the Saúde, Gambia and Sacco de Alferez districts, in which the shipping interests are centred, and a continuation of the sea-wall across the shallow São Christovão bay to the Ponta do Cajú, the large reclaimed area to be filled in by the removal of some small hills. The commercial quays are built in deep water and permit the mooring alongside of the largest vessels. The total length of the commercial quays is about 3800 yds. Railway and tramway connexions are provided and both electric and hydraulic power are available. Special surtaxes are levied on imports to meet the interest and redemption charges on the loans raised for the execution of these important works. Another improvement is the extension of the sea-wall southward from the ferry-slips (Praça 15 de Novembro) to the Ponta do Calabouço (war arsenal), providing protected basins for the arsenal and enclosing small reclaimed areas. With the completion of these improvements the water-front of the city will consist entirely of deep-water walls from Botafogo to the Ponta do Cajú, with the exception of a short section between the Ponta do Calabouço and the Avenida Central. The port is in regular communication with the principal ports of Europe and America. The coastwise service is good, though rates are high. Railway communication with the interior is maintained by the Central do Brazil (formerly the Dom Pedro II.), Leopoldina and Melhoramentos lines, besides which there is a short passenger line up to the Corcovado about 2½ m. long, an electric line to Tijuca, and a narrow-gauge line running out to the Rio do Ouro water-works. There is daily communication with Petropolis by a branch line of the Leopoldina system, and also by a steamer to the head of the bay and thence by rail up the serra. Ferry-boats cross the bay to Niteroy at intervals of 20 minutes, and smaller craft provide communication with the islands of Governador and Paqueta.

Rio de Janeiro is the seaport for a large area of the richest, most productive and most thickly settled parts of Brazil, including the states of Rio de Janeiro and Minas Geraes and a small part of eastern São Paulo. Its exports include coffee, sugar, hides, cabinet woods, tobacco and cigars, tapioca, gold, diamonds, manganese and sundry small products. Rio is also a distributing centre in the coasting trade, and many imported products, such as jerked beef (*carne secca*), hay, flour, wines, &c., appear among the coastwise exports, as well as domestic manufactures. The total exports for 1905 were officially valued at 62,572,033 *milreis* gold, or a little over one-sixth the exportation of the whole country. Formerly Rio led all other ports in the export of coffee, but the enormous increase in production in the state of São Paulo has given Santos the lead. The exports of coffee from Rio in 1908 amounted to 3,062,268 bags of 60 kilogrammes each, officially valued at about \$27,846,000. The coffee-producing area tributary to this port is slowly decreasing, owing to the exhaustion of the soil and the greater productivity of São Paulo. The imports include wheat-flour, Indian corn, jerked beef (*carne secca*), lard, bacon, wine and liquors, butter, cheese, conserves of all kinds, coal, cotton, woollen, linen and silk textiles, boots and shoes, earthen- and glasswares, railway material, machinery, furniture, building material, including pine lumber, drugs and chemicals, and hardware. The imports for 1905 aggregated 103,874,724 *milreis* gold, or about two-fifths the importation of the whole republic. The shipping arrivals in 1908 were as follows: from foreign ports, 1195 steamers of 3,479,357 tons and 75 sailing vessels of 84,474 tons; from national ports, 243 foreign steamers of 882,633 tons, 773 national steamers of 475,587 tons and 294 national sailing vessels of 20,250 tons—in all 2580 vessels of 7,542,301 tons.

Manufactures.—The industrial activities of Rio Janeiro have been largely increased since the organization of the republic through increased import duties on foreign products. There were a number of protected industries before this, but they made slight impression on imports. Rio de Janeiro has manufactures of flour from imported wheat, cotton, woollen and silk textiles, boots and shoes, ready-made clothing, furniture, vehicles, cigars and cigarettes, chocolate, fruit conserves, refined sugar, biscuits, macaroni, ice, beer, artificial liquors, mineral waters, soap, stearine candles, perfume, feather flowers, printing type, &c. There are numerous machinery and repair shops, the most important of which are the shops of the Central Works. One of the most important industrial enterprises in the city is the electric plant belonging to the Rio de Janeiro Light and Power Company, which supplies electric currents for public and private lighting, and power for the tramways and many industries. The hydro-electric works are situated about 50 m. N.W. of the city in a valley of the Serra do Mar, where a large reservoir has been created by building a dam across the Rio das Lages.

Government.—Rio de Janeiro is governed by a prefect, who represents the national government, and a municipal council which represents the people. The prefect is appointed by the President of the republic for a term of four years, and the appointment must be confirmed by the Senate. There are seven *directorias*, or boards, under the prefect, each one assigned to a special field of work, chief among which are education, health and public assistance, public works and transportation, and finance. The municipal council is elected by direct suffrage for a term of two years, and is composed of 15 members. The funded debt of the city on the 30th of June 1907 was £7,000,677, a part of which is guaranteed by the national government. There is some confusion in administration and accounts, however, and it is somewhat difficult to estimate the exact situation. The Federal District is represented in Congress by 2 senators and 10 deputies, and is credited with the rights and privileges of citizenship. On the other hand, the city is a garrison town and a district under the direct administration of the national executive, who appoints its chief executive, controls its police force, and exercises part control over its streets, squares and water front. In the work of improving the city, the national government assumed the expense of the commercial quays, the filling of the São Christóvão bay, the opening of the Mangue canal and its embellishment, the opening of the Avenida Central, the extension of the sewage system and the addition of new streets to the water supply, while the city was responsible for the Avenida Beira-Mar, the opening of a new avenue from the Largo da Lapa westward to Rua Frei Caneca, the removal of the Morro do Senado, the widening of some streets crossing the Avenida Central and the opening and straightening of other streets.

History.—The discovery of the Bay of Rio de Janeiro is attributed by many Portuguese writers to André Gonçalves, who entered its waters on the 1st of January 1502, and believed that it was the mouth of a great river, hence the name Rio de Janeiro (River of January). Another Portuguese navigator, Martim Afonso de Souza, visited it in 1531, but passed on to São Vicente, near Santos, where he established a colony. The first settlement in the bay was made by an expedition of French Huguenots under the command of Nicholas Durand Villegaignon,

who established his colony on the small island that bears his name. In 1560 their fort was captured and destroyed by a Portuguese expedition from Bahia under Mem de Sá, and in 1567 another expedition under the same commander again destroyed the French settlements, which had spread to the mainland. The victory was won on the 20th of January, the feast-day of St Sebastian the Martyr, who became the patron saint of the new settlement and gave it his name—São Sebastião do Rio de Janeiro. The French had named their colony La France Antarctique, and their island fort had been called Fort Coligny. In 1710 a French expedition of five vessels and about 1000 men under Duclerc attempted to regain possession, but was defeated; its commander was captured and later assassinated. This led to a second French expedition, under Duguay Trouin, who entered the bay on the 12th of September 1711, and captured the town on the 22nd. Trouin released Duclerc's imprisoned followers, exacted a heavy ransom and then withdrew. The discovery of gold in Minas Geraes at the end of the 17th century greatly increased the importance of the town. It had been made the capital of the southern captaincies in 1680, and in 1762 it became the capital of all Brazil. In 1808 the fugitive Portuguese court, under the regent Dom João VI., took refuge in Rio de Janeiro, and gave a new impulse to its growth. It was thrown open to foreign commerce, foreign mercantile houses were permitted to settle there, printing was introduced, industrial restrictions were removed, and a college of medicine, a military academy and a public library were founded. Dom João VI. returned to Portugal in 1821, and on the 7th of September 1822 Brazil was declared independent and Dom Pedro I. became its first emperor. There was no resistance to this declaration in Rio de Janeiro. There were some political disorders during the reign of Dom Pedro I., who was finally harassed into an abdication in favour of his son, Dom Pedro II., on the 7th of April 1831. The regency that followed was one of many changes, and led in July 1840 to a declaration of the young prince's majority at the age of fifteen. A long and peaceful reign followed, disturbed only by the struggles of rival political factions. In 1839 a steamship service along the coast was opened, but direct communication with Europe was delayed until 1850, and with the United States until 1865. These services added largely to the prosperity of the port. The first section of the Dom Pedro II. railway was opened in 1858, and the second or mountain section in 1864, which brought the city into closer relations with the interior. In 1874 submarine communication with Europe was opened, which was soon afterwards extended southward to the Platine republics. The first coffee tree planted in Brazil was in a convent garden of Rio de Janeiro. On the 15th of November 1889 a military revolt in the city under the leadership of General Deodoro da Fonseca led to the declaration of a republic and the expulsion of the imperial family, which was accomplished without resistance or loss of life. Disorders followed, a naval revolt in 1891 causing the resignation of President Deodoro da Fonseca, and another in 1893-94 causing a blockade of the port for about six months and the loss of many lives and much property from desultory bombardments. There have been since that time some trifling outbreaks on the part of agitators allied with the extreme republican element, but at no time was the security of the government in danger.

BIBLIOGRAPHY.—Nearly all books relating to Brazil devote some attention to its capital city. The history of its settlement and colonial development will be found in Robert Southey, *History of Brazil* (3 vols., London, 1810-19). For descriptions of the city, the customs and manners of its people and some of the larger political events during the first three-quarters of the 19th century, see R. Walsh, *Notes of Brazil in 1828 and 1829* (2 vols., London, 1830); Thomas Ewbank, *Life in Brazil* (New York, 1856); M. D. Moreira de Azevedo, *O Rio de Janeiro* (2 vols., Rio de Janeiro, 1877); and J. C. Fletcher and D. P. Kidder, *Brazil and the Brazilians* (9th ed., Boston, 1879), especially chapters iv. to xiv. For later descriptions, see A. J. Lamoureux, *Hand-Book of Rio de Janeiro* (Rio de Janeiro, 1887); Frank Vincent, *Around and About South America* (New York, 1890), chapters xxv. to xxix.; Marguerite Dickens, *Along Shore with a Man-of-War* (Boston, 1893); Arthur Dias, *Il Brasile Attuale* (Nivelle, Belgium, 1907); also in French and Portuguese, pp. 367-449.

RIO DE ORO, a Spanish possession on the N.W. coast of Africa. It is bounded W. by the Atlantic, E. and S. by Saharan territory under French protection. The northern frontier, where the protectorate adjoins the territory of the semi-independent tribes south of Morocco, is undefined. The most northerly point claimed by Spain on the coast is Cape Bojador. The southern and eastern boundaries were defined by a Franco-Spanish convention in 1900. The frontier traverses the middle of the Cape Blanco promontory, then runs eastward along the parallel of $21^{\circ} 20' N.$ till it meets the meridian of $13^{\circ} W.$, whence it turns first N.W. and afterwards N.E., meeting the tropic of Cancer at $12^{\circ} W.$ and thereafter runs due N. Forming part of the Sahara, Rio de Oro is nearly waterless. Oases are few and the sparse population consists almost entirely of nomad Arabs and Berbers. They are Mahomedans. In the south is the hilly country called Adrar Suttuf, not to be confounded with Adrar Temur (see **ADRAR** and **SAHARA**). The estimated area of the protectorate is 70,000 sq. m.

The peninsula of Rio de Oro, where is the principal Spanish settlement, occupies the central part of the coast-line in $23^{\circ} 50' N.$, $16^{\circ} W.$, and is united to the mainland by a sandy isthmus. Its length is 23 m., its breadth $\frac{1}{4}$ to 2 m. and it is on an average about 20 ft. above sea-level. The bay between peninsula and mainland—the so-called Rio de Oro—is 22 m. long, 5 broad, navigable over two-thirds of its extent, with good anchorage in most of the channel, but the bar at its mouth is not always easy to pass in rough weather. The peninsula has very sparse vegetation, except in its southernmost part near Cape Durnford. At the head of the bay is a small island—Isla Herne.

The climate is generally temperate, and not unhealthy except in the autumn. Esparto grass and manzanilla are grown in many places, but European plants are not easily acclimatized. On the peninsula and in the neighbouring country there are many wolves, foxes, hyenas, gazelles, lizards, hares, pelicans and large crows. The natives rear cattle, sheep, camels, and have but few horses. In contrast with the sterility of the land the sea throughout the coast of Rio de Oro abounds in fish, especially cod. The fishing industry is in the hands of the Canary Islanders and of the French.

The estuary between the mainland and the peninsula was taken by its Portuguese discoverers in the middle of the 15th century for a river, and, obtaining there a quantity of gold dust from the natives, they named it Rio d'Ouro (Gold River), Rio de Oro being the Spanish form. At a spot about 50 m. inland from the head of the estuary a Portuguese trading station was established, of which ruins exist, but the activity of the Portuguese was before long transferred to the true auriferous regions of the Gulf of Guinea.

Spain's interest in the Saharan coast dates from the 13th century, but was particularly directed to that part nearest the Canary Islands, a strip of coast over which she now exercises no sovereignty. The site of the fort of Santa Cruz de Mar Pequeña, established in 1476, though not identified, was north of Cape Bojador. The protection of the Canary Islanders engaged in the fisheries south of that point occasioned, however, the presence of Spanish warships in these waters, and small trading stations were formed at Rio de Oro, Cape Blanco and elsewhere. To preserve the interests thus acquired, Spain in January 1885 took the territories on the coast between capes Blanco and Bojador under her protection. The year before the Hispano-American Company had built a trading station on Rio de Oro peninsula, but in 1885 it was destroyed by the natives. The company renewed its operations, but subsequently ceded its rights to the Transatlantic Company of Barcelona. The extension inland of Spanish influence was opposed by France, which claimed a protectorate over the Sahara. The conflicting claims of the two powers were finally settled by the convention of 1900, which fixed the frontier in the manner stated. The administration is carried on under the control of the captain-general of the Canary Islands.

RIO GRANDE, a North American river, which rises in the San Juan Mountains of southern Colorado, flows S.E. and S. in Colorado, S. by W. and S.E. through New Mexico, and S.E. between Texas and Mexico to the Gulf of Mexico. Its length

is approximately 2200 m., and for about 1300 m. it forms the international boundary between the United States and Mexico. It presents many features of a complex physiographic type, being first a river of the Rocky Mountains, then of the interior deserts and then of the Atlantic Coastal Plain. It also presents a complicated geological history, as it includes what were originally several distinct streams. The Mexicans call it the Rio del Norte in its upper course, the Rio Bravo in the "Big Bend," from the mouth of the Conchas river to the mouth of the Devils river, and the Rio Grande only in its course through the Coastal Plain. From its headwaters, 12,000 ft. above the sea, it rushes rapidly down a mountain canyon to San Luis Valley, in Colorado. It flows with moderate speed through this broad valley, enters a long canyon with a maximum depth of 400 ft., about 4 m. above the boundary between Colorado and New Mexico, and is hemmed in between canyon walls rising as high as 1000 ft. or between the sides of narrow mountain valleys throughout its course through New Mexico. It passes through a series of picturesque canyons, some of them 1750 ft. in depth, in the "Big Bend," and becomes a silt-laden stream with a shifting channel in its passage through the Coastal Plain. Except in the flood season of May and June, the quantity of water which, for irrigation and by evaporation, is taken from the Rio Grande between its entrance to the San Luis Valley and the mouth of the Conchas, is greater than that received, and as a consequence it is an intermittent stream in this region. The flow of the Conchas is constant, and in the "Big Bend" the volume of the Rio Grande is enhanced by springs which break out in the bed. The total flow of the Rio Grande is ten times greater in some years than in others, and when its waters have been highest there have been great floods in its lower course and so much shifting of its banks as to cause international complications. Even in its course through the Coastal Plain its channel is so much obstructed by sand bars that it is of little importance for navigation. As the increasing diversion of the water of the Upper Rio Grande for irrigation in Colorado and New Mexico resulted in a scarcity of water for this purpose in Mexico, that country complained, and to remedy the evil the Reclamation Service of the United States proposed the construction by the United States of a storage dam across the river near Engle, New Mexico, which would form a storage reservoir having a capacity of 2,000,000 acre-feet and from which Mexico should be furnished with 60,000 acre-feet of water annually. Mexico agreed to this proposal and a treaty covering the matter was proclaimed in January 1907. The principal towns and cities on the river are: Brownsville, Texas; Matamoros, Mexico; Laredo, Texas; El Paso, Texas; and Ciudad Juarez, Mexico.

RIO GRANDE DO SUL, a southern frontier state of Brazil, bounded N. by the state of Santa Catharina, E. by the Atlantic, S. by Uruguay and W. by Uruguay and Argentina—the Uruguay river forming the boundary line with the latter. Area, 91,333 sq. m. Pop. (1900) 1,149,070, an increase of 251,615 since 1890. The northern part of the state lies on the southern slopes of the elevated plateau extending southward from São Paulo across the states of Paraná and Santa Catharina, and is much broken by low mountain ranges whose general direction across the trend of the slope gives them the appearance of escarpments. A range of low mountains extends southward from the Serra do Mar of Santa Catharina and crosses the state into Uruguay. West of this range is a vast grassy plain devoted principally to stock-raising—the northern and most elevated part being suitable in pasture and climate for sheep, and the southern for cattle. East of it is a wide coastal zone only slightly elevated above the sea; within it are two great tide-water lakes—Lagôa dos Patos and Lagôa Mirim—which are separated from the ocean by two sandy, partially barren peninsulas. The coast is one great sand beach, broken only at one point—that of the outlet of the two lakes, called the Rio Grande, which affords an entrance to navigable inland waters and several ports. There are two

distinct river systems in Rio Grande do Sul—that of the eastern slope draining to the tide-water lakes, and that of the La Plata basin draining westward to the Uruguay. Fully one-third of the state belongs to the La Plata drainage basin. The larger rivers of the eastern group are the Jacuhy, Sinos, Cahy, Gravatahy and Camaquã, which flow into the Lagôa dos Patos, and the Jaguarão which flows into the Lagôa Mirim. All of the first named, except the Camaquã, discharge into one of the two arms or estuaries opening into the northern end of Lagôa dos Patos, which is called the Rio Guahyba, though in reality it is not a river. It is broad, comparatively deep and about 35 m. long, and with the rivers discharging into it affords upwards of 200 m. of fluvial navigation. The Jacuhy is one of the most important rivers of the state, rising in the ranges of the Coxilha (Cuchilla) Grande of the North and flowing S. and S.E. to the Guahyba estuary, with a course of nearly 300 m. It has two large tributaries—the Vaccacahy from the S. and the Taquary from the N.—besides many small streams. The Jaguarão, which forms part of the boundary line with Uruguay, is navigable 26 m. up to and beyond the town of Jaguarão. Of the many streams flowing northward and westward to the Uruguay, the largest are the Ijuhy-guaçu, of the plateau region, the Ibicuhy, which has its source in the central part of the state, near Santa Maria, and flows westward to the Uruguay a short distance above Uruguayana and the Quarahim, or Quarahy, which forms part of the boundary line with Uruguay. The Uruguay river itself is formed by the confluence of the Rio das Canoas and Rio Pelotas in about long. $51^{\circ} 30'$ W. With its southern confluent, the Rio Pelotas, which has its source in the Serra do Mar, on the Atlantic coast, it forms the northern and western boundary line of the state down to the mouth of the Quarahim, on the Uruguayan frontier. In addition to the Lagôa dos Patos and Lagôa Mirim there are a number of small lakes on the sandy, swampy peninsulas that lie between the coast and these two, and there are others of a similar character along the northern coast. The largest lake is the Lagôa dos Patos (Lake of the Patos—an Indian tribe inhabiting its shores at the time of the discovery), which lies parallel with the coast-line, N.E. and S.W., and is about 133 m. long exclusive of the two arms at its northern end, 25 and 35 m. long respectively, and of its outlet, the Rio Grande, about 24 m. long. Its width varies from 22 to 36 m. The lake is comparatively shallow and filled with sand banks, making its navigable channels tortuous and difficult. The Lagôa Mirim occupies a similar position farther S., on the Uruguayan frontier, and is about 108 m. long by 6 to 22 m. wide. It is more irregular in outline and discharges into Lagôa dos Patos through a navigable channel known as the Rio São Gonçalo. A part of the lake lies in Uruguayan territory, but its navigation, as determined by treaty, belongs exclusively to Brazil. Both of these lakes are evidently the remains of an ancient depression in the coast-line shut in by sand beaches built up by the combined action of wind and current. They are of the same level as the ocean, but their waters are affected by the tides and are brackish only a short distance above the Rio Grande outlet.

Rio Grande lies within the South Temperate zone and has a mild, temperate climate, except in the coastal zone where it is semi-tropical. There are only two well-marked seasons, though the transition periods between them (about two months each) are sometimes described as spring and autumn. The winter months, June to September, are characterized by heavy rains and by cold westerly winds, called *minuãos*, which sometimes lower the temperature to the freezing point, especially in the mountainous districts. Snow is unknown, but ice frequently forms on inland waters during cold winter nights, only to disappear with the first rays of the sun. In summer, which is nominally a dry season, light rains are common, northerly and easterly winds prevail, and the temperature rises to 95° in the shade. Cases of insolation are not rare. Malaria is unusual and the state has a high reputation for healthiness, though insanitary conditions are responsible for various diseases in large communities.

The principal industry of the state is stock-raising, especially on the southern plains, where large *estancias* (ranches) are to be found. This industry originated with the Jesuit missions on the Uruguay early in the 17th century, and its development here has been much

the same as in Argentina and Uruguay. No general effort was made before the 20th century to improve the herds by the importation of better breeds, and the industry was practically in a state of decay until higher tariff rates were imposed on imported *carne secca* (jerked beef) toward the end of the 19th century. The export of live-stock is insignificant, the practice being to sell the cattle to the *xarqueadas* or *saladeros* where they are slaughtered for *xarque*, *charqui* or *carne secca*, which is usually prepared by salting and drying in the sun. The jerked beef is largely exported to other Brazilian states for consumption, while the hides and other by-products are exported to Europe and the United States. The importance of the industry is shown in the exports of 1905, in kilograms, viz.: jerked beef, 37,555,951; dry tongues, 4,735,987; salted hides, 12,141,779; beef extract, 16,712; ox-hides, 498,577; tallow, 6,174,189; and large quantities of leather, horns, hoofs, bone-ash and preserved meats. Horses, mules, sheep, goats and swine are also raised; the raising of sheep being fostered by the building of woolen factories, and that of swine by the higher duties on imported pork and lard. In some parts of the state agriculture claims much attention, especially in the forested districts of the north where colonies of foreign immigrants have been established. The principal products are wheat, Indian corn, rice, beans, peas, onions, garlic, *farinha de mandioca* (cassava flour), potatoes, tomatoes, cabbage, fruit, tobacco and peanut—all of which find a ready market in the country. Large quantities are grown in several localities (São Leopoldo, Alegrete, Bagé, &c.) for wine-making, and the industry has become important—the export in 1905 being 2,092,417 litres. The forest products include *hera mate* or Paraguay tea (*Ilex paraguayensis*), timbers and lumber, and vegetable fibre (*crina vegetal*). Coal of an inferior quality is mined at São Jerônimo, on a small tributary (Arroio dos Ratos) of the Jacuhy river, and has been discovered in other localities. Lime is burned at Caçapava, and at some other places. Gold, copper and iron are said to exist, but are not mined. Considerable progress has been made in manufacturing industries, among whose products are: woolen, cotton and jute textiles, leather, wheat, flour, boots, shoes and sandals (*tanecas*), wines and liquors, beer, macaroni, biscuits and other prepared foods, cigars and cigarettes, hats, matches, soap, candles and wrapping paper. Much of this diversity in production is due to the foreign element in the population.

The railway lines in the state are: the Porto Alegre to Novo Hamburgo (27 m.), with an extension to Taquary (28 m.); Porto Alegre to Uruguayana, completed from Margem do Taquary (Bank of the Taquary) to Caçequy (232 m.); Santa Maria to Passo Fundo (221 m.); Rio Grande to Bagé (175 m.), with 14 m. in branches at Rio Grande; an extension from Caçequy to Bagé (129 m.) and the Quarahim to Itaquy (109 m.). All these except the last have been taken over by the national government and leased to the Belgians. Compagnie auxiliaire de Chemin de Fer at Brestli, which has undertaken to complete the line from Caçequy to Uruguayana (161 m.), from Margem do Taquary to Neustadt, on the Novo Hamburgo line (60 m.), and some other branches. The Quarahim to Itaquy line belongs to an English company and runs from the Uruguayan frontier, where it connects with the North-Western of Uruguay, northward to Uruguayana and the naval station of Itaquy.

The population in 1900 was 1,149,070. There is a large foreign element: in 1905 the total number of foreigners residing in the state was estimated at 400,000 (not including children born in the country), and of Germans at 250,000. The first German colony was founded in 1824 and settled in 1825 in the rich forested country N. of Porto Alegre, and many large and prosperous communities have been established since then in spite of the wars and political agitations in the state. Several of these colonies, such as São Leopoldo, Novo Hamburgo and Conde d'Eu (now Garibaldi), have become important towns and are no longer under colonial administration. Italian colonies were subsequently established, also with good results, but an Irish colony founded at Monte Bonito, near Pelotas, about 1851, failed completely. The capital of Rio Grande do Sul is Porto Alegre at the northern extremity of Lagôa dos Patos, and its two next most important cities are Rio Grande and Pelotas, both at the southern extremity of the same lake. Among other important cities and towns, with population returns for 1900, are Alegrete (114,438), prettily situated in the W. part of the state on the Porto Alegre to Uruguayana railway; Bagé (13,463), about 173 m. by rail N.W. of Rio Grande in a picturesque mountainous region, 702 ft. above sea-level; Jaguarão (9000), on a river of the same name and opposite the Uruguayan town of Arivas, with steamboat communication with Rio Grande; Caçapava (8781 in 1890) in a fine grazing district in the central part of the state, 1732 ft. above sea-level; Quarahim, or Quarahy (about 6500), a town of much commercial

importance on the Quarahim river opposite the Uruguayan town of Santo Eugenio, and surrounded by a rich grazing country which supports one of the largest *saladeros* in the state; São Leopoldo; Santa Maria da Bocca do Monte; and Uruguayana.

The territory was first settled along the Uruguay river by the Jesuits when they were compelled to abandon their missions on the upper Paraná. Between 1632 and 1707, they founded on the E. side of the Uruguay seven missions—all under Spanish jurisdiction—which became highly prosperous, and at the time of their transfer from Spanish to Portuguese rule by a treaty of 1750 had an aggregate population of about 14,000, living in villages and possessing large herds of cattle and many horses. A joint effort of the two powers in 1753 to enforce the treaty, remove the Indians to Spanish territory, and mark the boundary line, led to resistance and a three years' war, which ended in the capture and partial destruction of the missions. On the coast the first recognized settlement—a military post at Estreito, near the present city of Rio Grande—was made in 1737. Before this, and as early as 1680, according to some chroniclers, the region S. of Santa Catharina was occupied by settlements, or penal colonies, of *degradados* (banished men) and immoral women from Santos, São Vicente and São Paulo, and was known as the "Continente de São Pedro." In 1738 the territory (which included the present state of Santa Catharina) became the Capitania d'El Rei and was made a dependency of Rio de Janeiro. Territorial disputes between Spain and Portugal led to the occupation by the Spanish of the town of Rio Grande (then the capital of the *capitania*) and neighbouring districts from 1763 to 1776, when they reverted to the Portuguese. The capture of Rio Grande in 1763 caused the removal of the seat of government to Viamão at the head of Lagôa dos Patos; in 1773 Porto dos Cazaes, renamed Porto Alegre, became the capital. In 1801 news of war between Spain and Portugal led the inhabitants of Rio Grande to attack and capture the seven missions and some frontier posts held by the Spaniards since 1763; since 1801 the boundary lines established by treaty in 1777 have remained unchanged. The districts of Santa Catharina and Rio Grande had been separated in 1760 for military convenience, and in 1807 the latter was elevated to the category of a *capitania-geral*, with the designation of "São Pedro do Rio Grande," independent of Rio de Janeiro, and with Santa Catharina as a dependency. In 1812 Rio Grande and Santa Catharina were organized into two distinct *comarcas*, the latter becoming an independent province in 1822 when the empire was organized. In 1835 a separatist revolution broke out in the province and lasted ten years. It was reduced more through the use of money and favours than by force of arms; but the province had suffered terribly in the struggle and did not recover its losses for many years. An incident in this contest was the enlistment of Garibaldi for a short time with the forces of the separatists. In 1865 a Paraguayan army invaded the state and on the 5th of August occupied the town of Uruguayana. On the 18th of September following, the Paraguayan general (Estigarribia) surrendered without a fight—an unusual occurrence in the remarkable war that followed. Political agitations have been frequent in Rio Grande do Sul, whose people have something of the temperament of their Spanish neighbours, but no important revolution occurred after the "ten years' war" (1835-45) until the presidency at Rio de Janeiro of General Floriano Peixoto, whose ill-considered interference with the state governments led to the revolt of 1892-94, under Gumerindo Saraiva. In this struggle the revolutionists occupied Santa Catharina and Paraná, capturing Curitiba, but were eventually overthrown through their inability to obtain munitions of war. An incident in this struggle was the death of Admiral Saldanha da Gama, one of the most brilliant officers of the Brazilian navy and one of the chiefs of the naval revolt of 1893-94, who was killed in a skirmish on the Uruguayan frontier at the close of the war.

RIO GRANDE DO SUL, or **SÃO PEDRO DO RIO GRANDE DO SUL** (sometimes **SÃO PEDRO** and commonly **RIO GRANDE**), a city and

port of the state of Rio Grande do Sul, Brazil, on the western side of the Rio Grande (as the outlet of the Lagôa dos Patos is called), about 6 m. from its mouth and nearly 780 m. S.W. of Rio de Janeiro, in lat. 32° 7' S., long. 52° 8' W. Pop. (1890) of the município (area, about 626 sq. m.) 24,653; of the city, including its suburbs, 20,103; (1900, estimate) of the city, 22,000, and of the city and its suburbs, 30,000. Rio Grande is the coast terminus of the Rio Grande to Bagé railway, which now forms part of the railway system of the state leased to the Belgian Compagnie Auxiliaire de Chemin de Fer au Brésil. Some of the principal streets are served by tramways, and the Rio Grande to Bagé railway has an extension to its shipping wharf called "Estação Marítima" (1½ m.), a branch to some points on the river (1½ m.), and a branch to Costa do Mar, on the ocean coast (11 m.). The city is a port of call for several steamship lines, and has direct communication with European ports. The bar at the mouth of the river, however, restricts traffic to vessels of light draught, not exceeding 12 to 15 ft. Extensive improvements, at an estimated cost of about 13½ millions of dollars, were undertaken in 1908 for deepening the bar to admit vessels of 30 ft. draught.

The city is built on a low sandy peninsula, barely 5 ft. above sea-level, formed by two arms of the Rio Grande projecting westward from the main channel, the peninsula being part of a large sandy plain extending southward along the coast to Lagôa Mirim. The level of the plain is broken by ranges of sand dunes, some of which rise not far from the city on the south-and south-east. The openness of the surrounding country and the proximity of the sea give to Rio Grande unusually healthy conditions, which, however, are largely counteracted by defective sanitary arrangements. Not infrequently the deaths exceed the births, and epidemics of contagious diseases make deadly inroads upon the population. The city has been developed irregularly, but the streets are for the most part broad, and the principal ones are well paved. Gas lighting was introduced about 1871, and in 1908 acetylene was used for public lighting. In one of the public squares is a shaft commemorating the abolition of slavery, and said to be the only monument in Brazil of that character. There is a notable scarcity of shade trees in the streets and squares, though flowers, shrubbery and some kinds of fruit trees are grown. In pleasing contrast to the drifting sands which surround the city is the fertile Ilha dos Marinheiros (Sailor's Island) lying directly in front of the port; it is highly cultivated and supplies the market with fruit and vegetables. The water-front has been improved by substantial stone walls, which permit the mooring of light-draught vessels alongside.

Among noteworthy public buildings and institutions are the municipal palace, the parochial church of São Pedro, dating from the 18th century, the modern church of N.S. de Bomfim, the beautiful Protestant, Episcopal church (Gothic), the public hospital (Hospital de Caridade), the hospital of the Beneficência Portuguesa, the public library (Bibliotheca Riograndense), created and maintained by private effort and containing about 30,000 volumes, the old custom-house and the *quartel-geral* (military barracks). Rio Grande is wholly a commercial and industrial city. Its exports include salted jerked beef (*carne secca*, or *sarque*), preserved meats, tongues, hides, horns, hoofs, woollen fabrics, Paraguay tea, beans, onions, fruit, flour, *farinha de mandioca* (cassava flour), lard, soap, candles and leather. Its manufactures include cotton, woollen and jute fabrics, wheat flour, biscuits, cigars and cut tobacco, beer, artificial drinks, boots, shoes and sandals (*stipetagos*), soap and candles, fireworks, ice, earthenware, hats, cast-iron and leather. The pioneer woollen factory in Brazil, and one of the largest in the country, is in Rio Grande.

Rio Grande was founded in 1737 by José da Silva Paes, who built a fort on the river near the site of the present city and called it Estreito. In 1745 the garrison and settlement was removed by Gomes Freire d'Andrade to its present site, which became a "villa," in 1751, with the name of São Pedro do Rio Grande, and a "cidade" (city) in 1807. It was the capital of the captaincy down to 1763, when it was captured by a Spanish force from Buenos Aires under the command of its governor, Don Pedro Zeballos, the seat of government being then removed to Viamão at the northern end of Lagôa dos

Patos. The city was occupied by the national forces in the ten years' war which began in 1835, and in 1894 it was unsuccessfully besieged by a small insurgent force that had attempted to overthrow the government at Rio de Janeiro.

RIOJA, LA, an Andine province of Argentina, bounded N. by Catamarca, E. by Catamarca and Cordoba, S. by San Luis and San Juan and W. by San Juan and Chile. Area, 34,546 sq. m. Pop. (1895) 69,502; (1902, estimate) 82,090. The province is traversed from N. to S. by eastern ranges of the Andes and is separated from Chile by the Cordillera itself. The western part of the province is drained by the Bermejo, which flows southward into the closed lacustrine basin of Mendoza. The eastern side of the province is arid, but in the extreme N. some small streams flow northward into Catamarca. The scanty waters of these streams are used for irrigation purposes. The principal industry of the province is that of mining, its mineral resources including gold, silver, copper, nickel, tin, cobalt, coal, alum and salt. Its best known mines are those of the Sierra de Famatina, 16,400 ft. above sea-level, where an aerial wire line is used for transportation to Chilecito in the valley below. The development of mining industries is seriously hindered by lack of water. For the same reason, agriculture is in a very backward condition. The climate is hot and dry, and there is no cultivation of the soil except in the valleys of the Cordillera and a few other places where irrigation is possible. Under these conditions, there are grown wheat (a limited extent), grapes, oranges, olives and tobacco. Alfalfa is grown to a considerable extent and is used for feeding the herds of cattle driven across country to Chile. The capital of the province is La Rioja (pop., 1904, about 6000), on the eastern flank of the Sierra de Velasco, about 1770 ft. above sea-level and near the gorge of Sanagasta, through which a small stream, also called Rioja, flows northward and affords water for the gardens, vineyards and orchards that surround it. The wines of Rioja are highly esteemed and are an important source of income for the district. The town is connected by rail with Cordoba and Catamarca. It was founded in 1591 by Velasco and in 1894 was destroyed by an earthquake from which it has only partially recovered. The most important town in the province is the mining centre of Chilecito, or Villa Argentina (pop., 1904, about 4000), about 2950 ft. above sea-level near the Famatina mines.

RIOM, a town of central France, capital of an arrondissement in the department of Puy-de-Dôme, 8 m. N. by E. of Clermont-Ferrand by rail. Pop., town, 7839; commune, 10,627. Riom is situated on the left bank of the Ambène, on an eminence rising above the fertile plain of Limagne. It is surrounded with boulevards and has wide streets, but the houses, being built of black lava, have a sombre appearance. Some belong to the 15th and 16th centuries, and have turrets and carved stonework. The church of St Amable, of Romanesque and early Gothic architecture, dates from the 12th century, but has been restored in modern times. It has fine carved woodwork of the 17th century. The church of Notre-Dame du Marthuret (15th century) has a well-known statue of the Virgin at its western entrance. The Sainte-Chapelle of the 14th and 15th centuries is a relic of the palace of Jean de Berry, duke of Auvergne, and contains fine stained glass. Near it stands a statue of the chancellor Michel de l'Hôpital, who was born near Riom. The rest of the site of the palace is occupied by the law courts. Other interesting buildings are the belfry of the 16th century and a mansion of the same period known as the Maison des Consuls. The town possesses numerous fountains, some of which are of the Renaissance period.

Riom is the seat of a court of appeal, a court of assizes and a sub-prefect, and has tribunals of first instance and commerce and a communal college. It has a state manufactory of tobacco, and carries on the preparation of fruit preserves. Trade is in grain, wine, vegetables, fruit, nut-oil and Volvic stone.

Riom (*Ricomagus* or *Ricomum* of the Romans) was long the rival of Clermont. Along with Auvergne it was seized for the crown by Philip Augustus, and it was the capital of this province under the dukes of Berry and Bourbon.

RIO NEGRO, a territory of Argentina lying between the Colorado river and the 42nd parallel S. lat., within the geographical area formerly known as Patagonia, bounded N. by the territories of Neuquen and La Pampa, E. by the province of Buenos Aires and the Atlantic, S. by the territory of Chubut and W. by Chile and Neuquen. Area, about 75,924 sq. m.; pop. (1895) 9241; (1904, estimate) 18,648. That part of it lying between the Colorado and Negro rivers has much of the formation and characteristics of the "sterile pampas," but with irrigation the greater part of it can be utilized for agriculture and grazing. South of the Negro the country is arid, barren and lies in great shingle-covered terraces sloping eastward to the Atlantic; its larger part is practically uninhabitable, only the river valleys and the foot-hills of the Andes having a regular water supply. The rivers of the territory are the Colorado, which forms a part of its northern boundary, and the Negro, formed by the confluence of the Limay (which forms part of the western boundary) and Neuquen on the boundary between Rio Negro territory and the territory of Neuquen. These rivers have no tributaries of importance within the territory, but the Limay receives some small streams from the Andean slopes. Lake Nahuel-Huapi lies partly in this territory (see *NEUQUEN*), and there are several small lakes scattered over the shingly steppes. The Atlantic coast-line of the territory has one deep indentation—the Gulf of San Matias—but, owing to the arid surroundings, there are no ports or towns upon it. The only industry of importance is grazing, cattle being raised for export to Chile, and a few sheep for their wool. The capital is Viedma (pop. in 1895, estimate, 1500), on the right bank of the Rio Negro, 22 m. from its mouth and opposite Carmen de Patagones, a town and port of Buenos Aires. There are other small settlements on the Rio Negro, which is navigable up to the Neuquen frontier (about 450 m.), but the only place of importance is General Roca (about 2300), a military and supply station situated a few miles below the confluence of the Limay and Neuquen rivers and connected with Bahia Blanca and Buenos Aires by a branch of the Great Southern railway.

RIO PARDO (formerly Villa do Rio Pardo), a town of Brazil in the state of Rio Grande do Sul, on the left bank of the Jacuchy at its confluence with the Pardo. Area (of the municipality) 1737 sq. m. Pop. (1890) of the municipality, 19,346; (1908, estimated) of the town, 3500. The town is about 80 m. due west of Porto Alegre, with which it is connected by rail and steamer. The Jacuchy is navigable by small steamers to this place, which was once an important military station and commercial centre. Its military importance has considerably declined through railway extension. The surrounding districts are fertile but only slightly cultivated, and stock-raising is its chief industry. The town had its origin in a frontier fort built at this point by the Portuguese in 1751, but did not reach the dignity of a "villa" until 1809.

RIOT (O. Fr. *riote*, of uncertain etymology), the gravest kind of breach of the peace, short of treason, known to the English law. It consists in a tumultuous disturbance of the peace by an assemblage of three or more persons who, with intent to help one another against any one who opposes them in the execution of some enterprise, actually execute that enterprise in a violent and turbulent manner, to the terror of the people. It is not necessary that violence should be used to any person or damage done to any property. Whether the enterprise itself is lawful or unlawful is not material, the gist of the offence lying in the mode in which the enterprise is carried out (*The Trafalgar Square Riots*, 1888, 16 Cox. Cr. Cas. 420, 427; Stephen, *Dig. Crim. Law*, 6th ed., art. 77). Nor is it material whether the enterprise is of a private or a public nature, though in the latter case the rioters may also be guilty of sedition or treason. An assembly in its inception perfectly lawful may become a riot if the persons assembled proceed to form and execute a common purpose in the manner above stated, although they had no such purpose when they first assembled. Riot differs from "Affray" in the number of persons necessary to constitute the offence, from an "Unlawful Assembly" in that actual tumult or violence is an

essential element, and from "Rout," which may be described as a beginning or endeavour to create a riot. It was considered as early as the 14th century that the English common law gave an insufficient remedy against riot. In 1360 the statute of 34 Edward III. gave jurisdiction to justices to restrain, arrest and imprison rioters. In 1393 the statute of 17 Richard II. conferred similar powers on the sheriff and *posse comitatus*. Numerous other acts extending the common law were passed, especially in the Tudor reigns (see Stephen, *History of the Criminal Law*, vol. i. p. 202). Both these acts above mentioned are still on the statute book, but the earliest act now in force of real importance as to this offence is the Riot Act (1716), which creates certain statutory offences for riot attended by circumstances of aggravation. That act makes it the duty of a justice, sheriff, mayor or other authority, wherever twelve persons or more are unlawfully, riotously and tumultuously assembled together, to the disturbance of the public peace, to resort to the place of such assembly and read the following proclamation: "Our Sovereign Lord the King chargeth and commandeth all persons being assembled immediately to disperse themselves, and peaceably to depart to their habitations or to their lawful business, upon the pains contained in the act made in the first year of King George for preventing tumultuous and riotous assemblies. God save the King." It is a felony to obstruct the reading of the proclamation or to remain or continue together unlawfully, riotously and tumultuously for one hour after the proclamation was made or for one hour after it would have been made but for being hindered. The act requires the justices to seize and apprehend all persons continuing after the hour, and indemnifies them and those who act under their authority from liability for injuries caused thereby. The punishment for the felony is penal servitude for life or for a term of not less than three years, or imprisonment with or without hard labour for not more than two years. Prosecutions for an offence against the act must be commenced within twelve months after the offence.

By s. 11 of the Malicious Damage Act 1861 (which is a re-enactment of a similar provision made in 1827 in consequence of the frame-breaking riots), it is a felony for persons riotously and tumultuously assembled together to the disturbance of the public peace to unlawfully and with force demolish or begin to demolish or pull down or destroy any building, public building, machinery or mining plant. The punishment is the same as for a felony under the Riot Act. By s. 12 it is a misdemeanour to injure or damage such building, &c. The punishment is penal servitude from three to seven years, or imprisonment as in the case of the two felonies above described. Under the Shipping Offences Act (1793) a riotous assemblage of three or more seamen, ship's carpenters and other persons, unlawfully and with force preventing and hindering or obstructing the loading or unloading or the sailing or navigation of any vessel, or unlawfully and with force boarding any vessel with intent to prevent, &c., is punishable on a first conviction as a misdemeanour by imprisonment from six to twelve months, and on a second conviction as a felony by penal servitude from three to fourteen years. And under the Offences against the Person Act 1861 (s. 40) summary penalties are provided for forcible interference with seamen in the exercise of their lawful occupation.

Besides these enactments there are others aimed at similar offences, such as smuggling, forcible entry and detainer, tumultuous petitioning (1661, 13 Charles II.), holding large political meetings within a certain distance of Westminster Hall during the sitting of parliament (Seditious Meetings Act 1817). For these offences see Stephen, *Dig. Cr. Law*, 6th ed., arts. 81-87.

It is the duty of a magistrate at the time of a riot to assemble subjects of the realm, whether civil or military, for the purpose of quelling the riot. In this duty he is aided by the common law, and a statute of 1414 (Henry V.), under which all subjects of the realm are bound to assist on reasonable warning, and by various enactments enabling the authorities to call out the

militia, yeomanry and reserve forces for the suppression of riot, and to close public-houses where a riot is apprehended (Licensing Act 1872). It is his duty to keep the peace; if the peace be broken, honesty of intention will not avail him if he has been guilty of neglect of duty. The question is whether he did all that he knew was in his power and which could be expected from a man of ordinary prudence, firmness and activity. The law as thus stated is gathered from the opinions of the judges on the trials of the lord mayor of London and the mayor of Bristol on indictments for neglect of duty at the time of the Gordon riots of 1780 and the Bristol riots in 1831.¹ In addition to his liability to an indictment at common law, a defaulting magistrate is subject under the provisions of acts of 1411 (Henry IV.) and 1414 (Henry V.) to a penalty of £100 for every default, the default to be inquired of by commission under the great seal. A matter of interest is the extent of the protection afforded by the Riot Act to soldiers acting under the commands of their officers. The question was dealt with by Lord Bowen and his fellow-commissioners in the report on the Featherstone riots (Parl. Paper, 1893-1894, c. 7234). The substance of their views is as follows:—

By the law of England every one is bound to aid in the suppression of riotous assemblages. The degree of force, however, which may be lawfully employed in their suppression depends on the nature of each riot, for the force used must always be moderated and proportioned to the circumstances of the case and to the end to be attained. The taking of life can only be justified by the necessity for protecting persons or property against various forms of violent crime, or by the necessity of dispersing a riotous crowd which is dangerous unless dispersed, or in the case of persons whose conduct has become felonious through disobedience to the provisions of the Riot Act, and who resist the attempt to disperse or apprehend them. The necessary prevention of such outrage on person or property justifies the guardians of the peace in the employment against a crowd of even deadly weapons. Officers and soldiers are under no special privileges and subject to no special responsibilities as regards the principle of the law. A soldier for the purpose of establishing civil order is only a citizen armed in a particular manner. He cannot because he is a soldier be exonerated if without necessity he takes human life. The duty of magistrates and peace officers to summon or abstain from summoning the assistance of the military depends in like manner on the necessities of the case. A soldier can act only by using his arms. The weapons he carries are deadly. They cannot be employed at all without danger to life or limb, and in these days of improved rifles and perfected ammunition without some risk of danger to distant and possibly innocent bystanders. To call for assistance against rioters from those who can interfere only under such grave conditions ought, of course, to be the last expedient of the civil authorities. But when the call for help is made and a necessity for assistance from the military has arisen, to refuse such assistance is in law a misdemeanour. The whole action of the military when once called in ought from first to last to be based on the principle of doing, and doing without fear, that which is absolutely necessary to prevent serious crime, and of exercising care and skill with regard to what is done. No set of rules exists which governs every instance or defines beforehand any contingency that may arise. The presence of a magistrate is not essential, but is usual, and of the highest value to aid the commander of the troops by local knowledge. But his presence or absence has no legal effect on the duties or responsibilities of the military to use their arms when it becomes necessary to do so, and without recklessness or negligence and with reasonable care and caution; and where they have so acted the killing of a rioter is justifiable homicide, and the killing of an innocent bystander is homicide by misadventure. It is not usual to resort to extremities with rioters until after reading the proclamation under the Riot Act (1716),

¹ Reports of these trials will be found in the State Trials, New Series, vol. iii, pp. 1, 11. Most of the important cases of riot are collected or referred to in that series.

but this preliminary is by no means a condition precedent to the exercise of the common-law powers of suppressing riots.

The crown cannot charge upon the local rates the expense of maintaining soldiers called into a district by the magistrates to suppress a riot (*re* Glamorgan County Council, L.R. 1809, 2 Q.B. 536); but the cost of extra police drafted in for the like purpose falls on the rates of the district into which they are drafted (see Police Act 1890, s. 25). Until 1886 persons whose property was damaged by riot had a civil remedy of an exceptional character by action against the hundred in which the riot took place. This remedy was a survival of the pre-Conquest liability of the hundred to guarantee the orderly conduct of its inhabitants. The hundred was made liable in case of robbery by the Statute of Winchester (1285).¹ That and subsequent acts were repealed in the reign of George IV., and their provisions were consolidated by an act of 1827 which gave a remedy against the hundred in the case of felonious demolition of churches, chapels, houses, machinery, &c., being feloniously demolished by rioters. The last instance of the use of this exceptional remedy was in the case of a riot at Worthing, and the remedy was abolished in 1886. When the Piccadilly riots occurred in that year no one knew that the injured shops were in the hundred of Ossulston, and difficulties arose in applying the old procedure. So an *ex post facto* statute was passed (the Metropolitan Police Compensation Act 1886) for a special settlement of the claims, and the old statutes were repealed and replaced by the Riot Damage Act 1886. Under this act compensation is payable where rioters have injured or destroyed houses, shops, buildings, fixed or movable machinery and appliances prepared or used for or in connexion with manufactures or agriculture, or for mines or quarries, or vessels stranded or in distress (see *WRECK*), or have injured, stolen, or destroyed property in houses, shops or buildings. The compensation is payable out of the police rate for the district in which the damage is done; or if it was done afloat, for the district nearest to the scene of action. The claim is made on the police authority for the district. The time and form for making claims and the mode of fixing the amount of compensation is regulated by rules made by the Home Secretary on the 30th of June 1894 (Stat. R. and O. 1894, No. 636). In adjusting the amount regard is had to the conduct of the claimant, viz. as to precautions taken by him, his share, if any, in the riot, or provocation offered to the rioters. Failure to carry out a programme for athletic sports has been held to debar a claimant from compensation for damage done by a riot among the disappointed spectators who had paid to see the sports. The claimant must give credit for insurance money, or any other compensation received in respect of the damage; but the insurers or persons who paid such compensation may file a claim against the police rate for the amount paid by them. Persons dissatisfied with the award of the police authority may sue for the recovery of their claim subject to a liability to pay all the costs if they do not get judgment for more than the amount awarded. The action, if it is not for more than £100, is to be brought in the county court. The remedy is available in the case of stranded ships plundered by rioters (s. 515 of the Merchant Shipping Act 1894).

The Riot Act does not extend to Ireland, but similar provisions are contained in an act of the Irish Parliament passed in 1787 as amended by acts of 1831 and 1842. These acts create a special offence punishable by penal servitude for life, viz. sending notices, letters or messages inciting or tending to riot. Under the Criminal Procedure Ireland Act 1887 (a temporary act) summary proceedings may be taken against rioters. The civil remedy against the county or borough for malicious injury to property, real or personal, including ships in distress and their cargo, is wider than in England or Scotland, but it includes malicious injury by rioters where

¹ There is a curious exception still on the Statute-book depriving persons robbed while travelling on the Lord's Day of any right to compensation from the hundred (Lord's Day Act 1677, s. 5).

the injury is a crime within the Malicious Damage Act of 1861. Claims are now dealt with in the county court, and not as formerly by the grand jury and judge of assize (Local Government Ireland Act 1898, s. 5).

In Scotland a riot may be either "rioting and mobbing" or "rioting and breach of the peace." The first is much the same as riot in English law. Mobbing consists in the assembling of a number of people and then combining against order or peace to the alarm of the lieges (Alison, *Cr. Law of Scotland*, vol. i. p. 509; Macdonald, *Criminal Law*, 180). The second offence occurs when concourse or a common purpose are wanting. Numerous acts against rioting and unlawful convocation were passed by the Scottish parliament, beginning in 1487. The Riot Act (1716) applies to Scotland. There is a civil remedy against the county or burgh in which a riot takes place in respect of damage done by the rioters to houses, churches, buildings and ships, and buildings or engines used in trade or manufacture. The remedy is given by a series of statutes of 1716, 1812, 1816, 1817 and 1894. The procedure for its enforcement is now regulated by the Riotous Assemblies (Scotland) Act 1822, and amending statutes. The county or burgh authorities may adjust claims without litigation, and pay them out of the general assessments.

British Dominions.—In India the offence of riot, as defined by s. 146 of the Penal Code, consists in the use of force or violence by an unlawful assembly (which must consist of at least five persons, s. 141), or by any member thereof in the prosecution of the common object of such assembly (see *Mayne, Ind. Criminal Law*, ed. 1896, p. 489). In Ceylon and the Straits Settlements provisions based on the Indian Code are in force. In most of the settled Colonies the English law as to riot applies subject to local legislation. The Criminal Codes of Canada (1892, ss. 70-86), New Zealand (1893, ss. 83-89) and Queensland (1899, ss. 61-67) adopt the substance of the English law as to riot, in terms borrowed from the English draft Code of 1880. In those of the West Indies whose common law is based on that of France, Holland or Spain, the English law as to riot has been applied by ordinance, e.g. in British Guiana (Criminal Code 1893, tit. xix), and St Lucia (Criminal Code 1888, tit. xxv). In the South African colonies the English law of riot does not apply, but under the Dutch Roman law there exists a similar offence, known as "public violence" (*vis publica*), i.e. the use of violence and force by which the public rest and order is endangered and the authority of the lawful authorities and officials is set at naught. The offence was capital (see Van Leeuwen, *Roman-Dutch Law*, tr. by Kotze, 1886, vol. ii. p. 294; Morice, *English and Roman-Dutch Law*, 1903, p. 334). Similar provisions based on the French Penal Code are in force in Mauritius (Penal Code of 1838).

United States.—In the United States the law is based upon that of England (see Bishop, *Amer. Cr. L.*, 8th ed., 1892, vol. i. s. 534, vol. ii. ss. 1143 et seq.). In some states there is a statutory proclamation for the dispersion of rioters in terms almost identical with those of the British Riot Act. The city, town, or county is by the statutes of many states rendered liable for damage caused by rioters, with or without a remedy over against the persons who did the damage (see revised Laws of Massachusetts, ed. 1902, chap. 211, sects. 2, 8).

RIO TINTO (MINAS DE RIO TINTO), a mining town of south-western Spain, in the province of Huelva; near the source of the river Tinto, and at the terminus of a light railway from the port of Huelva. Pop. (1900) 11,603. Rio Tinto is one of the greatest copper-mining centres in the world; and it is from the discoloration of its waters by copper ore that the river derives its name. Besides the town of Minas, several villages are peopled by the native miners, whose numbers exceed 10,000; and one is occupied solely by British mine officials. The surrounding country is covered for miles with heaps of slag, and has been reduced to a desert. In 1903 the output of the mines included 840,000 tons of copper ore, worth more than £500,000, besides a relatively small quantity of iron and manganese. Almost the entire product is despatched to Huelva for shipment to Great

Britain. Rio Tinto was probably first exploited by the Carthaginians; vestiges of later Roman workings may still be seen. After the Moorish conquest, in 711, it was neglected until 1725, when the mines were leased to a Swede named Wolters. Their modern importance dates from 1872, when a syndicate of London and Bremen capitalists purchased them from the Spanish government for nearly £4,000,000.

RIOU, EDWARD (1758?–1801), British sailor, entered the navy at an early age. In 1780 he was promoted lieutenant, and nine years later he was in command of the "Guardian" when that vessel, crowded with convicts, struck a hidden rock off the African coast. Riou, after parting with as many of his men as the boats would hold, not only successfully navigated his half-sinking ship 400 leagues to the Cape of Good Hope, but kept order amongst the panic-stricken convicts, an achievement which had few parallels in naval annals, and won Lieutenant Riou's immediate promotion. He did not long remain a commander and in 1791 he was posted. Under Sir John Jervis he was present at the operations about Martinique and Gadeloupe in 1794, and in the "Amazon" he accompanied the expedition under Sir Hyde Parker to the Baltic in 1801. His frigate led the way through the Channel at Copenhagen, and in the battle he was attacked as commodore of a light squadron to Nelson's division. Through the grounding of three ships of the line, Riou and his frigates found themselves opposed to the full force of the great Trekroner battery. Early in the fight he was wounded, but refused to leave the deck, and, as he was sitting on a gun-carriage and directing his men's fire, he was cut in two by a cannon ball. Nelson, who had not known him before this expedition, had conceived a great affection for Riou, and spoke of his loss as "irreparable." Brenton, the naval historian, declared that he had all the qualities of a perfect officer. Parliament commemorated the memory of the "gallant good Riou" by a memorial in St Paul's Cathedral.

RIOUW, RHOOW or BINTANG, an archipelago of the Dutch East Indies, E. of Sumatra, and separated from the Malay Peninsula by the Straits of Singapore. With the Lingga, Karim, Tambelan, Anambas and Natuna Islands, to the N.E., E. and S., and the territory of Indragiri in Sumatra, it forms the Dutch residency of Riouw and dependencies. The seat of government is at Tanjung Pinang, a small port of 4000 inhabitants (including 160 Europeans and about 2000 Chinese), on the S.W. coast of the chief island, Bintang or Riouw. The total area of the residency is about 17,550 sq. m., and its population (1905) 112,216, of whom considerably over a quarter are Chinese. These cultivate gambier and pepper successfully in Bintang, and there is a considerable trade in wood. Bintang has an area of about 440 sq. m., and is surrounded by many rocks and small islands, making navigation dangerous. The soil is not fertile, and much of it is swampy. There is an assistant residency of Lingga, to which belongs the island of Singkep, where extensive tin-deposits are worked. Geologically the Riouw and Lingga Islands are appendages of the Malay Peninsula, not of Sumatra. Bintang is mentioned by Marco Polo under the name of *Pentam*, which is not far from the genuine Malay name *Benān*, said to mean a half-moon. After the Portuguese conquest of Malacca (1511), the expelled Mahomedan dynasty took up its residence on Bintang, where it long fostered piracy.

RIPLEY, GEORGE (1802–1880), American critic and man of letters, was born at Greenfield, Massachusetts, on the 3rd of October 1802. He graduated first in his class at Harvard in 1823. From 1826 to 1840 he was pastor of a Unitarian church in Boston, subsequently retiring from the active ministry altogether. It was during those years that there grew up in New England that form of thought or philosophy known as Transcendentalism. Ripley was prominent, if not the leader, in all practical manifestations of the movement; and it was largely by his earnestness and practical energy that certain of its more tangible results were brought about. The first meeting of the Transcendental Club was held at his house in September 1836. He was a founder and a chief supporter of the magazine, the *Dial*, which was the organ of the school from 1841 to 1844. Most

important of all, however, he was the originator of "The Brook Farm Institute of Education and Agriculture." Until the abandonment of this experiment in 1847, Ripley was its leader, cheerfully taking upon himself all kinds of tasks, teaching mathematics and philosophy in the school, milking cows and attending to other bucolic duties, and after June 1845 editing the weekly *Harbinger*, an organ of "association," which he continued to edit in New York from 1847 until it was discontinued in 1849. The failure of Brook Farm (*q.v.*) left Ripley poor and feeling keenly the defeat of his project; but the event forced him at last to devote himself to that career of literary labour in which the real success of his life was achieved. In 1849 he joined the staff of the *New York Tribune*, and in a short time became its literary editor. This position, which, through his steadiness, scholarly conservatism and freedom from caprice as a critic, soon became one of great influence, he held until his death in New York City on the 4th of July 1880.

During the greater part of the time of his connexion with the *Tribune*, Ripley was also an adviser of a prominent publishing house, an occasional contributor to the magazines, and a co-operator in several literary undertakings. The chief of these was the *American Cyclopaedia*, which as the *New American Cyclopaedia*—so named to distinguish it from Francis Lieber's *Encyclopaedia Americana*—was issued, under the editorship of Ripley and Charles A. Dana, in 1857–63, a revised edition, with the word "new" dropped from the title, being issued under the same editorship in 1873–76. He also issued, in translation, a series of *Specimens of Foreign Standard Literature* (14 vols., 1838–42). Ripley was twice married, first in 1827 to Miss Sophia Willard Dana (d. 1861), a daughter of Francis Dana and a conspicuous figure at Brook Farm; and second, in 1865, to a young German widow, Mrs Augusta Schlossberger, who survived him and subsequently married Alphonse Pinede.

A biography of Ripley (Boston, 1882), written by the Rev. O. B. Frothingham, forms one of the volumes of the "American Men of Letters" series. (E. L. B.)

RIPLEY, a market town in the Ilkeston parliamentary division of Derbyshire, England, 10 m. N. by E. of Derby, on a branch of the Midland railway. Pop. of urban district (1901) 10,111. It lies on high ground between the valleys of the Derwent and the Erewash. In the neighbourhood there are extensive collieries, and coke is largely manufactured. Besides iron foundries, blast furnaces and boiler works, the town possesses silk and cotton mills. The charter for the market was granted by Henry III. The district has a large industrial population. To the west of Ripley lies the township of HEAGE (pop. 2886).

RIPON, GEORGE FREDERICK SAMUEL ROBINSON, 1ST MARQUESS OF (1827–1900), British statesman, only son of the 1st earl of Ripon and his wife Lady Sarah, daughter of Robert Hobart, 4th earl of Buckinghamshire, was born in London on the 24th of October 1827. The Robinson family was descended from an eminent Hamburg merchant, William Robinson (1522–1616), who represented York in parliament in Elizabeth's reign. His great-grandson was in 1660 created a baronet. Thomas Robinson, 1st Baron Grantham (1605–1770), son of a later holder of the baronetcy, was created a peer in 1761, having been an indefatigable diplomatist plenipotentiary at the peace of Aix-la-Chapelle, and secretary of state. The 2nd Baron Grantham (1738–1786), ambassador at Madrid, and foreign secretary under Lord Shelburne, had two sons. The elder of these, succeeding as 3rd Baron Grantham (1781–1850), became in 1833 2nd Earl de Grey, in right of his maternal aunt, and assumed the surname of de Grey; he was lord-lieutenant of Ireland (1841–44). The younger, Frederick John (1782–1850), created Viscount Goderic in 1827 and earl of Ripon in 1833, was the well-known "Prosperity Robinson" who was chancellor of the exchequer from 1823 to 1827; as Lord Goderic he became prime minister (and a peculiarly weak one) from August 1827 to January 1828, colonial secretary in 1831 and 1832, lord privy

seal (1833-34), president of the Board of Trade (1841-43), and president of the India board (1843-46).

His son, the future marquess, began his political life as *attaché* to a special mission to Brussels in 1849. In 1851 he married Henrietta Vyner (d. 1907), and their eldest son, afterwards known as Earl de Grey, was born in 1852. Under his courtesy title of Viscount Goderich he was returned to the House of Commons for Hull in 1852 as an advanced Liberal. In 1853 he was elected for Huddersfield, and in 1857 for the West Riding of Yorkshire. In January 1859 he succeeded to his father's title, and in November of the same year to that of his uncle, Earl de Grey. A few months after entering the Upper House he was appointed under-secretary for war, and in February 1861 under-secretary for India. Upon the death of Sir George Cornwall Lewis in April 1863 he became secretary for war, with a seat in the cabinet. In 1866 he was appointed secretary of state for India. On the formation of the Gladstone administration in December 1868, Lord Ripon was appointed lord president of the council, and held that office until within a few months of the fall of the government, in 1873, when he resigned on purely private grounds. In 1869 he was created a Knight of the Garter. In 1871 Lord Ripon was appointed chairman of the High Joint-Commission on the Alabama claims, which arranged the treaty of Washington. In recognition of his services he was elevated to a marquessate (1871). In 1874 he became a convert to Roman Catholicism, and this involved his resignation of the office of grand master of the English Freemasons. On the return of Gladstone to power in 1880 Lord Ripon was appointed viceroy of India, the appointment exciting a storm of controversy, the marquess being the first Roman Catholic to hold the viceregal office. He went out to reverse the Afghan policy of Lord Lytton, and Kandahar was given up, the whole of Afghanistan being secured to Abdur Rahman. The new viceroy was also called upon to decide grave questions between the native population and the resident British, and he resolved upon a liberal policy towards the former, among his measures being the repeal of the Vernacular Press Act, the extension of local government and the appointment of an Education Commission. He extended the rights of the natives, and in certain directions curtailed the privileges of Europeans. Several of the viceroy's measures, notably the Ilbert Bill of 1883—so named after its author Sir Courtenay Ilbert—irritated the Anglo-Indian population, and it was fiercely assailed. The purpose of this bill was disclosed in the statement that "the government of India had decided to settle the question of jurisdiction over European British subjects in such a way as to remove from the code, at once and completely, every judicial disqualification which is based merely on race distinctions," in fact to subject Europeans in certain cases to trial by native magistrates. This announcement raised a storm of indignation among the European community in India, and the government were obliged virtually, though not avowedly, to abandon their measure. Act III. of 1884 was a compromise, which, while subjecting Europeans to the jurisdiction of native district magistrates or sessions judges, reserved to them the right to demand trial by a jury which at least half should be Europeans. There probably never was a viceroy so unpopular among Anglo-Indians or so popular with the natives. On Lord Ripon's departure from India in November 1884 there were extraordinary manifestations in his favour on the part of the Hindu population of Bengal and Bombay, and more than a thousand addresses were presented to him. On his arrival in England the marquess delivered a number of vigorous speeches in defence of his administration. In 1886 he became first lord of the admiralty in the third Gladstone ministry; and on the return of the Liberals to power in 1892 he was appointed colonial secretary, which post he continued to hold until the resignation of the government in 1895. He was included in Sir Henry Campbell-Bannerman's cabinet at the close of 1905 as lord privy seal, an office which he retained in 1908 when Mr Asquith formed his new ministry, but which

he resigned later in the same year. He died at his seat, Studley Royal, near Ripon, on the 9th of July 1909, when his only son, Earl de Grey, who has been treasurer of the queen's household since 1904, became the 2nd marquess. For many years Lord Ripon was president of the Yorkshire College of Science at Leeds, and chairman of the West Riding County Council.

RIPON, a cathedral city and municipal borough in the Ripon parliamentary division of the West Riding of Yorkshire, England, 214 m. N.N.W. from London, on the North-Eastern railway. Pop. (1901) 8230. It is pleasantly situated at the confluence of the streams Laver and Skell with the river Ure, which is crossed by a fine bridge of nine arches. The streets are for the most part narrow and irregular, and, although most of the houses are comparatively modern, some of them retain the picturesque gables characteristic of earlier times. The cathedral, although not ranking among those of the first class, is celebrated for its fine proportions, and is of great interest from the various styles of architecture which it includes. Its entire length from E. to W. is 266 ft., the length of the transepts 130 ft., and the width of the nave and aisles 87 ft. Besides a large square central tower, there are two western towers. The cathedral was founded on the ruins of St Wilfrid's abbey about 680, but of this Saxon building nothing now remains except the crypt, called St Wilfrid's Needle. The present building was begun by Archbishop Roger (1154-81), and to this Transition period belong the transepts and portions of the choir. The western front and towers, fine specimens of Early English, were probably the work of Walter de Grey, archbishop of York (d. 1255), and about the close of the century the eastern portion of the choir was rebuilt in the Decorated style. The nave, portions of the central tower, and two bays of the choir are Perpendicular, having been rebuilt towards the close of the 15th century. Earlier than the rest of the fabric (except the crypt) is part of the chapter-house and the vestry, adjoining the south side of the choir, and terminating eastward in an apse. This is pure Norman work, and there is a crypt of that period beneath, which was formerly filled with unbrired bones. There are a number of monuments of historical and antiquarian interest. The diocese includes rather less than one-third of the parishes of Yorkshire, and also a small part of Lancashire. The bishop's palace, a modern building in Tudor style, is situated in extensive grounds about a mile from the town. In the vicinity is the domain of Studley Royal, the seat of the marquess of Ripon, which contains the celebrated ruins of Fountains Abbey (q.v.). The principal secular buildings are the town hall, the public rooms, and the mechanics' institution (1804) where technical and other classes are held. There are several old charities, including the hospital of St John the Baptist, founded in 1109 but modernized; the hospital of St Anne, founded probably in the reign of Henry VI. by an unknown benefactor; and the hospital of St Mary Magdalene for women. This last was founded by Thurstan, archbishop of York (1114-41), as a secular community, one of the special duties of which was to minister to lepers. In the 13th century a master and chaplain took the place of the lay brethren, and in 1334 a chantry was founded. The chapel remains, with its interesting Norman work, its low side-windows, said to have allowed the lepers to follow the services, and its pre-Reformation altar of stone, a rare example. There is a considerable trade in varnish, and the saddle-trees and other leather goods produced here are in high repute. The borough is under a mayor, 4 aldermen, and 12 councillors. Area, 1800 acres.

Ripon (*In Rhyppum*, *Ad Ripam*) owed its origin to the monastery founded in the 7th century. A certain king, Alchfrith, is said to have given the site of the town to Eata, abbot of Melrose, to found a monastery, but before it was completed Eata was deposed for refusing to celebrate Easter according to the Roman usage, and St Wilfrid was appointed the first abbot. Another version of the story, however, says that the land was given to St Wilfrid, who himself built the monastery. Ripon is said to have been made a royal borough by Alfred the Great, and King Æthelstan, after his victory at Brunanburh

in 937, is stated to have granted to the monastery sanctuary, freedom from toll and taxes, and the privilege of holding a court, although both charters attributed to him are known to be spurious. At the same time he is said to have given the manor to Wulfstan, archbishop of York. About 950 the monastery and town were destroyed by King Edred during his expedition against the Danes, but the monastery was rebuilt by the archbishops of York, and about the time of the Conquest was changed to a collegiate church. In 1318, when the Scots invaded England, Ripon only escaped being burnt a second time by the payment of 1000 marks. The custom of blowing the wakeman's horn every night at nine o'clock is said to have originated about A.D. 700. It was probably at first a means of calling the people together in case of a sudden invasion, but was afterwards a signal for setting the watch. A boin with a baldric and the motto "Except the Lord keep the city the watchman waketh but in vain" forms the mayor's badge. The archbishops of York as lords of the manor had various privileges in the town, among which were the right of holding a market and fair, and Archbishop John, being summoned in the reign of Henry I. to answer by what right he claimed these privileges, said that he held them by prescription and by the charter of King Æthelstan. Henry I. afterwards granted or confirmed to Archbishop Thomas a fair on the feast of St Wilfrid and four following days. The fairs and markets belonged to the archbishops of York until they were transferred to the bishop of Ripon in 1837. In 1857 they were transferred to the ecclesiastical commissioners, from whom they were purchased by the corporation of Ripon in 1880. From before the Conquest until the incorporation charter of 1604 Ripon was governed by a wakeman and 12 elders, or aldermen, but in 1604 the title of wakeman was changed to mayor, and 12 aldermen and 24 common councillors were appointed. The manufacture of cloth was at one time carried on in Ripon, but was almost lost in the 16th century when the town was visited by Leland. The making of spurs succeeded the cloth manufacture and became so noted that the saying "as true as Ripon rowels" was a well-known proverb. This manufacture died out in the 18th century. Ripon was summoned to send two members to parliament in 1295, and occasionally from that time until 1328-29. The privilege was revived in 1553, after which the burgesses continued to send two members until 1867, when they were allowed only one. This latter privilege was taken away by the Redistribution Bill of 1885, and it now gives its name to one of the divisions of the county.

See *Victoria County History, Yorkshire*; and W. Harrison, *Ripon Millenary: a Record of the Festival and a History of the City, arranged under its Wakemen and Mayors from the year 1400* (1892).

RIPON, a city of Fond du Lac county, Wisconsin, U.S.A., on Silver Creek, about 22 m. W. of Fond du Lac, and about 75 m. N.W. of Milwaukee. Pop. (1890), 3358; (1900), 3818, of whom 885 were foreign-born; (1905), 3811; (1910), 3739. Ripon is served by the Chicago & North-Western, and the Chicago, Milwaukee & St Paul railways. The city has a Carnegie library, which also houses the library of the Ripon Historical Society, and is the seat of Ripon College (non-sectarian, co-educational), which was founded in 1850 as the Lyceum of Ripon, and was named Ripon College in 1864; in 1908 it had 23 instructors and 279 students. There are grain elevators and various manufactories, among the products of which are cheese and other creamery products, flour, knit goods, pickles and canned goods, woodenware, washing machines and gloves.

The site of Ripon was purchased in 1838 by John Scott Horner (1802-1883), of Virginia, secretary and acting-governor of Michigan Territory in 1835, and the first secretary of Wisconsin Territory in 1836-37, who named the village when it was established in 1849 from the seat of his ancestors in Yorkshire. In May 1844 a settlement, named Ceresco or "the Wisconsin Phalanx," a Fourierist community,¹ organized

¹The charter, granted by the legislature in 1845, contained the following features: (1) property to be held in common;

in Southport (now Kenosha), had been established in the vicinity. A "Long House," 400 ft. in length, was erected, which contained tenements, an amusement or lecture hall, and a dining-room where all ate at a common table, and where board was provided at cost, sometimes as low as sixty-three cents per week. The "class of usefulness" was divided into three groups, agricultural, mechanical and educational, with such subdivisions as necessity dictated, and an exact account of labour was kept. The community prospered materially from the start. In the second season it consisted of thirty families with property valued at \$27,725; in 1846 there were 180 resident members, and the net profit for the year was \$9029. Eventually differences of opinion arose as to the division of labour, and the common dining-hall did not prove popular. Rivalry developed with the village of Ripon, and the community gave up its charter at the close of 1850, dividing property valued at \$40,000 among the shareholders. On the whole it was one of the most successful experiments in communism ever tried in America. In 1858 Ripon absorbed the village of Ceresco and was chartered as a city. At Ripon started one of the disconnected movements that resulted in the founding of the Republican party.

See D. P. Mapes, *History of Ripon* (Milwaukee, Wis., 1873); Consul W. Butterfield, *History of Fond du Lac County* (1880); W. A. Hinds, *American Communities and Co-operative Colonies* (3rd ed., Chicago, 1908), and F. A. Flower, *History of the Republican Party* (1884).

RIPPERDA, JOHN WILLIAM, BARON, and afterwards duke of (1680-1737), political adventurer and Spanish minister, was a native of Groningen in the Netherlands. According to a story which he himself set going during his adventures in Spain, his family was of Spanish origin. But there does not appear to be any foundation for this assertion. The name was not uncommon in Groningen, and was borne by several persons of some note in the 16th and 17th centuries, one of whom was a follower of William the Silent. They were people of some position, possessing "lordships" at Jansinia, Poëlgast, and other places, and some at least of them were Roman Catholics. John William, if he was, as he asserted, born a Roman Catholic, conformed to Dutch Calvinism in order to obtain his election as delegate to the states-general from Groningen. In 1715 he was sent by the Dutch government as ambassador to Madrid. Saint-Simon says that his character for probity was even then considered doubtful. The fortune of Orry, Alberoni and other foreigners in Spain, showed that the court of Philip V. offered a career to adventurers. Ripperda—whose name is commonly spelt Ripperda by the Spaniards—devoted himself to the Spanish government, and professed himself a Roman Catholic. He first attached himself to Alberoni, and after the fall of that minister he became the agent of Elizabeth Farnese, the restless and intriguing wife of Philip V. Though perfectly unscrupulous in money matters, and of a singularly vain and blustering disposition, he did understand commercial questions, and he has the merit of having pointed out that the poverty of Spain was mainly due to the neglect of its agriculture. But his fortune was not due to any service of a useful kind he rendered his masters. He rose by undertaking to aid the queen, whose influence over her husband was boundless, in her schemes for securing the succession to Parma, Plasencia and Tuscany for her sons. Ripperda was sent as special envoy to Vienna in 1725. He behaved with ridiculous violence, but the Austrian government, which was under the influence of its own fixed idea, treated him seriously. The result of ten months of very strange diplomacy was a treaty by which the emperor promised very little, but

and shares to be sold at \$25; (2) land to be limited to 40 acres for each member of the corporation; (3) a unanimous vote of the managers necessary for admission; (4) an annual settlement of profits on the basis of one-quarter credit to dividend on stock, and three-quarters credit to labour; (5) free public schools, capital paying three-quarters and labour one-quarter of cost; and (6) complete religious toleration and no involuntary taxation for church support.

Spain was bound to pay heavy subsidies, which its exhausted treasury was quite unable to afford. The emperor hoped to obtain money. Elizabeth Farnese hoped to secure the Italian duchies for her sons, and some vague stipulations were made that Charles VI. should give his aid for the recovery by Spain of Gibraltar and Minorca. When Ripperda returned to Madrid at the close of 1725 he asserted that the emperor expected him to be made prime minister. The Spanish sovereigns, who were overawed by this quite unfounded assertion, allowed him to grasp the most important posts under the crown. He excited the violent hostility of the Spaniards, and entered into a complication of intrigues with the French and English governments. His career was short. In 1726 the Austrian envoy, who had vainly pressed for the payment of the promised subsidies, came to an explanation with the Spanish sovereigns. It was discovered that Ripperda had not only made promises that he was not authorized to make, but had misappropriated large sums of money. The sovereigns who had made him duke and grandee shrank from covering themselves with ridicule by revealing the way in which they had been deceived. Ripperda was dismissed with the promise of a pension. Being in terror of the hatred of the Spaniards, he took refuge in the English embassy. To secure the favour of the English envoy, Colonel William Stanhope, afterwards Lord Harrington, he betrayed the secrets of his government. Stanhope could not protect him, and he was sent as a prisoner to the castle of Segovia. In 1728 he escaped, probably with the connivance of the government, and made his way to Holland. His last years are obscure. It is said that he reverted to Protestantism, and then went to Morocco, where he became a Mahomedan and commanded the Moors in an unsuccessful attack on Ceuta. But this story is founded on his so-called *Memoirs*, which are in fact a Grubstreet tale of adventure published at Amsterdam in 1740. All that is really known is that he did go to Morocco, and that he died at Tetuan in 1737.

See Arnold Ritter von Arneth, *Prinz Eugen von Savoyen* (Vienna, 1864), for the negotiations of 1725, and Gabriel Svveton, *Une Cour et un aventurier au XVIII^e siècle* (Paris, 1896). His *Memoirs* were translated into English by J. Campbell, London, 1750.

RISHANGER, WILLIAM (c. 1250-c. 1312), English chronicler, made his profession as a Benedictine at St Alban's abbey in 1271, of which he perhaps became the official chronicler. The most important of his writings is the *Narratio de bellis apud Lewes et Evesham*. Though written many years afterwards and drawn from other sources, it is a spirited account of the barons' war. He is so great an admirer of Simon de Montfort that this work has been called a hagiography. He is credited with the authorship of a chronicle covering the period 1259-1306; this has been disputed, but the work is printed under his name by Riley. Another work of his, of not much importance, is a chronicle entitled *Recapitulatis brevis de gestis domini Edwardi, &c.* He is probably not the author of other works commonly attributed to him.

AUTHORITIES.—*Wilhelmi Rishanger chronica et annales*, Rolls Series, Introduction, ed. H. T. Riley; the *Narratio de bellis apud Lewes et Evesham*, ed. J. O. Halliwell, Camden Society, 1840.

RISK, hazard, chance of danger or loss, especially the chance of loss to property or goods which an insurance company undertakes to make good to the insurer in return for the recurrent payment of a sum called the premium (see *INSURANCE*). The word appears late in English, and in the 17th century in the Fr. form *risque* or It. *risco* or *risgo*, for *risico*, *risigio*; cf. Sp. *riesgo*. The Med. Lat. *risicus*, *risichium*, and *risicum* are found, according to Du Cange (*Gloss.*, qq. n.), as early as the 13th century. Skeat (*Etym. Dict.*, 1910) accepts Diez's suggestion that the word is originally a sailor's term, and is to be referred to Sp. *risco*, a steep rock, from Lat. *resicare*, to cut back, shut off; thus Sp. *arriesgar*, to run into danger, means literally "to go against a rock."

RIST, JOHANN VON (1607-1667), German poet, was born at Ottensen in Holstein on the 8th of March 1607; the son of

the Lutheran pastor of that place. He received his early training in Hamburg and Bremen; after studying theology at Rinteln and Rostock, he became in 1633 private tutor in a family of Heide, and two years later (1635) was appointed pastor of the village of Wedel on the Elbe, where he laboured until his death on the 31st of August 1667. Rist first made his name known to the literary world by a drama, *Perseus* (1634), which he wrote while at Heide, and in the next succeeding years he produced a number of dramatic works of which the allegory *Das friedenwünsche Deutschland* (1647) and *Das friedejauchendes Teutschland* (1653) (new ed. of both by H. M. Schletterer, 1864) are the most interesting. Rist soon became the central figure in a school of minor poets, and honours were showered upon him from every side. The emperor Ferdinand III. crowned him laureate in 1644, ennobled him in 1653, and invested him with the dignity of a Count Palatine, an honour which enabled him to crown, and to gain numerous poets for the Elbschwanen order, a literary and poetical society which he founded in 1656. He had already, in 1645, been admitted, under the name "Daphnis aus Cimbrien," to the literary order of Pegnitz, and in 1647 he became, as "Der Rüstige," a member of the Fruchtbringende Gesellschaft. It is, however, as a writer of church hymns (see *HYMNS*) that Rist is best known to fame. Among these several are still retained in the evangelical hymn book: e.g. *O Ewigkeit, du Donnerwort* and *Ermun'tre dich, mein schwacher Geist*. Collections of his poems appeared under the titles *Musa Teulonica* (1634) and *Himmliche Lieder* (1643).

Selections of Rist's writings have been published by W. Müller in vol. viii. of his *Bibliothek deutscher Dichter des 17. Jahrh.* (1822-1838), and by K. Goedeke and E. Goetze (1885). See T. Hansen, *Johann Rist und seine Zeit* (1872); K. T. Gaedertz, *J. Rist als niederdeutscher Dramatiker* (*Jahrb. f. niederdeutsche Sprache*, vol. vii., 1881); and M. von Waldberg's article in the *Allg. deutsche Biographie*.

RISTITCH (or **RISTIC**), **JOVAN** (1831-1890), Servian statesman, was born at Kragevats in 1831. He was educated at Belgrade, Heidelberg, Berlin and Paris. After failing to obtain a professorship in the high school of Belgrade, he was appointed in 1861 Servian diplomatic agent at Constantinople. His reputation was enhanced by the series of negotiations which ended in the withdrawal of the Turkish troops from the Servian fortresses in 1867. On his return from Constantinople he was offered a ministerial post by Prince Michael, who described him as "his right arm," but declined office, being opposed to the reactionary methods adopted by the prince's government. He had already become the recognized leader of the Liberal party. After the assassination of Prince Michael in 1868, he was nominated member of the council of regency, and on the 2nd January 1869 the first Servian constitution, which was mainly his creation, was promulgated. When Prince Milan attained his majority in 1872, Ristitch became foreign minister; a few months later he was appointed prime minister, but resigned in the following autumn (1873). He again became prime minister in April 1876, and conducted the two wars against Turkey (July 1876-March 1877 and December 1877-March 1878). At the congress of Berlin he laboured with some success to obtain greater advantages for Servia than had been accorded to her by the treaty of San Stefano. The provisions of the treaty of Berlin, however, disappointed the Servians, owing to the obstacles now raised to the realization of the national programme; the Ristitch government became unpopular, and resigned in 1880. In 1887 King Milan (who had assumed the royal title in 1882), alarmed at the threatening attitude of the Radical party, recalled Ristitch to power at the head of a coalition cabinet; a new constitution was granted in 1888, and in the following year the king abdicated in favour of his son, Prince Alexander. Ristitch now became head of a council of regency, entrusted with power during the minority of the young king, and a Radical ministry was formed. In 1892, however, Ristitch transferred the government to the Liberal party, with which he had always been connected. This step and the subsequent

conduct of the Liberal politicians caused serious discontent in the country. On the 1st (13th) of April 1893 King Alexander, by a successful stratagem, imprisoned the regents and ministers in the palace, and, declaring himself of age, recalled the Radicals to office. Ristitch now retired into private life. He died at Belgrade on 4th September 1890. Though cautious and deliberate by temperament, he was a man of strong will and firm character. He was the author of two published works: *The External Relations of Serbia from 1848 to 1867* (Belgrade, 1887) and *A Diplomatic History of Serbia* (Belgrade, 1896). (J. D. B.)

RISTORI, ADELAIDE (1822-1906), Italian actress, was born at Cividade del Friuli on the 30th of January 1822, the daughter of strolling players. As a child she appeared upon the stage, and at fourteen made her first success as Francesca da Rimini in Silvio Pellico's tragedy. She was eighteen when for the first time she played Mary Stuart in an Italian version of Schiller's play. She had been a member of the Sardinian company and also of the Ducal company at Parma for some years before her marriage (1846) to the marchese Giuliano Capranica del Grillo (d. 1861); and after a short retirement she returned to the stage and played regularly in Turin and the provinces. It was not until 1855 that she paid her first professional visit to Paris, where the part of Francesca was chosen for her *début*. In this she was rather coldly received, but she took Paris by storm in the title rôle of Alfieri's *Myrrha*. Furious partisanship was aroused by the appearance of a rival to the great Rachel. Paris was divided into two camps of opinion. Humble playgoers fought at gallery doors over the merits of their respective favourites. The two famous women never actually met, but the French actress seems to have been convinced that Ristori had no feelings towards her but those of admiration and respect. A tour in other countries, was followed (1856) by a fresh visit to Paris, when Ristori appeared in Montanelli's Italian translation of Legouvé's *Medea*. She repeated her success in this in London. In 1857 she visited Madrid, playing in Spanish to enthusiastic audiences, and in 1866 she paid the first of four visits to the United States, where she won much applause, particularly in Giacometti's *Elizabeth*, an Italian study of the English sovereign. She finally retired from professional life in 1885, and died on the 9th of October 1906 in Rome. She left a son, the marchese Giorgio Capranica del Grillo. Her *Studies and Memoirs* (1888) provide a lively account of an interesting career, and are particularly valuable for the chapters devoted to the psychological explanation of the characters of Mary Stuart, Elizabeth, Myrrha, Phaedra and Lady Macbeth, in her interpretation of which Ristori combined high dramatic instinct with the keenest and most critical intellectual study.

See also Kate Field, *Adelaide Ristori: A Biography* (New York, 1867); E. Peron Kingston, *Adelaide Ristori: A Sketch of her Life* (1859); *Daily Telegraph* (London, Oct. 10, 1906).

RITCHIE, CHARLES THOMSON RITCHIE, 1ST BARON (1838-1906), English politician, was born at Dundee, and educated at the City of London school. He went into business, and in 1874 was returned to parliament as Conservative member for the Tower Hamlets. In 1885 he was made secretary to the Admiralty, and from 1886 to 1892 president of the Local Government Board, in Lord Salisbury's administration, sitting as member for St George's in the East. He was responsible for the Local Government Act of 1888, instituting the county councils; and a large section of the Conservative party always owed him a grudge for having originated the London County Council. In Lord Salisbury's later ministries, as member for Croydon, he was president of the Board of Trade (1895-1900), and home secretary (1895-1900); and when Sir Michael Hicks-Beach retired in 1902, he became chancellor of the exchequer in Mr Balfour's cabinet. Though in his earlier years he had been a "fair-trader," he was strongly opposed to Mr Chamberlain's movement for a preferential tariff (see the articles on BALFOUR, A. J., and CHAMBERLAIN, J.), and he resigned office in September 1903. In December 1905 he was created a peer, but he was in ill-health, and he died at Biarritz on the 9th of January 1906.

RITCHIE, DAVID GEORGE (1853-1903), Scottish philosopher, was born at Jedburgh, son of the Rev. George Ritchie, D.D. He had a distinguished university career at Edinburgh, and Balliol College, Oxford, and after being fellow of Jesus and tutor of Balliol was elected professor of logic and metaphysics at St Andrews. He was president of the Aristotelian Society in 1898. Among his works are: *Darwinism and Politics* (1889); *Principles of State Interference* (1891); *Darwin and Hegel* (1893); *Natural Rights* (1895); a translation with R. Lodge and P. E. Matheson of Bluntschli's *Theory of the State* (1885); many articles in *Mind*, *Philosophical Review*, &c. His *Philosophical Studies* was edited with a memoir by R. Latta (1905).

RITSCHL, ALBRECHT (1822-1899), German theologian, was born at Berlin on the 25th of March 1822. His father, Georg Karl Benjamin Ritschl (1783-1858), became in 1810 pastor at the church of St Mary in Berlin, and from 1827 to 1854 was general superintendent and evangelical bishop of Pomerania. Albrecht Ritschl studied at Bonn, Halle, Heidelberg and Tübingen. At Halle he came under Hegelian influences through the teaching of Julius Schaller (1810-1868) and J. H. Erdmann (b. 1805). In 1845 he was entirely captivated by the Tübingen school, and in his work *Das Evangelium Marcions und das kanonische Evangelium des Lukas*, published in 1846, he appears as a disciple of F. C. Baur. This did not last long with him, however, for the second edition (1857) of his most important work, on the origin of the old Catholic Church (*Die Entstehung der alt-kathol. Kirche*), shows considerable divergence from the first edition (1850), and reveals an entire emancipation from F. C. Baur's method. Ritschl was professor of theology at Bonn (extraordinarius 1852; ordinarius 1859) and Göttingen (1864; *Consistorialrath* also in 1874), his addresses on religion delivered at the latter university showing the impression made upon his mind by his enthusiastic studies of Kant and Schleiermacher. Finally, in 1864, came the influence of Rudolf Lotze. He wrote a large work on the Christian doctrine of justification and atonement, *Die Christliche Lehre von der Rechtfertigung und Versöhnung*, published during the years 1870-74, and in 1880-86 a history of pietism (*Die Geschichte des Pietismus*). His system of theology is contained in the former. He died at Göttingen on the 20th of March 1889.

His son, OTTO RITSCHL (b. 1860), after studying at Göttingen, Bonn and Giessen, became professor at Kiel (extraordinarius) in 1889 and afterwards at Bonn (extraordinarius 1894; ordinarius 1897). He has published, amongst other works, *Schleiermachers Stellung zum Christentum in seinen Reden über die Religion* (1888), and a *Life of his father* (2 vols., 1820-96).

Ritschl claims to carry on the work of Luther and Schleiermacher, especially in ridding faith of the tyranny of scholastic philosophy. His system shows the influence of Kant's destructive criticism of the claims of Pure Reason, recognition of the value of morally conditioned knowledge, and doctrine of the kingdom of ends; of Schleiermacher's historical treatment of Christianity, regulative use of the idea of religious fellowship, emphasis on the importance of religious feeling; and of Lotze's theory of knowledge and treatment of personality. Ritschl's work made a profound impression on German thought and gave a new confidence to German theology, while at the same time it provoked a storm of hostile criticism: his school has grown with remarkable rapidity. This is perhaps mainly due to the bold religious positivism with which he assumes that spiritual experience is real and that faith has not only a legitimate but even a paramount claim to provide the highest interpretation of the world. The life of trust in God is a fact, not so much to be explained as to explain everything else. Ritschl's standpoint is not that of the individual subject. The objective ground on which he bases his system is the religious experience of the Christian community. The "immediate object of theological knowledge is the faith of the community," and from this positive religious datum theology constructs a "total view of the world and human life." Thus the essence of Ritschl's work is systematic theology. Nor does he painfully work up to his master-category, for it is given in the knowledge

of Jesus Christ revealed to the community. That God is love and that the purpose of His love is the moral organization of humanity in the "Kingdom of God"—this idea, with its immense range of application—is applied in Ritschl's initial datum.

From this vantage-ground Ritschl criticizes the use of Aristotelianism and speculative philosophy in scholastic and Protestant theology. He holds that such philosophy can show no relationship; Hegelianism attempts to squeeze all life into the categories of logic; Aristotelianism deals with "things in general" and ignores the radical distinction between nature and spirit. Neither Hegelianism nor Aristotelianism is "vital" enough to sound the depths of religious life. Neither conceives "God" as correlative to human "trust" (cf. *Theologie und Metaphysik*, esp. p. 8 seq.). But Ritschl's recoil carries him so far that he is left alone with merely "practical" experience. "Faith" knows God in His active relation to the "kingdom," but not at all as "self-existent."

His limitation of theological knowledge to the bounds of human need might, if logically pressed, run perilously near phenomenalism; and his epistemology ("we only know things in their activities") does not cover this weakness. In seeking ultimate reality in the circle of "active conscious sensation," he rules out all "metaphysic." Indeed, much that is part of normal Christian faith—e.g. the Eternity of the Son—is passed over as beyond the range of his method. Ritschl's theory of "value-judgments" (*Werthurtheile*) illustrates this form of agnosticism. Religious judgments of value determine objects according to their bearing on our moral and spiritual welfare. They imply a lively sense of radical human need. This sort of knowledge stands quite apart from that produced by "theoretical and disinterested" inquiry. The former moves in a world of "values" and judges things as they are related to our "fundamental self-feeling." The latter moves in a world of cause and effect. (N.B. Ritschl appears to confine Metaphysic to the category of Causality.) The theory as formulated has such grave ambiguities, that his theology, which, as we have seen, is wholly based on uncompromising religious realism, has actually been charged with individualistic subjectivism. If Ritschl had clearly shown that judgments of value enfold and transform other types of knowledge, just as the "spiritual man" includes and transfigures but does not annihilate the "natural man," then within the compass of this spiritually conditioned knowledge all other knowledge would be seen to have a function and a home. The theory of value-judgments is part too of his ultra-practical tendency; both "metaphysic" and "mysticism" are ruthlessly condemned. Faith-knowledge appears to be wrenched from its bearings and suspended in mid-ocean. Perhaps if he had lived to see the progress of will-psychology he might have welcomed the hope of a more spiritual philosophy.

A few instances will illustrate Ritschl's positive systematic theology. The conception of God as Father is given to the community in Revelation. "He must be regarded in His active relationship to the 'kingdom,'" as spiritual personality revealed in spiritual purposiveness. His "Love" is His will as directed towards the realization of His purpose in the kingdom. His "Righteousness" is His fidelity to this purpose. With God as "First Cause" or "Moral Legislator" theology has no concern; nor is it interested in the "speculative" problems indicated by the traditional doctrine of the Trinity. "Natural theology" has no value save where it leans on faith. Again, Christ has for the religious life of the community the unique value of Founder and Redeemer. He is the perfect Revelation of God and the Exemplar of true religion. His work in founding the kingdom was a personal vocation, the spirit of which is to communicate to believers, even thus, as exalted king, "sustaining the life of His Kingdom. His Resurrection is a necessary part of Christian belief (G. Ecke, pp. 198-99). "Divinity" is a predicate applied by faith to Jesus in His founding and redeeming activity. We note here that though Ritschl gives Jesus a unique and unapproachable position in His active relation to the kingdom, he declines to rise above this relative teaching. The "Two Nature" problem and the eternal relation of the Son to the Father have no bearing on experience, and therefore stand outside the range of theology.

More, in the doctrine of sin and redemption, the governing idea is God's fatherly purpose for His family. Sin is the contradiction of that purpose, and guilt is alienation from the family. Redemption, justification, regeneration, adoption, forgiveness, reconciliation all mean the same thing—the restoration of the broken family relationship. All depends on the Mediation of Christ, who maintained the filial relationship even to His death, and communicates it to the brotherhood of believers. Everything is defined by the idea of the family. The whole apparatus of "forensic" ideas (law, punishment, satisfaction, &c.) is summarily rejected as foreign to God's purpose of love. Ritschl is so faithful to the standpoint of the religious community, that he was inclined definite to say on many inevitable questions, such as the relation of God to pagan races. His school, in which J. G. W. Herrmann, Julius Kaftan and Adolf Harnack are the chief names, diverges from his teaching in many directions; e.g. Kaftan appreciates the

mystical side of religion, Harnack's criticism is very different from Ritschl's arbitrary excess. They are united on the value of faith-knowledge as opposed to "metaphysic."

See A. Ritschl, *Die Christliche Lehre von der Rechtfertigung und Versöhnung* (3rd ed., 1889); *Unterricht in der Christlichen Lehre* (very many editions); and *Theologie und Metaphysik* (2nd ed., 1887), give his main position. Many historical and other works besides.—E. Bertrand, *Une nouvelle conception de la rédemption. La Doctrine de la justification et de la réconciliation dans le système de Ritschl* (1891); H. Schoen, *Les Origines historiques de la théologie de Ritschl* (1893); G. Ecke, *Die theologische Schule. A. Ritschl's und die evangelische Kirche der Gegenwart* (1897); James Orr, *The Ritschlian Theology and the Evangelical Faith* (London 1898); and A. E. Garvie, *The Ritschlian Theology* (Edinburgh 1899), in both of which the bibliography of the movement is given. Cf. Otto Pfeiderer, *Development of Theology in Germany since Kant* (1890). The German literature on the subject is very large; see article in *Heros-Hauck*, vol. xvii.

RITSCHL, FRIEDRICH WILHELM (1806-1876), German scholar, was born in 1806 in Thuringia. His family, in which culture and poverty were hereditary, were Protestants who had migrated several generations earlier from Bohemia. Ritschl was fortunate in his school training, at a time when the great reform in the higher schools of Prussia had not yet been thoroughly carried out. His chief teacher, Spitzner, a pupil of Gottfried Hermann, divined the boy's genius and allowed it free growth, applying only so much either of stimulus or of restraint as was absolutely needful. After a wasted year at the university of Leipzig, where Hermann stood at the zenith of his fame, Ritschl passed in 1826 to Halle. Here he came under the powerful influence of Reissig, a young "Hermannianer" with exceptional talent, a fascinating personality and a rare gift for instilling into his pupils his own ardour for classical study. The great controversy between the "Realists" and the "Verbalists" was then at its height, and Ritschl naturally sided with Hermann against Boeckh. The early death of Reissig in 1828 did not sever Ritschl from Halle, where he began his professional career with a great reputation and brilliant success, but soon hearers fell away, and the pinch of poverty compelled his removal to Breslau, where he reached the rank of "ordinary" professor in 1834, and held other offices. The great event of Ritschl's life was a sojourn of nearly a year in Italy (1836-37), spent in libraries and museums, and more particularly in the laborious examination of the Ambrosian palimpsest of Plautus at Milan. The remainder of his life was largely occupied in working out the material then gathered and the ideas then conceived. Bonn, whither he removed on his marriage in 1839, and where he remained for twenty-six years, was the great scene of his activity both as scholar and as teacher. The philological seminary which he controlled, although nominally only joint-director with Welcker, became a veritable *officina litterarum*, a kind of Isocratic school of classical study; in it were trained many of the foremost scholars of the last forty years. The names of Georg Curtius, Inne, Schleicher, Bernays, Ribbeck, Lorenz, Vahlen, Hübner, Bücheler, Helbig, Benndorf, Riese, Windisch, who were his pupils either at Bonn or at Leipzig, attest his fame and power as a teacher. In 1854 Otto Jahm took the place of the venerable Welcker at Bonn, and after a time succeeded in dividing with Ritschl the empire over the philological school there. The two had been friends, but after gradual estrangement a violent dispute arose between them in 1865, which for many months divided into two hostile forces the universities and the press of Germany. Both sides were steeped in fault, but Ritschl undoubtedly received harsh treatment from the Prussian government, and pressed his resignation. He accepted a call to Leipzig, where he died in harness in 1876.

Ritschl's character was strongly marked. The spirited element in him was powerful, and to some at times he seemed overbearing, but his nature was noble at the core; and, though intolerant of inefficiency and stupidity, he never asserted his personal claims in any mean or petty way. He was warmly attached to family and friends, and yearned continually after sympathy, yet he established real intimacy with only a few. He had a great faculty for organization, as is shown by his

administration of the university library at Bonn, and by the eight years of labour which carried to success a work of infinite complexity, the famous *Priscæ Latinitatis Monumenta Epigraphica* (Bonn, 1862). This volume presents in admirable ascimile, with prefatory notices and indexes, the Latin inscriptions from the earliest times to the end of the republic. It forms an introductory volume to the Berlin *Corpus Inscriptionum Latinarum*, the excellence of which is largely due to the precept and example of Ritschl, though he had no hand in the later volumes. The results of Ritschl's life are mainly gathered up in a long series of monographs, for the most part of the highest finish, and rich in ideas which have leavened the scholarship of the time.

As a scholar, Ritschl was of the lineage of Bentley, to whom he looked up, like Hermann, with fervent admiration. His best efforts were spent in studying the languages and literatures of Greece and Rome, rather than the life of the Greeks and Romans. He was sometimes, but most unjustly, charged with taking a narrow view of "Philologie." That he keenly appreciated the importance of ancient institutions and ancient art both his published papers and the records of his lectures amply testify. He devoted himself for the most part to the study of ancient poetry, and in particular of the early Latin drama. This formed the centre from which his investigations radiated. Starting from this he ranged over the whole remains of pre-Ciceronian Latin, and not only analysed but augmented the sources from which our knowledge of it must come. Before Ritschl the acquaintance of scholars with early Latin was so dim and restricted that it would perhaps be hardly an exaggeration to call him its real discoverer.

To the world in general Ritschl was best known as a student of Plautus. He cleared away the accretions of ages, and by efforts of that real genius which goes hand in hand with labour, brought to light many of the true features of the original. It is infinitely to be regretted that Ritschl's results were never combined to form that monumental edition of Plautus of which he dreamed in his earlier life. Ritschl's examination of the *Plautine MSS.* was both laborious and brilliant, and greatly extended the knowledge of Plautus and of the ancient Latin drama. Of this, two striking examples may be cited. By the aid of the Ambrosian palimpsest he recovered the name T. Maccius Plautus, for the vulgate M. Accius, and proved it correct by strong extraneous arguments. On the margin of the *Palatine MSS.* the marks C and DV continually recur, and had been variously explained. Ritschl proved that they meant "Canticum" and "Diverbium," and hence showed that in the Roman comedy only the conversations in iambic senarii were not intended for the singing voice. Thus was brought into strong relief a fact without which there can be no true appreciation of Plautus, viz. that his plays were comic operas rather than comic dramas.

In conjectural criticism Ritschl was inferior not only to his great predecessors but to some of his contemporaries. His imagination was in this field (but in this field only) hampered by erudition, and his judgment was unconsciously warped by the desire to find in his text illustrations of his discoveries. But still a fair proportion of his textual labours has stood the test of time, and he rendered immense service by his study of *Plautine metres*, a field in which little advance had been made since the time of Bentley. In this matter Ritschl was aided by an accomplishment rare (as he himself lamented) in Germany the art of writing Latin verse.

In spite of the incompleteness, on many sides, of his work Ritschl must be assigned a place in the history of learning among a very select few. His studies are presented principally in his *Opuscula* collected partly before and partly since his death. The *Trinummus* (twice edited) was the only specimen of his contemplated edition of Plautus which he completed. The edition has been continued by some of his pupils—Goetz, Loewe and others.

The facts of Ritschl's life may be best learned from the elaborate biography by Otto Ribbeck (Leipzig, 1879). An interesting and

discriminating estimate of Ritschl's work is that by Lucian Mueller (Berlin, 1877). (J. S. R.)

RITSON, JOSEPH (1752-1803), English antiquary, was born at Stockton-on-Tees, of a Westmorland yeoman family, on the 2nd of October 1752. He was educated for the law, and settled in London as a conveyancer when twenty-two. He devoted his spare time to literature, and in 1782 published an attack on Warton's *History of English Poetry*. The fierce and insulting tone of his *Observations*, in which Warton was treated as a showy pretender, and charged with cheating and lying to cover his ignorance, made a great sensation in literary circles. In nearly all the small points with which he dealt Ritson was in the right, and his corrections have since been adopted, but the unjustly bitter language of his criticisms roused great anger at the time, much, it would appear, to Ritson's delight. In 1783 Johnson and Steevens were assailed in the same bitter fashion as Warton for their text of Shakespeare. Bishop Percy was next subjected to a furious onslaught in the preface to a collection of *Ancient Songs* (printed 1787, dated 1790, published 1792). The only thing that can be said in extenuation of Ritson's unmatchable acrimony is that he spared no pains himself to ensure accuracy in the texts of old songs, ballads and metrical romances which he edited. His collection of the Robin Hood ballads is perhaps his greatest single achievement. Scott, who admired his industry and accuracy in spite of his temper, was almost the only man who could get on with him. On one occasion, when he called in Scott's absence, he spoke so rudely to Mrs Scott that Leyden, who was present, threatened to "throw his neck," and throw him out of the window. Spelling was one of his eccentricities, his own name being an example: Ritson is short pronunciation for Richardson. As early as 1796 Ritson showed signs of mental collapse, and on the 10th of September 1803 he became completely insane, barricaded himself in his chambers at Gray's Inn, made a bonfire of manuscripts, and was finally forcibly removed to Hoxton, where he died on the 23rd of the month.

RITTENHOUSE, DAVID (1732-1796), American astronomer, was born at Germantown, Pennsylvania, on the 8th of April 1732. First a watchmaker and mechanic he afterwards became treasurer of Pennsylvania (1777-80), and from 1792 to 1795 director of the U.S. mint (Philadelphia). He was largely occupied in 1763 and in 1779-86 in settling the boundaries of several of the states. He was a fellow of the Royal Society of London, and a member of the American Philosophical Society; and was elected president of the latter society in 1791. As an astronomer, Rittenhouse's principal merit is that he introduced in 1786 the use of spider lines in the focus of a transit instrument. His priority with regard to this useful invention was acknowledged by E. Troughton, who brought spider lines into universal use in astronomical instruments (see von Zach's *Monatliche Correspondenz*, vol. ii. p. 215), but Felice Fontana (1730-1805), professor of physics at the university of Pisa, and afterwards director of the museum at Florence, had already anticipated the invention in 1775, though no doubt this fact was unknown to Rittenhouse. His researches were published in the *Transactions of the American Philosophical Society* (1785-1799). He died at Philadelphia on the 26th of June 1796.

See *Memoir* (1813) by William Barton.

RITTER, HEINRICH (1791-1869), German philosopher, was born at Zerbst on the 21st of November 1791, and died at Göttingen on the 3rd of February 1869. He studied philosophy and theology at Göttingen and Berlin until 1815. In 1824 he became extraordinary professor of philosophy at Berlin, whence he was transferred to Kiel, where he occupied the chair of philosophy from 1833 to 1837. He then accepted a similar position at the university of Göttingen, where he remained till his death. His chief work was a history of philosophy (*Geschichte der Philosophie*) published in twelve volumes at Hamburg from 1820 to 1853. This book is the product of a wide and thorough knowledge of the subject aided by an impartial critical faculty, and its value is demonstrated by the

fact that it has been translated into almost all the languages of Europe. He wrote also accounts of ancient schools of philosophy, the Ionians, the Pythagoreans and the Megarians. Beside these important historical works, he published a large number of treatises of which the following may be mentioned: *Versuch zur Verständigung über die neueste deutsche Philosophie seit Kant* (1853); *Die christliche Philosophie bis auf die neuesten Zeiten* (2 vols., 1858-59), a work which supplemented the *Geschichte*; *Abriß der philosophischen Logik* (1824); *Ueber das Verhältnis der Philosophie zum Leben* (1835); *Historia philosophiae Graeco-Romanae* (in collaboration with Preller, 1838; 7th ed., 1888); *Kleine philosophische Schriften* (1839-40); *System der Logik und Metaphysik* (1856); *Encyclopädie der philosophischen Wissenschaften* (1862-64); *Ernest Renan, über die Naturwissenschaften und die Geschichte* (1865); *Ueber das Böse und seine Folgen* (1869). Of these latter, the one best known in England is the History of Greek and Roman Philosophy, which, by reason of the excellence of its arrangement and its judicious quotations and notes, is almost indispensable to the student of ancient philosophy.

RITTER, KARL (1779-1859), German geographer, was born at Quedlinburg on the 7th of August 1779, and died in Berlin on the 28th of September 1859. His father, a physician, left his family in straitened circumstances, and Karl was received into the Schnepfenthal institution then just founded by Christian Gotthilf Salzmann (1744-1811) for the purpose of testing his educational theories. The Salzmann system was practically that of Rousseau; conformity to natural law and enlightenment were its watchwords; great attention was given to practical life; and the modern languages were carefully taught, to the complete exclusion of Latin and Greek. Ritter already showed geographical aptitude, and when his school-days were drawing to a close his future course was determined by an introduction to Bethmann Hollweg, a banker in Frankfurt. It was arranged that Ritter should become tutor to Hollweg's children, but that in the meantime he should attend the university at his patron's expense. His duties as tutor in the Hollweg family began at Frankfurt in 1798 and continued for fifteen years. The years 1814-19, which he spent at Göttingen in order still to watch over the welfare of his pupils, were those in which he began to devote himself exclusively to geographical inquiries. He had already travelled extensively in Europe when in 1817-18 he brought out his first masterpiece, *Die Erdkunde im Verhältnis zur Natur und zur Geschichte des Menschen* (Berlin, 2 vols., 1817-1818). In 1819 he became professor of history at Frankfurt, and in 1820 professor extraordinarius of history at Berlin, where shortly afterwards he began also to lecture at the military college. He remained in this position till his death. The second edition of his *Erdkunde* (1822-58) was conceived on a much larger scale than the first, but he completed only the sections on Africa and the various countries of Asia. The service rendered to geography by Ritter was especially notable because he brought to his work a new conception of the subject. Geography was, to use his own expression, a kind of physiology and comparative anatomy of the earth: rivers, mountains, glaciers, &c., were so many distinct organs, each with its own appropriate functions; and, as his physical frame is the basis of the man, determinative to a large extent of his life, so the structure of each country is a leading element in the historic progress of the nation. Moreover, Ritter was a scientific compiler of the first rank. Among his minor works may be mentioned *Vorhalle europäischer Völkergeschichten vor Herodot* (Berlin, 1820); *Die Stupas . . . an der indobaktrischen Königsstrasse und die Kolosse von Bamiyan* (1838); *Einleitung zur allgemeinen vergleichenden Geographie* (Berlin, 1852); *Bemerkungen über Veranschaulichungsmittel räumlicher Verhältnisse bei graphischen Darstellungen durch Form u. Zahl*, in the *Trans.* of the Berlin Academy, 1828. After his death selections from his lectures were published under the titles *Geschichte der Erdkunde* (1861), *Allgemeine Erdkunde* (1862), and *Europa* (1863). Several of his works (e.g. the "Palestine" volumes

of his *Erdkunde*) were translated into English. "Karl Ritter" foundations were established in his memory at Berlin and Leipzig, for the furtherance of geographical study.

See G. Kramer, *Karl Ritter, ein Lebensbild* (Halle, 1864 and 1870; 2nd ed., 1875); W. L. Gage, *The Life of Karl Ritter* (London, 1867); F. Marthe, "Was bedeutet Karl Ritter für die Geographie," in *Zeitsch. der Ges. f. Erdk.* (Berlin, 1879). All Ritter's works mentioned above were published at Berlin.

RITUAL (from Lat. *ritus*, a custom, especially a religious rite or custom), a term of religion, which may be defined as the routine of worship. This is a "minimum definition"; "ritual" at least means so much, but may stand for more. Without some sort of ritual there could be no organized method in religious worship. Indeed, viewed in this aspect, ritual is to religion what habit is to life, and its *rationale* is similar, namely, that by bringing subordinate functions under an effortless rule it permits undivided attention in regard to vital issues. This analogy—for it is safer to regard such applications of individual psychology to social phenomena as only analogies—may be carried a step further. Just as the main business of habit is to secure bodily equilibrium in order to allow free play to the mental life, so the chief task of routine in religion is to organize the activities necessary to its stability and continuance as a social institution, in order that all available spontaneity and initiative may be directed into spiritual channels. Such organization will naturally affect far more than the forms of worship; but these at least, to judge from the past history of religion, cannot but submit extensively to its influence. The nature of religion, as the sociologist understands it, is bound up with its congregational character. In order that inter-subjective relations should be maintained between fellow-worshippers, the use of one or another set of conventional symbols is absolutely required; for example, an intelligible vocabulary of meet expressions, or (since this is, perhaps, not indispensable) at any rate sounds, sights, actions and so on, that have come by prescription to signify the common purpose of the religious society, and the means taken in common for the realization of that purpose. In this sense, the term "ritual," as meaning the prescribed ceremonial routine, is also extended to observances not strictly religious in character.

But, whilst ritual at least represents routine, it tends, historically speaking, to have a far deeper significance for the religious consciousness. A recurrent feature of religion, which many students of its phenomena would even consider constant and typical, is the attribution of a more or less self-contained and automatic efficacy to the ritual procedure as such. Before proceeding to considerations of genesis, it will be convenient briefly to analyse the notion as it appears in the higher religions. Two constituent lines of thought may be distinguished. Firstly, there is the tendency to pass beyond the purely petitionary attitude which as such can imply no more than the desire, hope or expectation of divine favour, and to take for granted the consummation sought, a deity that answers, a grace and blessing that are communicated. Only when such accomplishment of its end is assumed can efficacy be held to attach to the act of worship. Secondly, there is the tendency to identify such a self-accomplishing act of worship with its objective expression in the ritual that for purposes of mutual understanding makes the body of worshippers one.

The Magical Element in Ritual.—Exactly similar tendencies—to impute efficacy, and to treat the ritual procedure as the source of that efficacy—are typically characteristic of magic, and their reappearance in religion can hardly be treated as a coincidence, seeing that magic and religion would appear to have much in common, at any rate during the earlier stages of their development. In magic a suggestion is made orally, or by dramatic action, or most often in both ways together, that is held *ipso facto* to bring about its own accomplishment. A certain conditionality attaches to the magical operation, inasmuch as each magician is subject to interference on the part of other magicians who may neutralize his spell by a

counter spell of equal or greater power; nevertheless, the intrinsic tone is that of a categorical assertion of binding force and efficacy. Again, in magic the self-realizing force is apt to seem to reside in the suggestional machinery rather than in the spiritual qualifications of the magician, though this is by no means invariably the case. On the whole, however, spells and ceremonies are wont to be regarded as an inheritable and transferable property containing efficacy in themselves. And what is true of magic is equally true of much of primitive, and even of relatively advanced, religion. Dr J. G. Frazer has pronounced the following to be marks of a primitive ritual: negatively, that there are no priests, no temples and no gods (though he holds that departmental, non-individual "spirits" are recognized); positively, that the rites are magical rather than propitiatory (*The Golden Bough*, 2nd ed. ii. 101). If we leave it an open question whether, instead of "spirits," it would not be safer to speak of "powers" (to which not a soul-like nature, but simply a capacity for exercising magic, is attributed), this characterization may be accepted as applying to many, if not to all, the rites of primitive religion. Thus the well-known totemic ceremonies of Central Australia afford a striking example of rites of a deeply religious import—in the sense that the purpose they embody is that of consecrating certain functions of the common life (see RELIGION)—yet almost wholly magical in form. They resolve themselves on analysis into (1) direct acts of magical suggestion, and (2) acts commemorative of the magical doings of mythical ancestors, the purport of which may be regarded as indirectly and constructively magical, on the principle that in magic to mention a thing's origin is to control it, to recount another's wonder-working is to reproduce his power, and so on. It is to be noted, however, that other Australian rites are found, notably those that accompany initiation in the south-eastern region, over which anthropomorphic beings having enough individuality to rank as "gods" undoubtedly preside; but even here, though traces of propitiatory worship may be discernible (the evidence being scanty and conflicting), acts of pure magic are decidedly to the fore. And what is true of the most primitive and unreflective forms of cult remains true of more advanced types which have become relatively self-conscious. There is little or no felt opposition between processes implying control and processes of a propitiatory character in the religion of the Pueblo Indians, which American ethnologists have been so successful in expounding, or, to mount to a still higher level, in the Vedic, Assyrian or Egyptian cults. The leading idea, we may even say, is that expressed so happily by a character in Renan's *Le Prêtre de Némis*: "L'ordre du monde dépend de l'ordre des rites qu'on observe" (cf. A. Lang, *Myth, Ritual and Religion*, 2nd ed. i. 251). As regards the most developed forms of religion, whilst the old procedure largely survives unchanged, its original intention is disowned by theologians, though it may be doubted if the popular mind is always strong enough to withstand the appeal of prima facie appearance.

This proneness to impute efficacy to ritual is immensely reinforced by another social proclivity, more or less distinct in its ultimate nature, which causes the rite to rank as a divine ordinance or command. Naturally if the god manifests himself by means of certain forms, if he is reputed to have appeared or revealed them, or if he has been known to evince displeasure at departures from them, there is strong reason to think that such forms are efficacious, and that in a sense of themselves, namely, by being what they are. At the sociological level of thought this divine sanction has to be treated as the echo of a social sanction which ratifies and protects religious custom. In early society the influence of what Walter Bagehot (in *Physics and Politics*, 9th ed. p. 102) calls the "persecuting tendency" in enforcing custom is on the whole not markedly in evidence. The fact is that imitation in a homogeneous group produces such unanimity that, with the help of some education, notably the instruction given at the time of initiation, all non-conformity is nipped in the bud. Of the Central Australian

ceremonies we read that they "had to be performed in precisely the same way in which they had been in the Alcheringa (lit. 'dream-time' = age of mythical tribal ancestors). Everything was ruled by precedent; to change even the decoration of a performer would have been an unheard-of thing; the reply," "It was so in the Alcheringa," was considered as perfectly satisfactory by way of explanation" (B. Spencer and F. Gillen, *The Native Tribes of Central Australia*, 324). Here we perceive the social sanction of public opinion insensibly merging in a supernatural sanction. The tribe is a religious partnership with a divine past with which it would not willingly break. As Mr Lang well puts it, "Ritual is preserved because it preserves luck" (*loc. cit.*). Given an intrinsic sacredness, it is but a step to associate definite gods with the origin or purpose of a rite, whose interest it thereupon becomes to punish omissions or innovations by the removal of their blessing (which is little more than to say that the rite loses its efficacy), or by the active infliction of disaster on the community. In the primitive society it is hard to point to any custom to which sacredness does not in some degree attach, but, naturally, the more important and solemn the usage, the more rigid the religious conservatism. Thus there are indications that in Australia, at the highly sacred ceremony of circumcision, the fire-stick was employed after stone implements were known; and we have an exact parallel at a higher level of culture, the stone implement serving for the same operation when iron is already in common use (Spencer and Gillen, *ib.* 401; cf. E. B. Tylor, *Early History of Mankind*, 3rd ed. p. 217).

The Interpretation of Ritual.—A valuable truth insisted on by the late W. Robertson Smith (*Religion of the Semites*, 17 sqq.) is that in primitive religion it is ritual that generates and sustains myth, and not the other way about. Sacred lore of course cannot be dispensed with; even Australian society, which has hardly reached the stage of having priests, needs its *Ombrabata* or "great instructor" (Spencer and Gillen, *ib.* 303). The function of such an expert, however, is chiefly to hand on mere rules for the performance of religious acts. If his lore include sacred histories, it is largely, we may suspect, because the description and dramatization of the doings of divine persons enter into ritual as a means of magical control. Similarly, the sacred books of the religions of middle grade teem with minute prescriptions as to ritual, but are almost destitute of doctrine. Even in the highest religions, where orthodoxy is the main requirement, and ritual is held merely to symbolize dogma, there is a remarkable rigidity about the dogma that is doubtless in large part due to its association with ritual forms many of them bearing the most primeval stamp. As regards the symbolic interpretation of ritual, this is usually held not to be primitive; and it is doubtless true that an unreflective age is hardly aware of the difference between "outward sign" and "inward meaning," and thinks as it were by means of its eyes. Nevertheless, it is easier to define fetishism (a fetish "differing from an idol in that it is worshipped in its own character, not as the symbol, image or occasional residence of a deity," *New English Dictionary*, Oxford, 1901) than it is to bring such a fetishism home to any savage people, the West African negroes not excluded (cf. A. B. Ellis, *The Tshi-speaking Peoples of the Gold Coast of W. Africa*, 192). It is the magic power, virtue or grace residing in, and proceeding from, the material object—a power the communicability of which constitutes the whole working hypothesis of the magico-religious performance—that is valued in those cases where native opinion can be tested. Moreover, it must be remembered that in the act of magic a symbolic method is consciously pursued, as witness the very formulas employed: "As I burn this image, so may the man be consumed," or the even more explicit, "It is not wax I am scorching; it is the liver, heart and spleen of So-and-so that I scorch" (W. W. Skeat, *Malay Magic*, 570), where appearance and reality are distinguished in order to be mystically reunited. Now it is important to observe that from the symbol as embodying an imperative to the symbol as expressing an optative is a transition of meaning that involves no change of form whatever; and, much as theorists love to contrast the suggestional and the petitionary attitudes,

it is doubtful if the savage does not move quite indifferently to and fro across the supposed frontier-line between magic and religion, interspersing "bluff" with blandishment, spell with genuine prayer. Meanwhile the particular meanings of the detailed acts composing a complicated piece of ritual soon tend to lose themselves in a general sense of the efficacy of the rite as a whole to bring blessing and avert evil. Nay, unintelligibility is so far from invalidating a sacred practice that it positively supports it by deepening the characteristic atmosphere of mystery. Even the higher religions show a lingering predilection for cabalistic formulas.

Changes in Ritual.—Whilst ritual displays an extraordinary stability, its nature is of course not absolutely rigid; it grows, alters and decays. As regards its growth, there is hardly a known tribe without its elaborate body of magico-religious rites. In the exceptional instances where this feature is relatively absent (the Masai of E. Africa offer a case in point), we may suspect a disturbance of tradition due to migration or some similar cause. Thus there is always a pre-existing pattern in accordance with which such evolution or invention as occurs proceeds. Unconscious evolution is perhaps the more active factor in primitive times; imitation is never exact, and small variations amount in time to considerable changes. On the other hand, there is also deliberate innovation. In Australia councils of the older men are held day by day during the performance of their ceremonies, at which traditions are repeated and procedure determined, the effect being mainly to preserve custom but undoubtedly in part also to alter it. Moreover, the individual religious genius exercises no small influence. A man of a more original turn of mind than his fellows will claim to have had a new ceremony imparted to him in a vision, and such a ceremony will even be adopted by another tribe which has no notion of its meaning (Spencer and Gillen, *ib.* 272, 278, 281 n.). Meanwhile, since little is dropped whilst so much is being added, the result is an endless complication and elaboration of ritual. Side by side with elaboration goes systematization, more especially when local cults come to be merged in a wider unity. Thereupon assimilation is likely to take place to one or another leading type of rite—for instance, sacrifice or prayer. At these higher stages there is more need than ever for the expert in the shape of the priest, in whose hands ritual procedure becomes more and more of a conscious and studied discipline, the naive popular elements being steadily eliminated, or rather transformed. Not but what the transference of ritualistic duties to a professional class is often the signal for slack and mechanical performance, with consequent decay of ceremonial. The trouble and worry of having to comply with the endless rules of a too complex system is apt to operate more widely—namely, in the religious society at large—and to produce an endless crop of evasions. Good examples of these on the part alike of priests and people are afforded by Toda religion, the degenerate condition of which is expressly attributed by Dr W. H. R. Rivers to "the over-development of the ritual aspect of religion" (*The Todas*, 454-55). It is interesting to observe that a religion thus atrophied tends to revert to purely magical practices, the use of the word of power, and so on (*ib.* ch. x.). It is to be noted, however, that what are known as ritual substitutions, though they lend themselves to purposes of evasion (as in the well-known case of the Chinese use of paper money at funerals), rest ultimately on a principle that is absolutely fundamental in magico-religious theory—namely, that what suggests a thing because it is like it or a part of it becomes that thing when the mystic power is there to carry the suggestion through.

The Classification of Rites.—More than one basis of division has suggested itself. From the sociological point of view perhaps the most important distinction in use is that between public and private rites. Whilst the former essentially belong to religion as existing to further the common weal, the latter have from the earliest times an ambiguous character, and tend to split into those which are licit—"sacraments," as they may be termed—and those which are considered anti-social

in tendency, and are consequently put beyond the pale of religion and assigned to the "black art" of magic. Or the sociologist may prefer to correlate rites with the forms of social organization—the tribe, the phratry, the clan, the family and so on. Another interesting contrast (seeing how primary a function of religion it is to establish a calendar of sacred seasons) is that between periodic and occasional rites—one that to a certain extent falls into line with the previous dichotomy. A less fruitful method of classing rites is that which arranges them according to their inner meaning. As we have seen, such meaning is usually acquired *ex post facto*, and typical forms of rite are used for many different purposes; so that attempts to differentiate are likely to beget more equivocations than they clear up. The fact is that comparative religion must be content to regard all its classifications alike as pieces of mere scaffolding serving temporary purposes of construction.

Negative Rites.—A word must be added on a subject dealt with elsewhere (see TABOO, GENNA), but strictly germane to the matter in hand. What have the best, if not the sole, right to rank as taboos are ritual interdictions (see M. Mauss in *L'Année sociologique*, ix. 249). Taboo, as understood in Polynesia, the home of the word, is as wide as, and no wider than, religion, representing one side or aspect of the sacred (see RELIGION). The very power that can help can also blast if approached improperly and without due precautions. Taboos are such precautions, abstinences prompted, not by simple dread or dislike, but always by some sort of respect as felt towards that which in other circumstances or in other form has healing virtue. Thus the negative attitude of the observer of taboo involves a positive attitude of reverence from which it becomes in practice scarcely distinguishable. To keep a fast, for instance, is looked upon as a direct act of worship. It must be noted, too, that, whereas taboo as at first conceived belongs to the magico-religious circle of ideas, implying a quasi-physical transference of sacredness from what has it to one not fit to receive it, it is very easily reinterpreted as an obligation imposed by the deity on his worshippers. The law observed by a primitive religious community abounds in negative precepts, and if early religion tends to be a religion of fear it is because the taboo-breaker provides the most palpable objective for human and divine sanctions. In the higher religions, to be pure remains amongst the most laudable of aspirations, and even though the ceremonial aversion of a former age has become moralized, and a purity of heart set up as the ideal, it is on "virtues of omission" that stress is apt to be laid, so that a timorous propriety is too often preferred to a forceful grappling with the problems of life. There are signs, however, that the religious consciousness has at length come to appreciate the fact that the function of routine in religion as elsewhere is to clear the way for action.

BIBLIOGRAPHY.—A comprehensive study of ritual as such from the comparative standpoint remains yet to be written. Some leading ideas on the subject are struck out by E. B. Tylor, *Primitive Culture*³ (1903), ch. 18; and A. Lang, *Myth, Ritual and Religion*² (1899); whilst the whole of J. G. Frazer's vast collection of facts in *The Golden Bough*² (1900) illustrates ritual, more especially on its magical side; see also W. Robertson Smith, *Lectures on the Religion of the Semites* (1889). A very valuable work of restricted range but embodying a method that might fruitfully be applied to the whole subject of ritual is H. Hubert and M. Mauss, "Essai sur la nature et sur la fonction du sacrifice" in *L'Année sociologique*, ii.; in close connexion with the above should be studied S. Lévi, *La Doctrine du sacrifice dans les Brâhmanas* (1899); W. Caland and V. Henry, *L'Agnostoma, description complète de la forme normale du sacrifice de Soma dans le culte védique* (1906); see also H. Oldenberg, *Die Religion des Veda* (1894); A. Hillebrandt, *Ritual Literatur: Vedische Opfer und Zauber* (1896). Admirable descriptions of Australian ritual are to be found in B. Spencer and F. J. Gillen, *The Native Tribes of Central Australia* (1899) and *The Northern Tribes of Central Australia* (1904). On North American rituals very excellent studies exist in A. C. Fletcher, "The Hako: A Pawnee Ceremony," in *22nd Report of Bureau of American Ethnology*; see also various papers by the same author in *Pedology* and *Biography* in J. W. Fewkes, "Tusayan Katchinas," in *15th Rep.* of B. of A. Eth.; and *id.*, "Hopi Katchinas," in *21st Rep.* M. C. Stevenson, "The Zuni Indians," in *23rd Rep.*; cf. F. H. Cushing, "Zuni Fetiches," in *2nd Rep.* The following works pay special attention to ritual

features: L. R. Farnell, *The Cults of the Greek States* (1896-1907); A. Moret, *Le Rituel du culte divin journalier en Égypte* (1902); A. de Marchi *Il culto privato di Roma antica* (1902). (R. R. M.)

RITUAL MURDER, a general term for human sacrifice in connexion with religious ceremonies. False accusations as to the practice of ritual murder by Jews and Christians have often been made. "The Christians of the second and third centuries suffered severely under them" (Strack). Justin Martyr (150-160) in his Second Apology (ch. 12) vigorously defends the Christian community against this charge; Octavius, Minucius Felix, Tertullian, Origen and other Church Fathers all refer to the subject and indignantly repudiate the atrocious libel that the Eucharist involved human sacrifice. The myth was revived against the Montanists, and in the later middle ages against various sects of heretical Christians. In recent years the accusation has been again leveled against "foreigners" during the disturbances in China. The chief sufferers, however, from the charge were the Jews. The charge was never coherently defined, but a notion prevailed that at the Passover Christian blood was used in Jewish rites. For this belief there is no foundation whatever, as is proved in the classical treatise¹ on the subject by Hermann L. Strack, Regius Professor of Theology at Berlin University. The first occasion on which the medieval Jews were accused of the murder of a Christian child was at Norwich in 1144. In the following century other instances of the charge occurred on the Continent, and by this time (middle of the 13th century) the legend had grown into a belief that "the Jews of every province annually decide by lot" which congregation or town is to be the scene of the mythical murder. It is easy to understand how in ages when the Jews were everywhere regarded with superstitious awe, such stories to their detriment would find ready credence, but the revival of the myth in recent times by the anti-Semite is a deplorable instance of degeneration. It is only necessary here to refer to the Lincoln case (1255), the Trent case (1475) and more recently the Damascus case (1840), the Tisza-Eszlar affair (1882), the Xanten charge (1891) and the Polna case (1899). All of these charges—sometimes invented by malicious seceders from the Jewish fold—were followed by spoliation and tragic persecution of the Jews. On the other hand many Jewish proselytes to Christianity have strenuously defended the Jews from the charge, among them may be particularly named Prof. D. Chwolson (*Blutanklage*, 1901). In 1840 a protest against the charge was signed by 58 Jewish-Christians, the list being headed by M. S. Alexander, Anglican bishop at Jerusalem. Further testimonies of a similar kind are collected in Strack (*op. cit.* p. 239). Many of the popes have issued bulls exonerating the Jews (cf. Strack, p. 250); similarly temporal princes have often taken a similar step (*ibid.* p. 260). Many Christian scholars and ecclesiastics have felt it their duty to utter protests in favour of the Jews. Among them have been the most eminent Christian students of Rabbinism of recent times, e.g. Professors Alexander McCaul, P. Lagarde, Franz Delitzsch, A. Merx, T. Nöldeke, C. Siegfried, A. Wünsche, G. H. Dalman and J. von Döllinger. A careful examination of the evidence (with a complete acquittal of the Jews) is contained in a notable work by a Catholic priest, F. Frank, *Der Ritualmord vor den Gerichtshöfen der Wahrheit und der Gerechtigkeit* (1901, 1902). The literature on the other side is entirely antisemitic and in no instance has it survived the ordeal of criticism. The most notorious exponent of the charge was A. Rohling, the worthlessness of whose writings on the subject is exposed by (among many others) Strack (*op. cit.* pp. 155 seq.).

A list of some of the most important of the cases is given by J. Jacob in the *Jewish Encyclopedia*, iii. 266-67. (L. A.)

RIVA, a fortified district town of Tirol, Austria, near the Italian frontier. Pop. (1900) 7550. It is a lake port and steamship station at the northern extremity of the Lago di Garda. There are two forts on the Monte Brione a little over

¹ *Das Blut im Glauben und Aberglauben* (Eng. trans. *The Jew and Human Sacrifice*, London, 1909).

a mile north-east of the town, and the old castle of La Rocca was reconstructed and extended in accordance with modern requirements in 1850. The Minorite Church (1603), with altar pictures by Guido Reni and other Italian painters, is much frequented as a place of pilgrimage. In addition to its transit trade and the entertainment of visitors, the principal resources of the town are the manufacture of paper, iron wares and pottery, the cultivation of the silk-worm and the olive tree, and a considerable commerce in timber, planks and coal. Riva is connected with the Ledro valley by a picturesque road which passes in a series of tunnels and galleries along the rocky and precipitous west shore of the lake.

RIVAL, one who competes with another, one who strives to out-do or excel another or to gain an object or end before or in preference to another. The Latin *rivalis*, which was in classical Latin used of a competitor in love, meant by derivation one who used the same brook or stream (*rivus*) as another, hence a neighbour; thus in the *Digest*, xliii. 20, l. 26, "si inter rivales, id est qui per eundem rivum aquam ducunt, sit contentio de aquae usu." The term naturally applied more particularly to those who lived on opposite sides of a stream which would be a frequent subject of dispute as to rights.

RIVAROL, ANTOINE DE (1753-1801), French writer and epigrammatist, was born at Bagnols in Languedoc on the 26th of June 1753, and died at Berlin on the 11th of April 1801. It seems that his father was an innkeeper but a man of cultivated tastes. The son assumed the title of comte de Rivarol, and asserted his connexion with a noble Italian family, but his enemies said that the name was really Riverot, and that the family was not noble. After various vicissitudes he appeared in Paris in 1777. After winning some academic prizes, Rivarol distinguished himself in the year 1784 by a treatise *Sur l'universalité de la langue française*, and by a translation of the *Inferno*. The year before the Revolution broke out he, with some assistance from a man of similar but lesser talent, Champcenetz,² compiled a lampoon, entitled *Petit Almanach de nos grands hommes pour 1788*, in which some writers of actual or future talent and a great many nobodies were ridiculed in the most pitiless manner. When the Revolution developed the importance of the press, Rivarol at once took up arms on the Royalist side, and wrote in the *Journal politique* of Antoine Sabatier de Castres (1742-1817) and the *Actes des Apôtres* of Jean Gabriel Peltier (1770-1825). But he emigrated in 1792, and established himself at Brussels, whence he removed successively to London, Hamburg and Berlin. Rivarol has had no rival in France except Piron in sharp conversational sayings. These were mostly ill-natured, and mostly have a merely local application. Their brilliancy, however, can escape no one. His brother, Claude François (1762-1848), was also an author. His works include *Isman, ou le fatalisme* (1793), a novel; *Le Véridique* (1827), comedy; *Essai sur les causes de la révolution française* (1827).

The works of Antoine de Rivarol were published in five volumes (Paris, 1805); selections (Paris, 1858) with introductory matter by Sainte-Beuve and others, and that edited in 1862 (2nd ed., 1880) by M. de Lescaur, may be specified. See also M. de Lescaur's *Rivarol et la société française pendant la révolution et l'émigration* (1882), and Le Breton's *Rivarol, sa vie, ses idées* (1895).

RIVE-DE-GIER, a town of east-central France, in the department of Loire, 14 m. E.N.E. of St Étienne, on the railway to Lyons. Pop. (1906) 15,338.

Situated on the Gier and the Canal de Givors, it is principally dependent on the coal industry, giving its name to a coal-basin which is a continuation of that of St Étienne. It has glass works, the products of which are celebrated on account of the fineness and purity of the sand found on the banks of

² Louis René Quantin de Richebourg, Chevalier de Champcenetz (1760-1804), died on the scaffold. He is not to be confounded with Louis Pierre, marquis de Champcenetz, governor of the Tuilleries in 1789, who escaped in 1792 through the protection of Mme. Elliott, mistress of the duc d'Orléans.

the Rhone and the Saône. There are also iron and steel works where iron goods and ironmongery of all kinds are manufactured.

Rive-de-Gier is a place of some antiquity, as appears from remains of Gallo-Roman buildings, and mosaics and coins found at various times. In the time of Henry IV. the working of the mines had already given to the locality a measure of importance.

RIVER, any considerable stream of water flowing in a defined channel. The origin and subsequent formation of rivers and the valleys along which they flow are considered under GEOGRAPHY, § *Principles of Geography*, and GEOLOGY, § viii. The word "river" is an adaptation of the O. Fr. *rivere* (mod. *rivière*), which descends through Med. Lat. *rivera*, Low Lat. *riparia*, in the sense of river-bank and river, from *ripa*, bank. The Latin for a stream or river is *rivus*, whence *rivulus*, a small stream, Eng. "rivulet," which is, therefore, distinct in origin from "river," though probably the sense of *rivus* influenced the Med. Lat. *rivera*. The etymology of *rivus* and *ripa* is disputed; some scholars refer both to the root *ri-*, to drop, flow; others take *ripa* to be from the root seen in Gr. *ῥέπειν*, to bear, English "rive," the sense being a broken cliff or steep bank.

RIVER BRETHREN, the name of a group of three Christian communities in the United States of America, descended from Swiss settlers near the Susquehanna river in Pennsylvania in 1750. The first pastor was Jacob Engle, who became head of the community in 1770. Their system is based on literal obedience to the commands of the New Testament, and they have points of similarity both with the Mennonites and with the Dunkards. They practise foot-washing and baptism by trine immersion; are strict sabbatarians and simple in their manner of life. The three branches are: (1) *The Brethren in Christ*, who are the most elaborately organized and are numerous in Ohio, Pennsylvania and Kansas; they have also formed churches in New York and in Canada, and missions in South Africa, India and Texas. In 1909 they had 174 ministers, and 65 churches with 3675 communicants. (2) *The Old Order, or Yorker Brethren*, consists of a small body which separated from the main body in 1843 and maintained more strictly the original practice. They are found specially in York county, Pennsylvania (whence the name "Yorkers"). In 1909 they had 24 ministers, 9 churches, and 423 communicants. (3) *The United Zion's Children* date from 1853, when a small body left the parent communion on minor questions of administration. They had in 1909 22 ministers and 28 churches with 749 communicants, all in Pennsylvania.

RIVER ENGINEERING. Before undertaking works for the improvement of rivers, either with the object of mitigating the effects of their inundations, or for increasing and extending their capabilities for navigation, it is most important that their physical characteristics should be investigated in each case, for these vary greatly in different rivers, being dependent upon the general configuration of the land, the nature of the surface strata and the climate of the country which the rivers traverse.

Physical Characteristics of Rivers

The size of rivers above any tidal limit and their average fresh-water discharge are proportionate to the extent of their basins, and the amount of rain which, falling over these basins, reaches the river channels in the bottom of the valleys, by which it is conveyed to the sea.

River Basins.—The basin of a river is the expanse of country, bounded by a winding ridge of high ground, over which the rainfall flows down towards the river traversing the lowest part of the valley; whereas the rain falling on the outer slope of the encircling ridge flows away to another river draining an adjacent basin. River basins vary in extent according to the configuration of the country, ranging from the insignificant drainage-areas of streams rising on high ground very near the coast and flowing straight down into the sea, up to immense tracts of great continents, when rivers, rising on the slopes of mountain ranges far inland, have to traverse vast stretches of valleys and plains before

reaching the ocean. The size of the largest river basin of any country depends on the extent of the continent in which it is situated, its position in relation to the hilly regions in which rivers generally rise and the sea into which they flow, and the distance between the source and the outlet of the river draining it.

Great Britain, with its very limited area, cannot possess large river basins, its largest being that of the Thames with an area of 5244 sq. m. Even on the mainland of Europe, river basins augment in extent on proceeding eastwards with the increasing width of the continent; in France the largest basin is that of the Loire with an area of 45,000 sq. m., while the Rhine has a basin of 86,000 sq. m. with a length of 800 m., the Danube a basin of 312,000 sq. m. with a length of 1700 m., and the Volga a basin of 563,000 sq. m. with a length of 2000 m. The more extensive continents of Asia, Africa and North and South America possess still larger river basins, the Obi in Siberia having a basin of about 1,300,000 sq. m. and a length of 3200 m., the Nile a basin of 1,500,000 sq. m. with a length of over 4000 m., and the Mississippi, flowing from north to south, having a basin of 1,244,000 sq. m. with a length of 4200 m. The vast basin of the Amazon of 2,250,000 sq. m. is due to the chain of the Andes almost bordering the Pacific coast-line, so that the river rising on its eastern slopes has to traverse nearly the whole width of South America at its broadest part before reaching the Atlantic Ocean.

Available Rainfall.—The rainfall varies considerably in different localities, both in its total yearly amount and in its distribution throughout the year; also its volume fluctuates from year to year. Even in small river basins the variations in rainfall may be considerable according to differences in elevation or distance from the sea, ranging, for instance, in the Severn basin, with an area of only 4350 sq. m., from an average of under 30 in. in the year to over 80 in. The proportion, moreover, of the rain falling on a river basin which actually reaches the river, or the available rainfall in respect to its flow, depends very largely on the nature of the surface strata, the slope of the ground and the extent to which it is covered with vegetation, and varies greatly with the season of the year. The available rainfall has, indeed, been found to vary from 75% of the actual rainfall on impermeable, bare, sloping, rocky strata, down to about 15% on flat, very permeable soils.

Fall of Rivers.—The rate of flow of rivers depends mainly upon their fall, though where two rivers of different sizes have the same fall, the larger river has the quicker flow, as its retardation by friction against its bed and banks is less in proportion to its volume than that of the smaller river. The fall of a river corresponds approximately to the slope of the country it traverses; and as rivers rise close to the highest part of their basins, generally in hilly regions, their fall is rapid near their source and gradually diminishes, with occasional irregularities, till, in traversing plains along the latter part of their course, their fall usually becomes quite gentle. Accordingly, in large basins, rivers in most cases begin as torrents with a very variable flow, and end as gently flowing rivers with a comparatively regular discharge.

Variations in the Discharge of Rivers.—The irregular flow of rivers throughout their course forms one of the main difficulties in devising works, either for mitigating inundations or for increasing the navigable capabilities of rivers. In tropical countries, subject to periodical rains, the rivers are in flood during the rainy season and have hardly any flow during the rest of the year; whilst in temperate regions, where the rainfall is more evenly distributed throughout the year, evaporation causes the available rainfall to be much less in hot summer weather than in the winter months, so that the rivers fall to their low stage in the summer and are very liable to be in flood in the winter. In fact, with a temperate climate, the year may be divided into a warm and a cold season, extending from May to October and from November to April respectively; the rivers are low and moderate floods are of rare occurrence during the first period, and the rivers are high and subject to occasional heavy floods after a

considerable rainfall during the second period in most years. The only exceptions are rivers which have their sources amongst mountains clad with perpetual snow, and are fed by glaciers; their floods occur in the summer from the melting of the snows and ice, as exemplified by the Rhone above the Lake of Geneva, and the Arve which joins it below. But even these rivers are liable to have their flow modified by the influx of tributaries subject to different conditions, so that the Rhone below Lyons has a more uniform discharge than most rivers, as the summer floods of the Arve are counteracted to a great extent by the low stage of the Saône flowing into the Rhone at Lyons, which has its floods in the winter when the Arve on the contrary is low.

Transportation of Materials by Rivers.—Another serious obstacle encountered in the improvement of rivers consists in the large quantity of detritus brought down by them in flood-time, derived mainly from the disintegration of the surface-layers of the hills and slopes in the upper parts of the valleys by glaciers, frost and rain. The power of a current to transport materials varies with its velocity, so that torrents with a rapid fall near the sources of rivers can carry down rocks, boulders and large stones, which are by degrees ground by attrition in their onward course into shingle, gravel, sand and silt, simultaneously with the gradual reduction in fall, and, consequently, in the transporting force of the current. Accordingly, under ordinary conditions, most of the materials brought down from the high lands by the torrential water-courses are carried forward by the main river to the sea, or partially strewn over flat alluvial plains during floods; and the size of the materials forming the bed of the river or borne along by the stream is gradually reduced on proceeding seawards, so that in the Po, for instance, pebbles and gravel are found for about 140 m. below Turin, sand along the next 100 m., and silt and mud in the last 110 m. When, however, the fall is largely and abruptly reduced, as in the case of rivers emerging straight from mountainous slopes upon flat plains, deposit necessarily occurs, from the materials being either too large or too great in volume to be borne along by the enfeebled current; and if the impeded river is unable to spread this detritus over the plains, its bed becomes raised by deposit, causing the river in flood-time to rise to a higher level. The materials, moreover, which are carried in suspension or rolled along the bed of the river to the sea, tend to deposit when the flow of the river slackens and is finally brought to rest on encountering the great inert mass of the sea, especially in the absence of a tide and any littoral current, and this is the cause of the formation of deltas with their shallow outlets, barring the approach to many large rivers.

Influence of Lakes on Rivers.—Sometimes a peculiar depression along part of a valley, with a rocky barrier at its lower end, causes the formation of a lake in the course of the river flowing down the valley. The intervention of a lake makes the river, on entering at the upper end, deposit all the materials with which it is charged in the still waters of the lake; and it issues at the lower end as a perfectly clear stream, which has also a very regular discharge, as its floods, in flowing into the lake, are spread over a large surface, and so produce only a very slight raising of the level. This effect is illustrated by the river Rhone, which enters the Lake of Geneva as a very turbid, torrential, glacier stream, and emerges at Geneva as a sparkling, limpid river with a very uniform flow, though in this particular case the improvement is not long maintained, owing to the confluence a short distance below Geneva of the large, rapid, glacial river, the Arve.

The influence of lakes on rivers is, indeed, wholly beneficial, in consequence of the removal of their burden of detritus and the regulation of their flow. Thus the Neva, conveying the outflow from Lake Ladoga to the Baltic, is relieved by the lake from the detritus brought down by the rivers flowing into the lake; and the Swine outlet channel of the Oder into the Baltic is freed from sediment by the river having to pass through the Stettiner Haff before reaching its mouth. The St Lawrence, again, deriving most of its supply from the chain of Great Lakes of North America, possesses a very uniform flow.

River Channels.—The discharge of the rainfall erodes the beds of rivers along the lowest parts of the valleys; but floods occur too intermittently to form and maintain a channel large enough to contain the flow. A river channel, indeed, generally suffices approximately to carry off the average flow of the river, which, whilst comprising considerable fluctuations in volume, furnishes a sufficiently constant erosive action to maintain a fairly regular channel; though rivers having soft beds and carrying down sediment erode their beds during floods and deposit alluvium in dry weather. As the velocity of a stream increases with its fall, the size of a channel conveying a definite average flow varies inversely with the fall, and the depth inversely with the width. A river channel, accordingly, often presents considerable irregularities in section, forming shallow rapids when the river flows over a rocky barrier with a considerable fall, and consisting of a succession of pools and shoals when the bed varies in compactness and there are differences in width, or when the river flows round a succession of bends along opposite banks alternately.

A river flowing through a flat alluvial plain has its current very readily deflected by any chance obstruction or by any difference in hardness of the banks, and generally follows a winding course, which tends to be intensified by the erosion of the concave banks in the bends from the current impinging against them in altering its direction round the curves. Sometimes also a large river, bringing down a considerable amount of detritus, shifts its course from time to time, owing to the obstruction produced by banks of deposit, as exemplified by the Po in traversing the portion of the Lombardy plains between Casale and the confluence of the Ticino.

Floods of Rivers.—The rise of rivers in flood-time depends not merely on the amount of the rainfall, but also on its distribution and the nature of the strata on which it falls. The upper hilly part of a river basin consists generally of impermeable strata, sometimes almost bare of vegetation; and the rain flowing quickly down the impervious, sloping ground into the water-courses and tributaries feeding the main river produces rapidly rising and high floods in these streams, which soon pass down on the cessation of the rain. The river Marne, draining an impermeable part of the Upper Seine basin, is subject to these sudden torrential floods in the cold season, as illustrated by a diagram of the variations in height of the river at St Dizier from November to March 1903-4 (fig. 2). On the contrary, rain falling on permeable strata takes longer in reaching the rivers; and the floods of these rivers rise more gradually, are less high, continue longer and subside more slowly than in rivers draining impervious strata, as indicated by the diagram of the Little Seine at Nogent during the same period, which has a permeable basin (fig. 1). A main river fed by several tributaries, some from impermeable and others from permeable strata, experiences floods of a mixed character, as shown by the diagram of the same floods in 1903-4 of the Seine at Paris, below the confluence of the torrential Marne and Yonne, where the floods of the gently flowing Upper Seine and other tributaries with permeable basins also contribute to the rise of the river (fig. 3).

High floods are caused by a heavy rainfall on land already sodden by recent rains at a period of the year when evaporation is inactive, and especially by rain falling on melting snow. A fairly simultaneous rainfall over the greater part of a moderate-sized river basin is a tolerably common occurrence; and under such conditions, the floods coming from the torrential tributaries reach their maximum height and begin to subside before the floods from the gently flowing tributaries attain their greatest rise. Exceptional floods, accordingly, only occur in a main river when a heavy rainfall takes place at such periods over different parts of the basin that the floods of the various tributaries coincide approximately in attaining their maximum at certain points in the main river.

Mitigation of Floods and Protection from Inundations.—As the size of the channel of a river is generally quite inadequate to carry down the discharge of floods, the river overflows its

banks in flood-time and inundates the adjacent low-lying lands to an extent depending upon the level of the ground and the

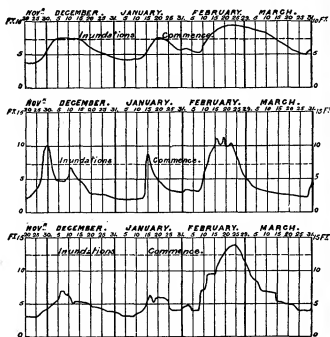

Flood Diagrams, Seine basin, 1903-1904.

FIG. 1.—Little Seine at Nogent.

FIG. 2.—Marne at St Dizier.

FIG. 3.—Seine at Paris.

volume and height of the flood. An enlargement of the bed of the river, principally by deepening it, in order to increase its discharging capacity sufficiently to prevent inundations, is precluded by the cost, and also, in rivers bringing down sediment, by the large deposit that would take place in the enlarged channel from the reduction in the velocity of the current when the flood begins to subside. Where, however, the depth of a tidal river has been considerably increased by dredging for the extension of its sea-going trade, the enlargement of its channel and the lowering of its low-water line have greatly facilitated the passage of land floods from the river above for some distance up, and consequently reduced their height; for instance, the Glasgow quays along the deepened Clyde are no longer subject to inundation, and the lands and quays bordering the Tyne have been relieved from flooding for nearly 10 m. above Newcastle by the deepening of the river from Elswick to the sea (fig. 18).

Sometimes works are carried out in a river valley for diminishing the height of floods by delaying the discharge of part of the rainfall into the main river; whilst others are designed to increase the discharging efficiency of the river channels. In certain cases, moreover, it is very important to restrict or to prevent the inundation of some riparian districts by embankments; and occasionally low-lying lands are so unfavourably situated that pumping has to be resorted to for the removal of their drainage waters.

Works in River Valleys for diminishing Floods.—Rain falling on bare, impervious, hilly slopes rapidly flows into the nearest water-course, carrying with it any loose soil or disintegrated materials met with in its rush down the ravines, thereby intensifying the torrential character of the river, increasing the height of its floods and adding to the sediment obstructing its course to the sea. By encouraging the growth of vegetation and restricting its use for pasturage, and by planting trees on the mountain slopes, which have often been denuded of their natural covering by the reckless clearing of forests, the flow of the rain off the slopes is retarded; the soil, moreover, is bound together by the roots of the plants, and the surface strata are protected from disintegration by the covering of

grass and leaves, so that the amount of detritus carried down into the river is greatly reduced.

Proposals have sometimes been made to reduce the height of floods in rivers and restrict the resulting inundations by impounding some of the flood discharge by the construction of one or more dams across the upper valley of a river, and letting it out when the flood has passed down. This arrangement, however, is open to the objection that in the event of a second flood following rapidly on the first, there might not be time to empty the reservoir for its reception. The cost, moreover, of the formation of such reservoirs could rarely be justified merely for the purpose of reducing the flood-level along an ordinary river valley. Nevertheless, when this provision against floods can be combined with the storage of water-supply for a town, it becomes financially practicable. Thus two masonry dams erected across the narrow valley of the river Furens, a torrential tributary of the Loire, form two reservoirs for the supply of the town of St Étienne, in which the water is kept down several feet below the full level in order to provide for the reception of the surplus flood-waters, and thereby protect St Étienne from inundation. Storage reservoirs also, formed solely for water-supply or irrigation, provided adequate compensation water is discharged from them during dry weather, are advantageous, like lakes, in regulating the flow of the river below.

When a river flowing through flat plains has a very small fall, it requires a proportionately large channel to carry away the drainage waters of the valley; and, accordingly, the low-lying lands bordering the river are very subject to inundations if the rainfall over the higher ground is allowed to flow straight down into the bottom of the valley. By intercepting, however, the flow off the high parts of the valley in small channels excavated along the slopes, termed "catch-water drains," the ample fall available from this higher elevation can be utilized for conveying the flow farther down the valley; and the congested river is thereby relieved for a certain part of its length from the rainfall over the higher ground.

Methods of increasing the Discharging Efficiency of River Channels.—The discharging efficiency of a river within the limits of its bed depends on the fall and the cross-section of the channel. The only way of increasing the fall is to reduce the length of the channel by substituting straight cuts for a winding course. This involves some loss of capacity in the channel as a whole, and in the case of a large river with a considerable flow it is very difficult to maintain a straight cut, owing to the tendency of the current to erode the banks and form again a sinuous channel. Even if the cut is preserved by protecting the banks, it is liable to produce changes, shoals and a raising of the flood-level in the channel just below its termination. Nevertheless, where the available fall is exceptionally small, as in lands originally reclaimed from the sea, such as the English fen districts, and where, in consequence, the drainage is in a great measure artificial, straight channels have been formed for the rivers; and on account of the importance of preserving these fertile, low-lying lands from inundation, additional straight channels have been provided for the discharge of the rainfall, known as drains in the fens. Except where a town is exposed to inundations, a considerable modification of the course of a river and an enlargement of its channel do not produce a reduction in the damage from its floods commensurate with the expenditure involved.

The removal of obstructions, whether natural or artificial, from the bed of a river furnishes a simple and efficient means of increasing the discharging capacity of its channel, and, consequently, of lowering the height of floods; for every impediment to the flow, in proportion to its extent, raises the level of the river above it so as to produce the additional artificial fall necessary to convey the flow through the restricted channel, thereby reducing the total available fall. Accidental obstructions, brought down by floods, such as trunks of trees, boulders and accumulations of gravel, require to be periodically removed. In the absence of legal enactments for the

conservancy of rivers, numerous obstructions have in many cases been placed in their channel, such as mining reefs, sluice-gates for mills, fish-traps, unduly wide piers for bridges and solid weirs, which impede the flow and raise the flood-level. Stringent prohibitions with regard to refuse, the enlargement of sluice-ways and the compulsory raising of their gates for the passage of floods, the removal of fish-traps which are frequently blocked up by leaves and floating rubbish, a reduction in the number and width of the piers of bridges when rebuilt, and the substitution of movable weirs for solid weirs, greatly facilitate the discharge of a river, and consequently lower its flood-level.

Prediction of Floods in Rivers.—By erecting gauges in a fairly large river and its tributaries at suitable points, and keeping continuous records for some time of the heights of the water at the various stations, the rise of the floods in the different tributaries, the periods they take in passing down to definite stations on the main river, and the influence they severally exercise on the height of the floods at these places, are ascertained. With the help of these records, by observing the times and heights of the maximum rise of a particular flood at the stations on the various tributaries, the time of arrival and height of the top of the flood at any station on the main river can be predicted with remarkable accuracy two or more days beforehand. By telegraphing these particulars about a high flood to places on the lower river, the weir-keepers are enabled to open fully beforehand the movable weirs for the passage of the flood, and the riparian inhabitants receive timely warning of the impending inundation.

Embankments along Rivers to prevent Inundations.—Where portions of a riverside town are situated below the maximum flood-level, or when it is important to protect land adjoining a river from inundations, the overflow of the river must be confined within continuous embankments on both sides. By placing these embankments somewhat back from the margin of the river-bed, a wide flood-channel is provided for the discharge of the river directly it overflows its banks, whilst leaving the natural channel unaltered for the ordinary flow. Low embankments may be sufficient where only exceptional summer floods have to be excluded from meadows. Occasionally the embankments are raised high enough to retain the floods during most years, whilst provision is made for the escape of the rare exceptionally high floods at special places in the embankments, where the scour of the issuing current is guarded against, and the inundation of the neighbouring land is least injurious. In this manner, the increased cost of embankments raised above the highest flood-level of rare occurrence is saved, and the danger of breaches in the banks from an unusually high flood-rise and rapid flow, with their disastrous effects, is avoided. Both the above methods afford the advantage of relieving the embanked channel of some of the sediment deposited in it by the confined flood-waters, when the surplus flow passes over the embankments.

When complete protection from inundations is required, the embankments have to be raised well above the highest flood-level, after allowing for the additional rise resulting from the confinement of the flood within the embankments, instead of spreading over the low-lying land; and they have to be made perfectly watertight and strong enough to resist the water-pressure and current of the highest floods. The system has been very extensively adopted where large tracts of fertile alluvial land below flood-level stretch for long distances away from the river. Thus the fens of Lincolnshire, Cambridgeshire and Norfolk are protected from inundations by embankments along their rivers and drains; a great portion of Holland is similarly protected; and the plains of Lombardy are shut off from the floods of the Po by embankments along each side of the river for a distance of about 265 m., extending from Cornale, 80 m. below Turin, to its outlet.

The system has been developed on a very extensive scale along the alluvial valley of the Mississippi, which is below the high flood-level of the river from Cape Girardeau, 45 m. above Cairo, to the Gulf

of Mexico, and has a length of 600 m. in a straight line with a width ranging between 20 and 80 m., and an area of 29,790 sq. m. These embankments, having been begun by the French settlers in Louisiana, are called levees, and have a total length of 1490 m. They, however, do not afford complete protection from inundations, as they are not quite continuous and are not always strong enough to withstand the water-pressure of high floods, which have a velocity but a maximum rise of 59 ft. above the lower stage of the river, and tend to increase in height owing to the improved drainage following on the extension of cultivation. Breaches, or crevasses as they are termed in the United States, resulting from a deficiency in the strength or consistency of the banks, or from their being overtopped or eroded by the current, produce a sudden rush of the flood-waters through the opening, which is much more damaging to the land in the neighbourhood of the breach than a gradual inundation. Moreover, the velocity of the outflowing water is intensified by the sloping down of the land on these alluvial plains for some distance away from the river, owing to the raising of the ground nearest the river by the gradual deposit of layers of sediment from the flood-waters when they begin to overflow the river banks. The levees on the Mississippi are breached in weak places every year during the spring floods, and are liable to be destroyed along considerable lengths by the rapid erosion resulting from their being overtopped by exceptional floods at intervals of about ten years; and in places they are undermined and overthrown by changes in the level of the river from the curving in of coarse banks at bends, necessitating reconstruction some distance back from the river at points thus threatened. When towns have been established below the flood-level of an adjoining river, like New Orleans on the Mississippi and Szegedin on the Theiss in Hungary, the channel of the river should be improved to facilitate the passage of floods past the town. The town also must be enclosed within very solid embankments, raised above the highest possible flood-level, to obviate the contingency of an exceptional flood, or a gradually raised flood-level, overtopping the protecting bank at a low part, leading to an inevitable breach and a catastrophe such as overwhelmed the greater part of Szegedin in March 1879.

Effect of Embankments in raising the River Bed.—A most serious objection to the formation of continuous, high embankments along rivers bringing down considerable quantities of detritus, especially near a part where their fall has been abruptly reduced by descending from mountain slopes on to alluvial plains, is the danger of their bed being raised by deposit, producing a rise in the flood-level, and necessitating a raising of the embankments if inundations are to be prevented. Longitudinal sections of the Po taken in 1874 and 1901 show that its bed was materially raised in this period from the confluence of the Ticino to below Caranella, in spite of the clearance of sediment effected by the rush through breaches; and therefore the completion of the embankments, together with their raising, would only eventually aggravate the injuries of inundations they have been designed to prevent, as the escape of floods from the raised river must sooner or later occur.

The periodical devastating floods of the Hwang Ho or Yellow River in China are due to the raising of the bed of its embanked channel by detritus brought down from the hills, followed by the raising of the banks, when the river is forced to rise above the level of the plains. When the river was first embanked, a considerable space was left between it and its banks on each side, which allowed for deviations in the channel, and also afforded a fair area for the deposit of detritus away from its bed, and a good width for the discharge of floods. Later, however, in order to appropriate and bring under regular cultivation the riparian land thus prudently left within the embankments and exposed to every flood, lines of inner embankments were formed close to the river, thereby greatly confining the flood-waters, and, consequently, raising the flood-level and the river-bed, besides exposing these embankments to undermining by merely a moderate change in position of the river channel. This reckless policy of securing additional land regardless of consequences has greatly contributed to the more frequent occurrence of the very widespread inundations resulting from the bursting of the vast volume of pent-up flood-waters through breaches in the banks, which descend with torrential violence upon the plains below, causing great destruction of life and property.

The restriction of the floods on the lower Mississippi by the levees, placed about double the width apart of the ordinary channel, has caused the river to enlarge its very soft alluvial bed, resulting in a lowering of the water-level at the low stage; and it is, therefore, anticipated that the further scour by floods when the levees have been made continuous will, in this instance, prevent any material raising of the flood-level by the levees.

Protection of Vessels during Floods.—On large open rivers, where vessels during high floods are exposed to injury from

large floating debris and ice floes, shelter can be provided for them in refuge ports, formed in a recess at the side under the protection of a solid jetty or embankment constructed in the river parallel to the bank, these ports being closed against floods at their upper end and having their entrance at the lower end facing down-stream. Many such ports have been provided on several German and North American rivers; where the port, being near a town, is lined with quay walls, it can also be used for river traffic, a plan adopted at the refuge port on the Main just below Frankfurt (fig. 8).

Regulation of Rivers for Navigation.

As rivers flow onward towards the sea, they experience a considerable diminution in their fall, and a progressive increase in the basin which they drain, owing to the successive influx of their various tributaries. Thus gradually their current becomes more gentle and their discharge larger in volume and less subject to abrupt variations; and, consequently, they become more suitable for navigation. Eventually, large rivers, under favourable conditions, often furnish important natural highways for inland navigation in the lower portion of their course, as, for instance, the Rhine, the Danube and the Mississippi; and works are only required for preventing changes in the course of the stream, for regulating its depth, and especially for fixing the low-water channel and concentrating the flow in it, so as to increase as far as practicable the navigable depth at the lowest stage of the water-level. Regulation works for increasing the navigable capabilities of rivers can only be advantageously undertaken in large rivers with a moderate fall and a fair discharge at their lowest stage; for with a large fall the current presents a great impediment to up-stream navigation, and there are generally great variations in water-level, and when the discharge becomes very small in the dry season it is impossible to maintain a sufficient depth of water in the low-water channel.

Removal of Shoals.—The possibility of securing uniformity of depth in a river by the lowering of the shoals obstructing the channel depends upon the nature of the shoals. A soft shoal in the bed of a river is due to deposit from a diminution in velocity of flow, produced by a reduction in fall and by a widening of the channel, or to a loss in concentration of the scour of the main current in passing over from one concave bank to the next on the opposite side. The lowering of such a shoal by dredging merely effects a temporary deepening, for it soon forms again from the causes which produced it. The removal, moreover, of the rocky obstructions at rapids, though increasing the depth and equalizing the flow at these places, produces a lowering of the river above the rapids by facilitating the efflux, which may result in the appearance of fresh shoals at the low stage of the river. Where, however, narrow rocky reefs or other hard shoals stretch across the bottom of a river and present obstacles to the erosion by the current of the soft materials forming the bed of the river above and below, their removal may prove a permanent improvement by enabling the river to deepen its bed by natural scour.

The deepening of the bed of a non-tidal river along a considerable length by dredging merely lowers the water-level of the river during the low stage; and though this deepening facilitates the passage of floods in the first instance, it does not constitute a permanent improvement even in this respect, for the deposit of the detritus brought down by the river as the floods abate soon restores the river to its original condition. Nevertheless, where sand-banks obstruct and divert the low-stage channel of a river at its low stage, as in parts of the Mississippi below Cairo, it has been found possible before the river has fallen to its lowest level to form a channel through these sand-banks, with a depth of 9 or 10 ft. and 250 ft. wide, by such devices, as by rock-jets or water-jets (see DREDGING), which discharge the sand through floating tubes into a part of the river away from the channel; and the navigation can thus be maintained throughout the low stage at a reasonable cost. Though, however, these channels across the shoals, connecting the deeper parts of the river, can be easily kept open on the Mississippi till the return of the floods, they are obliterated by the currents in flood-time, and have to be dredged out again afresh every year on the abatement of the floods.

Regulation of the Low-Water Channel.—The capability of a river to provide a waterway for navigation during the summer or throughout the dry season depends upon the depth that can be secured in the channel at the lowest stage. Owing to the small discharge and deficiency in scour during this period, it is important to restrict the width of the low-water channel, and concentrate the flow in it, and also to fix its position so that, forming the deepest part of the

bed along the line of the strongest current, it may be scoured out every year by the floods, instead of remaining an undefined and shifting channel. This is effected by closing subsidiary low-water channels with dikes across them, and narrowing the channel at the low stage by low-dipping cross dikes extended from the river banks down the slope, and pointing slightly up-stream so as to direct the water flowing over them into a central channel (figs. 4 and 5). The contraction also of the channel is often still more effectually accomplished at some parts, though at a greater cost, by low

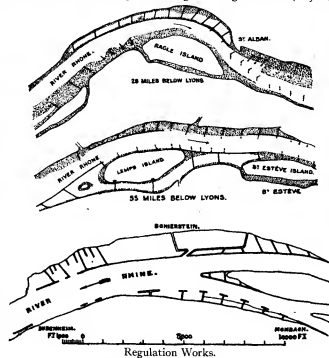

FIGS. 4 and 5.—River Rhone.
FIG. 6.—River Rhine.

longitudinal dikes placed along either side of the low-water channel, some distance forward from the banks but connected with them generally at intervals by cross dikes at the back to prevent the current from scouring out a channel behind them during floods (figs. 4 and 6). By raising these dikes only slightly above the surface of the bed of the river, except where it is expedient to produce accretion for closing an old disused channel or rectifying the course of the river, the capacity of the channel for discharging floods is not affected; for the slight obstruction to the flow produced by the dikes at the sides is fully compensated for by the deepening of the low-water channel in the central course of the river.

This system of obtaining a moderate increase in depth during the low stage of a river, whilst leaving the river quite open for navigation, has been adopted with satisfactory results on several large rivers, of which the Rhone, the Rhine and the Mississippi furnish notable examples. Regulation works were preferred on the Rhone to canalization from Lyons nearly to its outlet, in spite of its large fall, which reaches in some places 1 in 250, on account of the considerable quantities of shingle and gravel carried down by the river; the comparative regularity of the discharge, owing to the flow being derived from tributaries having their floods at different times of the year, has aided the effects of the works, which have produced an increase of about 33 ft. in the available navigable depth below Lyons at the lowest water-level. Owing, however, to the unfavourable natural condition of the river, the depth does not exceed 5 ft. at this stage; and the rapid current forms a serious impediment to up-stream navigation. The Rhine is much better adapted for improvement by regulation works than the Rhone, for it has a basin more than double the area of the Rhone basin, and its fall does not exceed 3-1 ft. per mile up at Strassburg and 2-5 ft. per mile through the rocky defile from Bingen to Kaub, and is much less along most of the length below Strassburg. These works systematically carried out in wide shallow reaches between the Dutch frontier and Mainz, aided by dredging where necessary, have secured a navigable depth at the low stage of the river of 10 ft. from the frontier to Cologne, 8½ ft. from Cologne to Kaub, and 6½ ft. through the rocky defile up to Bingen, beyond which the same depth is maintained up to Philippsburg, 22½ m. above Mannheim. Works, moreover, are in progress by which it is anticipated that the minimum depth of 6½ ft. will be extended up to Strassburg by 1916. The Mississippi also, with its extensive basin and its moderate fall in most parts, is well suited for having its navigable depth increased

by regulation works, which have been carried out below St Paul in shallow and shifting reaches, with the object of obtaining a minimum navigable depth during the low stage of 6 ft. along the upper river from St Paul to St Louis just below the confluence of the Missouri, and 8 ft. thence to Cairo at the mouth of the Ohio.

Various materials are used for the regulation works according to the respective conditions and the materials available in the locality. On the Rhone below Lyons with its rapid current, the dikes have been constructed of rubble-stone, contained above low water with concrete. The dikes on the Rhine consist for the most part of earthwork mounds protected by a layer of rubble-stone or pitching on the face, with a rubble mound forming the toe exposed to the current; but occasionally fascines are employed in conjunction with stone or simple rubble mounds. The dams closing subsidiary channels on the Mississippi are almost always constructed of fascine mattresses weighted with stone; but whereas the regulating dikes on the upper river are usually similar in construction, a common form for dikes in the United States consists of two parallel rows of piles filled in between with brushwood or other materials not affected by water, and protected at the sides from scour by an apron of fascines and stone. Other forms of dikes sometimes used are timber cribs filled with stone, single rows of sheet piling, permeable dikes composed of piles supporting thin curtains of brushwood for promoting silting at the sides, and occasionally rubble-stone in places needing special protection.

Protecting and Easing Bends.—Unless the concave banks of a river winding through wide, alluvial plains are protected from the scour of the current, the increasing curvature presents serious impediments to navigation, sometimes eventually becoming so intensified that the river at last makes a short cut for itself across the narrow strip of land at the base of the loop it has formed. This, however, produces considerable changes in the channel below, and disturbances in the navigable depth. Protection, accordingly, of concave banks is necessary to prevent excessive curvature of the channel and changes in the course of a river. On the Mississippi the very easily

ordinary summer level has to be raised by impounding the flow with weirs at intervals across the channel (see WEIR), while a lock (see CANAL and DOCK) has to be provided alongside the weir, or in a side channel, to provide for the passage of vessels (fig. 8). A river is thereby converted into a succession of fairly level reaches rising in steps up-stream, providing a comparatively still-water navigation like a canal; but it differs from a canal in the introduction of weirs for keeping up the water-level, in the provision for the regular discharge of the river at the weirs, and in the two sills of the locks being laid at the same level instead of the upper sill being raised above the lower one to the extent of the rise at the lock, as usual on canals. Canalization secures a definite available depth for navigation; and the discharge of the river generally is amply sufficient for maintaining the impounded water-level, as well as providing the necessary water for locking. The navigation, however, is liable to be stopped during the descent of high floods, which in many cases rise above the locks (fig. 7); and it is necessarily arrested in cold climates on all rivers by long, severe frosts, and especially on the break-up of the ice.

Instances of Canalized Rivers.—Many small rivers, like the Thames above its tidal limit, have been rendered navigable by canalization, and several fairly large rivers have thereby provided a good depth for vessels for considerable distances inland. Thus the canalized Seine has secured a navigable depth of 10½ ft. from its tidal limit up to Paris, a distance of 135 m., and a depth of 6½ ft. up to Montereau, 62 m. higher up. Regulation works for improving the river Main, from its confluence with the Rhine opposite Mainz up

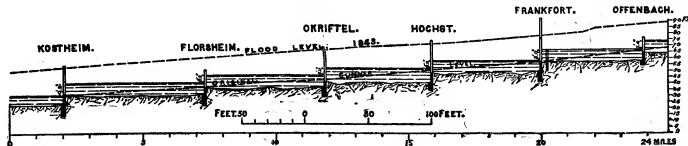

FIG. 7.—Canalized River Main.

eroded banks are protected along their upper, steeper part by stone pitching or a layer of concrete, and below low-water level by fascine mattresses weighted with stone, extended a short distance out on the bed to prevent erosion at the toe. Dikes, also, projecting into the channel from the banks reduce the curvature of the navigable channel by pushing the main current into a more central course; whilst curved longitudinal dikes placed in the channel in front of concave banks (figs. 4 and 6) are still more effective in keeping the current away from the banks, which is sometimes still further promoted by dipping cross dikes in front (fig. 5).

Regulation of Depth.—The regulation works at bends, besides arresting erosion, also reduce the differences in depth at the bends and the crossings, since they diminish the excessive depth round the concave banks and deepen the channel along the crossings, by giving a straighter course to the current and concentrating it by a reduction in width of the channel between the bends (figs. 4 and 5). Where there are deep pools at intervals in a river, shoals are always found above them, owing to the increased fall which occurs in the water line on approaching the pool, to compensate for the very slight inclination of the water-line in crossing the pool, which serves for the discharge of the river through the ample cross-section of this part of the river-bed. These variable depths can be regulated to some extent by rubble dikes or fascine mattress sills deposited across the bed of the pool, so as to reduce its excessive depth, but not raised high enough to interfere at all with the navigable depth. These obstructions in the pool raise the water-line towards its upper end, in order to provide the additional fall needed to effect the discharge through the pool with its diminished cross section; and this raising of the water-line increases the depth over the shoal above the pool, so that the general depth in these irregular parts of a river is rendered more uniform, with benefit to navigation.

Canalization of Rivers.

Rivers whose discharge is liable to become quite small at their low stage, or which have a somewhat large fall, as is usual in the upper part of rivers, cannot be given an adequate depth for navigation by regulation works alone; and their

to Frankfort, having failed to secure a minimum depth of 3 ft. at the low stage of the river, canalization works were carried out in 1883–86 by means of five weirs in the 22 m. between the Rhine and Frankfort, and provided a minimum depth of 6½ ft. (figs. 7 and 8).

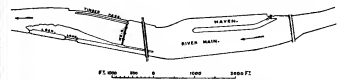

FIG. 8.—Locks, Weir and Haven near Frankfort.

This depth was subsequently increased by dredging the shoaler portion towards the upper end of each reach, due to the rise of the river-bed up-stream, so as to attain a minimum depth of 7½ ft. just below the lowest lock, and 7½ to 8½ ft. in the other reaches; whilst a sixth weir was erected at Offenbach above Frankfort (fig. 7). The Great Kanawha, Ohio, and other rivers, furnish instances of canalization works in the United States.

Limits to Canalization.—On ascending a river it becomes increasingly difficult to obtain a good depth by canalization in the upper part, owing to the progressive inclination of the river-bed; thus, even on the Seine, with its moderate fall, whereas a depth of 10½ ft. has been obtained on the Lower Seine by weirs placed on the average 1½ m. apart, on the Upper Seine weirs are required at intervals of only about ¼ m. to attain a depth of 6½ ft. Accordingly, the higher parts of rivers are only suitable for floating down trunks of trees felled on the hills, or rough rafts of timber, conveying small loads of produce, which are broken up on reaching their destination. Moreover, sometimes an abrupt fall or rocky shoals make it necessary to abandon a section of the river and to continue the navigation by lateral canal.

Small River Outlets exposed to Littoral Drift.

Rivers with a small discharge flowing straight into the sea on an exposed coast are more or less obstructed at their outlet

by drift of shingle or sand carried along the coast by the waves in the direction of the prevailing winds. When the flow falls very low in dry weather, the outlet of a river is sometimes completely closed by a continuous line of beach, any inland or tidal waters merely trickling through the obstruction; and it is only on the descent of floods that the outlet is opened out. In rivers which always have a fair fresh-water discharge, or a small fresh-water flow combined with a tidal flow and ebb, the channel sometimes has its direct outlet closed, and is deflected parallel to the shore till it reaches a weak place in the line of beach, through which a new outlet is formed; or, where the current is strong enough to keep the outlet open, a bar is formed across the entrance by the littoral drift, reducing the navigable depth.

Jetties at River Outlets.—The bar formed by littoral drift across the outlet of a river not charged with sediment and flowing into a tideless sea can be lowered by carrying out solid jetties on each side of the outlet across the foreshore, so as to scour the bar by concentrating the issuing current over it. Thus by means of jetties, aided by dredging, the depth at the entrance to the Swine mouth of the Oder has been increased from 7 ft. to 22½ ft.; the approach channels to the river Pernau (fig. 9) and other Russian rivers flowing into the Baltic have been deepened by jetties, and the outlet channels of some of the rivers flowing into the Great Lakes of North America have been improved by crib-work jetties and dredging.

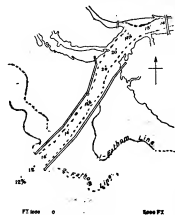

FIG. 9.—Jetty Outlet into Baltic: River Pernau.

the violent storms of the Bay of Biscay, was liable to be shifted 18 m. from its proper position, it has proved practicable to fix as well as to deepen the outlet by means of jetties (fig. 10). In such cases,

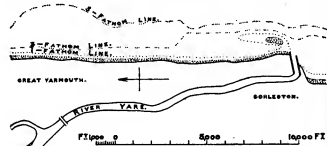

FIG. 10.—Shifting Outlet, fixed by Jetties: River Yare.

however, where the rivers flow into tidal seas, it is important to place the jetties sufficiently apart to avoid any loss of tidal influx, since the tidal flow assists the fresh-water discharge in keeping the outlet open; whereas, with rivers flowing into tideless seas, a moderate restriction of the width between the jetties increases the scour. The tortuous and somewhat shifting outlet channel of the Scheur branch of the river Maas, emerging on to a sandy coast where the rise of tide is small, and obstructed at its mouth by a bar, has been replaced by a straight cut across the Hook of Holland, and by an outlet guided across the foreshore and fixed in position by fascine mattress jetties (see JERRY), the maintenance of the depth at the mouth by the tidal and fresh waters being aided by frequent dredging (figs. 11 and 12).

Deltaic Outlets of Tideless Rivers.

Large rivers heavily charged with sand and silt, when their current is gradually arrested on entering a tideless sea, deposit these materials as a constantly advancing fan-shaped shoal in front of their mouths, through which comparatively

shallow diverging channels, almost devoid of fall, have to force their way in order to convey the fresh-water discharge

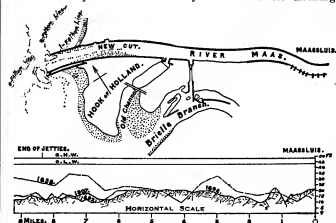

FIGS. 11 and 12.—Jetty Outlet into North Sea: River Maas.

into the sea (fig. 13). These deltaic channels deposit their burden of sediment in front of their outlets, forming bars which

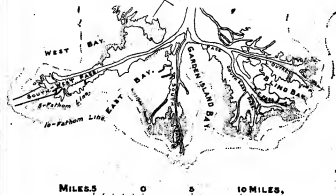

FIG. 13.—Mississippi Delta.

advance with the delta and whose rate of progress seawards and distance in front of each outlet are proportionate to the discharge of the several channels. A channel simply dredged on the bar in front of one of the outlets of a deltaic river is only maintained for a moderate period on account of the large volume of deposit continually accumulating at the outlet. Thus the channel in front of the outlet of the south-west pass of the Mississippi delta, when deepened from 13 ft. to 18 ft. over its bar by dredging many years ago, was soon silted up again on the discontinuance of the dredging; whilst the depth of the outlet channel of one of the branches of the Volga delta, which was increased from 4 ft. to 8 ft., could only be maintained by regular yearly dredging.

Parallel Jetties at Delta Outlets.—In order to procure and maintain for some time an adequate deepening across the bar in front of the outlets of delta channels, recourse has been had to the scour of the issuing current concentrated and extended out to the bar by parallel jetties, forming prolongations seawards of the banks of the channel. The requisite conditions for the success of this system of improvement are a good depth in the sea beyond the bar, allowing of a considerable deposit of alluvium before the increased depth is interfered with, and a littoral current carrying a portion of the alluvium away from the outlet, both of which retard the progression of the delta in front of the outlet and the inevitable eventual formation of a new bar farther out. The rate of advance of a delta depends also on the proportion of solid matter contained in the river water and on the specific gravity and size of the particles of alluvium discharged into the sea; for the heavier and coarser materials, and especially those which are rolled along the bed of the channels, come first to rest. Moreover, as the larger channels of a delta bring down a larger volume of alluvium on account of their larger discharge, and as their bars form farther seawards from their outlets owing to the issuing current being less rapidly arrested in proportion to the volume discharged, the rate of advance of the

delta in front of an outlet is proportionate to the size of the channel, and the length of the jetties required for lowering the bar by scour in front of any channel is proportionate to the discharge of the channel. Consequently, the conditions are more unfavourable for the improvement of the outlets of the larger delta channels than of the smaller ones; though, on the other hand, the larger channels crossing the delta are generally more suitable for navigation on account of their size, and the natural depth over their bars is greater owing to the larger discharge.

The discharge of the main branch of the Rhone, which formerly flowed into the Mediterranean and the Gulf of Foz through six mouths, was in 1852-57 concentrated in the direct eastern channel by embankments along sides, which closed all the lateral channels. The entire flow of the river, being thus discharged through the eastern outlets, increased for a time the depth over its bar from 4½ ft. to 9½ ft.; but as the great volume of alluvium brought down, including an unusually large proportion of sand rolled along the bed of the river, was also all discharged through the one outlet, the bar soon formed again farther out, and naturally advanced with the delta in front of the outlet more rapidly than formerly when the deposit was distributed through six divergent mouths. Accordingly, the very moderate deepening produced by the embankments was not long maintained, and the average depth over the bar has not exceeded 6½ ft. for many years past; the St Louis Canal was constructed to provide a deeper outlet for the navigation.¹ This want of success was due to the selection of an outlet opening on a sheltered, somewhat shallow bay, instead of a southern outlet discharging into deep water in the Mediterranean and having a deep littoral current flowing across it, and also resulted from the closing of all the other outlets, whereby the whole of the deposit, as well as all the discharge, was concentrated in front of the badly situated eastern outlet. The southern Roustan branch was reopened in 1893 to prevent the silting-up of the outlet of the St Louis Canal.

The Danube traverses its delta in three branches, the northern one of which, though conveying nearly two-thirds of the discharge of the river, is unsuitable for improvement owing to its splitting up along portions of its course into several channels, and eventually flowing into the sea through twelve mouths of a small independent delta advancing about 250 ft. annually across a shallow foreshore. The central Stna branch was selected for improvement in 1858. The southern St George branch, which had a more favourably situated outlet and a better channel through the delta, on account of the much smaller expenditure required for carrying out jetties to the bar in front of the Sulina outlet, which was only half the distance from the shore of the bar of the St George's outlet, owing to the much smaller discharge of the Sulina branch.² The jetties, begun provisionally in 1858 and subsequently consolidated and somewhat extended, were finally completed in 1877. They increased the depth over the bar from an average of about 9 ft. previously to 1858 up to 20½ ft. in 1873, which was maintained for many years. In 1893, however, the increasing draught of vessels rendered a greater depth necessary; the wide inshore portion of the jetty channel was therefore narrowed by inner parallel jetties, and a powerful dredger was set to work in the jetty channel and outside, whereby the depth was increased to 24 ft. in 1897, and was fairly maintained up to 1907, when a second dredger became necessary to cope with the shoaling. The somewhat small ratio of sediment to discharge in the Danube, the fineness of the greater portion of this sediment, its comparatively moderate amount owing to the small proportion of the discharge flowing through the Sulina branch, and its partial dispersion by the southern St George's outlet, and the fact that it prevented the rapid formation of a shoal in front of the Sulina outlet. Nevertheless, the lines of soundings are gradually advancing seawards in the line of the outlet channel, and there are signs of the formation of a new bar farther out, whilst the deposit to the south by the current and waves has deflected the deepest channel northwards. Accordingly, a prolongation of the jetties will eventually be necessary, notwithstanding the removal of a portion of the deposit from the outlet channel by dredging.

The selection of the outlet of the south pass of the Mississippi delta for improvement by parallel jetties in 1876-79, in spite of the south-west pass possessing a larger channel and a better Mississippi depth over its bar, was due, as at the Danube, to motives of economy, as the bar of the south-west pass was twice as far off from the shore as that of the south pass (fig. 13). There fascine mattress jetties, weighted with limestone, and with large concrete blocks at their exposed ends (see JETTY), 2½ and 1½ m. long, and curved slightly southwards at their outer ends to direct the sediment-bearing current more directly at right angles to the westerly littoral current, increased the depth of 8 ft. over the bar in 1875 up to 31 ft. between the jetties and out to deep water (fig. 14). The prolonged current of the river produced by the jetties has, as at the Sulina outlet, carried the main portion of the heavier sediment into fairly deep water, so that the greatest advance of the

foreshore in front of the south pass has occurred in the 70-ft. line of soundings, though the shallower soundings have also advanced.

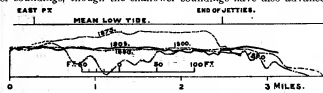

FIG. 14.—Deltaic Jetty Outlet, South Pass, Mississippi.

The shoaling, however, in the jetty channel necessitated its reduction in width by mattresses and spurs from 1000 ft. to 600 ft., and also dredging to maintain the stipulated central depth of 30 ft., and 26 ft. depth for a width of 200 ft., out to deep water; whilst the outer channel was deflected to the east and narrowed by the alluvium carried westwards by the littoral current and also deposited in front of the jetty outlet. Accordingly, dredging has been increasingly needed to straighten the channel outside and maintain its depth and width; and since the United States engineers took in hand its maintenance in 1901, the available depth of the outlet channel has been increased from 26 ft. up to 28 ft. by extensive suction dredging. In order to provide for the increasing requirements of sea-going vessels, the dredging of a channel 35 ft. deep and 1000 ft. wide, cut from the large south-west pass outlet to deep water in the gulf was begun at the end of 1903; and jetties of fascine mattresses weighted with stone and concrete blocks have been carried out about 4 and 3 m. respectively from the shore on each side of the outlet for maintaining the dredged channel³ (fig. 15). These works differ

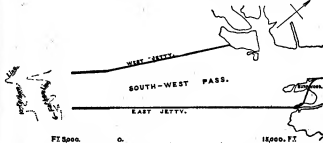

FIG. 15.—Deltaic Jetty Outlet, South Pass, Mississippi.

from the prior improvement of the south pass in the adoption mainly of suction dredging for the formation of the channel in place of scour alone, so that it will be unnecessary to restrict the width of the jetty channel to secure the desired depth; whilst as the discharge through the south-west pass is rather more than three times the discharge through the south pass, and the bar is double the distance seawards of the outlet, the slightly converging jetties, in continuation of the south-west pass, are placed about 3400 ft. apart at their outer ends, and have been given about twice the length of the south pass jetties. As soon as the dredging of the channel has been completed (which depends on the appropriations granted by Congress) the south pass will be abandoned, and the south-west pass will form the navigable approach. Dredging will be required for preserving the depth of the outlet of the south-west pass; and when the large volume of sand and other alluvium discharged by the pass accumulates in front sufficiently to begin forming a bar farther out, an extension of the jetties will be necessary to maintain the elongated channel free from drift, and extend the scour, especially in flood-time.

Improvement of Tidal Rivers for Navigation.

Whereas the size of tideless rivers depends wholly on their fresh-water discharge, the condition of tidal rivers is due to the configuration of their outlet, the rise of tide at their mouth, the distance the tide can penetrate inland, and the space available for its reception. Accordingly, tidal rivers sometimes, even when possessing a comparatively small fresh-water discharge, develop under-favourable conditions into large rivers in their lower tidal portion, having a much better natural navigable channel at high tide than the largest deltaic rivers, as shown by a comparison of the Thames, the Humber and the Elbe with the Danube, the Nile and the Mississippi. Tidal water is, indeed, unlimited in volume; but, unlike the drainage waters which must be discharged into the sea, it only flows up rivers where there is a channel and space available for its

¹ L. F. Vernon-Harcourt, *Rivers and Canals*, 2nd ed. pp. 187-90, plate 5, figs. 1 and 9.

² *Ibid.* plate 5, figs. 2, 3, 4 and 10.

³ *Report of the Chief Engineers for 1906*, pp. 382 and 1296 and charts.

reception. Consequently, it is possible to exclude the tide by injudicious works, such as the sluices which were erected long ago across the five rivers to secure the low-lying lands from the inroads of the sea; the tidal influx is also liable to be reduced by accretion in an estuary resulting from training works. The great aim, on the contrary, of all tidal river improvement should be to facilitate to the utmost the flow of the flood-tide up a river, to remove all obstructions from the channel so as to render the scouring efficiency of the flood and ebb tides as great as possible, and by making the tidal flow extend as far up the river as possible to reduce to a minimum the period of slack tide when deposit takes place.

Tidal Flow in a River.—The progress of the flood-tide up a river and the corresponding ebb are very clearly shown by a diagram giving a series of simultaneous tidal lines obtained from simultaneous observations of the height of the river Hugli during a high spring-tide in the dry season, taken at intervals at several stations along the river, and exhibiting on a very distorted scale the actual water-level of the river at these periods (fig. 16). The steep form assumed

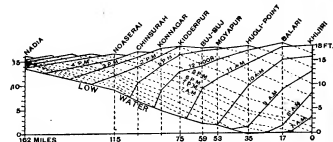

FIG. 16.—Simultaneous Tidal Lines: River Hugli.

by the foremost part of the flood-tide lines from the entrance to beyond Chinsura, attaining a maximum in the neighbourhood of Konnagar and Chinsura, indicates the existence of a bore, caused by the sand-banks in the channel obstructing the advance of the flood-tide, till it has risen sufficiently in height to rush up the river as a steep, breaking wave, overcoming all obstacles and producing a sudden reversal of the flow and abrupt rise of the water-level, as observed on the Severn, the Seine, the Amazon and other rivers. A bore indicates defects in the tidal condition and the navigable channel, which can only be reduced by lowering the obstructions and by the regulation of the river. No tidal river of even moderate length is ever completely filled by tidal water; for the tide begins to fall at its mouth before the flood-tide has produced high water at the tidal limit, as most clearly shown in the case of a long tidal river by the Hugli tidal diagram. Every improvement of the channel, however, expedites and increases the filling of the river, whilst the volume of water admitted at each tide is further augmented by the additional capacity provided by the greater eflux of the ebb, as indicated by the lowering of the low-water line.

Deepening Tidal Rivers by Dredging.—The improvement of tidal rivers mainly by dredging is specially applicable to small rivers which possess a sufficient navigable width, like the Clyde and the Tyne; for such rivers can be considerably deepened by an amount of dredging which would be quite inadequate for producing a similar increase in depth in a large, wide river, with shifting channels. Both the Clyde below Glasgow and the Tyne below Newcastle were originally insignificant rivers, almost dry in places at low water of spring-tides; and the earliest works on both rivers consisted mainly in regulating their flow and increasing their scour by jetties and training works. They have, however, been brought to their present excellent navigable condition almost wholly, since 1840 on the Clyde and 1861 on the Tyne, by continuous systematic dredging, rendered financially practicable by the growing importance of their sea-going traffic. The Clyde has been given a minimum depth of about 22 ft. at low water of spring-tides up to Glasgow, and can admit vessels of 27 to 28 ft. draught. In the Tyne (figs. 17 and 18), it was decided in 1902 to provide a minimum dredging depth in the river channel at low water of 25 ft. from the sea to the docks, of 20 ft. thence to Newcastle and of 18 ft. up to Scotswood, the rise of spring-tides increasing these depths by 15 ft. In 1906 it was determined to make the channel 30 ft. deep at low water of spring-tides from the sea to the docks, and in 1908 to deepen it between the docks and Newcastle swing bridge from 20 to 25 ft., and also between the swing bridge and Derwenthaugh from 18 to 25 ft. The natural scour of these rivers has been so much reduced by such an exceptional enlargement of their channels that a considerable amount of dredging will always be required to preserve the depth attained.

Regulation and Dredging of Tidal Rivers.—Considerable improvements in the navigable condition of tidal rivers above their outlet

or estuary can often be effected by regulation works aided by dredging, which ease sharp bends, straighten their course and render

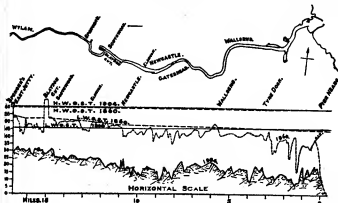

FIGS. 17 and 18.—Improvement of Tidal River by dredging: River Tyne.

their channel, depth and flow more uniform. Examples are the Nervion between Bilbao and its mouth (figs. 19 and 20), and the

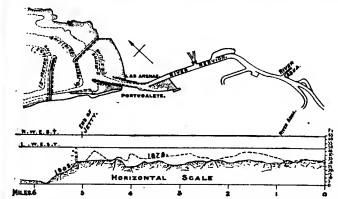

FIGS. 19 and 20.—Training Tidal River and protection of Outlet: River Nervion.

Weser from Bremen to Bremerhaven at the head of its estuary (figs. 21 and 22). These works resemble in principle the regulation works on large rivers with only a fresh-water discharge, previously described; but on tidal rivers the main low-water channel should alone be trained with an enlarging width seawards to facilitate the tidal influx, and the tidal capacity of the river above low water should be maintained unimpaired.

To secure a good and fairly uniform depth on a tidal river, it is essential that the flood and ebb tides should follow the same course, in order to combine their scouring efficiency, and form a single, continuous deep channel. In wide, winding reaches, however, the flood tide in ascending a river follows as direct a course as practicable; and on reaching a bend, the main flood-tide current, in being deflected from its straight course, hugs the concave bank, and, keeping close alongside the same bank beyond the bend, cuts into the shoal projecting from the convex bend of the bank higher up, forming a blind shoaling channel, as clearly indicated near the Moyapur Magazine in fig. 23, and a little below Shipgunj Point in fig. 24. This effect is due to the flood-tide losing its guidance, and consequently its concentration, at the change of curvature beyond the termination of the concave bank, where it spreads out and passes gradually over, in its direct course, to the next concave bend above along the opposite bank. The ebb tide, on the contrary, descending the river, follows the general course of the fresh-water discharge in all rivers, its main current in the Moyapur reach keeping close along the concave bank between Ulabaria and Hirangun Point, and crossing over opposite the point to the next concave bank below (fig. 23); whilst in the James and Mary reach the main ebb-tide current runs alongside the concave bank in front of Ninan and Nurpur, and crosses over near Hugli Point to the opposite concave bank below Gewanakhi (fig. 24). The main currents, accordingly, of the flood and ebb tides in such reaches act quite independently between the bends, forming channels on opposite sides of the river and leaving a central intervening shoal. The surveys of the two reaches of the Hugli, represented in figs. 23 and 24, having been taken in the dry season, exhibit the flood-tide channels at their deepest phase, and the ebb-tide channels in their worst and least continuous condition.

In tidal rivers the main ebb-tide current, being reinforced by

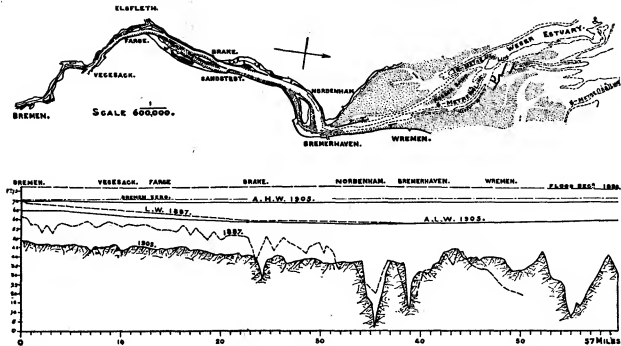

FIGS. 21 and 22.—Training Tidal River at Estuary: River Weser.

the fresh-water discharge, generally forms the navigable channel, which is scoured out during floods. Narrowing the river between the bends to bring the two channels together would unduly restrict the tidal flow; and in a river like the Hugi dependent on the tidal influx for the maintenance of its depth for two-thirds of the year, and with channels changing with the wet and dry seasons, so that deepening by dredging in the turbid river could not be permanent, training works below low water to bring the ebb-tide current into the flood-tide channel, which latter must not be obstructed at all, offer, aided by dredging, the best prospects of improvement.

Works at the Outlet of Tidal Rivers.—Tidal rivers flowing straight into the sea, without expanding into an estuary, are subject to the obstruction of a bar formed by the heaping-up action of the waves and drift along the coast, especially when the fresh-water discharge is small; and the scour of the currents is generally concentrated and extended across the beach by parallel jetties for lowering the bar, as at the outlets of the Maas (figs. 11 and 12) and of the Nervion (figs. 19 and 20). In the latter case, however, the trained outlet was still liable to be obstructed by drift during north-westerly storms in the Bay of Biscay; and, except in the case of large rivers, the jetties have to be placed too close together, if the scour is to be adequate, to form an easily accessible entrance on an exposed coast. Accordingly, a harbour has been formed in the small bay into which the Nervion flows by two converging breakwaters, which provides a sheltered approach to the river and protects the outlet from drift (fig. 19), and a similar provision has been made at Sunderland for the mouth of the Wear; whilst the Tynemouth piers formed part of the original design for the improvement of the Tyne, under shelter of which the bar has been removed by dredging (fig. 17).

Training Works through Sandy Estuaries.—Many tidal rivers flow through bays, estuaries or arms of the sea before reaching the open sea, as, for instance, the Mersey through Liverpool Bay, the Tees through its enclosed bay, the Liffey through Dublin Bay, the Thames, the Ribble, the Dee, the Shannon, the Seine, the Scheldt, the Weser and the Elbe through their respective estuaries, the Yorkshire Ouse and Trent through the Humber estuary, the Garonne and Dordogne through the Gironde estuary, and the Clyde, the Tay, the Severn and the St. Lawrence through friths or arms of the sea. These estuaries vary greatly in their tidal range, the distance inland of the ports to which they give access, and the facilities they offer for navigation. Some possess a very ample depth in their outer portion, though they generally become shallow towards their upper end; but dredging often suffices to remedy their deficiencies and to extend their deep-water channel. Thus the St. Lawrence, which possesses an ample depth from the Atlantic up to Quebec, has been rendered accessible for sea-going vessels up to Montreal by a moderate amount of dredging; whilst dredging has been resorted to in parts of the Thames and Humber estuaries, and on the Elbe a little below Hamburg, to provide for the increasing draught of vessels; and the Mersey bar in Liverpool Bay, about 11 m. seawards of the actual mouth of the river, has been lowered by suction dredging from a depth of about 9 ft. down to about 27 ft. below low water of equinoctial spring tides, to admit Atlantic liners at any state of the tide.

Some estuaries, however, are so encumbered by sand banks that their rivers can only form shallow, shifting channels through them to the sea; and these channels require to be guided or fixed by longitudinal training walls, consisting of mounds of rubble stone, chalk, slag or fascines, in order to form sufficiently deep stable channels to be available for navigation. The difficulty in such works is to fix the wandering channel adequately, and to deepen it

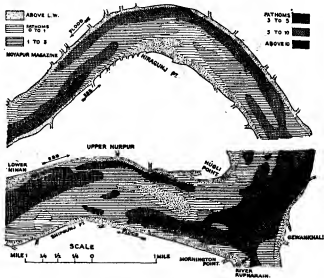

FIG. 23.—Moyapur Reach, River Hugi, Jan. 1896.
FIG. 24.—James and Mary Reach, River Hugi, April 1890.

The average rate of enlargement adopted for the trained channel of the Nervion, in proportion to its length, is 1 in 75 between Bilbao and its mouth, and 1 in 71 for the Weser from Bremen to Bremerhaven; and these ratios correspond very nearly to the enlargement of the regulated channel of the Clyde from Glasgow to Dumbarton of 1 in 83, and of the Tyne from Newcastle to its mouth of 1 in 75. Accordingly, a rate of enlargement comprised between 1 in 70 and 1 in 80 for the regulated or trained channel of the lower portion of a tidal river with a fairly level bed may be expected to give satisfactory results.

sufficiently by the scour produced between the training walls, without placing these walls so close together and raising them so high as to check the tidal influx and produce accretion behind them, thereby materially reducing the volume of tidal water entering and flowing out of the estuary at each tide. The high training works in the Dee estuary, carried out in the 18th century with the object of land reclamation, unduly narrowed the channel, and led it towards one side of the estuary; and though they effectually fixed the navigation channel, they produced very little increase in its depth, but caused a very large amount of sand to accumulate in the estuary beyond, owing to the great reduction in tidal volume by the reclamations, and diminished considerably the channel through the lower estuary in width and depth without checking its wanderings.¹ The training of the channel of the Ribble through its estuary below Preston, for improving its depth and rendering it stable, was begun in 1830, and has been gradually extended at intervals; but the works have not yet been carried out to deep water, and a shifting, shallow channel still exists through the sand banks, between the end of the training walls and the open sea. The high training walls adopted along the upper part of the channel enabled the upper end of the estuary on both sides to be

tide (figs. 25 and 26). The channel, however, was made too narrow between Aizier and Berville and was subsequently enlarged, and large tracts of land were reclaimed in the upper estuary. The reduction in tidal capacity by the reclamations, together with the fixing and undue restriction in width of the channel, occasioned very large accretions at the back of the lower portions of the training walls and at the sides of the estuary beyond them, and an extension of the sand banks seawards. Moreover, the channel has always remained shallow and unstable beyond the ends of the training walls down to deep water near the mouth of the estuary.

Conclusions about Training Works in Estuaries.—Experience has proved that training works through sandy estuaries, by stopping the wanderings of the navigable channel, produce an increase in its depth, and, consequently, in the tidal scour for maintaining it. This scour, however, being concentrated in the trained channel, is withdrawn from the sides of the estuary, which in its natural condition is stirred up periodically by the wandering channel; and, therefore, accretion takes place in the parts of the estuary from which the tidal scour and fresh-water discharge have been permanently diverted, especially where an abundance of sand from outside, put in suspension by the action of the prevalent

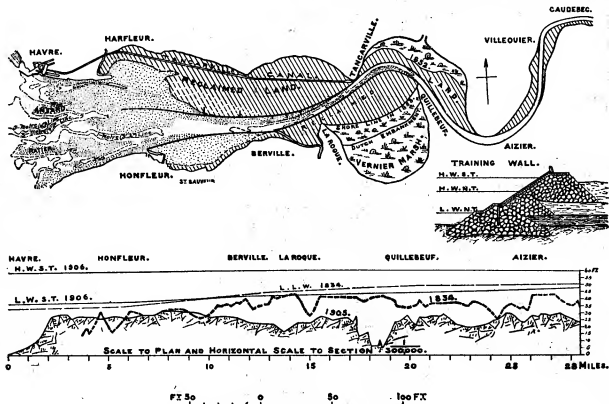

FIGS. 25 and 26.—Training Works in Sandy Estuary: River Seine.

reclaimed for a length of 4 m.; whilst the half-tide training walls below, placed unduly close together, have led to considerable accretion at the sides of the estuary and some extension of the sand banks seawards. Moreover, by fixing the channel near the northern shore they have enabled the landowners to carry out large reclamations on the southern foreshore. These works, however, besides fixing the navigable channel, have increased its depth, especially in the upper part, and augmented the tidal scour-along it by lowering the low-water line; and the trained channel is further deepened by dredging. The training works in the Weser estuary have been confined to constructing a single low training wall at the upper end, which forms a trumpet-shaped outlet for the river below Bremerhaven, and to guiding the navigable channel by occasional low dikes at the side and closing minor channels, so as to concentrate the tidal scour and fresh-water discharge in it, whilst additional depth is obtained by dredging (fig. 21). A remarkable improvement has been effected in the navigable condition of the upper portion of the Seine estuary by training works, begun in 1848; for in place of a shallow, intricate channel through shifting sand banks, whose dangers were at times intensified by a *barre*, a stable deep channel has been provided down to about half-way between Berville and St Sauveur, rendering access easy to the river above at high

winds blowing into the estuary, is brought in by the flood-tide, as in the cases of the estuaries of the Dee, the Ribble and the Seine. This accretion reduces the tidal capacity of the estuary, and, producing a diminution in the tidal volume passing through the outlet, promotes the extension of the sand banks seawards, as indicated by the difference in the outer portions of the longitudinal section at different dates of the Weser and Seine estuaries (figs. 22 and 26). To prevent as far as possible the reduction in tidal capacity, the training walls should not be raised more above low-water level than absolutely necessary to fix the channel; and the rate of enlargement of their width apart should not be less than 1 in 80 at the upper end, and should increase considerably towards the mouth of the estuary so as to form a trumpet-shaped outlet. The loss of scour in the channel resulting from this enlargement must be compensated for by dredging to attain the requisite depth. Training works partially carried out through an estuary have the advantage of reducing the length of shallow channel to be traversed between deep water and the entrance to the deepened river; but as these works produce no influence on the channel for any distance beyond their termination, a shallow, shifting channel is always found between the end of the trained channel and deep water. Accordingly, when training works are started at the head of a sandy estuary, provision should always be made in their design for their eventual

¹ L. F. Vernon-Harcourt, *Rivers and Canals*, 2nd ed. pp. 289-291. and plate 9, figs 13 and 14.

² *Id.* pp. 293-300, and plate 9, figs. 11 and 12.

prolongation to deep water at the mouth of the estuary, to ensure the formation of a stable, continuous, navigable channel. Experiments with a model, moulded to the configuration of the estuary under consideration and reproducing in miniature the tidal ebb and flow and fresh-water discharge over a bed of very fine sand, in which various lines of training walls can be successively inserted, are capable in some cases of furnishing valuable indications of the respective effects and comparative merits of the different schemes proposed for works which have often evoked very conflicting opinions and have sometimes produced most unexpected results.

(L. F. W.-H.)

RIVER-HOG, a sportsman's name for the African wild pigs of which the southern representative is known to the Boers as the boech-vark ("bush-pig"). They constitute a genus, *Potamochoerus*, nearly allied to the typical pigs of the genus *Sus* (see SWINE), from which they are distinguishable by the presence in the males of a long horny ridge below the eye; while they are further characterized by their thick coat of bristly and often brightly coloured hair, and by tufts of long bristles at the tips of the elongated and pointed ears. The southern *P. choeropotamus*, of southern and east Africa, is typically a greyish-brown animal, but one of its eastern representatives is orange-red. In north-east Africa occurs the allied *P. johnstoni*, while in Kordofan and Abyssinia this is in turn replaced by *P. hassama*. The most remarkable member of the group is, however, the red river-hog, *P. porcus*, which is a heavy, short-legged species remarkable for its bright red colour, the great length of the ear-tufts and the white rings round the eyes. It is a native of the great forest-tracts, extending from Senegambia, Liberia and Angola on the W., to Mombutu in the E. Very noteworthy is the occurrence of a small yellow-haired representative of the group (*P. larvatus*) in Madagascar, which evidently must have reached its present habitat from the mainland. (R. L. *)

RIVERINA, a large tract of pastoral country between the rivers Murray and Darling in New South Wales, Australia. It gives name to the see of an Anglican bishop who has his seat at Hay. The chief towns are Deniliquin, Hay, Moulamein, Oxley and Booligal.

RIVERS, EARL, an English title held in succession by the families of Woodville or Wydeville, Darcy and Savage. In 1209 John Rivers, or de Riparis, was summoned to parliament as a baron, and his son John was similarly summoned by Edward II. The earldom was created for Sir Richard Woodville in 1466 and remained in this family until 1491. (For the three earls of his line see below.) As borne by the Woodvilles the title was not derived from the name of a place, but from an ancient family name, Redvers, or Revers, members of this family, whose arms are quartered on the Rivers shield, having been sometime earls of Devon.

From 1626 to his death in 1640 the earldom was held by Thomas Darcy, Viscount Colchester, from whom it descended by special remainder to his grandson John (c. 1610-1654), the son of his daughter Elizabeth (d. 1651) by her marriage with Sir Thomas Savage (d. 1635), who was created Viscount Savage in 1626. John's son Thomas (c. 1626-1694) was the 3rd earl, and his grandson Richard the 4th earl (see below). The title became extinct when John, the 5th earl, died about 1735.

A new barony of Rivers, held by the family of Pitt and its later representative, that of Pitt-Rivers, was in existence from 1776 to 1880.

RIVERS, ANTHONY WOODVILLE, or WYDEVILLE, 2ND EARL (c. 1442-1483), statesman and patron of literature, and author of the first book printed on English soil, was born probably in 1442. He was the son of Richard de Wydeville and his wife, Jacquetta de Luxemburg, duchess of Bedford. His father was raised to the peerage in his son's infancy, and was made earl of Rivers in 1466. Anthony, who was knighted before he became of age, and fought at Towton in 1461, married the daughter of Lord Scales, and became a peer *jure uxoris* in 1462, two years after the death of that nobleman. Being lord of the Isle of Wight at the time, he was in 1467 appointed one of the ambassadors to treat with the duke of

¹ *Rivers and Canals*, 2nd ed. pp. 327-342, and plate 10.

Burgundy, and he exalted his office by challenging Anthony, comte de la Roche, the bastard of Burgundy, to single fight in what was one of the most famous tournaments of the age (see the elaborate narrative in Bentley's *Excerpta Historica*, 176-182). In 1469 Anthony was promoted to be lieutenant of Calais and captain of the king's armada, while holding other honorary posts. His father and brother were beheaded after the battle of Edgecot, and he succeeded in August of that year to the earldom. He accompanied Edward in his temporary flight to the Continent, and on his return to England had a share in the victory of Barnet and Tewkesbury and defended London from the Lancastrians. In 1473 he became guardian and governor to the young prince of Wales, and for the next few years there was no man in England of greater responsibility or enjoying more considerable honours in the royal service. It is now that for the first time we become aware of Lord Rivers's literary occupations. His mother, the duchess, died in 1472, and his first wife in 1473; in 1475 and the following year he went on pilgrimage to the holy places of Italy; from this time forth there was a strong tincture of serious reflection thrown over his character; he was now, as we learn from Caxton, nominated "Defender and Director of the Siege Apostolic for the Pope in England." Caxton had in 1476 rented a shop in the Sanctuary at Westminster, and here had set up a printing-press. The first MS. which he undertook in London was one sent to him by "the noble and puissant lord, Lord Antone, Erle of Ryvvers," consisting of a translation "into right good and fayr Englyssh" of Jean de Teonville's French version of a Latin work, "a glorious fair mirror to all good Christian people." In 1477 Caxton brought out this book, as *Dictes and Sayengis of the Philosophers*, and it is illustrious as the first production of an English printing-press. To this succeeded the *Moral Proverbs* of Christine de Pisan, in verse, in 1478, and a *Cordial*, in prose, in 1479. The original productions of Lord Rivers, and, in particular, his *Balades against the Seven Deadly Sins*, are lost. In 1478 a marriage was arranged between him and Margaret, sister of King James III. of Scotland, but it was mysteriously broken off. Rivers began to perceive that it was possible to rise too high for the safety of a subject, and he is now described to us as one who "conceiveth well the mutability and the unstableness of his life." After the death of Edward IV., he became the object of Richard III.'s peculiar enmity, and was beheaded by his orders at Pontefract on the 25th of June 1483. He was succeeded by his brother Richard, the 3rd and last earl of the Wydeville family, who died in 1491. Lord Rivers is spoken of by Commines as "un très-gentil chevalier," and by Sir Thomas More as "a right honourable man, as valiant of hand as politic in counsel." His protection and encouragement of Caxton were of inestimable value to English literature, and in the preface to the *Dictes* the printer gives an account of his own relations with the statesman which illustrates the dignity and modesty of Lord Rivers in a very agreeable way. Rivers was one of the purest writers of English prose of his time.

"Memoirs of Anthony, Earl Rivers" are comprised in the *Historical Illustrations of the Reign of Edward the Fourth* (ed. W. H. Blackie). (E. G.)

RIVERS, RICHARD SAVAGE, 4TH EARL (c. 1660-1712), was the second son of Thomas, 3rd earl; and after the death about 1680 of his elder brother Thomas, styled Viscount Colchester, he was designated by that title until he succeeded to the peerage. Early in life Richard Savage acquired notoriety by his dare-devilry and dissipation, and he was, too, one of the most conspicuous rakes in the society of the period. After becoming Lord Colchester on his brother's death he entered parliament as member for Wigan in 1681 and procured a commission in the Horseguards under Sarsfield in 1686. He was "the first nobleman and one of the first persons" who joined the prince of Orange on his landing in England, and he accompanied William to London. Obtaining promotion in the army, he served with distinction in Ireland and in the Netherlands, and was made major-general in 1693 and

lieutenant-general in 1702. In 1604 he succeeded his father as 4th Earl Rivers. He served abroad in 1702 under Marlborough, who formed a high opinion of his military capacity and who recommended him for the command of a force for an invasion of France in 1706. The expedition was eventually diverted to Portugal, and Rivers, finding himself superseded before anything was accomplished, returned to England, where Marlborough procured for him a command in the cavalry. The favour shown him by Marlborough did not deter Rivers from paying court to the Tories when it became evident that the Whig ascendancy was waning, and his appointment as constable of the Tower in 1710 on the recommendation of Harley and without Marlborough's knowledge was the first unmistakable intimation to the Whigs of their impending fall. Rivers now met with marked favour at court, being entrusted with a delicate mission to the elector of Hanover in 1710, which was followed by his appointment in 1711 as master-general of the ordnance, a post hitherto held by Marlborough himself. Swift, who was intimate with him, speaks of him as "an arant knave"; but the dean may have been disappointed at being unmentioned in Rivers's will, for he made a fierce comment on the earl's bequests to his mistresses and his neglect of his friends. In June 1712 Rivers was promoted to the rank of general, and became commander-in-chief in England; he died a few weeks later, on the 18th of August 1712. He married in 1679 Penelope, daughter of Roger Downes, by whom he had a daughter Elizabeth, who married the 4th earl of Barrymore. He also left several illegitimate children, two of whom were by Anne, countess of Macclesfield. Rivers's intrigue with Lady Macclesfield was the cause of that lady's divorce from her husband in 1701. Richard Savage, the poet, claimed identity with Lady Macclesfield's son by Lord Rivers, but though his story was accepted by Dr Johnson and was very generally believed, the evidence in its support is faulty in several respects. As Rivers left no legitimate son the earldom passed on his death to his cousin, John Savage, grandson of the 2nd earl, and a priest in the Roman Catholic Church, on whose death, about 1735, all the family titles became extinct.

See William Coxe, *Memoirs of Marlborough* (3 vols., London, 1818); *Letters and Despatches of Marlborough, 1702-1712*, vol. vi., edited by Sir G. Murray (5 vols., London, 1845); Gilbert Burnet, *History of his own Time* (6 vols., Oxford, 1833); F. W. Wyon, *History of Great Britain during the Reign of Queen Anne* (2 vols., London, 1876); G. E. C., *Complete Peerage*, vol. vi. (London, 1895).

RIVERS, RICHARD WOODVILLE, or **WYDEVILLE**, EARL (d. 1469), was a member of a family of small importance long settled at Grafton in Northamptonshire. His father, Richard Woodville, was a squire to Henry V., and afterwards the trusted servant of John of Bedford, in whose interest he was constable of the Tower during the troubles with Humphrey of Gloucester in 1425. The younger Richard Woodville was knighted by Henry VI. at Leicester in 1426. He served under Bedford in France, and after his master's death married his widow Jacquetta of Luxemburg. The mésalliance caused some scandal, but Woodville enjoyed the king's favour and continued to serve with honour in subordinate positions in France. He also distinguished himself at jousts in London (*Chronicles of London*, 146, 148). On the 9th of May 1448 Henry VI. created him Baron Rivers. His associations made him a strong Lancastrian. For some years he was lieutenant of Calais in Henry's interests. In 1459, when stationed at Sandwich to prevent a Yorkist landing, he was surprised by Sir John Dinham, and taken prisoner with his son Anthony to the earl of Warwick at Calais. He was, however, released in time to fight for Henry VI. at Towton. Early in the reign of Edward IV. Rivers recognized that the Lancastrian cause was lost and made his peace with the new king. The marriage of his eldest daughter, Elizabeth, widow of Sir John Grey of Groby, to Edward on the 1st of May 1464, secured the fortunes of his family. Rivers was appointed treasurer on the 4th of March 1466, and a little later created earl. Elizabeth found great alliances for her younger brothers and sisters, and the Wood-

vile influence became all-powerful at court. The power of this new family was very distasteful to the old baronial party, and especially so to Warwick. Early in 1468 Rivers's estates were plundered by Warwick's partisans, and the open war of the following year was aimed to destroy the Woodvilles. After the king's defeat at Edgecot, Rivers and his second son, John, were taken prisoners at Chepstow and executed at Kenilworth on the 12th of August 1469. Rivers had a large family. His third son, Lionel (d. 1484), was bishop of Salisbury. All his daughters made great marriages: Catherine, the sixth, was wife of Henry Stafford, 2nd duke of Buckingham (q.v.).

BIBLIOGRAPHY.—The chief contemporary authorities are the *Paston Letters*, ed. Dr James Gairdner, *The Chronicles of London*, ed. C. L. Kingsford (1905), and the *Chronicles of Commines and Waurin*. See also notices in *Calendars of State Papers, Venetian*, ed. Rawdon Browne. For modern accounts see Sir James Ramsay's *Lancaster and York* (1892), *The Political History of England*, vol. iv., by Professor C. Oman, and *The Complete Peerage*, by G. E. C. (Clonkayne). For Earl Anthony's connexion with Caxton consult William Blades's *Life of Caxton* (1861-63). (C. L. K.)

RIVERSIDE, a city of southern California, U.S.A., and the county-seat of Riverside county, situated on the Santa Ana river, in the San Bernardino valley. Pop. (1890) 4683; (1900) 7973 (1525 foreign-born); (1910) 15,212. It is served by the Atchison, Topeka & Santa Fé, the Southern Pacific and the San Pedro, Los Angeles & Salt Lake railways. The city occupies a slope (about 800-1000 ft. above sea-level), rising toward the east is beautifully built and is a winter and health resort. In the Albert S. White Park there is a notable collection of cacti; and Huntington Park is high and rocky, is well planted with trees and has a finely shaded automobile drive. Magnolia Avenue, bordered with pepper-trees, is 10 m. long and 130 ft. wide; and Victoria Avenue is similarly parked and lined with semi-tropical trees. Riverside is the seat of an important (non-reservation) boarding-school for Indians, Sherman Institute (1903), which in 1908 had 699 students. Riverside is devoted to the cultivation of oranges, lemons and other subtropical fruits, and has a large trade in these products. It is in the centre of the finest orange district of the state; near Huntington Park is the state citrus experiment station (1906), with an experimental orchard of 20 acres. The cultivation of navel oranges was first introduced from Brazil into the United States at Riverside in 1873; the two original trees, protected by an iron railing, were still standing in 1909. The domestic water supply is obtained from artesian wells. In 1870 the site of the present city, then called Jurupa Rancho, the name of the old Spanish grant, was purchased by the Southern California Colony Association. The settlement was chartered in 1883 as a city, with limits including about 56 sq. m. Riverside county was not organized until ten years later. From 1895 there were no saloons in the city.

RIVES, WILLIAM GABELL (1793-1868), American political leader and diplomat, was born in Nelson county, Virginia, on the 4th of May 1793. He attended Hampden-Sidney and William and Mary colleges, was admitted to the bar, and practised in Nelson county (till 1821) and afterwards in Albemarle county. In politics a Democrat, he served in the state constitutional convention in 1816, in the Virginia House of Delegates in 1817-19 and in 1822, and in the Federal House of Representatives in 1823-29. From 1829 to 1832 he was minister to France; in 1833 he entered the United States Senate, but in the following year resigned. From 1836 to 1845 he again served in the Senate, and in 1840-53 he was again minister to France. In February 1861 he was a delegate to the Peace Conference in Washington; he opposed secession, but was loyal to his state when it seceded, and was one of its representatives in the Confederate Congress during the Civil War. He died at the country estate of Castle Hill, Albemarle county, Virginia, on the 25th of April 1868. Rives was the author of several books, the most important being his *Life and Times of James Madison* (3 vols., Boston, 1859-68), the completion of which was prevented by his death. He was the father of Alfred Landon Rives (1830-1903), an engineer of some prominence, whose daughter, Amélie Rives (1863-), became well known as a novelist, her best known book being *The*

Quick or the Dead? (1888); she married John A. Chanler in 1888, and after their divorce married in 1896 Prince Pierre Troubetzkoy of Russia.

RIVET (O. Fr. *rivet*, from *river*, to fix, fasten together, of unknown origin; Skeat compares Icel. *rifa*, to stitch together), a metal pin or bolt used to fasten metal plates together. A rivet, made of wrought iron, copper or other malleable substance, is usually made with a head at one end, the other end being hammered out after passing through the plates so as to keep them closely fastened together. A "bolt" differs from a rivet in that one or both ends have screw-threads to hold a nut (see **SHIPBUILDING**).

RIVIERA, the narrow belt of coast which lies between the mountains and the sea all round the Gulf of Genoa in the north of Italy, extending from Nice on the W. to Spezia on the E. It is usually spoken of as Riviera di Ponente ("the coast of the setting sun"), the portion between Nice and the city of Genoa; and as Riviera di Levante ("the coast of the rising sun"), the portion from Genoa to Spezia. All this district, being open to the S. and sheltered from the N. and E. winds, enjoys a remarkably mild climate (winter mean, about 49° Fahr.); so much so that the vegetation in many places partakes of a subtropical character (e.g. the pomegranate, agave, prickly pear, date, palm and banana). Large numbers of flowers, especially roses, violets, hyacinths, &c., are grown near Nice, Mentone, Bordighera and other towns, and sent to the London and Paris markets. Bordighera is particularly noted for its noble groves of date-palms, one of the few places in Europe where these trees grow. The uncommon mildness of the climate, conjoined with the natural beauty of the coast scenery,—the steep sea-crags, the ruined towers and the range of the Maritime Alps,—attracts thousands of invalids and convalescents to spend the winter in the chain of towns and villages which stretch from the one end of the Riviera to the other, while these resorts are frequented for sea-bathing in summer by the Italians. Proceeding from W. to E. the following are the places to which visitors principally resort: Nice, Monaco (an independent principality), Monte Carlo, Mentone (the last town on the French Riviera), Ventimiglia, Bordighera, Ospedaletti, San Remo, Porto Maurizio, Oneglia, Diano Marina, Alassio, Arenzano, Pegli (in the Riviera di Ponente), and Nervi, Santa Margherita, Rapallo, Chiavari, Sestri Levante, Levante, Spezia, and San Terenzo (Lerici) in the Riviera di Levante. The Riviera labours, however, under the grave drawback of being liable to earthquakes. In the 10th century there were four such visitations, in 1818, 1831, 1854 and 1887, which especially affected the western Riviera. A railway runs close along the shore all through the Riviera, the distance from Nice to Genoa being 116 m., and the distance from Genoa to Spezia 56 m. In the latter stretch the line burrows through the many projecting headlands by means of more than eighty tunnels. The pearl of the eastern Riviera is the stretch (6 to 7 m.) between Rapallo and Chiavari. Lord Byron and Shelley both lived and wrote on the shores of the Gulf of Spezia, and Dickens wrote *The Chimes* at Genoa.

RIVIERE, BRITON (1840-), English artist, was born in London on the 14th of August 1840. His father, William Riviere, was for some years drawing-master at Cheltenham College, and afterwards an art teacher at Oxford. He was educated at Cheltenham College and at Oxford, where he took his degree in 1867. For his art training he was indebted almost entirely to his father, and early in life made for himself a place of importance among the artists of his time. His first pictures appeared at the British Institution, and in 1857 he exhibited three works at the Royal Academy, but it was not until 1863 that he became a regular contributor to the Academy exhibitions. In that year he was represented by "The Eve of the Spanish Armada," and in 1864 by a "Romeo and Juliet." Subjects of this kind did not, however, attract him long, for in 1865 he began, with a picture of a "Sleeping Deerhound," that series of paintings of animal-subjects which has since occupied him almost exclusively. Among the most

memorable of his productions are: "The Poacher's Nurse" (1866), "Circe" (1871), "Daniel" (1872), "The Last of the Garrison" (1875), "Lazarus" (1877), "Persepolis" (1878), "In Manus Tuas, Domine" (1879), "The Magician's Doorway" (1882), "Vae Victis" (1885), "Rizpah" (1886), "An Old-World Wanderer" (1887), "Of a Fool and his Folly there is no End" (1889), "A Mighty Hunter beyond the Lord" (1891), "The King's Libation" (1893), "Beyond Man's Footsteps" (1894), now in the National Gallery of British Art; "Phoebus Apollo" (1895); "Aggravation" (1896), "St George" (1900), and "To the Hills" (1901). He has also painted portraits; and at the outset of his career made some mark as an illustrator, beginning with *Punch*. He was elected an Associate of the Royal Academy in 1878, and R.A. in 1881, and received the degree of D.C.L. at Oxford in 1891.

See Sir Walter Armstrong, "Briton Riviere, R.A.; His Life and Work," *Art Annual* (1891).

RIVINGTON, CHARLES (1688-1742), British publisher, was born at Chesterfield, Derbyshire, in 1688. Coming to London as apprentice to a bookseller, he took over in 1711 the publishing business of Richard Chiswell (1639-1711), and, at the sign of the Bible and the Crown in Paternoster Row, he carried on a business almost entirely connected with theological and educational literature. He also published one of Whitefield's earliest works, and brought out an edition of the *Imitation of Christ*. In 1736 Rivington founded the company of booksellers who called themselves the "New Conger," in rivalry with the older association, the "Conger," dating from about 1700. In 1741 he published the first volume of Richardson's *Pamela*. Charles Rivington died on the 22nd of February 1742, and was succeeded by his two sons, John (1720-1792) and James (1724-1802). James emigrated to America, and pursued his trade in New York (see *NEWSPAPERS, U.S.A.*); John carried on the business on the lines marked out by his father, and was the great Church of England publisher of the day. In 1760 he was appointed publisher to the Society for Promoting Christian Knowledge, and the firm retained the agency for over seventy years. Having admitted his sons Francis (1745-1822) and Charles (1754-1831) into partnership he undertook for the "New Conger" Association the issue of a standard edition of the works of Shakespeare, Milton, Locke and other British classics; also Cruden's *Concordance*. John Rivington died on the 16th of January 1792. In 1810 John (1779-1841), the eldest son of Francis, was admitted a partner. In 1827 George (1801-1858) and Francis (1805-1885), sons of Charles Rivington, joined the firm. Rivington contracted further ties with the High Church party by the publication (1833, &c.) of *Tracts for the Times*. John Rivington died on the 21st of November 1841, his son, John Rivington (1812-1886) having been admitted a partner in 1836. George Rivington died in 1858; and in 1859 Francis Rivington retired, leaving the conduct of affairs in the hands of John Rivington and his own sons, Francis Hansard (b. 1834) and Septimus (b. 1846). In 1890 the business was sold to Messrs Longmans (*q.v.*). A business of the same character was, however, carried on from 1880 to 1893 by Mr Septimus Rivington and Mr John Guthrie Percival, as Percival & Co. This was changed in 1893 to Rivington, Percival & Co.; and in 1897 the firm revived its earlier title of Rivington & Co., maintaining its reputation for educational works and its connexion with the Moderate and High Church party.

See *The House of Rivington*, by Septimus Rivington (1894); also the *Publishers' Circular* (15th January 1885, 2nd June 1890).

RIVOLI VERONESE, a village of Venetia, Italy, in the province of Verona, on a hill on the right bank of the Adige, 13 m. N.W. of Verona, 617 ft. above sea-level. Pop. (1901) 1340. It is celebrated as the scene of the battle in which, on the 15th of January 1797, Napoleon inflicted a decisive defeat upon the Austrians commanded by Josef Alvinczi, Baron von Barberek (1735-1810) (see *FRENCH REVOLUTIONARY WARS*). A famous street in Paris (Rue de Rivoli) commemorates

the victory, and under the empire Marshal Masséna received the title of duke of Rivoli. The strong positions around Rivoli, which command the approaches from Tirol and the upper Adige into the Italian plain, have always been celebrated in military history as a formidable obstacle, and Charles V. and Prince Eugene of Savoy preferred to turn them by difficult mountain paths instead of attacking them directly. Minor engagements, such as rearguard actions and holding attacks, have consequently often taken place about them, notably in the campaign of 1796-97. An engagement of this character was fought here in 1848 between the Austrian and the Piedmontese troops.

RIXDORF, a town of Germany, lying immediately south of Berlin, of which it practically forms a suburb, though retaining its own civic administration. Pop. (1880) 18,729; (1895) 59,495; (1905) 153,650. It is connected with the metropolis by a railway (Ring-bahn) and by an electric tramway. It contains no public buildings of any interest, and is almost entirely occupied by a large industrial and artisan population, engaged in the manufacture of linoleum, furniture, cloth, pianos, beer, soap, &c.

Rixdorf is chiefly interesting as a foundation of Moravian Brethren from Bohemia, who settled here in 1737 under the protection of King Frederick William I. German Rixdorf, which is now united with Bohemian Rixdorf, was a much more ancient place, and appears as Richardsdorf in 1630 and as Riegenstorp in 1435. Before 1435 it belonged to the order of the Knights of St John.

RIZZIO, or **RICCIO**, **DAVID** (c. 1533-1566), secretary of Mary (q.v.), queen of Scots, was a native of Turin, and came to Scotland in 1561 in the train of the Piedmontese ambassador. The queen wanted a bass singer, and he entered her service as a musician, becoming also her *valet de chambre*, and in 1564 private foreign secretary. After her marriage to Darnley in 1565 his influence with Mary became paramount, and he gave himself great airs and affected considerable state, practically superseding Maitland of Lethington as secretary of state. His elevation aroused the active hostility of Darnley and the other nobles, and he was suspected of being the queen's lover. On the evening of the 9th of March 1566, the earls of Morton and Lindsay, with armed followers, entered Mary's supper chamber at Holyrood, seized Rizzio, hacked him to death with daggers, and threw his body into the courtyard.

See Ruthven's *Narrative of Riccio's Murder* (1836); and the articles on **MARY**, **QUEEN OF SCOTS**, and allied biographies.

ROACH (*Leuciscus rutilus*), a small fish belonging to the Cyprinid family, the genus *Leuciscus* having many representatives in Europe, in which the rudd, the chub and the dace are included. It may attain a length of over 12 in., but a roach of 2 lb is an unusually large one. It is good sport for anglers, but is not esteemed for the table. The general colour is silvery, with reddish fins. It does not occur in Ireland. In America, the "golden shiner" minnow (*Abramis chrysoleucus*) is sometimes called a roach.

See Greville Fennell's *Book of the Roach*, 1870.

ROADS AND STREETS. These words embrace the two divisions into which the lines of communication made by man for vehicular and pedestrian traffic between different places may be roughly classified. In current usage "road" is applied as a general term for all broad made ways from place to place, whether with separate side-paths for foot-passengers or not, while "street" is confined to the roads through towns, villages and other inhabited places, more or less lined by houses and other buildings on either side. The present article is confined to the methods adopted in making roads, from the first great road-makers, the Romans, down to modern times. The roadways of times anterior to the Romans, at least in Europe, were merely the tracks worn by the feet of pedestrians and animals, and the wheels of vehicular traffic.

Etymologically considered, "road" in its current usage is late

in its appearance. The first quotation in the *New English Dictionary* is from Shakespeare (*1 Henry IV.* 2, i. 16). The true O.E. word was *weg*, way, common to Teut. languages, and probably allied to Lat. *via*. The O.E. *rād* meant the act of riding, and is formed from *ridan*, to ride, and is thus used of a journey on horseback, and in compounds of a track or course, cf. *swanrād*, the swan's track, a poetic word for the sea- or *ström-rād*, course of a stream, *hufeolrād*, wheel-track, &c. A special use of the word, occurring as early as the Anglo-Saxon *Chron.* c. 900, was for a hostile foray, an "inroad," a "raid," which is the N. Eng. doublet of "road," and has superseded it in general use. Another use, which still survives, and shows the origin, is that of a space of water where ships may "ride at anchor in security from stress of weather, a roadstead." "Street" (O.E. *stræt*) represents the Lat. *strata via*, paved way (from *sternere*, to strew, pave). It is one of the few words adopted in O.E. from the Romans.

The earliest roads about which anything definite is known, so far as construction is concerned, are those of ancient Rome, one of the oldest of which and the most celebrated for the grandeur of its works—the Apian Way—was commenced in 312 B.C. Roman roads are remarkable for preserving a straight course from point to point regardless of obstacles which might have been easily avoided. They appear to have been often laid out in a line with some prominent landmark, and their general straightness is perhaps due to convenience in setting them out. In solidity of construction they have never been excelled, and many of them still remain, often forming the foundation of a more modern road, and in some instances constituting the road surface now used. It is consequently possible, with the help of allusions of ancient writers, to follow the ideal mode of construction, though this was not always adopted. Two parallel trenches were first cut to mark the breadth of the road; loose earth was removed until a solid foundation was reached; and it was replaced by proper material consolidated by ramming, or other means were taken to form a solid foundation for the body of the road. This appears often to have been composed of four layers, generally of local materials, though sometimes they were brought from considerable distances. The lowest layer consisted of two or three courses of flat stones, or, when these were not obtainable, of other stones, generally laid in mortar; the second layer was composed of rubble masonry of smaller stones, or a coarse concrete; the third of a finer concrete, on which was laid a pavement of polygonal blocks of hard stone jointed with the greatest nicety. The four layers are found to be often 3 ft. or more in thickness, but the lower ones were dispensed with on rock, on which the paving stones were sometimes laid almost directly. The paved part of a great road appears to have been about 14 ft. wide, and on either side, and separated from it by raised stone edgings, were unpaved sideways, each of half the width of the paved road. Where, as on many roads, the surface was not paved, it was made of hard concrete, or pebbles or flints set in mortar. Sometimes clay and marl were used instead of mortar, and it would seem that where inferior materials were used the road was made higher above the ground and rounder in cross section. Streets were paved with large polygonal blocks laid as above described, and footways with rectangular slabs. Specimens are still to be seen in Rome and Pompeii, while in Britain many of the roads were of hard gravel or had a cobbled surface. There are no traces of Roman influence in the later roads in England, but in France the Roman method appears to have been followed to some extent when new roads were constructed about the beginning of the 18th century. A foundation of stones on the flat was laid, and over that two layers of considerable thickness, of larger and smaller stones, bordered by large stones on edge, which appeared on the surface of the road. In 1764 Trésaguet set the foundation-stones on edge and reduced the thickness of the upper layers, and his method was generally followed until the influence of John Loudon McAdam (1756-1836) began to be felt. A French chaussée with accotements still retains some resemblance to the old Roman roads.

Roman roads.

The almost incredibly bad state of the roads in England towards the latter part of the 17th century appears from the accounts cited by Macaulay (*Hist. c. liii.*). It was due chiefly to the state of the law, which compelled each parish to maintain its own roads by statute labour, but the establishment of turnpike trusts and the maintenance of roads by tolls do not appear to have effected any great improvement. At the time of Arthur Young's six months' tour in 1770 the roads would seem to have been almost as bad as ever, and it is doubtful if there was much improvement up to the beginning of the 19th century. The turnpike roads were generally managed by ignorant and incompetent men until Telford and McAdam brought scientific principles and regular system to their construction and repair. The name of Telford is associated with a pitched foundation, which he did not always use, but which closely resembled that which had been long in use in France, and the name of McAdam often characterizes roads on which all his precepts are disregarded. Both insisted on thorough drainage and on the use of carefully prepared materials, and adopted a uniform cross section of moderate curvature instead of the exaggerated roundness given before; but, while Telford paid particular attention to a foundation for the broken stone, McAdam disregarded it, contending that the subsoil, however bad, would carry any weight if made dry by drainage and kept dry by an impervious covering. McAdam was engaged more with the repair of old roads than with the construction of new ones, and, though it is not possible to agree with all his doctrines, the improvement which he effected in road management and maintenance was great and lasting.

Construction of Roads.—A road should be as short as possible between two points to be connected, but straightness must often be sacrificed to avoid difficulties and expense and to secure good gradients. The latter should be as easy as practicable, having regard to the country to be traversed, and it is desirable that there should be a ruling gradient than which none should be steeper. On the level macadamized road in ordinary repair the force which the horse has to put forth to draw a load may be taken as one-thirtieth of the load. But in going uphill the horse has also to lift the load, and the additional force to be put forth on this account is very nearly equal to the load drawn, divided by the rate of gradient. Thus on a gradient of 1 in 30 the force spent in lifting is one-thirtieth of the load, and in ascending a horse has to exert twice the force required to draw the load on a level. In descending, on the other hand, on such a gradient, the vehicle, when once started, would just move of itself without pressing on the horse. A horse can without difficulty exert twice his usual force for a time, and can therefore ascend gradients of 1 in 30 on a macadamized surface without sensible diminution of speed, and can trot freely down them. These considerations have led to 1 in 30 being generally considered as the ruling gradient to be aimed at on first-class roads, though 1 in 40 has been advocated. Telford adopted 1 in 30 as the ruling gradient on the Holyhead road through North Wales, and there are only two gradients steeper, in places where they were unavoidable. All unnecessary rises and falls should be avoided, but a dead level is unfavourable for drainage, and on this account 1 in 100 to 1 in 150 is the flattest gradient that is desirable. Such slight rises and falls are probably rather favourable than otherwise to ease of draught by horses.

In transverse section, roads in the United Kingdom generally consist of a carriage-way, with spaces on each side, on one or both of which there may be a footpath, and fences and ditches. The width of the carriage-way may be from 15 ft., which allows of the easy passage of two vehicles, to 30 or 50 ft. for roads of importance near towns. The side spaces may be from 4 or 5 to 8 or 10 ft. wide; wide sides give the sun and air access to the road, and tend to keep it dry, and also afford space for the deposit of road materials and scrapings. In cuttings or on embankments the transverse section has of course to be modified. The road surface should have just enough convexity to throw the wet off freely, and a very moder-

ate amount is sufficient when a good surface is maintained. On a too convex road the traffic keeps to the middle, and wears ruts which retain the water, so that the surface is not so dry as with a flatter section which allows the traffic to distribute itself over the whole width. Telford used a cross section differing slightly from an arc of a circle in being more convex in the middle than at the sides. J. Walker recommended two straight lines joined in the middle of the road by a curve, and inclined about 1 in 24 towards the sides, the objection to which is that the flat sides are liable to wear hollow. On the whole a curve of the form of a flat ellipse is the best; the rise in the curve from the sides to the centre need not exceed one-fortieth of the width, and one-sixtieth is generally enough on well-kept roads. It is generally best to obtain the requisite convexity by rounding the formation surface or seat of the road and giving a uniform thickness to the coating of stone, but often, especially in country roads where the traffic is not very heavy and keeps mainly to the centre, the formation is made level and the convexity is obtained by using more road material at the centre than the sides. When there is not a kerb there should be a "shouldering" of sods and earth on each side to keep the road materials in place, and to form with the finished surface the water tables or side channels in which the surface drainage is collected, to be conveyed by outlets at frequent intervals to the side ditches. The outlets are open cuts through the sides or drains beneath the footpaths. The side ditches should be deep enough thoroughly to drain the foundation of the road, and cross or mitre drains under the road communicating with the side ditches may be required in wet soil. A thorough drainage of the subsoil is of the greatest importance, and it is economical in the end to go to considerable expense to secure it. In a cutting, or where there are no side ditches, the surface water may be taken off by gratings and under drains beneath the side channels.

Macadam Roads.—The thickness to be given to a road made altogether of broken stone will depend on the traffic it is intended for. On a good well-drained soil a thickness of 6 in. will make an excellent road for ordinary traffic, and McAdam's opinion that 10 in. of well-consolidated material was sufficient to carry the heaviest traffic on any substratum if properly drained has proved to be generally correct. In a new road the loss of thickness during consolidation must be allowed for, and the materials should be laid about one-half thicker than the coating is intended to be. When the materials are not rolled, a thickness of 3 to 6 in. should be laid first, and when that has partly consolidated under the traffic other coats may be added to make up the full thickness. There is great wear and waste of the materials in consolidating if they are laid too thickly at once. Inferior material is sometimes used in the lower part of the road coating, especially when the surface is to be of granite or other hard expensive stone. Thus flints or gravel may be used for the lower 5 or 6 in. of a road to be coated with 3 or 4 in. of granite. Telford covered the broken stone of new roads with $\frac{1}{2}$ in. of gravel to act as a binding material. McAdam absolutely interdicted the use of any binding material, leaving the broken stone to work in and unite by its own angles under the traffic.

If the ideas of the inventor are strictly followed, macadam, when the fine network of joints is thinly masked with hardened mud worn from the stone, comes near to a perfect surface. But stones that will pass through a ring of a given size may be twice as much in length, and unless their form is about that of a cube not exceeding $\frac{1}{4}$ in. on its longest side, they cannot be rammed or rolled into the regular mosaic characteristic of the true macadam. The best modern roads are of hand-broken stone dressed slightly on the surface with stone chips, while the mass of the road-metal is kept free from any kind of binding. Some roadmakers, however, have found the large irregularly shaped stones from the machine so difficult to consolidate that they have had to reconsider the question of binding. The engineer of Central Park, New York, found that, with the greatest care and attention to rolling, such stones would not

consolidate properly without admixture; indeed they became more intractable the more they were abraded by rolling. G. F. Deacon of Liverpool advocated a binding composed of large chips of trap rock or else of siliceous gravel from the size of three-quarters of an inch down to that of a pin's head, together with about one-fourth part of macadam sweepings obtained in wet weather. This will enable the roller to consolidate the road-metal in a third of the time required for broken stone alone. The harder materials here suggested differ essentially from the sand and dirt formerly used for binding, since they fill up all the vacant spaces and cannot be washed down.

A new road is preferably finished by rolling, since in that way the materials are consolidated with less waste, and wear and tear of vehicles is saved. A 15-ton steam-roller, 7 ft. wide, giving upwards of 2 tons weight per foot can thoroughly consolidate 1000 to 2000 sq. yds. of newly laid materials per day.

A pitched foundation, as used by Telford, consists of flat stones set on edge in courses across the road with the broader edges downwards. All inequalities must be knocked off, and small stones and chips must be firmly pinned into the interstices with a hammer, so as to form a regular convex surface with every stone fixed firmly in place. A foundation of cement concrete 6 in. thick was used by Sir J. Macneill on the Highgate Archway (London) road on a bad clay bottom, and common lime concrete was subsequently used elsewhere. A bed of lias lime concrete 12 in. thick was laid as a foundation in Southwark Street and on the Thames Embankment, but it is too expensive for a macadamized road under ordinary circumstances. Foundations of large and rough hard-core should be rolled down to a surface close enough to keep the finer pieces of road-metal from dropping down, so as to create hollows which, though they may escape the roller, will be detected by the laden wheel and by the pounding of the heavy hoof. But there is no foundation equal to sand, which has the property of spreading pressure over an enlarged area. A 12-in. bed of sand rolled down to 8 in. has been recommended, but military engineers have found that a layer of so little as 3 or 4 in. is sufficient as a foundation for macadam in very bad ground that has been rolled, or on an embankment that has had time to settle.

Tar Macadam.—Broken stone mixed with some bituminous composition has been found very suitable for suburban roads, and for towns where the nature of the traffic requires smooth roadways reasonably free from noise and dust. In its simplest form, tar macadam is made from a good hard limestone broken into the usual sizes, the fine chips being used for top-dressing. In a shed a large hearth is formed of stone flagging, under which the flues of a furnace are constructed, and upon the hearth the broken stone is spread in a layer just as thick as the heat may be able to penetrate, to dry off the moisture and make the stones distinctly hot. The load of an ordinary barrow is tipped on an iron plate and gas tar is poured over it (from 8 to 12 gals. per cubic yard), while a couple of men with shovels turn it over exactly as they would turn concrete. No more tar should be used than is required completely to blacken the whole surface of every stone; and when this has been done, the stone can be thrown upon the heap, where it may be kept for one or two months, under cover, to allow the volatile oils to evaporate. Fine siftings are treated in the same way. When it has been properly seasoned, the mass should assume a greenish lustre; and when cut into by a shovel, the particles will cling together and creep down slowly so that the heap is said to be "alive." In that state it may be used. The tar ought to be boiled, and if too thin, a little pitch may be added to it, though not enough to make the heap consolidate. A mixture of tar with pitch and creosote oil is used by more precise makers, one formula being 12 gals. tar, $\frac{1}{2}$ cwt. pitch and 2 gals. creosote oil to a ton of stone. But these ingredients differ considerably in their chemical composition, and the proportions have to be varied according to experience. Moreover, as regards the tar and pitch used in the manufacture of pave-

ments, the varieties that come directly from a vegetable source are liable to melt in hot and to become brittle in cold weather; coal tar is only moderately proof against these extremes.

Tar macadam must be put down in dry weather. If the material seems too dry, hot tar may be applied as before, but only as an expedient, and with great economy, so that the pavement may not soften in the sun. Upon a well-rolled foundation of hard material a layer of the coarser macadam should be put and rolled, then a layer of the smaller grade. For a road of light traffic a coat of the fine siftings may be put down and heavily rolled to a finished surface. For a road of heavier traffic the second coat should be dressed before rolling with tarred stone of a gauge of three-quarters of an inch to an inch and a quarter, and rolled first with a roller of not more than 10 or 12 cwt., then with one of 30 cwt. After the traffic has been turned on the road for a few days it should again be rolled as heavily as may be necessary to restore any parts that have been disturbed. But such roads are often consolidated by steam-rollers of 10 or 15 tons. For refacing an old road the prongs attached to a steam-roller will easily lift the old layer. Small depressions may be well tarred and levelled up with fine stuff, and the whole surface may be dressed every three years with tar and a fresh coat of fine chips. If the surface of the road is irregular, water will hang upon it, and frost may cause it to become slippery. The lack of affinity between granite and bitumen prevents the use of tar macadam upon roads of heavy traffic.

Concrete Macadam.—Rocks like granite and syenite may be used in combination with Portland cement. The ingredients are mixed in about the proportion of four parts of broken stone that has first been well wetted, one and a quarter or two parts of clean sharp sand, and one of cement put on in two layers, the second being rolled by hand to the required shape and to a good surface. It should remain for two or three weeks to dry and set. Want of elasticity may be urged against concrete macadam, and it is productive of dust, but in some cases it has proved satisfactory.

Gravel Roads.—Smooth rounded gravel is unsuitable for roads unless a large proportion of it is broken, and about an eighth part of ferruginous clay added for binding. Rough pit gravel that will consolidate under the roller may be applied in two or more layers, but each must be of similar composition, or the smaller stuff will work downwards. A gravel road should be always under inspection, and repairs should be done without delay. A track for equestrian exercise should be made of hoggin or fine gravel, that will remain soft when raked or harrowed and watered. It should be well drained. A foundation of rough hard core will let the hoggin pass down into it, so that the hard core will appear at the surface. The best material is rough chalk sufficiently rolled to stop the gravel while draining off the early water.

Stone Pavements.—Early pitched roadways consisted of pebbles or rounded boulders ("cobblestones") bedded in the natural surface or in sand or gravel. The next step in advance was to employ roughly squared blocks; but the wide and irregular joints admitted the water to the subsoil, and the mud worked up and the stones sank irregularly under the traffic. Telford, who was called upon to report on the street pavements of the parish of Hanover Square in 1824, saw the necessity of cutting off all connexion between the subsoil and the paving stones. He recommended a bed of about 6 in. of clean river ballast, rendered compact by being travelled upon for some time before the paving was laid, but he subsequently considered that nothing short of 12 in. of broken stone, put on in layers 4 in. thick and completely consolidated by carriages passing over them, would answer the purpose. He recommended paving stones of considerable depth and of from $4\frac{1}{2}$ to 6 or $7\frac{1}{2}$ in. in breadth for the greatest thoroughfares, and he pointed out the importance of working the stones flat on the face and square on all sides, so as to joint close and preserve the bed or base as nearly as possible of the same size as the face, and of carefully placing together in the same course stones of equal

breadth. Many pavements thus laid with stones of considerable breadth still remain, but experience proved that it was a mistake to suppose that broad stones having a large base would support better the weight and shocks of heavy traffic; on the contrary, a wide stone has a tendency to rock on its bed, and also to wear round on the top and become slippery. To obtain an even surface and a better foothold for the horses the stones were reduced in width, and in 1840 a granite pavement was laid by Walker on Blackfriars Bridge, which may be considered the first of modern set pavements. The stones were 3 in. broad and 9 deep; they were laid on a bed of concrete 1 ft. thick and were jointed with mortar. The reduction of breadth to about 3 in. was generally followed, but it was some time before a concrete foundation was employed to any great extent, the frequent breaking up to which streets are subject having prevented it. In London a foundation of broken stone has been continued in some thoroughfares, the sets being evenly bedded in gravel upon it and rammed with a heavy wooden rammer. Hard core—a mixture of broken stone, clinker, brick rubbish and old building materials—has also been largely used to form a foundation. In the northern towns of England cinders have been employed, and where the traffic is exceptionally heavy a pitched foundation of stones on edge has been laid when the sets were not paved upon an old macadamized surface. The concrete for a foundation to a paved street should be made with the best Portland cement, thoroughly mixed in proper proportions with the sand and gravel or other materials used, water being added as sparingly as possible. A thickness of 6 in. of well-made cement concrete is sufficient for the heaviest traffic, and it can be cut out in slabs for pipe-laying or repairs and can be relaid and cemented in its place. To obtain the best result a new foundation should not be paved upon for a week. A foundation of bituminous concrete is sometimes used where only a thin bed can be laid, in consequence of there being an old foundation which it is undesirable to disturb. It is made by pouring a composition of coal-tar, pitch and creosote oil while hot over broken stone levelled and rolled to the proper form, and then spreading a thin layer of smaller broken stone over the surface and rolling it in. It has the advantage that it can be paved upon a few hours after it has been laid.

The best materials for pavement sets are the hard igneous and metamorphic rocks, though millstone grit and other hard sedimentary rocks of the same nature are used when the traffic is comparatively light. Excessively hard stone which wears smooth and slippery is objectionable in spite of its durability.

Joints simply filled in with gravel are of course pervious to water, and a grout of lime or cement does not make a permanently watertight joint, as it becomes disintegrated under the vibration of the traffic. Grouted joints, however, make a good pavement when there is a foundation of concrete or broken stone or hard core. Where there is not a regular foundation imperviousness in the joints is of great importance. In some of the Lancashire towns the joints have for many years past been made by first filling them with clean gravel, well shaken in by ramming, and then pouring in a composition of coal-tar, pitch and creosote oil, which is allowed to percolate and fill up the interstices, the pavement being finished by covering it with small gravel. Joints so formed are impervious to wet and have a certain amount of elasticity; the foundation is kept dry; and the pavement with bituminous grout of this kind keeps its form well for many years. The objection is made that in hot weather the composition runs from the joints and makes the streets unpleasant for foot-passengers.

A pavement consisting of broad, smooth, well-jointed blocks of granite for the wheel tracks, and pitching between for the horse track, was laid by Walker in Commercial Road (London) for the heavy traffic to the West India Docks in 1825, and similar pavements have been successfully used elsewhere, principally for heavy traffic, in streets only wide enough for one vehicle. In Milan, Turin and other towns of northern Italy tramways of the same sort are extensively used for the

ordinary street traffic. The tractive force required is small, while the foothold on the horse track is good; but the tram-stones are slippery for horses to pass over. The rigidity of the roadway renders it more suitable for slow heavy traffic than for light quick vehicles, and the improvement in other pavements has limited the application of this one in ordinary streets.

Brick Paving.—Since about 1885 brick as a paving for carriage-ways has been adopted to a considerable extent, chiefly in the form of shale bricks, in American cities. The clay is a hydrated silicate of alumina, containing about 24% of alumina with 15% of iron, lime, soda, potash and magnesia. Lime is injurious, but alkalis to the extent of 3% are needed to ensure a slight degree of vitrification. Various tests are used to determine their liability to absorb moisture and to be abraded. That for abrasion is made by rolling half-bricks in an iron barrel or rattler in company with pieces of cast-iron for a given time, and noting the effect on the surfaces, but particularly on the angles, which should be tough enough to resist chipping. Comparisons are also made with test pieces of granite that are mixed with the bricks. To guard against chipping, the best-made bricks are pressed over again, and the upper angles rounded to a radius of three-eighths of an inch. Upon a foundation of concrete or well-rolled ballast a cushion or bed of coarse sand from half an inch to 3 in. thick is laid, and on this the bricks are set. They are then rolled till level, or are heavily rammed, a plank being interposed between the bricks and the rammer. No channel-courses are used. Pitch is poured in at the joints, but by no means on the surface, as that would make them slippery. Brick roadways have stood well under hard wear for fourteen years. Although in the United Kingdom bricks are produced unequalled for hardness and finish, no serious attempt has been made to introduce a tough brick for roadways that will neither chip nor wear smoothly. In various experiments with bricks that seemed most suitable they stood hard traffic for about a year. Clay of absolutely uniform character, and kilns that will ensure perfect equality in firing, are requisite. Slag bricks, made to interlock in the form of a double hexagon, the surface being grooved to a small pattern, have stood good tests for wear and foothold on a perfectly level surface. Many attempts have been made to use compositions, into which asphalt or cement usually enters, for making blocks or slabs, square or hexagonal, that can be laid down on a concrete foundation. A mosaic of macadam set in an iron frame is fixed by running molten slag into the back of the block. Small square pieces of oak are formed into blocks, end-grain upwards. Staffordshire blue bricks, made with holes to hold wooden plugs, have been used with some success. Broad blocks not firmly fixed down usually become loose and tilt when subjected to traffic.

Asphalt Paving.—Asphalt was first used for street paving in Paris in 1854. It was introduced in London in 1869, when Threadneedle Street was paved by the Val de Travers Asphalt Company, and since then it has been extensively used for paving both streets and footways. The material is a hard limestone impregnated with bitumen in the proportion of from 6 to 8% in the Seyssel rock, and from 10 to 12 in that from Val de Travers. Asphalts containing less than the former proportion have not sufficient coherence for street pavements, and those containing more than the latter proportion soften from heat in the summer. Asphalt is employed either as a mastic or compressed. The mastic is previously prepared in cakes and is melted for use in caldrons with a small quantity of bitumen, and for a street pavement is thoroughly mixed with sand or grit. It is spread in one thickness on a concrete foundation, covered with sand, and beaten to an even surface. This material has not proved so successful for street surfaces as compressed asphalt. To produce this, the rock asphalt, previously reduced to a fine powder by mechanical means, is heated in revolving ovens to from about 220° to 250° F., spread while still hot, and compressed into a solid mass by hot

disk-shaped rammers, and afterwards smoothed with irons heated to a dull redness. The original rock is thus, as it were, reconstructed by taking advantage of the power of coherence of the molecules under pressure when hot. In heating the powder the moisture combined in the limestone must be driven off without reducing the proportion of the bitumen more than is unavoidable. The powder cools very slowly, and may be conveyed long distances from the ovens; it may even be kept till the next day before use. When laid it should still retain a temperature of from 150° to 200°. It is spread evenly with a rake by skilled workmen for the whole width of the street to a thickness about two-fifths greater than the finished coating is intended to be. Ramping is commenced with light blows to ensure equality of compression throughout, and is continued with increased force until the whole is solidified. The ramming follows up the spreading, so that a joint is required only when the work is interrupted at the end of a day, or from some other cause. In a few hours after it has been laid an asphalt pavement may be used for traffic. When finished, its thickness may be from 1½ to 2½ in., according to the traffic; a greater thickness than the latter cannot be evenly compressed with certainty. The asphalt loses thickness by compression under the traffic for a long time and to the extent, it is said, of one-fifth or one-fourth, but the wear appears to be very small. The wear-resisting power of the asphalt is due to its elasticity; tracks are made by the wheels at first, but when thoroughly compressed by the traffic the surface retains little or no trace of the heaviest loads. Repairs are easily and quickly made by cutting out defective places and ramming in fresh heated powder, which can be done in the early morning without stopping the traffic. An unyielding foundation is indispensable; it should be of the best Portland cement concrete, 6 in. in thickness, which must be well set and perfectly dry throughout before the asphalt is laid, or the steam generated on the application of the hot powder will prevent coherence and lead to cracks and holes in the asphalt, which quickly enlarge under the traffic. For the same reason the asphalt should be laid in dry weather. The concrete foundation must be carefully formed to the proper profile, with an inclination towards the sides of not more than 1 in 50, which is sufficient with so smooth a surface. About 1 in 50 is the steepest gradient at which an asphalt pavement can be safely laid. When either dry or wet it affords good foothold for horses, but when beginning to get wet, or drying, it is often extremely slippery. This is said to be due to dirt on the surface, and not to the nature of the material. Sand is strewn over the surface to remedy the slipperiness; it tends, however, to wear out the asphalt, and great cleanliness is the best preventive. An asphalt pavement can be kept cleaner than any other, is impervious to moisture, and dries quickly. While the road is kept clean, a very slight depression is made by the horse-shoe, which for foothold is a great advantage. The noise made on asphalt by horse-traffic is about the same as that made on hard wood, and is not much more than is necessary for the safety of foot-passengers. In American cities asphalt has been adopted in a totally different form. All asphalt pavements are composed of a very large proportion, perhaps five parts in six, of a hard non-bituminous material. In America it is found cheaper to get the purer bitumen of the island of Trinidad, and to procure in the localities the bulky material required for admixture—a coarse angular sand with a little pure carbonate of lime. An asphaltic cement is made from refined asphaltum. Of this, from 12 to 15% is used with 70 to 80% of sand and 5 to 15% of limestone dust. These materials are heated and stirred together into a stiff mastic paste to form the wearing surface of the road. Upon the concrete foundation is first spread a layer of fine bituminous concrete called "binder," 1½ in. thick, to unite the wearing surface to the concrete foundation. Upon the binder the asphalt is laid to a thickness of 2 in., being spread with iron rakes and brought to its finished surface by the steam roller. Obviously this is a process requiring great judgment and

experience; but the system has become established in America, to the exclusion of European methods. Its great recommendation is the freedom from slipperiness that is said to result from the admixture of sharp sand, and this freedom is really the one quality in which asphalt pavement is seriously deficient. This system has been introduced into England.

Wood-Paving.—Wood pavements were introduced in England in 1839. Hexagonal blocks of fir, 6 to 8 in. across and 4 to 6 deep, were bedded in gravel laid on a foundation previously levelled and beaten. The blocks were either bevelled off at the edges or grooved across the face to afford foothold. Other wood pavements were tried in London about the same time, but they soon got out of order from unequal settlement of the blocks, and most of them lasted but a few years. The "improved wood pavement" was first used in London in 1871. After the foundation was formed to the proper cross-section a bed of sand 4 in. deep was laid, upon which came two layers of inch deal boards saturated with boiling tar, one layer across the other. The wooden blocks were 3 in. wide, 5 deep, and 9 long; they were dipped in tar and laid on the boards with the ends close together, but transversely the courses were spaced by fillets of wood three-fourths of an inch wide nailed to the floor and to the blocks. The joints were filled up with clean pebbles rammed in, and were run with a composition of pitch and tar, the surface being dressed with boiling tar and strewn with small sharp gravel and sand. In this pavement a somewhat elastic foundation was provided in the boards, which were also intended to prevent unequal settlement of the blocks; but the solidity of the pavement depended upon its water-tightness, for, when the surface water reached the sand, as it did sooner or later, settlement and dislocation of the blocks under the traffic arose. Pavements on this system were laid between 1872 and 1876, and were kept in repair and relaid from time to time, but about 1877 the plank foundation was abandoned for a foundation of cement concrete, which is now generally employed. Australian hard woods have to a large extent supplanted the fir and pine which were at one time used as the materials for wood-paving. The softer woods, which afford reasonably good foothold and are comparatively noiseless, wear rapidly under heavy traffic, and are very liable to decay. Moreover, the wood actually used has been of mixed qualities, and when a block fails, those near it suffer; thus holes are formed, so that the pavement has to be renewed before its time. English oak and beech, which are perhaps too hard, have been used with varying results; but the Australian woods of the genus *Eucalyptus* have been most extensively tried, and with the most satisfactory results. Those which are best known are jarrah and kauri, but tallow wood, black-butt, blue-gum, red-gum, and spotted-gum, with others, have been tried. Of these, one or two are too dense and hard to afford foothold, others are not easily procured, but jarrah and kauri are used extensively. When cut from the matured heart-wood they are uniform in quality, hard enough for durability, and rough enough to afford fairly good foothold. A very large quantity of wood has been used in London under the name of American red-gum. In substance it comes between the soft and hard woods above mentioned. Wood blocks for paving must be cut with the utmost precision as to the depth of 5 or 6 in. and the breadth of 3 in. The usual length of 8 or 9 in. should also be kept well enough for bond. A long block is liable to tilt. As to depth, although a slight depression may be of little account, the least projection in a block will be immediately noted as a jolt by the swift-moving wheel. The laying and jointing of wood blocks on concrete is still a matter of experiment. They may be set on a half-inch bed of sand, which is supposed to, though it is doubtful whether it actually does, make the pavement elastic to the tread. If the blocks are not accurately gauged, the sand enables the paviour to adjust them to a uniform surface. But the practice most approved is to pave directly upon the smoothly finished concrete, trusting for elasticity to the wood. On the revival of wood-paving it was thought necessary, for foothold, to leave

wide joints filled with small gravel grouted with cement; but this is mischievous. The cement breaks up, and when the blocks shrink, the filling-in is driven downwards, and when they again get wet, they have less room to expand, the side kerbs are driven back, and the foot-pavements are displaced, so as to require relaying. To guard against this, a space of about 2 in. has been left between the pavement and the kerb, to be temporarily filled with clay or sand, which can be cleared out as the pavement expands. But cement has no affinity for wood, and its use, together with the wide joints that were thought necessary to give foothold, has been abandoned. They permitted the edge of the block to be beaten down below the centre, so as to produce a succession of ridges, having much of the character of a "corduroy" road. Asphalted felt placed in the joints has not succeeded. A method very successfully adopted is to leave the end joints slightly open, and to place strips or laths one-tenth of an inch thick between the courses, so that hot pitch can be poured down to fill the joint and cover the surface. The roadway is then strewn with fine sharp gravel. Hard-wood blocks so laid expand very slightly, so that a space of an inch and a quarter is sufficient between the kerb and the two courses of blocks that are usually laid parallel to it; this, when filled with pitch, is more than enough to allow for expansion. Paving has been laid with close joints, small vessels of hot pitch being provided, into which each pavir dips the blocks more or less completely before laying them; but wood blocks are more commonly laid dry, a little pitch being brushed over the surface. The gradual abandonment of the wide joints once considered necessary for foothold will be noticed. Soft wood seems to wear under very heavy traffic about five times as fast as hard wood.

Plank Roads.—In opening up a new country, roads, temporary or permanent, must be made with such materials as may happen to be at hand. The plank road often used in American forests makes an excellent track for all kinds of traffic. Upon that side of the space devoted to the road, which the heavy traffic leading to a town will use, two parallel rows of sills 15 to 20 ft. long, 12 in. wide and 4 in. deep are laid longitudinally flatwise 4 ft. from centre to centre; the earth being well packed and rammed to the level of their faces. The joints are not opposite; a short piece of sill is put either under or by the side of each joint. Cross-boards about 8 ft. 3 in. long and 3 in. thick are laid down loosely, so that groups of four boards together will project on alternate sides of the road 3 or 4 in., forming a shoulder to enable vehicles to get on to the track at any point. The remainder of the road space is formed as an earthen track, 12 ft. wide, for light vehicles. Its slope outwards may be 1 in 16, that of the plank road 1 in 32. If the soil is too bad for the earthen track, short lengths of plank road of double width are made at intervals to form passing places. The cross boards are spiked down on five sills, and are sprung so as to give a fall both ways.

Log Roads.—The log road is formed across swamps by laying young trees of similar length close together. This is ridiculed as a "corduroy" road, but it is better than the swamp. Good temporary roads may be made by laying down half logs roughly squared upon the ground, close together or with spaces between of a couple of inches, into which earth is well rammed. They may be 8 or 9 ft. long, alternate logs being made to project a foot on each side for convenience of driving on and off the track.

Charcoal Roads.—When fuel is available, good roads can be formed of burned materials. Clay is burned into ballast for foundations, or for a temporary track. In American forests charcoal roads have been largely used. Logs from 6 in. to 2 ft. in diameter are piled along the whole route, the track being 9 ft. broad at the base, 6 ft. high and 2 ft. broad at the top. Dry materials for lighting are intermixed, and the track is covered up with sods and earth from the side ditches. When burned, the charcoal is simply raked down so as to form a 15-ft. road of a well-rounded section. These roads are dry and hard, and otherwise satisfactory.

The mode of carrying a road across a bog upon a foundation of faggots or brushwood is well known. In India the native roads have been made equal to heavy traffic by laying branches of the mimosa across the track. And in the great plains, where the soil, when dry, would otherwise be made deep in dust, this is entirely prevented by laying across the track a coarse reed or grass like the pampas-grass, and covering it with 3 or 4 in. of loam.

Sand Dressing.—In carrying traffic over a clay soil a covering of 3 or 4 in. of coarse sand will entirely prevent the formation of the ruts which would otherwise be cut by the wheels; and if the ground has already been deeply cut up, a dressing of sand will so alter the condition of the clay that the ridges will be reduced by the traffic, and the ruts filled in.

Noisless Roads.—A comparatively noiseless pavement may be formed with bricks made of cork granulated and mixed with fibre and asphalt; they are set in pitch, and seem to be suitable for rather steep gradients. For a perfectly noiseless pavement, such as is specially required where a carriage entrance under bedrooms is used by night, no substance is equal to indiarubber. For this purpose it is made in inch sheets about 3 ft. wide and as long as the width of the roadway; it is fixed over concrete and secured by iron clips. This arrangement carries the whole of the passenger traffic to St Pancras Station, London, and also a considerable amount of traffic passing under the Euston Square Station Hotel.

Dustless Roads.—The necessity for making roads dustless has been rendered urgent by the advent of the motor-car. The oldest and least efficacious method is to convert the dust into mud by the aid of the watering cart; at the best, however, the improvement is temporary, though attempts have been made to obtain more lasting results by using a solution of some hygroscopic salt such as calcium chloride. Various special preparations of petroleum and other oils have been introduced as palliatives, but the most promising treatment for existing macadam roads consists in distributing tar by hand or machine over the surface, care being taken to make the application in fine weather when the roads are dry. The radical solution of the problem, however, is to be sought in the adoption of improved methods and materials for construction, probably with a bituminous binding or matrix.

This same problem of the motor-car, which, by its rapidity of movement, rendered many of the old country roads in England (suitable, or at least tolerable, as they were for slow-moving traffic) positively dangerous for the new traffic by reason of their narrowness, sharp corners, &c., has been responsible for the passing by the legislature of a very important measure, the Development and Road Improvement Funds Act 1909. This act, in its second part, deals with the question of road improvement, and establishes a Road Board, making it a body corporate. The Board is given powers to make advances to county councils or other highway authorities for the construction of new roads or the improvement of existing roads, as well as itself to construct and maintain new roads. The expression "improvement of roads" is defined by the act as including the widening of a road, the cutting off corners, levelling, treating a road for mitigating dust nuisance, &c. Power is given to the Board to acquire land for the purposes of road improvements. The expenses of the Board are met out of a road improvement grant each year, the greater part of which it was proposed should be provided by diverting the tax on motor spirit and on motor vehicles levied under the Finance Act of 1909-10.

Watering.—On macadamized roads in Great Britain watering is only good for the road itself when the materials are of a very silicious nature and in dry weather. With other materials the effect is to soften the road and increase wear. In and near towns watering is required for the comfort of the inhabitants, but it should not be more than enough to lay the dust without softening the road, and the amount required for this may be greatly reduced by keeping the surface free from mud, and by sweeping off the dust when slightly wetted. Pavements are watered to cleanse them as well as to lay the dust, but it must be remembered that both wood

and asphalt are more slippery when wet, and that therefore watering should be obviated as far as possible by thorough cleansing. Hydrostatic vans, by improvements in the distributing pipes and regulating valves, water a wide track uniformly with an amount of water which can be regulated at pleasure. Where hydrants exist in connection with a water supply at high pressure, street watering can be effected by a movable hose and jet, a method much more effective in cleansing the surface, but using a much larger quantity of water. Another method which has been tried, but not much used, is to lay perforated pipes at the back of the kerb on each side of the road, from which jets are thrown upon the surface. The first jet is considerable, and the openings for the jets are liable to choke and get out of order. Deliquescent salts have been used for street watering, by which the surface is kept moist, but at the expense of the moisture in the air. Sea water has the same effect in a less degree.

Cleaning.—The principal streets of a town are generally cleaned daily, either by hand-sweeping and hand-scraping or by machines. Sir Joseph Whitworth's machine consists of a series of revolving brooms on an endless chain, whereby the mud or dust is swept up an incline into the cart. A less costly and cumbersome machine consists of a revolving brush mounted obliquely, which sweeps a track 6 ft. wide and leaves the dust or mud on one side to be gathered up by hand. A horse scraping-machine which delivers the mud at the side is also used, the blades of the scrapers being mounted obliquely and covering a width of 6 ft. For general use, more especially in the country, scraping-machines, worked by a man from side to side of the road, and scraping a width about 4 ft., are more convenient.

All street surfaces suffer from the constant breaking up and disturbance to which they are subjected for the purpose of laying and repairing gas and water pipes. Subways, either under the middle of the road or near the kerbs, in which the pipes may be laid and be always accessible, have often been advocated, and in a few instances have been constructed; but they have not hitherto found general favour.

Footways.—Gravel is the most suitable material for country or suburban footways; it should be bottomed with a coarser material, well drained and should be laid with a roller. An inclination towards the kerb of about half an inch in a foot may be given, or the surface may be rounded, to throw off the wet. Where greater cleanliness is desirable and the traffic is not too great a coal-tar concrete similar to that already described, but of smaller materials, makes a good and economical footway. The coating should be $\frac{2}{3}$ or 3 in. thick, composed of two or three layers each well rolled, the lower layer of materials of about $\frac{1}{4}$ in. gauge, and the upper of a half or a quarter of an inch gauge, with Derbyshire spar or fine granite chippings over all. Concrete footways require to be carefully made and must be allowed to set thoroughly before they are used. Concrete has a tendency to crack from contraction, especially when in a thin layer, and it is better to lay a footway in sections, with joints at intervals of about 2 yds. Concrete slabs, especially when silicated and constituting artificial stone, make an excellent footway. The material is composed of crushed granite, gravel or other suitable material, mixed with Portland cement and cast in moulds, and when set saturated with silicate of soda. This paving has proved more durable than York stone flagging, but it is more slippery, especially when made with granite. York stone makes a good and pleasant foot pavement, but is somewhat expensive considering its durability; it is apt to wear unevenly and to scale off when the stone is not of the best quality. It should not be laid of a less thickness than 2 in., or $\frac{2}{3}$ or 3 in. of metal. The joints should be square jointed, and not cut, and should be cut at the edges, and should be well bedded and jointed with mortar. Caithness flag is much more durable than York stone and wears more evenly; it is impervious to wet and dries quickly by evaporation. The edges are sawn, and the hardness of the stone renders it difficult to cut it to irregular shapes or to fit openings. Staffordshire blue bricks and bricks made of scoria from iron furnaces are both very durable, though somewhat brittle. Asphalt either laid as mastic or compressed is extensively used for footways; the former is considered inferior in durability to York stone and the latter superior to it. Asphalt should not be laid less than three-fourths of an inch thick on 4 in. of cement concrete, and 1 in. of asphalt is desirable where there is great traffic. In street ways in a street must be retained by a kerbing of granite, York stone, Purbeck or other stone sufficiently strong to stand the blows from wheels to which it is subjected. It should be at least 4 in. wide and 9 deep and in lengths of not less than 3 ft. A granite kerb is usually about 12 by 6 in., either placed on edge or laid on the flat. When set on edge a kerb is generally bedded on gravel with a mall; when laid on the flat a concrete bed is desirable.

In a macadamized street pitched or paved water channels are required to prevent the wash of the surface water from undermining the kerb. The pitching consists of cubical blocks of hard stone about 4 in. deep, bedded on sand or mortar, or preferably on a bed of concrete. A paved channel consists of flat stones about 12 in. wide inclining slightly towards the kerb. Moulded bricks and artificial stone are also used both for side-channelling and for kerbing. Such an inclination must be given to the channel as will

bring the surface water to gullies placed at proper intervals, and the level of the kerbing and consequently of the footway will depend to some extent on the surface drainage as well as on the levels of adjacent houses. To lay out a street satisfactorily the longitudinal and transverse sections must be considered in relation to these matters as well as to the levels of intersecting streets.

ROAN (O. Fr. *rouan*, *rouen*; Ital. *roano*, *rovano*); perhaps connected with *rufus*, red), a word applied to a variety of colour in an animal's coat, especially that of a horse, where there is a mixture of grey or white hair with the prevailing tint of bay, chestnut or sorrel. A sorrel when thus modified is either a strawberry-roan or a cream-roan. The term is also used of a soft, flexible kind of leather made of sheepskin, used in bookbinding as a substitute for or in imitation of morocco; but in this sense the origin is doubtful.

ROANNE, a town of east-central France, capital of an arrondissement in the department of Loire, on the left bank of the Loire, 54 m. N.W. of Lyons on the Paris-Lyons railway to Moulins. Pop. (1906) 33,981. The chief buildings are a modern town hall and the church of St Etienne (1835-1843), built in the Flamboyant Gothic style. The lycée occupies the buildings of the old college dating from the early 17th century. A fine bridge of seven arches connects Roanne with the industrial suburb of Le Coteau on the right bank of the river. The town is the seat of a sub-prefect, of tribunals of first instance and of commerce, of a chamber of commerce and a board of trade-arbitration, and has lycées for both sexes. Cotton goods form the staple manufacture, and cotton-spinning is also important. The making of knitted woollen articles gives employment to large numbers of women in the town and district. There are besides extensive engineering works, foundries, dye-works, tanneries, pottery and tile-works and other industrial establishments. As the centre of the Roannais coalfield, Roanne has trade in coal and coke. It is also the terminus of the Roanne-Nivoin Canal and the real starting-point of the Loire navigation.

Roanne (*Rodonna*, or *Roidonna*) was an ancient city of the Segusiani and a station on the great Roman road from Lyons to the ocean. In 1447 the lordship of Roannais became the property of the celebrated banker Jacques Cœur, from whom it passed as the result of a law-suit to the family of Gouffier. In their favour the title was raised to the rank of marquise and in 1566 to the rank of duchy; it became extinct in the first half of the 18th century.

ROANOKE, a river of the South Atlantic Slope, U.S.A. With the Staunton, which rises in the Appalachian Valley in southwestern Virginia, it constitutes one river, and, flowing in a general south-easterly direction, crosses the boundary between Virginia and North Carolina just above the Fall Line and discharges into Albemarle Sound. It is nearly 400 m. long, with a drainage area of 9237 sq. m. The United States government adopted a project in 1871 for clearing a channel with a minimum depth of 5 ft. at low water from its mouth to Weldon, a distance of 129 m., and in 1909, when the project was 80% completed, vessels drawing 4 ft. of water could ascend at low stages nearly to Weldon. The main river and its principal tributary, the Dan, are also navigable, for many miles above the Fall Line, by pole boats. In 1829 the Weldon Canal, 12 m. long, was opened to afford a passage around the falls, but it was abandoned in 1850.

ROANOKE, a city in (but administratively independent of) Roanoke county, Virginia, on the Roanoke river, about 55 m. W.S.W. of Lynchburg. Pop. (1890) 16,159; (1900) 21,405, of whom 5834 were negroes; (1910 census) 34,874. Roanoke is served by the Virginian railway, by the main line and the Shenandoah and the Winston-Salem divisions of the Norfolk & Western railway, and by electric railway to Vinton and to Salem. The city is about 900 ft. above sea-level and is surrounded by high hills; its picturesque situation and its nearness to famous mineral springs make it a health resort. On a mountain slope, about $\frac{1}{2}$ m. from the city limits, is the Virginia College for Young Ladies; 7 m. north of the city, at what was

formerly called Botetourt Springs (there is a sulphur spring), is Hollins Institute (1842) for girls; and in the city are the National Business College, the City Hospital (1899), private hospitals, and St Vincent's Orphan Asylum (1893) for boys, under the Sisters of Charity. Stock-raising, tobacco-growing, and coal and iron-mining are the industries of the district. Roanoke's factory product in 1905 was valued at \$5,544,907 (2.7% more than in 1900). Its railway car repair and construction shops, belonging to the Norfolk & Western railway, employed in that year 66.9% of the total number of factory wage-earners; pig-iron, structural iron, canned goods, bottles, tobacco, planing-mill products and cotton are among the manufactures. The municipal water supply comes from a reservoir at Crystal Springs at the foot of Mill Mountain near the city limits. Roanoke was the town of Big Lick (founded about 1852; incorporated in 1874; pop. in 1880, 669) until 1882, when it received its present name; in 1884 it was chartered as a city.

ROARING FORTIES, the name given to the zone in the southern hemisphere, near the 40th parallel of latitude, in which the north-westerly "anti-trade" winds attain their greatest development. Since the belt lies in the Great Southern Ocean (*g.s.*), and is little interrupted by land, the "planetary circulation" undergoes little modification and barometric gradients are steep. The "brave west winds" are accordingly of great strength, and, as in the corresponding belt of the northern hemisphere, the movement is largely broken up into the low and high pressure vortices known as cyclones and anticyclones.

ROBBER ISLAND, an island at the entrance of Table Bay, 7 m. N.N.W. of Cape Town. It is some 4 m. long by 2 broad. At its southern end is a lighthouse with a fixed light visible for 20 m. It got its name (*robber*, Dutch for seal) from the seals which formerly frequented it, now only occasional visitants. The island when discovered was uninhabited. It is first mentioned by an English seaman named Raymond, who states that in 1501 seals and penguins were there in large numbers. In 1614 ten criminals from London were landed on the island to form a settlement and supply fresh provisions to passing ships. The attempt, which ended in failure, is interesting as the first recorded settlement of English in South Africa. In the 18th century the slate quarries of Robben Island were extensively worked by the Dutch of Cape Town. The island is now noted for its leper asylum and its convict establishment. For many years an asylum for lunatics was also maintained, but in 1904 the lunatics were removed to the mainland. The common rabbit, brought from England, abounds, but its introduction to the mainland is prohibited. As early as 1657 criminals were banished to the island by the Dutch authorities at Cape Town; it has also served as the place of detention of several noted Kaffir chiefs.

See G. F. Gresley, "The Early History of Robben Island," in *The Cape Illustrated Magazine* (Oct. 1895).

ROBBER SYNOD, the name given to an irregular ecclesiastical council held at Ephesus in A.D. 449. See *EPHESUS, COUNCIL OF*.

ROBBERY (from O. Fr. *rober*, to steal), the unlawful and forcible taking of goods or money from the person of another by violence or threatened violence. Robbery is larceny (*g.s.*) with violence. It is a specific offence under the Larceny Act 1861, and is punishable by penal servitude for any term not exceeding fourteen years and not less than three years, or imprisonment for any term not exceeding two years, with or without hard labour. Under the Garrotters Act 1863, whipping may be added as part of the sentence for robbery. In Scots law robbery is termed *stouthrief*.

United States.—The nature of the offence is practically the same in America as in England, but what constitutes robbery is provided by statute in each state, as is also the punishment. The chief difference between English and American law is that the latter often divides the offences into grades and takes a liberal view of what constitutes force or fear. Train robbery is specially dealt with in some states owing to the prevalence of that species of crime.

Federal Statute.—Congress has made it piracy punishable with death to commit robbery on the high seas or on shore or in any harbour out of the jurisdiction of any state by landing from a piratical vessel (U.S. Rev. St. § 1047).

In *Alabama* it is train robbery to "enter upon or go near to any locomotive, engine, or car, on any railroad and by threats or exhibition of a deadly weapon or discharging a pistol or gun on or near such engine or car induce or compel any one to deliver up anything of value. It is punishable at the discretion of the jury by death or imprisonment for not less than ten years. Any one who stops, impedes or detains any locomotive or car with intent to commit train robbery must be punished by imprisonment for not less than ten nor more than thirty years. Conspiring to commit train robbery is punishable to the same extent (Crim. Code, §§ 5480-5482).

In *Arizona, California and Missouri* the "fear" may be that of the person robbed or of any relative of his or member of his family or of any one in his company. The punishment is imprisonment for not less than five years.

In *Arkansas and Missouri* extorting money or property by blackmail is an "attempt to rob"; it is punishable by not less than one nor more than five years' imprisonment. In *Georgia* larceny from the person is statutory robbery (*Hickey v. State* (1906), 125, Ga. 145).

Louisiana.—Train robbery is punishable by imprisonment for not less than five nor more than ten years.

Missouri.—Train robbery is punishable by death or imprisonment for not less than ten years. It may consist in placing an obstruction on the line with intent to rob.

Massachusetts.—Robbery, committed when armed with a dangerous weapon, is punishable by imprisonment for life (*Rev. L.*, 1902, ch. 207, § 17).

Minnesota.—The extreme penalty for robbery is forty years' imprisonment (*L.* 1905, ch. 114).

New Jersey.—The extreme penalty is \$3000 fine or twelve years' imprisonment.

Texas.—Falsely personating an officer and by means of arrest extorting money is robbery (*Burnside v. State* (1907), 102, S.W. Rep. 178).

ROBERT I., "THE BRUCE" (1274-1329), king of Scotland, was the son of the 7th Robert de Bruce, earl of Carrick by right of his wife Marjorie, daughter of Niel, or Nigel, earl of Carrick, and was the eighth in direct male descent from a Norman baron who came to England with William the Conqueror. After the death of Margaret, the "maid of Norway," in 1290, Bruce's grandfather, the 6th Robert de Bruce, lord of Annandale, claimed the crown of Scotland as the son of Isabella, the second daughter of David, earl of Huntingdon, and great-granddaughter of King David I.; but John de Baliol, grandson of Margaret, the eldest daughter of Edward David, was preferred by the commissioners of Edward I.

The birthplace of Bruce is not certainly known, but was probably Turnberry, his mother's castle on the coast of Ayr. The date is the 11th of July 1274. His youth is said by an English chronicler to have been passed at the court of Edward I. At an age when the mind is quick to receive the impressions which give the bent to life he must have watched the progress of the great suit for the crown of Scotland. Its issue in 1292 in favour of Baliol led his grandfather to resign Annandale to his son, the 7th Robert de Bruce, who either then or after the death of his father in 1295 assumed the title of lord of Annandale. Already on his wife's death in 1292 he had resigned the earldom of Carrick to his son, the future king, who presented the deed of resignation to Baliol at Stirling in August 1293, and offered the homage which his father, like his grandfather, was unwilling to render. Feudal law required that the king should take seisin of the earldom before regranteeing it and receiving the homage, and the sheriff of Ayr was directed to take it on Baliol's behalf. As the disputes between Edward I. of England and Baliol, which ended in Baliol losing his kingdom, commenced in this year, it is doubtful whether Bruce ever rendered homage; but he is henceforth known as earl of Carrick, though in a few instances this title is still given to his father. Both father and son sided with Edward against Baliol. In April 1294 the younger Bruce had permission to visit Ireland for a year and a half, and as a further mark of Edward's favour a respite of all debts owing by him to the exchequer.

In August 1296 Bruce and his father swore fealty to Edward I. at Berwick, but in breach of this oath, which had been renewed

at Carlisle, the younger Robert joined Sir William Wallace, who raised the standard of Scottish independence in the name of Baliol after that king had surrendered his kingdom to Edward in 1296. Urgent letters were sent ordering Bruce to support John de Warenne, earl of Surrey, Edward's general, in the summer of 1297; but, instead of complying, he assisted to lay waste the lands of those who adhered to Edward. On the 7th of July Bruce and his friends were forced to make terms by a treaty called the capitulation of Irvine. The Scottish lords were not to serve beyond the sea against their will, and were pardoned for their recent violence, in return owing allegiance to Edward. The bishop of Glasgow, James the steward, and Sir Alexander Lindsay became sureties for Bruce until he delivered his daughter Marjorie as a hostage. Wallace almost alone maintained the struggle for freedom which the nobles, as well as Baliol, had given up, and Bruce had no part in the honour of Stirling Bridge in September 1297, or the reverse of Falkirk, where in July 1298 Edward in person recovered what his generals had lost, and drove Wallace into exile. Shortly afterwards Bruce appears again to have sided with his countrymen; Annandale was wasted, while he, as Walter of Hemingford says, "when he heard of the king's coming, fled from his face and burnt the castle of Ayr which he held." Yet, when Edward was forced by home affairs to quit Scotland, Annandale and certain earldoms, including Carrick, were excepted from the districts he assigned to his followers, Bruce and other earls being treated as waverers whose allegiance might still be retained. About 1299 a regency was appointed in Scotland in the name of Baliol, and a letter of Baliol mentions Robert Bruce, lord of Carrick, as regent, along with William of Lamberton, bishop of St Andrews, and John Comyn the younger, a strange combination—Lamberton the friend of Wallace, Comyn the enemy of Bruce, and Bruce a regent in name of Baliol. Comyn in his own interest as Baliol's nephew and heir was the active regent; the insertion of the name of Bruce was an attempt to secure his co-operation. For the next four years he kept studiously in the background, waiting his time. A statement of Peter Langtoft that he was at the parliament of Lincoln in 1301, when the English barons repudiated the claim of Pope Boniface VIII. to the suzerainty of Scotland, is not to be credited, though his father may have been there. In the campaign of 1304, when Edward renewed his attempt on Scotland and reduced Stirling, Bruce supported the English king, who in one of his letters to him says, "If you complete that which you have begun, we shall hold the war ended by your deed and all the land of Scotland gained." But, while apparently aiding Edward, Bruce had taken a step which bound him to the patriotic cause. On the 11th of June, five weeks before the fall of Stirling, he met Lamberton at Cambuskenneth and entered into a secret bond by which they were to support each other against all adversaries and undertake nothing without consulting together. The death of his father in 1304 may have determined his course, and led him to prefer the chance of the Scottish crown to his English estates and the friendship of Edward.

This determination closes the first chapter of his life; the second, from 1304 to 1314, is occupied by his contest for the kingdom, which was really won at Bannockburn, though disputed until the treaty of Northampton in 1328; the last, from 1314 to his death in 1329, was the period of the establishment of his government and dynasty by an administration as skilful as his generalship. It is to the second of these that historians, attracted by its brilliancy even amongst the many romances of history and its importance to Scottish history, have directed most of their attention, and it is during it that his personal character, tried by adversity and prosperity, gradually unfolds itself. But all three periods require to be kept in view to form a just estimate of Bruce. That which terminated in 1304, though unfortunately few characteristics, personal or individual, have been preserved, shows him by his conduct to have been the normal Scottish noble of the time. A conflict of interest and of bias led to contradictory action.

and this conflict was increased in his case by his father's residence in England, his own upbringing at the English court, his family feud with Baliol and the Comyns, and the jealousy common to his class of Wallace, the mere knight, who had rallied the commons against the invader and taught the nobles what was required in a leader of the people. The merit of Bruce is that he did not despise the lesson. Prompted alike by patriotism and ambition, at the prime of manhood he chose the cause of national independence with all its perils, and stood by it with an unwavering constancy until he secured its triumph. Though it is crowded with incident, the main facts in the central decade of Bruce's life may be rapidly told. The fall of Stirling was followed by the capture and execution of Wallace in London in August 1305. Edward hoped still to conciliate the nobles and gain Scotland by a policy of clemency to all who did not dispute his authority. A parliament in London in September 1305 to which Scottish representatives were summoned, agreed to an ordinance for the government of Scotland, which, though on the model of those for Wales and Ireland, treating Scotland as a third subject province under an English lieutenant, was in other respects not severe. Bruce is reputed to have been one of the advisers who assisted in framing it; but a provision that his castle of Kildrumny was to be placed in charge of a person for whom he should answer shows that Edward, not without reason, suspected his fidelity. The details of his final breach with the English king are somewhat obscure. According to one account, the bond between Bruce and Lamberton was revealed to Edward by Comyn while Bruce was at the English court. Alarmed by a hint dropped by Edward, he left England secretly, and in the church of the Friars Minorite at Dumfries on the 10th of February 1306 met Comyn, whom he slew before the high altar for refusing to join in his plans. So much is certain, though the precise incidents of the interview are variously told. It was not their first encounter, for a letter of 1299 to Edward from Scotland describes Comyn as having seized Bruce by the throat at a meeting at Peebles, where they were with difficulty reconciled by the regents.

The bond with Lamberton was now sealed by blood, and the confederates lost no time in putting it into execution. Within little more than six weeks Bruce, collecting his adherents in the south-west, passed from Lochmaben to Glasgow and thence to Scone, where he was crowned king of Scotland on the 27th of March 1306. Two days later Isabella, countess of Buchan, claimed the right of her family, the Macduffs, earls of Fife, to place the Scottish king on his throne, and the ceremony was repeated with an addition flattering to the Celtic race. Though a king, Bruce had not yet a kingdom, and his efforts to obtain it were disastrous failures until after the death of Edward I. In June 1306 he was defeated at Methven, and on the 11th of August he was surprised in Strathfillan, where he had taken refuge. The ladies of his family were sent to Kildrumny in January 1307, and Bruce, almost without a follower, fled to the island of Rathlin. Edward came to the north in the following spring. On his way he granted the Scottish estates of Bruce and his adherents to his own followers, Annandale falling to Humphrey de Bohun, 4th earl of Hereford. At Carlisle there was published a bull excommunicating Bruce; and Elizabeth his wife, Marjorie his daughter, and Christina his sister, were captured in a sanctuary at Tain, while three of his brothers were executed. In a moment all was changed by the death of Edward I. on the 7th of July 1307. Instead of being opposed to the greatest, Bruce had now as his antagonist the feeblest of the Plantagenets. Quitting Rathlin, he had made a short stay in Arran, and before Edward's death had failed to take Ayr and Tumbrey, although he defeated Aymer de Valence, earl of Pembroke, at Loudoun Hill in May 1306. After wasting the critical moment of the war in the diversions of court life, the new English king, Edward II., made an inglorious march to Cumnock and back without striking a blow; and then returned south, leaving the war to a succession of generals. Bruce, with the insight of military

genius, seized his opportunity. Leaving Edward, now his only brother in blood and almost his equal in arms, in Galloway, he suddenly transferred his own operations to Aberdeenshire. He overran Buchan either once or twice, and after a serious illness defeated the earl of Buchan, one of his chief Scottish opponents, near Inverurie on the 22nd of May 1308. Then crossing to Argyllshire he surprised another body of his enemies in the pass of Brander early in 1309, took Dunstaffnage, and in March of this year held his first parliament at St Andrews. In 1309 a truce scarcely kept was effected by Pope Clement V. and Philip IV. of France, and in 1310, in a general council at Dundee, the clergy of Scotland, all the bishops being present, recognized Bruce as king. The support given to him by the national church in spite of his excommunication must have been of great importance in that age, and was probably due to the example of Lambertton. The next three years was signalized by the reduction one by one of the strong places still held by the English: Linlithgow towards the end of 1310, Dumbarton in October 1311, Perth, by Bruce himself, in January 1312. Previous to these two latter successes the king had made two raids into the north of England; after which Buittle, Dalswinton and Dumfries were reduced, and Berwick was threatened. In March 1313 his lieutenant Sir James Douglas surprised Roxburgh, and Thomas Randolph surprised Edinburgh. In May Bruce was again in England, and though he failed to take Carlisle, he subdued the Isle of Man. About the same time Edward Bruce took Rutherglen and laid siege to Stirling, whose governor, Sir Philip de Mowbray, agreed to capitulate if not relieved before the 24th of June 1314.

Bruce's rapidity of movement was one cause of his success. His sieges, the most difficult part of mediæval warfare, though won sometimes by stratagem, prove that he and his followers had benefited from their early training in the wars of Edward I. We know that he had been employed by that king to prepare the siege-train for his attack on Stirling in 1304. By the close of 1313 Berwick, Stirling and Bothwell alone remained English. Edward II. felt that if Scotland was not to be lost a great effort must be made. With the whole available feudal levy of England, and a contingent from Ireland, he advanced from Berwick to Falkirk, which he reached on the 22nd of June 1314. After a preliminary skirmish on Sunday the 23rd, in which Bruce distinguished himself by a personal combat with Sir Henry de Bohun, whom he felled by a single blow of his axe, the battle of Bannockburn was fought on Monday the 24th; and the complete rout of the English determined the independence of Scotland and confirmed the title of Bruce. The details of the day, memorable in the history of war as well as of Scotland, have been singularly well preserved, and redound to the credit of Bruce, who had studied in the school of Wallace as well as in that of Edward I. He had chosen and knew his ground, lying between St Ninians and the Bannock, a petty burn, yet sufficient to produce marshes dangerous to heavily armed horsemen, while from the rising ground on his right the enemy's advance was seen. His troops were in four divisions: his brother Edward commanded the right, Randolph the centre, Douglas the left. Bruce with the reserve planted his standard at the Bore Stone, whence there is the best view of the field. His camp-followers on the Gillies' Hill appeared over its crest at the critical moment which comes in all battles. The plain on the right of the marshes was prepared with pits and spikes. But what more than any other point of strategy made the fight famous was that the Scots fought on foot in battalions with their spears outwards, in a circular formation serving the same purpose as the modern square. A momentary success of the English archers was quickly reversed by a flank movement on the part of Sir Robert Keith. The Scottish bowmen followed up this advantage, and the fight became general; the English horse, crowded into too narrow a space, were met by the steady resistance of the Scottish pikemen, who knew, as Bruce had told them truly, that they fought for their country, their wives, their children, and all that freemen hold dear. The English rear was either unable to come up in

the narrow space, or got entangled in the broken ranks of the van. The first repulse soon passed into a rout, and from a rout into a headlong flight, in which the English king himself barely escaped. In the career of Bruce, Bannockburn was the turning-point. The enthusiasm of the nation he had saved forgot his tardy adhesion to the popular cause, and at the parliament of Ayr on the 25th of April 1315 the succession was settled by a unanimous voice on him, and, failing males of his body, on his brother Edward and his heirs male, or failing them on his daughter Marjorie and her heirs, if she married with his consent. Soon afterwards she married Walter the steward (d. 1326). As a result of Bannockburn, Bruce's queen was restored to her husband; Stirling was delivered up to the Scots; the north of England was ravaged, and Carlisle and Berwick were besieged.

The last part of Bruce's life, from 1315 to 1329, began with an attempt which was the most striking testimony that could have been given to the effect of Bannockburn, and which, had it succeeded, might have altered the future of the British Isles. This was no less than the rising of the whole Celtic race, who had felt the galling yoke of Edward I. and evaded the freedom the Scots had won. In 1315 Edward Bruce crossed to Ireland on the invitation of the natives, and in the following year the Welsh became his allies. In the autumn of 1316 Robert came to his brother, and together they traversed Ireland to Limerick. Dublin was saved by its inhabitants committing it to the flames, and, though nineteen victories were won, of which that at Slane in Louth by Robert was counted the chief, the success was too rapid to be permanent. The brothers retreated to Ulster, and, Robert having left Ireland in May 1317 to protect his own borders, Edward, who had been crowned king of Ireland, was defeated and killed at Dundalk in October 1318. On his return Bruce addressed himself to the siege of Berwick, a standing menace to Scotland. While he was preparing for it two cardinals arrived in England with a mission from Pope John XXII. to effect a truce, or, failing that, to renew the excommunication of Bruce. The cardinals did not trust themselves across the border; their messengers, however, were courteously received by Bruce, but with a firm refusal to admit the papal bulls into his kingdom because not addressed to him as king. Another attempt by Adam Newton, guardian of the Friars Minorite at Berwick, had a more ignominious result. Bruce admitted Newton to his presence at Aldcamus or Old Cambus, and informed him that he would not receive the bulls until his title was acknowledged and he had taken Berwick. On his return Newton was waylaid and his papers seized, not without suspicion of Bruce's connivance. In March 1318 the town and soon afterwards the castle of Berwick capitulated, and Bruce wasted the English border as far as Ripon. In December he held a parliament at Scone, where he displayed the same wisdom as a legislator which he had shown as a general. The death of his brother and his daughter rendered a resettlement of the crown advisable, and it was settled on his grandson, Robert, son of Marjorie and Walter the steward, in case Bruce died without sons, with a provision as to the regency in case of a minor heir in favour of Randolph. The defence of the country was next cared for by regulations for the arming of the whole nation, down to every one who owned the value of a cow, a measure far in advance of the old feudal levy. Exports during war, and of arms at any time, were prohibited. Internal justice was regulated, and it was declared that it was to be done to poor and rich alike. Leasing-making—a Scottish term for seditious language—was to be sternly punished. The nobles were exhorted not to oppress the commons. Reforms were also made in the tedious technicalities of the feudal law. In September 1319 an attempt to recover Berwick was repelled by Walter the steward, and Bruce took occasion of a visit to complement his son-in-law and raise the walls to it.

The king's position was now so strong that foreign states began to testify their respect. Bruges and Ypres rejected a request of Edward II. to cut off the Scottish trade with Flanders. Pope John, who had excommunicated Bruce, was addressed

by the parliament of Arbroath in April 1320 in a letter which compared Bruce to a Joshua or Judas Maccabaeus, who had wrought the salvation of his people, and declared they fought "not for glory, truth or honour, but for that liberty which no virtuous man will survive." Moved by this language and conscious of the weakness of Edward, the pope exhorted him to make peace with Scotland, and three years later Randolph, now earl of Moray, procured the recognition of Bruce as king from the papal see by promising aid for a crusade. In 1326 the French king, Charles IV., made a similar acknowledgment by the treaty of Corbeil. Meantime hostilities more or less constant continued with England, but, though in 1322 Edward made an incursion as far as Edinburgh, the internal weakness of his government prevented his gaining any real success, while in October of this year Bruce again ravaged Yorkshire, defeated the English near Byland, and almost captured their king. Some of his chief nobles—Thomas, earl of Lancaster, in 1321, and Sir Andrew Harclay, earl of Carlisle, in 1322—entered into correspondence with the Scots, and, though Harclay's treason was detected and punished by his death, Edward was forced to make a truce of thirteen years at Newcastle on the 30th of May 1323, which Bruce ratified at Berwick. In 1327 Edward III. became king of England, and one of the first acts of the new reign, after a narrow escape of the young king from capture by Moray, was the treaty of York, ratified at Northampton in April 1328, by which it was agreed that "Scotland, according to its ancient bounds in the days of Alexander III., should remain to Robert, king of Scots, and his heirs free and divided from England, without any subjection, servitude, claim or demand whatsoever." Joanna, Edward's sister, was to be given in marriage to David, the infant son of Bruce, born subsequent to the settlement of 1318 and now recognized as heir to the crown, and the ceremony was celebrated at Berwick on the 12th of July 1328.

The chief author of Scottish independence barely survived his work. He appears to have conducted an expedition to Ireland in 1327, and on his return led a foray into England. His last years were chiefly spent at the castle of Cardross on the Clyde, which he acquired in 1326, and the conduct of war, as well as the negotiations for peace, had been left to the young leaders, Moray and Sir James Douglas, whose training was one of Bruce's services to his country. Ever active, he employed himself in the narrower sphere of repairing the castle and improving its domains and gardens, in shipbuilding on the Clyde, and in the exercise of the virtues of hospitality and charity. The religious feeling, which had not been absent even during the struggles of manhood, deepened in old age, and took the form the piety of the times prescribed. He made careful provision for his funeral, his tomb, and masses for his soul. He procured from the pope a bull authorizing his confessor to absolve him even at the moment of death. He died at Cardross from leprosy, contracted in the hardships of earlier life, on the 7th of June 1329, and was buried at Dunfermline beside his second wife, Elizabeth (d. 1327), daughter of Richard de Burgh, earl of Ulster, whom he had married about 1304, and who bore him late his only son, David, who succeeded him. Of two surviving daughters, Matilda married Thomas Ysaak, a simple esquire, and Margaret became the wife of William, earl of Sutherland. Marjorie, an only child by his first wife, Isabella, daughter of Donald, earl of Mar, had predeceased him. Several children not born in wedlock have been traced in the records, but none of them became in any way famous.

In fulfilment of a vow to visit the Holy Sepulchre, which he could not accomplish in person, Bruce requested Douglas to carry his heart there, but his faithful follower perished on the way, fighting in Spain against the Moors, and the heart of Bruce, recovered by Sir William Keith, found its resting-place at Melrose. When his corpse was disinterred in 1821 the breast-bone was found severed to admit of the removal of the heart, thus confirming the story preserved in the verses of Barbour. That national poet collected in the earliest Scottish poem, written in the reign of Bruce's grandson, the copious traditions which clustered round his memory. It is a panegyric; but history has not refused to accept it as a genuine representation of the character of the great king, in spirit,

if not in every detail. Its dominant note is freedom—the liberty of the nation from foreign bondage, and of the individual from oppression. It is the same note which Tacitus embodied in the speech of Galgacus at the dawn of Scottish history. Often as it has been heard before and since in the course of history, seldom has it had a more illustrious champion than Robert the Bruce.

BIBLIOGRAPHY.—The chief contemporary authorities for the life of Bruce are coloured to some extent by the nationality of the writers. On the Scottish side *The Brus*, a poem by John Barbour, edited by W. W. Skeat (Edinburgh, 1804), and the *Chronica gentis Scotorum* of John of Fordun, edited by W. F. Skene (Edinburgh, 1871–72), are perhaps the most valuable. The *Chronicon de Lanercost*, edited by J. Stevenson (Edinburgh, 1839), is also very important. The English chronicles which may be consulted with advantage are those of Walter of Hemingford, edited by H. C. Hamilton (London, 1848–49); and of Peter Langtoft, edited by T. Wright (London, 1866–68), and the *Scalacronica* of Thomas Gray, edited by J. Stevenson (Edinburgh, 1836). For the documents of the time reference should be made to the *Calendar of Documents relating to Scotland*, edited by J. Bain (Edinburgh, 1881–88), *Documents and Records illustrating the History of Scotland*, vol. i., edited by F. Palgrave (London, 1837); the *Rotuli Scotiae* (London, 1814–19), and the *Foedera* of T. Rymer, vol. i. (London, 1704). The chief general histories are: Sir D. Dalrymple, Lord Hailes, *Annals of Scotland* (Edinburgh, 1819); P. F. Tytler, *History of Scotland* (Edinburgh, 1841–43); J. H. Burton, *History of Scotland*, vol. ii. (Edinburgh, 1903); A. Lang, *History of Scotland*, vol. i. (Edinburgh, 1904); R. Pauli, *Geschichte von England* (Hamburg, 1834–58). See also Sir H. Maxwell, *Robert the Bruce* (London, 1897).

ROBERT II. (1316–1390), called "the Steward," king of Scotland, was a son of Walter, the steward of Scotland (d. 1326), and Marjorie (d. 1316), daughter of King Robert the Bruce, and was born on the 2nd of March 1316. In 1318 the Scottish parliament decreed that if King Robert died without sons the crown should pass to his grandson; but the birth of a son, afterwards King David II., to Bruce in 1324 postponed the accession of Robert for nearly forty-two years. Soon after the infant David became king in 1329, the Steward began to take a prominent part in the affairs of Scotland. He was one of the leaders of the Scottish army at the battle of Halidon Hill in July 1333; and after gaining some successes over the adherents of Edward Baliol in the west of Scotland, he and John Randolph, 3rd earl of Moray (d. 1346), were chosen as regents of the kingdom, while David sought safety in France. The colleagues soon quarrelled; then Randolph fell into the hands of the English and Robert became sole regent, meeting with such success in his efforts to restore the royal authority that the king was able to return to Scotland in 1341. Having handed over the duties of government to David, the Steward escaped from the battle of Neville's Cross in 1346, and was again chosen regent while the king was a captive in England. Soon after this event some friction arose between Robert and his royal uncle. Accused, probably without truth, of desertion at Neville's Cross, the Steward as heir-apparent was greatly chagrined by the king's proposal to make Edward III. of England, or one of his sons, the heir to the Scottish throne, and by David's marriage with Margaret Logic. In 1363 he rose in rebellion, and after having made her submission was seized and imprisoned together with four of his sons, being only released a short time before David's death in February 1371. By the terms of the decree of 1318 Robert now succeeded to the throne, and was crowned at Scone in March 1371. His reign in unimportant. Some steps were taken by the nobles to control the royal authority. In 1378 a war broke out with England; but the king took no part in the fighting, which included the burning of Edinburgh and the Scottish victory at Otterbourne in 1388. As age and infirmity were telling upon him, the estates in 1389 appointed his second surviving son Robert, earl of Fife, afterwards duke of Albany, guardian of the kingdom. The king died at Dundonald on the 13th of May 1390, and was buried at Scone. His first wife was Elizabeth, daughter of Sir Robert Murc of Rowallan, a lady who had formerly been his mistress. By her he had at least four sons, the eldest of whom was his successor, King Robert III., and six daughters. By his second wife, Euphemia, daughter of Hugh, earl of Ross, and widow of Moray, formerly his

colleague as regent, he had two sons and several daughters; and he had also many illegitimate children.

See *Andrew of Wyntoun, The Orygynall Cronykil of Scotland*, edited by D. Laing (Edinburgh, 1872-1879); John of Fordun, *Scotichronicon*, continued by Walter Bower, edited by T. Hearne (Oxford, 1722); John Major, *Historia majoris Britanniae*, translated by A. Constable (Edinburgh, 1892); and P. F. Tytler, *History of Scotland* (Edinburgh, 1841-1843).

ROBERT III. (c. 1340-1406), king of Scotland, was the eldest son of King Robert II. by his mistress, Elizabeth Mure, and was legitimized when his parents were married about 1349. In 1368 he was created earl of Carrick, and he took some part in the government of the kingdom until about 1387, when he was disabled by the kick of a horse. It was probably in consequence of this accident that his brother Robert, earl of Fife, and not the crown prince himself, was made guardian of the kingdom in 1389; but the latter succeeded to the throne on his father's death in May 1390. At this time he changed his baptismal name of John, which was unpopular owing to its connexion with John de Baliol, for that of Robert, being crowned at Scone in August 1390 as King Robert III. Although he probably attended several parliaments the new king was only the nominal ruler of Scotland, the real power being in the hands of his brother, the earl of Fife. In 1399, however, owing to the king's "sickness of the body," his elder son, David, duke of Rothesay, was appointed lieutenant of the kingdom; but this event was followed by an English invasion of Scotland, by serious differences between Rothesay and his uncle, Robert, now duke of Albany, and finally in March 1402 by Rothesay's mysterious death at Falkland. Early in 1406 the king's only surviving son, afterwards King James I., was captured by the English; and on the 4th of April 1406 Robert died, probably at Rothesay, and was buried at Paisley. He married Annabella Drummond (c. 1350-1402), daughter of Sir John Drummond of Stobhall, and, in addition to the two sons already mentioned, had four daughters.

ROBERT I. (c. 865-923), king of France, or king of the Franks, was the younger son of Robert the Strong, count of Anjou, and the brother of Odo, or Eudes, who became king of the western Franks in 888. Appointed by Odo ruler of several counties, including the county of Paris, and abbot *in commendam* of many abbeys, Robert also secured the office of duke of the Franks, a military dignity of high importance. He did not claim the crown of France when his brother died in 898; but recognizing the supremacy of the Carolingian king, Charles III., the Simple, he was confirmed in his offices and possessions, after which he continued to defend northern France from the attacks of the Normans. The peace between the king and his powerful vassal was not seriously disturbed until about 921. The rule of Charles, and especially his partiality for a certain Hagano, had aroused some irritation; and, supported by many of the clergy and by some of the most powerful of the Frankish nobles, Robert took up arms, drove Charles into Lorraine, and was himself crowned king of the Franks at Reims on the 29th of June 922. Collecting an army, Charles marched against the usurper, and on the 15th of June 923, in a stubborn and sanguinary battle near Soissons, Robert was killed, according to one tradition in single combat with his rival. Robert left a son, Hugh the Great, duke of the Franks, and his grandson was Hugh Capet, king of France.

See F. Lot, *Les Derniers Carolingiens* (Paris, 1891); and E. Lavisse, *Histoire de France*, tome ii. (Paris, 1903).

ROBERT II. (c. 970-1031), king of France, was a son of Hugh Capet, and was born at Orleans. He was educated at Reims under Gerbert, afterwards Pope Sylvester II. As the ideal of medieval Christianity he won his surname of "Pious" by his humility and charity, but he also possessed some of the qualities of a soldier and a statesman. His father associated him with himself in the government of France, and he was crowned in December 987, becoming sole king on Hugh's death in October 996. Robert's reign is chiefly remembered for its dramatic side. In 988 he had married Rosala, or Susanna, widow of Arnold II., count of Flanders. This lady,

however, was much older than Robert, who repudiated her in 980, fixing his affections upon Bertha, daughter of Conrad the Peaceful, king of Burgundy, or Arles, and wife of Eudes I., count of Blois; and although the pair were related, and the king had been godfather to one of Bertha's children, they were married in 996, a year after the death of Eudes. Pope Gregory V., whose favour Robert vainly sought to win by allowing Arnulf, the imprisoned archbishop, to return to his see of Reims and forcing Gerbert to flee to the court of the emperor Otto III., excommunicated the king, and a council at Rome imposed a seven years' penance upon him. For five years the king braved all anathemas, but about 1002 he gave up Bertha and married Constance, daughter of a certain Count William, an intriguing and ambitious woman, who made life miserable for her husband, while the court was disturbed by quarrels between the partisans of the two queens. Still attached to Bertha, Robert took this lady with him to Rome in 1010, but the pope refused to recognize their marriage, and the king was forced to return to Constance. By this wife Robert had four sons, and in 1017, the eldest of these, Hugh, (1007-1025), was crowned as his father's colleague and successor. After Hugh's death the king procured the coronation of his second son, Henry, duke of Burgundy, afterwards king of France, a proceeding which displeased Constance, who wished her third son, Robert (d. 1073), afterwards duke of Burgundy, to receive the crown. Robert's concluding days were troubled by a rising on the part of these two sons, and after a short war, in which he was worsted, the king died at Melun on the 20th of July 1031. The notable gain to France during this reign was the duchy of Burgundy, which Robert claimed on the death of his uncle, Duke Henry, in 1001. The other claimant, however, Otto William, count of upper Burgundy, or Franche Comté, offered so stubborn a resistance that it was not until 1015 that the king secured the duchy, which he gave as an appanage to his son Henry. Nevertheless, Robert himself kept a close oversight over its government, and this was one reason which led to the revolt of his sons in 1030. Owing to family quarrels, he could not prevent the kingdom of Burgundy, or Arles, from passing into the hands of the emperor Conrad II., and no serious results followed his interference in Flanders or in Lorraine. Robert added to the royal domains, and was greatly aided by the support of Richard II. and Richard III., dukes of Normandy, the latter of whom was his son-in-law.

His life was written by his chaplain, Helgand, and this panegyric, *Epitoma vitae Roberti regis*, is published by J. P. Migne in the *Patrologia Latina*, tome cxli. (Paris, 1844). See also C. Pfister, *Études sur le règne de Robert le Pieux* (Paris, 1885); and E. Lavisse, *Histoire de France*, tome ii. (Paris, 1901).

ROBERT (1275-1343), king of Naples, was the son of Charles II., duke of Anjou and king of Naples, and in his youth took part in several expeditions to Sicily with the object of wresting the island from Frederick III. of Aragon. But his efforts, like those of his father and grandfather, proved fruitless, and the Angevins were compelled at last to agree to the peace of Caltabellotta (1302). On the death of Charles in 1300 Robert succeeded to the throne, although his nephew Caroberto (Carlo Roberto), son of his elder brother Charles Martel, who had died before his father, had a prior claim. He was crowned by Pope Clement V. at Avignon, and on the descent into Italy of the emperor Henry VII. was appointed papal vicar in Romagna to resist the imperialists; thenceforth he became the recognized leader of the Guelphs or papal faction in Italy and took part in all the wars against the Ghibellines. On various occasions he obtained for himself or his sons the suzerainty over Rome, Florence, and other cities, and was regarded as the most powerful Italian prince of his day. Pope John XXII. created him papal vicar in Italy against the emperor Louis the Bavarian. In 1320 Robert summoned his kinsman Philip V. of France to Italy, and he waged war against Sicily once more from 1325 to 1341, but failed to drive out the Aragonese. He died in 1343, just as he was about to lead another expedition to the island. Robert was a man of learning, devoted to

literature, and a generous patron of literary men: he befriended the poet Petrarch, who admired the king so greatly as to express the wish to see him lord of all Italy; while Boccaccio celebrated the virtues and charms of Robert's natural daughter Maria, under the name of Fiammetta. Dante was perhaps too severe on Robert, whom he described as a *re da sermone* (word king), and contemporary critics accused him of covetousness, a fault partly excused by his pressing need of money to pay the expenses of his perpetual wars. In spite of his power and influence, his position as a leader of the Guelphs was greatly shaken during the latter years of his reign, while at home he was never able completely to subjugate his rebellious barons.

See G. Villani, *Cronache*; M. Murena, *Vita di Roberto d'Angiò, re di Napoli* (Naples, 1770); and *Archivio storico Siciliano* (1884, vii. 511 seq.).

ROBERT, the name of two dukes of Normandy.

ROBERT I. (d. 1035), called Robert the Devil, was the younger son of Richard II., duke of Normandy (d. 1026), who bequeathed to him the county of Exmes. In 1028 he succeeded his brother, Richard III., whom he was accused of poisoning, as duke of Normandy. His time was mainly spent in fighting against his rebellious vassals. At his court Robert sheltered the exiled English princes, Edward, afterwards King Edward the Confessor, and his brother Alfred, and fitted out a fleet for the purpose of restoring them to their inheritance, but this was scattered by a storm. When returning from a pilgrimage to Jerusalem, he died at Nicea on the 22nd of July 1035. His successor as duke was his natural son, William the Conqueror, afterwards king of England. In addition to winning for him his surname, Robert's strength and ferocity afforded material for many stories and legends, and he is the subject of several poems and romances (see **ROBERT THE DEVIL** below).

ROBERT II. (c. 1054-1134) was the eldest son of William the Conqueror. Although recognized in boyhood as his father's successor in Normandy, he was soon disaffected with his position, and about 1078, following a quarrel between his brothers and himself, he revolted. He was obliged to fly from his own country, but after a period of exile he returned, raised some troops, and began to harry the duchy, wounding his father during a skirmish at Gerberoi early in 1079. He was, however, quickly forgiven, and passed two or three years in England and in Normandy until 1083, when he entered upon a second term of exile. When the Conqueror died in September 1087 Robert became duke of Normandy, but not king of England; although he received offers of help, he took no serious steps to displace his younger brother, King William II. In Normandy his rule was weak and irresolute. He lost the county of Maine, which for some years had been united with Normandy, and he was soon at variance with his brothers, the younger of whom, Henry, he seized and put into prison. In 1089 his duchy was invaded by William II., who soon made peace with Robert, the two agreeing to dispossess their brother Henry of his lands in Normandy. This peace lasted until 1094, when occasions of difference again arose and another struggle began, Robert being aided by King Philip I. of France.

This warfare ended in 1096, when Robert set out on the first crusade, having raised money for this purpose by pledging his duchy to William for 10,000 marks. With his followers he journeyed to Constantinople; then he took part in the siege of Nicea, the battle of Dorylaeum, and the famous battle under the walls of Antioch in June 1098. He shared in the siege of Jerusalem and other exploits of the crusade, while one account says that he was offered and refused the crown of the new Latin kingdom. Having won a great reputation both for valour and for generosity, the duke left Palestine and arrived in Normandy in September 1100.

William Rufus died while Robert was on his homeward way, and in Italy the Norman duke was greeted as king of England; but when he reached Normandy he learned that the English throne was already in the possession of Henry I. In July 1101 he crossed over to England, intending to contest his brother's title, but Henry met him near Alton, in Hampshire,

and an amicable arrangement was made between them. Having received presents and the promise of a pension, Robert went quietly home. But the fraternal strife was not allayed. Henry had interests in Normandy in addition to the county of Evreux, which Robert ceded to him about 1102. Visits were exchanged, but no lasting peace was made, and in 1106 the English king crossed over to Normandy, where Robert was in great extremities. At the battle of Tinchebrai, fought on the 28th of September 1106, Henry took his brother prisoner and carried him to England. For twenty-eight years the unfortunate duke was a captive, first in the Tower of London, and later in the castles of Devizes and Cardiff, but the evidence goes to show that he was not treated with cruelty. He died probably at Cardiff on the 10th of February 1134. Robert had a son, William, called the Clito, and several natural children. He was called Curthose, and also Gambaron, his figure being short and stout. Although wanting in decision of character, he was a skilled and able warrior, and the chroniclers tell many stories, some of them obviously legendary, of his exploits in the Holy Land.

The chief sources for the life of Robert II. are Ordericus Vitalis, William of Malmesbury and other chroniclers of the time. See E. A. Freeman, *History of the Norman Conquest* (1870-76), and *The Reign of Rufus* (1882).

ROBERT GUISCARD [i.e. "the resourceful"] (c. 1015-1085), the most remarkable of the Norman adventurers who conquered southern Italy. From 1016 to 1030 the Normans were pure mercenaries, serving either Greeks or Lombards, and then Sergius of Naples, by installing the leader Rainulf in the fortress of Aversa in 1030, gave them their first pied-à-terre and they began an organized conquest of the land. In 1030 there arrived William and Drogo, the two eldest sons of Tancred of Hauteville, a petty noble of Coutances in Normandy. The two joined in the organized attempt to wrest Apulia from the Greeks, who by 1040 had lost most of that province. In 1042 Melfi was chosen as the Norman capital, and in September of that year the Normans elected as their count William "Iron Arm," who was succeeded in turn by his brothers Drogo, "comes Normannorum totius Apulie et Calabriae," and Humfrey, who arrived about 1044. In 1046 arrived Robert, the sixth son of Tancred of Hauteville. His tall stature, blonde colouring and powerful voice are strikingly described by Anna Comnena.

Guiscard soon rose to distinction. The Lombards turned against their allies and Leo IX. determined to expel the Norman freebooters. The army which he led towards Apulia in 1053 was, however, overthrown at Civitate on the Fortore by the Normans united under Humfrey, Guiscard and Richard of Aversa. In 1057 Robert succeeded Humfrey as count of Apulia and, in company with Roger his youngest brother, carried on the conquest of Apulia and Calabria, while Richard conquered the principality of Capua. The Papacy, foreseeing the breach with the emperor over investitures, now resolved to recognize the Normans and secure them as allies. Therefore at Melfi, on the 23rd of August 1059, Nicholas II. invested Robert with Apulia, Calabria, and Sicily, and Richard with Capua. Guiscard "by Grace of God and St Peter duke of Apulia and Calabria and future lord of Sicily" agreed to hold by annual rent of the Holy See and to maintain its cause. In the next twenty years he made an amazing series of conquests. Invading Sicily with Roger, the brothers captured Messina (1061) and Palermo (1072). Bari was reduced (April 1071) and the Greeks finally ousted from southern Italy. The territory of Salerno was already Robert's; in December 1076 he took the city, expelling its Lombard prince Gisulf, whose sister Sikelgaita he had married. The Norman attacks on Benevento, a papal fief, alarmed and angered Gregory VII., but pressed hard by the emperor, Henry IV., he turned again to the Normans, and at Ceprano (June 1080) reinvited Robert, securing him also in the southern Abruzzi, but reserving Salerno. Guiscard's last enterprise was his attack on the Greek Empire, a rallying ground for his rebel vassals. He

contemplated seizing the throne of the Basileus and took up the cause of Michael VII., who had been deposed in 1078 and to whose son his daughter had been betrothed. He sailed with 16,000 men against the empire in May 1081, and by February 1082 had occupied Corfu and Durazzo, defeating the emperor Alexis before the latter (October 1081). He was, however, recalled to the aid of Gregory VII., besieged in San Angelo by Henry IV. (June 1083). Marching north with 36,000 men he entered Rome and forced Henry to retire, but an émeute of the citizens led to a three days' sack of the city (May 1084), after which Guiscard escorted the pope to Rome. His son Bohemund, for a time master of Thessaly, had now lost the Greek conquests. Robert, returning to restore them, occupied Corfu and Cephalonia, but died of fever in the latter on the 15th of July 1085, in his 70th year. He was buried in S. Trinità at Venosa. Guiscard was succeeded by Roger "Borsa," his son by Sikelgaita; Bohemund, his son by an earlier Norman wife Alberada, being set aside. At his death Robert was duke of Apulia and Calabria, prince of Salerno and suzerain of Sicily. His successes had been due not only to his great qualities but to the "entente" with the Papal See. He created and enforced a strong ducal power which, however, was met by many baronial revolts, one being in 1078, when he demanded from the Apulian vassals an "aid" on the betrothal of his daughter. In conquering such wide territories he had little time to organize them internally. In the history of the Norman kingdom of Italy Guiscard remains essentially the hero and founder, as his nephew Roger II. is the statesman and organizer.

The best modern authorities are F. Chalandon, *Histoire de la domination normande en Italie et en Sicile* (Paris, 1907), and L. von Heinemann, *Geschichte der Normannen in Unteritalien* (Leipzig, 1894). Contemporary authors: Amatus, *Ystoire de St Normand*, ed. Delarc (Rouen, 1892); Geoffrey Malaterra and William of Apulia, both in Muratori *Rer. Ital. SS.*, vol. v., and Anna Comnena in *Corpus script. hist. Byz.* (Bonn, 1839). (E. C.)

ROBERT OF AUXERRE (c. 1156–1212), French chronicler, was an inmate of the monastery of St Marien at Auxerre. At the request of Milo de Trainel (1155–1202), abbot of this house, he wrote a *Chronicon*, or universal history, which covers the period between the creation of the world and 1211. For the years previous to 1181 this is merely a compilation from Prosper of Aquitaine, Siebert of Gembloux and others, but it is an original authority for the period from 1181 to 1211. It is one of the most valuable sources for the history of France during the reign of Philip Augustus, and it also contains information about other European countries, the Crusades and affairs in the East. Molinier, in fact, describes the author as one of the best historians of the middle ages. Robert was evidently a man of great diligence and of sound judgment. Two continuators took the work down to 1228 and it was extensively used by later chroniclers. The original manuscript is now at Auxerre.

The *Chronicon* was first published by N. Camuzat at Troyes in 1608; the best edition is in Band xxvi. of the *Monumenta Germaniae historica. Scriptores*, with introduction by A. Holder-Egger. Robert has been identified, but on very questionable grounds, with a certain Robert Abolant, an official of the monastery of St Marien, who died in 1214. See A. Molinier, *Les Sources de l'histoire de France*, tomes iii. and iv. (1903–1904).

ROBERT OF COURTENAY (d. 1228), emperor of Romania, or Constantinople, was a younger son of the emperor Peter of Courtenay, and was descended from the French king, Louis VI., while his mother Yolande was a sister of Baldwin and Henry of Flanders, the first and second emperors of Constantinople. When it became known in France that Peter of Courtenay was dead, his eldest son, Philip, marquess of Namur, renounced the succession to the Latin empire of Constantinople in favour of his brother Robert, who set out to take possession of his distracted inheritance, which was then ruled by Conon of Béthune as regent. Crowned emperor on the 25th of March 1221, Robert, who was surrounded by enemies, appealed for help to the pope and to the king of France; but meanwhile his lands were falling into the hands of the Greeks. Some little

aid was sent from western Europe, but soon Robert was compelled to make peace with his chief foe, John Ducas Vatases, emperor of Nicea, who was confirmed in all his conquests. Robert promised to marry Eudoxia, daughter of the late emperor of Nicea, Theodore Lascaris I., a lady to whom he had been betrothed on a former occasion; however, he soon repudiated this engagement, and married a French lady, already the fiancée of a Burgundian gentleman. Heading a conspiracy, the Burgundian drove Robert from Constantinople, and early in 1228 the emperor died in Achaia.

ROBERT OF GLOUCESTER, English chronicler, is known only through his connexion with the work which bears his name. This is a vernacular history of England, from the days of the legendary Brut to the year 1270, and is written in rhymed couplets. The lines are of fourteen syllables, with a break after the eighth syllable. The author gives his name as Robert; the dialect which he uses, and his acquaintance with local traditions, justify the supposition that he was a monk of Gloucester. He describes, from his own recollections, the bad weather which prevailed in the neighbourhood of Evesham on the day of the battle between the Montfortians and Prince Edward (1265). He also alluded to the canonization of Louis IX. of France, which took place in 1297. He probably wrote about the year 1300. The earlier part of his chronicle (up to 1135) may be from another hand, since it occurs in some manuscripts in a shorter form, and with an exceedingly brief continuation by an anonymous versifier. There is no good reason for the theory that this part was translated from a French original; nor does it contain any undoubted borrowings from French sources. The authorities employed for the earlier part were Geoffrey of Monmouth, Henry of Huntingdon, William of Malmesbury, the English Chronicles, and some minor sources; Robert, in making his recension of it, also used the *Brut* of Layamon. From 1135 to 1256 Robert is still a compiler, although references to oral tradition become more frequent as he approaches his own time. From 1256 to 1270 he has the value of a contemporary authority. But he is more important to the philologist than to the historian. His chronicle is one of the last works written in Old English.

Robert's chronicle was first edited by T. Hearne (2 vols., Oxford, 1724); but this text is now superseded by that of W. Aldis Wright (2 vols., Rolls Series, 1887). Minor works attributed to the author are: a *Life of St Alban* in verse (MS. Ashmole 43); a *Life of St Patrick*, also in verse (MS. Tanner 17); a *Life of St Bridget* (MS. C.C.C. Cambridge, 145); and a *Life of St Alphege* (MS. Cont., Julius D. ix.). A *Martyrdom of St Thomas Becket* and a *Life of St Brendan*, both attributed to Robert, were printed by the Percy Society in 1845.

See T. D. Hardy's *Descriptive Catalogue of MSS.* i. 25, 68, iii. 181–9, 623; K. Brossman, *Über die Quellen der Chronik des Robert von Gloucester* (Striegau, 1887); W. Elmer in *Anglia* (1888), x. 1–37, 201–321; H. Strohmeyer, *Der Stil der Reimchronik R. von Gloucester* (Berlin, 1891). (H. W. C. D.)

ROBERT OF JUMIÉGES (d. c. 1070), archbishop of Canterbury, was a Norman who became prior of St Ouen at Rouen and then abbot of Jumiéges. A close friend of the future king of England, Edward the Confessor, he crossed over to England with Edward in 1042, and in 1044 became bishop of London. In English history Robert appears as the most trusted and the most prominent of the king's foreign friends, and as the leader of the party hostile to the influence of Earl Godwine. In 1051, although the chapter had already made an election, Edward appointed him archbishop of Canterbury. He seems to have been sent by the king on an errand to Duke William of Normandy, and on the return of Godwine from exile in 1052 he fled in great haste from England. He was outlawed and deposed, and he died at Jumiéges about 1070. The treatment of Robert by the English was put forward by William the Conqueror as a pretext for invading England.

See *Two Saxons Chronicles*, edited by J. Earle and C. Plummer (Oxford, 1892); and E. A. Freeman, *History of the Norman Conquest* (Oxford, 1870–76).

ROBERT OF TORIGNI (c. 1110–1186), medieval chronicler, was prior of Bec in 1149, and in 1154 became abbot of Mont

St. Michel, whence he is also sometimes called Robertus de Monte. He died, according to Potthast, on the 29th of May 1186. He wrote additions and appendices to the chronicle of Siebert of Genblours, covering the period A.D. 385-1100, and a chronicle in continuation of Siebert, extending from 1100 to 1186, of great value for Anglo-Norman history. Robert was in a good position to obtain information, for the Mont St Michel was one of the four great centres of pilgrimage in Europe. But he was excessively timid and cautious, and hardly mentions events, like the murder of Becket, which were subjects of controversy. Besides, his style is that of the driest annalist. It is for continental affairs between 1154 and 1170 that his information is especially valuable. His notices of English affairs are slight and sometimes misleading.

The best modern editions are the *Chronique de Robert de Torigni, &c.*, edited by Léopold Delisle for the *Soc. de l'histoire de Normandie* (Rouen, 1872-1873), and *Chronique of Robert of Torigni*, edited, with an introduction, by Richard Howlett (Rolls Series, No. 82, iv. 1889).

ROBERT THE DEVIL, hero of romance. He was the son of a duke and duchess of Normandy, and by the time he was twenty was a prodigy of strength, which he used, however, only for outrage and crime. At last he learnt from his mother, in explanation of his wicked impulses, that he was born in answer to prayers addressed to the devil. He was directed by the pope to a hermit, who imposed on him by way of penance that he should maintain absolute silence, feign madness, take his food from the mouth of a dog, and provoke ill-treatment from the common people without retaliating. He became court fool to the emperor at Rome, and delivered the city from Saracen invasions in three successive years in the guise of an unknown knight, having each time been bidden to fight by a celestial messenger. The emperor's dumb daughter recovered speech to declare the identity of the court fool with the deliverer of the city, but Robert refused the hand of the princess and the imperial inheritance, and ended his days in the hermitage of his old confessor.

The French romance of *Robert le Diable* is one of the oldest versions of the legend, and differs in detail from the popular tales printed in the 15th and 16th centuries. It was apparently founded on folk-lore, not on the wickedness of Robert Guiscard or any historical personage; but probably the name of Robert and the localization of the legend may be put down to the terror inspired by the Normans. In the English version the hero is called Sir Gowther, and the scene is laid in Germany. This metrical romance dates from the beginning of the 15th century, and is based, according to its author, on a Breton lay. The legend had undergone much change before it was used by E. Scribe and C. Delavigne in the libretto of Meyerbeer's opera of *Robert le Diable*.

See *Robert le Diable*, ed. E. Löseth (Paris, 1903, for the *Soc. des anc. textes fr.*); *Sir Gowther*, ed. K. Breul (Oppeln, 1886); M. Tardel, *Die Sage v. Robert d. Teufel in neueren deutschen Dichtungen* (Berlin, 1900). Breul's edition of the English poem contains an examination of the legend, and a bibliography of the literature dealing with the subject. The English prose romance of *Robert the Devil* was printed (c. 1510) by Wynkyn de Worde.

ROBERT THE STRONG (le Fort) (d. 866), count of Anjou and Blois, is said by Richerus to have been the son of a certain Wittichin, but nothing definite is known about his parentage or early life. Quickly attaining a prominent position among the Frankish nobles, he appears as rector of the abbey of Marmoutier in 852, and as one of Charles the Bald's *missi dominici*, in 853; but soon afterwards he was among those who rebelled against Charles, and invited the king's half-brother, Louis the German, to invade West Francia. However, after the peace between Charles and Louis in 860 Robert came to terms with his sovereign, who made him count of Anjou and of Blois, and entrusted him with the defence of that part of his kingdom which lay between the Seine and the Loire, a district which had suffered greatly from the ravages of the Normans and the Bretons. By his conduct in many stubborn fights with these foes, Robert thoroughly earned his surname and gained the confidence of the king, who gave him

the counties of Nevers and Auxerre. He was killed in battle at Brissarthe in October 866, leaving two sons, Odo, or Eudes, and Robert, both of whom became kings of the Franks. Robert has been compared to the Maccabees, and the fact that he was the ancestor of the Capetian kings of France has invested him with historical importance.

See K. von Kalkstein, *Robert der Tapfere* (Berlin, 1871); and E. Favre, *Eudes, comte de Paris et roi de France* (Paris, 1893).

ROBERT, HUBERT (1753-1808), French artist, born at Paris in 1753, deserves to be remembered not so much for his skill as a painter as for the liveliness and point with which he treated the subjects he painted. The contrast between the ruins of ancient Rome and the life of his time excited his keenest interest; and, although he had started for Italy on his own responsibility, the credit he there acquired procured him the protection of the minister Marigny and an official allowance. His incessant activity as an artist, his drying character, his many adventures, attracted general sympathy and admiration. In the fourth canto of his *L'Imagination* Delille celebrated Robert's miraculous escape when lost in the catacombs; later in life, when imprisoned during the Terror and marked for the guillotine, by a fatal accident another died in his place and Robert lived. The quantity of his work is immense; the Louvre alone contains nine paintings by his hand and specimens are frequently to be met with in provincial museums and private collections. Robert's work has more or less of that scenic character which justified his selection by Voltaire to paint the decorations of his theatre at Ferney. Robert died of apoplexy on the 15th of April 1808. His work was much engraved by the abbé Le Non, with whom he had visited Naples in the company of Fragonard during his early days; in Italy his work has also been frequently reproduced by Chatelain, Liénard, Le Veau, and others.

See C. Blanc, *Hist. des peintres*; Villot, *Notice des tableaux du Louvre*; Julius Meyer, *Gesch. mod. fr. Malerei*.

ROBERT, LOUIS LÉOPOLD (1794-1835), French painter, was born at Chaux de Fonds (Neuchâtel) in Switzerland on the 13th of May 1794, but left his native place with the engraver Girardet at the age of sixteen for Paris. He was on the eve of obtaining the *grand prix* for engraving when the events of 1815 blasted his hopes, for Neuchâtel was restored to Prussia, and Robert was struck off the list of competitors as a foreigner. Whilst continuing his studies under Girardet he had never ceased to frequent the studio of David, and he now determined to become a painter, and only returned to his native country when his master himself was exiled. At Neuchâtel he attracted the notice of Roulet de Mezerac, who enabled him by a timely loan to proceed to Rome. In depicting the customs and life of the people, of southern Italy especially, he showed peculiar feeling for the historical characteristics of their race. After executing many detached studies of Italian life Robert conceived the idea of painting four great works which should represent at one and the same time the four seasons in Italy and the four leading races of its people. In the "Return from the Fête of the Madonna dell' Arco" (Louvre) he depicted the Neapolitans and the spring. This picture, exhibited at the Salon of 1827, achieved undoubted success and was bought for the Luxembourg by Charles X.; but the work which appeared in 1831—the "Summer Reapers arriving in the Pontine Marshes" (Louvre), which became the property of Louis Philippe—established the artist's reputation. Florence and her autumn vineyards should now have furnished him with his third subject. He attempted to begin it, but, unable to conquer his passion for Princess Charlotte Napoleon (then mourning the violent death of her husband, Robert's devoted friend), he threw up his work and went to Venice, where he began and carried through the fourth of the series, the "Fishers of the Adriatic." This work was not equal to the "Reapers." Worn by the vicissitudes of painful feeling, and bitterly discouraged, Robert committed suicide before his easel on the 20th of March 1835, on the tenth anniversary of the melancholy suicide of a brother to whom he had been much attached.

See Villot, *Notice des tableaux du Louvre*; C. Blanc, *Hist. des peintures*; Feuilleit de Conches, *Correspondance de L. L. Robert*; Julius Meyer, *Gesch. mod. fr. Malerei*.

ROBERT-FLEURY, JOSEPH NICOLAS (1797-1890), French painter, was born at Cologne. He was sent by his family to Paris, and after travelling in Italy returned to France and made his first appearance at the Salon in 1824; his reputation, however, was not established until three years later, when he exhibited "Tasso at the Convent of St Onophrius." Endowed with a vigorous original talent, and with a vivid imagination, especially for the tragic incidents of history, he soon rose to fame, and in 1850 succeeded Granet as member of the Académie des Beaux-Arts. In 1855 he was appointed professor and in 1863 director of the École des Beaux-Arts, and in the following year he went to Rome as director of the French Academy in that city. Among his chief works are: "A Reading at Mme. de Sévigné's," "Scene of St Bartholomew," "Henry IV. taken to the Louvre after his Assassination" (1836); "Triumphal Entry of Clovis at Tours" (1838), at the Versailles Museum; "Le Colloque de Poissy" (1840), at the Luxembourg Museum in Paris; "The Children of Louis XVI. in the Temple" (1840); "Marino Faliero"; "An Auto-da-fé"; "Galileo before the Holy Office," at the Luxembourg Museum; "Christopher Columbus received by the Spanish Court" (1847), at the same gallery; "The Last Moments of Montaigne" (1853); and "Charles V. in the Monastery of Yuste" (1857). He died in Paris in 1890.

His son, **TONY ROBERT-FLEURY** (1837-), French painter, was born in Paris, and studied under his father and under Delaroche and Léon Cogniet. His first picture at the Salon, in 1866, was a large historical composition of the "Warsaw Massacres on April 8, 1861." In the following year his "Old Women in the Place Navone, Rome" was bought for the Luxembourg Museum, as was also the "Last Day of Corinth" in 1870. In 1880 he painted a ceiling for the Luxembourg, representing "The Glorification of French Sculpture." Tony Robert-Fleury became president of the Société des Artistes français in succession to Bouguereau. He acquired a great reputation for his historical compositions and portraits; and from his atelier have issued a great number of the best-known painters of our day.

ROBERTS, DAVID (1796-1864), Scottish painter, was born at Stockbridge, Edinburgh, on the 24th of October 1796. He was apprenticed by his father, a shoemaker, for seven years to a painter and house-decorator; and during this time he employed his evenings in the study of art. In 1820 he formed the acquaintance of Clarkson Stanfield, then painting at the Pantheon, Edinburgh, at whose suggestion he sent three pictures in 1822 to the Exhibition of Works by Living Artists, held in Edinburgh. In the same year he removed to London, where he worked for the Coburg Theatre, and was afterwards employed, along with Stanfield, at Drury Lane. In 1824 he exhibited at the British Institution a view of Dryburgh Abbey, and sent two works to the first exhibition of the Society of British Artists, of which he was elected president in 1831. In the same autumn he visited Normandy, and the works which were the results of this excursion began to lay the foundation of the artist's reputation—one of them, a view of Rouen Cathedral, being sold for eighty guineas. His scenes for an opera, *The Seraglio*, executed two years later, and the scenery for a pantomime dealing with the naval victory of Navarino, and two panoramas executed jointly by him and Stanfield, were among his last work for the theatres. In 1829 he exhibited the "Departure of the Israelites from Egypt," in which his style first becomes apparent; three years afterwards he travelled in Spain and Tangiers, returning in the end of 1833 with a supply of effective sketches, elaborated into attractive and popular paintings. His "Interior of Seville Cathedral" was exhibited in the British Institution in 1834, and sold for £300; and he executed a fine series of Spanish illustrations for the *Landscape Annual* of 1836, while in 1837 a selection of his *Picturesque Sketches in Spain* was reproduced by lithography.

In 1838 Roberts made a long tour in the East, and accumulated a vast collection of sketches of a class of scenery which had hitherto been hardly touched by British artists, and which appealed to the public with all the charm of novelty. The next ten years of his life were mainly spent in elaborating these materials. An extensive series of drawings was lithographed by Louis Haghe in *Sketches in the Holy Land and Syria*, 1842-1849. In 1851, and again in 1853, Roberts visited Italy, painting the "Ducal Palace, Venice," bought by Lord Londesborough, the "Interior of the Basilica of St Peter's, Rome," "Christmas Day, 1853," and "Rome from the Convent of St Onofrio," presented to the Royal Scottish Academy. His last volume of illustrations, *Italy, Classical, Historical and Picturesque*, was published in 1859. He also executed, by command of Queen Victoria, a picture of the opening of the Great Exhibition of 1851. In 1839 he was elected an associate and in 1841 a full member of the Royal Academy; and in 1858 he was presented with the freedom of the city of Edinburgh. The last years of his life were occupied with a series of views of London from the Thames. He had executed six of these, and was at work upon a picture of St Paul's Cathedral, when, on the 25th November 1864, he died suddenly of apoplexy.

A life of Roberts, compiled from his journals and other sources by James Ballantine, with etchings and pen-and-ink sketches by the artist, appeared in Edinburgh in 1866.

ROBERTS, FREDERICK SLEIGH ROBERTS, EARL (1832-), British soldier, second son of General Sir Abraham Roberts, G.C.B., was born at Cawnpore, India, on the 30th of September 1832. Educated at Eton, Sandhurst and Addiscombe, he obtained a commission in the Bengal Artillery on 12th December 1851. In the following year he was posted to a field battery at Peshawar, where he also acted as aide-de-camp to his father, who commanded the Peshawar division. In 1856 Roberts was appointed to the quartermaster-general's department of the staff, in which he remained for twenty-two years, passing from one grade to another until he became quartermaster-general in India. On the outbreak of the Mutiny in 1857, Roberts, at first, was staff officer to the movable column operating against the mutineers in the Punjab, successively commanded by Colonels Neville Chamberlain and John Nicholson, but, towards the end of June, he joined the Delhi Field Force, and was deputy assistant quartermaster-general with the artillery during the operations against Delhi. He was wounded in the fight of the 14th of July, but was sufficiently recovered in September to take command as a regimental officer of the left half of No. 2 Siege Battery during the siege. He rejoined the headquarters staff for the assault, and took part in the storm and subsequent seven days' fighting in the city. He then accompanied Colonel Greathed's column to Cawnpore, and during September and October was present at the actions of Bulandshahr, Aligarh, Agra, Bithur and Kanauj. He served under Sir Colin Campbell at the second relief of Lucknow in November, at the battle of Cawnpore on the 6th of December, and the subsequent pursuit and defeat of the Gwalior contingent near Shinrajpur. Roberts distinguished himself at the engagement of Khudaganj, on the 2nd of January 1858, by capturing, in single-handed combat, a standard from two sepoy, and also by cutting down a sepoy about to kill a sowar. For these acts of gallantry he was recommended for the Victoria Cross. He was present at the reoccupation of Fatehgarh on the 6th of January, the storm of Mianganj in February, the siege and capture of Lucknow in March, and the action at Kursi on the 22nd of that month, after which he went home on sick leave. For his services in the Mutiny he was seven times mentioned in despatches, received the medal with three clasps, the Victoria Cross, and on his promotion to captain, in October 1860, a brevet majority. On the 17th of May 1859 he married, at Waterford, Miss Nora Bews, and on his return to India was entrusted with the organization of the viceroys' camps during the progresses through Oudh, the North-West Provinces, the Punjab and Central India in 1860 and 1861. In December 1863 he took part, under

Major-General Garvock, in the Umbeyla campaign among the mountains to the north of Peshawar, and was present at the storm of Lulu, the capture of Umbeyla, and the destruction of Mulka, receiving for his services the medal and clasp.

In 1867 Roberts was appointed assistant quartermaster-general to Sir Donald Stewart's Bengal Brigade for Abyssinia. He showed judgment in embarking each unit complete in every detail, instead of despatching camp equipage in one ship, transport in another, and so on, as was customary. He arrived at Zula, Annesley Bay, in the Red Sea, the base of the expedition, on the 3rd of February 1868, and remained there as senior base staff officer during the four months' campaign. At its close he superintended the re-embarkation of the whole army. His duties were so well performed that Sir Robert Napier sent him home with his final despatches. He was three times "mentioned," and received a brevet lieutenant-colonelcy and the war medal. He returned to India the following year as first assistant quartermaster-general. In the autumn of 1871 he made the arrangements for the expedition into Lushai, between south-east Bengal and Burma, fitted out two columns under Brigadiers-General Bouchier and Brownlow, and himself accompanied the first. A road, over 100 m. long, was cut through dense gloomy forests in stifling heat, and the column was attacked by cholera; but the object of the expedition was successfully accomplished, and Roberts, who was present at the capture of the Kholat villages and the action in the Northlang range, and commanded the troops at the burning of Taikum, was mentioned in despatches and made a Companion of the Bath. On his return in March 1872, he became deputy quartermaster-general in Bengal, and in 1875 quartermaster-general and colonel. He settled the details of the great camp of exercise at Delhi on the occasion of the visit of the prince of Wales in January 1876, and attended H.R.H. at the manœuvres. He also superintended the arrangements for the great durbar at Delhi on the 1st of January 1877, when Queen Victoria was proclaimed empress of India.

In 1878 Roberts was appointed to the command of the Frontier Field Force at Abbottabad, in Hazara; but in the autumn, on the repulse of the Chamberlain Mission by the Afghans, and the formation of three columns to advance into Afghanistan by the Khyber, the Bolan and the Kurram passes, he was given the command of the Kurram Field Force, with the rank of major-general. Concentrating his column at Thal, he advanced to Kurram towards the end of November, and having formed an advanced base there, moved on to Habib Kila. Under cover of preparations for a front attack on the Peiwar Kotal, he reconnoitred that formidable position, and on the night of the 1st of December moved part of his force to attack the Spingawi Kotal, in order to turn the Afghan left flank, leaving the remainder of the force to feign a front attack on the Peiwar, and to guard the camp. After a very difficult night march the Spingawi Kotal was carried at daybreak on the 2nd, and, later, the Afghans on the Peiwar Kotal, threatened in rear, abandoned the position. The next morning Roberts occupied the Peiwar, and on the 6th advanced to Ali Khel. He reconnoitred the Shutargardan and the Sapari passes, and made a strong reconnaissance through Khost, in which some fighting took place, and at the end of January returned to Hagir Pir, in Kurram, where his force remained in occupation. In July Major Cavagnari, the British envoy to the new amir, Yakub Khan, passed through Kurram on his way to Kabul, and, shortly afterwards, Roberts left his Kurram command and went to Simla to take his seat on the army commission, where he strongly advocated the abolition of the three Presidency armies, and the substitution for them of four army corps, a measure which was carried out sixteen years later. While he was at Simla, news arrived on the 5th of September of the murder of Cavagnari and his companions at Kabul. The Peshawar Valley Force had been broken up; Sir Donald Stewart was still at Kandahar, but most of his troops had started for India; Roberts, therefore, had the only force ready to strike rapidly at Kabul. It was hastily reinforced, and he

hurried back to Kurram to take command, as a lieutenant-general, of the Kabul Field Force (7500 men and 22 guns). By the 19th of September a brigade was entrenched on the Shutargardan, and as Roberts advanced, the Amir Yakub Khan came into his camp. An Afghan force of 8000 men blocked the way in a strong position on the heights beyond Charasia, and on the 6th of October Roberts repeated the tactics that had done him such good service at the Peiwar in the previous year, and sending Brigadier-General T. D. Baker with the greater part of his force to turn the Afghan right flank, threatened the pass in front with the remainder. By the afternoon Baker had seized the position, and the enemy, severely defeated, were in full retreat. Kabul was occupied without further opposition.

The city was spared, but punishment was meted out to those convicted of complicity in the murder of the British Mission. Yakub Khan abdicated on the 12th of October, and was eventually deported to India. The troops occupied the Sherpur cantonments; but in November a religious war was proclaimed by the Mullahs, and early in December, in order to prevent a threatening combination of Afghan tribes against him, Roberts moved out two columns to attack them in detail. After considerable fighting around Kabul, the numbers of the enemy were so great that he was forced to concentrate his troops again at Sherpur, the defences of which had been greatly improved and strengthened. Sherpur was invested by the enemy, and early on the 23rd of December was attacked by over 100,000 Afghans. They were driven off with great loss; and on making a second attempt to storm the place, were met by Roberts, who moved out, attacked them in flank, and defeated them, when they broke and dispersed. Roberts now recommended the political dismemberment of Afghanistan, and negotiations were carried on with the northern tribes for the appointment of an amir for the Kabul district only. On the 5th of May Sir Donald Stewart arrived with his column from Kandahar and assumed the supreme command in Afghanistan, Roberts retaining, under Stewart, the command of the two Kabul divisions, and organizing an efficient transport corps under Colonel R. Low, which was soon to be of inestimable value. On the 22nd of July Abdur Rahman was proclaimed Amir of Kabul; and Roberts was preparing to withdraw his troops to India by the Kurram route, when news arrived that a British brigade had been totally defeated at Maiwand on the 27th of July, and that Lieutenant-General Primrose was besieged in Kandahar. Roberts was ordered to proceed thither at once with a specially selected column of 10,000 troops and his new transport corps. He started on his famous march on the 6th of August and arrived at Kandahar on the morning of the 31st, having covered 313 miles in twenty-two days. On the following day he fought the battle of Kandahar and gained a complete victory. His services in the Afghan campaigns of 1878 to 1880 are recorded in eight *Gazettes*, and were recognized by the thanks of both Houses of Parliament, of the Government of India, and of the Governor-General in Council. He was created K.C.B., G.C.B. and a baronet, received the medal with four clasps and the bronze star, and was given the command of the Madras army.

Before proceeding to Madras, Roberts went home on furlough, and when the news of the disaster at Majuba Hill in South Africa arrived in London at the end of February 1881, he was appointed governor of Natal and commander-in-chief in South Africa. He arrived at Cape Town to find that peace had been made with the Boers, and that instructions were awaiting him to return home. The same year he attended the autumn manœuvres in Hanover as the guest of the German emperor. He declined the post of quartermaster-general to the forces in succession to Sir Garnet Wolseley, and returned to India, arriving at Madras in November. The following year he visited Burma with the viceroy, and in 1885 attended the meeting between Abdur Rahman and Lord Dufferin at Rawalpindi at the time of the Panjdeh incident, in connexion with which he had been nominated to the command of an army corps in

case of hostilities. In July he succeeded Sir Donald Stewart as commander-in-chief in India, and during his seven years' tenure of this high position instituted many measures for the benefit of the army, and greatly assisted the development of frontier communications and defence. At the end of 1886, at the request of the viceroy, he took personal command for a time of the forces in Burma, and organized measures for the suppression of dacoity. For his services he received the medal, was created G.C.I.E., and promoted supernumerary general. In 1890 he did the honours of the army to Prince Albert Victor at a standing camp at Muridki, and in 1891 his attention was occupied with the Zhoob and Hunza Nagar frontier campaigns. On the 1st of January 1892 he was raised to the peerage as Baron Roberts of Kandahar and Waterford. In 1893 he left India for good, and the G.C.S.I. was bestowed upon him. He was promoted to be field-marshal in 1895, and in the autumn of that year succeeded Lord Wolsley in the Irish command and was sworn a privy councillor. At Queen Victoria's diamond jubilee in 1897 he was created K.P.

After the disastrous actions in the Boer war in South Africa in December 1899 at Magersfontein, Stormberg and Colenso, where his only son was killed, Lord Roberts was sent out as commander-in-chief. He arrived at Cape Town on the 10th of January 1900, and after organizing his force, advanced with sound strategy on Bloemfontein, the capital of the Orange Free State, and soon changed the aspect of affairs. The sieges of Kimberley and Ladysmith were raised, and the Boer general, Cronje, flying towards the capital, was overtaken at Paardeberg and, after a fine defence, compelled to surrender, with 5000 men, on the anniversary of Majuba Day, the 27th of February 1900. Roberts entered Bloemfontein on the 13th of March, and after six weeks' preparation, advanced on Pretoria, the capital of the Transvaal. Mafeking was relieved on the 17th of May, and Pretoria occupied on the 5th of June. The two Boer states were annexed, and the war gradually assuming a guerrilla character, Roberts handed over the command to Lord Kitchener and returned to England to fill the office of commander-in-chief of the army in succession to Lord Wolsley.

He arrived in the Solent on the 2nd of January 1901, and the same day, at Osborne, had an audience of Queen Victoria, who handed him the insignia of the Order of the Garter. The next day he was received at Paddington by the prince and princess of Wales, and drove in procession to Buckingham Palace, where he was entertained as the guest of the queen. He again had an audience of the queen at Osborne on the 14th of January on his elevation to an earldom, the last audience given by her majesty before her death, which took place eight days later. When the German emperor came to London for the queen's funeral, he decorated Lord Roberts with the Order of the Black Eagle. Earl Roberts received the thanks of both Houses of Parliament and a grant of £100,000 for his services in South Africa. In 1905 he resigned his post on the Committee of National Defence, and devoted himself to attempting to rouse his countrymen to the necessity of cultivating rifle-shooting and of adopting systematic general military training and service. As an author he is known by his *Rise of Wellington* (1895), and his *Forty-One Years in India* (1897), an autobiography which has passed through numerous editions.

ROBERTSON, FREDERICK WILLIAM (1816-1853), English divine, known as Robertson of Brighton, was born in London on the 3rd of February 1816. The first five years of his life were passed at Leith Fort, where his father, a captain in the Royal Artillery, was then resident. The military spirit entered into his blood, and throughout life he was characterized by the qualities of the ideal soldier. In 1821 Captain Robertson retired to Beverley, where the boy was educated. At the age of fourteen he spent a year at Tours, from which he returned to Scotland and continued his education at the Edinburgh Academy and University. In 1834 he was articled to a solicitor in Bury St Edmunds, but the uncongenial and sedentary employment soon broke down his health. He was anxious for a military career, and his name was placed upon the list

of the 3rd Dragoons, then serving in India. For two years he worked hard in preparing for the army, but, by a singular conjunction of circumstances and at the sacrifice of his own natural bent to his father's wish, he matriculated at Brasenose College, Oxford, just two weeks before his commission was put into his hands. Oxford he did not find wholly congenial to his intensely earnest spirit, but he read hard, and, as he afterwards said, "Plato, Aristotle, Butler, Thucydides, Sterne, Jonathan Edwards, passed like the iron atoms of the blood into my mental constitution." At the same time he made a careful study of the Bible, committing to memory the entire New Testament both in English and in Greek. The Tractarian movement had no attraction for him, although he admired some of its leaders. He was at this time a moderate Calvinist in doctrine, and enthusiastically evangelical. Ordained in July 1840 by the bishop of Winchester, he at once entered on ministerial work in that city, and during his ministry there and under the influence of the missionaries Henry Martyn and David Brainerd, whose lives he studied, he carried devotional asceticism to an injurious length. In less than a year he was compelled to seek relaxation; and going to Switzerland he there met and married Helen, third daughter of Sir George William Denys, Bart. Early in 1842, after a few months' rest, he accepted a curacy in Cheltenham, which he retained for upwards of four years. The questioning spirit was first aroused in him by the disappointing fruit of evangelical doctrine which he found in Cheltenham, as well as by intimacy with men of varied reading. But, if we are to judge from his own statement in a letter from Heidelberg in 1846, the doubts which now actively assailed him had long been latent in his mind. The crisis of his mental conflict had just been passed in Tirol, and he was now beginning to let his creed grow again from the one fixed point which nothing had availed to shift: "The one great certainty to which, in the midst of the darkest doubt, I never ceased to cling—the entire symmetry and loveliness and the unequalled nobleness of the humanity of the Son of Man." After this mental revolution he felt unable to return to Cheltenham, but after doing duty for two months at St Ebbe's, Oxford, he entered in August 1847 on his famous ministry at Trinity Chapel, Brighton. Here he stepped at once into the foremost rank as a preacher, and his church was thronged with thoughtful men of all classes in society and of all shades of religious belief. His fine appearance, his flexible and sympathetic voice, his manifest sincerity, the perfect lucidity and artistic symmetry of his address, and the brilliance with which he illustrated his points would have attracted hearers even had he had little to say. But he had much to say. He was not, indeed, a scientific theologian; but his insight into the principles of the spiritual life was unrivalled. As his biographer says, thousands found in his sermons "a living source of impulse, a practical direction of thought, a key to many of the problems of theology, and above all a path to spiritual freedom." His closing years were full of sadness. His sensitive nature was subjected to extreme suffering, arising mainly from the opposition aroused by his sympathy with the revolutionary ideas of the 1848 epoch. Moreover, he was crippled by incipient disease of the brain, which at first inflicted unconquerable lassitude and depression, and latterly agonizing pain. On the 5th of June 1853 he preached for the last time, and on the 15th of August he died.

Robertson's published works include five volumes of sermons, two volumes of expository lectures, on Genesis and on the epistles to the Corinthians, a volume of miscellaneous addresses, and an *Analysis of "In Memoriam."* See *Life and Letters* by Stopford A. Brooke (1865).

ROBERTSON, GEORGE CROOM (1842-1892), Scottish philosopher, was born at Aberdeen on the 10th of March 1842. In 1857 he gained a bursary at Marischal College, and graduated M.A. in 1861, with the highest honours in classics and philosophy. In the same year he won a Fergusson scholarship of £100 a year for two years, which enabled him to pursue his studies outside Scotland. He went first to University

College, London; at Heidelberg he worked at German; at Berlin he studied psychology, metaphysics and also physiology under du Bois-Reymond, and heard lectures on Hegel, Kant and the history of philosophy, ancient and modern. After two months at Göttingen, he went to Paris in June 1863. In the same year he returned to Aberdeen and helped Alexander Bain with the revision of some of his books. In 1864 he was appointed to help Professor Geddes with his Greek classes, but he gave up the vacations to philosophical work. In 1866 he was appointed professor of philosophy of mind and logic at University College, London. This post he retained until ill-health compelled him to resign a few months before his death in 1892. He lectured on logic, deductive and inductive, systematic psychology and ethical theory. He left little published work. A comprehensive work on Hobbes was never completed, though part of the materials were used for an article in the *Encyclopædia Britannica*, and another portion was published as one of Blackwood's "Philosophical Classics." Together with Bain, he edited Grote's *Aristotle*, and was the editor of *Mind* from its foundation in 1876 till 1891. He was keenly interested in German philosophy, and took every opportunity of making German works on English writers known in the United Kingdom. In philosophy he followed mainly Mill and Bain, but he was acquainted with all philosophical literature. He was associated with his wife (a daughter of Mr Justice Crompton) in many kinds of social work; he sat on the Committee of the National Society for Women's Suffrage, and was actively associated with its president, John Stuart Mill. He warmly supported the admission of women students to University College.

ROBERTSON, JOSEPH (1810-1866), Scottish antiquary, was born at Aberdeen on the 17th of May 1810, the son of a small shopkeeper. He was educated in Marischal College in Aberdeen and was for some years engaged in literary and newspaper work there and in Glasgow and Edinburgh. In 1839 he helped to found the Spalding Club, organized to publish the historical, genealogical, topographical and literary remains of the north-eastern counties of Scotland, and he edited eight of its thirty-eight volumes. In 1853 he was appointed curator of the historical and antiquarian department of the General Register House, Edinburgh, hitherto a subordinate and unimportant office, but which, in his hands, became of the first consequence to the interests of antiquarian literature in Scotland. His inventory of the personal property and jewels of Mary Queen of Scots, prefaced by a paper of great learning and research, and his essays on Scottish architecture, preceded his greatest work, published by the Bannatyne Club (1866), *Concilia Scotiæ, Ecclesiæ Scotiæ Statuta*. In 1864 the University of Edinburgh conferred upon him the honorary degree of LL.D. He died on the 13th of December 1866.

ROBERTSON, THOMAS WILLIAM (1820-1871), English actor and dramatist, was born at Newark on the 9th of January 1820. As a dramatist he had a brief but very brilliant career. The son of a provincial actor and manager, chief of a "circuit" that ranged from Bristol to Cambridge, Robertson was familiar with the stage from his childhood; he was the eldest of a large family, the actress Margaret (Madge) Robertson (Mrs Kendal) being the youngest. His success came late. A farcical comedy by him, *A Night's Adventure*, was produced at the Olympic under Farren's management as early as 1851, but this did not make good his footing, and he remained for some years longer in the provinces, varying his work as an actor with miscellaneous contributions to newspapers. In 1860 he went to London, and edited a mining journal to which he contributed a novel afterwards dramatized with the title *Shadow Tree Shaft*. He was at one time prompter at the Olympic under the management of Charles Mathews. He wrote a farce entitled *A Cantab*, which was played at the Strand Theatre in 1861. This brought him a reputation in a Bohemian clique, but so little practical assistance that he thought of abandoning the profession to become a tobacconist. Then, in 1864, came his first marked success, *David Garrick*, produced at the Haymarket with

Edward Sothorn in the principal character. It was not, however, till the production of *Society* at the Prince of Wales Theatre in 1865, under the management of Miss Marie Wilton, afterwards Mrs Bancroft, that the originality and cleverness of the dramatist were fully recognized. Play-writer and company were exactly suited one to another; the plays and the acting together—the small size of the playhouse being also in their favour—were at once recognized as a new thing. Although some critics sneered at the "cup-and-saucer comedy," voted it absurdly realistic, said there was nothing in it but commonplace life represented without a trace of Sheridanian wit and sparkle, all London flocked to the little house in Tottenham Street, and the stage was at once inundated with imitations of the new style of acting and the new kind of play. Robertson, although his health was already undermined, rapidly followed up *Society* with a series of characteristic plays which made the reputation of himself, the company and the theatre. All his best known plays (except *David Garrick*) were written for the old Prince of Wales's under the Bancrofts, and that régime is now an historical incident in the progress of the English stage. *Ours* was produced in 1866, *Caste* in 1867, *Play* in 1868, *School* in 1869, *M.P.* in 1870. Unhappily, Robertson enjoyed his success for but a short time. He died in London on the 3rd of February 1871. His work is notable for its masterly stagecraft, wholesome and generous humour, bright and unstrained dialogue, and high dramatic sense of human character in its theatrical aspects.

See *Principal Dramatic Works of Robertson; with Memoir by his son* (1889); and T. E. Pemberton, *Life and Writings of Robertson* (1893).

ROBERTSON, WILLIAM (1721-1793), Scottish historian, born at Borthwick, Mid Lothian, on the 19th of September 1721, was the eldest son of the Rev. William Robertson. He was educated at the school of Dalkeith and the university of Edinburgh. He was from the first intended for the ministry; in 1743 he was presented to the living of Gladsmuir in East Lothian, and two years later he lost both his father and his mother, who died within a few hours of each other. The support and education of a younger brother and six sisters then devolved upon him, though at that time his income was less than £100 a year. Robertson's inclination for study was never allowed to interfere with his duties as a parish minister, and his power as a preacher had made him a local celebrity while still a young man.

His energy and decision of character were brought out vividly by the rebellion of 1745. When Edinburgh seemed in danger of falling into the hands of the rebels he joined the volunteers in the capital. When the city was surrendered he was one of the small band who repaired to Haddington and offered their services to the commander of the royal forces. Such a man could not remain in obscurity, and in 1746 he was elected a member of the General Assembly, where his influence as leader of the "moderate" party was for many years nearly supreme (see PRESBYTERIANISM).

During all this period of prominent activity in the public life of Edinburgh, Robertson was busy with his historical labours. His *History of Scotland*, begun in 1753, was published in 1759. Till he had finished his book Robertson had never left his native country; but the publication of his history necessitated a journey to London, and he passed the early months of the year 1758 partly in the capital and partly in leisurely rambles in the counties of England. The success of the *History of Scotland* was immediate, and within a month a second edition was called for. Before the end of the author's life the book had reached its fourteenth edition; and it soon brought him other rewards than literary fame. In 1759 he was appointed chaplain of Stirling Castle, in 1761 one of His Majesty's chaplains in ordinary, and in 1762 he was chosen principal of the university of Edinburgh. In May 1763 he was elected Moderator of the General Assembly, and in August of the same year the office of king's historiographer was revived in his favour with a salary of £200 a year.

The rest of Robertson's life was uneventful. His *History of*

the *Reign of the Emperor Charles the Fifth* occupied ten consecutive years of labour. It appeared in three volumes quarto in 1769. In 1777 he published his *History of America* and in 1791 his *Disquisition concerning the Knowledge which the Ancients had of India*, which concluded his historical labours and appeared only two years before his death, which occurred near Edinburgh on the 11th of June 1793. His fame had long been European, and he left no rival in the field of historical composition save Gibbon alone.

For an adequate appreciation of Robertson's position in British literature, and more especially of his rank as an historian, we have to consider the country and the age in which he was born and his own personal qualities and limits. Considering the small size and poverty of the country, Scotland had made a more than creditable figure in literature in the great age of the Reformation and the Renaissance, and Scottish contributions to British literature in the last half of the 18th century were distinctly superior to those produced in the southern portion of the island.

Of the three great British historians of the 18th century two were Scotsmen. The exact place of Robertson with regard to his two friends Hume and Gibbon, and to such historians as the rest of Europe had to offer, presents a question of some nicety, because it is complicated by extraneous considerations, so to speak, which should not weigh in an abstract estimate, but cannot be excluded in a concrete and practical one. If we regard only Robertson's potential historic power, the question is not so much whether he was equal to either of his two friends as whether he was not superior to both. The man who wrote the review of the state of Europe prefixed to the *History of Charles V.*, or even the first book of the *History of Scotland*, showed that he had a wider and more synthetic conception of history than either the author of the *Decline and Fall* or the author of the *History of England*. These two portions of Robertson's work, with all their shortcomings in the eye of modern criticism, have a distinctive value which time cannot take away. He was one of the first to see the importance of general ideas in history. He saw that the immediate narrative of events with which he was occupied needed a background of broad and connected generalizations, referring to the social state of which the detailed history formed a part. But he did more than this. In the appendix to the view of Europe called "Proofs and Illustrations" he enters into the difficult and obscure question of land tenure in Frankish times, and of the origin of the feudal system, with a sagacity and knowledge which distinctly advanced the comprehension of this period beyond the point at which it had been left by Du Bos, Montesquieu and Mably. He was well acquainted with the original documents,—many of them, we may conjecture, not easy to procure in Scotland. It must have been a genuine aptitude for historical research of a scientific kind which led Robertson to undertake the labour of these austere disquisitions of which there were not many in his day who saw the importance. Gibbon, so superior to him for wide reading and scholarship, has pointedly avoided them. Robertson's views are now out of date. But he deserves the honour of a pioneer in one of the most obscure if also important lines of inquiry connected with European history. On the other hand, it must be admitted that he showed himself only too tame a follower of Voltaire in his general appreciation of the middle ages, which he regarded with the mingled ignorance and prejudice common in the 18th century. In this particular he was not at all in advance of his age.

The neglect and gradual oblivion which have overtaken the greater part of Robertson's historical work are owing to no fault of his. He had not and could not have the requisite materials: they were not published or accessible. Justice requires that we should estimate his performance in view of the means at his command, and few critics would hesitate to subscribe to the verdict of Buckle, "that what he effected with his materials was wonderful." His style is singularly clear, harmonious and persuasive. The most serious reproach made against it is that it is correct to a fault and lacks idiomatic vigour,

and the charge is not without foundation. But there can be no doubt that, if Robertson's writings are less read than they formerly were, the fact is to be attributed to no defects of style but to the growth of knowledge and to the immense extension of historical research which has inevitably superseded his initiatory and meritorious labours.

By his wife, Mary Nisbet, whom he married in 1751, Robertson left three sons: William (1753-1835), who in 1805 was raised to the Scottish bench as Lord Robertson; James, who became a general in the British army; and David, who in 1799 married Margaret, sister of Colonel Donald Macdonald and heiress of Kinloch-Moidart, whose surname he assumed.

There are lives of Robertson by Dugald Stewart (Edinburgh, 1801 and 1802), prefixed to most of the collective editions of his works; by George Gleig, bishop of Brechin (Edinburgh, 1812); and by Lord Brougham in *Lives of Men of Letters*, &c. (1845-1846).

ROBERTSON, WILLIAM BRUCE (1820-1886), Scottish divine, was born at Greenhill, St Ninians, Stirlingshire, on the 24th of May 1820, and was educated at Glasgow University and at the Secession Theological Hall, Edinburgh, where he made the acquaintance of Thomas de Quincey, and on his recommendation went to Halle and studied under Tholuck. After travelling in Italy and Switzerland he was licensed to preach by the presbytery of Stirling and Falkirk in 1843, and was soon after ordained at the Secession (after 1847, the United Presbyterian) Church in Irvine, Ayrshire. In this charge he remained for 35 years, exercising from his pulpit a truly magnetic influence, not so discernible in his published sermons. From 1871 his health failed, in spite of several visits to Florence and the Riviera. He resigned his charge in 1878 and died at Bridge of Allan on the 27th of June 1886.

He wrote many hymns, among them a version of "Dies Irae"; several of them, together with letters, &c., are to be found in the *Life* by James Brown. A volume containing Robertson's lectures on Martin Luther and other subjects was published in 1892.

ROBERVAL, GILLES PERSONNE (or PERSONTER) DE (1602-1675), French mathematician, was born at Roberval, near Beauvais, on the 8th of August 1602. His name was originally Gilles Personne, that of Roberval, by which he is known, being taken from the place of his birth. Like René Descartes, he was present at the siege of La Rochelle in 1627. In the same year he went to Paris, where he was appointed to the chair of philosophy in the Gervais College in 1631, and two years later to the chair of mathematics in the Royal College of France. A condition of tenure attached to this chair was that the holder should propose mathematical questions for solution, and should resign in favour of any person who solved them better than himself; but, notwithstanding this, Roberval was able to keep the chair till his death, which occurred at Paris on the 27th of October 1675.

Roberval was one of those mathematicians who, just before the invention of the infinitesimal calculus, occupied their attention with problems which are only soluble, or can be most easily solved, by some method involving limits or infinitesimals, and in the solution of which accordingly the calculus is always now employed. Thus he devoted some attention to the quadrature of surfaces and the cubature of solids, which he accomplished, in some of the simpler cases, by an original method which he called the "Method of Indivisibles"; but he lost much of the credit of the discovery as he kept his method for his own use, while Bonaventura Cavalieri published a similar method which he himself had invented. Another of Roberval's discoveries was a very general method of drawing tangents, by considering a curve as described by a moving point whose motion is the result of several simpler motions. (See *INFINITESIMAL* and *CALCULUS*.) He also discovered a method of deriving one curve from another, by means of which finite areas can be obtained equal to the areas between certain curves and their asymptotes. To these curves, which were also applied to effect some quadratures, Evangelista Torricelli gave the name of "Robervallian lines." Between Roberval and Descartes there existed a feeling of ill-will, owing to the jealousy aroused in the mind of the former by the criticism which Descartes offered to some of the methods employed by him and by Pierre de Fermat; and this led him to criticize and oppose the analytical methods which Descartes introduced into geometry about this time. As results of Roberval's labours outside the department of pure mathematics may be noted a work on the system of the universe, in which he supports the Copernican system and attributes a mutual attraction to all particles of matter;

and also the invention of a special kind of balance which goes by his name.

His works were published in 1693 by the Abbé Gallois, in the *Recueil de Mémoires de l'Académie des Sciences*.

See J. A. N. de C. Condorcet, *Éloge de Roberval* (Paris, 1773): J. E. Montucla, *Histoire des mathématiques* (1802).

ROBES (Fr. *robe*, Late Lat. *roba, raupa*, meaning (1) spoils, (2) robe, stuff, cf. Mod. Ital. *roba*, connected with a Teutonic root *raup, rawb*, German *rauben* and English *rob*), the name generally given to a class of official costume, especially as worn by certain persons or classes on occasions of particular solemnity. According to Du Cange, the word robe was earliest used, in the sense of a garment, of those given by popes and princes to the members of their household or their great officers. Thus Matthew Paris (*Chron. Majora*, Rolls Series, V. 38) tells how, in 1248, the pope gave to some Tatar envoys "vestes pretiosissimas quas Robas vulgariter appellamus, de escarlet praelecto, cum pellicibus et furruris," with which Du Cange compares the "festiva indumenta" given, e.g., by King John *magnatum suorum multitudini* at Christmas time (1214, Matt. Paris, Rolls Series, II. 520) and the *robae papales scutiferorum*, and the like, given by the popes to members of their households, after the fashion of a livery. It would, however, be perhaps going too far to assume that, e.g., peers' robes were originally the king's livery, for there seems to be no proof that this was the case; but it is curious that in most early cases where robes are mentioned, if not of cloth of gold, &c., they are of scarlet, furred. A robe is properly a long garment, and the term "robes" is now applied only in those cases where a long garment forms part of the official costume, though in ordinary usage it is taken to include all the other articles of dress proper to the costume in question. The term "robes," moreover, connotes a certain degree of dignity or honour in the wearer. We speak of the king's robes of state, of peers' robes, of the robes of the clergy, of academic robes, judicial robes, municipal or civic robes; we should not speak of the robes of a cathedral verger, though he too wears a long gown of ceremony, and it is even only by somewhat stretching the term "robes" that we can include under it the ordinary academic dress of the universities. In the case of the official costume of the clergy, too, a distinction must be drawn. The *vestimenta sacra* are not spoken of as "robes"; a priest is not "robed" but "vested" for Mass; yet the rochet and chimere of an English bishop, even in church, are more properly referred to as robes than as vestments, and while the cope he wears in church is a vestment rather than a robe, the scarlet cope which is part of his parliamentary full dress is a robe, not a vestment. For the sake of convenience the official, non-liturgical costume of the clergy is dealt with under the general heading VESTMENTS and the subsidiary articles (e.g. COPE).

The coronation robes of emperors and kings, representing as they do the sacerdotal significance of Christian kingship, are essentially vestments rather than robes (see CORONATION). Apart from these, however, are the royal robes of state; in the case of the king of England a crimson velvet surcoat and long mantle, fastened in front of the neck, ermine lined, with a deep cape or tippet of ermine.¹

The subject of official robes is too vast for any attempt to be made to deal with it comprehensively here. All countries, East and West, which boast an ancient civilization have retained them in greater or less degree, and the tendency in modern times has been to multiply rather than to diminish their number. Even in republican France they survived the Revolution, at least in the universities and the law courts. But nowhere has custom been so conservative in this matter as in the United Kingdom, where in this as in other matters the wise Machiavellian principle has been followed of changing

¹ For the sovereign's coronation robes, see "The King's Coronation Ornaments," by W. St. John Hope, in *The Ancestor*, vols. i. and ii., also L. Wickham Legg, *English Coronation Records*, 1901. The "parliamentary robes" used to be of crimson or purple velvet, furred with ermine. See the above, also the inventories of the wardrobes of sovereigns, &c.

the substance of institutions without altering their outward semblance. The present article, then, does not attempt to deal with any but British robes,² under the headings of (1) peers' robes, (2) robes in the House of Commons, (3) robes of the Orders of Knighthood, (4) judicial and forensic robes, (5) municipal and civic robes, (6) academic costume.

Peers' Robes.—As early as the end of the 14th century peers seem to have worn at their creation some kind of robe of honour; this we may conclude from the description of the investiture of the earl of Somerset in 1397 (*Rol. Parl.* iii. 343), which says: "le dit Monsieur John fut amené devant le Roy en Parlement entre deux Contes, c'est assavoir Huntynghdon et Mareschall, vestuz en un pane (Du Cange; *pannus* = 3. *habitus vestimentum*) come vesture de honor"; while in accounts of various creations of about the same time (*Rol. Parl.* iii. 205, 206) are used the words "adventienteque . . . prefato Duce honorifice . . . togato et ornato." An early illustration of their use is to be found in an illumination on the foundation charter of King's College, Cambridge (see fig. 1), which represents the peers as



From the foundation charter of King's College, Cambridge, 1446.

FIG. 1.—Peers spiritual and temporal.

early as 1446 wearing gowns, mantles and hoods of scarlet, furred with miniver, the mantle opening on the right shoulder and guarded with two, three or four bars of miniver, in the form of short stripes high up on the shoulder. The origin of these is as yet unknown, and it is not certain precisely when the peers' velvet robe of estate was first used. At the coronation of Henry VI. the king's own parliament robe was of scarlet and miniver (Gregory's *Chronicle*, ed. Gairdner, Camden Soc. pp. 165-70), so the peers' robes were certainly not yet of velvet; at that of Henry VII. (see *Rutland Papers*, 1842; "Device for the Coronation of Henry VII.") the king had a robe of crimson velvet and ermine, but the "lords temporal" are only said to have been "in their robes"; at that of Henry VIII. (see Hall's *Chronicle*) the king in his progress through the city wore a crimson velvet robe furred with ermine, "his knights and esquires for his body" wore crimson velvet, and "all the gentlemen," &c., scarlet, while we hear of the "lords spiritual and temporal, and of their costly and rich apparel, of several devises and fashions," and notably of the duke of Buckingham's robe of gold and needlework (Stow's *Annals*, p. 813), which would show that the velvet robe of estate was not yet worn at the king's coronation. The duke of Richmond at his creation in 1525 (17 Henry VIII., see Brewer, *State Papers*, iv. 639) is described as clad in robes of estate, and the description of the investiture says that "the patent was read, the robe, sword, cap and circlet put on," and about this time references are found to the "parliament robes" of peers, implying that there were others.

An account of the coronation of Anne Boleyn in 1533, in J. Nichols, *Progresses of Queen Elizabeth*, vol. i. p. 1, says that in her progress through the city "all the lordes for the most part were clothed in crimson velvet," while at

² In the United States few save Federal judges wear robes. The scarlet judicial robes were discarded at the Revolution. Those of black silk now worn are slightly modified academic gowns. John Jay, first Chief Justice of the Supreme Court (1787), set the fashion by sitting in the LL.D. gown granted him by Columbia University.



THE CORONATION ROBES

As worn by His Late Majesty King Edward VII.

By permission of His Majesty King George V.



THE CORONATION ROBES

As worn by His Late Majesty King Edward VII.

By permission of His Majesty King George V.



The Most Ancient Order of the Thistle.



The Most Noble Order of the Garter.



The Most Illustrious Order of St. Patrick.



Baron in Coronation Robes



The Most Honourable Order of the Bath.



Baron in Parliament Robes



The Most Ancient Order of the Thistle.



The Most Noble Order of the Garter.



The Most Illustrious Order of St. Patrick.



Baron in Coronation Robes



The Most Honourable Order of the Bath.



Baron in Parliament Robes

Westminster the barons and viscounts wore their parliament robes, the earls, marquesses and dukes wearing their robes of estate of crimson velvet "furred with ermins, powdered according to their degrees." This was also the case at the coronation of James I., and in Selden's *Titles of Honour* (3rd ed., 1672) the illustrations show the baron and viscount in parliamentary robes, the higher ranks in robes of estate. By the time of James II.'s coronation, however, the baron and viscount had the velvet robes of estate (see illustration on p. 188 of Perkins's *The Coronation Book*, 1902, where the surcoat also appears to have a pointed collar edged with white and to be sleeveless). The colour of these seems to have been crimson at first, sometimes varying to purple. They consisted of a long gown or surcoat with girdle, a mantle lined with ermine, a hood and a tippet of ermine, the rows being as follows: for a duke 4, a marquess 3½, an earl 3, a viscount 2½, and a baron 2.

Till late in the 18th century peers continued to attend the House of Lords in parliamentary robes, with the stars and ribbons of their orders, but robes are now only worn in the House of Lords, e.g. at the opening of parliament, on occasions when the sovereign gives his assent to bills by "royal commission" (when five or six peers on the government side appear in robes, and the lord chancellor also wears his peer's robe of scarlet ermine), and at the introduction of a newly created peer, when the new peer and his two introducers wear their parliamentary robes (over morning dress) during the ceremony of introduction only. The mover and seconder of the Address no longer wear robes, but uniform. On all the above occasions, and when the peers as a body attend church or some other ceremony, the parliamentary robe of scarlet cloth is worn; in the present day it takes the form of a mantle opening on the right shoulder, with a collar of "ermine," and guarded with rows of ermine and gold lace round the right shoulder, varying in number according to the rank of the wearer. The modern coronation robes consist of a crimson velvet surcoat and a mantle with a tippet of ermine and with rows of ermine as in the parliamentary robes. The surcoat is no longer a gown, but a short sleeveless garment.

For Scotland, an order of James II. (1455) prescribed for earls "mantles of brown granic colour" open before, lined and faced in front, as far as the girdle, with white fur, and with hoods to match; for the other lords of parliament a red mantle lined with silk or fur, with a furred hood, while James I. (and VI.) in 1606 had to issue an order restraining the Scotch peers from wearing velvet robes in parliament, and confining them to those of scarlet cloth (*Miscellany of the Maitland Club*, vol. 1, p. 147). The robes of the Scotch peers are now, of course, similar to those of the others.

The peeresses' robes at the coronation of Anne Boleyn are also described in the account mentioned above. The duchess of Norfolk, the train-bearer, was followed by "ladies being lordes' wives" in scarlet robes furred with "lettice," while Wriothesley (*loc. cit.*) adds that the duchess was also in scarlet.² The order of the carl-marshall for the regulation of the peeresses' robes at the coronation of James II. (given in J. H. T. Perkins's *The Coronation Book*, 1902, pp. 202-5) shows that by then all peeresses wore the robes of state of crimson velvet, and minutely regulates all details, such as shape, powderings, length, of train and width of the fur edging of the mantle. They have changed very little up to the present day.

Robes of the Orders of Knighthood.—The history of the robes of the two oldest orders is given in great detail in Ashmole's *Order of the Garter* (London, 1672) and Anstis's *Order of the Bath* (London, 1725); see also G. F. Beltz, *Memorials of the Order of the Garter* (London, 1841), p. l-lii. In each case the robes

¹ These are well described in the account of the opening of parliament by Henry VI. in 1537 given in Wriothesley's *Chronicle of England* (Camden Soc., 1871), and Hamilton's "all articles, marquesses and lordes, all in their Parliament robes of scarlet furred with white, and their hoods about their neckes, which were forty in number; everie duke having fower barres of white fur alongest the right side of their robes, and everie earle having three barres, . . . and everie lord two barres in likewise."

² "After her followed ladies being lordes' wives, which had cirottes of scarlet, with narrow sleeves, the breast all lettice, with barres of pouders according to their degrees, and over that they had mantles of scarlet furred, and every mantle had lettice about the necke like a neckerchief, likewise powdered, so that by the powderings their degrees might be known. Then followed ladies being knights' wives in gownes of scarlet."

consisted of a mantle, surcoat and hood. The robes of the Garter were originally of blue woollen stuff, the surcoat and hood being powdered with garters embroidered in silk and gold. In the time of Henry VI. the mantle was first made of velvet, and between the time of Elizabeth and of Charles I. it seems to have been sometimes purple in colour. The surcoat varied in colour from year to year; in the reign of the founder alone, e.g., it was first blue, then black (possibly as a sign of mourning for the plague), then "sanguine in grain." The hood was made of the same material as the surcoat, and when hats began to be worn, was carried hanging over the shoulder. The number of garters embroidered on the surcoat and hood came to be fixed by rank, but after Henry VI. the surcoat seems to have been made of plain velvet. Robes were sometimes granted to ladies in the early days (see Beltz, p. ccxxi., for a list of those ladies), in which case the robe and hood were of the colour of the surcoat worn by the knights that year, and powdered with garters. The last lady to receive the robes was Margaret, countess of Richmond, in 1488. At the present day the mantle is of dark blue velvet, of the same colour as the ribbon, lined with this taffeta, and with the star embroidered on the left shoulder, the hood and surcoat of crimson velvet lined with white taffeta, and with these are worn a doublet and trunk-hose of white satin and a plumed hat (see Lawrence-Archer, *The Orders of Chivalry*, p. 106).

The robes worn by the knights of the Bath created at the coronation of Henry IV. were green with furred hoods, and a white silk cord hanging from the left shoulder.³ In the various accounts of later creations of knights of the Bath quoted by Anstis, the costume worn before the ceremonial bath seems to have been a priest-like garment of russet or grey, with a girdle and hood; after the bath, was put on a red surcoat and mantle, the latter with a lace of white silk, from which hung a pair of white gloves; and the final costume was a blue (later a purple) velvet or satin gown, with hood furred with miniver (later lined with sarcenet), and the white cord hanging from the shoulder, until it should be removed by the sovereign or a lady for some deed of valour. The mantle in the present day is of crimson velvet lined with white over a white satin under-coat and trunk-hose, and a plumed hat and white boots with red tops are worn. The mantle of the Thistle is of dark green velvet over surcoat, &c., of cloth of silver; that of St Patrick azure, with doublet and trunk-hose of white satin; that of St Michael and St George of Saxon blue satin lined with scarlet; and that of the Star of India of light blue satin lined with white.

House of Commons.—The speaker of the House of Commons wears on state occasions a black damask robe with gold lace and a full-bottomed wig; in the House itself he wears a black silk robe with train and a full-bottomed wig. The clerks at the table wear barristers' robes and wigs.

Judicial and Forensic Robes.—It is frequently stated that judicial robes had their origin in the dress of ecclesiastics. But though ecclesiastics in early days frequently acted as judges, and though, as Fortescue says, the serjeant's long robe was "ad instar sacerdotis," judicial robes more probably arose from the ordinary civilian dress of the early 14th century. The chief argument for the ecclesiastical origin has been found in the *coif* (*tenu, biretum album*), a cap of white linen or silk, tied under the chin, and described by Fortescue as "the principal or chief insignment and habit wherewith serjeants-at-law at their creation are decked," which is said to have been used by ecclesiastics to hide the tonsure when in court. This view is disposed of by Pulling (*The Order of the Coif*, London, 1884). More probably the *coif* was a head-dress in common use in the 13th century, which survived as the distinguishing mark of men of law.⁴ As such it is found in a wardrobe-roll of

³ "Longues cottes vertes a estoictes manches fourres de menever, et chapperons pareil fourres de menever, en guise de prelat; et avoient les dits chevaliers sur la senestre espaule ung double cordeau de soye blanche a blanche houppettes pendans" (Froissart).

⁴ Mr Oswald Barron, in *The Ancestor*, vols. v. (p. 108) and vii. (p. 108 seq., plate xii.), has given reproductions of figures from MSS.

Richard II. (1391, see Fairholt, ii. 347) in an entry for "twenty-one linen coifs for counterfeiting men of the law in the king's play at Christmas." The serjeant-at-law's "houve of silk" is also mentioned in *Piers the Plowman* (latter half of the 14th century)¹ together with his furred cloak. Chaucer, at the same period, describes his serjeant-at-law as wearing a party-coloured gown and girdle with bars.²

The earliest document quoted by Planché and others with reference to judges' costume is a Close-roll of 20 Edw. III. (1347). See also a wardrobe-roll of 21 Edw. III., and wardrobe accounts of 11 Richard II. and 22 Henry VI., all quoted in Dugdale's *Origines Juridicales*, from which we gather that the robes of the judges varied in colour, in the 14th and 15th centuries, from scarlet to green or "violet in grain," and that their winter gowns were furred with budge or miniver.

For the early 15th century there are more data. Firstly, there is the illumination of the serjeant-at-law in the Ellesmere MS. of *The Canterbury Tales* (reproduced in Furnivall's 6-text edition for the Chaucer Society), in which he is shown wearing a short, party-coloured rayed gown of red and blue, lined with white fur, a hood and tippet edged with white fur, and a white coif with two little bands showing below the hood. Secondly, there are a certain number of effigies or brasses of judges and serjeants belonging to the first half of the 15th century. Of judges, an early brass is that of Sir John Cassy (c. 1400) (see fig. 2).³

For the second half of the 15th century the authority is Chief-Justice Fortescue, who, writing in the reign of Henry VI., describes the dress of the serjeant-at-law as follows:—"Roba longa ad instar sacerdotis cum capicno penulato circa humeros ejus, et desuper collobium, cum duobus labellis, qualiter uti solent doctores legum in universitatibus quibusdam, cum supra desuper biretto vestiebatur." "He was clothed in a long robe, after the fashion of a priest, with a furred cape about his shoulders, and above it a hood, with two bands, such as are used by doctors of laws in some universities, with the coif as described above" (*De Laudibus Legum Angliæ*, cap. li.). Fortescue continues: "But being once made a justice, instead of his hood, he shall wear a cloak closed upon his right shoulder, all the other ornaments of a serjeant still remaining; saving that a justice shall wear no party-coloured vestment as a serjeant may, and his cape is furred with miniver, whereas the serjeant's cape is furred with white lamb (budge)."

This description of Fortescue's is borne out by some illuminations from a 15th-century MS. representing sittings of the four superior

of the 13th and 14th century, showing the coif worn by both clerks and laymen.

¹ *Prok*, line 210 (ed. Skeat, Clarendon Press): "Jit houed there an hondreth in houes of silke, seriaunt it seemed that serveden atre barre"; and iii. 293: "Shal no seriaunt for here seruse were a silk houwe, Ne no pelure in his cloke, for pleding atre barre."

² *Prok*, line 382 (ed. Morris, Clarendon Press): "He rood but homely in a medlee cote Girt with a ceint of silk, with barres smale; of his array telle I no longer tale."

³ The effigy "supposed to represent Sir Richard de Wyloughby, chief justice of the king's bench" *temp.* Edward III., illustrated by Fairholt, p. 201, wears a long gown with erdle and skull-cap, no distinctively judicial dress. The figure of Robert Grymbald (*temp.* Henry II.), engraved from his seal by Dugdale, wears the ordinary dress of the time.

⁴ See also that of Sir Hugh de Holes (1415; see Haines, *Brasses*, i. xc), and a stone effigy of Sir William Gascoigne in Harwood Church, Yorks (d. 1419, see Planché, *Cyclopaedia*, i. 427). Of serjeants-at-law, an early example is the brass of Nichol Rolond at Cople, Beds. (c. 1410, see Druitt, *Costume in Brasses*, p. 221); also that of Thomas Rolf at Gosfield, Essex (c. 1440, see Haines, p. 85), who wears a gown, tabard, tippet, hood and coif, with two bands showing below the hood, like the Ellesmere MS. figure. The inscription calls Rolf "legi professor," and Haines takes to mean "professor of law." Boutell and Clark (*Archaeological Journal*, vol. i, pp. 203-4) consider that he is a serjeant-at-law. Druitt (p. 224) remarks on the likeness of his tabard to that of a Master of Arts, but compares a figure on a 15th-century cope, who also appears to be a serjeant-at-law and wears a tabard. That a tabard sometimes formed part of the dress of a serjeant, can be seen in the extract from *The Liber famelicus* of Sir James Whiteclock, quoted by Druitt, p. 225, footnote.

courts in the time of Henry VI. (reproduced in *Archaeologia*, vol. xxxix. p. 358, &c., with an article by G. R. Corner; see plate). In them we see the scarlet robes of the judges furred with miniver, and the party-coloured rayed gowns, tippets and hoods of the serjeants, besides the costume of the minor officials of the court. Both serjeants and judges wear the coif, certain of the judges also wearing furred caps or turbans-like head-dresses. The colour of the serjeants' party-coloured robes seems to have varied; in these illuminations they are blue and green, but by the 17th century, to quote Dugdale, *Origines Juridicales*, cap. 38: "The robes they now use do still somewhat resemble those of the justices of either bench, and are of three distinct colours, viz. murrey, black, furred with white, and scarlet; but the robe which they usually wear at their creation only is of two colours, viz. murrey and mouse colour; whereunto they have a hood suitable, as also a coif of white silk or linen." (See also Pulling, p. 218, and Druitt, p. 225.) Sir E. Brabrook (*Proceedings of the Soc. of Antiquaries*, 2nd series, vol. iii. p. 414) quotes descriptions of calls of serjeants showing that as late as 1700 the serjeants wore party-coloured gowns at their creation and during the year following, and stating on what occasions they wore their black, scarlet or purple gowns (the last with scarlet or purple hoods). At the last general call (1736), and at the creation of a serjeant in 1762, party-coloured robes were still worn, but at a creation of 1809 they are no longer found. Until their final abolition the serjeants wore purple robes at their creation, and on ordinary occasions a black cloth or silk gown, with a scarlet robe for state occasions.

Illustrations of judicial costumes in the 16th century are to be found in vol. I. of *Vestitus Monumenta* (Soc. of Antiquaries, 1747), in which are reproduced firstly, a "painted table in the King's Exchequer," *temp.* Henry VII., on which the officials of the Exchequer are shown wearing long gowns, furred tippets and mantles, with coifs (see fig. 3); and secondly, a sitting of the Court of Wards and Liveries, *temp.* Elizabeth I., in which are shown serjeants wearing party-coloured gowns, tippets, hoods and coifs (see also Pulling, facing pp. 86 and 214).

About this time the square cap, otherwise known as the cornered, black or sentence cap (the last from the fact of its being put on by the judge when pronouncing sentence of death), begins to be seen in monuments (cf. that of Sir Richard Harpur, *temp.* Mary; Fairholt, p. 223). Sometimes this cap is worn over the coif only, sometimes over the coif and skull-cap (cf. the portrait of Sir Edward Coke, in Pulling, facing p. 180). The form also varies; sometimes, as in the portrait of Coke, it has no ear-flaps, some times, as in its present form, it has. The form with ear-flaps is held by some to be a combination of the square cap and skull-cap. The square cap was a mark of dignity, worn or carried on solemn occasions, hence its use when pronouncing sentence of death, to mark the solemnity of the moment.

Among the State Papers of 1625 is a "Discourse on what robes and apparel the judges are to wear, and how the serjeants-at-law are to wear their robes, and when," and on the 4th of July 1635 there was a "solemn decree and rule made by all the judges of the courts at Westminster," which is quoted in Dugdale (*loc. cit.*) and Pulling (p. 215, footnote).

This costume is illustrated in Hollar's engraving of the coronation procession of Charles II. Towards the end of the 17th century the judges took to wearing wigs, and have continued to wear them ever since. The wearing of wigs naturally concealed the coif and velvet skull-cap, so a device had to be invented by which they could still be displayed. The expedient was hit upon of putting a round patch of white stuff with a black spot in the middle of it, on the top of the wig of certain of the judges, to represent the coif and skull-cap. The rank of serjeant no longer existing, this round patch has now disappeared, the only trace of it left being the circular depression on the crown of the wig.

The costume of judges of the High Court at the present day differs very little from that given in the order of 1635; but the cap is carried in the hand as a part of the full dress, and only worn when a judge is passing sentence of death.⁶ The

⁵ They were probably originally liveries; see G. R. Corner in *Archaeologia*, also Pulling, *op. cit.* pp. 211-12.

⁶ See an essay by Sir Herbert Stephen in *Unwritten Laws and Ideals*, ed. E. H. Pitcairn (Smith, Elder, 1899), from which the following paragraph is largely condensed.



From a brass in Deerhurst church, Gloucestershire.

FIG. 2.—Sir John Cassy, chief baron of the Exchequer (c. 1400).



From the Standard of Weights and Measures (temp. Henry VIII.), in *Vestitus Monumenta* (Soc. of Antiquaries), vol. I.

FIG. 3.—Figures wearing coif.



One of four illuminations belonging to a law treatise, *temp. Henry VI*, found at Whaddon Hall, Bucks, depicting five presiding judges of the Court of King's Bench, wearing coifs and scarlet robes; below the King's Coroner, Attorney and Masters of the Court; two ushers at table swearing the jury; a tipstaff in charge of a fettered prisoner, two sergeants at law in coif on either side; in foreground six prisoners.

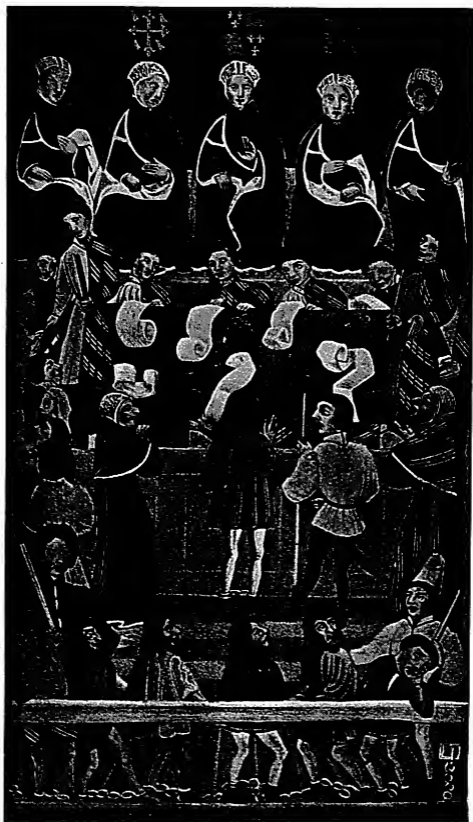

One of four illuminations belonging to a law treatise, *temp. Henry VI*, found at Whaddon Hall, Bucks, depicting five presiding judges of the Court of King's Bench, wearing coifs and scarlet robes; below the King's Coroner, Attorney and Masters of the Court; two ushers at table swearing the jury; a tipstaff in charge of a fettered prisoner, two sergeants at law in coif on either side; in foreground six prisoners.

From *Archæologia* XXXIX.

dress worn when trying criminal cases, attending church officially, and on "red letter days" in the courts, consists of a scarlet gown, with a broad black belt, a tippet trimmed with white fur, known by courtesy as "ermine" (this is worn only on state occasions), and a scarlet casting-hood, always worn with the scarlet gown, the end of which is passed under the belt. For summer the robes are of thinner stuff, faced with slate-coloured silk instead of ermine. The full-bottomed wig is worn on state occasions; at other times a wig is worn similar to that of barristers, except that it has one vertical curl just above the tail of the wig instead of the three rows of horizontal curls going all the way round.

The judges of the King's Bench Division have also a black gown, trimmed with ermine, which may be worn with the scarlet casting-hood when they sit two or more together. The summer equivalent of the black robes is in thin blue stuff, faced with silk. A costume like that of King's Counsel, namely, a black silk gown, with black cloth court suit, is the dress of judges when sitting alone to try civil actions, and of vice-chancellors and judges of the Chancery Division, but Sir Herbert Stephen remarks that of late years certain of the judges have preferred on grounds of comfort the black or blue gown with scarlet casting-hood. The court dress of the judges of the High Court and of Indian and colonial judges consists of a black damask tufted gown, without train, worn over a black velvet court suit, with full-bottomed wig, lace bands and three-cornered silk hat.¹

The Lord Chancellor, when in the House of Lords, and sitting on Appeals, wears a black silk trained gown, over a black cloth court suit, with full-bottomed wig; he has also his peer's robe (see above), and his state robe of black damask with gold lace, worn over a velvet court suit, with full-bottomed wig, lace bands, &c.; the purse is carried on state occasions when in the royal presence. The state robe of the Master of the Rolls, the Lords Justices of the Court of Appeal, and the President of the Probate, Divorce and Admiralty Divisions is the same, except that they have not the purse, and similar to it is the full-dress gown of the Speaker of the House of Commons, the Chancellor of the Exchequer, &c. The Lords Justices of the Court of Appeal sit in court in a costume similar to that of King's Counsel.

The Lords of Appeal have no official robes, but sit in ordinary civilian dress. On state occasions they wear their peers' robes. The robes of state of the Lord Chief Justice of England are the same as those of the judges of the High Court, except that his are trained, and he wears the gold chain of office, the "collar of SS."

The Scottish judges have two sets of robes, one for Justiciary (i.e. the criminal court), which is also their full dress, and one for civil causes (Court of Session). The dress for the President and Ordinary Lords of Session was fixed in 1610 by an order of James I, and was of purple cloth, faced with crimson satin, with hood to match, the President's gown having crimson velvet instead of satin. The four "extraordinary Sessionaries" were to wear black velvet, satin, or silk gowns, lined with black. The Lord Justice General wore a scarlet gown lined with ermine and an ermine hood, the Lord Justice Deputy and Lord Justice Clerk black gowns with crimson satin facings and hoods (see *Register of the Privy Council of Scotland*, vol. viii. p. 612). At the foundation of the High Court of Justiciary (1672) it was enacted "that for the splendour of that court, all the judges sit in red robes, faced with white, that of the Justice Generalls being lined with ermine for distinction from the rest" (see *Acts of Parliament of Scotland*, vol. viii. p. 88). The present full dress of the Lord Justice General is a scarlet silk robe with tippet and hood, the hood falling down the back; the collar is of ermine, with which the tippet, sleeves and gown are edged

and the hood lined. The Lord Justice Clerk wears a scarlet cloth robe and hood, and a white silk tippet lined with scarlet, the silk being perforated with small holes to imitate ermine, as also on the sleeves and edges of the gown. In front of the tippet on each side are two crosses in scarlet silk, and on each side of the gown six crosses. The ordinary Lords Commissioners of Justiciary have robes the same as those of the Lord Justice Clerk, except that the satin is not perforated. Instead of the bands worn by English judges, the Scottish judges wear a long fall in front.

The Bar.—There appears to have been no official costume for the bar until the end of the 17th century. Druitt (*Costume in Brasses*, pp. 232-33) gives a list of several brasses of *in lege periti*, or *apprenticis ad legem*, most of whom wear ordinary civilian costume, occasionally with the addition of a high cap. In the 16th and 17th centuries they wear the false-sleeved gown worn by civilians. Before the 17th century the costume worn by students at the Inns of Court and by "Utter Barristers" consisted of a stuff gown, and sometimes, in term-time, a round cap, which was worn in hall and in church (see Herbert, *History of the Inns of Court* (1804), p. 230). In Westminster Hall (see Pulling, p. 223) the same costume was worn, Benchers and Readers having a more elaborate gown with facings of black velvet and tufts of silk. Frequent laws were passed in the 16th century and later, forbidding the wearing of swords, cloaks, boots and spurs, &c., in hall, and insisting on the wearing of gowns by students of the Inns of Court when walking in the city. In the 17th century, barristers, like the judges, adopted wigs, the full-bottomed wigs being confined to judges, "King's Counsellors," &c., and ordinary counsellors wearing small wigs. In Hollar's engraving of the coronation of Charles II. the King's Counsel, the King's Attorney and Solicitor, and the Master of the Rolls wear a laced gown with hanging sleeves. The silk gown, full-bottomed wig and black court dress now worn by King's Counsel is generally held to date from the funeral of Queen Mary II., being the mourning dress worn by the wish of King William for a considerable period after the queen's death, and adopted as a convenient costume ever since. There is a well-known jest of Chief Baron Pollock to the effect that "the Bar went into mourning at the death of Queen Anne, and never came out again," which bears out this theory as to the origin of the costume. At the present time barristers wear black stuff gowns, with small wigs having three rows of curls round the head. King's Counsel wear black silk gowns over a cloth court suit (cp. the expression "to take silk," i.e. to become a K.C.); on full-dress occasions they wear a full-bottomed wig, and at court a black damask tufted gown over a velvet court suit. This is also the dress for state occasions of the Attorney-General, Solicitor-General, &c.

Municipal and Civic Robes.—The word "livery," the use of which is now practically confined to the costume of the "livery companies," the dress of men-servants, &c., originally meant an allowance of food or clothing granted to certain persons (*Lat. liberata, Fr. livrée*). It is still used of the allowances of food made to the fellows of certain colleges. As early as the 13th century, according to Matt. Paris (*Chron. Maj.*; *Rolls Series*, III. 337), we find the citizens of London assuming a uniform dress to do honour to some great occasion, as, e.g., when in 1236 a body of them rode out to meet Henry III. and Queen Eleanor, "sericis vestimentis ornati, cicladibus auro textis circumdati, excogitatis mutatoris amicti," or when 600 citizens rode out to meet Queen Margaret, wife of Edward I., "in one livery of red and white, with the cognizances of their misteries embroidered upon their sleeves" (see Stow's *Surrey*, ed. Morley, p. 444). By the 14th century there is evidence of the adoption of liveries by the trades and fraternities. At the celebrations of the birth of Edward III. (see Riley's *Memorials*, p. 105) the mayor and aldermen were "richly arrayed in suits of robes," while the drapers, mercers and vintners were also "in costume." This need not, however, refer to liveries. G. Unwin (*The Gilds of London*, 1908) quotes a chronicler who records that by the year 1319 "many of the people

¹ Minute details of court and levée dress, judicial and legal, will be found in *Dress worn at Court* (pp. 60-61), issued with the authority of the Lord Chamberlain, and ed. H. A. P. Trendell, of the Lord Chamberlain's department (London, 1908),—also details of mourning costume.

of the trades of London were arrayed in livery," and an ordinance of 1347 of the fraternity of the Mercers commanding that "all those of the said mystery shall be clothed of one suit once a year at the feast of Easter," and Riley (*op. cit.* p. 516) quotes an order of 1389 allowing the sheriffs, on grounds of expense, to proceed to Westminster by boat instead of on horseback, "without there being any arraying of men of the trades in like suit for that purpose; except that such men of the trades as should wish to accompany them should walk in such suit of vestments of the livery of their respective trade as they might then have." As to the liveries of the religious fraternities, Chaucer (*Prolog.* 361) describes:—

"An Haberdasher and a Carpenter
A Webbe, a Dyere, and a Tapicer,"
As, "a clothed alle in a liverie
Of a clothe and greet fraternitee."

In 1389 there was a petition against the giving of liveries by the fraternities, on the ground that these gatherings were centres of political agitation, but in the statutes of Edward III. and Richard II. against liveries members of guilds were expressly excepted from these prohibitions. However, it was doubtless deemed prudent to make sure of the privilege, and so, when the livery companies were incorporated, they took care to have their liveries authorized by their charters.

These liveries consisted of a gown and hood, though the hood only was sometimes given; thus the Grocers' Company had in 1430 55 members in the full livery, 17 in hoods and 42 not in livery. It was also customary for such of the companies as wished it to present liveries to outsiders, for instance, to the mayor, should he belong to another company. Thus in 1399 the Tailors gave liveries to the king, the prince and the mayor, and hoods to the sheriffs. But in 1415 and 1423 the mayor and aldermen were forbidden to receive any livery except that of their own company. A similar custom was that by which a member of any company might send to the mayor a certain sum, receiving in return a suit of the livery of the mayor's company. The colours of the various liveries varied very much from time to time. Thus in 1414 the Grocers wore liveries of scarlet and green, which were changed in 1418 to scarlet and black, in 1428 to scarlet and blue and in 1450 to "violet in grain," with party-coloured hoods of violet and crimson. At first both gowns and hoods were party-coloured, but later a party-coloured hood was worn with a gown of one colour. The gowns were also lined and edged with fur. An early illustration of the liveries is to be found on the first charter of the Leathersellers' Company, granted them in 1444 by Henry VI., where the members of the company are depicted kneeling before the king in short party-coloured gowns of red and blue, edged at the neck, wrists and round the bottom with fur and with white girdles (see fig. 4, from a coloured reproduction in W. H. Black's *History and Antiquities of the Leathersellers' Co.*).

In the reign of Henry VIII., Holbein's picture of the king giving a charter to the Barber-Surgeons' Company shows the members of the latter wearing gowns of rich stuff, with red and black party-coloured hoods, three of the figures also in coifs. The form of gown which has survived, practically unchanged, till the present day; may be seen on the second charter of the Leathersellers' Company, granted them by James I. in 1604 (see fig. 5, and for coloured plate see W. H. Black, *op. cit.*). Here we see them in flat caps, long black furred gowns, with false sleeves, and having on the right shoulder party-coloured hoods

of scarlet and black, the end of which is cast over the left shoulder and hangs down nearly to the edge of the gown.

Besides the liveries of the city companies, and those of the mayor and sheriffs, there was often a special livery adopted by all the citizens on some great occasion, such as a visit of the sovereign to the City. W. St John Hope (*Corporation Plate and Insignia*, ii. 141) quotes a number of such cases, showing that the city livery was sometimes green, sometimes blue, sometimes violet, sometimes red and white, the city colours *par excellence*.

As to the costume of the mayor, aldermen, sheriffs, &c., we have seen above the mayor "richly costumed," and the aldermen "in like suits of robes," at the birth of Edward III., and Riley (*op. cit.*) gives an order of 1378, that the aldermen are to ride to Westminster in the mayor's procession, in a cloak and hood at least, that are party-coloured with red, scarlet and white, the red on the right side"; while he quotes (from Letter-book H. fol. cxvii) the amusing sentence passed by his fellow-aldermen in 1382 on one John Seley, for disregarding the order to have his green cloak for the Whitsuntide procession lined with green taffeta. Thus before the 15th century the aldermen apparently had not yet their scarlet robes, but on state occasions wore the ordinary city livery. For the early 15th century we have the *Liber Albus* (written c. 1419; Rolls Series, ed. Riley), where we are told (p. 35) that "The Mayor, Sheriff and Aldermen were wont to array themselves in like suits of robes twice in the year, viz. when the mayor rode to Westminster to take the oath, and on the day following the feast of SS. Simon and Jude; and this raiment was trimmed with fur as befiting their honourable rank; and when they would also dress themselves in suits of robes against the feast of Pentecost, these robes having a lining of silk." The scarlet, violet and black robes, still worn by the Lord Mayor, aldermen, &c., were early in use. There is an order of 1421 (8 Henry V.) that the aldermen should use "togis et armillausa de scarleto," and in numerous accounts of royal receptions and other solemn occasions in the City we are told that the mayor and aldermen were in scarlet (W. St John Hope, in *Corporation Plate and Insignia*, i., *Introductio*, lxxxv seq., and ii. 138-147), quotes a number of these, and treats the whole subject of mayors', &c., robes very fully). The *Liber Albus* (i., ch. vi.) also shows us the mayor and aldermen assembled at the Guildhall on the day of the election of the new mayor *induti togis de violis*. As to the form of the dress in the 14th and 15th century, we can see from brasses of lord mayors and aldermen (see Haines, *Manual*, pp. cc-cxi and Cotman, *Norfolk Brasses*). There is a fine series of brasses of mayors, &c., at Norwich) that it consisted of a long gown, a mantle fastened on the right shoulder and a hood.

As to the provincial mayors and aldermen there is evidence that at quite an early date many of them followed the fashion of London; e.g. the Royal Charter of Nottingham, of 1448, contains the words: "that the Aldermen of the same town forever . . . may use gowns, hoods and cloaks of one suit and one livery together with furs and linings suitable to these cloaks, in the same manner and form as the Mayor and Aldermen of our city of London do use, the Statute of Liveries . . . notwithstanding" (see *Nottingham Records*, ii. 208), while the charter granted by Henry VI. to Kingston-on-Hull in 1440 contains practically the same words (see St. J. Hope, i. lxxxvii). The costume of provincial mayors, &c., is shown by St. John Hope (*loc. cit.*) to have generally consisted of a scarlet furred gown and cloak, with tippet or scarf of black velvet. The colour was not, however, invariably scarlet, but varied to violet, blue and black, sometimes even for the mayor. An account of the robes of modern provincial mayors will be found in St. J. Hope, p. lxxxix seq. and under the accounts of the various boroughs, *passim*.

There is some doubt as to when the Lord Mayor first began to wear his robe of estate of crimson velvet. Stow (*Survey*, ed. Strype, 1720, ii. 165) says that at the reception of Henry VI. at Eltham the mayor was in crimson velvet, the aldermen in scarlet with "sanguine" hoods, but at the coronation of Edward V. (see St. J. Hope) he wore scarlet. At the coronation of Anne Boleyn (see Writchesley's *Chronicle*, *loc. cit. sup.*, and Hall's *Chronicle*) the mayor wore his crimson velvet robe of estate, the aldermen and sheriffs scarlet; and at the entry of Anne of Cleves into London the mayor was again in his crimson velvet robe with his collar of gold, the aldermen and councilmen in robes of black velvet with chains of gold (but see



FIG. 5.—Liveries of Leathersellers' Company, from a charter of James I. (1604).

FIG. 4.—Liveries of the Leathersellers' Company, from the charter of the Company granted by Henry VI. (1444).

with the neck, wrists and round the bottom with fur and with white girdles (see fig. 4, from a coloured reproduction in W. H. Black's *History and Antiquities of the Leathersellers' Co.*).

In the reign of Henry VIII., Holbein's picture of the king giving a charter to the Barber-Surgeons' Company shows the members of the latter wearing gowns of rich stuff, with red and black party-coloured hoods, three of the figures also in coifs. The form of gown which has survived, practically unchanged, till the present day; may be seen on the second charter of the Leathersellers' Company, granted them by James I. in 1604 (see fig. 5, and for coloured plate see W. H. Black, *op. cit.*). Here we see them in flat caps, long black furred gowns, with false sleeves, and having on the right shoulder party-coloured hoods



Lord Chief Justice of England in full robes, scarlet and ermine, with collar of S. S.



The Lord High Chancellor of England, in robes of State.



Judge of the Supreme Court of the United States of America.



Judge of the High Court, England, in black robes.



Lord Mayor of London, in full robes.



Alderman of the City of London, in bench robes.



Lord Chief Justice of England in full robes, scarlet and ermine, with collar of S. S.



The Lord High Chancellor of England, in robes of State.



Judge of the Supreme Court of the United States of America.



Judge of the High Court, England, in black robes.



Lord Mayor of London, in full robes.



Alderman of the City of London, in bench robes.

St J. Hope, ii. 144, who quotes the order for these same robes, from which it would appear that the mayor also wore black velvet.

About this period begin to occur notices of the wearing of official robes by the wives of mayors and aldermen; and V.G. for Lincoln there is an entry in the corporation records in 1544: "Every alderman that hath not been mayor to prepare for himself and his wife gowns of crimson, and every one that hath been mayor to prepare for himself and his wife gowns of scarlet and tippets of velvet to be worn at all principal feasts" (see 14th report, *Hist. MSS. Commis.*, App. V, 111). St. John Hope (p. lxxix) quotes numerous instances in the 16th century, in some of which the husband was liable to a heavy fine in the event of his wife's non-compliance with the rule.

In 1568 (see Stow, and J. G. Nichols, *Account of 55 Royal Processions and Entertainments*, pt. ii. p. 94) first appeared an "Order observed by my Lord Mayor, Aldermen and Sheriffs, for their meetings and wearing the apparel throughout the whole year, according as formerly it hath been used," which has been altered and revised from time to time by order of the Corporation, and is still issued under the name of the *Handbook of Ceremonials to the officers of the City Corporation*. In 1568 we find the aldermen and sheriffs going to Westminster in the Lord Mayor's procession in scarlet-furred gowns and their cloaks borne with them; and in 1575 Nichols quotes a London citizen's description of the same procession; "they of the livery in their long gowns, with hood on the left shoulder, half black and half red. . . The Mayor in a long gown of scarlet, and on his left shoulder a hood of black velvet, and a collar of SS. . . The Aldermen in scarlet gowns, those having been mayors with chains of gold, the others with black velvet tippets." The Order of 1629 gives particulars of the various gowns; the cloaks are violet for Michaelmas to Whitsuntide, furred, for mayors and ex-mayors, with "amys," for aldermen with "calabre," and scarlet in summer, lined with "changeable taffety" and "green taffety" respectively.

After the 16th century the costume of the Lord Mayor can be studied in successive "Orders" or Ceremonial Books, accounts of coronations, &c., and in portraits and statues belonging to the various city companies. Early in the 10th century (1806) the Lord Mayor began to wear on some state occasions a black robe with gold lace, similar to that of the Lord Chancellor. The Ceremonial Book was thoroughly revised in 1864, and the latest edition is that issued in 1906 (*Handbook of Ceremonials*, &c., issued under the direction and with the approval of the Privileges Committee of the Court of Aldermen").

At the present day the Lord Mayor has several sets of robes; a special coronation robe (see illustration in Naylor, *Book of the Coronation of George IV.*, 1837), a crimson velvet robe of state like that of an earl, worn with the chain and jewel, e.g. in the presence of the sovereign when in the city;¹ a black robe of state trimmed with gold, which is worn with the chain and jewel, e.g. at the Guildhall on Lord Mayor's Day; the scarlet robes, which are worn, with or without the chain, on most public occasions, such as the service at St Paul's on the first day of the Easter Law Term, audiences of the sovereign, the election of the Lord Mayor, the opening of the Central Criminal Court, &c.; a violet gown, which is worn, e.g., when the Lord Mayor elect is presented to the king, when he is sworn in, at the election of sheriffs, &c., and a black gown worn in church on Good Friday, &c. The aldermen wear scarlet on most occasions of ceremony, ex-mayors "having the Cap of Dignity attached to their gown, and being entitled to introduce a sword and mace into their badges." Violet robes are also worn on certain occasions marked in the almanac of the *Alderman's Pocket-Book*; and black gowns when the Lord Mayor wears his. The sheriffs and recorders² have scarlet, violet

¹ Sir G. G. Young in a pamphlet called *The Place of the Lord Mayor in proceeding through or within the City of London* (1852), quotes various royal visits to the city which seem to show that the Lord Mayor did not always wear his crimson velvet robe on these occasions. Thus in 1638 Charles I., on going to meet Marie de Médicis, was met by the Lord Mayor in scarlet, which was also worn at the entry of Charles II. in 1660. In 1702, when Queen Anne went to a thanksgiving service at St Paul's, the Lord Mayor wore crimson velvet, with the collar and jewel; but in 1705, at the thanksgiving after Blenheim, he met the queen on horseback, dressed in scarlet. In 1714, at the reception of George I., the Lord Mayor wore crimson velvet robes.

² The recorders had from an early date annual suits of robes like the mayor, aldermen, &c. See *Liber Albus*, p. 43: "Habet itaque Recordator pro feodo de Camera tontiens et talem vestimurum lineatum sive penulatum, chaperon et qualem Major et Aldermann capiant annuatim." The chamberlain, common serjeant, &c., had also gowns (see an order of 1523 in St. J. Hope, ii. 146). For the sword-bearer's cap of maintenance see article CAP and St. John

and black gowns, and the members of the common council have deep mazarine blue gowns, which seem to have been first prescribed in 1761.

For Scotland an order of James I. and VI. of 1610 (see *Register of Privy Council, loc. cit.*) ordered that the provosts, aldermen, &c., of every borough should wear, for ordinary occasions, black furred gowns, the officers of the chief boroughs having also scarlet furred gowns for Sundays and other solemn occasions, when the provost of Edinburgh was to wear a gold chain.

Academic Costume.—No thorough study has so far been made of early English academic costume as compared with that of the continental universities—a study which ought to throw much light on the subject.³ A vexed question is that of how far academic dress is derived from the ecclesiastical. Anthony Wood's view, that it was derived from the *tunica talaris* and *caucullus* of the Benedictines, would not now meet with much support; but many writers seem to be unnecessarily anxious to trace each item of the academic robes to some definite ecclesiastical garment. The medieval scholar was of course a clerk, and had to wear the clerical gown and the tonsure. But the fact that this was the case makes it more difficult to distinguish between academical and ecclesiastical robes, notably in the case of brasses and other monuments of university graduates and dignitaries who were also priests. Another source of difficulty is the variety of names by which the different parts of the academic costume are called in the university statutes and elsewhere, resulting sometimes in inextricable confusion.

The earliest information as to English academic dress is found in the second half of the 14th century. Certain early statutes show that "excess in apparel" had already to be rebuked in scholars (cf. the Constitution of Archbishop Stratford, 1342), while the statutes of certain colleges require of the scholars the tonsure and a "decent habit" suitable to a clerk (cf. Statutes of Peterhouse, 1344, and of Merton Coll., Oxford), i.e. a long gown (*toga* or *tunica talaris*), which it is stipulated in some cases must be closed in front. Some colleges had liveries, prescribed perhaps by the founder of the college and laid down by the statutes. The differences of colour and shape in the undergraduate gowns of most of the Cambridge colleges are supposed to be a survival of this. There was also an ordinance of Richard II. for King's Hall, Cambridge (1379), which fixed the dress of a scholar as the *roba talaris*, over which, if a bachelor, he should wear a tabard suited to his degree. The undergraduates seem in the early days to have worn a hood, the ordinary head-covering worn by all, but they gradually ceased to do so, until nobody below the rank of a bachelor might wear one.

It is proposed to give here (1) a list of the various parts of the academic dress, with a few remarks on each; (2) a short account of the early costume of the various degrees; (3) a sketch of any changes which have taken place since the Reformation.

The Gowns (*toga*, *roba*, or *tunica talaris*) was worn by all degrees, as befitting clerks. It is hard to determine whether there was at first any difference between the gown of the higher degrees, which some maintain was the *roba*, and that of the lower degrees, the *toga* or *tunica talaris*, but it seems improbable. It was frequently fur-lined, but the use of the more costly furs was forbidden to all below the degree of Master, except sons of noblemen, or those possessing a certain income, bachelors using budge (see in Anstey's *Munimenta Academica*, p. 301, the Hope i. lxxvi-lxxix. For mayor's and sheriff's chains see ibid. pp. lxxix-lxxxiv.

³ Practically the only detailed study of early English academic costume is a paper on "English Academic Costume (Medieval)," by Dr E. C. Clark, in *Archaeological Journal*, vol. i. pp. 74 seq., 137 seq., and 183 seq., which contains a mass of information, and upon which the present article is to a great extent based. Rashdall (*Universities of Europe in the Middle Ages*, vol. ii. pt. ii.) and Druitt (*Costume on Brasses*, ch. ii.) each devote a chapter to the subject; Rashdall treats of both the English and continental universities, not very thoroughly, Druitt of English academic dress only, but thoroughly. Clark gives many facts about foreign, as well as the English, costume.

statute of 1432 *de admissione ad pelluram*). Students, and even doctors in theology (*Mun. Acad.* ii. 303), were also restricted to budge, and to sad-coloured habits. The robes of masters were to be flowing and reach to the ankles (see *Mun. Acad.* p. 212, an order of 1358 to the tailors not to stint the robes, which should be "*largae et talares*," because clerks should be distinguished from the laity).

The COPE, worn as part of academic dress over the gown, probably originated in the ordinary *cappa clericalis*, or everyday mantle of the clergy, which had been introduced into general use in England by synods of 1222, 1237 and 1268.¹ This kind of cope, closed in front, and originally black in colour, is generally known as the *cappa clausa*, and sometimes, for convenience' sake, had a slit in front to allow of the passage of the hands. It was worn by Regent Masters when lecturing



FIG. 6.—Members of New College, Oxford, from Chandler MS. (15th century).

(*Mun. Acad.* p. 421) and as a full dress by certain doctors. By the second half of the 14th century differences of colour occur; e.g. the Chancellor represented in a 14th-century miniature in the *Oxford Chancellor's Book* (reproduced by J. W. Wells, *The Oxford Degree Ceremony* (1906), facing p. 19) wears a scarlet cope closed in front, lined with miniver and with tippet and hood of miniver, and there is also a mention in an ancient statute of Cambridge of a red cope worn by Inceptors in Canon Law (Clark, p. 102). The Rev. N. F. Robinson (*loc. cit.* p. 195) quotes the will of R. Browne, archdeacon of Rochester (d. 1452), to prove that the habit of a doctor of civil law was violet; he also thinks that that of a doctor of theology was green, and of a doctor of canon law scarlet. By the 16th century all copest were scarlet. Clark (p. 138) gives as evidence "Stokys' picture" in the Cambridge Registry. The scarlet *cappa clausa* has

¹ See Rev. T. A. Lacey in *Transactions of the St Paul's Ecclesiastical Society*, vol. iv. (1900), p. 128, &c. Also Rev. N. F. Robinson in the same (1898), pp. 181-220.

survived to the present day at Cambridge as the dress worn by the Vice-Chancellor and by Regius Professors of Divinity, Law and Medicine when presenting for degrees. It is now open down the front, but the fur edging only reaches half-way down, marking the place where the slit used to be. At Oxford the so-called "cope" which is the Convocation robe of certain doctors is not a real cope, but is probably derived from the medieval tabard, the out-of-door dress worn by the clergy and others, it having become customary by the beginning of the 16th century for Regent Masters to wear the tabard at lectures as more convenient than the cope (Rashdall, II. ii. 639, and *Mun. Acad.* p. 421, where the *pallium* is spoken of as an alternative to the *cappa clausa*. The *pallium* is most probably to be identified with the tabard).² The *cappa manicata* mentioned in Anstey (*Mun. Acad.* p. 421, &c.) seems to have been a shorter gown with bell-shaped sleeves reaching to the elbow, and lined with fur, worn by masters and bachelors of arts (see Druitt, p. 124), and a shorter tabard is also occasionally found (Robinson's *Taberdum ad medias libias*). These are illustrated in fig. 6 from a MS. of the 15th century at New College, Oxford.³ The D.D.'s wear the *cappa clausa*, the other doctors tabards (see also pl. iii., xvi. in *Archaeologia*, where William of Wykeham and all the doctors wear long sweeping tabards, as ample as copes), the Warden a shorter tabard, reaching just below the knees, and the M.A.'s gowns or tabards with false sleeves.

The HOOD was originally worn by all scholars, as by everybody, and had evidently no academic significance. Sometimes a cap was also worn, the hood being thrown back (Chaucer's "clerk of Oxenford" in the Ellesmere MS. illumination wears a red skull-cap, and a furred tippet and hood, with the hood falling rather back, though not on his shoulders). The liripipe⁴ became somewhat elongated, as is seen in the hoods of the so-called M.A. group in the Chandler MS. An early mention of the undergraduate hood is the much-discussed Oxford Statute of 1489 (*Mun. Acad.* p. 360), which reads: "ut nullus de cetero scholaris non-graduatus (nobili sanguine insignitis &c. exceptis) capitulo quovis utatur publice . . . nisi lirippium consutum habeat et non contextum, prout antea Universitatis laudabilis consuetudo exposcit . . ."⁵ but the undergraduate

² Clark (pp. 138-39) treats of the *pallium* and tabard as two separate garments, deciding that the *pallium* was a kind of tippet. Robinson considers the *pallium* to correspond to the tabard, his *taberdum talare*, which the Rev. T. A. Lacey (p. 128) also compares with the chimere of Anglican bishops. (See article CHIMERE, where the chimere is likewise traced to the tabard.) Moroni, *Dizionario dell'erudizione storico-ecclasiastica*, s.v. *zimarra*, says that professors of the university of Rome wear black *zimarre* while teaching. This recalls the *pallium* of Regent Masters (*Mun. Acad.* p. 421) and Inceptors in arts and medicine (*id.* p. 430).

³ The Chandler MS. The drawings from which the illustration is taken are reproduced in the *Transactions of the St Paul's Ecclesiastical Society*, p. 208, with an explanatory article by the Rev. N. F. Robinson, and in *Archaeologia*, vol. liii. pl. i., with notes by F. Kirby. Robinson identifies the various groups of the Society of New College with his plate i. (xv. in *Archaeol.*) by the aid of a statute of the College settling the order of standing in choir and at processions, and thus claims to settle the question of the dress of the various kinds of Doctor and Bachelor, M.A.'s, &c., at the period.

⁴ In the present article "liripipe" will be used of the tail of the hood, "tippet" of the shoulder-cap, sometimes forming part of the same garment as the hood, sometimes not, and "scarf" of the "tippet" or scarf, e.g. of D.D.'s, Anglican clergy.

⁵ That no non-graduate scholar (with the usual exceptions of noblemen, &c.) shall wear any kind of hood in public, unless it have the liripipe sewn on, and not woven in one piece, as the ancient and venerable custom of the university demands." The meaning of this is not clear; Anstey (marginal note *ad loc.*) takes it to mean that the tail of the hood should be sewn to the hood; others that the tail of the hood should be sewn down to the gown; cf. Chaucer, *Prologus to Canon's Yeoman's Tale*: "Till that I understood How that his cloke was sowed to his hood, For which, when I hadde long avysed me, I demed him some Chanoun for to be," which shows that this method of sewing the hood, whatever it were, was used to define rank; others again hold that "lirippium" here means a tippet or shoulder-cap, and that for some reason the hood was to be sewn to the tippet and not made all in one piece with it. Rashdall sees "consutum" instead of "consutum" (footnote ii. p. 641). The Constitution of Archbishop Bourchier (1463) forbids undergraduates to use lirippies or "tippets" round the neck in public (Clark, p. 85), so the sewing down of the liripipe at the back may

ROBES

PLATE V.



D.C.L., Oxford.



LL.D., Cambridge.



D.D., Oxford.



D.D., Cambridge.



Doctor of Music, Oxford.



M.A., Oxford.



M.A., Cambridge.



M.A., Trinity College, Dublin.

Robes lent by Ede, Son & Ravenscroft, Chancery Lane, London

ROBES



D.C.L., Oxford.



L.L.D., Cambridge.



D.D., Oxford.



D.D., Cambridge.



Doctor of Music, Oxford.



M.A., Oxford.



M.A., Cambridge.



M.A., Trinity College, Dublin.

hood had gone out of use by the end of the 16th century.¹ Bachelors' hoods were to be lined throughout with fur (*Mun. Acad.* p. 361), which we learn from the statute *de admissione ad pelturam* (1432) to have been budge. Masters and noblemen might use miniver, or silk in summer (*Mun. Acad.* pp. 283, 301). There were evidently hoods of at least two kinds for masters, sometimes called respectively *caputium* and *epomis*, whether corresponding to the distinction between regents and non-regents we do not know. (See *Mun. Acad.* p. 638, will of Thomas Bray, M.A., and Robinson, *loc. cit.* In the Oxford *Corpus Statutorum* of 1768 the *epomis* is worn with the ordinary gown, the *caputium* with the scarlet habit.) At a later date, at Cambridge, a distinction was made between the hoods of non-regents, which were lined with silk, and those of regents, which were lined with miniver.² Later again the regents wore their hoods in such a way as to show the white lining, while the non-regents wore theirs "squared," so that the white did not show. Hence the name "White Hoods" and "Black Hoods" given to the upper and lower houses of the old Senate respectively. It is not settled when the modern colourings of hoods arose; they probably followed those of the gowns of the faculties, but about these we are equally uncertain. The Oxford Proctor still wears a miniver hood. The modern Cambridge hood has preserved the original shape more closely than the Oxford one, being a hood and tippet combined, the hood having square corners. The tippet, which appears as part of the early costume of certain doctors, was probably, like the judges' tippet, originally the shoulder-cape forming part of the same garment as the hood. Clark and others would derive it from the *almuce* (q.v.), but do not seem to show any definite grounds for so doing. Its place seems to have been taken by the scarf worn by D.D.'s, &c., probably developed from the hood with long lipripe as worn turbanwise on the head or as a scarf round the shoulders. It seems rather far-fetched to derive the scarf from the two pendants of the *almuce*.³ (See article VESTMENTS and cp. the mayor's scarf mentioned above.)

There seem to have been at least three varieties of academic head-dress: firstly, the doctor's skull-cap with "apex" as illustrated in the Chandler MS. drawings; secondly, the square cap of cloth as prescribed by Laud's statutes of 1636 for graduates and foundation scholars (similarly for Cambridge by Burleigh's letter to the vice-chancellor in 1588), with its counterpart of velvet worn by doctors; thirdly, a round cloth cap prescribed by the Laudian statutes and Burleigh's letter for undergraduates who were not foundation scholars, with the round cap of velvet for doctors which survives as part of their full dress to the present day. The square cap was adopted at the universities, according to Robinson, after 1520, in imitation of the university of Paris. For the development of the modern "college cap," see BIRETTA. In this connexion should be mentioned the term "tuff-hunting," i.e. attempting to thrust oneself into the society of one's social superiors, derived from the gold tuffs or tassel worn by noblemen and fellow-commoners on their college caps.

As to the dresses of the different degrees, the drawings from the Chandler MS. give a good idea of the early costume. It is also

have been to prevent this improper use as a scarf. But in this case, what is the force of "et non contentum"?

An interesting survival, which only disappeared about the middle of the 19th century, was the little black hood placed round the neck of candidates going in for *viva voce* in all examinations subsequent to responses at Oxford. This was a survival of the custom of conferring on *sophistae generales*, i.e. those who had passed the first stage of the exercises for the B.A. degree, a hood of plain black cloth. See A. Clark's *Introduction to the Registers of Oxford University*, vol. ii. pt. i. p. 22 (Oxford Hist. Soc., 1887).

See *Cain's Statutes* (1557), also an account of the entertainment at Cambridge on the visit of Queen Elizabeth, 1564, given in Nichols, *Progresses*, vol. iii. "Theologie Baccalarius ad non Regentes primum, sericis caputium induti, tum Regentes Magistri suis pelliciosis albescentibus decorati; tandem Juris Artiumque Baccalarius suis agnibus braceis conspici.".

See Rev. E. Wickham Legg in *Trans. of St Paul's Eccles. Soc.* vol. iii. Also Lacey and Robinson (*loc. cit.*).

The subject is discussed in detail by Clark, "College Caps and Doctors' Hats," in *Archaeol. Journ.*, vol. lxi., and N. F. Robinson, "Pileus Quadratus," in *Transact. of St Paul's Ecclesiastical Soc.*, vol. v. pt. 1. (1901). There is also much miscellaneous information in C. Wordsworth, *University Life in the 18th Century*, p. 499 seq.

well illustrated by brasses.⁴ Doctors of theology seem to have worn a tippet but no hood. Masters of Arts seem to have worn a gown, over which was a garment with bell-shaped sleeves reaching to the elbow, a tippet and a hood (see Druitt, plate facing p. 136, and p. 135). The same dress was sometimes worn by B.A.'s (see brass of John Palmer, B.A., d. 1479, New College, Oxford, in Druitt, p. 141), and bachelors of law and divinity, the latter being generally already M.A.'s (Druitt, p. 139). Haines's theory is that after the middle of the 15th century the dress of the M.A.'s was changed, and they wore a sleeveless tabard reaching to midway between ankle and knee. This costume certainly occurs on brasses, chiefly of the 16th or late 15th centuries, but the change is hard to explain.⁵

Academic dress underwent much inquiry and some revision at the time of the Reformation, chiefly in the direction of sobriety and uniformity, "excess of apparel" being repressed as severely as ever, but not with much more effect.⁶ Burleigh's letter to the Vice-Chancellor of Cambridge University (1588), and the statutes of Queen Elizabeth, strictly enforce the wearing of cap and gown by all, and hoods and habits by those entitled to wear them, and similar regulations were made for Oxford by Laud's statutes of 1633, further details being dealt with by a decree of 1770. Academic dress during the 17th century may be further studied in Bedel Buck's book (1665, see Appendix B. to Peacock, *Observations on the Statutes of the University of Cambridge*), and Loggan's plates of academic costume in *Oxoniana Illustrata* (1675) and *Cantabrigia Illustrata* (1690, ed. J. W. Clark, 1905).

There have been few far-reaching changes since Loggan's day. Cambridge has of late years inquired into and revised her regulations as to dress, and in the *Ordinances* (latest ed. 1908, Statute A, cap. VII. p. 303) clear rules are laid down; the Oxford regulations (see *Statuta et Decreta Univ. Oxon.*

¹ See for doctors' costume, J. G. and L. A. B. Waller's *Series of Monumental Brasses* (London, 1864), plate of "Four Ecclesiastics," from New College, Oxford, who are also illustrated in Druitt, pp. 131, 129, 119; and for M.A.'s and B.A.'s, Druitt, p. 135 seq. and plate facing p. 136. On the brass of John Lowthe, D.C.L., should be noticed the two curious long streamers or lipriipes hanging from the back of his tabard or hood. It is hard to say what they can be; but the closest parallel is in the two streamers on the back of the old Oxford commoners' gown, which were probably survivals of sleeves. The same said to have given rise to the term "plucking," i.e. failing in examination, the story being that the man's credenda might assemble at the conferring of degrees, and by "plucking" at his gown prevent him from going up for his degree.

² It is just possible that this sleeved garment may be the *capa manicata* mentioned in *Mun. Act.* p. 421, "nullus regens in artibus . . . in capa manicata lectiones legat ordinarias, sed in pallio vel capa clausa." Clark (pp. 188, 189, &c.) identifies the *capa manicata* with the tabard, but if, as suggested above, the *pallium* is the tabard, the *capa manicata* cannot be the same. Braun, *Liturgische Gewandung*, p. 308, shows that a sleeved cope, called *capa manicata*, did develop from the *capa clericalis* or everyday cope of the clergy, at the end of the 12th century, its use being forbidden by various synods. It is possible, then, that the *capa manicata* may have been worn by non-regents, the tabard (which Haines alleges to have been adopted generally by M.A.'s in the late 15th century), or *pallium*, by regents.

³ The essential parts of Laud's statutes, Burleigh's letter, &c., with much other matter bearing on academic costume from the 16th century onwards, will be found in C. Wordsworth's *University Life in the 18th Century* (London and Cambridge, 1874, p. 485 seq.).

To the passages quoted by him may be added the following from *Johann's Berekh's Commentarii*, an eye-witness's account of Queen Elizabeth's visit to Oxford in 1566 (published in *Elizabethan Oxford*, ed. C. Plummer, Oxford Hist. Soc., 1887); at one of the disputations Mr. Campion, M.A., was dressed as follows: "Toga illi tum Dalmatica talaris fuit, manicis remissis ac largitate sua diffinitibus. Huic pallium inductum est undique consutum, praeter quam qua dextro patebant astitit. Postremo erant humeri superius pellicibus albis, candoreque lucentibus, redimiti. Atque hic tum habitus fuit omnium magistrorum, praeterquam quod nonnulli, loco pallidum intulit illius pellicae, sericeo utebantur, omni colore variegato."

This points to the wide-sleeved gown, tabard and hood as the dress of masters, but the colour of the hood was evidently not fixed. For Doctor White, D.C.L., at vestis Dalmatica talaris, ex electiori et clarissima purpura; lato clavo coccineo superius induebatur, additum postremo humeris paludamentum est ejusdem coloris, cum serico subtegmine, similique tum vestiti habitu omnes Doctores sedebant." Here *vestis Dalmatica* would be the ordinary gown, *clavus talaris* the scarlet gown, and *paludamentum* the hood, as before. For costume up to the middle of the 19th century see Wall-Gunning, *Ceremonies observed in the Senate House at Cambridge* (1828).

for 1909, Tit. xiv., *de vestitu et habitu*, pp. 327-328) have not been revised lately, and some of them are a dead letter.

Doctors of both universities have three sets of robes: firstly, the full-dress gown of scarlet cloth; secondly, the congregation habit and hood of scarlet (now at Cambridge a cope, at Oxford the so-called "cope"); thirdly, the black gown. The first is worn by all doctors except the doctor of music, and is accompanied by the round cap of velvet. The Oxford D.D. also wears a cassock, sash and scarf. The scarlet gown is of a different and older shape than the M.A. and B.A. gowns. As now worn, it is faced with silk of the same colour as the hood of the faculty. The second, or cope, has now gone almost out of use, but is still worn when presenting for degrees, &c. It is sometimes worn over the black gown. There are several types of black gown, but the tufted gown of Loggan's day has now gone out of use. The M.D. and Mus.D. black gowns at Cambridge are now made after the pattern of the LL.D. gown, with wing-like sleeve and flap collar, trimmed with black lace, but the D.D., D.Sc. and Litt.D. wear the M.A. gown, the former with the scarf, the two latter with lace on the sleeve, placed horizontally for D.Sc. and vertically for Litt.D. Some doctors of divinity wear the full-sleeved gown with scarf. The head-dress of a D.D. is the square cap, that of the lay doctors the velvet bonnet with gold cord. At Oxford, too, some doctors wear the M.A. gown, others the doctor's laced gown. The M.A. and B.A. gowns are two varieties of the civilian gown of the 15th and 16th century. The B.A. loose-sleeved gown is no longer worn with the sleeve tucked up round the elbow.

The Oxford sleeveless commoner's gown, though still by statute *talaris*, now reaches little below the waist, the full-sleeved scholar's gown to the knees. The tufted silk gown of the gentleman-commoner and the nobleman's gold-laced gown are not yet abolished by statute, but have fallen into disuse. Vice-Chancellors have no official costume, but wear the habit of their degree. The Chancellors of the older universities wear a black damask robe with gold lace, and a black velvet square cap with gold tassel or a doctor's velvet bonnet with gold cord; those of the newer universities have robes "created" by the robe-makers, who are nowadays to a large extent the arbiters of academic dress.

For the colours of the hoods of the various university degrees see UNIVERSITIES *ad fin.* (C. B. F.)

ROBESPIERRE, MAXIMILIEN FRANÇOIS MARIE ISIDORE DE (1758-1794), French revolutionist, was born at Arras on the 6th of May 1758. His family, according to tradition, was of Irish descent, having emigrated from Ireland at the time of the Reformation on account of religion, and his direct ancestors in the male line had been notaries at the little village of Carvin near Arras from the beginning of the 17th century. His grandfather, being more ambitious, established himself at Arras as an advocate; and his father followed the same profession, marrying Jacqueline Marguerite Carraut, daughter of a brewer in the same city, in 1757. Of this marriage four children were born, two sons and two daughters, of whom Maximilien was the eldest; but in 1767 Madame Derobespierre, as the name was then spelt, died, and the disconsolate widower at once left Arras and wandered about Europe until his death at Munich in 1769. The children were taken charge of by their maternal grandfather and aunts, and Maximilien was sent to the college of Arras, where he was nominated in 1770 through the bishop of his native town to a bursarship at the college of Louis-le-Grand at Paris. Here he had for fellow-pupils Camille Desmoulins and Stanislas Fréron.

Completing his law studies with distinction, and having been admitted an advocate in 1781, Robespierre returned to his native city to seek for practice, and to struggle against poverty. His reputation had already preceded him, and the bishop of Arras, M. de Conzié, appointed him criminal judge in the diocese of Arras in March 1782. This appointment, which he soon resigned, to avoid pronouncing a sentence of death, did not prevent his practising at the bar, and he speedily became

a successful advocate. He now turned to literature and society, and came to be esteemed as one of the best writers and most popular dandies of Arras. In December 1783 he was elected a member of the academy of Arras, the meetings of which he attended regularly; and, like all other young Frenchmen with literary proclivities, he began to compete for the prizes offered by various provincial academies. In 1784 he obtained a medal from the academy of Metz for his essay on the question whether the relatives of a condemned criminal should share his disgrace, the prize being divided between him and Pierre Louis Lacretelle, an advocate and journalist in Paris. An *éloge* on J. B. L. Gresset (1700-1777), the author of *Vert-Vert* and *Le Méchant*, written for the academy of Amiens in 1785, was not more successful; but Robespierre was compensated for these failures by his great popularity in the little literary and musical society at Arras known as the "Rosati," of which Carnot was also a member. There his sympathetic quality of Robespierre's voice, which afterwards did him such good service in the Jacobin Club, always caused his indifferent verses to be loudly applauded by his friends.

In 1788 he took part in the discussion as to the way in which the states-general should be elected, showing clearly and forcibly in his *Adresse à la nation artésienne* that, if the former mode of election by the members of the provincial estates were again adopted, the new states-general would not represent the people of France. Necker also perceived this, and therefore determined to make the old royal *bailliages* and *sénéchaussées* the units of election, which thus took place on the basis of almost universal suffrage. Under this plan the city of Arras was to return twenty-four members to the assembly of the *bailliage* of Artois, which was to elect the deputies. The corporation claimed the right to a preponderating influence in these city elections, and Robespierre headed the opposition, making himself very conspicuous and drawing up the *cahier*, or table of complaints and grievances, for the guild of the cobblers. Although the leading members of the corporation were elected, their chief opponent succeeded in getting elected with them. In the assembly of the *bailliage* rivalry ran still higher, but Robespierre had already made his mark in politics; by the *AVIS aux habitants de Campagne* (Arras, 1789), which is almost certainly by him, he secured the support of the country electors, and, though but thirty years of age, poor and without influence, he was elected fifth deputy of the *tiers état* of Artois to the states-general.

When the states-general met at Versailles on 5th May 1789, the young deputy of Artois already possessed the one faculty which was to lead him to supremacy: he was a fanatic. As Mirabeau is reported to have said: "That young man believes what he says: he will go far." Without the courage and wide tolerance which make a statesman, without the greatest qualities of an orator, without the belief in himself which marks a great man, nervous, timid and suspicious, Robespierre yet believed in the doctrines of Rousseau with all his heart, and would have gone to death for them; and in the belief that they would eventually succeed and regenerate France and mankind, he was ready to work with unwearied patience. While the Constituent Assembly occupied itself in drawing up a constitution, Robespierre turned from the assembly of provincial lawyers and wealthy *bourgeois* to the people of Paris. However, he spoke frequently in the Constituent Assembly, and often with great success, and was eventually recognized as second only to Pétion de Villeneuve—if second to him—as a leader of the small body of the extreme left,—the thirty voices, as Mirabeau contemptuously called them. It is hardly necessary to examine minutely Robespierre's speeches and behaviour before 1791, when the death of Mirabeau left the way clear for the influence of his party; but what is noteworthy, as proving the religious cast of his mind and his belief in the necessity of a religion, is that he spoke several times in favour of the lower clergy and laboured to get their pensions increased. When he instinctively felt that his doctrines would have no success in the Assembly, he turned to the Society of the Friends of the Constitution, known

later as the Jacobin Club, which had consisted originally of the Breton deputies only, but which, after the Assembly moved to Paris, began to admit among its members various leaders of the Parisian bourgeoisie. As time went on, many of the more intelligent artisans and small shopkeepers became members of the club, and among such men Robespierre found the hearers he sought. They did more than listen to him: they idolized him; the fanatical leader had found followers. As the wealthier bourgeoisie of Paris and deputies of a more moderate type seceded to the club of '89, the influence of the old leaders of the Jacobins (Barnave, Dupont, Alexandre de Lameth) diminished; and when they themselves, alarmed at the progress of the Revolution, founded the club of the Feuillants in 1791, the followers of Robespierre dominated the Jacobin Club. The death of Mirabeau strengthened Robespierre's influence in the Assembly; but on the 15th of May 1791 he proved his lack of statesmanlike insight and his jealous suspicion of his colleagues by proposing and carrying the motion that no deputies who sat in the Constituent could sit in the succeeding Assembly. The flight of the king on the 20th of June and his arrest at Varennes made Robespierre declare himself at the Jacobin Club to be *ni monarchiste ni républicain*. After the "massacre" of the Champ de Mars (on the 17th of July 1791) he established himself, in order to be nearer to the Assembly and the Jacobins, in the house of Duplay, a cabinetmaker in the Rue St Honoré, and an ardent admirer of his, where he lived (with but two short intervals) till his death. At last came his day of triumph, when on the 30th of September, on the dissolution of the Constituent Assembly, the people of Paris crowned Pétion and himself as the two incorruptible patriots.

On the dissolution of the Assembly he returned for a short visit to Arras, where he met with a triumphant reception. In November he returned to Paris, and on the 18th of December made a speech which marks a new epoch in his life. Brissot de Warville, the *dme politique* of the Girondin party which had been formed in the Legislative Assembly, urged vehemently that war should be declared against Austria, and the queen was equally urgent, in the hope that a victorious army might restore the old absolutism of the Bourbons. Two men opposed the projects of the queen and the Girondins—Marat and Robespierre. Robespierre feared a development of militarism, which might be turned to the advantage of the reaction. This opposition from those whom they had expected to aid them irritated the Girondins greatly, and from that moment began the struggle which ended in the *coups d'état* of the 31st of May and the 2nd of June 1793. Robespierre persisted in his opposition to the war; the Girondins, especially Brissot, attacked him violently; and in April 1792, he resigned the post of public prosecutor at the tribunal of Paris, which he had held since February, and started a journal, *Le Défenseur de la Constitution*, in his own defence. It is noteworthy that during the summer months of 1792 in which the fate of the Bourbon dynasty was being sealed, neither the Girondins in the Legislative Assembly nor Robespierre took any active part in overthrowing it. Stronger men with practical instincts of statesmanship, like Danton and Billaud Varenne, who dared to look facts in the face and take the responsibility of doing while others were talking, were the men who made the roth of August and took the Tuileries. The Girondins, however, were quite ready to take advantage of the accomplished fact; and Robespierre, likewise, though shocked at the shedding of blood, was willing to take his seat on the Commune of Paris, which had overthrown Louis XVI., and might check the Girondins. The strong men of the Commune were glad to have Robespierre's assistance, not because they cared for him or believed in him, but because of the help got from his popularity, his reputation for virtue, which had won for him the surname of "The Incorruptible," and his influence over the Jacobin Club and its branches, which spread all over France. He it was who presented the petition of the Commune of Paris on 16th August to the Legislative Assembly, demanding the establishment of a revolutionary tribunal and the summoning of a Convention. The massacres

of September in the prisons, which Robespierre in vain attempted to stop, showed that the Commune had more confidence in Billaud than in him. Yet, as a proof of his personal popularity, he was a few days later elected first deputy for Paris to the National Convention.

On the meeting of the Convention the Girondins immediately attacked Robespierre; they were jealous of his influence in Paris, and knew that his single-hearted fanaticism would never forgive their intrigues with the king at the end of July. As early as the 26th of September the Girondin M. D. A. Lasource accused him of aiming at the dictatorship; afterwards he was informed that Marat, Danton and himself were plotting to become triumvirs; and eventually on the 20th of October Louvet de Couvrai attacked him in a studied and declamatory harangue, abounding in ridiculous falsehoods and obviously concocted in Madame Roland's boudoir. But Robespierre had no difficulty in rebutting this attack (5th of November), while he denounced the federalist plans of the Girondins. All personal disputes, however, gave way by the month of December 1792 before the great question of the king's trial, and here Robespierre took up a position which is at least easily understood. These are his words spoken on the 3rd of December: "This is no trial; Louis is not a prisoner at the bar; you are not judges; you are—you cannot but be—statesmen, and the representatives of the nation. You have not to pass sentence for or against a single man, but you have to take a resolution on a question of the public safety, and to decide a question of national foresight. It is with regret that I pronounce the fatal truth: Louis ought to perish rather than a hundred thousand virtuous citizens; Louis must die, that the country may live." This great question settled by the king's execution, the struggle between Robespierre and the Girondins entered upon a more acute stage, and the want of statesmanship among the latter threw upon the side of the fanatical Robespierre Danton and all those strong practical men who cared little for personal questions, and whose only desire was the victory of France in her great struggle with Europe. Had it been at all possible to act with that group of men of genius whom history calls the Girondins, Danton, Lazare Carnot, Robert Lindet, and even Billaud-Varenne, would have sooner thrown in their lot with them than with Robespierre, whom they thoroughly understood; but the Girondins, spurred on by Madame Roland, refused to have anything to do with Danton. Government became impossible; the federalist idea, which would have broken France to pieces in the very face of the enemy, grew and flourished, and the men of action had to take a decided part. In the month of May 1793 Camille Desmoulins, acting under the inspiration of Robespierre and Danton, published his *Histoire des Brissotins* and *Brissot démasqué*; Maximin Isnard declared that Paris must be destroyed if it pronounced itself against the provincial deputies; Robespierre preached insurrection at the Jacobin Club; and on the 31st of May and the 2nd of June the Commune of Paris destroyed the Girondin party. For a moment it seemed as if France would avenge them; but patriotism was stronger than federalism. The defence of Lyons exasperated the men who were working for France, and the armies who were fighting for her, and on the 27th of July 1793, when the struggle was practically decided, the Convention elected Robespierre to the new Committee of Public Safety. He had not solicited, so it seems, nor even desired this election, yet it marks an important epoch, not only in the life of Robespierre, but in the history of the Revolution. Danton and the men of action had throughout the last two years of the crisis, as Mirabeau had in the first two years, seen that the one great need of France, if she was to see the end of her troubles without the interference of foreign armies, was the existence of a strong executive government. The means for establishing the much-needed strong executive were found in the Committee of Public Safety. The success of this Committee in suppressing the Norman insurrection had confirmed the majority of the Convention in the expediency of strengthening its powers, and the Committee of General

Security which sat beside it was also strengthened and given the entire management of the internal police of the country. It was not until Robespierre was elected to the Committee that he became one of the actual rulers of France. Indeed, the Committee was not finally constituted until the 13th of September, when the last two of the "great" twelve who held office until July 1794 were elected. Of these twelve at least seven—Lazare Carnot, Billaud-Varenne, Collot d'Herbois, Prieur Duvernois (of the Marne), Prieur (of the Côte d'Or), Jean Bon Saint-André and Robert Lindet—were essentially men of action, and were entirely free from the influence of Robespierre. Of the other four, Héroult de Séchelles was a professed adherent of Danton, Barère de Vieuzac was an eloquent Provençal, who was ready to be the spokesman to the Convention of any view which the majority of the Committee might adopt; and only Georges Couthon and Saint-Just, devoted to Robespierre, adroitly sustained his policy. It is necessary to dwell upon the fact that Robespierre was always in a minority in the great Committee in order to absolve him from the blame of being the inventor of the Terror, as well as to deprive him of the glory of the gallant stand made against Europe in arms.

After this examination of Robespierre's position it is not necessary to investigate closely every act of the great Committee during the year which was pre-eminently the year of the Terror; the biographer is rather called upon to examine his personal position with regard to the establishment of the Terror and the fall of the Hébertists and Dantonists, and then to dwell upon the last three months in which he stood almost alone trying to work up an effective counterbalance to the power of the majority of the great Committee. The Terror was the embodiment of the idea of Danton, that it was necessary to have resort to extreme measures to keep France united and strong at home in order to meet successfully her enemies upon the frontier. This idea was systematized by the Committee of Public Safety. With the actual organization of the Terror Robespierre had little or nothing to do; its two great engines, the revolutionary tribunal and the almost absolute power in the provinces of the representatives on mission, were in existence before he joined the Committee of Public Safety, and the laws of the maximum and of the suspects were by no means of his creation. The reason why he is almost universally regarded as its creator and the dominant spirit in the Committee is not hard to discover. Men like Lazare Carnot and Billaud-Varenne were not conspicuous speakers in the Convention, nor were they the idols of any section of the populace; but Robespierre had a fanatical following among the Jacobins and was one of the most popular orators in the Convention, on which his carefully prepared addresses often made a deep impression. His panegyrics on the system of revolutionary government and his praise of virtue led his hearers to believe that the system of the Terror, instead of being monstrous, was absolutely laudable; his pure life and admitted incorruptibility threw a lustre on the Committee of which he was a member; and his colleagues offered no opposition to his posing as their representative and reflecting some of his personal popularity upon them so long as he did not interfere with their work. Moreover, he alone never left Paris, whilst all the others, except Barère, were constantly engaged on missions to the armies, the navy and the provinces. It has been asserted that Robespierre, Couthon and Saint-Just took upon themselves the direction of "la haute politique," while the other members acted only in subordinate capacities; undoubtedly it would have suited Robespierre to have had this believed, but as a matter of fact he was in no way especially trusted in matters of supreme importance.

After this explanation it may be said at once that Robespierre was not the sole author of the overthrow of the Dantonists and the Hébertists, though he thoroughly agreed with the majority and had no desire to save them, the principles of both parties being obnoxious to him. The Hébertists were communists in the true meaning of the word. They held that each commune should be self-governing, and, while admitting

the right of a central authority to levy men and money for the purposes of the state, they believed that in purely internal matters, as well as in determining the mode in which men and money were to be raised, the local government ought to be supreme. This position of the Hébertists was of course obnoxious to the Committee, who believed that success could only be won by their retention of absolute power; and in the winter of 1794-1795 it became obvious that the Hébertist party must perish, or its opposition to the Committee would grow too formidable owing to its paramount influence in the Commune of Paris. Robespierre shared his colleagues' fear of the Hébertist opinions, and he had a personal reason for disliking that party of atheists and *sansculottes*, since he believed in the necessity of religious faith, and detested their imitation of the grossness that belongs to the lowest class of the populace. In 1792 he had indignantly thrown from him the cap of liberty which an ardent admirer had placed upon his head; he had never pandered to the depraved tastes of the mob by using their language; and to the last day of his life he wore knee-breeches and silk stockings and wore his hair powdered. His position towards the Dantonist party was of a different character. After having seen established the strong executive he had laboured for, and having moved the resolutions which finally consolidated the power of the Committee of Public Safety in September 1793, Danton retired to his country house. But to his retreat came the news of the means the Committee used to maintain their supremacy. Danton did not believe that this continuous series of sacrifices under the guillotine was necessary, especially since the danger to the country had passed away with the victories of the revolutionary army; hence he inspired Camille Desmoulins to protest against the Terror in the *Vieux Cordelier*. Where is this system of terror to end? What is the good of a tyranny comparable only to that of the Roman emperors as described by Tacitus? Such were the questions which Camille Desmoulins asked under Danton's inspiration. This "moderantism," as it was called, was as objectionable to the members of the Committee as the doctrines of the Hébertists. Both parties must be crushed. Before the blows at the leaders of those two parties were struck, Robespierre retired for a month (from 13th February to 13th March 1794) from active business in the Convention and the Committee, apparently to consider his position; but he came to the conclusion that the cessation of the Reign of Terror would mean the loss of that supremacy by which he hoped to establish the ideal of Rousseau; for Danton, he knew, was essentially a practical statesman and laughed at his ideas and especially his politico-religious projects. He must have considered too that the result of his siding with Danton would probably have been fatal to himself. The result of his deliberations was that he abandoned Danton and co-operated in the attacks of the Committee on the two parties. On the 15th of March he reappeared in the Convention; on the 19th Hébert and his friends were arrested; and on the 24th they were guillotined. On the 30th of March Danton, Camille Desmoulins and their friends were arrested, and on the 5th of April they too were guillotined.

It was not until after the execution of Danton that Robespierre began to develop a policy distinct from that of his colleagues in the Committee, an opposition which ended in his downfall. He began by using his influence over the Jacobin Club to dominate the Commune of Paris through his devoted adherents, two of whom, Fleuriot-Lescot and C. F. de Payan, were elected respectively mayor and *procureur* of the Commune. He also attempted to usurp the influence of the other members of the Committee over the armies by getting his young adherent, Saint-Just, sent on a mission to the frontier. In Paris Robespierre determined to increase the pressure of the Terror: no one should accuse him of moderantism; through the increased efficiency of the revolutionary tribunal Paris should tremble before him as the chief member of the Committee; and the Convention should pass whatever measures he might dictate. To secure his aims, Couthon, his other ally in the Committee,

proposed and carried on the 10th of June the outrageous law of 22nd Prairial, by which even the appearance of justice was taken from the tribunal, which, as no witnesses were allowed, became a simple court of condemnation. The result of this law was that between the 12th of June and the 28th of July, the day of Robespierre's death, no less than 1285 victims perished by the guillotine in Paris. It was the bloodiest and the least justifiable period of the Terror. But before this there had taken place in Robespierre's life an episode of supreme importance, as illustrating his character and his political aims: on the 7th of May he secured a decree from the Convention recognizing the existence of the Supreme Being. This worship of the Supreme Being was based upon the ideas of Rousseau in the *Social Contract*, and was opposed by Robespierre to Catholicism on the one hand and the Hébertist atheism on the other. In honour of the Supreme Being a great fête was held on the 8th of June; Robespierre, as president of the Convention, walked first and delivered his harangue, and as he looked around him he may well have believed that his position was secured and that he was at last within reach of a supreme power which should enable him to impose his belief on all France, and so ensure its happiness. The majority of the Committee found his popularity—or rather his ascendancy, for as that increased his personal popularity diminished—useful to them, since by increasing the stringency of the Terror he strengthened the position of the Committee, whilst attracting to himself, as occupying the most prominent position in it, any latent feeling of dissatisfaction at such stringency. Of the issue of a struggle between themselves and Robespierre they had little fear: they controlled the Committee of General Security through their alliance with its leaders, André Amar and Marc Guillaume Alexis Vadier; they were hopeful of obtaining a majority in the Convention; for they knew that the chief deputies on the left, or "the Mountain," were Dantonists, who burned to avenge Danton's death; while they felt sure also that the mass of the deputies of the centre, or "the Marsh," could be hounded on against Robespierre if they were to accuse him of aiming at the dictatorship and pour on him the obloquy of having increased the Terror when victory on the frontier rendered it less necessary; and they knew finally that his actual adherents, though devoted to him, were few in number. The devotion of these admirers had been further excited by the news that a half-witted girl, named Cécile Renault, had been found wandering near his house, with a knife in her possession, intending to play the part of Charlotte Corday. She was executed on the 17th of June, on the very day that Vadier raised a laugh at Robespierre's expense in the Convention by his report on the conspiracy of Catherine Théot (q.v.), a mad woman, who had asserted that Robespierre was a divinity.

Robespierre felt that he must strike his blow now or never. Yet he was not sufficiently audacious to strike at once, as Payan and Jean Baptiste Coffinhal, the ablest of his adherents, would have had him do, but retired from the Convention for some weeks, as he had done before the overthrow of the Hébertists and the Dantonists, to prepare his plan of action. This retirement seemed ominous to the majority of the Committee, and they too prepared for the struggle by communicating with the deputies of the Mountain, who were either friends of Danton or men of proved energy like Barras, Fréron and Tallien. These weeks, the last of his life, Robespierre passed very peacefully, according to his wont all through the Revolution. He continued to live with the Duplays, with whose daughter Éléonore he had fallen in love, and used to wander with her and his favourite dog, a great Danish hound, named Bruant, in the Champs Élysées during the long summer evenings. At last, on the 26th of July, Robespierre appeared, for the first time for more than four weeks, in the Convention and delivered a carefully studied harangue, which lasted for more than four hours, in which he declared that the Terror ought to be ended, that certain deputies who had acted unjustly and exceeded their powers ought to be punished, and that the Committees of

Public Safety and General Security ought to be renewed. Great was the excitement in the Convention: all wondered who were the deputies destined to be punished; all were surprised that the Terror should be imputed as a fault to the very Committee of which Robespierre had been a member. The majority of the Committee of Public Safety determined to act promptly. The Convention, moved by Robespierre's eloquence, at first passed his motions; but he was replied to by Joseph Cambon the financier, Billaud-Varenne, Amar and Vadier, and the Convention rescinded their decrees and referred Robespierre's question to their committees. On the following day, the 27th of July, or in the revolutionary calendar the 9th Thermidor, Saint-Just began to speak on behalf of the motions of Robespierre, when violent interruptions showed the temper of the Convention. Jean Lambert, Tallien, Billaud-Varenne and Vadier again attacked Robespierre; cries of "Down with the tyrant!" were raised; and, when Robespierre hesitated in his speech in answer to these attacks, the words "C'est le sang de Danton qui t'étouffe" showed what was uppermost in the minds of the Mountain. Robespierre tried in vain to gain a hearing, the excitement increased and at five in the afternoon Robespierre, Couthon and Saint-Just, with two young deputies, Augustin Robespierre (younger brother of Maximilien) and Philippe François Joseph Lebas, the only men in all the Convention who supported them, were ordered to be arrested. Yet all hope for Robespierre was not gone; he was speedily rescued from his prison, with the other deputies, by the troops of the Commune and brought to the Hôtel de Ville. There he was surrounded by his faithful adherents, led by Payan and Coffinhal. But the day was past when the Commune could overawe the Convention; for now the men of action were hostile to the Commune, and its chief was not a master of *coups d'état*. On the news of the release of Robespierre, the Convention had again met, and declared the members of the Commune and the released deputies outlawed. The national guards under the command of Barras had little difficulty in making their way to the Hôtel de Ville; Robespierre was shot in the lower jaw by a young gendarme named Meda while signing an appeal to one of the sections of Paris to take up arms for him, though the wound was afterwards believed to have been inflicted by himself; and all the released deputies were again arrested. After a night of agony, Robespierre was the next day taken before the tribunal, where his identity as an outlaw was proved, and without further trial he was executed with Couthon and Saint-Just and nineteen others of his adherents on the Place de la Révolution on the 10th Thermidor (28th July) 1794.

The character of Robespierre, when looked upon simply in the light of his actions and his authenticated speeches, and apart from the innumerable legends which have grown up about it, is not a difficult one to understand. A well-educated and accomplished young lawyer, he might have acquired a good provincial practice and lived a happy provincial life had it not been for the Revolution. Like thousands of other young Frenchmen, he had read the works of Rousseau and taken them as gospel. Just at the very time in life when this illusion had not been destroyed by the realities of life, and without the experience which might have taught the futility of idle dreams and theories, he was elected to the states-general. At Paris he was not understood till he met with his audience of fellow-disciples of Rousseau at the Jacobin Club. His fanaticism won him supporters; his singularly sweet and sympathetic voice gained him hearers; and his upright life attracted the admiration of all. As matters approached nearer and nearer to the terrible crisis, he failed, except in the two instances of the question of war and of the king's trial, to show himself a statesman, for he had not the liberal views and practical instincts which made Mirabeau and Danton great men. His admission to the Committee of Public Safety gave him power, which he hoped to use for the establishment of his favourite theories, and for the same purpose he acquiesced in and even heightened the horrors of the Reign of Terror. It is here that the fatal mistake of allowing a theorist to have power appeared:

Billaud-Varenne systematized the Terror because he believed it necessary for the safety of the country; Robespierre intensified it in order to carry out his own ideas and theories. Robespierre's private life was always respectable: he was always emphatically a gentleman and man of culture, and even a little bit of a dandy, scrupulously honest, truthful and charitable. In his habits and manner of life he was simple and laborious; he was not a man gifted with flashes of genius, but one who had to think much before he could come to a decision, and he worked hard all his life.

On the family of Robespierre see A. J. Paris in the *Mémoires* (2nd series, vol. iii.) of the Academy of Arras; the *Œuvres de Maximilien Robespierre* (3 vols., 1840), published by Laponneraye with preface by Armand Carrel, contain some of his speeches and the memoirs of Charlotte Robespierre on her brothers. The standard work on Robespierre's career is Ernest Hamel, *Histoire de Robespierre d'après des papiers de famille, les sources originales et des documents entièrement inédits* (3 vols., 1865-67). After the appearance of the first volume, the publisher refused to proceed for fear of prosecution until compelled to do so by the author. Another edition with a different title appeared in 1878. See also Ch. d'Héricault, *La Révolution de Thermidor* (2nd ed., 1878); Karl Brunemann, *Maximilian Robespierre* (Leipzig, 1880); F. A. Aulard, *Les Orateurs de l'Assemblée Constituante* (1882); M. de Lescure, "Le Roman de Robespierre," in *La Société française pendant la Terreur* (1882); E. Hamel, *La Maison de Robespierre* (1895); Hilaire Belloc, *Robespierre* (1901); and C. F. Warwick, *Robespierre and the French Revolution* (1909). Many of the books which have been written about Robespierre are most untrustworthy, and the picture of him given by Thomas Carlyle in his *French Revolution* is unjust.

ROBILANT, CARLO FELICE NICOLIS, CONTE DI (1826-1888), Italian statesman and diplomat, was a native of Turin. He entered the army, and lost his left hand at Novara, where he was aide-de-camp to Charles Albert, king of Piedmont. He fought in 1859, and reached the grade of general in the Austrian campaign of 1866, after which he served on the delimitation commission. He was chief of the Military Academy, and in 1867 was made prefect of Ravenna to suppress political disorder. He was defeated at Turin in the elections for the Chamber in 1870, and was sent in 1871 as minister plenipotentiary to Vienna, where he subsequently became ambassador. He was connected with the Prussian nobility by his mother, and he married an Austrian, a daughter of Prince Edmund Clary-Aldringen. In spite of the active share he had taken in driving Austria from Italy, he was a *persona grata* at Vienna, and his policy was steadily directed to an alliance between the two powers. This was accomplished by the secret terms of the Triple Alliance in 1882. He was recalled to Rome in 1885 to become minister for foreign affairs in the Depretis cabinet. Robilant's independent attitude as foreign minister secured greater consideration for Italy from her allies, but he did not adapt himself to the exigencies of domestic politics, and his excessive unpopularity contributed to the downfall of the ministry on the 7th of February 1887, consequent on an adverse vote on the Massawa question. Before leaving office, he completed the negotiations for the renewal of the Triple Alliance, and for its extension to cover Anglo-Italian co-operation in the Mediterranean. In the new Depretis-Crispi administration Robilant was not included. He was sent to London as ambassador in the next year, but died two months after his arrival, on the 17th of October 1888.

ROBIN HOOD, English legendary hero. The oldest mention of Robin Hood at present known occurs in the second edition—what is called the B text—of *Piers the Plowman*, the date of which is about 1377. In *passus v.* of that poem the figure of Sloth is represented as saying—

"I can nouȝte perfly my pater-noster, as the prest it synȝeth :
But I can rymes of Robyn Hood and Randolf Erle of Chestre."

He is next mentioned by Andrew of Wyntoun in his *Original Chronicle of Scotland*, written about 1420—

"Lytel Jhon and Robyne Hude
Waytþamen ware commendyd gude;
In Ynglidue and Barnysdale
Thai oysyd all this tyme [c. 1283] thare trawle";

next by Walter Bower in his additions of Fordun's *Scotichronicon* about 1450—

"Hoc in tempore [1266] de exhereditatis et bannitis surrexit et caput erexit ille famosissimus sciacrus Robertus Hode et Litill [Johanne cum eorum consplicitibus de quibus stolidum vulgus hianter in comediis et traegoidis prurienter restant faciant et super ceteras romancias, mimos, et bardanos cantitare delectantur."

Of his popularity in the latter half of the 15th and in the 16th centuries there are many signs. Just one passage must be quoted as of special importance because closely followed by R. Grafton, J. Stow and W. Camden. It is from John Mair's *Historia Majoris Britanniae tam Angliae quam Scotiae*, which appeared in 1521—

"Circa haec tempora [Ricardi Primi], ut augguror, Robertus Hudus Anglus et Parvus Joannes latrones famatissimi in memoribus latuerunt, solum opulentorum virorum bona deripientes. Nullum nisi eos invadentem vel resistentem pro suarum rerum tuitione occiderunt. Centum sagittarios ad pugnam aptissimos Robertus latrocinis aluit, quos 400 viri fortissimos invadere non audebant. *Rebus hujus Roberti gestis tota Britannia in cantibus ulitur.* Faecimam nullam opprimi permitit nec pauperum bona surripuit, verum eos ex albatum bonus sublati oppare pavit. Viri rapinam improbo, sed latronum omnium humanissimus et princeps erat."

In the Elizabethan era and afterwards mentions abound; see the works of Shakespeare, Sidney, Ben Jonson, Drayton, Warner, A. Munday, Camden, Stow, Braithwaite, Fuller, &c.

Of the ballads themselves, *Robin Hood and the Monk* is possibly as old as the reign of Edward II. (see Thomas Wright's *Essays on England in the Middle Ages*, ii. 174); *Robin Hood and the Potter* and *Robin and Gandelyn* are certainly not later than the 15th century. Most important of all is *A Lytell Geste of Robyn Hode*, which was first printed about 1510 (see A. W. Pollard's *Fifteenth Century Prose and Verse*, Westminster, 1903). This is evidently founded on older ballads; we read in *The Seconde Fytte*, ll. 176 and 177—

"He wente hym forthe full mery synygge,
As men have told in tale."

In fact, it does for the Robin Hood cycle what a few years before Sir Thomas Malory had done for the Arthurian romances—what in the 6th century B.C. Peisistratus is said to have done for the Homeric poems.

These are the facts about him and his balladry. Of conjectures there is no end. He has been represented as the last of the Saxons—as a Saxon holding out against the Norman conquerors so late as the end of the 12th century (see Augustin Thierry's *Norman Conquest*, and compare Sir Walter Scott's *Ivanhoe*). J. M. Gutch maintains that he was a follower of Simon de Montfort. The Rev. Joseph Hunter associated him with the rebel earl of Lancaster of Edward II.'s time. This scholar in a brochure published in 1852 produced evidence from the exchequer accounts and the court rolls of the manor of Wakefield showing that a "Robyn Hod" and a "Robertus Hood" were living in this reign. The series of coincidences to which he points is undoubtedly striking, but had failed to convince most critics. Professor F. J. Child dismisses his inferences as "ludicrous."

For our part, we are not disinclined to believe that the Robin Hood story has some historical basis, however fanciful and romantic the superstructure. We parallel it with the Arthurian story, and hold that, just as there was probably a real Arthur, however different from the hero of the *trouvères*, so there was a real Hood, however now enlarged and disguised by the accretions of legend. That Charlemagne and Richard I. of England became the subjects of romances does not prevent our believing in their existence; nor need Hood's mythical life deprive him of his natural one. Sloth in Langland's poem couples him, as we have seen, with Randle, earl of Chester; and no one doubts this nobleman's existence because he had "rymes" made about him. We believe him to have been the third Randle (see Bishop Percy's *Folio MS.*, ed. Hales and Furnivall, i. 260). And possibly enough Hood was contemporary with that earl, who "flourished" in the reigns of Richard I., John and Henry III. Wyntoun and Mair, as we have seen, assign him to that period. It is impossible to believe with Hunter that he lived so late as Edward II.'s reign. This would leave no time for the growth

of his myth; and his myth was, as is evident from what we have already said and quoted, full-grown in the first half of the 14th century. Whatever may have been the immediate genesis of the myth—and it may well be sought in the heartless forest laws—its vitality was assured by the English love of archery and historical repetition. In the rolls of parliament of 1437 mention is made of Piers Venables, a robber who took to the woods "like as it had been Robin Hood and his meyné." There are indications that Robin was identified or confused with Robert Locksley, a manslayer of Bradford in Hallamshire. The former is said to have been born in "Merry sweet Locksley town."

But whether he lived or not, and whenever he lived, it is certain that many mythical elements are contained in his story. Both his name and his exploits remind us of the woodland spirit Robin Goodfellow and his merry pranks. He is fond of disguising himself, and devoted to fun and practical jokes. These frolics suggest the wind. "The whole story," says Mr H. Bradley, "is ultimately derived from the great Aryan sun-myth. Robin Hood is Hod, the god of the wind, a form of Woden; Maid Marian is Morgen, the dawn-maiden; Friar Tuck is Toki, the spirit of frost and snow."

The name Robin (a French form from Rob, which is of course a short form for Robert) would serve both for "the shrewd and knavish sprite"—the German Knecht Ruprecht (see Grimm's *Teut. Myth.* p. 594, trans. Stallybrass)—and for the bandit (see "Roberdes Knaues" in the Prologue of *Piers the Plowman*, l. 44, and the note in Warton's *Hist. of Eng. Poet.* ii. 95, ed. 1840). Hood is a very usual dialectal form of wood; and in his play *Edward the First*, George Peele actually alludes to the bandit as "Robin of the Wood." Mr Gutch thus explains the origin of the name. It is still a common enough surname, of which the earlier shape is Odo (see "Houdart," &c., in Larchey's *Dict. des Noms*); notice, too, the name Hudson. But it also reminds one of the German familiar spirit Hudekin, or possibly of the German Witikind (see Wright's *Essays on the Middle Ages*, ii. 207). Mr Sidney Lee suggests that Robin was a forest elf so called because elves wore hoods (see *Dict. of National Biography*, sub. "Robin Hood"). How certain it is that the Robin Hood story attracted to it and appropriated other elements is illustrated by its subsequent history—its history after the 14th century. Thus later on we find it connected with the Morris dance; but the Morris dance was not known in England before the 16th century or late in the 15th. The Friar Tuck and Maid Marian elements have been thought to have been introduced for the purpose of these performances, which were held on May-day and were immensely popular (see Latimer's *Fruitful Sermons* (London, 1571), p. 75; also *Paston Letters*, ed. J. Gairdner, iii. 89). After 1615, the date of the pageant prepared for the mayoralty of Sir John Jolles, draper, by Anthony Munday and entitled *Metropolis Coronata*, a peer was imported into it, and the yeoman of the older version was metamorphosed into the earl of Huntingdon, for whom in the following century William Stukeley discovered a satisfactory pedigree! The earl of Huntingdon was probably a nickname for a hunter. At last, with the change of times, the myth ceased growing. Its rise and development and decay deserve a more thorough study than they have yet received.

What perhaps is its greatest interest as we first see it is its expression of the popular mind about the close of the middle ages. Robin Hood is at that time the people's ideal as Arthur is that of the upper classes. He is the ideal yeoman as Arthur is the ideal knight. He readjusts the distribution of property: he robs the rich and endows the poor. He is an earnest worshipper of the Virgin, but a bold and vigorous hater of monks and abbots. He is the great sportsman, the incomparable archer, the lover of the greenwood and of a free life, brave, adventurous, jocular, open-handed, a protector of women. Observe his instructions to Little John—

"Loke ye do no housbonde harme
That tylleth with his plough;
No more ye shall no good yeman
That walketh by grene wode shawe;

Ne no knyght ne no squyer
That wolde be a good felawe:
These bysshoppes and thysse archebyschoppes
Ye shall them bete and bynde;
The hie sheryef of Notyngham
Hym holde in your mynde."

And we are told—

"Robin loude our dere lady;
For lovede of dedely synne
Wolde he never do company harme
That only woman was ynne."

See also Drayton's *Polyolbion*, Song xxvi. The story is localized in Barnsdale and Sherwood, i.e. between Doncaster and Nottingham. In Yorkshire, Nottinghamshire and Lincolnshire a host of place-names testify to the popularity of the Robin Hood legend—Robin Hood's Bay, Robin Hood's Cave, Robin Hood's Chase, Robin Hood's Cup (a well), Robin Hood's Chair, Robin Hood's Pricks, and many more.

The best collections of Robin Hood poems are those of Ritson (8vo, 1795) and Gutch (2nd ed. 1847), and of Professor Child in the 5th volume of his invaluable *English and Scotch Popular Ballads* (Boston, 1888). See also Professor F. B. Gummere's *Old English Ballads* (Boston, 1894). The versions in the Percy Folio (edited by Hales and Furnivall, 1867, vol. i.) are unhappily mutilated; but they should be consulted, for they are all more or less unique, and that on "Robin Hoode his death" is of singular interest. The literary and artistic value of many of the Robin Hood ballads cannot be pronounced considerable, but eight of them attain the high-water mark of their class. *Robin Hood and the Monk* and *Guy of Gisborne* are perhaps the best. There is, however, real vigour and force in this fragment on the hero's death. The earliest "Garland" was printed in 1670, and in 1678 appeared a prose version which was reprinted by W. J. Thoms in his *Early English Prose Romances* (vol. ii., 1858). Mr Lee's memoir in the *Dictionary of National Biography* is extremely erudite, and two valuable articles, contributed by Sir Edward Brabrook to the *Antiquary* for June and July 1906, might be consulted. See also Stukeley, *Palaographia Britannica*, No. 1. 113; Thierry, *Conquête de l'Angleterre* (1830); and J. Hunter's *Great Hero of the Ancient Minstrelsy of England, Robin Hood* (1852). (J. W. H.; F. J. S.)

ROBIN HOOD'S BAY, a seaside resort in the Whithy parliamentary division of the North Riding of Yorkshire, England, 6½ m. S.E. of Whithy by a branch of the North-Eastern railway. The bay itself is a shallow indentation of the coast, and is fringed with high picturesque cliffs, breached in places by steep-sided narrow gullies. The old fishing village overhangs the cliffs, while the more modern watering-place is mostly built a little inland. A fine stretch of sandy shore is exposed at low tide.

ROBINIA, or LOCUST-TREE, a genus of about six species native of the United States and Mexico, belonging to the sub-order Papilionaceae of the great family Leguminosae. It was named by Linnaeus in honour of Jean Robin (1550-1629), herbalist to the king of France and his son and successor, Vespasian Robin (1579-1660) by whom the best-known species, *Robinia Pseudacacia*, was introduced into Europe, in the Jardin du Roi at Paris in 1636. This tree, the bastard acacia, or false acacia, and often called erroneously acacia, is now widely cultivated as an ornamental tree in this country and on the European continent. It grows from 30 to 60 ft. high, and bears long, graceful, compound leaves with 9 to 17 bright green oblong leaflets, and white fragrant flowers in loose pendulous racemes, recalling the laburnum in habit. There are many varieties in English gardens varying in the method of growth, the presence or absence of thorns (persistent spinose stipules) on the branches and the colour of the flower.

In the eastern United States, where it is native, it grows from 70 to 80 ft. high with a trunk 3 or 4 ft. in diameter. It is one of the most valuable timber trees of the American forest. The wood is heavy, very hard, strong, close-grained and durable, and is extensively used in shipbuilding, also for posts and other purposes where durability in contact with the ground is essential.

Like many plants of the same family, the leaves show sleep movement, folding together at night and in dull or wet weather; for this reason it is less injurious than many trees to plants growing in its shade, as the rain is able more quickly to reach the ground beneath.

ROBINS, BENJAMIN (1707-1751), English man of science and engineer, was born at Bath in 1707. His parents were Quakers in poor circumstances, and gave him very little education. Having come to London by the advice of Dr Henry Pemberton (1694-1771), who had recognized his talents, he for a time maintained himself by teaching mathematics, but soon devoted himself to engineering and the study of fortification. In particular he carried out an extensive series of experiments in gunnery, embodying his results in his famous treatise on *New Principles in Gunnery* (1742), which contains a description of his ballistic pendulum (see CHRONOGRAPH). Robins also made a number of important experiments on the resistance of the air to the motion of projectiles, and on the force of gunpowder, with computation of the velocities thereby communicated to projectiles. He compared the results of his theory with experimental determinations of the ranges of mortars and cannon, and gave practical maxims for the management of artillery. He also made observations on the flight of rockets, and wrote on the advantages of rifled barrels. His work on gunnery was translated into German by L. Euler, who added to it a critical commentary of his own. Of less interest nowadays are Robins's more purely mathematical writings, such as his *Discourse concerning the Nature and Certainty of Sir Isaac Newton's Methods of Fluxions and of Prime and Ultimate Ratios* (1735), "A Demonstration of the Eleventh Proposition of Sir Isaac Newton's Treatise of Quadratures" (*Phil. Trans.*, 1727), and similar works. Besides his scientific labours Robins took an active part in politics. He wrote pamphlets in support of the opposition to Sir Robert Walpole, and was secretary of a committee appointed by the House of Commons to inquire into the conduct of that minister. He also wrote a preface to the *Report on the Proceedings of the Board of General Officers on their Examination into the Conduct of Lieutenant-General Sir John Cope*, in which he gave an apology for the battle of Prestonpans. In 1749 he was appointed engineer-general to the East India Company, and went out to superintend the reconstruction of their forts; but his health soon failed, and he died at Fort St David on the 29th of July 1751.

His works were published in two volumes in 1761.

ROBINSON, EDWARD (1794-1863), American Biblical scholar, was born in Southington, Connecticut, on the 10th of April 1794, the son of William Robinson (1754-1825), minister of the Congregational Church of Southington. He graduated in 1816 at Hamilton College. In 1821 he came under the influence and teaching of Moses Stuart, the second edition of whose *Hebrew Grammar* he helped to prepare for the press in 1823, and through whom he was appointed in the same year instructor in Hebrew in Andover Seminary. With Stuart he translated in 1825 the first edition of Winer's *Grammar of New Testament Greek*; and alone he translated Wahl's *Clavis Philologica Novi Testamenti* (1825). In 1826-30 he studied in Germany, especially at Halle, under Gesenius, Tholuck and Rödiger, and at Berlin, under Neander. He was professor (extraordinary) of sacred literature and librarian at Andover in 1830-33, resigning because of dangerous epileptic attacks; and in 1831-35 he edited the *Biblical Repository*, which he founded and carried on very largely by his own contributions, assisted somewhat by his young German wife, Theresia Albertina Luise (1797-1869), the daughter of Professor Ludwig Heinrich von Jakob of Halle, a linguist of considerable ability, and a writer (in her early years under the pseudonym "Talvi") of essays and stories. In 1837 he accepted the professorship of Biblical literature in Union Theological Seminary, and left America for three years of study in Palestine and Germany, the fruit of which, his *Biblical Researches*, published in 1841, brought him the gold medal of the Royal Geographical Society in 1842. A second volume of *Researches* appeared in 1856. His plans to sum up his important topographical studies in a work on Biblical geography were cut short by cataract in 1861 and by his death in New York City on the 27th of January 1863. A great Biblical scholar and exegete, Robinson must

be considered the pioneer and father of Biblical geography—his *Biblical Researches*, supplemented by the *Physical Geography of the Holy Land* (1865), were based on careful personal exploration and tempered by a thoroughly critical spirit, which was possibly at times too sceptical of local tradition. Of scarcely less value in their day were his *Greek Harmony of the Gospels* (1845 and often) and his *Greek and English Lexicon of the New Testament* (1836; revised 1847 and 1850). He established in 1843 and edited for some years the *Bibliotheca Sacra* (in which the *Biblical Repository* was merged in 1852), for which he wrote until 1855.

See Henry B. Smith and Roswell D. Hitchcock, *The Life, Writings and Character of Edward Robinson* (New York, 1863); a biography of Mrs Robinson was published, with a collection of her stories, in Leipzig, in 1874.

ROBINSON, HENRY CRABB (1777-1867), English journalist and diarist, the son of a tanner, was born at Bury St Edmunds on the 13th of March 1775. In 1796 he entered the office of a solicitor in London, but two years later, having inherited a sum of money sufficient to give him a small yearly income, he started in 1800 upon a tour on the Continent, travelling chiefly in Germany and Bohemia. In 1802 he became a student at the university of Jena, where he remained until his return to England in 1805. After vain endeavours to obtain a post in the diplomatic service, he was appointed foreign correspondent for *The Times* at Altona. His letters, "From the Banks of the Elbe," were published in this newspaper during 1807, and on his return he became its foreign editor. In 1808 at the outbreak of the Peninsular War he was sent out as special war correspondent—an innovation in English journalism—for *The Times* to Spain. There he witnessed Sir John Moore's retreat at Corunna. After his return to England he read for the bar at the Middle Temple, and from 1813 to 1828 he practised as a barrister, retiring as soon as he had acquired a modest competence. He is remembered chiefly as the friend of Lamb, Coleridge, Wordsworth and Southey. He was a great conversationalist, and his breakfast parties rivalled those of Samuel Rogers. He died in London on the 5th of February 1867.

His *Diary* of 35 volumes, his *Journals* of 30 volumes, and his *Letters and Reminiscences* in 36 volumes, contain vivid pictures drawn by an acute and sympathetic observer who had exceptional opportunities of studying contemporary celebrities. They are preserved at Dr Williams's Library in Gordon Square, London. Crabb Robinson seems to have intended to edit these for publication, but except for a meagre selection edited by Thomas Sadler and entitled *The Diary, Reminiscences and Correspondence of H. Crabb Robinson* (1869), they have never been reprinted. Crabb Robinson was one of the founders of the Athenaeum Club and of University College, London.

ROBINSON, JOHN (1650-1723), English diplomatist and prelate, a son of John Robinson (d. 1651), was born at Cleasby, near Darlington, on the 7th of November 1650. Educated at Brasenose College, Oxford, he became a fellow of Oriel College, and about 1680 chaplain to the British embassy to Stockholm, and remained in Sweden for nearly thirty years. During the absence of the minister, Philip Warwick, Robinson acted as resident and as envoy extraordinary, and he was thus in Sweden during a very interesting and important period, and was performing diplomatic duties at a time when the affairs of northern Europe were attracting an unusual amount of attention. Among his adventures not the least noteworthy was his journey to Narva with Charles XII. in 1700. In 1709 Robinson returned to England, and was appointed dean of Windsor and of Wolverhampton; in 1710 he was elected bishop of Bristol, and among other ecclesiastical positions he held that of dean of the Chapel Royal. In August 1711 he became lord privy seal, this being, says Lord Stanhope, "the last time that a bishop has been called upon to fill a political office." In 1712 the bishop represented England at the important congress of Utrecht, and at first plenipotentiary he signed the treaty of Utrecht in April 1713. Just after his return to England he was chosen bishop of London in succession to Henry Compton. He died at Hampstead on the 11th of April 1723, having been a great benefactor to Oriel College. Robinson wrote an *Account of Sweden*:

together with an Extract of the History of that Kingdom. By a person of note who resided many years there (London, 1605). This was translated into French (Amsterdam, 1712), and in 1738 was published with Viscount Molesworth's *Account of Denmark in 1692*. Some of his letters are among the Strafford papers in the British Museum.

A member of the same family was Sir Frederick Philippe Robinson (1763-1852), a Virginian soldier, who fought for England during the American War of Independence. On the conclusion of peace he went to England, and in 1813 and 1814 he commanded a brigade under Wellington in Spain. Afterwards he was governor of Tobago, and he became a general in 1841. He died at Brighton on the 1st of January 1852.

ROBINSON, JOHN (1575-1625), English Nonconformist divine, was born probably in Lincolnshire or Nottinghamshire about 1575. He seems to have studied at Cambridge, and to have been influenced by William Perkins. He took orders and held a curacy in Norwich, but was attracted by Puritan doctrines, and finally associated himself with a Congregation meeting at Gainsborough (where the "John Robinson Memorial Church" bears witness to his work). In 1606 the members divided into two societies, Robinson becoming minister of the one which made its headquarters at Scrooby, a neighbouring village. The increasing hostility of the authorities towards nonconformity soon forced him and his people to think of flight, and not without difficulty, they succeeded in making their escape in detachments to Holland. Robinson settled in Amsterdam in 1608, but in the following year removed, with a large contingent, to Leiden, where he ministered to a community whose numbers gradually grew from one hundred to three hundred. In 1620 a considerable minority of these sailed for England in the "Speedwell," and ultimately crossed the Atlantic in the "Mayflower"; it was Robinson's intention to follow as soon as practicable, along with the rest of his flock, but he died before the plan could be carried out, on the 1st of March 1625.

In the early stages of the Arminian controversy he took the Calvinistic side, and even engaged in a public disputation with the famous Episcopius. He bore a high reputation even among his ecclesiastical opponents, and one of them (Robert Bailie) calls him "the most learned, polished and modest spirit that ever that sect enjoyed." He was large-minded and eminently reasonable in spirit, recognizing parish assemblies where "the pure word and discipline" prevailed as true churches of God. His sound judgment is seen in the way in which he adjusted the relations of elders and church—the most delicate practical problem of Congregationalism.

Amongst his publications may be mentioned *Justification of Separation from the Church* (1610), *Apologia Brownistarum* (1619), *A Defence of the Doctrine propounded by the Synod of Dort* (1624), and a volume of *Essays, or Observations Divine and Moral*, printed in 1625. His Works (with one exception) *A Manusmission to a Manuduction*, since published by the Massachusetts Historical Society, ser. iv., vol. i.), including a memoir, were reprinted by R. Ashton in three vols. in 1851. A summary of their contents is given in G. Punchard, *History of Congregationalism* (New York, 1867), iii. 300-344. See further CONGREGATIONALISM, and the literature there cited; also O. S. Davis, *John Robinson* (Hartford, Connecticut, 1897).

ROBINSON, SIR JOHN BEVERLEY, BART. (1701-1863), Canadian statesman and jurist, was the son of Christopher Robinson (1764-1798), one of the band known as United Empire Loyalists, who came to Canada at the conclusion of the American Revolution. He was born at Berthier, Quebec, on the 26th of July 1701, and studied under Dr John Strachan, by whom his religious and political ideas were much influenced. He served with distinction at the beginning of the war of 1812, and later in the war was appointed acting attorney-general of Upper Canada. In 1815 he visited England and read law at Lincoln's Inn.

From 1818 till 1829 he was the head of the Tory party in Upper Canada (the so-called "Family Compact"). In 1829 he became chief justice of Upper Canada, which position he held till shortly before his death on the 31st of January 1863.

Not one of his decisions was ever reversed on appeal. In 1824 and again in 1830 he strongly advocated a federal union of British North America, and in 1839 opposed in *Canada and the Canada Bill* the legislative union of the two Canadas proposed by Lord Durham. In 1854 he was created a baronet of the United Kingdom and in 1855 a D.C.L. of Oxford University. His unbending Toryism rendered him a reactionary in politics, but his bitterest opponents admitted his sincerity and patriotism.

Several of his sons rose to eminence, John Beverley Robinson (1820-1896) becoming a member of the Dominion parliament and lieutenant-governor of Ontario (1880-1887). Christopher Robinson (1828-1905) was for many years the acknowledged leader of the Canadian Bar.

His Life, by his son, Major-General C. W. Robinson, C.B. (Toronto and London, 1904), gives a very favourable picture of the fine old colonial gentleman and loyalist. For a less favourable view see J. C. Dent, *Canadian Portrait Gallery*, vol. iv. (Toronto, 1881).

ROBINSON, JOHN THOMAS ROMNEY (1792-1882), Irish astronomer and physicist, was born in Dublin on the 23rd of April 1792. He studied at Trinity College, Dublin, and obtained a fellowship in 1814; for some years he was deputy professor of natural philosophy, until in 1821 he obtained the college living of Enniskillen. In 1823 he was appointed astronomer of the Armagh observatory, with which he (from 1824) combined the living of Carrickmacross, but he always resided at the observatory, engaged in researches connected with astronomy and physics, until his death on the 28th of February 1882.

Robinson published a number of papers in scientific journals, and the Armagh catalogue of stars (*Places of 5,345 Stars observed from 1825 to 1854 at the Armagh Observatory, Dublin, 1859*), but he is best known as the inventor (1846) of the cup-anemometer for registering the velocity of the wind.

ROBINSON, SIR JOSEPH BENJAMIN (1845-), South African mine-owner, was born at Cradock, Cape Colony, in 1845. At the age of sixteen he started business as a general trader, wool-buyer and stock-breeder, but on the discovery of diamonds in South Africa in 1867 he hastened to the Vaal river district, where, by purchasing the stones from the natives and afterwards by buying diamond-bearing land, notably at Kimberley, he soon acquired a considerable fortune. He was mayor of Kimberley in 1880, and for four years was a representative of Griqualand West in the Cape parliament. On the discovery of gold in the Witwatersrand district in 1886, Robinson purchased the Langlaagte and Randfontein estates. His views as to the westerly trend of the main gold-bearing reef were entirely contrary to the bulk of South African opinion at the time, but events proved him to be correct, and the enormous appreciation in value of his various properties made him one of the richest men in South Africa. As a Rand capitalist he stood aloof from combinations with other gold-mining interests, and took no part in the Johannesburg reform movement, maintaining friendly relations with President Kruger. He claimed that it was as the result of his representations after the Jameson Raid that Kruger appointed the Industrial Commission of 1897, whose recommendations—had they been carried out—would have remedied some of the Uitlander grievances. In 1908 he was created a baronet.

ROBINSON, MARY ["Perdita" (1758-1800), English actress and author, was born in Bristol on the 27th of November 1758, the daughter of a captain of a whaler named Darby. In 1774 she was married to Thomas Robinson, a clerk in London, where her remarkable beauty brought her many attentions; and when, after two years of fashionable life, her husband was arrested for debt, she shared his imprisonment. She had been a precocious child, encouraged to write verses, and while in King's Bench prison she completed the collection published in two volumes in 1775. On her release, thanks to Garrick, she secured an engagement at Drury Lane, making a successful first appearance as Juliet in 1776. On the 3rd of December 1779 she was Perdita in Garrick's version of *The Winter's Tale*, and her beauty so captivated George, prince of Wales (afterwards

George IV.), then in his eighteenth year, that he began a correspondence with her, signing himself "Florizel." She was for about two years his mistress, but he then deserted her, even dishonouring his bond for £30,000, payable when he came of age, and left her to obtain a pension of £500 in exchange for it from Charles James Fox. Owing to the hostility of public opinion, she feared to return to the stage, but she published some more volumes of her writings. There are numerous charming portraits of "Perdita"; two in the Wallace Collection, by Reynolds and by Gainsborough, reveal "her grave, refined beauty." Hoppner, Cosway and Romney also painted her.

See *Memoirs of Mary Robinson*, "Perdita," with introduction and notes by J. F. Molloy (1894).

ROBINSON, THEODORE (1852-1896), American artist, was born at Irasburg, Vermont, in 1852. He was a pupil of J. L. Gérôme and Carolus-Duran in Paris, and worked with Claude Monet. He received the Webb Prize in 1890 for his "Winter Landscape," and the Shaw Fund in 1892 for his "In the Sun," a study of a peasant girl. He became a member (1881) of the Society of American Artists. He died in New York City on the 2nd of April 1896.

ROB ROY (1671-1734), the popular designation of a famous Highland outlaw whose prowess is the theme of one of Sir Walter Scott's novels, was by descent a Macgregor, being the younger son of Donald Macgregor of Glengyle, lieutenant-colonel in the army of James II., by his wife, a daughter of William Campbell of Gleneaves. He received the name Roy from his red hair, and latterly adopted Campbell as his surname on account of the acts proscribing the name of his clan. Though in stature not much above the middle height, he was so muscular and thickly set that few were his equals in feats of strength, while the unusual length of his arms gave him an extraordinary advantage in the use of the sword. His eyes were remarkably keen and piercing, and with his whole expression formed an appropriate complement to his powerful physical frame. He inherited a small property on the Braes of Balquhider, and at first devoted himself to the rearing of cattle. Having formed a band of armed clansmen, he obtained, after the accession of William III., a commission from James II. to levy war on all who refused to acknowledge him as king, and in the autumn of 1691 made a descent on Stirlingshire to carry off the cattle of Lord Livingstone, when, being opposed by the villagers of Kippen, he also seized the cattle from all the byres of the village. Shortly afterwards he married Helen Mary, daughter of Macgregor of Comar. On the death of Gregor Macgregor, the chief of the clan, in 1693 he managed, though not the nearest heir, to get himself acknowledged chief, obtaining control of the lands stretching from the Braes of Balquhider to the shores of Loch Lomond, and situated between the possessions of Argyll and those of Montrose. To assist in carrying on his trade as cattle-dealer he borrowed money from the 1st duke of Montrose, and, being unable to repay it, he was in 1712 evicted from his property and declared an outlaw. Taking refuge in the more inaccessible Highlands, Rob Roy from this time forward supported himself chiefly by depredations committed in the most daring manner on the duke and his tenants, all attempts to capture him being unsuccessful. During the rebellion of 1715, though nominally siding with the Pretender, he did not take an active part in the battle of Sheriffmuir except in plundering the dead on both sides. He was included in the Act of Attainder; but, having for some time enjoyed the friendship of the duke of Argyll, he obtained, on making his submission at Inveraray, a promise of protection. He now established his residence at Craigroyston, near Loch Lomond, whence for some time he levied blackmail as formerly upon Montrose, escaping by his wonderful address and activity every effort of the English garrison stationed at Inversnaid to bring him to justice. Ultimately, through the mediation of Argyll, he was reconciled to Montrose, and in 1722 he made submission to General Wade; he was carried off, and imprisoned in Newgate, and in 1727 was pardoned just as he was to be transported to Barbados. He then returned to Scotland.

According to a notice in the *Caledonian Mercury* he died at Balquhider on the 28th of December 1734. He was buried in Balquhider churchyard.

The best lives are K. Macleay, *Historical Memoirs of Rob Roy* (1818; new ed., 1881); A. H. Millar, *Story of Rob Roy* (1883). See also Sir W. Scott's introduction to the novel *Rob Roy*. An early account, *The Highland Rogue, &c.* (1723), is ascribed to Defoe.

ROBSART, the maiden name of LADY AMY DUDLEY (1532-1560), wife of Lord Robert Dudley, afterwards earl of Leicester. She was the daughter of Sir John Robsart of Norfolk, and was married to Lord Robert on the 4th of June 1550. The marriage was apparently arranged by the family for business reasons, and there is no ground for supposing that it was a love match, or that she was beautiful. Her attraction lay in her estate, which was a provision for a younger son. During the early years of the marriage her husband was entangled in the rebellion of his family against Queen Mary, and was imprisoned in the Tower. She visited him there, and acted for his interests. After his release she saw little of him. When Elizabeth became queen in 1559 Lord Robert was soon known to be her favourite, and it was believed that she would marry him if he were free. His wife never came to court and was never in his company. Stories were set about to the effect that she was suffering from cancer and would soon die. Quadra, the Spanish ambassador, reported to the king of Spain that the queen had repeated this rumour to him. In 1560 she went by her husband's directions to Cumnor Place, a house near Oxford, rented by his agent Anthony Forster or Forrester, member of parliament for Abingdon. Here she was found lying dead on the floor of the hall on the 8th of September 1560 by her servants, whom she had allowed to go to Abingdon, Fair. The circumstances of her death never have been, and now cannot be cleared up. A coroner's jury, which her husband did his best to pack and influence, attributed her end to accident. There is no evidence against Dudley, unless it be evidence that he was a most unscrupulous man, and that he was generally believed to have murdered several other persons who stood in his way.

See G. Adlard, *Amy Robsart and Leicester* (London, 1870), and W. Rye, *The Murder of Amy Robsart* (London, 1885).

ROBSON, STUART (1836-1903), American actor, whose real name was Robson Stuart, was born in Annapolis, Maryland, on the 4th of March 1836. An unintentionally humorous appearance in a serious part in 1852 showed him that his forte was comedy; and in partnership with W. H. Crane from 1877 to 1889 he was very successful as a comedian, *The Henrietta* being one of their best productions. He died on the 29th of April 1903. His wife, May Robson, also became well known as an actress.

ROBY, HENRY JOHN (1830-), English classical scholar and writer on Roman law, was born at Tamworth on the 12th of August 1830. He was educated at St John's College, Cambridge (senior classic, 1853; fellow, 1854). From 1866 to 1868 he was professor of jurisprudence at University College, London, and from 1872 to 1874 commissioner of endowed schools. From 1890 to 1895 he was member of parliament in the Liberal interest for the Eccles division of Lancashire. The book by which he is perhaps best known is his *Grammar of the Latin Language from Plautus to Suetonius*, a storehouse of illustrative quotations from Latin literature, but his most important works deal with Roman law—*Introduction to Justinian's Digest* (1884) and *Roman Private Law* (1902).

ROC, or more correctly RUKH, a fabulous bird of enormous size which carries off elephants to feed its young. The legend of the roc, familiar to every one from the *Arabian Nights*, was widely spread in the East; and in later times the home of the monster was sought in the direction of Madagascar, whence gigantic fronds of the *Raphia* palm very like a quill in form appear to have been brought under the name of roc's feathers (see Yule's *Marco Polo*, bk. iii. ch. 33, and *Academy*, 1884, No. 620). Such a feather was brought to the Great Khan, and we read also of a gigantic stump of a roc's quill being

brought to Spain by a merchant from the China seas (Abu Hamid of Spain, in Damiri, *s.v.*). The roc is hardly different from the Arabian *an'ka* (see PHOENIX); it is also identified with the Persian *simurgh*, the bird which figures in Firdausi's epic as the foster-father of the hero Zal, father of Rostam. When we go farther back into Persian antiquity we find an immortal bird, *amru*, or (in the *Mindī-khīradh*) *sinamrā*, which shakes the ripe fruit from the mythical tree that bears the seed of all useful things. *Sinamrū* and *simurgh* seem to be the same word. In Indian legend the *garuda* on which Vishnu rides is the king of birds (Benfey, *Pantschatantra*, iii. 98). In the Pahlavi translation of the Indian story as represented by the Syrian *Kātilag and Damag* (ed. Bickell, 1876), the *simurgh* takes the place of the *garuda*, while Ibn al-Mo'kaffa' (*Calila et Dimna*, ed. De Sacy, p. 126) speaks instead of the *'an'ka*. The later Syriac, curiously enough, has *behmoth*,—apparently the behemoth of Job transformed into a bird.

For a collection of legends about the roc, see Lane's *Arabian Nights*, chap. xx. notes 22, 62, and Yule, *ut supra*. Also see Borchart, *Hieros*, bk. vi. ch. xiv.; Damiri, l. 414. ii. 177 seq.; Kazwini, i. 419 seq.; Ibn Batūta, iv. 305 seq.; Spiegel, *Eran. Altertumsk.* ii. 118.

ROCAMADOUR, a village of south-western France, in the department of Lot, 36 m. N.N.E. of Cahors by road. Pop. (1906) 206. Rocamadour, a famous place of pilgrimage, is most strikingly situated. Its buildings rise in stages up the side of a cliff on the right bank of the Alzou, which here runs between rocky walls 400 ft. in height. Flights of steps ascend from the lower town to the churches—a group of massive buildings half-way up the cliff. The chief of them is the church of Notre-Dame (1479), containing the wooden figure of the Madonna reputed to have been carved by St Amadour. The church opens on to a terrace called the Plateau of St Michel, where there is a broken sword said to be a fragment of "Durandal," once wielded by the hero Roland. The interior walls of the church of St Sauveur are covered with paintings and inscriptions recalling the pilgrimages of celebrated persons. The subterranean church of St Amadour (1166) extends beneath St Sauveur and contains relics of the saint. On the summit of the cliff stands the château built in the middle ages to defend the sanctuaries.

Rocamadour owes its origin to St Amadour or Amateur, who, according to tradition, chose the place as a hermitage for his devotions to the Virgin Mary. The saint is identified with Zacchaeus the publican and disciple of Jesus, who is said to have journeyed to Gaul to preach the gospel. The renown of Rocamadour as a place of pilgrimage dates from the early middle ages.

ROCAMBOLE, *Allium Scorodoprasum*, a hardy bulbous perennial occurring in a wild state in sandy pastures and waste places throughout Europe, but not common in the south; in Britain it is rare, and found in the north of England and the south of Scotland. Its cultivation does not appear to be of ancient date; it is not mentioned by Greek and Roman authors, and there are only a small number of original common names among ancient peoples (A. de Candolle, *Origin of Cultivated Plants*, p. 72). The plant is grown for its bulbs, which are smaller and milder than those of garlic, and consist of several cloves chiefly produced at the roots. The cloves are planted about the end of February or in March, and treated like garlic or shallot. When mature, the bulbs are taken up, dried and stored for use.

ROCH, ST (Lat. Rochus; Ital. Rocco; Span. Roque; Fr. Roch) (d. 1327), a confessor whose death is commemorated on the 16th of August; he is specially invoked against the plague. According to his *Acta*, he was born at Montpellier, France, about 1295. He early began to manifest strict asceticism and great devoutness, and on the death of his parents in his twentieth year he gave all his substance to the poor. Coming to Italy during an epidemic of plague, he was very diligent in tending the sick in the public hospitals at Aquapendente, Cesena and Rome, and effected many miraculous cures by

prayer and simple contact. After similar ministries at Piacenza he himself fell ill. He was expelled from the town, and withdrew into the forest, where he would have perished had not a dog belonging to a nobleman named Gothardus supplied him with bread. On his return to Montpellier he was arrested as a spy and thrown into prison, where he died on the 16th of August 1327, having previously obtained from God this favour—that all plague-stricken persons invoking him should be healed. His cult spread through Spain, France, Germany, Belgium and Italy. A magnificent temple was raised to him at Venice, where his body is believed to lie, and numerous brotherhoods have been instituted in his honour. He is usually represented in the garb of a pilgrim, with a wound in his thigh, and with a dog near him carrying a loaf in his mouth.

See *Acta sanctorum*, August, iii. 380-415; Charles Cahier *Les Caractéristiques des saints* (Paris, 1867), pp. 215-217. (H. DE)

ROCHAMBEAU, JEAN BAPTISTE DONATIE DE VIMEUR, COMTE DE (1725-1807), French soldier, was born at Vendôme (Loir-et-Cher) on the 1st of July 1725. He was originally destined for the church and was brought up at the Jesuit college at Blois, but after the death of his elder brother he entered a cavalry regiment, served in Bohemia and Bavaria and on the Rhine, and in 1747 had attained the rank of colonel. He took part in the siege of Maestricht in 1748, became governor of Vendôme in 1749, and after distinguishing himself in 1756 in the Minorca expedition was promoted brigadier of infantry. In 1757 and 1758 he fought in Germany, notably at Crefeld, received several wounds in the battle of Clostercamp (1760), was appointed *maréchal de camp* in 1761 and inspector of cavalry and was frequently consulted by the ministers on technical points. In 1780 he was sent, with the rank of lieutenant-general, in command of 6000 French troops to help the American colonists under Washington against the English. He landed at Newport, Rhode Island, on the 10th of July, but was held here inactive for a year, owing to his reluctance to abandon the French fleet, which was blockaded by the British in Narragansett Bay. At last, in July 1781, Rochambeau's force was able to leave Rhode Island and, marching across Connecticut, joined Washington on the Hudson. Then followed the celebrated march of the combined forces to Yorktown, where on the 22nd of September they formed a junction with the troops of Lafayette; as the result Cornwallis was forced to surrender on the 19th of October. Throughout, Rochambeau had displayed an admirable spirit, placing himself entirely under Washington's command and handling his troops as part of the American army. In recognition of his services, Congress voted him and his troops the thanks of the nation and presented him with two cannon taken from the English. These guns, which Rochambeau took back to Vendôme, were requisitioned in 1792. On his return to France he was loaded with favours by Louis XVI. and was made governor of Picardy. During the Revolution he commanded the Army of the North in 1790, but resigned in 1792. He was arrested during the Terror, and narrowly escaped the guillotine. He was subsequently pensioned by Bonaparte, and died at Thoré (Loir-et-Cher) on the 10th of May 1807.

A statue of Rochambeau by Ferdinand Hamar, the gift of France to the United States, was unveiled in Lafayette Square, Washington, by President Roosevelt on the 24th of May 1902. The ceremony was made the occasion of a great demonstration of friendship between the two nations. France was represented by her ambassador, M. Cambon, Admiral Fournier and General Brugère, a detachment of sailors and marines from the warship "Gaulois" being present. Representatives of the Lafayette and Rochambeau families also attended. Of the many speeches perhaps the most striking was that of Senator Henry C. Lodge, who, curiously enough in the circumstances, prefaced his eloquent appreciation of the services rendered to the American cause by France by a brilliant sketch of the way in which the French had been driven out of North America by England and her colonists combined. General Brugère, in his speech, quoted Rochambeau's words, uttered in 1781: "*Entre vous,*

entre nous, à la vie, à la mort." A "Rochambeau fête" was held simultaneously in Paris.

The *Mémoires militaires, historiques et politiques, de Rochambeau* were published by Luce de Lancival in 1809. Of the first volume a part, translated into English by M. W. E. Wright, was published in 1838 under the title of *Mémoires of the Marshal Count de R. relative to the War of Independence in the United States*. Rochambeau's correspondence during the American campaign is published in H. Doniol, *Hist. de la participation de la France à l'établissement des États Unis d'Amérique*, vol. v. (Paris, 1892). See Duchesne, "Autour de Rochambeau" in the *Revue des Facultés catholiques de Fougères* (1898-1900); E. Gachot, "Rochambeau" in the *Nouvelle Revue* (1902); H. de Ganniers, "La Dernière Campagne du maréchal de Rochambeau" in the *Revue des questions historiques* (1901).

ROCHDALE, a municipal, county and parliamentary borough of Lancashire, England, on the river Roch, 10½ m. N.N.E. from Manchester and 196 m. N.W. by N. from London, on the Lancashire & Yorkshire railway. Pop. (1891) 76,161; (1901) 83,114. By means of the Rochdale canal and connexions it has water communications in every direction. The site rises sharply from the Roch, near its confluence with the Spodden, and from the high-lying public park of Rochdale fine views of the picturesque neighbourhood are obtained. Several interesting old houses remain in the vicinity of the town. The parish church of St Chad is built on the site of a church erected in the 12th century, but itself retains no portion earlier than the Perpendicular period. In the churchyard is buried John Collier (1708-1786), a local author, artist and caricaturist, who was among the first to recognize and utilize in writing the humour of the Lancashire dialect, and attained considerable fame under the pseudonym of Tim Bobbin. The town hall is an extensive and elaborate structure in the Decorated style, with a tower. Of educational charities the principal is the Archbishop Parker free grammar school, founded in 1565. There are also technical and art schools; and a large Roman Catholic orphanage. Among other public institutions are the public library, the infirmary, the literary and scientific society and the art society. Rochdale was the birthplace of the co-operative movement. The Equitable Pioneers Society (1844) numbers over 11,000 members, with a capital of over £350,000. A handsome co-operative store, belonging to the Rochdale Provident Co-operative Society, was opened in 1900. A statue of John Bright (1891) recalls the connexion of the statesman and his family with Rochdale. The staple manufactures are those of woollens and cottons. There are, besides, foundries, iron-works and machine-factories. Coal and stone are obtained extensively in the neighbourhood. Frequent cattle and horse fairs are held. Rochdale was incorporated in 1856, and includes several townships. The corporation consists of a mayor, 10 aldermen and 30 councillors. The county borough was created in 1888. The parliamentary borough, which has returned one member since 1832, falls between the Middleton and Heywood divisions of the county. Area of municipal borough, 6446 acres.

Rochdale (Recedham, Rachedam, Rachedal) takes its name from the river on which it stands. A Roman road passed the site, and a Saxon castle stood in Castleton, one of the component parts of the town. In Edward the Confessor's reign most of the land was held by Gamel the Thane, but after the Conquest the manor probably came into the hands of Roger de Poitou, from whom it passed to the Lacys and like their other lands became merged in the duchy of Lancaster. From 1462 to 1625 the crown seems to have leased it to the Byron family. In 1625 Charles I. conveyed the manor in trust for the earl of Holderness, and in 1638 it was sold to Sir John Byron, afterwards Baron Byron of Rochdale, whose descendants held it till 1823 when it was sold to the Deardens. Manor courts are still held periodically. Henry III. in 1240-41 granted by charter to Edmund de Lacy the right to hold a weekly market on Wednesday and an annual fair on the feast of SS Simon and Jude (28th October). Early in George III.'s reign the market day was changed to Monday. Two of the early industries, cutlery and hat-making, date from about the middle of the 16th century. The woollen

industry is generally, but erroneously, said to have been introduced by Flemish immigrants in Edward III.'s reign; but, with the cognate trades of dyeing and fulling, its importance only dates from the early part of the 17th century. It was not till 1795 that a cotton mill was built here, and in the latter half of the 18th century the town was famed for its woollen, not its cotton manufactures.

See H. Fishwick, *History of the Parish of Rochdale* (1889).

ROCHE, SIR BOYLE, BART. (1743-1807), Irish soldier and politician, famous for his "bulls," came of a branch of the family of the Viscounts Fermoy. He served in the American War, and sat in the Irish parliament from 1777 onwards, being created a baronet in 1782 for his loyalty to the government. He supported the Union, and one of his recorded "bulls"—many, however, being only fastened on him—was his declaration that he would have "the two sisters" (England and Ireland) "embrace like one brother." Sir Boyle Roche was a characteristically witty and genial Irishman, and was master of the ceremonies at Dublin Castle.

ROCHFORD, HENRI, MARQUIS DE ROCHFORD-LUCAY (1830-), French politician, was born in Paris on the 30th of January 1830. His father was a Legitimist noble who as "Edmond Rochefort" was well known as a writer of vaudevilles; his mother's views were republican. After experience as a medical student, a clerk at the Hôtel de Ville, a playwright and a journalist, he joined the staff of the *Figaro* in 1863; but a series of his articles, afterwards published as *Les Français de la Décadence* (3 vols., 1866-68), brought the paper into collision with the authorities and caused the termination of his engagement. In collaboration with different dramatists he had meanwhile written a long series of successful vaudevilles, which began with the *Monsieur bien mis* at the Folies Dramatiques in 1856. On leaving the *Figaro* Rochefort determined to start a paper of his own, *La Lanterne*. The paper was seized on its eleventh appearance, and in August 1868 Rochefort was fined 10,000 francs, with a year's imprisonment. He then published his paper in Brussels, whence it was smuggled into France. Printed in French, English, Spanish, Italian and German, it went the round of Europe. After a second prosecution he fled to Belgium. A series of duels, of which the most famous was one fought with Paul de Cassagnac a propos of an article on Joan of Arc, kept Rochefort in the public eye. In 1869, after two unsuccessful candidatures, he was returned to the Chamber of Deputies by the first circonscription of Paris. He was arrested on the frontier, only to be almost immediately released, and forthwith took his seat. He renewed his onslaught on the empire, starting a new paper, the *Marseillaise*, as the organ of political meetings arranged by himself at La Villette. The staff was appointed on the votes of the members, and included Victor Noir and Pascal Grousset. The violent articles in this paper led to the duel which resulted in Victor Noir's death at the hands of Prince Pierre Bonaparte. The paper was seized, and Rochefort and Grousset were sent to prison for six months. The revolution of September was the signal for his release. He became a member of the government of National Defence, but this short association with the forces of law and order was soon broken on account of his openly expressed sympathy with the Communards. On the 11th of May 1871 he fled in disguise from Paris. A week earlier he had resigned with a handful of other deputies from the National Assembly rather than countenance the dismemberment of France. Arrested at Meaux by the Versailles government, he was detained for some time in prison with a nervous illness before he was condemned under military law to imprisonment for life. In spite of Victor Hugo's efforts on his behalf he was transported to New Caledonia. In 1874 he escaped on board an American vessel to San Francisco. He lived in London and Geneva until the general amnesty permitted his return to France in 1880. In Geneva he resumed the publication of *La Lanterne*, and in the Parisian papers articles constantly appeared from his pen. When at length in 1880 the general amnesty

permitted his return to Paris he founded *L'Intransigeant* in the Radical and Socialist interest. For a short time in 1885-86 he sat in the Chamber of Deputies, but found a great opportunity next year for his talent for inflaming public opinion in the Boulangist agitation. He was condemned to detention in a fortress in August 1889 at the same time as General Boulanger, whom he had followed into exile. He continued his polemic from London, and after the suicide of General Boulanger he attacked M. Constans, minister of the interior in the Freycinet cabinet, with the utmost violence, in a series of articles which led to an interpellation in the chamber in circumstances of wild excitement and disorder. The Panama scandals furnished him with another occasion, and he created something of a sensation by a statement in the *Figaro* that he had met M. Clemenceau at the table of the financier Cornélius Herz. In 1895 he returned to Paris, two years before the Dreyfus affair supplied him with another *point d'appui*. He became a leader of the anti-Dreyfusards, and had a principal share in the organization of the press campaign. Subsequently he was editor of *La Patrie*.

Besides his plays and articles in the journals he published several separate works, among them being: *Les Petits Mystères de l'Hôtel des Ventes* (1862), a collection of his art criticisms; *Les Dépravés* (Geneva, 1882); *Les Naufrageurs* (1876); *L'Évadé* (1883); *Napoléon dernier* (3 vols., 1884); and *Les Aventures de ma vie* (5 vols., 1896).

ROCHEFORT, a small town of Belgium, situated on the Lomme, a tributary of the Lesse, in the S.E. of the province of Namur close to the Ardennes. Resident pop. (1904) 3068, which in July and August is doubled. It is of ancient origin, its position at the point where the route to St Hubert crossed that from Liège to Bouillon having made it at all times a place of some importance. The ruins of the old castle, which gave the place its name and a title to a long line of counts who had the right of coining their own money, still exist. This castle underwent many sieges and suffered much in the earlier wars, especially at the hands of Marshal de Chatillon in 1636. Rochefort is noted for its healthiness, and is a favourite place of residence. It also attracts every summer a large number of visitors and tourists, who visit it on account of the remarkable grottoes in its neighbourhood. One of these is situated in the town itself and is known by its name. This grotto contains six halls or chambers, the largest of which is called the Sabbat, and is remarkable for its great height. But the most famous are the grottoes of Han, situated three miles from Rochefort at Han sur Lesse. Here the river Lesse passes by a subterranean and undiscovered passage under the hill called Boème or Boine. The endeavour to trace the course of the river led to the discovery of the grottoes, which consist of fifteen separate halls, connected by passages more or less short and emerging on the river in a dark and extensive cavern forming a sort of side creek or bay. Except in flood-time, when the exit has to be used, the entrance is near the point where the river disappears at what is called the gap or hole of Belvaux, and the exit is made by boat from the cavern last described, which leads out to the open river. A beautiful effect is afforded by the passage from the complete darkness of this cavern into the light. The finest stalactites are in the three halls called the Mysterieuses, the Vigneron and the Draperies. In the last-named is "the tomb," which looks as if chiselled out of white marble. The central hall—called the Salle d'Armes—is immense, and one of the river channels flows through it. Electric light has been introduced. Near Rochefort are the famous red marble quarries of St Remy, and the old Cistercian abbey of that name is now a Trappist seminary.

ROCHEFORT, a town of western France, capital of an arrondissement in the department of Charente-Inférieure, 20 m. S.S.E. of La Rochelle on the State railway from Nantes to Bordeaux. Pop. (1906) town, 31,433; commune, 36,694. It is situated on the right bank of the Charente, 9 m. from the Atlantic, and is built partly on the side of a rocky hill and partly on an old marshland. The town is laid out with great

regularity, the streets being wide and straight and centring round the Place Colbert, in the middle of which is a monumental fountain of the 18th century. The public institutions of Rochefort comprise the sub-prefecture, tribunals of first instance and of commerce, a board of trade arbitration, a chamber of commerce, a lycée for boys, a college for girls and schools of drawing and architecture. The fortifications are slight. Below Rochefort the Charente is crossed by a *pont transbordeur*, the carrier of which is suspended at a height which admits of the tallest ships passing underneath at any time. There are both a naval and a commercial harbour. The former has the advantage of deep anchorage well protected by batteries at the mouth of the river, and the roadstead is perfectly safe. The windings of the channel, however, between Rochefort and the sea, and the bar at the entrance render navigation dangerous. Rochefort is capital of the fourth maritime arrondissement, which stretches from the bay of Bourgneuf to the coast of Spain. The naval harbour and arsenal, separated from the town by a line of fortifications with three gates, contain large covered building yards, repairing docks and extensive timber basins on both banks of the river. The arsenal has also a ropewalk dating from 1668, a school of navigation and pilotage, the offices of the maritime prefecture, the navy commissariat, a park of artillery and various boards of direction connected with the navy. Other government establishments at Rochefort are barracks for infantry, artillery and marines, and the naval hospital and school of medicine. In the grounds of this last institution is an artesian well, sunk in 1826-1866 to a depth of 2800 ft., and yielding water with a temperature of 100° F. The commercial harbour, higher up the river than the naval harbour, has two small basins, a third basin with an area of 15 acres and a depth at neap-tide of 25 ft., at spring-tide of 20½ ft., and a dry dock 110 yds. long. Besides shipbuilding, which forms the staple industry, flour- and saw-milling, sail-cloth, &c., are among the local manufactures. At the ports of Rochefort and Tonnyay-Charente (4 m. higher up) there entered, in 1905, 265 vessels (166 British), with a tonnage of 192,537.

The lordship of Rochefort, held by powerful nobles as early as the 11th century, was united to the French Crown by Philip the Fair early in the 14th century; but it was alternately seized in the course of the Hundred Years' War by the English and the French, and in the Wars of Religion by the Catholics and Protestants. Colbert having in 1665 chosen Rochefort as the seat of a repairing port between Brest and the Gironde, the town rapidly increased in importance; by 1674 it had 20,000 inhabitants; and when the Dutch admiral Cornelius Tromp appeared at the mouth of the river with seventy-two vessels for the purpose of destroying the new arsenal, he found the approaches so well defended that he gave up his enterprise. It was at Rochefort that the naval school, afterwards transferred to Brest, was originally founded. The town continued to flourish in the later part of the 17th century. In 1690 and in 1703 the English made unsuccessful attempts to destroy it. Its fleet, under the command of Admiral la Galissonnière, a native of the place, defeated Admiral Byng in 1755 and did good service in the wars of the republic. But the destruction of the French fleet by the English in 1809 in the roadstead of Ile d'Aix, the preference accorded to the harbours of Brest and Toulon and the unhealthiness of its climate seriously interfered with the prosperity of the place. The convict establishment, founded at Rochefort in 1777, was suppressed in 1852.

ROCHESTER, JOHN WILMOT, 2ND EARL OF (1647-1680), English poet and wit, was the son of Henry Wilmot, 1st earl. The family was descended from Edward Wilmot of Witney, Oxfordshire, whose son Charles (c. 1570-c. 1644), having served with distinction in Ireland during the rebellion at the beginning of the 17th century, was president of Connaught from 1616 until his death. In 1621 he had been created an Irish peer as Viscount Wilmot of Athlone, and he was succeeded by his only surviving son, Henry (c. 1612-1658). Having fought against the Scots at Newburn and been imprisoned and expelled from

the House of Commons for plotting in the interests of the king in 1641, Henry Wilmot served Charles I. well during the Civil War, being responsible for the defeats of Sir William Waller at Roundway Down in July 1643 and at Cropredy Bridge in June 1644. In 1643 he was created Baron Wilmot of Aderbury. Wilmot was on bad terms with some of the king's friends and advisers, including Prince Rupert, and in 1644 he is reported to have said that Charles was afraid of peace and to have advised his supersession by his son, the prince of Wales. Consequently he was deprived of his command, and after a short imprisonment was allowed to cross over to France. He was greatly trusted by Charles II., whose defeat at Worcester and subsequent wanderings he shared, and during this king's exile he was one of his principal advisers, being created by him earl of Rochester in 1652. In the interests of Charles he visited the emperor Ferdinand III., the duke of Lorraine, and the elector of Brandenburg, and in March 1655 he was in England, where he led a feeble attempt at a rising on Marston Moor, near York; on its failure he fled the country.

Born at Ditchley in Oxfordshire on the 10th of April 1647, John Wilmot, who succeeded his father as 2nd earl in 1658, was educated at Wadham College, Oxford, and in 1661, although he was only fourteen years of age, received the degree of M.A. On leaving Oxford he travelled in France and Italy with a tutor who encouraged his love of literature, and moreover advocated principles of temperance which, however, bore little fruit. He returned in 1664, and at once made his way to Charles II.'s court, where his youth, good looks and wit assured him of a welcome. In 1665 he joined the fleet serving against the Dutch as a volunteer, and in the following year distinguished himself by carrying a message in an open boat under fire. This reputation for courage was afterwards lost in private quarrels in which he seems to have shirked danger. He became gentleman of the bedchamber to Charles II., and was the confidant of his various exploits. According to Anthony Hamilton, banishment from court for lampooning the king or his mistresses was with Rochester an almost annual occurrence, but his disgrace was never of long duration. Charles seems to have found his company too congenial to be long dispensed with, and Pepys says that all serious men were disgusted by the complaisance with which he passed over Rochester's insolence (*Diary*, 17th Feb. 1666). In order to restore his rapidly vanishing fortune he became a suitor to Elizabeth Malet. In spite of the king's support of Rochester's suit, Miss Malet refused to marry the earl, who thereupon had her seized (1665) from her uncle's coach. Rochester was pursued, and Charles, who was very angry, sent him to the Tower. Miss Malet, however, married him in 1667.

Not content with making or unmaking the reputation of the maids of honour and the courtiers by his squibs and songs, Rochester aspired to be a patron of poetry and an arbiter of taste, but he was vain and capricious, tolerating no rivals in his capacity of patron. Dryden dedicated to him his *Marriage à la-Mode* (1672) in a preface full of effusive flattery, at the close of which, however, occurs a passage that may be taken to indicate that he already had misgivings. "Your lordship has but another step to make," he says, "and from the patron of wit, you may become its tyrant; and oppress our little reputations with more ease than you now protect them." Dryden had another patron in Lord Mulgrave (afterwards duke of Buckingham and Normanby), to whom he dedicated (1675) *Aurengzeb*. Mulgrave had engaged in a duel with Rochester, who had refused to fight at the last minute on the ground of ill-health. Mulgrave allowed this story to spread, and Rochester, who apparently thought him too dangerous an opponent, revenged himself on Dryden as Mulgrave's protégé by setting up as his rivals, first Elkanah Settle, and then John Crowne. By his influence Settle's *Emperor of Morocco* was played at Whitehall, and Crowne was employed, in direct infringement of Dryden's province as laureate, to write a masque for the court. Both these poets were discarded in turn for Nathaniel Lee and Thomas Otway. In 1679 Mulgrave began to circulate his *Essay on Satire* in which Rochester was singled out for severe criticism.

Rochester chose to pretend that this was Dryden's work, not Mulgrave's, and by his orders a band of roughs set on the poet in Rose Alley, Covent Garden, and beat him. He obviously felt no shame for this infamous attack, for in his "Imitation of the First Satire of Juvenal" he says, "Who'd be a wit in Dryden's cudgelled skin?" His health was already undermined, and in the spring of 1680 he retired to High Lodge, Woodstock Park. He began to show signs of a more serious temper, and at his own request was visited (July 20th to July 24th) by Bishop Burnet, who attested the sincerity of his repentance. He died, however, two days after the bishop left him. When his son Charles, the 3rd earl, died on the 12th of November 1681, his titles became extinct.

As a poet Rochester was a follower of Abraham Cowley and of Boileau, to both of whom he was considerably indebted. His love lyrics are often happy, but his real vigour and ability is best shown in his critical poems and satires. The political satires are notable for their fierce exposure of Charles II.'s weakness, his ingratitude, and the slavery in which he was held by his mistresses. They show that Rochester had it in him to be a very different man from the criticizing courtier and the "very profane wit" who figures in contemporary memoirs.

BIBLIOGRAPHY.—*Poems on Several Occasions by the Right Honourable the Earl of Rochester* . . . (Antwerp, 1680) was really printed in London. Other issues, slightly varying in title and contents, appeared in 1685, 1691 and 1696. *Valentinian, A Tragedy*, adapted from Beaumont and Fletcher, was printed in 1685; a scurrilous attack on Charles II. in the shape of a play in heroic couplets, *Sodom*, was printed in 1684, and is supposed, in spite of Rochester's denial, to have been chiefly his work. No copy of this is known, but there are two MSS. extant. The completest edition of his works is *The Poetical Works of the Earl of Rochester* (1731–32). Expurgated collections are to be found in Johnson's, Anderson's and Chalmers's editions of the *British Poets*. His *Familiar Letters* were printed in 1686, 1697 and 1699. His Political Satires are available, with those of Sir John Denham and Andrew Marvell, in the *Bibliotheca Curiosa* (Some Political Satires of the Seventeenth Century, vol. i., Edinburgh, 1885). Contemporary accounts of Rochester are to be found in the memoir by Saint-Evremond prefixed to an edition of 1709, in Hamilton's *Mémoires du Comte de Gramont*, in the funeral sermon preached by Robert Parsons (1680), and in Bishop Burnet's *Some Passages in the Life and Death of John, Earl of Rochester* (1680), reprinted in Bishop Wordsworth's *Ecclesiastical Biography* (vol. vi.).

ROCHESTER, LAWRENCE HYDE, EARL OF (1641–1711), English statesman, second son of Edward Hyde, earl of Clarendon, was born in March 1641. After the restoration of Charles II. he sat as member of parliament, first for Newport in Cornwall and afterwards for the university of Oxford, from 1660 to 1679. In 1661 he was sent on a complimentary embassy to Louis XIV. of France, while he held the court post of master of the robes from 1662 to 1675. In 1665 he married Henrietta (d. 1687), daughter of Richard Boyle, earl of Burlington and Cork. When his father was impeached in 1667, Lawrence joined with his elder brother, Henry, in defending him in parliament, but the fall of Clarendon did not injuriously affect the fortunes of his sons. They were united with the royal family through the marriage of their sister, Anne, with the duke of York, afterwards James II., and were both able and zealous royalists. In 1676 Lawrence Hyde was sent as ambassador to Poland; he then travelled to Vienna, whence he proceeded to Nijmegen to take part in the peace congress as one of the English representatives. Having returned to England, he entered the new parliament, which met early in 1679, as member for Wootton Bassett; in November 1679 he was appointed first lord of the treasury, and for a few years he was the principal adviser of Charles II. In April 1681 he was created Viscount Hyde of Kenilworth, and in November following earl of Rochester. He was compelled to join in arranging the treaty of 1681, by which Louis XIV. agreed to pay a subsidy to Charles, at the very moment when he was imploring William, prince of Orange, to save Europe from the ambitions of the French monarch. The conflict between his wishes and his interests may have tended to sour a temper never very equable; at all events the earl made himself so unpleasant to his colleagues that in August 1684 he was removed from the treasury to the

more dignified, but less influential, post of president of the council, a process which his enemy Halifax described as being "kicked upstairs." Although appointed lord lieutenant of Ireland, Rochester did not take up this position; he was still president of the council when James II. became king in February 1685, and he was at once appointed to the important office of lord treasurer. But in spite of their family relationship and their long friendship, James and his treasurer did not agree. The king wished to surround himself with Roman Catholic advisers; the earl, on the other hand, looked with alarm on his master's leanings to that form of faith. In January 1687 he was removed from his office of treasurer, being solaced with a pension of £4000 a year and a gift of Irish lands.

After the revolution of 1688 Rochester appeared as a leader of the Tories, and he opposed the election of William and Mary as king and queen, raising his voice for the establishment of a regency on behalf of the exiled James. But he soon reconciled himself to the new order, perhaps because he could not retain his pension unless he took the oaths of allegiance. After this he was quickly in the royal favour and again a member of the privy council. He advised the queen in ecclesiastical matters, and returned to his former position as the leader of the High Church party. From December 1700 until February 1703 he was lord lieutenant of Ireland, although he did not spend much time in that country, and the concluding years of his public life were mainly passed in championing the interests of the Church. In 1710 he was again made lord president of the council. He died on the 2nd of May 1711, and was succeeded by his only son, Henry (1672-1758), who in 1724 inherited the earldom of Clarendon. When Henry died without issue on the 10th of December 1758 all his titles became extinct.

Lawrence Hyde had some learning and a share of his father's literary genius. The main employment of his old age was the preparation for the press of his father's *History of the Rebellion*, to which he wrote a preface. Like most of the men of his time, he drank deeply, and he was of an arrogant disposition and had a violent temper. In Dryden's satire of *Absalom and Achitophel* he is "Hushai," the friend of David in distress.

The correspondence of Rochester with his brother the earl of Clarendon, together with other letters written by him, was published with notes by S. W. Singer (1828). Other authorities are G. Burnet, *History of his Own Time*, edited by O. A. Ayry (Oxford, 1897-1900); John Evelyn, *Diary*, edited by H. B. Wheatley (1879); and Macaulay, *History of England*.

ROCHESTER, a city, municipal and parliamentary borough of Kent, England, on the river Medway, 33 m. E.S.E. of London by the South-Eastern & Chatham railway, contiguous to Chatham and Strood. Pop. (1901) 30,590. Chatham lies east of the city on the same bank of the river, while Strood is opposite, on the left bank, being connected with Rochester by a railway bridge and by an iron swing bridge, the latter occupying the site of a bridge which spanned the Medway before the Conquest. The cathedral church of St Andrew was originally founded by Augustine in 604, for whom Æthelbert built the church. It was partially destroyed by the Danes, but was rebuilt, with a long choir and square east end, by Bishop Gundulph, the second Norman bishop (1077-1108). Gundulph at the same time (1089) established an order of Benedictine monks here. Bishop Ernulf (1115-24), who as prior of Canterbury and abbot of Peterborough had already distinguished himself as a builder, completed and also renovated the church, lengthening it by two bays eastward; the old chapter-house remains. The beautiful Norman west front was built about 1125-30, and in 1130 the new cathedral was consecrated. About 1201 a baker, William of Perth, while on a pilgrimage was murdered near Rochester by robbers. He was buried in the cathedral and was canonized, his shrine becoming a famous resort of pilgrims, who brought much wealth to the monastery. The edifice suffered from fire in 1137 and in 1171. During the whole of the 13th and a part of the 14th century a gradual rebuilding, or sometimes mere recasing, of the church was effected from east to west. The work included an extended choir by William

de Hoo (1227), enlargement of the main transepts, the building of piers for a central tower, and treatment of the nave to the third bay. About 1352 a low central tower was built, to which a spire was added in the next century. Towards the end of the 15th century St Mary's chapel was added, the Norman clerestory was rebuilt, and a great west window inserted. Though a comparatively small building, being only 306 ft. in length and 65 ft. in breadth at the nave, the cathedral is of much architectural interest, and exhibits a variety of styles from Norman to Perpendicular. The rich and varied decoration of the Norman nave (especially the triforium) is very noteworthy, as is also the chapter-house doorway, a fine example of Decorated work. The Early English portion of the building is less successful. The ruins of Gundulph's Tower stand detached from and are earlier than the church; this tower was built by Bishop Gundulph probably as a defensive work for the eastern boundary of the city. The crypt beneath the choir is of special interest, showing early Norman work in the western part. The remainder is Early English, and there are traces of mural painting. The cathedral contains many interesting monuments, including a plain slab assigned to Gundulph, and several tombs of bishops of the 13th century, among them that of Bishop Walter de Merton, founder of Merton College, Oxford (d. 1277). The library attached to the modern chapter-house contains, among various valuable relics, the *Textus Roffensis*, being records of the cathedral compiled in the time of Bishop Ernulf. The old episcopal palace is partly converted into dwelling-houses. Portions of the wall of the priory dormitory and the refectory doorway may also still be seen. Among various restorations of the cathedral in the 19th century the earliest was that of Lewis Cottingham (1825-27), who erected a Decorated central tower unsuited to the general character of the building. Bishop Hamo de Hythe (1310-52) had erected a tower with short spire of timber and lead, and of this the general design is reproduced in the present tower and spire from designs of Mr C. H. Fowler, begun in 1904 under Dean Hole, who, however, did not survive to see its dedication on St Andrew's day at the close of the same year.

The parish church of St Nicholas was built in 1421, and restored after a fire in 1892. In Saxon times the cathedral was the parish church, but after the establishment of a monastery here, monks and parishioners quarrelled as to their rights, and a new parish church was built.

On the eminence overlooking the right bank of the river and commanding a wide view of the surrounding country are the extensive remains of the Norman castle, part of which was built by Bishop Gundulph at the order of William Rufus towards the close of the 11th century. The castle was besieged by King John, by Simon de Montfort in the reign of Henry III., and in the reign of Richard II. by a party of rebels during the insurrection of Wat Tyler. It was repaired by Edward IV., but soon afterwards fell into decay, although the massive keep is still in good preservation. This, one of the finest relics of its kind in England, is considered to be the work of William de Corbeil, archbishop of Canterbury, to whom the castle was granted in 1126. It is a quadrangular four-storeyed structure, flanked by turrets, with an extreme height of 120 ft. Remains of the 13th-century walls which once surrounded the city also exist. Gad's Hill, above Strood, to the north-west, is famous as the residence of Charles Dickens. At Borstal, south-west of Rochester, is a large convict prison. Among the principal public buildings of secular character in the city are the town hall (1687), the corn exchange with free library and a museum, the county court offices, and the Richard Watt's almshouses (1579). Besides these almshouses there are a number of other charities, among which the almshouse of St Catherine originated in 1316 as a leper's hospital. A picturesque Elizabethan mansion was acquired by the corporation for a museum as a memorial of Queen Victoria's Diamond Jubilee. The principal schools are the cathedral grammar-school or King's School, founded in 1544, and the Williamian mathematical school (1704), formerly

for the sons of freemen, but now open to all. Rochester has an oyster fishery of some importance, and there is a considerable shipping trade, a quay and landing-place having been erected by the corporation. There is a large steam-engine manufactory. In Strood, which is a ward of the borough of Rochester, there are oil-mills, and brick and cement works. The dockyards and government works of Chatham employ many inhabitants of Rochester. The parliamentary borough returns one member. The city is governed by a mayor, six aldermen, and eighteen councillors. Area, 2933 acres.

History.—Its situation on the Roman way from the Kentish ports to London, as well as its strategic position on the bend of the river Medway, gave Rochester (Durobrivæ, Hrofescester or Hrobecester, Roffa) an early importance. It was a walled Romano-British town (though of no great size), and the original bridge across the Medway probably dated from that period. The church of St Andrew was founded by King Ethelbert, who also made Rochester a bishop's see. Rochester was a royal borough in the time of William I, who raised a castle here, probably on Boley Hill. Richard I granted the citizens quitance of *passagium* from crusaders in the town of Rochester. In 1227 Henry III granted them the city at a fee farm rent of £25; he also granted them a gild merchant, the right to be impleaded only within the city walls, and other liberties. These charters were confirmed by subsequent sovereigns down to Henry VI, who in 1446 incorporated the city by the title of the baillif and citizens, and granted them the power of admiralty and many privileges. Edward IV, by his charter of 1461 altered the style of incorporation to the mayor and citizens. Charters were granted in successive reigns down to Charles I, whose charter of 1659 remained the governing charter until 1835. A fair on the 18th, 19th and 20th of May was granted to the citizens by Henry VI, and another fair was formerly held in December by prescription. At the present time fairs are held on the 18th of May and the 26th, 27th and 28th of August; a "formarket" was granted in the second charter of Henry III; the market days were formerly Tuesday and Friday. Corn and cattle markets are now held on Tuesday.

ROCHESTER, a city and the county seat of Olmsted county, Minnesota, U.S.A., on the Zumbro river, about 70 m. S.E. of St Paul. Pop. (1890) 5321; (1900) 6843; (1905, state census) 7233 (1905 foreign-born); (1910 census) 7844. It is served by the Chicago & North-Western and the Chicago Great Western railways. The city has a public library (1865), and is the seat of St John's School and the Academy of Our Lady of Lourdes (both Roman Catholic), of a state hospital for the insane (1878), originally planned (1877) as an inebriate asylum, liquor dealers being taxed for its erection, and of St Mary's Hospital (1880), a famous institution founded and maintained by the Sisters of St Francis. There is valuable water-power, and the city has grain elevators and various manufactures. Rochester was first settled in 1854, and was chartered as a city in 1858.

ROCHESTER, a city of Strafford county, New Hampshire, U.S.A., on the Cochecho and Salmon Falls rivers, about 30 m. E. by N. of Concord. Pop. (1890) 7396; (1900) 8466, of whom 1651 were foreign-born; (1910 U.S. census) 8868. Area, about 34 sq. m. Rochester is served by four lines of the Boston & Maine railroad. The rivers furnish excellent water-power for various manufactures. Rochester, named in honour of Lawrence Hyde, earl of Rochester, was incorporated as a town by a royal charter in 1722, but no settlement was made here until 1728. From parts of the original town Farmington and Milton were erected in 1798 and 1802 respectively, and in 1846 part of Rochester was annexed to Barrington. It was the birthplace of John Parker Hale. Rochester was chartered as a city in 1891.

See F. McDuffee, *History of the Town of Rochester, New Hampshire* (Rochester, 1892).

ROCHESTER, a city and the county-seat of Monroe county, New York, U.S.A., about 70 m. E.N.E. of Buffalo and about 230 m. W. of Albany, on the Genesee river, 7 m. above where it empties into Lake Ontario. Pop. (1880), 89,366; (1890), 133,896; (1900), 162,608, of whom 40,748 were foreign-born (including 15,685 Germans; 7746 English-Canadians; 5599 Irish; 3900 English; 1777 Russians; and 1278 Italians) and 601 were negroes; (1910, census) 218,149. Rochester is served by the Erie, the Pennsylvania (two divisions), the Lehigh Valley, the West Shore, the Buffalo, Rochester &

Pittsburg (two divisions), and the New York Central & Hudson River (five divisions) railways. The Genesee river, which cuts through the centre of the city in a deep gorge whose banks vary in height from 50 to 200 ft., is navigable for lake craft only for 2½ m. from the mouth, to a point 4½ m. below the city; the Erie Canal runs through the heart of the city and is carried across the river on a stone viaduct of seven arches, 850 ft. long, and having a channel 45 ft. wide. Several lines of freight and passenger steamboats connect with Buffalo, Oswego and other lake ports, and there are daily passenger steamboats to Toronto, Canada, 70 m. distant across the lake. Electric railways connect with neighbouring cities and lake-side resorts on Lake Ontario (Ontario Beach) and Irondequoit Bay, an irregular arm of the lake, 5 m. long 2 m. E. of the city limits. Rochester is on high plateaus on either side of the Genesee river at a general altitude of about 500 ft. above sea-level. It occupies an area of 20.3 sq. m. Within the city limits are the famous Falls of the Genesee,¹ three cataracts of 96, 26 and 83 ft. respectively, the banks above the first fall, which is in the heart of the city, rising to a height of fully 200 ft. above the river. From the city limits the river falls 263 ft. in its 7 m. course to the lake. Ten bridges, road and railway, connect the two sides of the river.

Rochester is an attractive city, with many fine avenues. East Avenue is perhaps the most beautiful street in the city, and Plymouth, West and Lake Avenues are other prominent residential streets. The park system of Rochester, planned by Frederick Law Olmsted, was 1264 acres in extent in 1908. The largest park is Eastman-Durand (512 acres), on the shore of Lake Ontario; Genesee Valley Park (443 acres) is on both sides of the river; Seneca Park (212 acres) includes a zoological garden; Highland Park (75 acres) and eleven other smaller parks. In Washington Park there is a soldiers' monument surmounted by a statue of Lincoln, and a statue (1898) by S. W. Edwards of Frederick Douglass, the negro orator and editor, who lived in Rochester in 1847-70, stands at the approach to the New York Central & Hudson River railway station. The principal cemeteries are the Mount Hope, the Holy Sepulchre, and Riverside. The Powers Building, a 7-storey stone and iron structure surmounted by a tower 204 ft. high, was one of the first office buildings in the United States to be equipped with elevator service. The Monroe County Court House (of New Hampshire granite) on West Main Street is in the Renaissance style, and contains a law library of about 25,000 volumes. The City Hall (of grey sandstone) has a tower 175 ft. high. Among the other prominent buildings are the Post Office, the Chamber of Commerce, the Lyceum Theatre, the Temple Theatre, the Masonic Building, the Buffalo, Rochester & Pittsburg office building, the Sibley building, the Duffy-McLanerney building, and the Young Men's Christian Association building. The following churches are architecturally noteworthy: the Central, the First and the Third Presbyterian, the Brick Presbyterian, St Patrick's Cathedral (Roman Catholic), the Cornhill and the Asbury (Methodist Episcopal), the First Baptist, St Paul's (Protestant Episcopal), and the First Unitarian. Rochester is the see of a Roman Catholic bishop. In Rochester are the Western New York Institution for Deaf Mutes, the Monroe County Penitentiary, a State Arsenal, a State Hospital for the Insane, the Protestant Episcopal Church Home, Rochester City Hospital (1864), and others, including the Rochester Municipal Hospital (1903) for contagious diseases and consumption.

Rochester is an important educational centre. Its best-known institution is the University of Rochester (Baptist, 1850; co-educational since 1900), having in 1908-9 28 instructors, 352 students (231 men and 121 women), and a library of 40,000 volumes. It occupies a tract of 24 acres

¹ From the top of the upper falls (96 ft. high), in the centre of the city, Sam Patch (1807-1820) jumped and was killed in November 1829; he had formerly made the same leap, had jumped half the depth of Niagara, and was planning to go to London and jump from London Bridge—he was to go by sailing packet to Liverpool and jump from the yard-arm every fair day.

on University Avenue in the eastern part of the city. With it is connected the Ward Museum, containing the valuable geological and zoological collections of Henry Augustus Ward (1834-1906), an American naturalist, professor of natural sciences here in 1860-75, who had in Rochester a laboratory for the manufacture of plaster-casts of fossils, and who prepared natural-history cabinets for many museums. Much of the success of the university was due to Martin Brewer Anderson (1815-1890), president from 1853 to 1888, and David Jayne Hill (b. 1850), who was president from 1888 to 1896, and subsequently was assistant secretary of state in 1898-1903, and minister to Switzerland in 1903-5 and to the Netherlands from 1905 to 1907, when he became ambassador to Germany. Rochester Theological Seminary (1850) is also under the control of the Baptist Church, but has no organic connexion with the university of Rochester. Its library of 36,500 volumes includes the valuable collection (6500 vols.) of the German church historian, Johann August Wilhelm Neander. Other educational institutions include St Bernard's Theological Seminary (Roman Catholic; 1893); Wagner Memorial Lutheran College (German; Academy of the Sacred Heart (Roman Catholic), &c. One of Rochester's most noteworthy institutions is the Athenaeum and Mechanics' Institute (an outgrowth of the Rochester Athenaeum, established in 1829); it was founded in 1885 by Henry Lomb, of the Bausch & Lomb Optical Co., and has a large building, the gift of George Eastman (b. 1854), of the Eastman Kodak Co. It has an endowment of \$650,000, and more than 60 instructors, and in 1907-8 more than 5000 students were enrolled. Since 1907 public school buildings have been used as club-houses for community civic clubs with libraries and gymnasiums; and in 1909 a League of Civic Clubs was organized. Besides the law library and the libraries of the educational institutions mentioned above, Rochester has the Reynolds (Public) Library, containing more than 65,000 volumes in 1910.

The Falls of the Genesee provide a valuable water-power, early utilized by the flour-milling industry, of which, owing largely to the nearness of the fertile wheat-fields of the Genesee Valley and the transportation facilities furnished by the Erie Canal and Lake Ontario, as well as to the water-power, Rochester was for many years the most important centre in the country. Flour-milling is no longer so important an industry here, but Rochester ranks high among the great manufacturing cities of the country, holding third rank in this as in population in New York state, and is remarkable for the great size and output of several of its manufacturing plants, which are the largest of their sort in the United States or of the world. In 1905 the value of the city's factory products was \$82,747,379, an increase of 38.7% since 1900. In value of product and in number of wage-earners employed the manufacture of men's clothing stood first; the value of the product was \$14,948,703, or more than 18% of the total value of all the city's manufactures; and 20% of the factory wage-earners in the city were employed in this industry. The second industry in 1905 was the making of boots and shoes, of which the value was \$8,620,011, an increase of 24.3% since 1900. In the value of clothing and in the value of boots and shoes manufactured Rochester ranked seventh among the cities of the United States in 1905. In the manufacture of photographic apparatus and materials and optical goods Rochester easily holds first place in the world, and it has the largest establishment for the manufacture of cameras (the Eastman Kodak Co. at Kodak Park) and the largest manufactory of lenses, telescopes, opera and field glasses (Bausch & Lomb Optical Co.). The total value of the photographic apparatus in 1905 was \$2,886,071, which represented 82.9% of the product value of photographic apparatus manufactured in the entire United States, and was 176.1% more than in 1900. Photographic materials amounted in value to \$4,528,522, 47.4% of the total value of the product of the country. The value of the output of this industry was 2100% more in 1905 than in 1900. Another remarkable increase was shown in the value of electrical machinery and apparatus, which was only \$15,000 in 1900, but in 1905 was \$2,078,360. Flour and grist mill products in 1905 were valued at \$3,222,257. In Rochester is an immense refinery of lubricating oil, and the oil product more than doubled in value between 1900 and 1905. Other important manufactures, with the value of their product in 1905, are as follows: foundry and machine-shop products, \$2,874,142; furniture, \$2,364,859; tobacco, cigars, snuff, &c., \$2,234,531; malt liquors, \$2,173,707; confectionery, \$1,516,110; and planing mill products, \$1,495,229; carriages and wagons, \$1,229,570; and stationery goods, \$1,130,873. Rochester is also the nursery-

gardening centre of the United States. The first nursery, that of Ellwanger & Barry, now one of the largest in the world, was established here in 1840. There are now more than a score of large nurseries, representing an investment of several millions of dollars, and annually shipping seeds, bulbs and plants having an approximate value of \$2,000,000. Rochester is the port of entry for the Genesee customs-district, importing Canadian lumber and wheat and exporting dairy, garden, farm and orchard products. In 1909 its imports were valued at \$1,809,746 and its exports at \$1,356,367.

The government of Rochester is that of cities of the first class (the state census of 1905 showed that it had more than the 175,000 inhabitants necessary for a city of the first class under the New York state law). The city owns its water supply system, the supply being obtained largely from Hemlock Lake, 30 m. S. of the city limits. The value of the plant is approximately \$8,000,000. Rochester is famous for the purity of its milk supply, which is regulated under a strict system of supervision and inspection.

The region about Rochester, when first visited by Europeans, was the home of the Seneca Indians. The Jesuits, Peter Joseph Marie Chaumonot (1611-1693) and Jacques Frémin (d. 1691), worked among the Indians in the neighbourhood. In 1687 the marquis de Denonville fought a battle with the Iroquois near the falls. In 1710 there was a French post on Irondequoit Bay. The district was included in the Phelps-Gorham Purchase in 1788. It was not until Ebenezer Allan (called "Indian Allan") built a saw and grist mill at the falls in 1790 that a small settlement began to grow up. In 1802 a large tract of land, which included the site of the present city, passed into the hands of three Maryland proprietors, Charles Carroll, William Fitzhugh, and Nathaniel Rochester (1752-1831). Rochester, from whom the city took its name, was a native of Virginia, had been a manufacturer at Hagerstown, Maryland, and after settling in Rochester in 1818 was a member in 1822 of the New York Assembly. He established a settlement, largely of New Englanders, at the falls in 1810-12, but its growth was slow as it was not on the direct road between Albany and Buffalo, and the region was malarial. It was known at first as "The Falls" or "Falls Town." In 1817 it was incorporated as the village of Rochesterville, the name being shortened to its present form two years later. In 1820 it had only 1502 inhabitants. In 1821 Monroe county was erected with Rochester as the county-seat. The real growth of the place began with the completion of the Rochester and Lockport section of the Erie Canal in 1823, and in two years the population had about doubled. Rochester was first chartered as a city in 1834, with 12,000 inhabitants. Rochester's first newspaper, the *Gazette*, was established in 1816, the *Telegraph* following in 1818. The first daily newspaper was the *Daily Advertiser* (1826). Between 1828 and 1830 Rochester was the centre of the anti-Masonic political movement, and here Thurlow Weed published his *Anti-Masonic Enquirer*. Subsequently it was a centre of the abolitionist movement in New York state; Myron Holley (1770-1841) began here the publication of his *Freeman* in 1830, and in 1847 Frederick Douglass established the *North Star*. For many years before the Civil War it was a busy station of the "Underground Railroad," by which fugitive slaves were assisted in escaping to Canada. In 1846 Miss Susan B. Anthony settled in Rochester, and the city has been a gathering-place for advocates of women's rights. Here lived the Fox sisters, Margaret (1836-1893) and Katharine (b. 1839), whose spiritualistic demonstrations became notorious about 1850 as the "Rochester Rappings," and the city has been a gathering-place for American spiritualists also. The narrowness of the gorge through which the Genesee river runs has always rendered the city liable to disastrous floods. Several of these in its early history practically destroyed the manufacturing industries along the river, but the loss of property in the more recent ones has been relatively less; that of 1865 entailed a loss of more than \$1,000,000, and in that of 1902 the damage exceeded \$1,500,000.

See William F. Peck, *History of Rochester and Monroe County* (2 vols., Chicago, 1908).

ROCHET (Lat. *rochetium*, from the late Lat. *roccus*, connected with the O.H.Ger. *roch*, roc and the A.S. *rocc*; Fr. *rochet*, Ital. *rochetto*, Sp. *roquete*, Ger. *Rochett*, *Chorkleid*), an ecclesiastical

vestment. In the Roman Catholic Church the rochet is a tunic of white, and usually fine linen or muslin (battiste, mull) reaching about to the knee, and distinguished from the surplice by the fact that its arms are narrow and tight-fitting. The lower edge and the sleeves are usually garnished with lace, lined with violet or red silk in the case of prelates, or—more rarely—with embroidered borders.

The rochet is proper to, and distinctive of, prelates and bishops: but the right to wear it is sometimes granted by the pope to others, especially the canons of cathedral churches. It is not a *vestis sacra*, and cannot therefore be used as a substitute for the surplice, e.g. in the administering of the Sacraments (Decree of the Congregation of Rites of Jan. 10, 1852). None the less, since it is used at choir services and is ordered to be worn over the everyday dress at Mass (*Missa rom. Rit. celebr. i. 2*), it may be included among liturgical vestments in the widest sense.

The earliest notice of the use of the rochet is found in an inventory of the vestments of the Roman clergy, dating from the 9th century. In this it is called *camisia*, a name which it retained at Rome until the 14th century, and it seems to have been already at that time proper to particular members of the clergy. Other Roman names for the vestment were *succa*, *sucta*; it was not till the 14th century that the name *rochetum* appeared at Rome, but it was not long before it had superseded all the native designations. Outside Rome, too, the vestment is early met with, e.g. in the Frankish empire (9th century) as *alba clericalis*, in contradistinction to the liturgical alb, and in England (10th century) under the name of *oferstrip* in the 46th canon of the ecclesiastical laws of Edgar. At the beginning of the 12th century the rochet is mentioned, under the name of *camisia*, by Gilbert of Limerick and by Honorius, and, somewhat later, by Gerloh of Reichersperg as *tunica talaris*. From the 13th century onward it is frequently mentioned. The name *rochetum* is first traceable in England; in Germany and northern France the rochet was also called *sarohit* (*sarrotus*) or *sarcos* (*sarcotium*).

Outside Rome the rochet was, until well into the 14th century, a vestment common to all the clergy, and especially to those of the lower orders; and so it remained, in general, until the 16th century, and even, here and there, so late as the 19th. Moreover, in further contradistinction to the Roman use, it had—especially in the German dioceses—a liturgical character, being used instead of the surplice.

The rochet was originally a robe-like tunic, and was therefore girdled, like the liturgical alb. So late as 1260 the provincial synod of Cologne decreed that the *vestis camisialis* must be long enough entirely to cover the everyday dress. A good example of the *camisia* of the 12th century is the rochet of Thomas Becket, preserved at Dammartin in the Pas de Calais, the only surviving medieval example remarkable for the pleating which, as was the case with albs also, gave greater breadth and more elaborate folds. In the 15th century the rochet only reached half-way down the shin; in the 16th and 17th to the knee; in the 18th and 19th often only to the middle of the thigh. In the middle ages it was always plain. The rochet is unknown in the Eastern Churches. (J. BRA.)

Church of England.—In the English Church the rochet is a vestment peculiar to bishops, and is worn by them, with the chimere (*q.v.*) both "at all times of their ministration" in church and also on ceremonial occasions outside, e.g. in the House of Lords or at a royal levee. In general it has retained the medieval form more closely than the Roman rochet, in so far as it is of plain, very fine linen (lawn), and reaches almost to the feet. The main modifications have been in the sleeves. At the time of the Reformation these were still narrow, though already showing a tendency to expand. The portrait of Archbishop Warham at Lambeth, for instance, shows a rochet with fairly wide sleeves narrowing towards the wrists, where they are confined by fur cuffs. This fashion continued until, in the 17th century, the sleeves became much fuller; but it was not till the 18th century that they developed into the familiar

exaggerated balloon shape, confined at the wrists by a ribbon, beyond which a ruffle projected. About the same period, too, arose the custom of making the rochet sleeveless and attaching the "lawn sleeves" to the chimere. This fashion survived throughout most of the 19th century, but there has since been a tendency to revert to the earlier less exaggerated form, and the sleeves have been reattached to the rochet. The ribbon by which the wrist is confined is black, except when convocation robes are worn, when it is scarlet. The rochet is worn without the chimere under the cope by those bishops who use this vestment. At his consecration the bishop-elect is, according to the rubric, presented to the consecrating bishops vested in a rochet only; after the "laying on of hands" he retires and puts on "the rest of the episcopal habit," i.e. the chimere. (W. A. P.)

ROCHFORD, EARL OF, an English title borne by the family of Nassau de Zulestein from 1695 to 1830. William Henry Nassau de Zulestein (1645-1709) was born at Zuyelestein, near Utrecht, his father being Frederick Nassau de Zulestein (1608-1672), a natural son of Henry Frederick, prince of Orange, and his mother an English lady, Mary Killgrew. One of the most trusted companions of his kinsman, William of Orange, Zulestein was sent to England in 1687 and again in 1688 to report on the condition of affairs, and later in 1688 he sailed with the prince on his famous expedition. After the Revolution he was naturalized and served the king in the field, being created Viscount Tunbridge and earl of Rochford in 1695. He was succeeded by his son William (1681-1710), who was killed at the battle of Almenara, and then by another son Frederick (1682-1738). Frederick's son, William Henry, the 4th earl (1717-1781), was a diplomatist and a statesman. Having gained experience as envoy at Turin from 1749 to 1753, he was ambassador at Madrid from 1763 to 1766 and at Paris from 1766 to 1768. From 1768 to 1775 he was one of the secretaries of state. This earl left no children when he died on the 28th of September 1781, and his nephew, William Henry, the 5th earl (1754-1830), dying in September 1830 the earldom became extinct. The estates of the earls of Rochford were in Suffolk and Essex, their principal residence being St Osyth Priory in the latter county.

ROCHFORD, a town in the south-eastern parliamentary division of Essex, England, 39 m. E. by N. from London by the Southend branch of the Great Eastern railway. Pop. (1901) 1820. It lies on the small river Roach, near the head of a long estuary. The town has a Perpendicular church (St Andrew), a corn exchange and some agricultural trade. Rochford Hall, a picturesque gabled mansion of various dates, belonged once to the Boleyns, and it has been stated that Anne Boleyn, the unfortunate queen of Henry VIII., was born here, but this is in no way proved. Near Rochford the Lawless or Whispering Court, a remarkable survival of unknown origin, is held by a manorial tenure on the Wednesday following Michaelmas Day, beginning at midnight. No light is permitted, nor may voices be raised above a whisper. Nearly 3 m. N.W. from Rochford is Ashington. This is generally accepted as the scene of the fight of Assandun in 1016 between Canute and Edmund Ironside, in which the English were defeated through treachery in their ranks. Earthworks of this or an earlier date, remain.

ROCK, DANIEL (1799-1871), English Roman Catholic priest and ecclesiologist, was born at Liverpool on the 31st of August 1799, and educated at St Edmund's College, Ware, Herts, and at the English College, Rome. He was ordained priest in 1824 and successively appointed chaplain to the 16th earl of Shrewsbury at Alton Towers, Staffordshire, and priest in charge of the Roman Catholic congregation at Buckland, near Faringdon in Berkshire. After the re-establishment of the Roman Catholic hierarchy in England, in which he had taken an active part, Rock was elected a canon of St George's Cathedral, Southwark. He was greatly interested in medieval art, and, having gone to live at South Kensington in 1864, in order to be near the museum, was of great assistance to the authorities there. He died on the 28th of November 1871.

Rock's principal works are: *Hierurgia, or the Holy Sacrifice of the Mass expounded* (London, 1833; revised edition by W. H. J. Weale, 1893), an exhaustive account of the Eucharistic rites in the Latin, Greek and Oriental Churches, and illustrated from early paintings, sculptures and inscriptions; *The Church of Our Fathers, as seen in St Oswald's Rite for the Cathedral of Salisbury, with Dissertations on the Belief and Ritual in England before the Coming of the Normans* (3 vols., 1849-54; new edition by G. W. Hart and W. H. Frere, London, 1903).

See the Memoir prefixed to Hart & Frere's edition of *The Church of Our Fathers* by the Rev. B. W. Kelly; a full list of his writings is given in J. Gillow's *Bibl. Dict. of the Eng. Catholics*, vol. v. p. 436.

ROCK (O.Fr. *roche*, Sp. *roca*, Ital. *roccia*; possibly from a Lat. form *rupica*, from *rupes*, rock), in geology a mass of the mineral matter of which the crust of the earth is composed (see **PETROLOGY** and **GEOLOGY**). In more general usage a "rock" is a large mass of this mineral matter, as distinguished from smaller pieces which are termed "stones."

From this word must be distinguished the verb "to rock," to swing an object to and fro, particularly of a cradle in which a child is rocked to sleep, the original meaning. The O.Eng. word is *roccian*, and is cognate with many words in Teutonic languages, e.g. *Du. rukken*, *Dan. rykke*, *Ger. rücken*, to pull, tug, push.

ROCK-CRYSTAL, a colourless and transparent variety of quartz (*q.v.*), used as an ornamental stone. It usually occurs as crystals lining cavities in quartz-veins, which often run through granite, gneiss and crystalline schists. The limpidity of the crystal, its coldness to the touch and its common occurrence in rocks among Alpine glaciers, led to the ancient belief that it was a kind of congealed water, whence the name crystal, from Gr. *κρυσταλλος* (ice). In the Swiss Alps the "*Sirahlér*," or crystal-gatherer, searches the rocks at much personal risk, and is often led to a drusy cavity by tracing narrow veins, or strings, of quartz on the mountain-side. A remarkable druse, or *Krystalkeller*, discovered at Zinkenstock in the Bernese Oberland, in 1719, yielded about 20 tons of crystal, a single specimen weighing 8 cwt. The famous discovery of the Galenstok, in 1867, furnished magnificent crystals, but they were dark brown or smoky quartz. La Gardette, near Le Bourg d'Oisans, in the Alps of Dauphiné, is a notable locality for fine specimens of rock-crystal. The Alps and India probably furnished the ancients with their supplies.

Rock-crystal has been used for ornamental purposes since the Mycenaean period. By the Romans under the Empire it was highly valued, and carved into vases and goblets, in some cases elaborately engraved. Lenses or globes were used for kindling the sacred vestal fire and for cauterizing the flesh, whilst ladies carried balls of crystal in order to cool their hands during the heat of summer. The artists of the Early Renaissance greatly favoured the use of rock-crystal, and executed beautiful carvings in this material. In modern times the use of rock-crystal has been largely superseded by that of glass, and it is notable that flint-glass is known in France as "*crystal*," probably from its resemblance to limpid quartz, or perhaps from the fact that powdered rock-crystal has been used as a source of silica in the manufacture of the finest glass. Rock-crystal is still cut as a faceted stone for personal decoration, but though not without brilliancy it lacks the "fire" of many gemstones. It is often known locally by such names as Bristol diamond, Cornish diamond, Isle of Wight diamond, Briançon diamond, Marmaros diamond, Lake George diamond, &c. Rock-crystal is also carved into seals, paper-weights and other trivial objects, and into spheres for divination by crystal-gazing, Japanese balls being specially noteworthy. In Japan the crystal has been obtained for centuries from the granitic districts around Kimpū-san, in the province of Kai. Probably the most valuable application of rock-crystal is for spectacle lenses, which in consequence of their hardness are not readily abraded by use. They should be cut at right angles to the optic axis, or axis of the prism.

The "pebble" for lenses is found loose in the soil in many parts of the provinces of Goyaz, São Paulo and Minas Geraes in Brazil. Much of the material for spectacles comes also from Madagascar, where large crystals of clear quartz are found in the beds of certain streams, especially in the N.E. part of the island, having probably

been derived from quartz-veins in the gneiss and pegmatite. In India rock-crystal has been worked at many localities, and the loot of the palace of Delhi yielded marvellous ornaments carved in this material. At the present day it is cut and polished at Vellum in the Tanjore district in Madras, and is known as Vellum stone. Among the numerous localities in the United States which yield rock-crystal mention may be made of those in Herkimer Co., New York State, whence the Lake George crystals are obtained; and it is notable that some of the Herkimer quartz encloses bituminous matter. Mokelumne Hill, Calaveras Co., California, has furnished some remarkable rock-crystal. In Europe the localities are very numerous, the most important being those in the Alps. Very fine crystals remarkable for pellucidity though not of large size occur in cavities in the statuary marble of Carrara; and remarkably hollowed crystals are known from Porretta near Bologna in Italy. The finest rock-crystal in Great Britain occurs at Tintagel and the Delabole slate quarry in N. Cornwall; and at Snowdon in N. Wales. (F.W.R.*)

ROCKEFELLER, JOHN DAVISON (1839-), American capitalist, was born in Richford, Tioga county, New York, on the 8th of July 1839. In 1853 his family removed to Ohio, living after 1857 in Cleveland, where Rockefeller had begun to work as a bookkeeper in 1855 and where in 1858 he went into the produce commission business. His firm, Clark & Rockefeller, in 1862 invested in an oil refinery, planned by Samuel Andrews, and in 1865 Rockefeller sold out his share to his partner Clark, bought for \$72,500 a larger share in another refinery, and formed the partnership of Rockefeller & Andrews. At about the same time another refinery was started by Rockefeller's brother William (b. 1841), but in 1867 Rockefeller & Andrews absorbed this business, and Henry M. Flagler was added to the partnership. In 1870 the two Rockefeller, Flagler, Andrews and a refiner named Stephen V. Harkness formed the Standard Oil Company, with a capital of \$1,000,000 (increased in 1872 to \$2,500,000 and in 1874 to \$3,500,000), of which John D. Rockefeller was president. This great corporation gradually established itself in practical control of the oil production in America, by means of business methods and financial operations which have been severely criticized, but which brought immense wealth to those concerned. Its capital was further increased in 1882, when separate companies were organized in each state; and in later years, as the first great American "trust," the Standard Oil Company was hotly attacked during the anti-trust movement (see **INTER-STATE COMMERCE**). Into the merits of this question it is impossible to enter here. Rockefeller himself retired from active business in 1895; he had for a time large iron interests (mines and ore-carrying vessels) on Lake Superior, which he sold to the United States Steel Corporation, and his personal wealth was probably greater than that of any other man in the country. In private life he was a devoted member of the Baptist church, and his benefactions were numerous. To "the University of Chicago founded by John D. Rockefeller" (in 1892) he had given, up to 1910, \$24,809,666, while to the General Education Board he had given \$43,000,000; he founded (1901) and supported the Rockefeller Institute for Medical Research in New York City; he gave large sums to Rush Medical College in Chicago, to Johns Hopkins Hospital in Baltimore, to Barnard College in New York City and to the Baptist Missionary Society; and in 1909 he gave \$1,000,000 to endow a medical commission to investigate the nature of the hook-worm and to suppress the hook-worm disease.

See Ida M. Tarbell's *History of the Standard Oil Company* (New York, 1903), a severe attack on the Trust; also his own *Random Reminiscences* (1909).

ROCKET. (1) The name (Fr. *roquette*, Lat. *eruca*, a kind of cabbage) of two species of plants. The one, *Eruca sativa*, is a cruciferous annual with white flowers veined with purple; the leaves have a sharp flavour and are used in southern Europe for salads. The other is a hardy perennial herbaceous plant, of the genus *Hesperis*, of which *Hesperis matronalis* is the most familiar species (see **HORTICULTURE**).

(2) A cylinder of paper, pastboard or metal, filled with an explosive mixture. This word, which appears in many forms in various languages, is from the It. *rochetta*, diminutive of *rocca*, a distaff, the obsolete English "rock"; the application

is due to a resemblance in shape. Rockets are used in pyrotechny for purpose of display, scattering showers of stars, coloured balls, &c., on bursting (see FIREWORKS). They are also used in signalling, and especially as a part of life-saving apparatus for wrecks (see LIFEBOAT and LIFE-SAVING SERVICE).

Large and heavy rockets, of which the head formed a projectile, had too a considerable vogue in the early part of the 19th century for war purposes. They were invented by Sir William Congreve (*q.v.*) and employed by him both afloat in coast operations and in field operations. Brought to the notice of all armies by the fact that a rocket battery of the Royal Artillery served in the allied army in the Leipzig campaign, war rockets were introduced in many armies, being sometimes issued as an additional portion of the equipment of ordinary field batteries, sometimes reserved for special rocket batteries. The Congreve rocket was in use in the British army as late as 1860. There were four natures—3-pounder, 6-pounder, 12-pounder and 24-pounder. The case was of sheet-iron, on to which was screwed a cylindro-conoidal head forming the projectile. The head was made hollow and could be filled with a bursting charge if a shell effect was desired, a base fuze being provided. The iron case contained the rocket composition, and was closed at the rear end by a metal plate with five holes or vents, and on the centre a bush into which the stick was screwed. These rockets were fired from rocket tubes on tripods, the tubes being provided with a tangent sight. Against masses of troops within easy range, the war rocket was considered an efficient engine; it was used also to set fire to buildings, but was always deficient in accuracy. Eventually the Congreve rocket was superseded by the Hale, of which two patterns were in use, the 9-pounder and the 24-pounder, for field and fortress warfare respectively. These had no sticks, and were centred by the arrangement of the vent, the gases, as they emerged from the vent, impinging upon a screw-formed tail, to which they imparted the necessary rotation. These rockets were fired from a trough. The maximum effective range of the 9-pounder Hale rocket was about 1200 yards. The use of these engines was discontinued in the British service about 1885. On the continent of Europe they had disappeared more than twenty years before. Austria, the last power to use them, broke up her rocket batteries in 1867.

ROCKFORD, a city and the county seat of Winnebago county, Illinois, U.S.A., on the Rock river, in the northern part of the state, about 85 m. N.W. of Chicago. Pop. (1890) 23,584; (1900) 31,051, of whom 9337 were foreign-born (6690 Swedes); (1910 census) 45,401. Area, 8.91 sq. m. It is served by the Chicago, Burlington & Quincy, the Chicago & North-Western, the Chicago, Milwaukee & St. Paul, the Chicago, Milwaukee & Gary ("Rockford Route") and the Illinois Central railways, and is connected by interurban electric railway with Chicago and Freeport, Illinois, and Janesville, Wisconsin. The city has a Memorial Hall, erected in honour of the soldiers and sailors of Winnebago county, and in charge of the Grand Army of the Republic; a soldiers' memorial fountain; a Carnegie library, containing 51,340 volumes in 1909; and the Velie Museum of natural history. Rockford College (non-sectarian), for the higher education of women, is ranked by the United States Commissioner of Education as one of fifteen women's colleges of the highest grade in the country; it was opened in 1840 as Rockford Seminary, and was named Rockford College in 1892. In 1908-9 it had 196 students. Rockford is the see of a Roman Catholic bishop. In and near the city there are two hospitals and three sanatoriums. Manufacturing is facilitated by good water-power, supplied by a dam across the Rock river about 800 ft. long, constructed in 1844. Among the manufactures are furniture, hosiery and knit goods, agricultural implements, foundry and machine-shop products, saddlery and harness, &c. The total value of all factory products in 1905 was \$15,276,129 (38.6% more than in 1900). The municipality owns and

operates its waterworks; the water supply is obtained from artesian wells. Rockford was first settled in 1834, and was chartered as a city in 1852. More than one-fourth of its area has been annexed to the city since 1889.

ROCKHAMPTON, a town of Livingstone county, Queensland, Australia, on the Fitzroy river 4.3 m. from its mouth, 335 m. in a direct line N.W. of Brisbane. It has a beautiful situation, and its climate, in spite of heat, is healthy. It is the port of a wide agricultural district, which also produces gold, copper and silver. Much of the trade is carried on through the ports of Alma and Broadmount, near the mouth of the river, both available for ocean steamers. Rockhampton has a large trade in frozen meat, and there are factories for extract and meat preserving. Rockhampton is the terminus of the Queensland Central railway and the seat of an Anglican and a Roman Catholic bishopric. Population of the municipality (1901), 15,461; within the 5 m. radius, 19,691; of the separate municipality of North Rockhampton, 2865.

ROCK HILL, a city of York county, South Carolina, U.S.A., 84 m. by rail N. of Columbia. Pop. (1890) 2744; (1900) 5485 (1706 negroes); (1910) 7216. Rock Hill is served by two lines of the Southern railway. It lies at an elevation of about 670 ft. above the sea. Among its buildings and institutions are the Federal Government Building, the City Hall, the Carnegie Library and the Winthrop Normal and Industrial College (chartered in 1891 and opened in 1894), a state institution for white girls. Cotton is the most important product of the surrounding country. The Catawba river, 5 m. distant, furnishes good water-power, and in a large power-plant electricity is generated for the city's manufactures. Among the manufactures are cotton goods, cotton-seed oil, yarn, wagons and carriages, foundry and machine-shop products; and there are cotton gins, marble and stone works. The growth of the city has been almost entirely since the Civil War. Rock Hill was incorporated as a village in 1870, and was chartered as a city in 1892.

ROCKINGHAM, CHARLES WATSON WENTWORTH, 2ND MARQUESS OF (1730-1782), twice prime minister of England, was the son of Thomas Watson Wentworth (c. 1690-1750), who was created earl of Melton in 1733 and marquess of Rockingham in 1746. The family of Watson was descended from Sir Lewis Watson (1584-1653), son and heir of Sir Edward Watson (d. 1616) of Rockingham Castle in Northamptonshire. For his services to the king during the Civil War Sir Lewis was created Baron Rockingham in 1645. His grandson Lewis, the 3rd baron (1655-1724), was created earl of Rockingham in 1714, and was succeeded by his grandson Lewis (c. 1709-1745), whose brother Thomas, the 3rd earl, died unmarried in February 1746, when the earldom became extinct. The barony of Rockingham, however, descended to a cousin, Thomas, father of the prime minister, a grandson of Edward, the 2nd baron (1630-1689), who had married Anne, daughter and heiress of Thomas Wentworth, 1st earl of Strafford. The vast estates of the Wentworths had passed to Edward's son, Thomas, who took the additional name of Wentworth, and then to his son, the 1st marquess of Rockingham.

Charles Watson Wentworth was born in 1730 on the 19th of March (according to some, the 13th of May), and was educated at Westminster school and St John's College, Cambridge. He showed his spirit as a boy by riding across from Wentworth to Carlisle in 1746 to join the duke of Cumberland in his pursuit of the Young Pretender. He was created earl of Malton in the peerage of Ireland in September 1750, and succeeded his father as 2nd marquess of Rockingham in December of the same year. In 1751 he became lord-lieutenant of the North and East Ridings of Yorkshire and a lord of the bedchamber, and in 1760 was made a knight of the Garter. After George III. had begun his policy of dividing the great Whig families, those Whig noblemen and gentlemen who did not choose to join the sections headed by the Grenvilles, the duke of Bedford, or any other great noblemen, selected as their chief the young marquess of Rockingham. In May 1762 the king's favourite,

the earl of Bute, became first lord of the treasury, and the marquess of Rockingham was amongst those who in the following year were dismissed from their lord-lieutenancies. The opposition now grew so strong that Lord Bute resigned in April 1763, and the king, true to his policy, appointed George Grenville to be his successor. But Grenville's section of the Whig party was not strong enough to maintain him in power long, and in July 1765 Lord Rockingham formed his first administration with General Conway and the duke of Grafton as secretaries of state. The cabinet seemed stronger than it really was, for it was divided by intestine quarrels, and the earl of Chatham refused to have anything to do with it. Nevertheless, Rockingham recovered his lord-lieutenancies and won reputation as a good administrator. In May 1766 the duke of Grafton, a far abler man than Rockingham, though neither so conciliatory in his manners nor so generally popular, seceded from the government, and in August 1766 he succeeded his former chief as first lord of the treasury and prime minister. Then followed many years of fruitless opposition to the king's personal authority as exhibited through his ministers, but at last, on the 27th of March 1782, Lord Rockingham again became prime minister with Fox and Shelburne (afterwards marquess of Lansdowne) as secretaries of state. This time he enjoyed office for but a few weeks, for he died on the 1st of July 1782. He left no issue, and his property went to his nephew, the 2nd Earl Fitzwilliam, his titles becoming extinct. A few words from his epitaph by Burke deserve quotation as giving the reason of the predominance of such an ordinary man as Lord Rockingham over a party abounding in men of great abilities: "A man worthy to be held in esteem, because he did not live for himself. . . . He far exceeded all other statesmen in the art of drawing together, without the seduction of self-interest, the concurrence and co-operation of various dispositions and abilities of men, whom he assimilated to his character and associated in his labours."

See *Memoirs of the Marquis of Rockingham and his Contemporaries*, by George Thomas, earl of Albemarle (2 vols., 1852); Horace Walpole's *Memoirs of the reign of George III.*, edited by G. F. R. Barker (1894); and the other letters, papers and diaries of the time.

ROCK ISLAND, a city and the county-seat of Rock Island county, Illinois, U.S.A., in the N.W. part of the state, on the E. bank of the Mississippi river, adjoining Moline, and opposite Davenport, Iowa (with which it is connected by two bridges), about 3 m. above the mouth of the Rock river, and at the foot of Rock Island rapids, which extend for nearly 16 m. Pop. (1890) 13,634; (1900) 19,493, of whom 4412 were foreign-born; (1910) 24,335. It is served by the Chicago, Burlington & Quincy, the Chicago, Milwaukee & St Paul, the Chicago, Rock Island & Pacific, and the Davenport, Rock Island & North-Western railways. Near the city, at the mouth of Rock river, the "Hennepin" (or Illinois & Mississippi) canal joins the Mississippi river. The city occupies a plain lying between the river and a series of bluffs. The island of Rock Island, a ridge of limestone rock about 3 m. long and 1½ m. wide, is connected with the mainland by bridges to Rock Island and Moline; on it there are a Federal arsenal, the most important in the country for the manufacture of small-arms, gun carriages and artillery equipment, a Federal armoury and a national cemetery; the island is connected with the Illinois shore at Moline by a dam, whence good water-power is derived. In the city are: a public library (1872), the Augustana College and Theological Seminary (controlled by the Evangelical Lutheran Augustana Synod of North America; co-educational), which was founded as Augustana Seminary in Chicago in 1866 chiefly for the education of Swedish Lutheran clergymen, was removed to Paxton, Illinois, in 1863 and to Rock Island in 1875, and received its present name in 1869; and the principal offices of the Modern Woodmen of the World, a fraternal society, founded in 1884 and having 219,729 members in 1909. The city has a large trade by water and rail; commercially it forms a unit with Davenport and Moline. Among the city's manufactures are lumber, agricultural implements,

flour, glass, stoves, carriages, soap, &c. In 1905 the value of the factory product was \$5,332,967. Some coal is mined in the county.

On the north bank of the Rock river, 3 m. from its mouth, there was a large summer village (sometimes called Saukenuk) of the Sauk Indians, built about 1730 and destroyed in 1811; and near the mouth of the Rock river is a bluff called "Black Hawk's watch-tower." A settlement on the island was made in 1816, when the fort was built; the first settlement on the mainland was made in 1826. In 1841 the town of Rock Island was formed by the consolidation of two small settlements named Stephenson and Farnhamsburg and was incorporated; it received a city charter in 1849. Upon the west end of the island the United States government in 1816 built Fort Armstrong, where on the 21st of September 1832, at the close of the Black Hawk War, a treaty of peace was signed by General Winfield Scott and Governor John Reynolds of Illinois and by the chiefs of the Sauk and Foxes, and where, six days before, General Scott and Governor Reynolds had made a treaty with the Winnebagoes. The fort was abandoned in 1836 and was burned in 1855; a monument now marks its site. The Rock Island armoury and arsenal, under an act of 1862, were built in 1863, when a number of captured Confederate soldiers were confined on the island.

ROCKLAND, a city and the county-seat of Knox county, Maine, U.S.A., on Rockland Harbor, Penobscot Bay, 86 m. by rail E.N.E. of Portland. Pop. (1900) 8150; (1910) 8174. It is the eastern terminus of a branch of the Maine Central railway, and is served by an interurban electric line and by steamboat lines to Portland, Boston, Bangor, Bar Harbor and other coast ports. The harbour is protected by a breakwater nearly 5000 ft. long. The principal buildings are the United States Government Building and the County Court House. Granite and limestone are quarried in the vicinity. The granite (biotite, biotite-muscovite and quartz-monzonite) is of fine quality, and has been used extensively in the United States for building and monumental purposes; and the burning of lime is by far the most important industry of the city. The shipbuilding industry is also important. The total value of the city's factory products in 1905 was \$1,822,591 (46.5% more than in 1900). Lobsters and fish in considerable quantities are shipped from the city. Rockland was settled in 1769, but its growth began only with the establishment of the lime industry in 1795. It was a part of the township of Thomaston (pop. 2205 in 1910), from 1777 to 1848, when it was incorporated as a separate township under the name of East Thomaston. Two years later the present name was adopted, and in 1854 Rockland was chartered as a city.

ROCKLAND, a township of Plymouth county, Massachusetts, U.S.A., about 20 m. S. of Boston. Pop. (1800) 5213; (1900) 5327; (1910 U.S. census) 6028. Area, about 10 sq. m. It is served by the New York, New Haven & Hartford railway, and by interurban electric railway. Among its manufactures are boots and shoes and tacks. There is a public library (1878). Rockland was erected into a township in 1874, having been previously a part of Abington.

ROCKPORT, a township of Essex county, Massachusetts, U.S.A., on the N.E. end of Cape Ann, on the Atlantic Ocean, north-east of Gloucester, and about 35 m. north-east of Boston. Pop. (1800) 4087; (1900) 4592; (1910, U.S. census) 4211. Rockport is the southern terminus of the Gloucester branch of the Boston & Maine railway, and is served by an electric railway extending from Gloucester through Rockport and around the cape. Off Sandy Bay, a rendezvous of the Atlantic squadron of the U.S. navy, the Federal government began in 1884 a harbour of refuge, with an area of 1664 acres, to be protected from north and north-east winds by a breakwater, 117 ft. wide at a depth of 12 ft. below mean low water, rising 22 ft. above mean low water, and 9000 ft. long. In the township are the North Village or Pigeon Cove and the South Village or Rockport. Rockport is a summer resort, and there are many summer residences at Andrews Point and at the South

End and Headlands. There are large granite quarries along the coast, especially in Pigeon Cove, and there are two varieties of granite, called commercially "grey" and "green," both very hard, the former the more abundant. It has been used in building the great breakwater off Sandy Bay and various large bridges. Granite for paving-stones is quarried. Like many of the Maine quarries those of Rockport owe much of their development to their nearness to deep water transportation. Isinglass, glue, tools, parts for automobile engines, and copper paint are among the manufactures. Fishing was formerly of importance, but quarrying has displaced it. Sandy Bay, the fifth parish of Gloucester, first settled about 1697, and Pigeon Cove, part of the third parish, were set off from Gloucester and were incorporated as the township of Rockport in 1840. The Bennett & Mackay transatlantic commercial cable was landed in Rockport in May 1884.

ROCKVILLE, a city of Tolland county, Connecticut, U.S.A., in the N.E. part of the state, on the Hockanum river, about 15 m. N.E. of Hartford. Pop. (1890) 7772; (1900) 7287, of whom 2548 were foreign-born, many being Germans and Poles; (1910) 7977. It is served by the New York, New Haven & Hartford railway and by electric lines. It is in the township of Vernon (pop. in 1890, 8808; in 1910, 9087; area, 19 sq. m.), which was separated from Bolton township in 1808, and contains the villages of Vernon, Vernon Centre, Dobsonville and Talcottville. In the city are the George Maxwell Memorial Library and the Sykes Manual Training School. The river, by a series of falls, makes a descent of 280 ft. here, and furnishes power for large manufacturing establishments. The principal manufactures are woollen, silk and cotton goods, envelopes, and silk fish-lines. In 1841 fancy cassimeres, probably the first manufactured in the United States, were made here. At the Hockanum Mills (established 1809) worsted for men's clothing was first made (about 1870) in the United States. The first settlement here was made about 1726. Rockville was chartered as a city in 1880.

ROCKY MOUNTAIN GOAT, or **WHITE GOAT** (*Oreamnus montanus*), a North American hollow-horned ruminant of the family BOVIDÆ, distinguished by its white colour. It is, in fact, the only ruminant, with the exception of the white Alaskan wild sheep, which is entirely white at all seasons of the year; and cannot, therefore, be mistaken for any other animal, and its description may consequently be brief. In the winter coat the hair is long and pendent, elongated into a short beard on the sides of the lower jaw behind the chin; and it is also longer than elsewhere on the neck and the chest; at the base of the long hair is a thick growth of short and woolly under-fur. In summer the coat becomes comparatively short. The muzzle is hairy, the ears are of moderate size, and the tail is short, and partially buried among the long hair of the rump. There are no glands on the face; but there is a large globular one at the base of each horn of the size of half a small orange. The black horns, which are ringed in their basal portion, are comparatively short and not unlike those of the Asiatic serows in general characters, being subcylindrical, and curving slightly backwards. They taper, however, much more rapidly than those of the serows, and diverge much more widely from the middle line. The lateral hoofs are well developed. Although commonly described as white, the hair has a more or less decided tinge of yellow, which appears to be more marked in the summer than in the winter coat. The cannon-bones are remarkably short and wide, and in this respect differ from those of all allied ruminants, except the Tibetan takin. The general shape of the animal is ungainly, owing to a huge hump on the withers, at which point the height is about 3 ft.

The head of a white goat obtained in 1900 from the mountains at the mouth of Copper river, opposite Kyak Island, has been described as a species apart. In addition to certain details in the conformation of the skull, the horns are much more slender than in the ordinary white goat, and instead of bending regularly backwards till near their tips, curve widely outwards from their bases. Their length is nearly equal to that of the

longest pair of the ordinary form hitherto recorded, while the tip-to-tip interval is nearly double that of any other known specimen. This animal can scarcely be regarded as more than a local race, and should be styled *Oreamnus montanus kennedyi*.

The affinities of the white goat (which is really a member of a group intermediate between goats and antelopes) are probably with the Asiatic serows and takin, and hence perhaps with the musk-ox.

See a paper by Madison Grant, entitled "The Rocky Mountain Goat," published in the ninth annual report of the New York Zoological Society (1905). (R. L. *)

ROCCO, or **ROCAILLE**, literally "rock-work," a style of architectural and mobiliary decoration popular throughout the greater part of Europe during the first half of the 18th century. In France it was especially characteristic of the regency and the reign of Louis XV. A debased style at the best, essentially fantastic and bizarre, it ended in extravagance and decadence. A meaningless mixture of imitation rock-work, shells, scrolls and foliage, the word came eventually to be applied to anything extravagant, flamboyant or tasteless in art or literature. The very exuberance of the rococo forms is, indeed, the negation of art, which is based upon restraint. There is something fundamentally Italian in the *bravura* upon which the style depends; yet Italy has produced some of the worst examples of what in that country is called the "Jesuit style," in allusion to the supposed lack of directness in Jesuit policy. Everything, indeed, in the rococo manner is involved and tortured, though before a superb example of Jacques Caffieri, such as the famous commode in the Wallace Collection, it is impossible not to admire the art with which genius can treat even the defects and weaknesses of a peculiarly mannered fashion. The best French work possesses a balance and symmetry which are usually entirely absent from its imitations. Spain and Italy produced many monstrous travesties—it is impossible to imagine anything more grotesque than the flamboyant convolutions of the monumental Roman style of the third quarter of the 18th century. In Germany, weak and lifeless imitations were as popular as might be imagined in a land which was content to take its art, especially its bad art, from France. England did not escape the infection, and Chippendale and his school produced examples of rocaille work and *coquillage* which were quite foreign to their own sentiment, and rarely rose above respectable mediocrity.

ROCROI, a town of northern France, capital of an arrondissement in the department of Ardennes, 22 m. N.N.W. of Charleville by rail, and within 2 m. of the Belgian frontier. Pop. (1906) town, 796; commune, 2116. As a fortified place it commands the Ardennes plateau between the valley of the Meuse and the head-waters of the Oise. The present fortifications, constructed by Vauban, form a pentagon and entirely close in the town, which has regularly built streets converging on a central square. Overlooking the latter is the church, a florid building of the 18th century. Rocroi is the seat of a sub-prefect and has a tribunal of first instance.

The place, originally called Croix-de-Rau or Rau Croix, was fortified in the 16th century and besieged by the imperialists in 1555. Invested by the Spaniards in 1643, it was relieved by Louis II, the duke of Enghien (afterwards the Great Condé), after a brilliant victory. Captured in 1658 by the same duke, then in the Spanish service, it was not restored to France till the treaty of the Pyrenees in 1659. In 1815 Rocroi was besieged for a month by the allies.

ROD, ÉDOUARD (1857-1910), French-Swiss novelist, was born at Nyon, in Switzerland, on the 31st of March 1857. He studied at Lausanne and Berlin, and in 1878 found his way to Paris. In 1881 he dedicated his novel, *Palmyre Vesudard*, to Zola, of whom he was at this period of his career a faithful disciple. A series of novels of similar tendency followed. In 1884 he became editor of the *Revue contemporaine*, and in 1887 succeeded Marc Monnier as professor of comparative literature at Geneva, where he remained till 1893. *La Course à la mort* (1885) marks a turning-point in his career; in it he

forsook the so-called naturalistic novel for the analysis of moral motives. He is at his best in presenting cases of conscience, the struggle between passion and duty, and the virtues of renunciation. *Le Sens de la vie* (1889), one of his most famous books, is in the nature of a complement to *La Course à la mort*. It was followed by *Les Trois cœurs* (1890), *La Sacrificée* (1892), *La Vie privée de Michel Teissier* (1893), translated as *The Private Life of an Eminent Politician* (1893); *La Seconde Vie de Michel Teissier* (1894), *Le Silence* (1894), *Les Roches blanches* (1895), *Le Dernier Refuge* (1896), *Le Ménage du pasteur Nauddé* (1898), a study of Protestant France; *L'Eau courante* (1902), *L'Inutile Effort* (1903), *Un Vainqueur* (1904), *L'Indocile* (1905), and *L'Incendie* (1906). M. Rod's books of literary criticism include *Les Idées morales du temps présent* (1897), an admirable *Essai sur Goethe* (1898), *Stendhal* (1892), and some columns of collected essays. He published *L'Affaire J. J. Rousseau* in 1906, and in the same year he drew from an episode in the life of the philosopher a play in three acts, *Le Réformateur*, which was produced at the Nouveau Théâtre. He died in January 1910.

ROD (O.E. *rodd*, probably related to Norw. *rudda*, stick, *rod*, stake), a twig or shoot of a tree or bush, especially a straight slender stick or wand used as an instrument of punishment, as a symbol of office, or as an implement, usually composed of several joints, for angling or fishing. The term is thus applied to a metal bar, slender in proportion to its length, used as a tie, brace or connecting shaft between different parts of a machine. It is familiar in the titles, showing the colour of their wands of office, of the gentlemen ushers of the three principal British orders of knighthood, the ushers of the Garter and St Patrick being "Ushers of the Black Rod," and of the Thistle "Green Rod." The use of a rod as a measuring implement has given rise to the use of the word for a measure of length = 5½ yds. or 16½ ft.; this length is also named a pole or perch, the origin of the application being the same as in "rod"; as a measure of area, a rod = a square pole or perch, 30½ square yds. = 27½ square ft., 160 rods = a acre.

RODBERTUS, KARL JOHANN (1805-1875), German socialist, was born at Greifswald on the 12th of August 1805, his father being a professor at the university there. He studied law at Göttingen and Berlin, thereafter engaging in various legal occupations; and, after travelling for some time, he bought the estate of Jagetzow in Pomerania, whence his name of Rodbertus-Jagetzow. In 1836 he settled on this estate, and henceforward devoted his life chiefly to economic and other studies, taking also some interest in local and provincial affairs. After the revolution of March 1848 Rodbertus was elected member of the Prussian national assembly, in which body he belonged to the left centre; and for fourteen days he filled the post of minister of public worship and education. He sat for Berlin in the second chamber of 1849, and moved the adoption of the Frankfort imperial constitution, which was carried. When the system of dividing the Prussian electorate into three classes was adopted, Rodbertus recommended abstention from voting. His only subsequent appearance in public life was his candidature for the first North German diet, in which he was defeated. His correspondence with Lassalle was an interesting feature of his life. At one time Rodbertus had some intention of forming a "social party" with the help of the conservative socialist Rudolf Meyer and of W. Hasenclever, a prominent follower of Lassalle, but no progress was made in this. Rodbertus was neither disposed nor qualified to be an agitator, being a man of a quiet and critical temperament, who believed that society could not be improved by violent changes, but by a long and gradual course of development. He warned the working men of Germany against connecting themselves with any political party, enjoining them to be a "social party" pure and simple. He died on the 8th of December 1875.

The general position of Rodbertus was "social, monarchical and national." He held the purely economic part of the creed of the German social-democratic party, but he did not agree with their

methods, and had no liking for the productive associations with state help of Lassalle. He regarded a socialistic republic as a possible thing, but he cordially accepted the monarchical institution in his own country and hoped that a German emperor might undertake the rôle of a social emperor. The basis of the economic teaching of Rodbertus is the principle laid down by Adam Smith and Ricardo, and insisted on by all the later socialists, that labour is the source and measure of value. In connexion with this he developed the position that rent, profit and wages are all parts of a national income produced by the united organic labour of the workers of the community. Consequently there can be no talk of the wages of labour being paid out of capital; wages is only that part of the national income which is received by the workmen, of a national income which they have themselves entirely produced. The wages fund theory is thus summarily disposed of. But the most important result of the theory is his position that the possession of land and capital enables the landholders and capitalists to compel the workmen to divide the product of their labour with those non-working classes, and in such a proportion that the workers only obtain as much as can support them in life. Thus the iron law of wages is established. Hence also Rodbertus deduces his theory of commercial crises and of pauperism.

A fundamental part of the teaching of Rodbertus is his theory of social development. He recognized three stages in the economic progress of mankind: (1) the ancient heathen period in which property in human beings was the rule; (2) the period of private property in land and capital; (3) the period, still remote, of property as dependent on service or desert. The goal of the human work is to be one society organized on a communistic basis; only in that way can the principle that every man be rewarded according to his work be realized. In this communistic or socialistic state of the future land and capital will be national property, and the entire national production will be under national control; and means will be taken so to estimate the labour of each citizen that he shall be rewarded according to its precise amount. An immense staff of state officials will be required for this function. Rodbertus believed that this stage of social development is yet far distant; he thought that five centuries will need to pass away before the ethical force of the people can be equal to it.

From temperament, culture and social position Rodbertus was averse to agitation as a means of hastening the new era; and, in the measures which he recommends for making the transition towards it, he showed a scrupulous regard for the existing interests of the capitalists and landholders. He proposed that those two classes should be left in full possession of their present share of the national income, but that the workers should reap the benefit of the increasing production. To secure them this increment of production he proposed that there should be a normal working day for the various trades, a normal day's work, and a legal wage the amount of which should be revised periodically, and raised according to the increase of production, the better workman receiving a better wage. By measures such as these, carried out by the state in order to correct the evils of competition, would Rodbertus seek to make the transition into the socialistic era.

The economic work of Rodbertus is an attempt made in a temperate and scientific spirit to elucidate the evil tendencies inherent in the competitive system, especially as exemplified in the operation of the iron law of wages. The remedy he proposes is a state management of production and distribution, which shall extend more and more, till we arrive at a complete and universal socialism,—and all based on the principle that as labour is the source of value so to the labourer should all wealth belong. It is therefore an attempt to place socialism on a scientific basis; and he is certainly entitled to be regarded as one of the founders of "scientific socialism."

The following are some important works of Rodbertus: *Zur Erkenntnis unserer staatswirtschaftlichen Zustände* (1842); *Soziale Briefe* (2nd ed., 1876); "Der Normal-Arbeitstag," in *Tüb. Zeitschrift* (1878); *Letters to A. Wagner, &c.*, *Tüb. Zeitschrift* (1878-79); *Letters to Rudolf Meyer* (1882). Rodbertus has received great attention in Germany, especially from Adolf Wagner (*Tüb. Zeitschrift*, 1878); see also Kosak's *Rodbertus sozialökonomische Ansichten* (Jena, 1882); an excellent monograph by G. Adler, *Rodbertus, der Begründer des wissenschaftlichen Sozialismus* (Leipzig, 1884); Dietzel, *Karl Rodbertus, Darstellung seines Lebens und seiner Lehre* (Jena, 1886); Jentsch, *Rodbertus* (Stuttgart, 1899); and E. C. K. Gonner, *Social Philosophy of Rodbertus* (London, 1899).

RODENTIA, or GLIRES, an order of placental mammals characterized by the peculiar form and structure of their front or incisor teeth, which are reduced to a single functional chisel-like pair in each jaw, specially adapted for gnawing, and growing throughout the entire life of their owners. Rodents may be characterized as terrestrial, or in some cases arboreal or aquatic, placental mammals of small or medium size, with a milk and a permanent series of teeth, plantigrade or partially plantigrade, and generally five-toed, clawed (rarely nailed or semi-

hoofed) feet, clavicles or collar-bones (occasionally imperfect or rudimentary), no canine teeth, and a single pair of lower incisors, opposed by only one similar and functional pair in the upper jaw.

In all rodents the upper incisors resemble the lower ones in growing uninterruptedly from persistent pulps, and (except in the hare group, Duplicitadentata) agree with them in number. The premolars and molars may be rooted or rootless, with tuberculated or laminated crowns, and are arranged in an unbroken series. The orbits are always open behind, never being surrounded by bone. The condyle of the lower jaw is antero-posteriorly elongated. The intestine (except in the dormice or Gliridae) has a large caecum. The testes are inguinal or abdominal. The uterus is two-horned, with the cornua opening separately into the vagina or uniting to form a *corpus uteri*. The placenta is discoidal and deciduate. And the smooth hemispheres of the brain do not extend backwards so as to cover any part of the cerebellum.

Rodents include by far the greater number of species, and have the widest distribution, of any of the orders of terrestrial mammals, being in fact cosmopolitan, although more abundant in some parts, as in South America, which may be considered their headquarters, than in others, as in Australasia and Madagascar, where they are represented only by members of the mouse-group, or Myoidea.

All rodents are vegetable-feeders, and this uniformity in their food and in the mode of obtaining it, namely by gnawing, has led to that general uniformity in structure observable throughout the group; a feature which renders their classification difficult. Indeed, despite the fact that they present much diversity of habit—some being arboreal, as the squirrels, many of which are provided with expansions of skin or parachutes on which they glide from tree to tree; some cursorial, as the hares; others jumpers, as the jerboas; others fossorial, as the mole-rats; and others aquatic, as the beavers and water-rats—no important structural modifications are correlated with such diversity of habit.

Anatomy.—The rodent skull is characterized by the great size of the premaxilla, which completely separate the nasals from the maxillae; by the presence of zygomatic arches; and by the wide unoccupied space existing between the incisors and the cheek-teeth; and (except in the Duplicitadentata) by the antero-posteriorly elongated glenoid cavity for the articulation of the lower jaw. Post-orbital processes of the frontals exist in squirrels, marmots and hares; but in all other genera they are rudimentary or altogether absent; and the zygoma seldom sends upwards a corresponding process so that

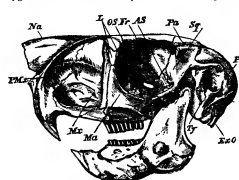

Flower, *Skull, Mammal*.

FIG. 1.—Skull of Jumping-Hare (*Pedetes caffer*).
P Mx, premaxilla; Mx, maxilla; Ma, malar; Fr, frontal; L, lacrimal; Pa, parietal; Na, nasal; Sq, squamosal; Ty, tympanic; Exo, exoccipital; AS, alisphenoid; OS, orbito-sphenoid; Per, mastoid bulla.

etals are moderate, and there is generally a distinct interparietal. The palate is narrow from before backwards, this being especially the case in the hares, where it is reduced to a mere bridge between the premolars; in others, as in the rodent-moles (*Bathyerginae*), it is extremely narrow transversely, its width being less than that of one of the molar teeth. Tympanic bullae are always present and generally large; in some genera, as in the gerbils (*Gerbillinae*) and jerboas (*Jaculidae*), there are supplemental mastoid bullae which form great

hemispherical bony swellings at the back of the skull (fig. 1, *Per*), in these genera and the hares the meatus auditorius being tubular and directed upwards and backwards. The lower jaw is characterized by its abruptly narrowed and rounded front part supporting the pair of large incisors, as well as by the small size of the coronoid process, and the great development of the lower hind, or angular, portion.

The dental formula varies from $i. \frac{1}{1}, c. \frac{0}{0}, p. \frac{0}{0}, m. \frac{0}{0}$ (total 28) in the hares and rabbits to $i. \frac{1}{1}, c. \frac{0}{0}, p. \frac{0}{0}, m. \frac{0}{0}$ (total 12) in the Australian water-rats; but in the great majority of species it presents striking uniformity, and may be set down typically as $i. \frac{1}{1}, c. \frac{0}{0}, p. \frac{1}{1}$ or $i. \frac{1}{1}, c. \frac{0}{0}, p. \frac{1}{1}$ or $i. \frac{1}{1}, c. \frac{0}{0}, p. \frac{1}{1}$.

In the Duplicitadentata only is there more than a single pair of incisors, and in these the additional pair is small and placed behind the middle pair. In this group the enamel extends partially to the back of the incisors, but in all the rest it is restricted to the front surface, so that, by the more rapid wearing-away of the softer structures behind, a chisel-shaped edge is maintained. Both upper and lower incisors are regularly curved, the upper ones slightly more so than the lower; and, their growth being continuous, should anything prevent the normal wear by which their length is regulated—as by the loss of one of them, or by displacement owing to a broken jaw or other cause—the unopposed incisor may gradually curve upon itself until a complete circle or more has been formed, the tooth sometimes passing through some part of the animal's head. The cheek-teeth may be either rooted or

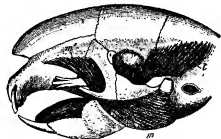

FIG. 2.—Skull of Porcupine (*Hystrix cristata*), with muscle attached. *i*, temporal muscle; *m*, masseter; *m*, portion of masseter transmitted through the infra-orbital foramen, the superior maxillary nerve passing outwards between it and the maxilla.



FIG. 3.—Vertical and Longitudinal Section through the Skull of the Beaver (*Castor fiber*), showing the brain-cavity, the greatly developed plates of bone in the nose-cavity, the mode of implantation of the ever-growing chisel-edged incisor, and the curved rootless cheek-teeth.

rootless, and either cusped or formed of parallel-plates, this diversity of structure often occurring in the same family. When there are more than three cheek-teeth, those which precede the last three have succeeded milk-teeth, and are premolars. In some species, as in the agoutis (*Dasyproctidae*), the milk-teeth are long retained, while in the allied cavies (*Caviidae*) they are shed before birth.

The tongue presents little variability in length, being short and compressed, with a blunt tip, which is never protruded beyond the incisors. In most species there are three circumvallate papillae at the base, and the apical portion is generally covered with small thread-like papillae, some of which in the porcupines become greatly enlarged, forming toothed spines. The stomach varies in form from the simple oval bag of the squirrels to the complex ruminant-like organ of the lemmings. In the water-rat and agoutis it is constricted between the oesophagus and pylorus; while in the dormouse the oesophagus immediately before entering the stomach is much dilated, forming a large egg-shaped bag with thickened glandular walls; and in certain other species, as in *Lophiomys* and the beaver, glandular masses are attached to and open into the cardiac or pyloric pouches. All rodents, with the sole exception of the dormice, have a caecum, often of great length and sacculated, as in hares, the water-rat and porcupines; and the long colon in some, as the hamster and water-rat, is spirally twisted upon itself near the commencement. The liver is divided in the typical manner in all, but the lobes are variously subdivided in different species (in *Copromys* they are divided into minute lobules); and the gall-bladder, though present in most, is absent in a few. In most species the penis (which is generally provided with a bone) may be more or less completely retracted within the fold of integument surrounding the vent, and lie curved backwards upon itself under cover of the integument, or it may be carried forward some distance in front of the anal orifice, from which, as in voles and marmots,

in the breeding-season, it is separated by the prominent testicular mass. The testes in the pairing-season form projections in the groins, but (except in the Duplicitantata) do not completely leave the cavity of the abdomen. Prostate glands and, except in the Duplicitantata, vesicular seminales are present in all. The uterus may be double, each division opening by a separate os uteri into a common vagina, as in *Leporidae*, *Sciuridae*, and *Hydrochoerus*, or two-horned, as in most species. The teats vary in number from a single abdominal pair in the guinea-pig to six thoraco-abdominal pairs in the rats; while in the *Oxidontidae* and *Capyromyidae* they are placed high up on the sides of the body.

There are generally nineteen dorso-lumbar vertebrae (thirteen thoracic and six lumbar), the form of which varies in different genera; in the cursorial and leaping species the lumbar transverse processes are generally very long, and in the hares there are large compressed inferior spines, or hypophyses. The caudal vertebrae vary from a rudimentary condition in the guinea-pig to a great size in the jumping-hare and prehensile-tailed porcupines. The scapula is usually narrow, with a long acromion; the clavicles may be altogether absent or imperfect, as in porcupines, cavies and hares, but in most species are well developed. The humerus has no supra-condylar foramen, and the forelimb bones are distinct; and in most species the fore foot has five digits with the phalanges normally developed, the first toe being but rarely rudimentary or absent. The pelvis has large ischia and pubes, with a long and usually bony symphysis. The femur varies considerably in form, but generally has a well-defined third trochanter. In the squirrels and porcupines the tibia and fibula are distinct, but in rats and hares they are united, often high up. The hind foot is more variable than the front one, the digits varying in number from five, as in squirrels and rats, to four, as in hares, or even three, as in the capybara, viscacha and agouti. In the *Jaculidae* the metatarsals are greatly elongated, and in some of the species, as jerboas, they are welded together.

The mouth is divided into two cavities communicating by a narrow orifice, the anterior one containing the incisors and the posterior the molars, the hairy skin of the face being continued inwards behind the incisors. This evidently prevents substances not intended for food getting into the mouth, as when the animal is engaged in gnawing through an obstacle. In hares and pacas the inside of the cheeks is hairy; and in some species, pouched rats and hamsters, there are large internal cheek-pouches lined with hair, which open near the angles of the mouth and extend backwards behind the ears. In the New World pouched rats (*Geomysidae*) the pouches open externally on the cheeks.

The perineal furrow evolves in many rodents into the secretions of special glands, which may open into the prepuce, as in *Mus*, *Microtus* and *Cricetus*, or into the rectum, as in *Arctomys* and *Thryonomys*, or into the passage common to both, as in the beaver, or into pouches opening near the vent, as in hares, agoutis and jerboas.

The skin is generally thin, and the panniculus carnosus muscle rarely much developed. The fur varies exceedingly in character,—in some, like the chinchillas and hares, being fine and soft, while in others it is more or less replaced by spines on the upper surface, as in spiny rats and porcupines; these spines in several genera, as *Xerus*, *Acornys*, *Platacanthomys*, *Echinomys*, *Lonchoceros* and *Echinomys*, being flattened. In muscular structure the chief peculiarities are noticeable in the comparatively small size of the temporal muscles, and in the great double masseters (fig. 2), which are the principal agents in gnawing. The digastric muscles also are remarkable for their well-defined central tendon, and in many species their anterior bellies are united between the two halves of the lower jaw. The cleido-mastoid generally arises from the basi-occipital, and the pectoralis major is connected with the latissimus dorsi. In porcupines and hares the tendons of the flexor digitorum longus and flexor hallucis longus are connected in the foot, while in the rats and squirrels they are separate, and the flexor digitorum longus is generally inserted into the metatarsal of the first toe.

Classification.—Some diversity of view obtains among naturalists with regard to the classification of the order; the scheme here followed being the one adopted (with some modifications of nomenclature) by Professor Max Weber in his *Säugethiere*. The number of genera is so great that only the more important can be noticed. All authorities are agreed in dividing rodents into two great sections or sub-orders, the one, *Duplicidentata*, comprising only the hares, rabbits and picas, and the other, *Simplicidentata*, all the rest. In the latter there is only one pair of incisor teeth in the upper jaw, in which the enamel is confined to the front surface. The incisive foramina of the palate are moderate and distinct; the fibula does not articulate with the calcaneum; and the testes are abdominal, and descend periodically only into the inguinal canal.

Sewellids.—The first family is represented by certain peculiar North American rodents known as sewellids, constituting the genus

Haplodon (or *Apodon*) and the family Haplodontidae and section Haplodontoidea. In common with the next three sections these rodents have the angular process of the lower jaw (fig. 4) arising from the inferior surface of the socket of the incisor. The masseter

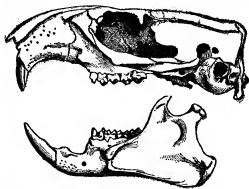

FIG. 4.—Skull of the American Marmot (*Arctomys marmota*). The projection at the right-hand lower corner of the figure is the angular process of the lower jaw.

muscle does not pass through the narrow infra-orbital canal. An alisphenoid canal may be present on the palatal aspect of the skull; but there is always a transverse canal. The malleus and incus of the inner ear are separate. The humerus often has a foramen (entepicondylar) on the inner side of its lower end; the tibia and fibula may be separate or united; but the scaphoid and lunar of the carpus are also united, while the centrale is free. The stomach is simple.

Sewellids are medium-sized terrestrial rodents, with no post-orbital process to the skull, which is depressed in form, and rootless cheek-teeth, among which the premolars number 1, the first in the upper jaw being very small. The build is stout and heavy, the limbs and tail are short, the ears moderate, the eyes minute and the feet five-toed and plantigrade. *Haplodon* is represented by a small number of species in America west of the Rocky Mountains, of which *H. rufus* is the longest known. They are burrowing, and, in some cases at any rate, partially aquatic rodents.

Squirrels Group.—The Sciuroidea, which include the great group of squirrels, souseiks, marmots, &c., all comprised in the single family Sciuridae, differ from the sewellids in having large post-orbital processes to the skull (figs. 4, 5, 6); and, with one exception, have rooted cheek-teeth, the pre-molar-formula being 2.1.1. The infra-orbital foramen is also narrower, and the tympanic bulla is cellular. In both groups the tibia and fibula are separate.

The family is divided into three sub-families, the first of which is the Sciurinae. In this the crowns of the molars are more or less shortened, with their cusps either arranged in longitudinal lines, or forming four upper and three lower more or less distinct oblique ridges. The post-orbital processes of the frontal and jugal are widely sundered, and the former may even be small (*Xerus*). The expanded anterior root of the zygomatic process has its front border oblique. According to modern views the sub-family is broken up into a large number of genera.

The first of these is *Rhithrosciurus*, represented by one large species (*R. notatus*) from Borneo, characterized by its finely grooved incisors (see GROOVE-TOOTHED SQUIRREL). The second genus, *Heterosciurus*, includes arboreal African squirrels, typified by *H. stangeri*, allied in the characters of their skulls to the under-mentioned *Xerus*, and with a very large pre-orbital foramen in the more typical forms. The third, *Funisciurus*, of which *F. pyrrohobus* is a well-known example, is also African and allied to *Xerus*, but has a still longer skull and soft fur. In *Xerus* itself, which is represented by the terrestrial African spiny squirrels, the ears are short, there are only two teats, and flat spines are mingled with the fur; while the skull, and more especially the frontals, is elongated, with a very short post-orbital process, and the crowns of the molars are taller than usual (see SPINY SQUIRREL). The well-known Indian palm-squirrel, *Funambulus palmarum*, typifies an Indo-Malay genus allied to *Xerus* in skull-characters but with molars more like those of *Sciurus*. In contrast to these small striped species are the giant squirrels of the same region, such as *Ratufa indica* and *R. bicolor*, which are very brightly coloured rodents, with *Sciurus*-like skulls (fig. 5) but extremely short-crowned molars, and only one pair of upper premolars. Next comes the typical *Sciurus*, including the great bulk of the entire group, and ranging over Europe, Asia, North Africa and America. The skull is short and broad, especially as regards the frontals, with large post-orbital processes (fig. 5), and very generally two upper premolars, making a total of five pairs of upper cheek-teeth, which have crowns of medium height. The teats are either four or six. Squirrels of this and the other arboreal groups have the bodily form slender and agile, the tail long and bushy, the ears well developed, pointed and often tufted; the feet adapted for

climbing, the anterior pair with four toes and a rudimentary thumb, and the posterior pair with five toes, all the toes having long, curved and short-pointed claws (see SQUIRREL). The names *Glyphotes* and

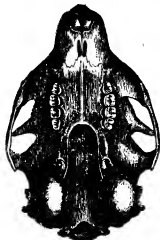

FIG. 5.—Under Side of Skull of the Malay Giant Squirrel (*Ratsufa bicolor*).



FIG. 6.—Under Side of Skull of Prairie-Marmot (*Cynomys ludovicianus*).

Sciurotamias have been proposed respectively for one Bornean and some four Chinese squirrels. With *Tamias* (sometimes split into *Tamias* and *Eutamias*) we reach the North American striped ground-squirrels, or chipmunks, well characterized by the large internal cheek-pouches, with one outlying species in Northern Asia and Europe (see CITTUS-SQUIRREL). These lead on to the sousliks, *Spermophilus* (or *Geomys*), in which the incisors (as in the following genera) differ from those of all the squirrels in not being compressed. The genus which is common to the northern parts of both hemispheres is distinguished by the large cheek-pouches and by the absence or rudimentary condition of the claw of the first hind-toe, resembles *Tamias* in the slender form of the body, but displays great variation in the length of the tail, which may be a mere stump, or comparatively long. As in the following genera, there are two pairs of premolars, of which the first in this case is small and rounded, while the two series of cheek-teeth are nearly parallel (see SOUSLIK). The prairie-dogs, or prairie-marmots, *Cynomys*, are a North American group, in which the five-toed forefeet have the claw of the first as large as that of the fifth toe. The skull is heavily built, with the post-orbital processes directed outwards. Dentition (fig. 6) remarkably heavy, the molar teeth differing from those of *Spermophilus* and *Arctomys* by having three instead of two transverse grooves on their crowns. First premolar nearly as large as the second. Molar series strongly convergent behind (see PRAIRIE-MARMOT). Finally, we have the marmots (*Arctomys*), which are larger and more heavily built rodents, with short ears, more or less short tails and rudimentary or no cheek-pouches. Fore-feet with the first toe rudimentary and bearing a flat nail. Skull (fig. 4) large and heavy, with the post-orbital process stouter and at right angles to the axis. Incisors broad and powerful. First upper premolar nearly as large as the second. Molar series nearly parallel, scarcely converging behind at all.

The genus is common to the northern half of both hemispheres, and its members, like those of the two preceding groups, burrow and hibernate (see MARMOT).

The Nannosciurinae, or second sub-family of Sciuridae, are represented only by the pigmy squirrels (*Nannosciurus*), characterized by their very short-crowned molars (which approximate to those of dormice in structure) and small premolars, of which the first upper pair is often deciduous, while the upper molars have only three oblique ridges. The front root of the zygomatic arch is nearly vertical, and placed so far back that it is above the second molar, while the orbit—a unique feature among rodents—is almost completely surrounded by bone. The few representatives of this group are all very small rodents, confined to tropical Africa, the Philippines and the Malay islands.

The third and last sub-family, the Pteromyinae, is distinguished from the other two by the presence of a parachute-like fold of skin along the sides of the body, the supporting cartilage of which arises from the carpus or wrist. It includes *Sciuropterus*, represented by small species from the northern parts of both hemispheres; *Pteromys*, comprising large flying-squirrels, ranging from India and the Malay countries to Japan, characterized by the long cylindrical tail and large inter-femoral membrane; and *Elaptesurus*, represented by one very large dark grey, long-tailed and long-haired species from Astor and Gilgit, which differs from all other members of the family by its tall-crowned cheek-teeth (see FLYING-SQUIRREL).

Beavers.—The second section, Castoroidea, of the present group includes only the family Castoridae, represented by the beavers, which are large aquatic rodents characterized by their massive skulls, devoid of post-orbital processes, with the angle of the lower jaw rounded, the molars rootless or semi-rooted, with re-entering enamel-folds, and one pair of premolars above and below. The tibia and fibula are united inferiorly, the tympanic bulla is hollow and the infra-orbital foramen narrow. The single existing genus is the European beaver, *Castor fiber*, of Europe and Northern Asia, and the North American *C. canadensis*. The upper molars are subequal, each with one internal and two external enamel-folds; the stomach has a large glandular mass situated to the right of the oesophageal orifice; the anal and urino-genital orifices open within a common cloaca; the tail is broad, horizontally flattened and naked; and the hind-feet are webbed (see BEAVER).

Pouched Rats.—The American pouched rats, or pocket-gophers, constitute the third section, Geomyoidea, with the single family Geomyiidae. The dentition includes one pair of premolars above and below, and rooted or rootless molars with but few enamel-folds. In the skull the infra-orbital foramen is narrow, and post-orbital processes and an alisphenoid canal are absent. The tibia and fibula are united. The cheeks are provided with large pouches opening externally. Two sub-families are recognized. The first of these, or Geomyiinae, is characterized as follows: Incisors broad; masticoid not appearing on the top of the skull; eyes small; ears rudimentary; limbs short, subequal. Habits fossorial. *Geomys bursarius*, the red pocket-gopher of North America, with deeply grooved incisors, inhabits the plains of the Mississippi, living in burrows like the mole. Several other species from the Southern States, Mexico and Central America are recognized. *Thomomys talpoides*, with plain incisors, extending from Canada to the United States west of the Rocky Mountains, typifies the second genus, which has also many species. The following are the characters of the second sub-family, Heteromyiinae: Incisors narrow; masticoid appearing largely on the top of the skull; eyes and ears moderate or large; hind-limbs and tail elongated. Habits terrestrial. *Dipodomys*, which has the molars rootless, is typified by *D. philippi*, the kangaroo-rat of the desert regions east of the Rocky Mountains, and *Microtodipodops* being another genus. *Perognathus* and *Heteromys* have rooted molars; the latter genus is distinguished by the presence of flattened spines among the fur, and has species extending into South America. (See POCKET-GOPHER, POCKET-MOUSE and KANGAROO-RAT.)

Scaly-tailed Squirrels.—The next section, according to Prof. Max Weber's arrangement, is that of the Anomaluroidea, typified by the rodents commonly called African flying-squirrels (*Anomaluridae*), but better designated scale-tailed squirrels, or simply "scaly-tails," since one member of the family has no parachute. To this group Prof. H. Winge affiliates the African jumping-hares (*Pedetes*), a view which is adopted by Prof. Fisher, although Mr O. Thomas places these rodents in the neighbourhood of the porcupines. In the more extended sense, the Anomaluroidea are diagnosed as follows: In the skull the infra-orbital foramen (or canal) is large, the lachrymal foramen placed high up, and no transverse canal; while the malleus and incus of the internal ear are fused. In the carpus the scaphoid and lunar bones are united. There is a single pair of premolars in each jaw.

The Anomaluridae are characterized by having rooted cheek-teeth with shallow transverse enamel-folds, the two halves of the lower jaw movably articulated in front, very small post-orbital processes to the skull, and the presence of two rows of scales on the under surface of the base of the tail (figs. 7 and 8), which is cylindrical and thickly haired. The family is confined to the equatorial forest-trait of Africa, where it is most numerously represented on the west side. The majority of the species belong to the typical genus *Anomalurus* (fig. 7), which is provided with a parachute supported by a cartilaginous process arising from the olecranon of the ulna, and has well-developed ears and a moderately long tail. Several of the species are considerably larger than an ordinary squirrel. *Idiurus*, as represented by the West African *I. senkeri* (figured in the article FLYING-SQUIRREL), is a mouse-like form, with very small ears and an extremely long tail. The third genus, *Zenkerella* (*Aithurus*), which is also West African, has no parachute (fig. 8).

Jumping-Hares.—The grounds for referring the African jumping-hares (*Pedetes*) to the Anomaluroidea rest largely on the evidence of certain Tertiary rodents from Europe, such as *Issodoromys*. The family is represented by the South African *Pedetes caffer*, which is as large as a hare, and the smaller East African *P. surdaster*. In general habits and appearance these animals recall large jerboas, from which group they are, however, distinguished by the four pairs of rooted cheek-teeth, the premolars being as large as the molars, and the latter having one outer and one inner enamel-fold. The hind-limbs are elongated, with four toes, of which the metatarsals are separate; the tibia and fibula are welded in old age; the calcaneum and astragalus of the tarsus are elongated; and there is a perforation on the inner side of the lower end of the humerus (see JUMPING-HARE).

Dormice.—The next three sections of the order, namely, the Myoxoidea, or dormice, Dipodoidea, or jerboas, and Myoidea, or the mouse group, have the following characteristics in common. The

appearance of the pigmy squirrels (*Nannosciurus*), which in some degree connect the family with the Muridae. (See DORMOUSE.)

Jerboa Group.—The Dipodoidea, or jerboa-group, which likewise includes only a single family, Jaculidae (or Dipodidae), is characterized by the presence of not more than one pair of premolars in the upper jaw, which, however, may be wanting; by the rooted cheek-teeth, which have transverse enamel-folds, and the absence of a transverse canal in the skull, and of a horny layer in the stomach. The family is divisible into two sub-families, of which the first, or Sminthinae, is represented only by the genus *Sminthus*, containing a few species which range from Denmark into Western Asia, Kashmir and China. They are small rat-like rodents, with one pair of upper premolars, which are mere pins, as is the last molar, and the two pairs of limbs of normal length, with the metatarsals separate; the infra-orbital opening in the skull being triangular and widest below, while the incisive foramina in the palate are elongated. The European *S. incisilis* has a black dorsal stripe bordered with yellow.

The Dipodinae, on the other hand, are leaping rodents, with the metatarsals elongated, a small upper premolar present or absent, and the crowns of the molars tall. Various degrees of specialization occur in the adaptation for leaping. The least specialized genus is *Zapus*, containing the jumping-mice of North America, with one outlying Siberian species, in which the five metatarsals are free, as are also the cervical vertebrae, the small upper premolar being retained. (See JUMPING-MOUSE.)

In the other genera, so far as known, the three central metatarsals of the hind foot are fused into a cannon-bone, of a type unique among mammals and comparable to that of birds. Some of the cervical vertebrae are also united in at least the better-known genera. The tail and ears are generally very long; while, in correlation with the size of the latter, the auditory bullae of the skull are also large. In the typical jerboas, *Jaculus* (or *Dipus*), ranging from North Africa to Persia, Russia and Central Asia, there are only three hind toes, the incisors are grooved, and the premolars are generally wanting. The other genera have five toes, of which only the middle three are functional, and smooth incisors. *Euchoreutes*, with one or two Akand species, has premolars, enormous ears and a long nose. *Arctaga*, ranging over Russia and Western and Central Asia, inclusive of Persia and Baluchistan, has smaller ears and a shorter nose; by some naturalists it is taken to include the North African *A. tetradactylus*, which is separated by others as *Scarturus*. The Turkestan *Platyxeromys* (or *Fygeretmus*) has a lancet-shaped tail and no premolars; while *Cardiocranus* of the Nan-shan district of Central Asia has a similar type of tail, but short ears and a peculiarly triangular skull. (See JERBOA.)

Mole-Rats.—The mole-rats (Spalacidae) bring us to the mouse-like section, or Myoidea, in which there are no premolars and the molars may be occasionally reduced to 2; these teeth being either rooted or rootless, with either cusps or enamel-folds, and the first generally larger than the second. In the skull the zygomatic arch is slender and the jugal bone small and not extending far forwards, being supported by the long zygomatic process of the maxilla, while the infra-orbital foramen is mostly large, and there are no post-orbital processes. Although sometimes short, the tail is generally long, sparsely haired and scaly. The cardiac portion of the complex stomach has a horny layer, and there is a caecum.

The Spalacidae are burrowing types, allied apparently to the ancestral Jaculidae, and characterized by the second and third molars being equal in size, the presence of enamel-folds in all these teeth, and the superiority in size of the claws of the second, third and fourth front toes over the other two. All these "rodent-moles" are thoroughly adapted to a subterranean life, the eyes and ears being small and rudimentary, as is also the tail; while the bodily form is cylindrical, and the front claws are very large and powerful. The incisors are very large; and the palate of the skull is narrow. The typical representative of the group is the great mole-rat (*Spalax typhlus*) of Eastern Europe and North-East Africa, which, together with a few closely allied species, has the eyes completely buried in the skin, and the head much flattened.



From Alston.

FIG. 7.—Red Scaly-tailed Squirrel (*Anomalurus fulgens*).

of the lower jaw has the same relations as in the sewellels and the allied groups. The lachrymal foramen in the skull is low down and forms an elongated slit. In the carpus the scaphoid and lunar are welded, but the centrale remains distinct. The tibia and fibula are fused at their upper and lower ends. The malleus and incus of the inner ear are separate. Except in *Lophiomys*, the clavicles are complete. The infra-orbital foramen of the skull (fig. 9) is more or less broad; and there is generally a transverse canal. The stomach is generally complex.

In the dormice, forming the section Myoxoidea, with the single family Gliiridae (or Myoxoidea), a single pair of premolars may or may not be present; the molars are short-crowned and rooted, with transverse enamel-folds. The angle of the lower jaw is twisted and its coronoid process slender. Dormice are a

From de Winton.

FIG. 8.—Zenker's Scaly-tailed Squirrel (*Zenkerella insignis*).

small arboreal rodents, with long hairy tails, large eyes and ears, and short fore-limbs, ranging over Europe, Asia and Africa. Of the four genera in the typical sub-family Gliirinae, the first is *Glis*, represented by *Glis vulgaris* (or *G. glis*) of Europe, with a doubly vaneed, bushy tail, simple stomach, and large molars with well-marked enamel-folds; the second, *Muscardinus*, with *M. ocellarius*, the common dormouse, distinguished by the cylindrical bushy tail, and thickened glandular walls of the cardiac extremity of the oesophagus; thirdly, *Elomys*, containing several species, with tufted and doubly vaneed tails, simple stomachs and smaller molar teeth, having concave crowns and faintly marked enamel-folds; and lastly, the African *Graphiurus*, represented by several species, with short cylindrical tails ending in a pencil of hairs, and very small molars almost without trace of enamel-folds. None of the members of the typical sub-family extend into India, where the group is represented by *Platacanthomyi*, typifying the sub-family Platacanthomyiinae, characterized by the absence of premolars; the other being the Chinese *Typhomys*. These are small rodents with somewhat

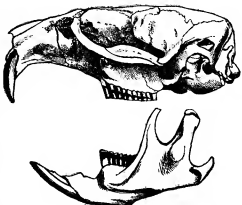
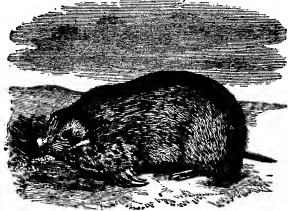

FIG. 9.—Skull of the Muskrat (*Fiber sibiricus*). Natural size.

In the bamboo-rats, *Rhizomys*, from the Indo-Malay countries, China and Tibet, as well as in the closely allied East African *Tachyoryctes*, the eyes are, however, functional, and the head is rounded. (See MOLE-RAT.)

According to the arrangement here followed, the burrowing zokors may be placed in this family, although they have teeth like those of the vole group in the Muridae. The first representative of this sub-group is the genus *Siphneus* (or *Myotalpa*), of which some five Central and North Asiatic species are known. They are characterized by the mole-like form and long, powerful, front claws (fig. 10). In the true zokors (*Ellobius*), on the other hand,



From Milne-Edwards.

FIG. 10.—The Tibetan Zokor (*Siphneus armandi*).

the claws are short and the general form more vole-like. Of three named species, one extends from South Russia to Siberia, while two others are respectively from Kurdistan and Afghanistan. A third type, *Prometheomys*, from the Caucasus, is represented by a species of the size of a small water-rat, chestnut-brown in colour, with lighter feet, and the minute eyes covered with skin. The teeth are nearest to those of the true zokors (*Ellobius*). The single example was taken under flowering anemones.

Madagasy Rats.—On account of certain structural peculiarities, the rats of Madagascar, which have a dentition like that of the cricetine Muridae, are separated as a distinct family, Nesomyidae. They are the only rodents in that island. Of these, *Hypogeomys* is a large, long-tailed, fawn-coloured rat, with large ears and feet; *Nesomys* is a red species, with long hair; *Brachytarsomys* is short-footed and long-tailed, with velvety fawn fur; *Hallomys* has elongated hind feet, as has also *Macrotarsomys*; *Gymnoromys* is naked-tailed; and the several species of *Elurus* are dormouse-like.

Mouse Tribe.—The characteristics of the Muridae are those of the Myoidea generally, as given above under the heading of the Spalacidae. With the exception of Madagascar, the family, which may be divided into six sub-families, has a cosmopolitan distribution, and the genera are so numerous that only some of the most important can be even mentioned.

The first group is that of the hamsters, or cricetines (Cricetinae), in which the molars are rooted and tuberculated, with the cusps of the upper ones arranged in two longitudinal rows (fig. 13, B); in the upper teeth the outer cusps and in the lower the inner ones are the higher, and when worn the crown surfaces show oblique dentine-areas; in shape the third molar is like the second, but it is smaller. The infra-orbital foramen is generally narrow, and the tympanic bulla hollow. The humerus has a foramen at the lower end. The tail is short. The group is typified by the European hamster (*Cricetus vulgaris* or *C. cricetus*), to which a separate article is devoted (see HAMSTER); the genus includes a number of species ranged under several sub-genera, such as *Mesocricetus*, *Cricetus*, and *Urocrietus*, widely spread in Western and Central Asia, the last-mentioned, which is from Tibet, being distinguished by its relatively long tail. The hamsters all possess cheek-pouches, which are, however, absent in many of the following genera. Africa claims only a single representative of the group, *Mysromys*, with one southern and one eastern species. Persia is the home of *Colomyscus* (with one species), a near relative of the American *Peromyscus*. In America, where the more typical kinds are known as white-footed, or deer, mice, the cricetines absolutely swarm, and include a host of genera, the majority of which are North American, although others are peculiar to Central and South America. Among these may be named *Onychomys*, *Peromyscus*, *Rhipidomys*, *Holochilus* (which is South American and includes the largest species), *Stigmodon* (typified by the North American rice-rat, *S. hispidus*), *Oryzomys*, *Rhithrodontomys* (with grooved incisors), *Ichthyomys* and *Anotomys* (fish-eating, aquatic forms, from the mountains of South America), *Acodon*, and the North American wood-rats, or *Neotoma*, in which the

molars have a structure simulating that of the under-mentioned Microtinae. A distinct sub-family, Lophomyiinae, is represented by the Central African arboreal spiny rats, *Lophomys*, of which there are two or three species. Although agreeing with the Cricetinae in



From Milne-Edwards.

FIG. 11.—African Spiny Rat (*Lophomys imhausi*).

the hollow tympanic bullae, they have the clavicles imperfect, the first front toe opposable to the rest, the temporal region of the skull roofed with bone, and the crowns of the molars with cusps arranged in rows but eventually covered by a layer of enamel.

The third sub-family is that of the Microtinae, or voles, which are distributed all over Europe, Northern Asia and North America, and are characterized by the tympanic bulla of the skull being filled with honey-combed bony tissue, the small size of the infra-orbital foramen, and the deep pterygoid fossa on the palatal aspect. The humerus lacks a foramen at the lower end; and the molar teeth, as explained and illustrated in the article VOLE (*q.v.*), consist of two longitudinal rows of triangular alternating vertical prisms, and may be either rooted or rooted. Voles, as typified by the water-rat and the tailed field-mouse, are stouter built and shorter-nosed rodents than the typical rats and mice, with smaller ears and eyes and shorter tails; all being good burrowers. In the circumpolar *Eutamias* (represented in England by the red-backed field-mouse) and the nearly allied North American *Phenacomys*, the molars develop roots in old age; but in *Microtus* (which includes the water-rat, and is circumpolar) they are rootless throughout life, the genus being one of the largest in the mammalian class (see VOLE). *Fiber*—the muskrats—is a North American aquatic type (see MUSKRAT), characterized by the compression of the tail. *Synaptomys* is also North American, and characterized by the grooved



After Gould.

FIG. 12.—The Australian Brown-footed Rat (*Mus fuscipes*).

upper incisors and the presence of distinct enamel-loops on the outer side of the lower molars. The circumpolar lemmings of the genera *Lemmus* and *Dicrostonyx* are noticed in the article LEMMING. *Ellobius*, which many naturalists place in this group, has been mentioned among the Spalacidae.

The typical rats and mice, together with their nearest relatives, constitute the sub-family Murinae, which is represented by more than three hundred species, distributed over the whole of the Old World except Madagascar. The molars (fig. 13, A) are rooted



FIG. 13.—Upper Molars of *Mus* (A) and *Cricetus* (B).

and have a plate-like structure, with the cusps or tubercles forming three longitudinal rows in those of the upper jaw, but only two distinct ones in the lower. By this structure the Murinae are broadly distinguished both from the Cricetinae (fig. 13, B) and the Microtinae. In the skull the tympanic bulla is hollow, the pterygoid fossa shallow and the zygomatic arch slender, with a rudimentary jugal bone. The tail is long and scaly (fig. 12). The genus *Mus*, with about a couple of hundred species, includes the true mice and rats (see MOUSE and RAT), and has the typical characters of the group, the incisors being narrow and smooth, the molars small, the eyes and ears large and the tip of the muzzle naked. In some cases there may be spines among the fur. None are much larger than the brown rat (*M. norvegicus*) or smaller than the harvest mouse; and they all have habits generally similar to those of one or other of the English species, although some live in trees like the squirrel, or in the water like the latter being the brown-footed rat (*M. fuscipes*) of western and southern Australia (fig. 12). The genus *Nesocia* is like *Mus*, but with the incisors and molars broader, and the transverse laminae of the latter more clearly defined. This genus contains a few clumsily built rats spread over Southern Asia from Palestine to Formosa, and from Kashmir to Ceylon (see BANDICOOT-RAT). Among other important genera *Cricetomys* and *Eosacomys* (both African) stand apart by the possession of cheek-pouches; *C. gambianus* being a very large species. The Java *Ptilochirus* has the thumb opposable, while the Papuan *Chiruromys* has the tip of the tail naked above and prehensile. The spiny mice, *Acomys* (or *Acanthomys*), of Western Asia, Cyprus and Africa, take their name from the fur being almost entirely replaced by flattened spines, and are further distinguished by the rudimentary coronoid process of the lower jaw. *Dasyomys* is an allied African genus; while *Aricanthis* includes the African striped mice. *Golunda*, from India and Africa, is like *Mus*, but with grooved upper incisors. *Vandeleuria*, ranging from India to Yunnan, has flat nails on the first five toes, and a very long tail; while the Indo-Malay *Cratogeomys* has a flat nail on the first toe of both feet and a tufted tail. In the Philippines occur the peculiar genera *Batomys*, *Carpomys* and *Crateromys*, confined to the mountains of Luzon, the third remarkable for its huge size and long hair. *Mastacomys* is like *Mus*, but with the molars remarkably broadened, and with only four teeth. The single species is from Tasmania, though it has been found fossil in New South Wales; it is somewhat similar in size and appearance to the English water-rat, but has longer and softer fur. *Uromys* differs from *Mus* in having the scales of the tail not overlapping, but set edge to edge, so as to form a sort of mosaic work. There are several species, spread over the northern part of the Australian region from the Aru Islands to Queensland. *Echinothrix* is a rat with an extremely elongated muzzle, all the bones of the face being much produced, and the incisors faintly grooved, the only species, *E. leucura*, being about the size of the common rat, with its fur thickly mixed with spines, a native of Celebes. Australia is the home of the group of jumping species, known as jerboa-rats, characterized by the elongation of the hind limbs, arranged under the genera *Neotomomys*, *Dipodillus*, *Ammomys* and *Contarius*, distinguished from one another by the structure of the molars and the number of teeth and foot-pads, the second being further characterized by its long ears.

The large-eared African *Otomys* and the allied *Oreomys* (*Oreomys*), often made the type of a distinct sub-family, may be included in this section; as well as the small African tree-mice, *Dendromys*, allied to which is *Deomys*, peculiar in the circumstance that only the first molar has three rows of cusps, the other two having only a couple of such rows, as in cricetines. Other allied African genera are *Stenomys* and *Lophuromys*, which include several species of smaller mouse-like rodents, with the habits of dormice generally, though some burrow in cornfields. Here also may be noticed the huge Philippine long-haired rats of the genus *Phlaeomys*, characterized by their broad incisors, transversely laminated molars and large claws. They are often regarded as forming a sub-family by themselves. The gerbils, which are widely distributed over the more or less desert-like regions of the Old World exclusive of the Malay countries and Australia, form the sub-family Gerbillinae. They have long hind limbs, large eyes and ears; and in correlation with the latter an enlarged auditory bulla to the skull, which is hollow and fits into a tympanic and a mastoid portion. The tail is generally long and hairy. There are three pairs of rooted molars, whose crowns carry transverse plates, decreasing in number from three in the first to one in the last tooth.

Gerbillus (or *Tatera*), with a large number of species, has a range coextensive with that of the sub-family; *Pachyromys*, with two African species, has a short club-shaped tail and enormous auditory bullae; while the remaining members of the group, which are confined to North Africa, Eastern Europe and Asia, are arranged in the genera *Meriones*, *Psammomys* and *Rhombomys*, the latter represented only by *R. opimus* from Russia and Central Asia (see GERBIL).

The last representatives of the Muridae are confined to Australasia and the Philippines, and constitute the sub-family Hydromyinae, characterized by the very general presence of only two pairs of molars in each jaw. In the typical Australian and Papuan *Hydromys*, locally known as water-rats, the molars originally have transverse ridges, the enamel folds between which form cutting edges whose sharpness depends upon the degree to which the teeth have been worn, while the large hind feet are webbed. The typical *H. chrysogaster* is a large brown rat with an orange belly, which feeds on small fishes and insects. *Limnomys*, from New Guinea, is a type less specialized for swimming, the hind-feet being much less twisted than in *Hydromys*, and not so fully webbed. Still less specialized are *Chrotomys* and *Xeromys*, which include Philippine land-rats, and thus *Crunomys*, from the same area, retains the third molars, and thus connects the group with the Murinae.

Finally, the Philippine *Rhynchomys* is represented by a rat with two pairs of molars and a long shrew-like nose, the zygomatic arch of the skull being also placed unusually far backward.

Strand-Moles.—With the so-called strand-moles of South Africa, forming the section Bathygeroidea, and the family Bathygeridae, which were formerly placed with the Spalacidae, we come to the first of two sections in which the lower jaw has a totally different form to that obtaining in all the preceding groups. In the rodents now to be considered, the angular process of the lower jaw arises from the outer side of the sheath of the incisor. The malleus and incus of the internal ear are united, and there is no transverse canal in the skull. At least one pair of premolars is present in each jaw; and these teeth and the molars typically have one outer and one inner enamel fold. There is no foramen at the lower end of the humerus, and no horny nail on the stomach.

In the Bathygeroidea the scaphoid and lunar of the carpus are separate, the tibia and fibula united and the clavicles normal. The masseter muscle does not pass through the narrow infra-orbital canal, and the temporal muscle is large. All the Bathygeridae are African, and adapted to a burrowing life, having minute ears and eyes, a short tail and the thumb armed with a large claw. The largest species represents the genus *Bathyergus*, while several smaller kinds are included in *Georchus*. The former constructs its tunnels in the sandy flats near the shore at the Cape, but the latter generally frequent higher ground. In both genera there is only a single pair of premolars in each jaw, but in the smaller *Myoscalops* there are usually three pairs of these teeth. The most remarkable members of the family are the sand-rats of Somaliland and Shea, forming the genera *Heterocephalus* and *Fornarina*, in which the premolars may be reduced to two pairs. They have large heads, projecting incisors, no ears, almost functionless eyes and moderately long tails; the skin, with the exception of a few hairs on the body and fringes on the feet, being naked. They spend their whole time buried in the hot desert sand, in which they construct burrows, throwing up at intervals small hillocks.

Porcupines.—In the second section, or Hystricoidae, including several families, the skull (fig. 14) is characterized by the heavy

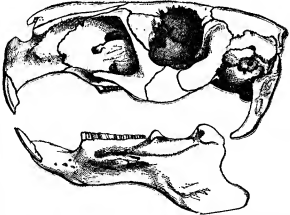

FIG. 14.—Skull of the Capybara (*Hydrochaeris capybara*), reduced.

zygomatic arch, the middle portion of which is formed by the more or less straight and horizontal jugal, and the large infra-orbital canal, traversed by a portion of the masseter muscle. The tibia and fibula are separate, but the scaphoid and lunar are united, and the clavicles are generally incomplete. There is a few hairs

than one pair of premolars, and the original ridges of all the cheek-teeth have become obscured and complicated by the development of secondary enamel-folds. The majority of these rodents, many of which are of large size, are terrestrial, but a few are burrowing, others arboreal and two or three aquatic.

The Old World porcupines, constituting the family Hystricidae, are terrestrial, stoutly built rodents, with limbs of subequal length in front and behind, and the skin covered with strong spines. The upper lip is cleft, the jugal lacks an inferior angle, the fore part of the skull is short and broad; the cheek-teeth are partially rooted, with external and internal enamel-folds, the soles of the feet are smooth, there are six pairs of teats, the clavicles are imperfect and the tail is not prehensile. In the typical genus *Hystrix*, which



FIG. 15.—The Brazilian Tree-Porcupine (*Syntheres* (or *Coendou*) *prehensilis*).

is represented in all the three great continents of the Old World, and extends as far east as Flores and Celebes, the skull is swollen and convex, the spines are cylindrical, and the tail is short and covered with spines and slender-stalked open quills. In *Atherura fasciculata* of the Malay Peninsula the spines are flattened, and the tails long and scaly, with a tuft of compressed bristles. A closely allied species, *A. africana*, inhabits Western Africa. The third genus is *Trichys* (see PORCUPINE).

American Porcupines.—All the New World porcupines, representing the family Erethizontidae (or Cœndidae) are arboreal in their habits, and have the upper lip undivided, the cheek-teeth rooted, the clavicles complete, the soles of the feet tuberculated and three pairs of teats. *Erethizon dorsatum*, the urson, is distributed all over the forest regions of North America; *Syntheres* (or *Coendou*) *prehensilis*, the prehensile-tailed porcupine of South America (fig. 15), represents a genus in which the whole upper surface of the body is protected by long white-tipped spines; *Chaetomys subspinosus* is clothed with strong wavy bristles. In the last two genera the feet have four toes, in place of the five of *Erethizon* (see PORCUPINE).

Cavy.—In the family Caviidae, typified by the cavies (or guinea-pigs), may be included a large number of South and Central American rodents, among which the agoutis and pacas are often ranked as a family (Dasyproctidae) by themselves. The Caviidae, in the present more comprehensive sense, include the giants of the rodent order. Many of them, like ungulates, are specialized for swift running, and have unusually long limbs, with ridges developed on the articular surfaces of the lower bones; the clavicles are more or less reduced; the thorax is more compressed than usual, with a narrower breast-bone; and there is a marked tendency to the reduction or loss of the lateral toes, more especially in the hind limb. Since these rodents walk more or less entirely on their toes, in such a manner that the edges of the claws or nails come in contact with the ground, these tend to assume somewhat of a hoof-like character; while the foot-pads are more or less horny. The tail is generally very short, and its basal vertebrae are often fused with the sacrum. In the skull the lachrymal bone is large, the par-occipital process is directed vertically downwards and the tympanic bulla is hollow. In the soft parts the caecum is very large, the penis is armed with a pair of barbed horny claspers and the scrotum is spiny. Special interest attaches to the most aberrant member of the

family, the Peruvian Dinomys, known for more than thirty years only by a single specimen taken in a house in Lima, and only lately rediscovered. It is a large rodent known to the Tupi Indians as the paca-rana, or false paca, in allusion to the resemblance of its coloration to that of the true paca, from which it differs by its well-developed tail, the absence of cheek-pouches, the full development of all five toes and the wider thorax. The Tupi name may be adopted as the popular title of the species. Dr E. Goeldi states that the paca-rana is a rodent of phlegmatic and gentle disposition, which may account, perhaps, for its rarity. It, indeed, is locally scarce in its native home, which is probably the eastern slopes and tablelands of the Bolivian and Peruvian foot-hills bordering on Brazil, inclusive of the headwaters of the Purus, Acre and Jurua rivers. In the true pacas, *Coelogenys* (or *Agouti*), the first front toe is small, and both the first and fifth digits of the hind-foot are much inferior in size to the other three. The most remarkable feature of the genus is, however, the extraordinary development of the zygomatic arches of the skull, which are enormously expanded vertically, forming great convex bony capsules on the sides of the face, enclosing on each side a large cavity lined with mucous membrane internally, and communicating by a small opening with the mouth. *C. paca* is a white-spotted rodent, about 2 ft. long, and lives generally in the forests or along the banks of rivers (see PACA). The Agoutis, *Dasyprocta*, include several species of slender-limbed rodents, with three hind-toes, inhabiting Central and South America, one (*D. cristata*) extending into the West Indian islands. The members of both *Coelogenys* and *Dasyprocta* are terrestrial in their habits, and have the fore- and hind-limbs subequal, hoof-like claws, short or obsolete tail and rudimentary clavicles. The masseteric ridge of the lower jaw is obsolete, the palate broad, the incisors long and the molars very rootless and internal enamel-folds (see AGOUTI). The remaining and more typical members of the family, one of which is aquatic, are characterized by their short incisors, the strong masseteric ridges on the sides of the lower jaw, the long and curved par-occipitals and the palate contracted in front. Fore-feet with four digits, hind-feet with three; clavicles imperfect; molars divided by enamel-folds into transverse lobes; milk-teeth shed before birth. In the true cavies, or couies, *Cavia*, the fore- and hind-limbs are short and of subequal length, the ears are short and there are no tail. They include several species widely distributed throughout South America, extending even to the straits of Magellan, from one of which (*C. culveri* of Peru) the guinea-pig is derived. The maras (*Dolichotis*) have the limbs and ears long and the tail very short. *D. patagonica* is a large species, nearly 3 ft. long, inhabiting the gravelly plains of Patagonia, while *D. salinicola* is a much smaller rodent from the salt-lagunas of Argentina. The palate is so much contracted in front that the premolars of opposite sides touch by their antero-internal edges. *Hydrochaeris*, in which all the feet are fully webbed, includes a single species, the capybara, or carpincho, the largest of living rodents. The skull (fig. 14) is distinguished not only by its great size, but by the enormous development of the par-occipital processes and the complex structure and large size of the last molars (see CAVY and CAPYBARA).

Chinchilla Group.—The family, Chinchillidae, typified by the well-known chinchilla, includes a small number of South American rodents with large ears and proportionately great auditory bullae in the skull, elongated hind-limbs, bushy tails, very soft fur and perfect clavicles. The jugal is without an inferior angle, and extends forwards to the lachrymal; the palate is contracted in front and deeply emarginate behind; the incisors are short, and the molars divided by continuous folds into transverse plates; and the two halves of the lower jaw are welded together in front. It includes three existing genera, represented by some five species. Of these the true chinchilla, *Chinchilla lanigera*, *C. leucocaudata*, *Lagidium peruv.*, and *C. bellii*, are restricted to the alpine zones of the Andes, from the northern boundary of Peru to the southern parts of Chili; while *Lagostomus trichodactylus* (or *Viscaccia viscaccia*), the viscacha, is confined to the pampas from the Uruguay river to the Rio Negro. In *Chinchilla* the fore-feet have five and the hind four digits, the tail is long and bushy, and the auditory bullae are enormous, appearing on the top of the skull; *Lagidium* has four digits in both fore- and hind-feet, and *Lagostomus* three only in the hind-feet, while the auditory bullae are much smaller (see CHINCHILLA and VISCACHA).

Hutia Group.—The three remaining families of the Hystricoidea, of which one is African while the other two are chiefly South American, are very closely allied and often brigaded in the same family group, and are typified by the hutia, which includes the South American and West Indian hutias, the South American coypu and the African cane-rats, the tympanic bulla of the skull is hollow, the par-occipital process straight, the lachrymal small, and the cheek-teeth rooted, with deep enamel-folds; the first front toe being occasionally absent. Of the few living representatives of the group, the genus *Myocastor* (or *Myopotamus*) is represented only by the South American coypu, *M. coypu*, which is aquatic in its habits, and measures about 2 ft. in length, being the largest member of the group. It has a long tail, brown fur and red incisors, and lives in burrows near water, feeding on aquatic plants.

The hutia (*Capromys pilorides*) is nearly as large, arboreal in habits, and a native of Cuba, where it is the largest indigenous mammal. Other species occur in Cuba, Jamaica and the Bahamas, while a Venezuelan species, *Procapromys geyi*, represents a separate genus. In one kind the tail is prehensile. All these rodents are remarkable for the manner in which the liver is divided into minute lobules. *Plagiodontia adiumi*, another member of the group, is peculiar to Hayti. The African cane-rats, *Thryonomys* (or *Aulacodons*), are large terrestrial rodents, ranging from the centre of the continent to the Cape, easily recognized by their deeply fluted incisors (see COYPU). The Octodontidae, which are exclusively South American, differ from the preceding family by the tympanic bulla being filled with cellular bony tissue, and by the par-occipital process curving beneath it, while the cheek-teeth are almost or completely rootless and are placed on a series of parallel plates. The first front toe may be absent. The more typical members of the family are rat-like burrowing rodents, living in communities. The typical genus is represented by the degu (*Octodon degus*) and several nearly related species; other genera being *Clenomys*, *Octodontomys* (*Neotodon*), *Aconemys*, *Spalacopus* and *Abrocoma*; the latter taking its name from its unusually soft fur. Among these, the tuco-tucos (*Clenomys*) are characterized by their burrowing habits, and rudimentary ears, small eyes, short tails and kidney-shaped grinding-surfaces of their cheek-teeth. They take their name of tuco-tuco from their cry, which resembles the blows of a hammer on an anvil, and may be heard all day as the little rodents move in their burrows, generally formed in sandy soil. In some districts the ground is undermined by these burrows, in which stores of food are accumulated. The species of *Octodon* have larger ears, longer, tufted tails and the sides of the cheek-teeth indented by plates of enamel, which are chiefly found in bed-burrows and earths, where they burrow. In *Abrocoma* the tail has no tuft, and the ears are still larger and the lower cheek-teeth more complex than the upper ones. *Aconemys* is an allied Chilean genus in which the enamel-folds meet across the molars. Several of these rodents live in the Andes, where the ground is covered for months with snow. The second group of the family is formed by the genera *Loucheuxi*, *Dactylopsilus*, *Echinosylvis*, *Proechimys* and a few others, the members of which are rat-like rodents, with long scaly or furry tails and frequent flattened spines mingled with the fur of the back. Most species are brown above and whitish beneath, but in some the lighter tints extend on to the sides, shoulders and head, communicating a coloration somewhat like that of a guinea-pig (see OCTODON). The North African gundis (*Ctenodactylus gundi* and *C. vidi*) are the types of an African family, which also includes the genera *Masousiera*, *Pectinator* and *Petromys*. In the gundi the two inner toes of the hind-foot are articulated with the long scaly or furry tail and bristles for the purpose of cleaning the fur, and the tail is very short; but in *Pectinator* the tail is longer. *Petromys* has a still longer and more bushy tail, and no comb to the hind-feet. The gundi is a diurnal species, inhabiting rocky districts, and having habits very similar to those of a jerboa. Of these *Ctenodactylus* and *Pectinator* are characterized by the union of the incus and malleus of the internal ear, the free fibula and the almost rootless cheek-teeth. The premaxilla is very small, thus showing an approximation to the Myoidae, although in other respects *Petromys* appears to approximate to the Hystricidae.

Picas and Hares.—The remaining rodents, which include two families—the picas (Ochotonidae) and the hares and rabbits (Leporidae)—constitute a second sub-order, the Duplicitentata, differing from all the foregoing groups in possessing two pairs of incisors in the upper jaw (of which the second is small, and placed directly behind the large first pair), the enamel of which extends round to their posterior surfaces. At birth there are three pairs of incisors, but the outer one is soon lost. The incisive foramina are large and usually confluent; the bony palate is very narrow from before backwards; there is no alisphenoid canal; the fibula is welded to the tibia, and articulates with the calcaneum; and the testes are permanently external. All are terrestrial, and in many cases burrowing, in their habits, and some of them are of extreme fleetness. The Ochotonidae are represented at the present day only by the single genus *Ochotona* (*Lagomys*), which includes all the mountain-picas and mouse-hares. They are small rodents, with complete clavicles, fore- and hind-limbs of nearly equal length, no external tails and short ears. Skull depressed, frontals contracted and without post-orbital processes; $p. \frac{1}{2}$ or $\frac{3}{4}$; molars rootless, with transverse enamel-folds. In some cases the molar-formula is $\frac{1}{2}$. The genus includes about a score of species of guinea-pig-like animals, inhabiting chiefly the mountainous parts of Northern Asia (from 11,000 to 14,000 ft.), one species only being known from the South-east Europe and several from the Rocky Mountains and Alaska.

From the picas the hares and rabbits (Leporidae) are distinguished by the imperfect clavicles, the more or less elongated hind-limbs, short recurved tail (absent in one case) and generally long ears. The skull is compressed, with large wing-shaped post-orbital processes (fig. 16); $p. \frac{1}{2}$. With the exception of Australasia, the family has a cosmopolitan distribution; and its numerous species resemble one another more or less closely in general external

characters. In all the fore-limbs have five and the hind four digits; and the soles of the feet are densely clothed with hairs similar to those covering the legs; the inner surface of the cheeks being hairy. Although the family has such a wide distribution, the greater number of the species are confined to Europe, northern and central Asia and North America; South America having very few. Till within the last few years the majority of naturalists followed the practice of including all the members of the family in the genus *Lepus*. It is true that Mr E. Blyth long ago proposed the name *Caprolagus* for the remarkable spiny rabbit of the western Himalayas, while the generic name *Oryctolagus* was suggested later for the rabbit, and *Sylvestrus* for the American "cotton-tails"; but none of these was accorded general acceptance. Of late years, however, zoologists have come to the conclusion that generic subdivisions of the Leporidae are advisable. In 1899 Dr Forsyth Major proposed a classification of the family in which a number of species were grouped with the spiny rabbit in the genus *Caprolagus*, whilst *Oryctolagus* was taken to include not only the common rabbit, but likewise the Cape hare. A more recent classification is that of Mr M. W. Lyon, in which by far the largest number of species of the family are retained in the original genus *Lepus*, which has also the widest geographical distribution of all the genera. It is typified by the blue hare (*Lepus timidus*), next to which comes the common hare (*L. europaeus*) and certain other allied forms. The jackass-hares of Mexico, &c., such as *L. californicus*, form a second sub-group; while these are in turn followed by the American hare (*L. americanus*) and its immediate relatives. The cotton-tails, of which the species of North and South America are regarded as forming a genus, *Sylvestrus*, by themselves, which includes the Brazilian and Paraguay hares, and appears to be chiefly distinguished by a certain feature in the parietal region of the skull. Under the name of *Oryctolagus cuniculus*, the rabbit is considered to represent a genus by itself, specially characterized by the shortness of the ears and hind-feet. The swamp-rabbit (*L. palustris*) and water-hare (*L. aquaticus*) of the southern United States form the group *Limnolagus*, characterized by the harsher fur, the shorter ears, tail and hind-feet, and the complete fusion of the post-orbital process (which is so distinct in the typical hares) with the adjacent parts of the skull, so that neither notches nor perforations are developed in this region. The short-tailed rabbit of the western United States (*Brachylagus idahoensis*) is the sole member of a group allied in general characters to the typical *Lepus*, but distinguished by the unusually short tail. Another group is *Pronolagus*, typified by the Cape thick-tailed hare, the so-called *Lepus eremicus*, which is externally similar to *Lepus* proper, but has the skull and teeth of the general type of the next group. The tail-less rabbit of Mount Popocatepetl, Mexico, originally described as a distinct generic type, under the name of *Romerolagus nelsoni*, is broadly distinguished by the entire absence of the tail, and the short ears and hind-feet, its general form being like that of the Liu-Kiu rabbit, while, as in the latter, the post-orbital process of the skull is small, and represented only by the hinder half. Next come the remarkable rabbits from the Indo-Malay countries, all closely allied, although regarded as representing three generic groups, *Neolagus*, *Caprolagus* and *Pentalagus*. In all three the skull is of the type of *Romerolagus*. The first is represented by the Sumatran rabbit, the so-called *N. netscheri*, which apparently differs from the spiny rabbit mainly by the pattern of the cheek-teeth. The spiny rabbit, separated from *Lepus* by Blyth in 1845 under the name of *Caprolagus hispidus*, is an inhabitant of Assam and the adjacent districts, and is distinguished by its harsh, bristly fur and long tail. In the Liu-Kiu rabbit (*Pentalagus furnessi*) the coat is equally harsh, but the ears and hind-feet are shorter, and there are only five (in place of the usual six) pairs of upper cheek-teeth. In the loss of the last upper molar, the Liu-Kiu rabbit approximates to the picas, as does the tailless rabbit in the abortion of its caudal appendage. Mr Lyon's scheme seems to be the best attempt to explain the affinities of the members of the group. Whether all his genera be adopted, or all the species be included in *Lepus*, must largely be a matter of individual opinion.

FIG. 16.—Skull of the Common Hare (*Lepus europaeus*).

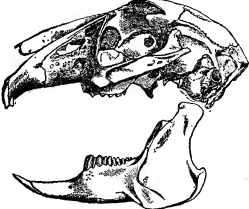

If the latter course be followed, Mr Lyon's genera must be reduced to the rank of sub-genera, and his sub-generic divisions of *Lepus* and *Sylvestagus* ignored. (See HARE and RABBIT.)

EXTINCT RODENTS

Among extinct rodents, only a few of the more important types may be noticed. As to the origin of the order, we are still to a great extent in the dark; and even the relations of the Diplicidentata to the Simplicidentata are not yet fully understood. With regard to the latter point, it is, however, considered probable that both are branches of a common stock, which diverged from each other before all the typical rodent characters were acquired. As to the ancestral stock of the order, it has been suggested that this is represented by certain Lower Eocene European and North American mammals, at one time regarded as primitive Primates. In Europe these include *Plesiadapis* and *Protopithecus*, and in North America *Mixodectes*, *Microsops* and *Cynodontomys*; the last three constituting the family Mixodectidae. Possibly the European forms, in which the dental formula has been given as $i, 1, c, 3, p, 2, m, 1, 1$, and there is a gap between the incisors and the cheek-teeth, are more nearly related to modern rodents than the American types, and may indeed belong to the same order. On the other hand, the American forms, which have one pair of large chisel-like incisors in the lower jaw, also possess a lower canine, and show no marked gap in front of the cheek-teeth, nor any indication of the characteristic rodent backwards movement of the lower jaw. On these grounds, while admitting that they are allied to the rodents, it has been pointed out that they can scarcely be included in the Rodentia, and the order "Progliridae" has accordingly been proposed for the position.

Whatever may be the true affinity of these problematical mammals, undoubted rodents are known from the Lower Eocene of both Europe and North America. In Europe these form the genus *Ischyromys* and the family Ischyromyidae, and have premolars $\frac{1}{2}$, and all the cheek-teeth low-crowned, with simple cusps or ridges. Possibly they are akin to the Sciuridae. In America, *Paromys*, with transversely ridged molars, is allied; and the European *Sciuromyia* should perhaps find a place in the same neighbourhood. A more advanced phase is represented in the European Lower Oligocene by the Pseudosciuridae, with the genera *Psudosciurus*, *Sciurorites*, *Trochomys*, *Theridomys*, &c., in which part of the masseteric passes through the broad infra-orbital canal, and the premolars are $\frac{1}{2}$; the molars being low-crowned, many-rooted and either cusped or ridged. These rodents are thought to be allied to the Anomaluridae; and it is partly on their evidence that the family Pedetidae is placed next the latter. Here it may be mentioned that *Leithia*, from the Pleistocene of Malta, originally regarded as a giant dormouse, seems near akin to *Anomalurus*. In the highly specialized mastoid region of the skull, the North American Oligocene *Protophyclus* approaches to *Dipodomyia*, while the contemporary *Gymnophlycus* and *Entolophus* likewise appear referable to the Geomyidae. The upper Oligocene *Cricetodon* in Europe and *Eumys* in America are the earliest known forerunners of the cricetine Muridae; while at the same time primitive beavers appear in the form of *Steneofiber*, to be succeeded in the European Pleistocene by the gigantic *Trogontherium*.

The still larger North American Pleistocene *Castoroides*, known by one species of the size of a bear, and the allied West Indian *Amblyrhiza*, appear to be specialized beavers, although they have been referred to a family by themselves. Near akin is the North American Miocene family Mylagaulidae, typified by *Mylagaulus*, but including *Mesogaulus* and *Protogaulus*. Although showing some dental characters approximating to those of the beavers, these rodents are regarded as allied to the Castoridae, although forming an isolated type. The prominent feature, writes Mr E. S. Riggs, is the unusual development of the premolar to the exclusion of the posterior teeth. Associated with this is the strength and sharpness of the lower jaw, the prominence and anterior position of the masseteric ridge, and the depth of the ramus from the alveolar line to the angle. These indicate unusual capacity for crushing or grinding; while the last premolar is a crushing implement, which has reached the highest degree of specialization known in Rodentia. It is suggested that these teeth may have been employed for cracking nuts or hard seeds, although also used for grinding. The remarkable North American *Ceratogaulus*, with a large bony nasal horn, belongs to the same family. To discuss the remaining Miocene and later fossil Simplicidentata would be doing little more than adding to the generic names referable to the various existing families. It may be mentioned, however, that the distribution of these later Tertiary types accords very closely with that of their existing relatives: the families of South American hystricoids being represented by a number of extinct genera in the formations of Argentina and Brazil. Special mention may be made of *Megomys*, from the coast of Brazil, which while approximating to the living viscacha, attained dimensions approximating to those of a hippopotamus.

As regards the Diplicidentata, it appears that the families Ochotonidae and Leporidae had become differentiated as early as the Lower Miocene. *Titanomys* is the earliest form, from the Middle Miocene, succeeded by *Lagopsis*, and then by the modern *Ochotona*. In this line there is a tendency to lose the last upper molar, but in *Prolagus*, which ranges in the Pliocene from Sardinia and Corsica to Spain, and forms a side-branch, the corresponding lower tooth

has likewise disappeared. In contradistinction to *Titanomys*, in which the cheek-teeth are rooted, is the North American Upper Oligocene *Palaenolagus*, where they are rootless. In general dental characters, especially the retention of three pairs of molars, this genus approximates to the Leporidae, although in the absence of post-orbital processes and the pattern of the molars it departs less widely from the modern Ochotonidae than does *Prolagus*.

AUTHORITIES.—The above article is partly based on that by G. E. Dobson in the 9th edition of this work. See also H. Winge, *Jord Fauna og Nuleens Gnaedere* (Rodentia), *E. Museo Lund.* (1888); C. J. Forsyth-Major, "On some Miocene Squirrels, with Remarks on the Dentition and Classification of the Sciuridae," *Proc. Zool. Soc. London* (1893); "On Fossil and Recent Lagomorpha," *Trans. Linnean Soc. London*, vol. vii. (1899); T. S. Palmer, "A List of the Generic and Family Names of Rodents," *Proc. Zool. Soc. Washington*, vol. xi. (1897); O. Thomas, "On the Genera of Rodents," *Proc. Zool. Soc. London* (1896); T. Tullberg, *Über das System der Nagethiere* (Upsala, 1899); H. F. Osborn, "American Eocene Primates, and the Supposed Rodent Family Mixodectidae," *Bull. Amer. Mus. Nat. Hist.* vol. xvi. (1902); W. Lyon, "Classification of the Hares and their Allies," *Smithsonian Miscell. Collections*, vol. xiv. (1903). Also numerous papers by O. Thomas, in *Proc. Zool. Soc. London* and *Annals and Magazine of Nat. Hist.*, and by several American naturalists in transatlantic zoological serials. (R. L. *)

RODERICK, or RUADRI (d. 1198), king of Connaught and high king of Ireland, was the son of Turlough (Tordelbach) O'Connor, king of Connaught, who had obtained the over-kingship in 1151, but had lost it again in 1154 through the rise of Muirchertach O'Lochlainn in Ulster. Roderick succeeded to Connaught in 1156, and after ten years' fighting won back the title of high king. His ill-advised persecution of Dermot (Diarmait MacMurcudha), king of Leinster, furnished the pretext for the Anglo-Norman invasion of Ireland. Roderick endeavoured to expel the invaders, but was driven behind the Shannon. He delayed his submission to Henry II until 1171, when a treaty was concluded at Windsor. Roderick, under this agreement, held Connaught as the vassal of England, and exercised lordship over all the native kings and chiefs of Ireland; in return he undertook to pay an annual tribute. The treaty did not put an end to the wars of the Norman adventurers against Connaught and Roderick's dependants. He held out till 1191; but then, weary of strife, retired to the cloister. He died in 1198, the last of the high kings of Ireland.

See Giraldus Cambrensis, *Opera*, vol. v. (Rolls Series); G. Orpen's *Song of Dermot and the Earl* (1892); W. Stubbs's edition of *Benedictus Abbas* (Rolls Series); Miss K. Norgate's *England under the Angevin Kings*, vol. ii. (1887).

RODEZ, a town of southern France, capital of the department of Aveyron, 51 m. N.N.E. of Albi by rail. Pop. (1906) town, 11,076; commune, 15,502. Rodez is situated on the southern border of the Cause of Rodez, on an isolated plateau bordered on the E. and S. by the river Aveyron. The cathedral was built between 1277 and 1535. A great Flamboyant rose-window and a gallery in the same style are the chief features of the principal façade, which is flanked by two square towers and has no portal. Each transept has a fine Gothic doorway. On the north side of the building rises a tower (1510-1526) of imposing height (253 ft.). The three upper stages are richly decorated, and the whole is surmounted by a colossal statue of the Virgin. In the cathedral are a fine rood-loft, some good wood-carving and the tombs of several bishops. Other interesting buildings are the episcopal palace (17th and 19th centuries), flanked by a massive tower, relic of an older palace; the church of St Amans, of Romanesque architecture, restored in the 18th century; and, among other old houses, the hôtel d'Armagnac built in the Renaissance period on the site of the old palace of the counts. The ruins of a Roman amphitheatre still exist in Rodez, which is supplied with water by a Roman aqueduct. About 6 m. to the north of Rodez is the chasm of Tindoul de la Vaysière, leading to a subterranean river issuing in the springs of the picturesque village of Salles-la-Source.

The town is the seat of a bishop, a prefect and a court of assizes, and has tribunals of first instance and commerce, a chamber of commerce, a branch of the Bank of France, a lycée training college for both sexes and an ecclesiastical seminary. The industries include wool-spinning and the weaving of woollen goods.

Rodez, called *Segodunum* under the Gauls, and *Ruthena* under the Romans, was the capital of the *Rutheni*, a tribe allied to the Arverni, and was afterwards the principal town in the district of Rouergue. In the 4th century it adopted the Christian faith, and St Amans, its first bishop, was elected in 401. During the middle ages contests were rife between the bishops, who held the temporal power in the "cité," and the counts in the "bourg." The Albigenes were defeated near Rodez in 1210. The countship of Rodez, detached from that of Rouergue at the end of the 11th century, belonged first to the viscounts of Carlat, and from the beginning of the 14th century to the counts of Armagnac. From 1360 to 1368 the English held the town. After the confiscation of the estates of the Armagnacs in 1475 the countship passed to the dukes of Alençon and then to the D'Albrets. Henry IV. finally annexed it to the crown of France.

RODGERS, JOHN (1771-1838), American sailor, was born in Harford county, Maryland, on the 11th of July 1771. He entered the United States navy when it was organized in 1798. He was second in command to Commodore James Barron (1769-1851) in the expedition against the Barbary pirates, and succeeded him in the command in 1805. In this year he brought both Tunis and Tripoli to terms, and then returned to America. In 1811 he was in command as commodore of the U.S. frigate "President" (44) off Annapolis when he heard that an American seaman had been "pressed" by a British frigate off Sandy Hook. Commodore Rodgers was ordered to sea "to protect American commerce," but he may have had verbal instructions to retaliate for the impressment of real or supposed British subjects out of American vessels, which was causing much ill-feeling and was a main cause of the War of 1812. On the 16th of May 1811 he sighted and followed the British sloop "Little Belt" (22), and after some hailing and counter-hailing, of which very different versions are given on either side, a gun was fired, each side accusing the other of the aggression, and an action ensued in which the "Little Belt" was cut to pieces. The incident, which was represented as an accident by the Americans, and believed to be a deliberate aggression by the British navy, had a share in bringing on war. When hostilities broke out Rodgers commanded a squadron on the coast of America, and was wounded by the bursting of one of his guns while pursuing the British frigate "Belvedere." He was subsequently President of the Board of Navy Commissioners in 1815-1824 and in 1827-1837, and acting secretary of the navy in 1823 for two weeks. He died in Philadelphia on the 1st of August 1838.

His brother, George Washington Rodgers (1787-1832), a brother-in-law of Commodore Perry, served in the War of 1812 and in the war with Algiers (1815). Rear-Admiral John Rodgers (1812-1882), a son of Commodore John Rodgers, served in the Union navy and in 1877-1882 was superintendent of the Naval Observatory at Washington. G. W. Rodgers had two sons who were naval officers, Christopher Raymond Perry Rodgers (1819-1892) and George Washington Rodgers (1822-1863).

RODIN, AUGUSTE (1840-), French sculptor, was born in 1840, in Paris, and at an early age displayed a taste for his art. He began by attending Barye's classes, but did not yield too completely to his influence. From 1864 to 1870, under pressure of necessity, he was employed in the studio of Carrier-Belleuse, where he learnt to deal with the mechanical difficulties of a sculptor. Even so early as 1864 his individuality was manifested in his "Man with a Broken Nose." After the war, finding nothing to do in Paris, Rodin went to Brussels, where from 1871 to 1877 he worked, as the colleague of the Belgian artist Van Rasboum, on the sculpture for the outside and the caryatids for the interior of the Bourse, besides exhibiting in 1875 a "Portrait of Garnier." In 1877 he contributed to the Salon "The Bronze Age," which was seen again, cast in bronze, at the Salon of 1880, when it took a third-class medal, was purchased by the State, and is now in the museum of the Luxembourg. Between 1882 and 1885 he sent to the Salons busts of "Jean-Paul Laurens" and "Carrier-Belleuse" (1882), "Victor Hugo" and "Dalou" (1884), and "Antonin Proust" (1885). From about this time he chiefly devoted himself to a great decorative composition six metres high, which was not finished for twenty years. This is the "Portal of Hell," the

most elaborate perhaps of all Rodin's works, executed to order for the Musée des arts décoratifs. It is inspired mainly by Dante's *Inferno*, the poet himself being seated at the top, while at his feet, in under-cut relief, we see the writhing crowd of the damned, torn by the frenzy of passion and the anguish of despair. The lower part consists of two bas-reliefs, in their midst two masks of tormented faces. Round these run figures of women and centaurs. Above the door three men cling to each other in an attitude of despair. After beginning this titanic undertaking, and while continuing to work on it, Rodin executed for the town of Damvillers a statue of "Bastien-Lepage"; for Nancy a "Monument to Claude le Lorrain," representing the Chariot of the Sun drawn by horses; and for Calais "The Burgesses of Calais" surrendering the keys of the town and imploring mercy. In this, Rodin, throwing over all school tradition, represents the citizens not as grouped on a square or circular plinth, but walking in file. This work was exhibited at the Petit Gallery in 1889. At the time of the session of the National Society of Fine Arts, or New Salon, in 1890, Rodin withdrew from the old Society of French Artists, and exhibited in the New Salon the bust of his friend "Puvis de Chavannes" (1892), "Contemplation" and a "Caryatid," both in marble, and the "Monument to Victor Hugo" (1897), intended for the gardens of the Luxembourg. In this the poet is represented nude, as a powerful old man extending his right arm with a sovereign gesture, the Muses standing behind him. In 1898 Rodin exhibited two very dissimilar works, "The Kiss," exhibited again in 1900, a marble group representing Paolo Malatesta and Francesca da Rimini, and the sketch in plaster for a "Statue of Balzac." This statue, a commission from the Society of Men of Letters, had long been expected, and was received with vehement dissensions. Some critics regarded this work, in which Balzac was represented in his voluminous dressing-gown, as the first-fruits of a new phase of sculpture; others, on the contrary, declared that it was incomprehensible, if not ridiculous. "This was the view taken by the society who had ordered it, and who" refused to recognize Rodin's rough sketch as a statue of Balzac," and withdrew the commission, giving it to the sculptor Falguière. Falguière exhibited his model in 1899. In the same Salon, Rodin, to prove that the conduct of the society had made no change in his friendship with Falguière, exhibited a bust in bronze of his rival, as well as one of "Henri Rochefort." In 1900, the city of Paris, to do honour to Rodin, erected at its own expense a building close to one of the entrances to the Great Exhibition, in which almost all of the works of the artist were to be seen, more especially the great "Portal of Hell," still quite incomplete, the "Balzac," and a host of other works, many of them unfinished or mere rough sketches. Here, too, were to be seen some of Rodin's designs, studies and water-colour drawings. He has also executed a great many etchings and *graffiti* on porcelain for the manufactory at Sèvres. His best-known etching is the portrait of Victor Hugo. Many of Rodin's works are in private collections, and at the Luxembourg he is represented by a "Danaid" (in marble), a "Saint John" (in bronze, 1880), "She who made the Helmet" (bronze statuette), the busts of "J. P. Laurens" and of "A Lady" and other works. In the Musée Galliera is a very fine bust of Victor Hugo. Rodin's "Hand of God" was exhibited in the New Gallery, London, in 1905. In 1904 Mr Ernest Beckett (Lord Grimthorpe) presented the British nation with the sculptor's "Le Penseur." In the same year Rodin became president of the International Society of Sculptors, Painters and Engravers, in succession to James McNeill Whistler.

See SCULPTURE (*Modern French*); also Geoffroy, *La Vie artistique* (Paris, 1892, 1893, 1899, 1900); L. Maillard, *Rodin* (Paris, 1899); *La Plume, Rodin et son œuvre* (Paris, 1900); Alexandre, *Le Balzac de Rodin* (Paris, 1898); H. Boutet, *Dix dessins choisis de Auguste Rodin* (1904); R. Dircks, *Auguste Rodin* (1904); H. Duham, *Auguste Rodin* (1903); C. Black, *Auguste Rodin: the Man, his Ideas and his Works* (1905).

RODNEY, GEORGE BRYDGES RODNEY, BARON (1718-1792), English admiral, second son of Henry Rodney of

Walton-on-Thames, was born in February 1718. His father had served in Spain under the earl of Peterborough, and on quitting the army served as captain in a marine corps which was disbanded in 1713. George was sent to Harrow, being appointed, on leaving, by warrant dated the 21st of June 1732, a volunteer on board the "Sunderland." While serving on the Mediterranean station he was made lieutenant in the "Dolphin," his promotion dating the 15th of February 1739. In 1742 he attained the rank of post-captain, having been appointed to the "Plymouth" on the 9th of November. After serving in home waters, he obtained command of the "Eagle" (60), and in this ship took part in Hawke's victory off Ushant (14th October 1747) over the French fleet. On that day Rodney gained his first laurels for gallantry, under a chief to whom he was in a measure indebted for subsequent success. On the 9th of May 1749 he was appointed governor and commander-in-chief of Newfoundland, with the rank of commodore, it being usual at that time to appoint a naval officer, chiefly on account of the fishery interests. He was elected M.P. for Saltash in 1751, and married his first wife, Jane Compton (1730-1757), sister of the 7th earl of Northampton, in 1753. During the Seven Years' War Rodney rendered important services. In 1757 he had a share in the expedition against Rochefort, commanding the "Dublin" (74). Next year, in the same ship, he served under Boscawen at the taking of Louisbourg (Cape Breton). On the 10th of May 1759 he became a rear-admiral, and was shortly after given command of a small squadron intended to destroy a large number of flat-bottomed boats and stores which were being collected at Havre for an invasion of the English coasts. He bombarded the town for two days and nights, and inflicted great loss of war-material on the enemy. In July 1760, with another small squadron, he succeeded in taking many more of the enemy's flat-bottomed boats and in blockading the coast as far as Dieppe. Elected M.P. for Penryn in 1761, he was in October of that year appointed commander-in-chief of the Leeward Islands station, and within the first three months of 1762 had reduced the important island of Martinique, while both St Lucia and Grenada had surrendered to his squadron. During the siege of Fort Royal (now Fort de France) his seamen and marines rendered splendid service on shore. At the peace of 1763 Admiral Rodney returned home, having been during his absence made vice-admiral of the Blue and having received the thanks of both houses of parliament.

In 1764 Rodney was created a baronet, and the same year he married Henrietta, daughter of John Clies of Lisbon. From 1765 to 1770 he was governor of Greenwich Hospital, and on the dissolution of parliament in 1768 he successfully contested Northampton at a ruinous cost. When appointed commander-in-chief of the Jamaica station in 1771 he lost his Greenwich post, but a few months later received the office of rear-admiral of Great Britain. Till 1774 he held the Jamaica command, and during a period of quiet was active in improving the naval yards on his station. Sir George struck his flag with a feeling of disappointment at not obtaining the governorship of Jamaica, and was shortly after forced to settle in Paris. Election expenses and losses at play in fashionable circles had shattered his fortune, and he could not secure payment of the salary as rear-admiral of Great Britain. In February 1778, having just been promoted admiral of the White, he used every possible exertion to obtain a command, to free himself from his money difficulties. By May he had, through the splendid generosity of his Parisian friend Marshal Biron, effected the latter task, and accordingly he returned to London with his children. The debt was repaid out of the arrears due to him on his return. The story that he was offered a French command is fiction.

Sir George was appointed once more commander-in-chief of the Leeward Islands late in 1779. His orders were to relieve Gibraltar on his way to the West Indies. He captured a Spanish convoy off Cape Finisterre on the 8th of January 1780, and eight days later defeated the Spanish admiral Don Juan de

Langara off Cape St Vincent, taking or destroying seven ships. On the 17th of April an action, which, owing to the carelessness of some of Rodney's captains, was indecisive, was fought off Martinique with the French admiral Guichen. Rodney, acting under orders, captured the valuable Dutch island of St Eustatius on the 3rd of February 1781. It had been a great *entrepôt* of neutral trade, and was full of booty, which Rodney confiscated. As large quantities belonged to English merchants, he was entangled in a series of costly lawsuits.

After a few months in England, recruiting his health and defending himself in Parliament, Sir George returned to his command in February 1782, and a running engagement with the French fleet on the 9th of April led up to his crowning victory off Dominica, when on the 12th of April with thirty-five sail of the line he defeated the comte de Grasse, who had thirty-three sail. The French inferiority in numbers was more than counterbalanced by the greater size and superior sailing qualities of their ships, yet five were taken and one sunk, after eleven hours' fighting. This important battle saved Jamaica and ruined French naval prestige, while it enabled Rodney to write: "Within two little years I have taken two Spanish, one French and one Dutch admirals." A long and wearisome controversy exists as to the originator of the manoeuvre of "breaking the line" in this battle, but the merits of the victory have never seriously been affected by any difference of opinion on the question. A shift of wind broke the French line of battle, and advantage was taken of this by the English ships in two places.

Rodney arrived home in August to receive unbounded honour from his country. He had already been created Baron Rodney of Rodney Stoke, Somerset, by patent of the 10th of June 1782, and the House of Commons had voted him a pension of £2000 a year. From this time he led a quiet country life till his death, which occurred on the 24th of May 1792, in London. He was succeeded as 2nd baron by his son, George (1753-1802), from whom the present baron is descended.

Rodney was unquestionably a most able officer, but he was also vain, selfish and unscrupulous, both in seeking prize money, and in using his position to push the fortunes of his family. He made his son a post-captain at fifteen. He was accused by his second-in-command, Hood, of sacrificing the interest of the service to his own profit, and of showing want of energy in pursuit of the French on the 12th of April 1782. It must be remembered that he was then prematurely old and racked by disease.

See General Mundy, *Life and Correspondence of Admiral Lord Rodney* (2 vols., 1830); David Hannay, *Life of Rodney*; Rodney letters in 9th Report of Hist. MSS. Com., pt. iii.; "Memoirs," in *Naval Chronicle*, i. 353-93; and Charnock, *Biographia Navalis*, v. 202-28. Lord Rodney published in his lifetime (probably 1789) *Letters to His Majesty's Ministers, &c., relative to St Eustatius, &c.*, of which there is a copy in the British Museum. Most of these letters are printed in Mundy's *Life*, vol. ii., though with many variant readings.

RODOMONTADE, or RHODOMONTADE, a term for boastful, extravagant language or any inflated bragging speech. The word refers to the brave but boastful Saracen leader Rodomonte in Ariosto's *Orlando Furioso*. The name (in the form Rodamante) appears earlier in Boiardo's *Orlando Innamorato*. It is supposed to represent a compound of *rodare*, to roll, and *monte*, mountain.

RODOSTO (Turkish, *Tekir Dagli*), a town of European Turkey, in the vilayet of Adrianople, on the coast of the Sea of Marmora, 78 m. W. of Constantinople. Pop. (1905) about 35,000, of whom half are Greeks. The picturesque Bay of Rodosto is enclosed by the great promontory of Combos, a spur about 2000 ft. in height from the hilly plateau to the north. The church of Panagia Rheumatocratis contains the graves, with long Latin inscriptions, of the Hungarians who were banished from their country in 1686 by the imperialist captors of Buda. Rodosto was long a great depot for the produce of the Adrianople district, but its trade suffered when Dédéagatch became the terminus of the railway up the Maritza, and the town is now

dependent on its maritime trade, especially its exports to Constantinople. It is the administrative centre of a district (*sanjak*) producing and exporting barley, oats, spelt and canary seed, and largely planted with mulberry trees, on which silkworms are fed. White cocoons are exported to western Europe (304 cwt. in 1901), silkworms' eggs to Russia and Persia.

Rodosto is the ancient *Rhædæstus* or *Bisanthe*, said to have been founded by Samians. In Xenophon's *Anabasis* it is mentioned as in the kingdom of the Thracian prince Seuthes. Its restoration by Justinian in the 6th century A.D. is chronicled by Procopius. In 813 and again in 1206 it was sacked by the Bulgarians, but it continues to appear as a place of considerable note in later Byzantine history.

RODRIGUEZ (officially **RODRIGUES**), an island in the Indian Ocean in 19° 41' S., 63° 23' E.; the most important dependency of the British colony of Mauritius, from which it is distant 344 nautical miles. It is a station on the "all-British" cable route between South Africa and Australia, telegraphic communication with Mauritius being established in 1902. With a length of 13 m. E. and W., and a breadth of 3 to 6 m. N. and S., it has an area estimated at 42½ sq. m. On all sides it is surrounded by a fringing reef of coral, studded with islets. This reef, only 100 yds. wide at the eastern end of the island, extends westward 3 m., and both N. and S. forms a flat area partly dry at low water. Two passages through the reef are available for large vessels—these leading respectively to Port Mathurin on the N. coast and to Port South-East.

The island was at one period believed to consist of granite overlaid with limestone and other modern formations, and its supposed formation caused it to be regarded as a remnant of the hypothetical continent of Lemuria. The investigations made by an expedition sent by the British government in 1874 showed, however, that the island is a mass of volcanic rock, mainly a doleritic lava, rich in olivine. The land consists largely of a series of hills. The main ridge, which runs parallel to the longest diameter, rises abruptly on the east, more gradually on the west, where there is a wide plain of coralline limestone, studded with caves, some stalactitic. Of several peaks on the main ridge the highest is Mt. Limon, 1300 ft. above the sea. The ridge is deeply furrowed by ravines, the slopes of which show successive belts of lava separated by thin beds of cinders, agglomerate and coloured clays. In places the cliffs rise 300 ft. and exhibit twelve distinct lava flows. The climate is like that of Mauritius, but Rodriguez is more subject than Mauritius to hurricanes during the north-west monsoon (November to April).

Flora and Fauna.—When discovered, and down into the 17th century, Rodriguez was clothed with fine timber trees; but goats, cattle and bush-fires have combined to destroy the great bulk of the old vegetation, and the indigenous plants have in many cases been ousted by intrusive foreigners. Parts are, however, still well wooded, and elsewhere there is excellent pasturage. The sweet potato, manioc, maize, millet, the sugar-cane, cotton, coffee and rice grow well. Tobacco is also cultivated. Wheat is seldom seen, mainly because of the paroquets and the Java sparrows. Beans (*Phaseolus lunatus*), lentils, gram (*Cicer arietinum*), dholl (*Cajanus indicus*) and ground-nuts are all grown to a certain extent in spite of ravages by rats. Mangoes, bananas, guavas, pine-apples, custard-apples, and especially oranges, citrons and limes flourish. Of the timber trees the most common are *Elaeodendron orientale*, much used in carpentry and for pirouges, and *Latania Verschaffeltii* Leguati's plantain. At least two species of acacia pine (*Podocarpus heterophyllus*, Balf. fil. and *P. tenuifolius*) occur freely throughout the island. The total number of known species, according to Professor J. B. Balfour, is 470, belonging to 85 families and 293 genera. The families represented by the greatest number of species are Gramineæ, Leguminosæ, Convolvulaceæ, Malvaceæ, Rubiaceæ, Cyperaceæ, Euphorbiaceæ, Liliaceæ, Compositæ. *Malthurina penduliflora* (Turneraceæ) is interesting, as its nearest congener is in Central America. Of 33 species of mosses 17 are peculiar. Variability of species and heterophily are characteristic of the flora to quite an unusual degree.

At present the only indigenous mammal is a species of fruit-eating bat (*Pteropus rodericensis*), and the introduced species are familiar creatures as deer, pig, rabbit, rat, mouse, &c.; but down to a recent period the island was the home of a very large land-tortoise (*Testudo Vosmaeri* or *rodericensis*), and its limestone caves have yielded a large number of skeletons of the dodo-like solitaire (*Pezophaps solitaria*), which still built its mound-like nest in the island in the close of the 17th century, but is now extinct (see Dodo). Deer, once plentiful, had become very scarce by the beginning of the 20th century, having been indiscriminately hunted by the inhabitants. Of indigenous birds 13 species were discovered. The guinea-fowl (introduced), has become exceedingly abundant, partly owing to protective game-law; and a francolin (*F. pouterianus*), popularly a "partridge," is also common. The

marine fish-fauna does not differ from that of Mauritius, and the freshwater species, with the exception of *Mugil rodericensis* and *Myxus caecutiens*, are common to all the Mascarenes. Thirty-five species of crustaceans are known. The insects (probably very imperfectly recorded) comprise 60 species of Coleoptera, 15 Hymenoptera, 21 Lepidoptera, 15 Orthoptera, and 20 Hemiptera. Forty-nine species of corals have been collected, showing a close affinity to those of Mauritius, Madagascar and the Seychelles.

History.—Rodriguez or Diego Ruy's Island was discovered by the Portuguese in 1645. In 1690 Duquesne prevailed on the Dutch Government to send a body of French Huguenots to the Island of Bourbon, at that time, he believed, abandoned by the French authorities. As the refugees, however, found the French in possession, they proceeded to Rodriguez, and there eight of their number were landed on the 30th of April 1691 with a promise that they should be visited by their compatriots within two years. The two years were spent without misadventure, but, instead of waiting for the arrival of their friends, the seven colonists (for one had meanwhile died) left the island on the 8th of May 1693 and made their way to Mauritius, where they were treated with great cruelty by the governor. The account of the enterprise by Francis Leguat—*Voyages et aventures* (London, 1708), or, as it is called in the English translation, *A New Voyage to the East Indies* (London, 1708)—is a garrulous and amusing narrative, and was for a long time almost the only source of information about Rodriguez. His description of the solitaire is unique.

From the Dutch the island passed to the French, who colonized it from Mauritius. Large estates were cultivated, and the islanders enjoyed considerable prosperity. In 1809-10 Rodriguez was seized by the British, in whose possession it has since remained. The abolition of slavery proved disastrous to the prosperity of the island, and in 1843 the population had sunk to about 250. Since that time there has been a gradual recovery in the economic condition and a steady increase in population. In 1881 the inhabitants numbered 1436; in 1904 the total had risen to 3681. In 1907 the total population was 4231. The inhabitants are mainly of African origin, being descendants of slaves introduced by the French and negro immigrants direct from Africa. There are a few families of European descent (besides the comparatively large staff maintained by the Eastern Telegraph Company) and a small colony of Indians and Chinese. The bulk of the people are French-speaking and Roman Catholics. There are two small settlements, Port Mathurin, the capital, and Gabriel, in the centre of the island. The chief industries are fisheries and cattle-rearing. Salt fish is the principal export, next in importance coming goats, pigs and horned cattle and tobacco. The value of the exports for the four years 1903-06 was £50,894; of the imports for the same period, £54,710. The island is administered by a magistrate appointed by the governor of Mauritius, and the laws are regulations issued by the governor in executive council. The revenue, some £1000 a year, is about half the expenditure incurred, the balance being furnished from the Mauritian treasury. The government maintains a hospital and schools, and pays the salary of a Roman Catholic priest.

Leguat's *Voyage*, edited by Capt. P. Oliver, forms vols. 82 and 83 of the Hakluyt Soc. publications (1891). See also C. Grant, *Hist. of Mauritius and the Neighbouring Islands* (1801); Higgin, in *Jour. R. G. Soc.* 1849; published as the *Reports of the Transit of Venus Expedition, 1874-75*, 1849, as an extra volume of the *Philosophical Transactions* (clxviii., London, 1879) (Botany, by J. B. Balfour; Petrology, by N. S. Maskelyne, &c.); Behm, in *Felernann's Mittheilungen* (1880); and the annual reports on Mauritius.

ROE, EDWARD PAYSON (1838-1888), American novelist, was born in Moodna, Orange county, N.Y., on the 7th of March 1838. He studied at Williams College and at Auburn Theological Seminary; in 1862 became chaplain of the Second New York Cavalry, U.S.V., and in 1864 chaplain of Hampton Hospital, at Hampton, Virginia. In 1866-74 he was pastor of the Presbyterian Church at Highland Falls, N.Y. In 1874 he removed to Cornwall-on-the-Hudson, where he devoted himself to the writing of fiction and to horticulture. He died on the 10th of July 1888. During the Civil War he wrote weekly

letters to the *New York Evangelist*, and subsequently lectured on the war and wrote for periodicals. Among his novels were *Barriers Burned Away* (1872), which first appeared as a serial in the *Evangelist* and made him widely known; *What Can she Do?* (1873), *Opening of a Chestnut Burr* (1874), *From Jest to Earnest* (1875), *Near to Nature's Heart* (1876), *A Knight of the Nineteenth Century* (1877), *A Face Illumined* (1878), *A Day of Fate* (1880), *Without a Home* (1881), *Nature's Serial Story* (1884), *A Young Girl's Wooing* (1884), *An Original Belle* (1885), *He Fell in Love with his Wife* (1886), *The Earth Trembled* (1887) and *Miss Lou* (left unfinished, 1888). He wrote also *Play and Profit in My Garden* (1873), *Success with Small Fruits* (1881) and *The Home Acre* (1887). His novels were very popular in their day, especially with middle-class readers in England and America, and were translated into several European languages. Their strong moral and religious purpose, and their being written by a clergyman, did much to break down a Puritan prejudice in America against works of fiction.

See E. P. Roe: *Reminiscences of his Life* (New York, 1899), by his sister, Mary A. Roe.

ROE (or Row), **SIR THOMAS** (c. 1581-1644), English diplomatist, son of Robert Rowe, and of Elinor, daughter of Robert Jermy of Worstead in Norfolk, was born at Low Leyton near Wanstead in Essex, and at the age of twelve (1593) matriculated at Magdalen College, Oxford. Shortly afterwards he joined one of the inns of court, and was made esquire of the body to Queen Elizabeth. He was knighted by James I. in 1605, and became intimate with Henry, prince of Wales, and also with his sister Elizabeth, afterwards queen of Bohemia, with whom he maintained a correspondence and whose cause he championed. In 1610 he was sent by Prince Henry on a mission to the West Indies, during which he visited Guiana and the river Amazon, but failed then, and in two subsequent expeditions, to discover the gold which was the object of his travels. In 1614 he was elected M.P. for Tamworth, and in 1621 for Cirencester. His permanent reputation was mainly secured by the success which attended his embassy in 1615-18 to the court at Agra of the Great Mogul, Jahāngir, the principal object of the mission being to obtain protection for an English factory at Surat. Appointed ambassador to the Porte in 1621, which he even then describes as being "irrevocably sick," he distinguished himself by further successes. He obtained an extension of the privileges of the English merchants, concluded a treaty with Algiers in 1624, by which he secured the liberation of several hundred English captives, and gained the support, by an English subsidy, of the Transylvanian Prince Bethlen Gabor for the European Protestant alliance and the cause of the Palatinate. Through his friendship with the patriarch of the Greek Church, Cyril Lucaris, the famous Codex Alexandrinus was presented to James I., and Roe himself collected several valuable MSS. which he subsequently presented to the Bodleian library. In 1629 he was again successful in another mission undertaken to arrange a peace between Sweden and Poland. Subsequently Roe negotiated treaties with Danzig and Denmark, returning home in 1630, when a gold medal was struck in his honour. In January 1637 he was appointed chancellor of the Order of the Garter, with a pension of £1200 a year. Subsequently he took part in the peace conferences at Hamburg, Regensburg and Vienna, and used his influence to obtain the restoration of the Palatinate, the emperor declaring that he had "scarce ever met with an ambassador till now." In June 1640 he was made a privy councillor, and in October was returned to parliament as member for the university of Oxford, where his unrivalled knowledge of foreign affairs, commerce and finance, together with his learning and eloquence, gained for him in another sphere considerable reputation. He died on the 6th of November 1644. He had married Eleanor, daughter of Sir Thomas Carr of Stamford, Northamptonshire. Roe was a distinguished and most successful diplomatist, an accomplished scholar and a patron of learning, while his personal character was unblemished.

His *Journal* of the mission to the Mogul, several times printed, has been re-edited, with an introduction by W. Foster, for the Hakluyt Society (1899). This is a valuable contribution to the history of India in the early 17th century. Of his correspondence, *Negotiations in his Embassy to the Ottoman Porte, 1621-28*, vol. i. was published in 1740, but the work was not continued. Other correspondence, consisting of letters relating to his mission to Gustavus Adolphus, was edited by S. R. Gardiner for the Camden Society Miscellany (1875), vol. vii., and his correspondence with Lord Carew in 1615 and 1617 by Sir F. Maclean for the same society in 1860. Several of his MSS. are in the British Museum collections. Roe published a *True and Faithful Relation . . . concerning the Death of Sultan Osman . . . 1622*; a translation from Sarpi, *Discourse upon the Resolution taken in the Valteine* (1628); and in 1613 Dr T. Wright published *Quatuor Colloquia*, consisting of theological disputations between himself and Roe; a poem by Roe is printed in *Notes and Queries*, iv. Ser. v. 9. The *Swedish Intelligence* (1632-33), including an account of the career of Gustavus Adolphus and of the Diet of Ratibon (Regensburg), is attributed to Roe in the catalogue of the British Museum. Several of his speeches, chiefly on currency and financial questions, were also published. Two other works in MS. are mentioned by Wood: *Compendious Relation of the Proceedings . . . of the Imperial Diet at Ratibon* and *Journal of Several Proceedings of the Order of the Garter*.

ROEBLING, JOHN AUGUSTUS (1806-1869), American civil engineer, was born at Mülhausen, Prussia, on the 6th of June 1806. Soon after his graduation from the polytechnic school at Berlin he removed to the United States, and in 1831 entered on the practice of his profession in western Pennsylvania. He established at Pittsburg a manufactory of wire-ropes, and in May 1845 completed his first important structure, a suspended aqueduct across the Allegheny river. This was followed by the Monongahela suspension bridge at Pittsburg and several suspended aqueducts on the Delaware & Hudson Canal. Removing his wire manufactory to Trenton, New Jersey, he began, in 1851, the erection at Niagara Falls of a long span wire suspension bridge with double roadway, for railway and carriage use (see BRIDGE), which was completed in 1855. Owing to the novelty of its design, the most eminent engineers regarded this bridge as foredoomed to failure; but, with its complete success, demonstrated by long use, the number of suspension bridges rapidly multiplied, the use of wire-ropes instead of chain-cables becoming all but universal. The completion, in 1867, of the still more remarkable suspension bridge over the Ohio river at Cincinnati, with a clear span of 1057 ft., added to Roebling's reputation, and his design for the great bridge spanning the East river between New York and Brooklyn was accepted. While personally engaged in laying out the towers for the bridge, Roebling received an accidental injury, which resulted in his death, at Brooklyn, from tetanus, on the 22nd of July 1869. The bridge was completed under the direction of his son, Washington Augustus Roebling (b. 1837), who introduced several modifications in the original plans.

ROEBOURNE, a settlement of De Witt county, Western Australia, 8 m. from the N.W. coast, on the Harding river, 920 m. direct N. of Perth. It is the centre of one of the richest and most varied mineral districts in the colony; gold, silver, tin, lead, copper, diamonds and other precious stones are found. There are extensive pearl fisheries off its port at Cossack Bay.

ROEBUCK, JOHN (1718-1704), English inventor, was born in 1718 at Sheffield, where his father had a prosperous manufacturing business. After attending the grammar school at Sheffield and Dr Philip Doddridge's academy at Northampton, he studied medicine at Edinburgh, where he was imbued with a taste for chemistry by the lectures of William Cullen and Joseph Black, and he finally graduated M.D. at Leiden in 1742. He started practice at Birmingham, but devoted much of his time to chemistry, especially in its practical applications. Among the most important of his early achievements in this field was the introduction, in 1746, of leaden condensing chambers for use in the manufacture of sulphuric acid. Together with Samuel Garbett he erected a factory at Prestonpans, near Edinburgh, for the production of the acid in 1749, and for some years enjoyed a monopoly; but ultimately his methods became known, and, having omitted to take out patents for

them at the proper time, he was unable to restrain others from making use of them. Engaging next in the manufacture of iron, he in 1760 established the ironworks which still exist at Carron, in Stirlingshire. There he introduced various improvements in the methods of production, including the conversion (patented in 1762) of cast iron into malleable iron "by the action of a hollow pit-coal fire" urged by a powerful artificial blast. His next enterprise was less successful. He leased a colliery at Bo'ness to supply coal to the Carron works, but in sinking for new seams encountered such quantities of water that the Newcomen engine which he used was unable to keep the pit clear. In this difficulty he heard of James Watt's engine and entered into communication with its inventor. This engine, then at an early stage of its development, also proved inadequate, but Roebuck became a strong believer in its future and in return for a two-thirds share in the invention assisted Watt in perfecting its details. His troubles at the colliery, however, aggravated by the failure of an attempt to manufacture alkali, brought him into pecuniary straits, and he parted with his share in Watt's engine to Matthew Boulton in return for the cancellation of a debt of £1200 which he owed the latter. Subsequently, though he had to give up his interest in the Bo'ness works, he continued to manage them and to reside at the neighbouring Kinnell House, where he occupied himself with farming on a considerable scale. He died on the 17th of July 1794.

ROEBUCK, JOHN ARTHUR (1801-1879), British politician, was born at Madras on the 28th of December 1801. After the death of his father, a civil servant, his mother's second marriage transferred him to Canada, where he was chiefly brought up. He came to England in 1824, was called to the bar (Q.C. 1843), became intimate with the leading radical and utilitarian reformers, was elected M.P. for Bath in 1832, and took up that general attitude of hostility to the government of the day, be it what it might, which he retained throughout his life. At all times conspicuous for his eloquence, honesty and recalcitrancy, he twice came with especial prominence before the public—in 1838, when, although at the time without a seat in parliament, he appeared at the bar of the Commons to protest, in the name of the Canadian Assembly, against the suspension of the Canadian constitution; and in 1855, when, having overthrown Lord Aberdeen's ministry by carrying a resolution for the appointment of a committee of inquiry into the mismanagement in the Crimean War, he presided over its proceedings. In his latter years his political opinions became greatly modified, but with one interruption he retained his seat for Sheffield, which he had won in 1849, until his death in London on the 30th of November 1879.

ROE-BUCK, the smallest of the British deer (a full-grown buck standing not more than 27 in. high at the shoulder), the typical representative of a genus (*Capreolus*) in which the antlers lack a brow-tine and belong to what is characterized as the forked type, while the tail is rudimentary (see DEER). The antlers are short, upright and deeply furrowed, the beam forking at about two-thirds of its length, and the upper prong again dividing, thus making three points. The coat in summer is foxy red above and white below; in winter this changes to a greyish fawn, with a white rump-patch. The roe-buck or roe-deer (*Capreolus capreo*, or *C. capreolus*) inhabits southern and temperate Europe as far east as the Caucasus, where, as in Syria, it is probably represented by another race or species. It frequents woods, preferring such as have a large growth of underwood and are in the neighbourhood of cultivated ground. The latter it visits in the evening in search of food; and where roe are numerous the damage done to growing crops is considerable. Pairing takes place in August, but the fawns are not born till the following May. According to one theory, the germ lies dormant until December, when it begins to develop; but it is now believed that this long gestation is due to slow rather than arrested development. Roe were formerly abundant in all the wooded parts of Great Britain, but were gradually exterminated, till a century and a half ago they were unknown

south of Perthshire. Since then the increase of plantations has led to the partial restoration of the species in the south of Scotland and the north of England; and it was reintroduced into Dorset early in the 19th century. These deer take readily to the water, and they have been known to swim across lochs more than half a mile in breadth. The Siberian roe (*C. pygargus*), which is common in the Altai, is larger and paler than the type species, with shorter and more hairy ears, a larger white rump-patch, and small irregular snags on the inner border of the antlers. The Manchurian roe (*Capreolus manchuricus*) is about the size of the European species, with antlers of the type of those of the Siberian roe, but more slender, and the coat shorter. Although described in 1889 as a local variety of the Siberian species, the Manchurian roe really appears, both as regards stature, hairiness and the black and white markings on the muzzle, the much more nearly related to the European animal. This is the more remarkable seeing that the habitats of the two are separated by such an enormous tract of country. (R. L.*)

ROEDERER, PIERRE LOUIS, COMTE (1754-1835), French politician and economist, was born at Metz on the 15th of February 1754, the son of a magistrate. At the age of twenty-five he became councillor at the parlement of Metz, and was commissioned in 1787 to draw up a list of remonstrances. His work advocating the suppression of internal customs houses (*Suppression des douanes intérieures*), published the same year, is an elaborate treatise on the laws of commerce and on the theory of customs imposts. In 1788 he published *Députation aux États généraux*, a pamphlet remarkable for its bold exposition of liberal principles, and partly on the strength of this he was elected deputy to the states-general by the Third Estate of the *bailliage* of Metz. In the Constituent Assembly he was a member of the committee of taxes (*comité des contributions*), prepared a scheme for a new system of taxation, drew up a law on patents, occupied himself with the laws relating to stamps and *assignats*, and was successful in opposing the introduction of an income tax. After the close of the Constituent Assembly he was elected, on the 11th of November 1791, *procureur général syndic* of the department of Paris. The directory of the department, of which the duc de la Rochefoucauld was president, was at this time in pronounced opposition to the advanced views that dominated the Legislative Assembly and the Jacobin Club, and Roederer was not altogether in touch with his colleagues. Thus he took no share in signing their protest against the law against the non-juring clergy, as a violation of religious liberty. But the directory did not long survive. With the growing anarchy of the capital many of its members resigned and fled, and their places could not be filled up. Roederer himself has left in his *Chronique des cinquante jours* (1832) an account of the pitiable part played by the directory of the department in the critical period between the 20th of June and the 10th of August 1792. Seeing the perilous drift of things, he had tried to get into touch with the king; and it was on his advice that Louis, on the fatal 10th, took refuge in the Assembly. His conduct arousing suspicion, he went into hiding, and did not emerge again until after the fall of Robespierre. In 1796 he was made a member of the Institute, was appointed to a professorship of political economy, and founded the *Journal d'économie publique, de morale et de législation*. Having escaped deportation at the time of the *coup d'état* of 18 Fructidor, he took part in the revolution of 18 Brumaire, and was appointed by Napoleon member of the council of state and senator. Under the Empire, Roederer, whose public influence was very considerable, was Joseph Bonaparte's minister of finance at Naples (1806), administrator of the grand duchy of Berg (1810), and imperial commissary in the south of France. During the Hundred Days he was created a peer of France. The Restoration government stripped him of his offices and dignities, but he recovered the title of peer of France in 1832. He died on the 17th of December 1835. His son, Baron Antoine Marie Roederer

(1782-1865), was also a politician of some note in his day.

Among P. L. Roederer's writings may be mentioned *Louis XII.* (1820); *François I.* (1825); *Comédies historiques* (1827-30); *L'Esprit de la révolution de 1789* (1831); *La Première et la deuxième année du consulat de Bonaparte* (1802); *Chronique des cinquante jours*, an account of the events of the 10th of August 1792; and *Mémoire pour servir à l'histoire de la société polie en France* (1855). See his *Œuvres*, edited by his son (Paris, 1853 seq.); *Sainte-Beuve, Causeries du lundi*, vol. viii.; M. Mignet, *Notices historiques* (Paris, 1853).

ROEMER, FRIEDRICH ADOLPH (1809-1869), German geologist, was born at Hildesheim, in Prussia, on the 14th of April 1809. His father was a lawyer and councillor of the high court of justice. In 1845 he became professor of mineralogy and geology at Clausthal, and in 1862 director of the School of Mines. He first described the Cretaceous and Jurassic strata of Germany in elaborate works entitled *Die Versteinerungen des Norddeutschen Oolithen-gebirges* (1836-30), *Die Versteinerungen des Norddeutschen Kreidegebirges* (1840-1841) and *Die Versteinerungen des Harzgebirges* (1843). He died at Clausthal on the 25th of November 1869.

His brother, **CARL FERDINAND von ROEMER** (1818-1891), who had been educated for the legal profession at Göttingen, also became interested in geology, and abandoning law in 1840, studied science at the university of Berlin, where he graduated Ph.D. in 1842. Two years later he published his first work, *Das Rheinische Übergangsgebirge* (1844), in which he dealt with the older rocks and fossils. In 1845 he paid a visit to America, and devoted a year and a half to a careful study of the geology of Texas and other Southern states. He published at Bonn in 1849 a general work entitled *Texas*, while the results of his investigations of the Cretaceous rocks and fossils were published three years later in a treatise, *Die Kreidebildungen von Texas und ihre organischen Einschlüsse* (1852), which included also a general account of the geology, and gained for him the title "Father of the geology of Texas." Subsequently he published at Breslau *Die Silurische Fauna des westlichen Tennessee* (1860). During the preparation of these works he was from 1847 to 1855 "privat-docent" at Bonn, and was then appointed professor of geology, palaeontology and mineralogy in the university of Breslau, a post which he held with signal success as a teacher until his death. As a palaeontologist he made important contributions to our knowledge especially of the invertebrata of the Devonian and older rocks. He assisted H. G. Bronn with the third edition of the *Lethæa geognostica* (1851-56), and subsequently he laboured on an enlarged and revised edition, of which he published one section, *Lethæa palæozoica* (1876-1883). In 1862 he was called on to superintend the preparation of a geological map of Upper Silesia, and the results of his researches were embodied in his *Geologie von Oberschlesien* (3 vols., 1870). As a mineralogist he was likewise well known, more particularly by his practical teachings and by the collection he formed in the Museum at Breslau. He died at Breslau on the 14th of December 1891.

ROEMER, OLE (Latinized OLAUS) (1644-1710), Danish astronomer, was born at Aarhus in Jutland on the 25th of September 1644. He became in 1662 the pupil and amanuensis of Erasmus Bartholinus at Copenhagen, and assisted J. Picard in 1671 to determine the geographical position of Tycho Brahe's observatory (Uraniborg on the island of Hveen). In 1672 he accompanied Picard to Paris, where he remained nine years, occupied with observations at the new royal observatory and hydraulic works at Versailles and Marly. On the 22nd of November 1675 he read a paper before the Academy on the successive propagation of light as revealed by a certain inequality in the motion of the first of Jupiter's satellites. A scientific mission to England in 1679 made him acquainted with Newton, Halley and Flamsteed. In 1681, on the summons of Christian V., king of Denmark, he returned to Copenhagen as royal mathematician and professor of astronomy in the university; and from 1688 he discharged, besides, many important admini-

strative functions, including those of mayor (1705), chief of police and privy councillor. He died at Copenhagen on the 23rd of September 1710.

Roemer will always be remembered as the discoverer of the finite velocity of light. He showed besides wonderful ingenuity in the improvement of astronomical apparatus. The first transit instrument worthy the name was in 1690 erected in his house. In the same year he set up in the university observatory an instrument with altitude and azimuth circles (for observing equal altitudes on both sides of the meridian) and an equatorial telescope. In 1704 he built, at his own cost, the so-called "Tusculan" observatory at Vridløsemagle, a few miles west of Copenhagen, and equipped it with a meridian circle (the transit instrument and vertical circle combined) and a transit moving in the prime vertical. Roemer thus effectively realized nearly all our modern instruments of precision, and accumulated with them a large mass of observations, all of which unfortunately perished in the great conflagration of the 21st of October 1728, except the three nights' work discussed by J. G. Galle (*O. Roemeris triduum observationum astronomiarum a. 1706 institutarum*, Berlin, 1845).

See E. Philippen, *Nordisk Universitets Tidsskrift*, v. II (1860); P. Horrebow, *Basis Astronomiæ* (Copenhagen, 1735); J. B. J. Delambre, *Hist. de l'astr. moderne*, ii. 632; J. F. Montucla, *Hist. des mathématiques*, ii. 487, 579; R. Grant, *Hist. of Phys. Astronomy*, p. 461; R. Wolf, *Gesch. der Astronomie*, pp. 452, 489, 576; J. F. Weidler, *Historia Astronomiæ*, p. 538; W. Doberck, *Nature*, xvii. 105; C. Huygens, *Œuvres complètes*, t. viii. pp. 30-58; L. Ambronn, *Handbuch der astr. Instrumentenkunde*, ii. 552, 966; T. J. J. See, *Pop. Astronomy*, No. 105, May 1903.

ROERMOND, a town in the province of Limburg, Holland, on the right bank of the Maas at the confluence of the Roer, and a junction station 28 m. by rail N.N.E. of Maastricht. Pop. (1900) 12,348. The old fortifications have been dismantled and partly converted into fine promenades. At this point the Maas is crossed by a bridge erected in 1866-67, and the Roer by one dating from 1771, replacing an older structure, and connecting Roermond with the suburb of St. Jacob. Roermond is the seat of a Roman Catholic episcopal see. The finest building in the town is the Romanesque minster church of the first quarter of the 13th century. In the middle of the nave is the tomb of Gerhard III., count of Gelderland, and his wife Margaret of Brabant. It was formerly the church of a Cistercian nunnery, and in modern times has been elaborately restored. The cathedral of St. Christopher is also of note; on the top of the tower (246 ft.) is a copper statue of the saint, and the interior is adorned with paintings by Rubens, Jacob de Wit (1695-1754) and others. The Reformed church was once the chapel of the monastery of the Minorites. There is also a Redemptorist chapel. The old bishop's palace is now the courthouse, and the old Jesuits' monastery with its fine gardens a higher-burgher school. Woollen, cotton, silk and mixed stuffs, paper, flour and beer are manufactured at Roermond.

Close to Roermond on the west is the village of Horn, once the seat of a lordship of the same name, which is first mentioned in a document of 1166. The lordship of Horn was a fief of the counts of Loon, and after 1361 of the bishop of Liège; but in 1450 it was raised to a county by the Emperor Frederick II. On the extinction of the house of Horn in 1540, the county passed to the famous Philip of Montmorency, who, with the count of Egmont, was executed in Brussels in 1568 by order of the duke of Alva. In the beginning of the next century the county was forcibly retained by the see of Liège, and was incorporated in the French department of the Lower Maas at the end of the 18th century. The ancient castle is in an excellent state of preservation and is sometimes used for the assembly of the states.

ROGATION DAYS (Lat. *rogatio*, from *rogare*, to beseech; the equivalent of Gr. *Arxevia*, litany), in the Calendar of the Christian Church, the Monday, Tuesday and Wednesday before Ascension Day, so called because long associated with the chanting of litanies in procession (*rogationes*). The week in which they occur is sometimes called Rogation Week. In 511

the first Council of Orleans ordered that the three days preceding Ascension Day should be celebrated as rogation days with fasting and *rogationes*. All work was to be suspended that all might join in the processions. Leo III. (pope 795-816) introduced rogation days, but without the fasting, at Rome. St Augustine had earlier introduced the custom into the English Church, learning it on his way through Gaul. The Council of Clovesho in 747 confirmed Augustine's injunction, and ordered that the rogation days be kept up "according to the way of our fathers." The place-name "Gospel Oak," which occurs in London and elsewhere, is a relic of these rogation processions, the gospel of the day being read at the foot of the finest oak the parish boasted. After the Reformation the processions gradually ceased to be ecclesiastical in England, and are now practically secularized into the perambulation of the parish boundaries on or about Ascension Day.

See also PROCESSION and LITANY.

ROGER I. (1031-1101), ruler of Sicily, was the youngest son of Tancred of Hauteville. He arrived in Southern Italy soon after 1057. Malaterra, who compares Robert Guiscard (see **GUISCARD, ROBERT**) and his brother to "Joseph and Benjamin of old," says of Roger: "He was a youth of the greatest beauty, of lofty stature, of graceful shape, most eloquent in speech and cool in counsel. He was far-seeing in arranging all his actions, pleasant and merry all with men; strong and brave, and furious in battle." He shared with Robert Guiscard the conquest of Calabria, and in a treaty of 1062 the brothers in dividing the conquest apparently made a kind of "condominium" by which either was to have half of every castle and town in Calabria.¹ Robert now resolved to employ Roger's genius in reducing Sicily, which contained, besides the Moslems, numerous Greek Christians subject to Arab princes who had become all but independent of the sultan of Tunis. In May 1061 the brothers crossed from Reggio and captured Messina. After Palermo had been taken in January 1072 Robert Guiscard, as suzerain, invested Roger as count of Sicily, but retained Palermo, half of Messina and the north-east portion (the Val Demone). Not till 1085, however, was Roger able to undertake a systematic crusade. In March 1086 Syracuse surrendered, and when in February 1091 Noto yielded the conquest was complete. Much of Robert's success had been due to Roger's support. Similarly the latter supported Duke Roger, his nephew, against Bohemund, Capua and his rebels, and the real leadership of the Hautevilles passed to the Sicilian count. In return for his aid against Bohemund and his rebels the duke surrendered to his uncle in 1085 his share in the castles of Calabria, and in 1091 the half of Palermo. Roger's rule in Sicily was more real than Robert Guiscard's in Italy. At the enfeoffments of 1072 and 1092 no great undivided fiefs were created, and the mixed Norman, French and Italian vassals owed their benefices to the count. No feudal revolt of importance therefore troubled Roger. Politically supreme, the count became master of the insular Church. While he gave full toleration to the Greek Churches, he created new Latin bishoprics at Syracuse and Girgenti and elsewhere, nominating the bishops personally, while he turned the archbishopric of Palermo into a Catholic see. The Papacy, favouring a prince who had recovered Sicily from Greeks and Moslems, granted to him and his heirs in 1098 the Apostolic Legateship in the island. Roger practised general toleration to Arabs and Greeks, allowing to each race the expansion of its own civilization. In the cities the Moslems, who had generally secured such terms of surrender, retained their mosques, their kadis, and freedom of trade; in the country, however, they became serfs. He drew from the Moslems the mass of his infantry, and St Anselm visiting him at the siege of Capua, 1098, found "the brown tents of the Arabs innumerable." Nevertheless the Latin element began to prevail with the Lombards and other Italians who flocked into the island in the wake of the conquest, and the conquest of Sicily was decisive in the steady decline from this time of Mahomedan power in the western Mediterranean.

¹ See Chalandon, *La Domination normande*, vol. i. p. 200.

Roger, the "Great Count of Sicily," died on the 22nd of June 1101 in his seventieth year and was buried in S. Trinità of Mileto. His third wife, Adelaide, niece of Boniface, lord of Savona, gave him two sons, Simon and Roger, of whom the latter succeeded him.

See E. Caspar, *Roger II. und die Gründung der normannisch-sicilischen Monarchie* (Innsbruck, 1904). (E. C.)

ROGER II. (1093-1154), king of Sicily, son of the preceding, began personally to rule in 1112, and from the first aimed at uniting the whole of the Norman conquests in Italy. In June 1127, William, duke of Apulia, grandson of Robert Guiscard, died childless, having apparently made some vague promise of the succession to Roger. In any case Roger claimed at once, not only all the Hauteville possessions, but also the overlordship of Capua, for which Richard II. in 1098 had sworn homage to Duke Roger. The union of Sicily and Apulia, however, was resisted by Honorius II. and by the subjects of the duchy itself, averse from any strong ducal power, and the pope at Capua (Dec. 1127) preached a crusade against the claimant, setting against him Robert II. of Capua and Ranulf of Alife, or Avellino, brother-in-law of Roger, who proved himself the real leader of the revolt. The coalition, however, failed, and in August 1128 Honorius invested Roger at Benevento as duke of Apulia. The baronial resistance, which was backed by Naples, Bari, Salerno and other cities, whose aim was civic freedom, also gave way, and at Melfi (Sept. 1129) Roger was generally recognized as duke by Naples, Capua and the rest. He began at once to enforce order in the Hauteville possessions, where the ducal power had long been falling to pieces. For the binding together of all his states the royal name seemed essential, and the death of Honorius in February 1130, followed by a double election, seemed the decisive moment. While Innocent II. fled to France, Roger, with deep design, supported Anacletus II. The price was a crown, and on the 27th of September 1130 a bull of Anacletus made Roger king of Sicily. He was crowned in Palermo on the 25th of December 1130.

This plunged Roger into a ten years' war. Bernard of Clairvaux, Innocent's champion, built up against Anacletus and his "half heathen king" a coalition joined by Louis VI. of France, Henry I. of England and the emperor Lothar. Meanwhile the forces of revolt in South Italy drew to a head again. The rebels under Ranulf shamefully defeated the king at Nocera on the 24th of July 1132. Nevertheless, by July 1134 his terrific energy and the savagery of his Saracen troops forced Ranulf, Sergius, duke of Naples, and the rebels to submit, while Robert was expelled from Capua. Meanwhile Lothar's contemplated attack upon Roger had gained the backing of Pisa, Genoa and the Greek emperor, all of whom feared the growth of a powerful Norman kingdom. In February 1137 Lothar began to move south and was joined by Ranulf and the rebels; in June he besieged and took Bari. At San Severino, after a victorious campaign, he and the pope jointly invested Ranulf as duke of Apulia (Aug. 1137), and the emperor then retired to Germany. Roger, freed from the utmost danger, recovered ground, sacked Capua and forced Sergius to acknowledge him as overlord of Naples. At Rignano the indomitable Ranulf again utterly defeated the king, but in April 1139 Ranulf died, leaving none to oppose Roger, who subdued pitilessly the last of the rebels.

The death of Anacletus (25 Jan. 1138) determined Roger to seek the confirmation of his title from Innocent. The latter, invading the kingdom with a large army, was skillfully ambushed at Galuccio in the Garigliano (22 July 1139). This secured the king's object; on the 25th July the pope invested him as "Rex Siciliae ducatus Apuliae et principatus Capuae." The boundaries of the "regno" were finally fixed, by a truce with the pope in October 1144, at a line south of the Tronto and east of Terracina and Ceprano.

Roger, now become one of the greatest kings in Europe, made Sicily the leading maritime power in the Mediterranean. A powerful fleet was built up under several "admirals," or

"emirs," of whom the greatest was George of Antioch, formerly in the service of the Moslem prince of El Mehdiā. Mainly by him a series of conquests were made on the African coast (1135-53) which reached from Tripoli to Cape Bona. The second crusade (1147-48) gave Roger an opportunity to revive Robert Guiscard's designs on the Greek Empire. George was sent to Corinth at the end of 1147 and despatched an army inland which plundered Thebes. In June 1149 the admiral appeared before Constantinople and defied the Basileus by firing arrows against the palace windows. The attack on the empire had, however, no abiding results. The king died at Palermo on the 26th of February 1154, and was succeeded by his fourth son William.

Personally Roger was of tall and powerful build, with long fair hair and full beard. "He had," says Rornald of Salerno, "a lion face, and spoke with a harsh voice." With little or none of Robert Guiscard's personal valour, and living at intervals the life of an eastern Sultan, he yet showed to the full his uncle's audacity, diplomatic skill and determination. It is Roger II's distinction to have united all the Norman conquests into one kingdom and to have subjected them to a government scientific, personal and centralized. The principles of this are found in the Assizes of the kingdom of Sicily, promulgated at Ariano in 1140, which enforced an almost absolute royal power. At Palermo Roger drew round him distinguished men of various races, such as the famous Arab geographer Idrisi and the historian Nilus Doxopatrius. The king's active and curious mind welcomed the learned; he maintained a complete toleration for the several creeds, races and languages of his realm; he was served by men of nationality so dissimilar as the Englishman Thomas Brun, a kaid of the Curia, and, in the fleet, by the renegade Moslem Christodoulos, and the Antiochene George, whom he made in 1132 "amiratus amiratorum," in effect prime vizier. The Capella Palatina, at Palermo, the most wonderful of Roger's churches, with Norman doors, Saracenic arches, Byzantine dome, and roof adorned with Arabic scripts, is perhaps the most striking product of the brilliant and mixed civilization over which the grandson of the Norman Trancard ruled.

Contemporary authors are: Falco of Benevento, Alexander of Teleso, Rornald of Salerno and Hugo Falcandus, all in the *Scrittorei cronisti napoletani*, ed. Del Re, vol. I. See also E. Caspar, *Roger II. und die Gründung der normannisch-sicilischen Monarchie* (Innsbruck, 1904). (E. C. U.)

ROGER (d. 1139), bishop of Salisbury, was originally priest of a small chapel near Caen. The future King Henry I., who happened to hear mass there one day, was impressed by the speed with which Roger read the service, and enrolled him in his own service. Roger, though uneducated, showed great talent for business, and Henry, on coming to the throne, almost immediately made him chancellor (1101). Soon after Roger received the bishopric of Salisbury. In the Investitures controversy he skillfully managed to keep the favour of both the king and Anselm. Roger devoted himself to administrative business, and remodelled it completely. He created the exchequer system, which was managed by him and his family for more than a century, and he used his position to heap up power and riches. He became the first man in England after the king, and was in office, if not in title, justiciar. He ruled England while Henry was in Normandy, and succeeded in obtaining the see of Canterbury for his nominee, William of Corbeil. Duke Robert seems to have been put into his custody after Tinchebrai. Though Roger had sworn allegiance to Matilda, she disliked the Angevin connexion, and went over to Stephen, carrying with him the royal treasure and administrative system (1135). Stephen placed great reliance on him, on his nephews, the bishops of Ely and Lincoln, and on his son Roger, who was treasurer. The king declared that if Roger demanded half of the kingdom he should have it, but chafed against the overwhelming influence of the official clique whom Roger represented. Roger himself had built at Devizes the most splendid castle in Christendom. He and his nephews

seem to have secured a number of castles outside their own dioceses, and the old bishop behaved as if he were an equal of the king. At a council held in June 1139, Stephen found a pretext for demanding a surrender of their castles, and on their refusal they were arrested. After a short struggle all Roger's great castles were sequestered. But Henry of Winchester demanded the restoration of the bishop. The king was considered to have committed an almost unpardonable crime in offering violence to members of the church, in defiance of the scriptural command, "Touch not mine anointed." Stephen took up a defiant attitude, and the question remained unsettled. This quarrel with the church, which immediately preceded the landing of the empress, had a serious effect on Stephen's fortunes. The moment that the fortune of war declared against him, the clergy acknowledged Matilda. Bishop Roger, however, did not live to see himself avenged. He died at Salisbury in December 1139. He was a great bureaucrat, and a builder whose taste was in advance of his age. But his contemporaries were probably justified in regarding him as the type of the bishop immersed in worldly affairs, ambitious, avaricious, unfettered by any high standard of personal morality.

Roger's nephew Alexander (d. 1148), who became bishop of Lincoln in 1123, was a typical secular ecclesiastic of the middle ages, wealthy, proud, ambitious and ostentatious. He founded monasteries, built castles at Newark, Sleaford and Banbury, and restored his cathedral at Lincoln after the fire of 1145. He followed the policy of Roger, whose imprisonment he shared, and died after a visit to Pope Eugenius III. at Auxerre, early in 1148.

See Sir J. Ramsay's *Foundations of England*, vol. ii., and J. H. Round's *Geoffrey de Mandeville*.

ROGER (d. 1181), archbishop of York, known as Roger of Pont l'Évêque, was a member of the household of Theobald, archbishop of Canterbury, where he quarrelled violently with another future archbishop, Thomas Becket. In 1148 he was appointed archdeacon of Canterbury, and soon afterwards chaplain to King Stephen, who sent him on an errand to Rome in 1152; then in October 1154 he was consecrated archbishop of York in Westminster Abbey. When Henry II. entered upon his great struggle with Becket over the immunity of clerks from secular jurisdiction, he managed to secure the support of Roger, and having been appointed papal legate in England, the archbishop visited Pope Alexander III. and the French king, Louis VII., in his master's interests. In June 1170 he crowned the king's son Henry, in spite of prohibitions from the pope and from Becket, and for this act he was suspended. One authority declares that Roger, who was then with Henry II. in Normandy, instigated the murder of the rival archbishop, but he swore he was innocent of this crime. He quarrelled with Richard, the new archbishop of Canterbury, about the respective rights of the two archiepiscopal sees, until 1176, when the king arranged a truce between them; and he was constantly endeavouring to assert his supremacy over the Scottish church. The archbishop died at York on the 21st of November 1181. He was always loyal to Henry II., to whom he was very useful during the great rising of 1174; but he has been accused of avarice, and he was certainly not lacking in ambition.

Another English prelate of this name was ROGER, bishop of Worcester, a younger son of Robert, earl of Gloucester, and thus a grandson of the English king Henry I. In 1163 his cousin Henry II. appointed him bishop of Worcester, but almost alone of the English bishops he supported Thomas Becket and not the king during the quarrel between them in 1166. In 1167 he left England to share Becket's exile, but he soon returned to court, although he appears to have remained on friendly terms with the archbishop. He died at Tours in 1179.

ROGER OF HOVEDEN, or HOWDEN (fl. 1174-1201), English chronicler, was, to judge from his name and the internal evidence of his work, a native of Howden in the East Riding of Yorkshire. But nothing is known of him before the year 1174. He was then in attendance upon Henry II., by whom

he was sent from France on a secret mission to the lords of Galloway. In 1175 he again appears as a negotiator between the king and a number of English religious houses. The interest which Hoveden shows in ecclesiastical affairs and miracles may justify the supposition that he was a clerk in orders. This, however, did not prevent him from acting, in 1180, as a justice of the forests in the shires of Yorkshire, Cumberland and Northumberland. After the death of Henry II., it would seem that Hoveden retired from the public service, though not so completely as to prevent him from drawing on the royal archives for the history of contemporary events. About the year 1192 he began to compile his *Chronica*, a general history of England from 732 to his own time. Up to the year 1192 his narrative adds little to our knowledge. For the period 732-1148 he chiefly drew upon an extant, but unpublished chronicle, the *Historia Saxonum sive Anglorum post obitum Bedae* (British Museum MS. Reg. 13 A. 6), which was composed about 1150. From 1148 to 1170 he used the Melrose Chronicle (edited for the Bannatyne Club in 1835 by Joseph Stevenson) and a collection of letters bearing upon the Becket controversy. From 1170 to 1192 his authority is the chronicle ascribed to Benedictus Abbas (q.v.), the author of which must have been in the royal household at about the same time as Hoveden. Although this period was one in which Hoveden had many opportunities of making independent observations, he adds little to the text which he uses; except that he inserts some additional documents. Either his predecessor had exhausted the royal archives, or the supplementary searches of Hoveden were languidly pursued. From 1192, however, Hoveden is an independent and copious authority. Like "Benedictus," he is sedulously impersonal, and makes no pretence to literary style, quotes documents in full and adheres to the annalistic method. His chronology is tolerably exact, but there are mistakes enough to prove that he recorded events at a certain distance of time. Both on foreign affairs and on questions of domestic policy he is unusually well informed. His practical experience as an administrator and his official connexions stood him in good stead. He is particularly useful on points of constitutional history. His work breaks off abruptly in 1201, though he certainly intended to carry it further. Probably his death should be placed in that year.

See W. Stubbs's edition of the *Chronica* (Rolls Series) and the introductions to vols. i. and iv. This edition supersedes that of Sir H. Savile in his *Scriptores post Bedam* (1596). (H. W. C. D.)

ROGER OF WENDOVER (d. 1236), English chronicler, was probably a native of Wendover in Buckinghamshire. At some uncertain date he became a monk of St Albans; afterwards he was appointed prior of the cell of Belvoir, but he forfeited this dignity in the early years of Henry III., having been found guilty of wasting the endowments. His latter years were passed at St Albans, where he died on the 6th of May 1236. He is the first of the important chroniclers who worked in the scriptorium of this house. His great work, the *Flores Historiarum*, begins at the creation and extends to 1235. It is of original value from 1202. Some critics have supposed, but on inconclusive evidence, that Wendover copied, up to 1189, an earlier compilation, the work of John de Cella, the twenty-first abbot of St Albans (1105-1214). Wendover's work is known to us through one 13th-century manuscript in the Bodleian library (Douce MS. 207), a mutilated 14th-century copy in the British Museum (Cotton MS. Otho B. v.), and the edition prepared by Matthew Paris which forms the first part of that writer's *Chronica Majora* (ed. H. R. Luard, Rolls Series, 7 vols.). The best edition of Wendover is that of H. O. Coxe (4 vols., London, 1841-42); there is another (from 1154) in the Rolls Series by H. G. Hewlett (3 vols., 1886-89). Wendover is a copious but inaccurate writer, less prejudiced but also less graphic than Matthew Paris. Where he is the sole authority for an event, he is to be used with caution.

See Luard's prefaces to vols. i., ii., iii. and vii. of the *Chronica Majora*; and the *Monumenta Germaniae Historica, Scriptores*, Band xxviii. pp. 3-20. (H. W. C. D.)

ROGERS, HENRY (1806-1877), English Nonconformist divine, was born at St Albans on the 18th of October 1806, and was educated privately and by his father, a surgeon of considerable culture. Rogers was meant to follow his father's profession, but the reading of John Howe turned him to theology, and after qualifying at Highbury College he accepted a call to the Congregational Church at Poole in 1820. In 1832 he was appointed lecturer in logic at Highbury, in 1836 professor of English at University College, London, and in 1839 professor of English, mathematics and mental philosophy at Spring Hill College, Birmingham. In 1836 appeared his *Life and Character of John Howe*, and in 1837 *The Christian Correspondent*, a collection of some 400 religious letters "by eminent persons of both sexes." His contributions to the *Edinburgh Review* began in 1839 and were collected in volume form in 1850, 1855 and 1874. His most famous book, *The Eclipse of Faith, or a Visit to a Religious Sceptic*, was published anonymously in 1852 and went through six editions in three years. It drew a *Reply* from F. W. Newman, which Rogers answered in a *Defence* (1854). Two volumes of imaginary letters, *Selections from the Correspondence of R. E. H. Greyson* (an anagram for his own name), appeared in 1857 and show his style at its best. In 1858 he became principal and professor of theology at the Lancashire Independent College, where he edited the works of John Howe (6 vols., 1862-63) and wrote for the *British Quarterly*. He retired in 1871, and died at Machynlleth on the 21st of August 1877. Rogers was widely read, and as a Christian apologist carried on the traditions of the 18th century as illustrated by Butler.

See Memoir by Dr R. W. Dale, prefixed to the 8th edition of *The Supernatural Origin of the Bible Inferred from Itself* (the Congregational Lecture for 1873, delivered by Rogers).

ROGERS, HENRY DARWIN (1808-1866), American geologist, was born at Philadelphia on the 1st of August 1808. At the age of twenty-one he was chosen professor of chemistry and natural philosophy at Dickinson College, Pennsylvania. After holding this post for three years, he went to Europe and took up the study of geology. Subsequently he was engaged for twenty-two years in the State surveys of Pennsylvania and New Jersey, his Reports on which were published during the years 1836-41. In 1842 he and his brother WILLIAM BARTON ROGERS (1805-1882), who had been similarly occupied in Virginia (his Reports were published in 1838-41, and he wrote also on the connexion between thermal springs and anticlinal axes and faults), brought before the Association of American Geologists and Naturalists their conclusions on the physical structure of the Appalachian chain, and on the elevation of great mountain chains. The researches of H. D. Rogers were elaborated in his final *Report on Pennsylvania* (1858), in which he included a general account of the geology of the United States and of the coal-fields of North America and Great Britain. In this important work he dealt also with the structure of the great coal-fields, the method of formation of the strata, and the changes in the character of the coal from the bituminous type to anthracite. In 1857 he was appointed professor of natural history and geology at Glasgow. One of his later essays (1861) was on the parallel roads of Lochaber (Glen Roy), the origin of which he attributed to a vast inundation. He died at Glasgow on the 29th of May 1866.

ROGERS, JAMES EDWIN THOROLD (1823-1890), English economist, was born at West Meon, Hampshire, in 1823. He was educated at King's College, London, and Magdalen Hall, Oxford. After taking a first-class degree in 1846, he was ordained, and was for a few years a curate in Oxford. Subsequently, however, he resigned his orders. For some time the classics were the chief field of his activity. He devoted himself a good deal to classical and philosophical tuition in Oxford with success, and his publications included an edition of Aristotle's *Ethics* (in 1865). Simultaneously with these occupations he had been diligently studying economics, with

the result that in 1859 he was appointed professor of statistics and economic science at King's College, London, a post which he filled till his death. From 1862 to 1867 he also held the position of Drummond professor of political economy at Oxford. During that period he published (in 1866) the first two volumes of his *History of Agriculture and Prices in England*, dealing with the period 1259-1400, a minute and masterly record of the subject, and the work upon which his reputation mainly rests. Two more volumes (1401-1582) were published in 1882, a fifth and sixth (1583-1702) in 1887, and he left behind him at his death copious materials for a seventh and eighth. In 1868 he published a *Manual of Political Economy*, and in 1869 an edition of Adam Smith's *Wealth of Nations*. In 1875 he collected and edited the *Protests of the Lords*. An intimate acquaintance with Cobden and John Bright led Rogers to take an active part in politics: he represented Southwark in parliament from 1880 to 1885, and Bermondsey from 1885-86, as an advanced Liberal. In 1888, on the death of Professor Bonamy Price, who had succeeded him at Oxford as professor of political economy, he was re-elected to the post, and held it till his death. Previously (in 1883) he had been appointed lecturer in political economy at Worcester College, Oxford. His latter years were mainly spent at Oxford, where he died on the 12th of October 1890. He was celebrated as a caustic wit and humorist. Of his miscellaneous economic and historical writings, which were numerous, the most noteworthy is his *Six Centuries of Work and Wages*, published in 1884. As an economist, Thorold Rogers did much to promote the historical study of his subject. He was, however, apt to be guided too frequently by political prejudice, and the value of his work suffered from his aggressively contentious spirit.

ROGERS, JOHN (1627-c. 1665), English preacher, second son of Nehemiah Rogers, a royalist and Anglican clergyman, was born at Messing in Essex, and became a servitor and student of medicine at King's College, Cambridge. When still a youth the violence of his religious despair led him to attempt suicide and ended in his joining the extreme sect of the Puritans. Deprived of his home in 1642, he walked to Cambridge, and found the college establishment broken up; he nearly starved, but obtained in 1643 a scholastic post in Lord Brudenel's house in Huntingdonshire, and subsequently at St Neot's free school. He became known as a preacher, received Presbyterian ordination in 1647, married a daughter of Sir Robert Payne of Midloe in Huntingdonshire, and obtained the living of Purlleigh in Essex. Subsequently he came to London, joined the Independents, became lecturer at St Thomas Apostle's, and attracted attention by the violence of his political sermons. He was appointed preacher to Christ Church Cathedral in Dublin by the parliament in 1651, and while there served in the field, returning in 1652 to St Thomas Apostle's on account of religious dissensions. In 1653 his parishioners at Purlleigh, where he had hitherto managed to retain the living, successfully proceeded against him for non-residence. In the quarrel between the army and the parliament Rogers had naturally sided with the former, and he was one of the first to join the Fifth Monarchy movement. He approved of the expulsion of the Long Parliament, and addressed two letters to Cromwell on the subject of the new government to be inaugurated, but the establishment of the Protectorate at once threw the Fifth Monarchy men into antagonism. Rogers addressed a warning letter to Cromwell, and boldly attacked him from the pulpit on the 9th of January 1654. Thereupon his house was searched and his papers seized, and Rogers then issued another denunciation against Cromwell, *Mene, Tekel, Perez: a Letter lamenting over Oliver Lord Cromwell*. On the 28th of March, on which day he had proclaimed a fast for the sins of the rulers, he preached a violent sermon against the protector, which occasioned his arrest in July. He confronted Cromwell with great courage when brought before him on the 5th of February 1655, and was imprisoned successively at Windsor and in the Isle of Wight, being released in January 1657. He returned to London, and, being suspected of a conspiracy, was again imprisoned

by Cromwell in the Tower from the 3rd of February 1658 till the 16th of April. On the protector's death and the downfall of Richard Cromwell, the ideals of the Fifth Monarchy men seemed nearer realization, but Rogers was engaged in political controversy with Prynne and became a source of embarrassment to his own faction, which endeavoured to get rid of him by appointing him "to preach the gospel" in Ireland. On the outbreak of Sir George Booth's royalist insurrection, however, he became chaplain in Charles Fairfax's regiment, and served throughout the campaign. He obtained a lectureship at Shrewsbury in October and was in Dublin in January 1660, being imprisoned there by order of the army faction and released subsequently by the parliament. At the Restoration he withdrew to Holland, studied medicine at Leiden and Utrecht, and obtained from the latter university the degree of M.D. in 1662. He returned to England the same year and resided at Bermondsey, was admitted to the degree of M.D. at Oxford in 1664, and is supposed, in the absence of further record, to have died soon afterwards.

Besides the pamphlet already cited, Rogers wrote in 1653 *Ohel or Bethshemesh, a Tabernacle for the Sun*, in which he attacked the Presbyterians, and *Sagrir, or Doomed day drawing nigh*, from his new standpoint as a Fifth Monarchy man, and was the author of *Challah, the Heavenly Nymph* (1653); *Dod, or Chathan; the Beloved or the Bridegroom going forth for his Bride* . . . (1653); *Prison-born Morning Beams* (1654); *Jeger Sahadath* . . . (1657); *Mr Prynne's Good Old Cause stated and stunted to Year ago* . . . (1660); *Macrobrevia, a Christian Conceration* (1659); *Mr Harrington's Parallel Unparalleled* (1659); *A Vindication of Sir H. Vane* (1659); *Disputatio Medica Inauguralis* (1662).

AUTHORITIES.—*Life and Opinions of a Fifth Monarchy Man*, by Ed. Rogers (1867), compiled from Rogers's own works; Wood, *Athenae Oxonienses and Fasts; Calendars of State Papers (Domestic)*. See also "English Ancestry of Washington," *Harper's Magazine*, xxi. 887 (1891); "John Rogers of Purlleigh," *The Nation*, vol. 53, p. 314 (1891).

ROGERS, JOHN (c. 1500-1555), English Protestant martyr, was born in the parish of Aston, near Birmingham, and was educated at Pembroke Hall, Cambridge, where he graduated B.A. in 1526. Six years later he was rector of Holy Trinity, Queenhithe, London, and in 1534 went to Antwerp as chaplain to the English merchants. Here he met William Tyndale, under whose influence he abandoned the Roman Catholic faith, and married an Antwerp lady. After Tyndale's death Rogers pushed on with his predecessor's English version of the Old Testament, which he used as far as 2 Chronicles, employing Coverdale's translation (1535) for the remainder and for the Apocrypha. Tyndale's New Testament had been published in 1526. The complete Bible was put out under the pseudonym of Thomas Matthew in 1537; it was printed in Antwerp, and Richard Grafton published the sheets and got leave to sell the edition (1500 copies) in England. Rogers had little to do with the translation, but he contributed some valuable prefaces and marginal notes. His work was largely used by those who prepared the Great Bible (1539-40), out of which in turn came the Bishop's Bible (1568) and the Authorized Version of 1611. After taking charge of a Protestant congregation in Wittenberg for some years, Rogers returned to England in 1548, where he published a translation of Melancthon's *Considerations of the Augsburg Interim*. In 1550 he was presented to the crown livings of St Margaret Moyses and St Sepulchre in London, and in 1551 was made a prebendary of St Paul's, where the dean and chapter soon appointed him divinity lecturer. He courageously denounced the greed shown by certain courtiers with reference to the property of the suppressed monasteries, and defended himself before the privy council. He also declined to wear the prescribed vestments, donning instead a simple round cap. On the accession of Mary he preached at Paul's Cross commending the "true doctrine taught in King Edward's days," and warning his hearers against "pestilent Popery, idolatry and superstition." Ten days after (16th August 1553), he was summoned before the council and bidden to keep within his own house. His emoluments were taken away and his prebend was filled in October. In January 1554 Bonner, the new bishop of London, sent him to Newgate, where he lay with

John Hooper, Laurence Saunders, John Bradford and others for a year, their petitions, whether for less rigorous treatment or for opportunity of stating their case, being alike disregarded. In December 1554 parliament re-enacted the penal statutes against Lollards, and on January 22nd, 1555, two days after they took effect, Rogers with ten others came before the council at Gardiner's house in Southwark, and held his own in the examination that took place. On the 28th and 29th he came before the commission appointed by Cardinal Pole, and was sentenced to death by Gardiner for heretically denying the Christian character of the Church of Rome and the real presence in the sacrament. He awaited and met death (on the 4th of February 1555 at Smithfield) cheerfully, though denied even an interview with his wife. Noailles, the French ambassador, speaks of the support given to Rogers by the greatest part of the people: "even his children assisted at it, comforting him in such a manner that it seemed as if he had been led to a wedding." He was the first Protestant martyr of Mary's reign, and his friend Bradford wrote that "he broke the ice valiantly."

The following divines of the same name may be distinguished:—**JOHN ROGERS** (1572?–1603), Puritan vicar of Dedham, Essex, "one of the most awakening preachers of the age."—**JOHN ROGERS** (1610–1680), ejected vicar of Croftin, Cumberland, and the founder of Congregational churches in Teesdale and Weardale, where he evangelized the lead miners.—**JOHN ROGERS** (1679–1729), one of George II.'s chaplains, famous for his share in the Bangor controversy (1719), his *Vindication of the Civil Establishment of Religion* (1728), and his *Persuasive to Conformity*, addressed to Dissenters (1736) and to Quakers (1747).—**JOHN ROGERS** (1740?–1814), leader of the Irish seceding divines, minister of Cahans, Co. Monaghan.—**JOHN ROGERS** (1778–1856), rector of Mawnan, Cornwall, and the owner of the Penrose and Helston estates; a good botanist and mineralogist, and a distinguished Hebrew and Syriac scholar.

ROGERS, JOHN (1820–1904), American sculptor, was born at Salem, Massachusetts, on the 30th of October 1820. In 1848 he became an apprentice in a machine shop at Manchester, New Hampshire, and remained there for about ten years. During the latter part of this time he had done some modelling in clay in his leisure hours, and, having decided to become a sculptor, he spent eight months in Rome and Paris in 1848–50. Becoming discouraged, he returned to America and obtained employment as a draughtsman in the office of the city surveyor of Chicago; but soon afterwards, owing to the favourable reception of his group of small figures, "The Checker Players," he resumed sculptural work, confining himself to these small figures, known as "Rogers Groups," which had an enormous popular success and were extensively reproduced. The Civil War in America gave him patriotic themes that increased his vogue and prosperity, and in 1863 he became a National Academician. His subjects were familiar scenes and incidents of home life known to the masses, and the reproductions of his groups were sold in the most remote districts as well as in the larger cities. He executed several life-sized statues, including "General John F. Reynolds" and a seated figure of Lincoln, both in Philadelphia; but it is by his statuettes that he is best remembered, and these were characterized by sentiment and human interest rather than any genuine artistic feeling. He died at New Haven, Connecticut, on the 27th of July 1904.

ROGERS, ROBERT (1727–1784?), American frontier soldier, was born of Irish parentage in 1727, probably at Methuen, Massachusetts, whence his father, James Rogers (often confused with James Rogers, an early settler of Londonderry, N.H.), removed in 1730 to Starktown (now Dunbarton), New Hampshire. During the Seven Years' War he raised and commanded a force of militia, known as Rogers' Rangers, which won a wide reputation for its courage and endurance in the campaigns about Lake George. He took part in Wolfe's expedition against Quebec, and on the 4th of October 1759 he destroyed an Abnaki Indian village on the St Francis river near its mouth and killed about 200 of its inhabitants. After the Montreal campaign of 1760, in which he served, he was sent by General Amherst to take possession of the north-western posts, occupied Detroit on the 20th of November, and later returned to the east. In 1763, during the Pontiac uprising, he accom-

panied the relief expedition under James Dalyell to Detroit and took part in the battle of Bloody Bridge on the 31st of July (see PONTIAC). Soon after this he went to England, and in 1765 published in London a *Concise Account of North America, containing a Description of the Several British Colonies . . . also an Account of the Several Nations and Tribes of Indians* (new edition, Albany, 1883). In 1766–68 he was commandant of Michilimackinac. He spent the next few years in England, and after 1772 was in the service of the dey of Algiers. At the beginning of the War of Independence he returned to America, and in spite of his protestations of patriotism was considered by Washington and others a Loyalist spy. He was arrested by agents of Congress, but was paroled. His re-arrest he considered a release from his parole. He then openly joined the British, and under a commission from General Howe organized a regiment of Loyalists which was known as the Queen's Rangers, and which after his return to England in 1776 was commanded by Capt. John G. Simcoe. In 1779 he was commissioned to raise a regiment to be called the King's Rangers, and he returned for a short time to America; but the command of the Rangers, which soon became a part of the garrison of St John's, Quebec, was taken by his brother James (d. 1792), who had formerly served under Robert. Rogers died in London probably in 1784.

In addition to the *Concise Account of North America*, he published his *Journals* (London, 1765), and is supposed to have written, at least in part, *Ponteach, or the Savages of America, a Tragedy* (London, 1766). See also his "Journal" in the *Diary of the Siege of Detroit in the War with Pontiac* (Albany, 1860; new edition, 1883), edited by F. B. Hough; and Francis Parkman, *Montcalm and Wolfe* (2 vols., Boston, 1884).

ROGERS, SAMUEL (1763–1855), English poet, was born at Newington Green, London, on the 30th of July 1763. His father, Thomas Rogers, was the son of a Stourbridge glass manufacturer, who was also a merchant in Cheapside. Thomas Rogers had a place in the London business, and married Mary, the only daughter of his father's partner, Daniel Radford, becoming himself a partner shortly afterwards. On his mother's side Samuel Rogers was connected with the two well-known Nonconformist divines Philip and Matthew Henry, and it was in Nonconformist circles at Stoke Newington that he was brought up. He was educated at private schools at Hackney and Stoke Newington. He wished to enter the Presbyterian ministry, but at his father's desire he joined the banking business in Cornhill. In long holidays, necessitated by delicate health, Rogers became a diligent student of English literature, particularly in Johnson, Gray and Goldsmith. Gray's poems, he said, he had by heart. He had already made some contributions to the *Gentleman's Magazine*, when in 1786 he published a volume containing some imitations of Goldsmith and an "Ode to Superstition" in the manner of Gray. In 1788 his elder brother Thomas died, and Samuel's business responsibilities were increased. In the next year he paid a visit to Scotland, where he met Adam Smith, Henry Mackenzie, the Piozzis and others. In 1791 he was in Paris, and enjoyed a hurried inspection of the art collection of Philippe Egalité at the Palais Royal, many of the treasures of which were later on to pass into his possession. With Gray as his model, Rogers took great pains in polishing his verses, and six years elapsed after the publication of his first volume before he printed his elaborate poem on *The Pleasures of Memory* (1792). This poem may be regarded as the last embodiment of the poetic dictation of the 18th century. Here is carried to the extremest pitch the theory of elevating and refining familiar themes by abstract treatment and lofty imagery. In this art of "raising a subject," as the 18th-century phrase was, the *Pleasures of Memory* is much more perfect than Thomas Campbell's *Pleasures of Hope*, published a few years later in imitation. The acme of positive praise for the fashionable serious poetry of the time was given by Byron when he said, "There is not a vulgar line in the poem."

In 1793 his father's death gave Rogers the principal share in the banking house in Cornhill, and a considerable income.

He left Newington Green in the same year and established himself in chambers in the Temple. In his circle of friends at this time were "Conversation" Sharp and the artists Flaxman, Opie, Martin Shee and Fuseli. He also made the acquaintance of Charles James Fox, with whom he visited the galleries in Paris in 1802, and whose friendship introduced him to Holland House. In 1803 he moved to 22 St James's Place, where for fifty years he entertained all the celebrities of London. Flaxman and Stothard had a share in the decorations of the house, which Rogers had almost rebuilt, and now proceeded to fill with pictures and other works of art. His collections at his death realized £50,000. An invitation to one of Rogers's breakfasts was a formal entry into literary society, and his dinners were even more select. His social success was due less to his literary position than to his powers as a conversationalist, his educated taste in all matters of art, and no doubt to his sarcastic and bitter wit, for which he excused himself by saying that he had such a small voice that no one listened if he said pleasant things. Above all, he seems to have had a genius for benevolence. "He certainly had the kindest heart and unkindest tongue of any one I ever knew," said Fanny Kemble. He helped the poet Robert Bloomfield, he reconciled Moore with Jeffrey and with Byron, and he relieved Sheridan's difficulties in the last days of his life. Moore, who refused help from all his friends, and would only be under obligations to his publishers, found it possible to accept assistance from Rogers. He procured a pension for H. F. Cary, the translator of Dante, and obtained for Wordsworth his sinecure as distributor of stamps.

It is difficult to realize the length of time that Rogers played the part of literary dictator in England. He made his reputation by *The Pleasures of Memory* when Cowper's fame was still in the making. He became the friend of Wordsworth, Scott and Byron, and lived long enough to give an opinion as to the fitness of Alfred Tennyson for the post of poet laureate. Alexander Dyce, from the time of his first introduction to Rogers, was in the habit of writing down the anecdotes with which his conversation abounded. From the mass of material thus accumulated he made a selection which he arranged under various headings and published in 1836 as *Recollections of the Table-Talk of Samuel Rogers, to which is added Porsoniana*. Rogers himself kept a notebook, in which he entered impressions of the conversation of many of his distinguished friends—Charles James Fox, Edmund Burke, Henry Crattan, Richard Porson, John Horne Tooke, Talleyrand, Lord Erskine, Sir Walter Scott, Lord Grenville and the duke of Wellington. They were published by his nephew William Sharpe in 1859 as *Recollections by Samuel Rogers; and Reminiscences and Table-Talk of Samuel Rogers, Banker, Poet, and Patron of the Arts, 1763-1855* (1903), by G. H. Powell, is an amalgamation of these two authorities. Rogers held various honorary positions: he was one of the trustees of the National Gallery; and he served on a commission to inquire into the management of the British Museum, and on another for the rebuilding of the Houses of Parliament.

Meanwhile his literary production was slow. A poem of some autobiographical interest, *An Epistle to a Friend* (Richard Sharp), published in 1798, describes Rogers's ideal of a happy life. This was followed twelve years later by *The Voyage of Columbus* (1810), and by *Jacqueline* (1814), a narrative poem, written in the four-accent measure of the newer writers, and published in the same volume with Byron's *Lara*. His reflective poem on *Human Life* (1819), on which he had been engaged for twelve years, is written in his earlier manner.

In 1814, Rogers made a tour on the Continent with his sister Sarah. He travelled through Switzerland to Italy, keeping a full diary of events and impressions, and had made his way to Naples when the news of Napoleon's escape from Elba obliged him to hurry home. Seven years later he returned to Italy, paying a visit to Byron and Shelley at Pisa. Out of the earlier of these tours arose his last and longest work, *Italy*. The first part was published anonymously in 1822; the second, with his

name attached, in 1828. The production was at first a failure, but Rogers was determined to make it a success. He enlarged and revised the poem, and commissioned illustrations from J. M. Turner, Thomas Stothard and Samuel Prout. These were engraved on steel in the sumptuous edition of 1830. The book then proved a great success, and Rogers followed it up with an equally sumptuous edition of his *Poems* (1838). In 1850, on Wordsworth's death, Rogers was asked to succeed him as poet laureate, but declined the honour on account of his great age. For the last five years of his life he was confined to his chair in consequence of a fall in the street. He died in London on the 18th of December 1855.

A full account of Rogers is given in two works by P. W. Clayden, *The Early Life of Samuel Rogers* (1887) and *Rogers and his Contemporaries* (2 vols., 1889). One of the best accounts of Rogers, containing many examples of his caustic wit, is by Abraham Hayward in the *Edinburgh Review* for July 1856. See also the Aldine edition (1857) of his *Poetical Works*, and the *Journals of Byron and of Moore*.

ROGERS, WILLIAM (1810-1896), English clergyman and educational reformer, was born in London on the 24th of November 1810, the son of a barrister. Educated at Eton and at Balliol College, Oxford, he entered Durham University in 1842, to study theology, and was ordained in 1843. In 1845 he was appointed to St Thomas Charterhouse, where he remained for eighteen years, throwing himself passionately into the work of education of his poor, degraded and often criminal parishioners. He began by establishing a school for ragamuffins in a blacksmith's abandoned shed, and with the generous help of friends he gradually extended its scope until the whole parish was a network of schools. In 1858 he was appointed a member of the Royal Commission to inquire into popular education, and he was returned a representative of the London School Board after the passing of Forster's Act in 1870. In 1863 the bishop of London gave him the living of St Botolph Bishopsgate. Rogers was also made a prebendary of St Paul's, and in 1857 he had been appointed Chaplain in Ordinary to the Queen. Having largely solved at St Thomas's the problem of elementary education, at Bishopsgate Rogers tackled the no less difficult one of middle-class schools. He believed in secular education, leaving doctrinal training to parents and clergy. To the cry against "godless education," Rogers impulsively replied, "Hang theology; let us begin"; and his nickname of "Hang-theology Rogers" stuck to him for the rest of his life. The Cowper Street Schools, costing £20,000, were the practical result of his energy. His next great work was the reconstruction of Edward Alleyn's charity at Dulwich. The new college was opened in 1870; new buildings were erected for the lower school, and the lion's share of the work fell upon Rogers. The culmination of his labours was the opening, on his seventy-fifth birthday, of the Bishopsgate Institute, including a hall, with accommodation for 500 people and a reference and lending library. On the same day a portrait and gift of plate was made him at the Mansion House, before a distinguished gathering. Lord Rosebery, then Prime Minister, observed in his speech that though bishops and deaneries had not been the rector's lot, there was not a poor Jew in Houndsditch or Petticoat Lane whose face would not brighten when he saw him coming. When he died, on the 19th of January 1896, this might have served as an appropriate epitaph.

ROGIER, CHARLES LATOUR (1800-1885), Belgian statesman, descended from a Belgian family settled in the department of the Nord in France, was born at St Quentin on 17th August 1800. His father, an officer in the French army, perished in the Russian campaign of 1812; and the family moved to Liège, where the eldest son, Firmin, held a professorship. Charles, after being called to the Bar, founded, in collaboration with his lifelong friends, Paul Devaux and Joseph Lebeau, the journal *Mathieu Laensberg* (afterwards *Le Politique*), which by its ardent patriotism and its attacks on the Dutch administration soon acquired a widespread influence. When the insurrection of 1830 broke out at Brussels, Rogier put himself at the head of 150 Liégeois, and inscribing on his banner the motto,

"Vaincre ou mourir pour Bruxelles," he obtained arms from a local factory, and marched upon the capital. Here he took his place at once among the leaders of the revolutionary party. His influence saved the town-hall from pillage on 10th September. On the 24th a *commission administrative* was formed, of which Rogier became president. The energetic measures of this body and of its successor, the *gouvernement provisoire*, soon freed the greater part of the country from the Dutch troops. Rogier was sent in October to suppress an outbreak among the colliers of Hainaut, and then as delegate of the provisional government to Antwerp, where the citadel still held out for Holland. He succeeded in arranging an armistice, and then, in the exercise of the absolute power with which he was invested, reorganized the entire administration of the city. He sat for Liège in the National Congress, voted for the establishment of a hereditary monarchy, and induced the congress to adopt the principle of an elective second chamber. In the long-drawn debates on the bestowal of the crown he ranged himself on the side of Louis Philippe: he first supported the candidature of Otto of Bavaria, and on his rejection declared for the duc de Nemours. Finally, when Louis Philippe declined the crown on behalf of his son, Rogier voted with the majority for Leopold of Saxe-Coburg. In June 1831 he was appointed governor of the province of Antwerp, a post rendered exceptionally difficult by the continued presence of Dutch troops in the citadel. In October 1832 he was made minister of the interior in the Goblet-Devaux cabinet. In the following June he intervened in a quarrel in the chamber of deputies between Devaux and the Opposition leader, Alexandre Gendebien, claimed a prior right to give satisfaction, and fought a duel, in which he was severely wounded. During his term of office he carried, in the teeth of violent opposition, a law that established in Belgium the first railways on the continent of Europe, and thus laid the foundation of her industrial development. Owing to dissensions in the cabinet, he retired in 1834, together with Lebeau, and resumed the governorship of Antwerp. On Lebeau's return to power in 1840, Rogier became minister of public works and education. The proposals that he made in the latter capacity were defeated by the determined opposition of the Clerical party, and on the resignation of the ministry in 1841, Rogier gave his support to a compromise on the subject of education, which passed into law in 1842. He led the Liberal party in Opposition till 1847, when he formed a cabinet in which he held the ministry of the interior. He at once embarked on a programme of political and economic reform. He took effective steps to remedy the industrial distress caused by the decay of the Flemish linen trade. The limits of the franchise were extended; and as the result of the liberal policy of the government Belgium alone escaped the revolutionary wave that spread over the Continent in 1848. He passed a law in 1850 organizing secondary education under the control of the State, and giving the clergy only the right of religious instruction. The Clerical party, though unable to defeat this measure, succeeded in shaking the position of the cabinet; and it was finally undermined, after Prince Louis Napoleon's *coup d'état* of 1851, by the hostility of the French government, which found its political exiles welcomed by the liberal cabinet at Brussels. Rogier retired in October 1852, but was brought back into office by the liberal reaction of 1857. He again became president of the council and minister of the interior in a cabinet of which Frère-Orban was the most conspicuous member. The first important measure passed by the ministry was one for the fortification of Antwerp. In 1860 the fear of French designs on the independence of Belgium led to a movement of reconciliation with Holland, and inspired Rogier to write the only one of his numerous poems that is likely to survive, his national anthem, "La Nouvelle Brabançonne." Some of the ministers resigning in 1861, on the question of recognizing the kingdom of Italy, the cabinet was reconstructed, and Rogier exchanged the ministry of the interior for that of foreign affairs. In this capacity he achieved a diplomatic triumph in freeing the navigation of the Scheldt, and thus enabling Antwerp to become the second port on the mainland of Europe. Defeated at

Dinant, he sat for Tournai from 1863 till his death. His younger and more energetic colleague, Frère-Orban, gradually overshadowed his chief, and in 1868 Rogier finally retired from power. He continued, however, to take part in public life, and was elected president of the extraordinary session of the chamber of representatives in 1878. From this time his age, his devoted patriotism and the unassuming simplicity of his life made him the idol of all classes. The fiftieth anniversary of the kingdom of Belgium in 1880, and two years later that of his entry into parliament, were the occasion of demonstrations in his honour. He died at Brussels on the 27th of May 1885, and his remains were accorded a public funeral.

See T. Juste, *Charles Rogier, 1800-1885, d'après des documents inédits* (Verviers, 1885).

ROGUE, a word which came into use about the middle of the 16th century as a slang or "cant" term for a vagrant vagabond, answering to the modern "tramp," and was adopted into English legal phraseology together with "vagabond" in the Statute of Elizabeth 1572, "rogue and vagabond" and "incorrigible rogue" remaining as legal terms for certain classes of persons amenable to the law under the Vagrancy Acts (see VAGRANCY). The act of Elizabeth defined "rogues, vagabonds and sturdy beggars" as including "idle persons going about and using subtle craft and unlawful games and all persons whole and mighty in body, but having neither land nor master, nor able to give an account how they get their living and all common labourers using loitering and refusing to work for the wages commonly given" (Sir G. Nicholls' *History of the English Poor Law*, ed. 1898 by H. G. Willink, vol. 1, 150). The word has now the general meaning of a knave or rascal, though also used (by meiosis) as a term of playful or tender banter and in various special applications (e.g. a "rogue" elephant, one who has been driven out by the herd and lives a solitary life, becoming very savage and destructive. Gardeners also apply the word to a plant which does not come true from seed, showing some variation from the type).

The derivation of the word has been much disputed. It has usually been referred to Fr. *rogue*, meaning proud, arrogant, which is variously derived from the Icelandic *hroke*, rook, long-winded talker, or Breton *rok*, proud, haughty; cf. Irish and Gaelic *ruca*s, pride. The *New English Dictionary*, however, rejects this derivation, and considers possible a connexion with another early "cant" word "roger," a begging vagabond pretending to be a poor university scholar.

ROHAN, the name of one of the most illustrious of the feudal families of France, derived from that of a small town in Morbihan, Brittany. The family appears to have sprung from the viscounts of Porhoët, and claims connexion with the ancient sovereigns of Brittany. Since the 12th century it held an important place in the history of Brittany, and strengthened its position by alliances with the greatest houses in France. It was divided into several branches, the eldest of which, that of the viscounts of Rohan, became extinct in 1527. Of the younger branches the most famous is that of Guéméné, from which sprang the branches of Montbazou, Soubise and Gié. The seigneurs of Frontenay, an offshoot of this last branch, inherited by marriage the property of the eldest branch of the house. Hercule de Rohan, duc de Montbazou (1568-1654) served Henry III. and Henry IV. against the League, and was made by Henry IV. governor of Paris and the Isle of France, and master of the hounds. His grandson, Louis de Rohan-Guéméné, the chevalier de Rohan, who was notorious for his dissolute life, conspired with the Dutch against Louis XIV. and was beheaded in Paris in 1674. In the 18th century the Soubise branch furnished several prelates, cardinals and bishops of Strassburg, among others the famous cardinal de Rohan, the hero of the affair of the diamond necklace. The seigneurs of Gié, a branch founded by Pierre de Rohan (1453-1513), a cadet of the branch of Guéméné and marshal of France, were conspicuous on the Protestant side during the wars of religion. René de Rohan, seigneur of Pontivy and Frontenay, commanded the Calvinist army in 1570, and

defended Lusignan with great valour when it was besieged by the Catholics (1574-75). His son Henry, the first duke of Rohan, also distinguished himself in the Protestant army. His only child, Marguerite de Rohan, married in 1645 Henry Chabot, a cadet of a great family of Poitou. This marriage was opposed by her mother, Marguerite de Béthune, who put forward a rival heir called Tancred, whom she claimed to be her son by the duke of Rohan. This Tancred perished in the Fronde in 1649. The property and titles of Henry de Rohan thus passed to the Chabot family, which under the name of Rohan-Chabot produced some distinguished soldiers and a cardinal archbishop of Besançon. The male line of the Rohans is now represented by an offshoot of the Rohan-Guéméné branch.

ROHAN, HENRI, Duc de (1579-1638), French soldier, writer and leader of the Huguenots, was born at the château of Blain, in Brittany, in 1579. His father was René II., count of Rohan (1550-86), and head of one of the oldest and most distinguished families in France, which was connected with many of the reigning houses of Europe. He was educated by his mother, who was a woman of exceptional learning and force of character. Rohan was by birth the second son, but his elder brother René dying young he became the heir of the name. He appeared at court and in the army at the age of sixteen, and was a special favourite with Henry IV., after whom, failing the house of Condé, he might be said to be the natural chief of the French Protestants. Having served till the peace of Vervins, he travelled for a considerable time over Europe, including England and Scotland, in the first of which countries he received the not unique honour of being called by Elizabeth her knight, while in the second he was godfather at Charles I.'s christening. On his return to France he was made duke and peer at the age of twenty-four, and two years later (1603) married Marguerite de Béthune, the duc de Sully's daughter. He served in high command at the celebrated siege of Jülich in 1610, but soon afterwards he fell into active or passive opposition to the government over the religious disputes. For a time, however, he abstained from actual insurrection, and he endeavoured to keep on terms with Marie de' Medici; he even, despite his dislike of De Luynes, the favourite of Louis XIII., reappeared in the army and fought in Lorraine and Piedmont. It was not till the decree for the restitution of church property in the south threw the Bearness and Gascons into open revolt that Rohan appeared as a rebel. His authority and military skill were very formidable to the royalists; his constancy and firmness greatly contributed to the happy issue of the war for the Huguenots, and brought about the treaty of Montpellier (1623). But Rohan did not escape the results of the incurable factiousness which showed itself more strongly perhaps among the French Huguenots than among any other of the numerous armed oppositions of the 17th century. He was accused of lukewarmness and treachery, though he did not hesitate to renew the war when the compact of Montpellier was broken. Again a hollow peace was patched up, but it lasted but a short time, and Rohan undertook a third war (1627-29), the first events of which are recounted in his celebrated *Memoirs*. This last war (famous for the defence of La Rochelle by Soubise, Rohan's younger brother) was one of considerable danger for Rohan. In spite of all efforts he had in the end to sign a peace, and after this he made his way quickly to Venice. Here he is said to have received from the Porte the offer of the sovereignty of Cyprus. It is more certain that his hosts of Venice wished to make him their general-in-chief, a design not executed owing to the peace of Cherasco (1631). At Venice he wrote his *Memoirs*; at Padua, *Le Parfait Capitaine*. But when France began to play a more conspicuous part in the Thirty Years' War Rohan was again called to serve his lawful sovereign, and entrusted with the war in the Valtelline. The campaign of 1633 was completely successful, but Rohan was still considered dangerous to France, and was soon again in retirement. At this time he wrote his *Traité du gouvernement des treize cantons*. Rohan fought another Valtelline campaign,

but without the success of the first, for the motives of France were now held in suspicion. The unfortunate commander retired to Geneva and thence went to the army of Bernhard of Saxe-Weimar. He received a mortal wound at the battle of Rheinfelden on the 28th of February 1638, and died at the abbey of Königsfeld, canton Berne, on the 13th of April. His body was buried at Geneva, and his arms were solemnly handed over to the Venetian government. With his daughter Marguerite the honours of the family of Rohan-Gié passed to the house of Chabot.

Rohan's *Memoirs sur les choses qui se sont passées en France*, &c., rank amongst the best products of the singular talent for memoir writing which the French noblesse of the 16th and 17th centuries possessed. Alike in style, in clearness of matter and in shrewdness, they deserve very high praise. The first three books, dealing with the civil war, appeared in 1644; the fourth, containing the narrative of the Valtelline campaigns, not till 1758. Some suspicions were thrown on the genuineness of the latter, but it would seem, groundlessly. His famous book on the history and art of war, *Le Parfait Capitaine*, appeared in 1631 and subsequently in 1637 and 1693 (see also Quincy, *Art de la guerre*, Paris, 1741). It treats of the history and lessons of Cæsar's campaigns and their application to modern warfare, and contains appendices dealing with phalangeite and legionary methods of fighting and the art of war in general. He also wrote an account of his travels, the book on Switzerland mentioned above, *De l'intérêt des princes et états de la chrétienté*, etc. The *Memoirs* may be conveniently found in the collection of Michaud and Poujoulat, vol. 19.

See Fauvellet de Foix, *Histoire du Duc Henri de Rohan* (Paris, 1667); Schybergsson, *Le Duc de Rohan et la charte du paris protestant en France* (Paris, 1880); Böhrling, *Venedig, Gustaf Adolf, und Rohan* (Halle, 1889); Laugel, *Henri de Rohan, son rôle politique et militaire* (Paris, 1899); Veraguth, *Herzog Rohan und seine Mission in Graubünden* (Berne, 1894); and Shadwell, *Mountain Warfare*.

ROHAN, LOUIS RENÉ ÉDOUARD, CARDINAL DE (1734-1803), prince de Rohan-Guéméné, archbishop of Strassburg, a cadet of the great family of Rohan (which traced its origin to the kings of Brittany, and was granted the precedence and rank of a foreign princely family by Louis XIV.), was born at Paris on the 25th of September 1734. Members of the Rohan family had filled the office of archbishop of Strassburg from 1704—an office which made them princes of the empire and the compeers rather of the German prince-bishops than of the French ecclesiastics. For this high office Louis de Rohan was destined from his birth, and soon after taking orders, in 1760, he was nominated coadjutor to his uncle, Constantine de Rohan-Rochefort, who then held the archbishopric, and he was also consecrated bishop of Canopus. But he preferred the elegant life and the gaiety of Paris to his clerical duties, and had also an ambition to make a figure in politics. He joined the party opposed to the Austrian alliance, which had been cemented by the marriage of the archduchess Marie Antoinette to the dauphin. This party was headed by the duc d'Aiguillon, who in 1771 sent Prince Louis on a special embassy to Vienna to find out what was being done there with regard to the partition of Poland. Rohan arrived at Vienna in January 1772, and made a great noise with his lavish fêtes. But the empress Maria Theresa was implacably hostile to him; not only did he attempt to thwart her policy, but he spread scandals about her daughter Marie Antoinette, laughed at herself, and shocked her ideas of propriety by his dissipation and luxury. On the death of Louis XV. in 1774, Rohan was recalled from Vienna, and coldly received at Paris; but the influence of his family was too great for him to be neglected, and in 1777 he was made grand almoner, and in 1778 abbot of St Vaast. In 1778 he was made a cardinal on the nomination of Stanislaus Ponia-towski, king of Poland, and in the following year succeeded his uncle as archbishop of Strassburg and became abbot of Noirmoutiers and Chaise-Dieu. His various preferences brought him in an income of two and a half millions of livres; yet the cardinal was restless and unhappy until he should be reinstated in favour at court and had appeased the animosity which Marie Antoinette felt against him. In pursuit of this object he fell into the hands of a gang of intriguers, the comtesse de Lamotte, the notorious Cagliostro and others, whose actions

form part of the "affair of the diamond necklace." This story is disentangled elsewhere (see DIAMOND NECKLACE), and diverging views are still taken of it. Rohan certainly was led to believe that his attentions to the queen were welcomed, and that his arrangement by which she received the famous necklace was approved. He was the dupe of others, and at the trial in 1786 before the parlement his acquittal was received with universal enthusiasm, and regarded as a victory over the court and the unpopular queen. He was deprived, however, of his office as grand almoner and exiled to his abbey of Chaise-Dieu. He was soon allowed to return to Strassburg, and his popularity was shown by his election in 1789 to the states-general by the clergy of the bailliages of Haguenau and Weissenburg. He at first declined to sit, but the states-general, when it became the national assembly, insisted on validating his election. But as a prince of the church in January 1791 he refused to take the oath to the constitution, and went to Ettenheim, in the German part of his diocese. In exile his character improved, and he spent what wealth remained to him in providing for the poor clergy of his diocese who had been obliged to leave France; and in 1801 he resigned his nominal rank as archbishop of Strassburg. On the 17th of February 1803 he died at Ettenheim.

See the *Mémoires* of his secretary, the abbé Georgel, of the baronet d'Oberkirch, of Beugnot, and of Madame Campan; and works cited under DIAMOND NECKLACE.

ROHILKHAND, a tract in the United Provinces of India. The name is associated with the Rohilla tribe (*q.v.*), but in its historical significance it covers an area almost coincident with the modern division of Bareilly, for which it is a common alternative title. This division has an area of 10,720 sq. m., and comprises the districts of Bareilly, Bijnor, Budauan, Moradabad, Shahjahanpur and Pilibhit. Pop. (1901) 5,479,688. Political control over the state of Rampur is exercised by the commissioner for the division.

ROHILLA (a Pushtu word for "mountaineer"), a tribe of Afghan marauders, who, towards the beginning of the 18th century, conquered a district of Hindostan, giving it the name of Rohilkhand, which still survives as an alternative title of the Bareilly division of the United Provinces. The Rohillas are chiefly notable for their association with Warren Hastings, which formed one of the main counts in his impeachment. Having been driven into the mountains by the Mahrattas, they had appealed for aid to Shuja-ud-Dowlah, wazir of Oudh, and ally of the British. The wazir promised to assist them in return for a sum of money; but when the Mahrattas were driven off the Rohilla chiefs refused to pay. The wazir then decided to annex their country, and appealed to Hastings for assistance, which was given in return for a sum of forty lakhs of rupees. Hastings justified his action on the ground that the Rohillas were a danger to the British as uncovering the flank of Cudh; and while he would never involve the company in an unjust war, neither did he desire an unprofitable one. The Rohillas were defeated by Colonel Champion in April 1774, and the majority of them fled across the Ganges; but the charges of destroying a nation, brought against Hastings by Burke and Macaulay, were greatly exaggerated. The Rohillas were never a nation, but consisted of a small body of Mahomedans, who had imposed an alien rule upon a million Hindus; and one of their chiefs was left in possession of a tract which now forms the state of Rampur (*q.v.*).

See Charles Hamilton, *History of the Rohilla Afghans* (1787); and Sir J. Strachey, *Hastings and the Rohilla War* (Oxford, 1892).

ROHLFS, FRIEDRICH GERHARD (1831-1896), German explorer of the Sahara, son of a physician, was born at Vegesack, near Bremen, on the 14th of April 1831. After the ordinary course at the gymnasium of Osnabrück he entered the Bremen corps in 1848, and took part as a volunteer in the Schleswig-Holstein campaign, being made an officer after the battle of Idstedt (July 1850). He became a medical student at the universities of Heidelberg, Würzburg and then Göttingen; but his natural inclination was for travelling, and in 1855 he went to Algeria and enlisted in the Foreign Legion.

He took part in the conquest of Kabylia, and was decorated for bravery as Chevalier of the Legion of Honour. Having made himself master of Arabic and gained a thorough knowledge of native customs, Rohlfis went to Morocco in 1861; presenting himself as a Mussulman, he gained the favour of the enlightened sheriff of Wazzan, and was thus enabled to travel over the length and breadth of the country. He then entered the Sahara and traversed the entire extent of the Wad Draa, being the second European (the first being René Caillié) to visit Taflet. On leaving Taflet he was robbed by his guides and left for dead; but two marabouts charitably succoured him and he was able to reach Algeria. When scarcely recovered from his wounds he started once more for the Sahara (August 1862) by way of Algeria. Compelled by tribal disturbances to turn back, he went to Tangier and thence in March 1864 made a fresh start. Crossing the Atlas by an eastern route he again visited Taflet, and thence made his way across the desert to the oasis of Tuat, which he was the first European to describe. Returning by Ghadames and Tripoli he spent three months in Germany, and then (March 1865) went back to Tripoli, intending to explore the highlands of the Ahaggar; being prevented, however, by a war among the Tuareg, he went from Ghadames to Murzuk, where he spent five months, and thence across the Sahara to Bornu, mapping *en route* the oasis of Kavar. Rohlfis passed through Mandara and its ancient capital Mora, and struck out for the coast of the Gulf of Guinea. He reached the Benue by way of the Bauchi highlands, and descended that river to its confluence with the Niger, which he ascended to Rabba. Thence he made his way on horseback to Lagos, reaching Liverpool on the 2nd of July 1867. In the following year he accompanied the British expedition against Theodore of Abyssinia, and on his return went once more to Tripoli, whence he traversed the Cyrenaica, reaching Egypt by way of the oasis of Siwa (1869). Returning home, he married and settled down in Weimar. He did not rest long, however, for in 1873-74 he took command of an expedition sent by the Khedive Ismail into the Libyan Desert, which made investigations of great value to science. In 1878 Rohlfis and Dr Stecker were commissioned by the German African Society to go to Wadai. They succeeded in reaching the oasis of Kufra, one of the chief centres of the Senussites, but being attacked by the Arabs, they were obliged to retreat, making their way to the coast at Benghazi, reached in October 1879. In 1880 Rohlfis accompanied Dr Stecker in an exploring expedition to Abyssinia; but after delivering a letter from the German emperor to the Negus, he returned to Europe. In 1885, when the rivalry between the British and Germans in East Africa was very keen, Prince Bismarck appointed Rohlfis consul at Zanzibar, which island Bismarck desired to secure for Germany. Rohlfis, untrained in diplomacy, was no match for Sir John Kirk, the British Agent, and he was soon recalled, and did not again visit Africa. He died at Rüngsdorf, near Bonn, on the 2nd of June 1896. Rohlfis visited many regions not before traversed by Europeans, and the value of his work was recognized in 1868 by the Royal Geographical Society, which bestowed on him the Patron's Medal.

Accounts of each of his expeditions, and other works on Africa were published by Rohlfis, including *Mein Erster Aufenthalt in Marokko* (Bremen, 1873; English edition, *Travels in Morocco*, London, 1874); *Reise durch Marokko* (Bremen, 1868); *Quer durch Afrika* (Leipzig, 1874-75); *Von Tripolis nach Alexandrien* (Bremen, 1871); *Expedition zur Erforschung der Libyschen Wüste* (Cassel, 1875-76); *Kufra: Reise von Tripolis nach der Oase Kufra* (Leipzig, 1881); *Land und Volk in Afrika* (Bremen, 1870); *Quid novi ex Africa?* (Cassel, 1886). See also a biographical notice by Dr W. Wolkenhauer in the *Deutsche geo. Blätter* for 1896.

ROHTAK, a town and district of British India, in the Delhi division of the Punjab. The town, which is of great antiquity, became the headquarters of a British district in 1824. Viewed from the sandhills to the south, Rohtak, with its white mosque in the centre, a fort standing out boldly to the east, is striking and picturesque. It has a station on the Southern Punjab

railway, 44 m. N.W. of Delhi. Pop. (1901) 20,323. It is an important trade centre, with factories for ginning and pressing cotton, and a speciality in muslin turbans.

The district of Rohtak has an area of 1797 sq. m. It is situated in the midst of the level tableland between the Jumna and the Sutlej, forming one unbroken plain of hard clay copiously interspersed with light yellow sand, and covered in its wild state by a jungle of scrubby brushwood. The only natural reservoir for its drainage is the Najafgarh *jhil*, a marshy lake lying within the boundaries of Delhi. The Sahibi, a small stream from the Ajmere hills, traverses a corner of the district, and the northern portions are watered by the Rohtak and Butana branches of the Western Jumna canal; but the greater portion of the central plain, comprising about two-thirds of the district area, is entirely dependent upon the uncertain rainfall. The climate, though severe in point of heat, is generally healthy; the rainfall averages annually about 20 in.

The population in 1901 was 630,672, showing an increase of 6.8% in the decade. The principal crops are millets, wheat, barley, pulses, cotton and sugar-cane. The district is traversed by the line of the Southern Punjab railway from Delhi to Jind, and also touched by the Rewari-Perozepore branch of the Rajputana railway. It is peculiarly exposed to drought, suffering in the famine of 1896-97, and yet more severely in 1899-1900, when the highest number of persons relieved was 33,632 in March 1900.

Rohtak was formerly included within the region known as Hariana. The district, with the other possessions of Sindhia west of the Jumna, passed to the British in 1803. Until 1832 Rohtak was under the administration of a political agent, resident at Delhi, but in that year it was brought under the general regulations and annexed to the North-Western Provinces. The outbreak of the Mutiny in 1857 led to its abandonment, when the mutineers attacked and plundered Rohtak, destroying every record of administration. It was not until after the fall of Delhi that the authority of the British government was permanently restored. Rohtak was then transferred to the Punjab.

ROJAS ZORRILLA, FRANCISCO DE (1607-c. 1660), Spanish dramatist, was born at Toledo; the only circumstance recorded of his life is that he became a knight of Santiago in 1644. The exact date of his death is unknown. His plays were published in 1640-45; the best of his dramatic compositions, *Del Rey abejo Ninguno*, is not included in the collection and was printed separately under the title *García del Castañar*. Of his other pieces, apart from their intrinsic merit, an international interest attaches to *No hay padre siendo rey*, which was borrowed by Rotrou for his *Venceslas*; to *Donde hay agravios no hay zelos* and the *Ano criado*, which were imitated by Scarron in his *Jodet Soufflet* and *Maitre Valet*; to *Entre Bobos anda el juego*, the source of Thomas Corneille's *Don Bertrand de Cigarral*, as well as of Scarron's *Don Japhet d'Armenie*; to *Obligados y ofendidos*, from which are derived *Les Généreux Ennemis* by Boisobert, *Les Illustres Ennemis* by Thomas Corneille, and Scarron's *Écolier de Salamanque*; and to *La traición busca el castigo*, upon which are based Vanbrugh's *False Friend* and Le Sage's *Traître puni*. Rojas Zorrilla's power of conveying a tragic impression is manifest in *García del Castañar*; his chief defect is his persistent prolixity of diction.

ROKITANSKY, CARL, FREHERR VON (1804-1878), the founder of the Vienna school of pathological anatomy, was born on the 19th of February 1804 at Königgrätz in Bohemia. He studied medicine at Prague and at Vienna, graduating at the latter place in 1828. Soon afterwards he became assistant to Johann Wagner, the professor of pathological anatomy, and succeeded him in 1834 as prosector, being at the same time made extraordinary professor. It was not until ten years later (1844) that he reached the rank of full professor. To his duties as a teacher he added in 1847 the onerous office of medico-legal anatomist to the city, and from 1863 he filled an influential office in the ministry of education and public worship, wherein he had to advise on all routine matters of medical teaching,

including patronage. A seat in the upper house of the Reichsrath rewarded his public labours in 1867, and on his retirement from all his offices in 1874 he was made a commander of the Order of Leopold. He joined the Imperial Academy of Sciences as a member in 1848, and became its president in 1869. He was president also of the medical society of the Austrian capital and an honorary member of many foreign societies. On his retirement at the age of seventy his colleagues celebrated the occasion by a function in the aula of the university, where his bust was unveiled. In his leave-taking speech he said that work had always been a pleasure to him and pleasures mostly a toil. His death in Vienna on the 23rd of July 1878 elicited many genuine expressions of affection and of esteem for his upright character. Two of his sons became professors at Vienna, one of astronomy and another of medicine, while a third gained distinction on the lyric stage.

With Rokitansky's name is associated the second great period of the medical school of Vienna, its first success having been identified with the liberal patronage of it by Maria Theresa and with the fame of Van Swieten, who attracted thither the greatest anatomists of the continent. The basis of its second reputation was morbid anatomy, together with the precision of clinical diagnosis dependent thereon, and associated with the labours of Rokitansky's lifelong friend, Joseph Skoda (1805-1881). The anatomical vogue had begun under Wagner while Rokitansky was still a student; but it reached its highest point while the latter was assistant in the dead-house and afterwards prosector and professor. The enthusiasm for the post-mortem study of disease brought one very serious consequence at the outset, in the enormous increase of the death-rate in the wards in the city and in the general hospital. A comparison between the slight mortality in the wards that were afterwards reserved for the training of midwives and the excessive mortality in those set apart for the training of students proved that the cause was the conveyance of infection from the dead-house by the hands of the latter. The precautions introduced by I. P. Semmelweis in 1847 proved adequate in removing that grave reproach from the study of morbid anatomy. Another and more lasting consequence of the assiduous pursuit of post-mortem study, counterbalancing somewhat the advantage of a more precise and logical diagnosis, was the loss of faith in the power of drugs to remedy the textual changes—the so-called "inflammation" of the Vienna school. The immediate outcome of Rokitansky's close application to the work of the dead-house was his *Handbuch der pathologischen Anatomie* (1842-46), in 3 vols., of which the first was published last. The value of the work lies in the second and third volumes, containing succinct descriptions of the visible changes and abnormalities in the several organs and parts of the body. Whenever Rokitansky touched the vital problems of general pathology, as he did in the postponed first volume, he revealed a metaphysical bent, which was strong in him behind all his undoubted powers of outward observation and accurate description. "Being a few years too soon to profit by the microscopic movement which led to the cellular pathology, he endeavoured to reconcile the old humoral doctrine with his anatomical observations, and to read a new meaning into the doctrine of the various dyscrasias. In 1862 he entered into possession of a new pathological institute, in which he found means, for the first time, to display his extensive collection of specimens in a museum. Although he had no direct share in the newer developments of pathology, he was far from indifferent or reactionary towards them; indeed, the laboratories and chairs for microscopic and experimental pathology, and for pathological chemistry were warmly encouraged and aided by him." (William Osler.)

Next to his *Handbuch*, of which the Sydenham Society published an English translation in 4 vols. (1849-52), his most important writings were four memoirs in the *Denkschriften* of the Vienna Academy of Sciences (on the anatomy of goitre, cysts, diseases of arteries, and defects in the septa of the heart), the last as late as 1875. Other papers of less importance brought up the total of his writings to thirty-eight, including three addresses of a philosophical turn, on "Freedom of Inquiry" (1862), "The Independent Value of Knowledge" (1867) and "The Solidarity of Animal Life" (1869).

ROLAND [ROLAND DE LA PLATÈRE], **JEAN MARIE** (1734-1793), French statesman, was born at Thizy on the 18th of February 1734. He received a good education, and early formed the studious habits which remained with him through life. Proposing to seek his fortune abroad, he went on foot to Nantes, but was there prostrated by an illness so severe that all thoughts of emigration were perforce abandoned. For some years he was employed as a clerk; thereafter he joined a relative who was inspector of manufactures at Amiens, and he himself speedily rose to the position of inspector. To these two employments may be ascribed those qualities of assiduity and

accuracy, and that familiarity with the commerce of the country, which distinguished his public career. In 1781 he married Manon Jeanne Philpon (1754-1793), and the name of MADAME ROLAND is famous in history. She was the daughter of Gratien Philpon, a Paris engraver, who was ambitious, speculative and nearly always poor. From her early years she showed great aptitude for study, an ardent and enthusiastic spirit, and unquestionable talent. She was to a considerable extent self-taught; and her love of reading made her acquainted first with Plutarch—a passion for which author she continued to cherish throughout her life—thereafter with Bossuet, Massillon, and authors of a like stamp, and finally with Montesquieu, Voltaire and Rousseau. These studies marked stages of her development, and as her mind matured she abandoned the idea of a convent which for a year or two she had entertained, and added to the enthusiasm for a republic which she had imbibed from her earlier studies not a little of the cynicism and the daring which the later authors inspired. She almost equalled her husband in knowledge, and infinitely excelled him in talent and in tact. Through and with him she exercised a singularly powerful influence over the destinies of France from the outbreak of the Revolution till her death.

For four years after their marriage Roland lived at Amiens, he being still an inspector of manufactures; but his knowledge of commercial affairs enabled him to contribute articles to the *Encyclopédie Nouvelle*, in which, as in all his literary work, he was assisted by his wife. On their removal to Lyons the influence of both became wider and more powerful. Their fervent political aspirations could not be concealed, and from the beginning of the Revolution they threw in their lot with the party of advance. The *Courrier de Lyon* contained articles the success of which reached even to the capital and attracted the attention of the Parisian press. They were from the pen of Madame Roland and were signed by her husband. A correspondence sprang up with Brissot and other friends of the Revolution at headquarters. In Lyons their views were publicly known; Roland was elected a member of the municipality, and when the depression of trade in the south demanded representation in Paris he was deputed by the council of Lyons to ask the Constituent Assembly that the municipal debt of Lyons, which had been contracted for the benefit of the state, should be regarded as national debt. Accompanied by his wife, he appeared in the capital in February 1791. He remained there until September, frequenting the Society of the Friends of the Constitution, and entertaining deputies of the most advanced opinions, especially those who later became the leading Girondists. Madame Roland took an active part in the political discussions in these reunions.

In September 1791, Roland's mission being executed, they returned to Lyons. Meanwhile the inspectorships of manufactures had been abolished; he was thus free; and they could no longer remain absent from the centre of affairs. In December they again reached Paris. Roland became a member of the Jacobin Club. They had made many and influential friends in advance, and Madame Roland's salon soon became the rendezvous of Brissot, Pétion, Robespierre and other leaders of the popular movement, above all of Buzot, whom she loved with platonic enthusiasm. In person Madame Roland was attractive though not beautiful; her ideas were clear and far-reaching, her manner calm, and her power of observation extremely acute. It was almost inevitable that she should find herself in the centre of political aspirations and presiding over a company of the most talented men of progress. The rupture had not yet been made evident between the Girondist party and that section still more extreme, that of the Mountain. For a time the whole left united in forcing the resignation of the ministers. When the crisis came the Girondists were ready, and on the 23rd of March 1792 Roland found himself appointed minister of the interior. As a minister of the crown Roland exhibited a bourgeois brusqueness of manner and a remarkable combination of political prejudice with administrative ability. While his wife's influence

could not increase the latter, it was successfully exerted to foment and embitter the former. He was *ex officio* excluded from the Legislative Assembly, and his declarations of policy were thus in writing—that is, in the form in which she could most readily exert her power. A great occasion was invented. The decrees against the emigrants and the non-juring clergy still remained under the veto of the king. A letter was penned by Madame Roland and addressed by her husband to Louis. It remained unanswered. Thereupon, in full council and in the king's presence, Roland read his letter aloud. It contained many and terrible truths as to the royal refusal to sanction the decrees and as to the king's position in the state; but it was inconsistent with a minister's position, disrespectful if not insolent in tone. Roland's dismissal followed. Then he completed the plan: he read the letter to the Assembly; it was ordered to be printed, became the manifesto of disaffection, and was circulated everywhere. In the demand for the reinstatement of the dismissed ministers were found the means of humiliation, and the prelude to the dethronement, of the king.

After the insurrection of the 10th of August, Roland was recalled to power, one of his colleagues being Danton. But now he was dismayed by the progress of the Revolution. He was above all a provincial, and was soon in opposition to the party of the Mountain, which aimed at supremacy not only in Paris but in the government as well. His hostility to the insurrectional commune of Paris, which led him to propose transferring the government to Blois, and his attacks upon Robespierre and his friends rendered him very unpopular. His neglect to seal the iron chest discovered in the Tuileries, which contained the proofs of Louis XVI.'s relations with the enemies of France, led to the accusation that he had destroyed a part of these documents. Finally, in the trial of the king he demanded, with the Girondists, that the sentence should be pronounced by a vote of the whole people, and not simply by the Convention. He resigned office on the 23rd of January 1793, two days after the king's execution.

Although now extremely unpopular, the Rolands remained in Paris, suffering abuse and calumny, especially from Marat. Once Madame Roland appeared personally in the Assembly to repel the falsehoods of an accuser, and her ease and dignity evoked enthusiasm and compelled acquittal. But violence succeeded violence, and early on the morning of the 1st of June she was arrested and thrown into the prison of the Abbaye. Roland himself escaped secretly to shelter in Rouen. Released for an hour from the Abbaye, she was again arrested and thrown among the horrors of Sainte-Pélagie. Finally, she was transferred to the Conciergerie. In prison she won the affections of the guards, and was allowed the privilege of writing materials and the occasional visits of devoted friends. She there wrote her *Appel à l'impartiale postérité*, those memoirs which display a strange alternation between self-laudation and patriotism, between the trivial and the sublime. On the 8th of November 1793 she was conveyed to the guillotine. Before yielding her head to the block, she bowed before the clay statue of Liberty erected in the Place de la Révolution, uttering her famous apostrophe—"O Liberty! what crimes are committed in thy name!" When Roland heard of his wife's condemnation, he wandered some miles from his refuge in Rouen; maddened by despair and grief, he wrote a few words expressive of his horror at those massacres which could only be inspired by the enemies of France, protesting that "from the moment when I learned that they had murdered my wife I would no longer remain in a world stained with enemies." He affixed the paper to his breast, and unsheathing a sword-stick fell upon the weapon, which pierced his heart, on the 10th of November 1793.

Madame Roland's *Mémoires*, first printed in 1820, have been edited among others by P. Faugère (Paris, 1864), by C. A. Dauban (Paris, 1864), by J. Claretie (Paris, 1884), and by C. Perroud (Paris, 1905). Some of her *Lettres inédites* have been published by C. A. Dauban (Paris, 1867), and a critical edition of her *Lettres* by

C. Perroud (Paris, 1900-2). See also C. A. Dauban, *Étude sur Madame Roland et son temps* (Paris, 1864); V. Lamy, *Deux femmes célèbres, Madame Roland et Charlotte Corday* (Paris, 1884); C. Bader, *Madame Roland, d'après des lettres et des manuscrits inédits* (Paris, 1892); A. J. Lambert, *Le mariage de Madame Roland, trois années de correspondance amoureuse* (Paris, 1896); Austin Dobson, *Four Frenchwomen* (London, 1890); and articles by C. Perroud in the review *La Révolution française* (1896-99).

ROLAND, LEGEND OF. The legend of the French epic hero Roland (transferred to Italian romance as Orlando) is based on authentic history. Charlemagne invaded Spain in 778, and had captured Pampeluna, but failed before Saragossa, when the news of a Saxon revolt recalled him to the banks of the Rhine. On his retreat to France through the defiles of the Pyrenees, part of his army was cut off from the main body by the Basques, who had ambushed in a narrow defile, and now drove the rear-guard into a valley where it was surrounded and entirely destroyed. The Basques, after plundering the baggage, made good their escape, favoured by the darkness and by their knowledge of the ground. The incident is related in the *Annales* (Pertz i. 150) commonly ascribed to Einhard, and with more detail in Einhard's *Vita Karoli* (cap. ix.; Pertz ii. 448), where the names of the leaders are given. "In this battle were slain Egghard, praepositus of the royal table; Anselm, count of the palace; and Hruotland, praefect of the Breton march. . . ." The scene of the disaster is fixed by tradition at Roncevaux, on the road from Pampeluna to Saint Jean Pied de Port. There is no foundation in this story for the fiction of the twelve peers, which may possibly arise from a still earlier tradition. In 636-37, according to the *Chronicles of Fredegarus* (ed. Krusch p. 150), twelve chiefs, whose names are given, were sent by Dagobert against the Basques. The expedition was successful, but in an engagement fought in the valley of Subola, or Robola, identified with Maulfou, which is not far from Roncevaux, the Duke Harembert, with other Frankish chiefs, was slain. Later fights in the same neighbourhood and under similar circumstances are related in 824 (*Vita Hludowici*; Pertz ii. 616), and especially in 824 (Einhard's *Annales*; Pertz i. 213). These incidents no doubt served to strengthen the tradition of the disaster to Charlemagne's rear-guard in 778, the importance of which was perhaps underrated by the Frankish historians and was certainly magnified in popular story. The author of the *Vita Hludowici*, writing sixty years after the battle of Roncevaux, thought it superfluous to give the names of the fallen chiefs, as being matter of common report.

Growth of the Legend.—The choice of Roland or Hruotland as the hero of the story probably points to the borders of French Brittany as the home of the legend. The exaggeration of a rear-guard action into a national defeat; the substitution of a vast army of Saracens, the enemies of the Frankish nation and the Christian faith, for the border tribe mentioned by Einhard;¹ and the vengeance inflicted by Charlemagne, where in fact the enemy escaped with complete impunity—all are in keeping with the general laws of romance. Charlemagne himself appears as the ancient epic monarch, not as the young man he really was in 778. The earliest version of the legend which we possess dates no earlier than the 11th century, but there is abundant evidence of the existence of a continuous tradition dating from the original event, although its methods of transmission remain a vexed question. Roncevaux lay on the route to Compostella, and the many pilgrims who must have passed the site from the middle of the 9th century onwards may have helped to spread the story. Whether the actual *cantilena Rolandi* chanted by Taillefer at the battle of Hastings (William of Malmesbury, *De gestis regum angl.* iii. 242, and Wace, *Brut*. ii. 11, 8035 seq.) was any part of the existing *Chanson de Roland* cannot be stated, but the choice of the legend on this occasion by the trouvère is proof of its popularity.

The oldest extant forms of the legend are: (a) chapters xix.-xxx. of the Latin chronicle, known as the *Pseudo-Turpin*,

¹ It is noteworthy, however, that an Arab historian, Ibn-al-Athir, states that Charles's assailants were the Arabs of Saragossa, by whom he had been originally invited to interfere in Spain.

which purports to be the work of Turpin, archbishop of Reims, who died about 800, but probably dates from the 12th century; (b) *Carmen de proditiōe Guenonis*, a poem in Latin distichs; and (c) the *Chanson de Roland*, a French *chanson de geste* of about 4000 lines, the oldest recension of which is in the Bodleian Library, Oxford (MS. Digby 23). It is in assonanced tirades, of unequal length, many of them terminated with the refrain *Aoi*. This MS. was written by an Anglo-Norman scribe about the end of the 12th century, and is a corrupt copy of a text by a French trouvère of the middle of the 11th century. It concludes with the words: "Ci falt la geste, que Turoldus declinet." There was a Turold (d. 1098) who was abbot of Peterborough; another was tutor to William the Conqueror and died in 1035. Even if we could identify this personage, we cannot tell whether he was the poet, the minstrel or the scribe of the MS., but it seems likely that he was merely the scribe. The poem, which was first printed by Francisque Michel (Oxford, 1837), is the finest monument of the heroic age of French epic. In its fundamental features it evidently dates back to the reign of Charlemagne, who is not represented as the capricious despot of the later *chansons de geste*, but as governing in accordance with Frankish custom, accepting the counsel of his barons, and carrying out the curious procedure of Frankish law. *Roland* represents the monarchical idea, and was evidently, in its primitive form, written before the feudal revolts which weakened the power of Charlemagne's successors. Its unity of conception, the severity and conciseness of the language, the directness, vividness and sobriety of the narrative, place it far above the chansons of later trouvères, with their wordiness and their loose, episodic construction. With the exception of the small place allotted to Alde, women have practically no place in the story, and the romantic element is thus absent. Roland's master-passions are daring and an exaggerated conception of honour, the extravagance of which is the cause of the disaster. His address to Oliver before the battle is typical of the warlike spirit of the poem:—

"Notre empereur qui ses Francs nous laissa,
Tels vingt mille hommes a pour nous mis à part,
Qu'il soit très bien que pas n'est couard.
Pour son seigneur grands maux on souffrira,
Terribles froids, grands chauds endurera,
Et de son sang, de sa chair on perdra!
Brandis ta lance; et moi, ma Durendal,
Ma bonne épée, que le Roi me donna.
Et si je meurs, peut dire qui l'aura
C'était l'épée d'un très noble vassal."

(tr. Petit de Julleville xi. 1114 seq.)

The Story as related in the Chanson de Roland.—Charlemagne, after fighting for seven years in Spain, had conquered the whole country with the exception of Saragossa, the seat of the Saracen king Marsile. He was encamped before Cordova when he received envoys from the Saracen king, sent to procure the evacuation of Spain by the Franks through false offers of submission. Charlemagne held a council of his barons, Naimes of Bavaria, Roland, Oliver, Turpin, Ogier, Ganelon and the rest. Roland, the emperor's nephew, was eager for war; the peace party was headed by Ganelon of Mayence.² The Franks were weary of campaigning, and Ganelon's counsels won the day. At the suggestion of Roland, Ganelon, who was his stepfather, was entrusted with the embassy to Marsile—a sufficiently perilous errand, since two former envoys had been beheaded by the Saracens. Ganelon, inspired by hatred of Roland and Oliver, agreed with Marsile to betray Roland and his comrades for ten mule-loads of gold. He then returned to Charlemagne bearing Marsile's supposed assent to the Frankish terms. The retreat began. Roland, at Ganelon's instigation, was placed in command of the rear-guard. With him were the rest of the famous twelve peers,³ his companions-in-arms, Oliver, Gérin, Gier, Oton, Bérengier, Samson, Anséis, Girard

² Ganelon may perhaps be identified with Wenilo, archbishop of Sens, whose treason against Charles the Bald is related in the *Annales Bertiniani* (anno 859).

³ The lists vary in different texts.

de Roussillon, Engelier the Gascon, Ivon and Ivoire, and the flower of the Frankish army. They had nearly reached the summit of the pass when Oliver, who had mounted a high rock, saw the advancing army of the Saracens, 400,000 strong. In vain Oliver begged Roland to sound his horn and summon Charlemagne to his aid. A description of the battle, a series of single combats, follows. Oliver, with his sword Hauteclère, rivalled Roland with Durendal. After the first fight, a second division of the pagan army appears, then a third. Roland's army was reduced to sixty men before he consented to sound his horn. Presently all were slain but Roland and Oliver, Turpin and another. Finally, when the Saracens, warned of the return of Charlemagne, had retreated, Roland alone survived on the field of battle. With a last effort he blew his horn once more, and heard before he died the sound of Charlemagne's battlercry of "Montjoie." Charlemagne pursued the enemy, and destroyed their army. The raising of a second army by Baligant, the emir of Babylon, and its defeat by the emperor, who slays Baligant in single combat, is obviously an interpolation in the original narrative. The trouvère then relates the return of the Franks, the burial of the heroes of Roncevaux, and, at great length, the trial of Ganelon at Aix, his execution, and that of his thirty kinsmen, and the death of Aïde, Roland's betrothed and Oliver's sister, when she heard the news of Roland's death. The trial of Ganelon is one of the most curious parts of the story, providing, as it does, a full account of the Frankish criminal procedure.

Relations between the Earlier Forms of the Legend.—The *Pseudo-Turpin* represents a different recension of the story, and is throughout clerical in tone. It was the trouvère of the *Chanson de Roland* who developed the characters into epic types; he invented the heroic friendship of Roland and Oliver, the motives of Ganelon's treachery, and many other details. The famous fight between Roland and the giant Ferragus appears in the *Pseudo-Turpin* (chapter xviii.), but not in the poem. The *Chanson de Roland* presupposes the existence of a whole cycle of epic poetry, probably in episodic form; it contains allusions to many events outside the narrative, some of which can be explained from other existing chansons, while others refer to narratives which are lost. In lines 590-603 of the poem Roland gives a list of the countries he has conquered for Charles, from Constantinople and Hungary on the east to Scotland on the west. Of most of these exploits no trace remains in extant poems, but his capture of Bordeaux, of Nobles, of Carcassonne, occur in various compilations. Roland was variously represented by the romancers as the son of Charlemagne's sister Gilles or Berte and the knight Milon d'Anglers. The romantic episode of the reconciliation of the pair with Charlemagne through Roland's childish prattle (*Berle et Milon*) is probably foreign to the original legend. In the Scandinavian versions Roland is the son of Charlemagne and his sister, a recital probably borrowed from mythology. His *enfances*, or youthful exploits, were, according to *Aspremont*, performed in Italy against the giant Eaumont, but in *Girais de Viane* his first taste of battle is under the walls of Vienne, where Oliver, at first his adversary, becomes his brother-in-arms.

Other Versions.—Most closely allied to the Oxford *Roland* are (a) a version in Italianized French preserved in a 13th or 14th century MS. in the library of St Mark, Venice (MS. Fr. iv.); (b) the *Ruolantes Lied* (ed. W. Grimm, Göttingen, 1838) of the Saxon priest Kocand (fl. 1130), who gave, however, a pious tone to the whole;¹ (c) the 8th branch of the *Karlamagnus-saga* (ed. C. Unger, Christiania, 1860), and the Danish version of that compilation.

In the 12th century the *Chanson de Roland* was modernized by replacing the assonance by rhyme, and by amplifications and

additions. Several MSS. of this rhymed recension, sometimes known as *Roncevaux*, are preserved. In the prose compilations of *Gautier* and in David Aubert's *Conquêtes de Charlemagne* (1458) the story kept its popularity for many centuries. In England the story was understood in the original French, and the English romances of Charlemagne (*q.v.*) are mostly derived from late and inferior sources. In Spain the legend underwent a curious transformation. Spanish patriotism created a Spanish ally of Marsile, Bernard del Carpio, to be the rival and victor of Roland. It was in Italy that the Roland legend had its greatest fortune; Charlemagne and Roland appear in the *Paradiso* (canto xviii.) of Dante; the statues of Roland and Oliver appear on the doorway of the cathedral of Verona; and the French *chansons de geste* regularly appeared in a corrupt Italianized form. The Roland legend passed through a succession of revisions, and, as the *Spagna*, forming the 8th book of the great compilation of Carolingian romance, the *Reali di Francia*, kept its popularity down to the Renaissance. The story of Roland (Orlando) in a greatly modified form is the subject of the poems of Luigi Pulci (*Morgante Maggiore*, 1481), of Matteo Boiardo (*Orlando innamorato*, 1486), of Ariosto (*Orlando furioso*, 1516), and of Francesco Berni (*Orlando*, 1541).

AUTHORITIES.—For a complete bibliography of the editions of the various MSS. of the *Chanson de Roland*, of the foreign versions, and of the enormous literature of the subject, see Léon Gautier, *Les Épopées françaises* (2nd ed., vol. iii., 1880), and the same author's *Bibliographie des chansons de geste* (1897). Among critical editions of the *Chanson* are those by Wendelin Foerster in the *Altfranz. Bibliothek*, vols. vi. and vii. (Heilbronn, 1883-86), and by E. Stengel, *Das altfranzösische Rolandlied* (Leipzig, 1900, 8c.). The most popular edition is La *Chanson de Roland* (Paris, 1872, and numerous subsequent editions), by Léon Gautier, with text, translation, introduction, notes, variants and glossary. L. Petit de Julleville published in 1878 an edition with the old French text, and a modern French translation in assonance verse. There are various other translations in French; in English prose by I. Butler (Boston, Mass., 1904); and a partial English verse translation by A. Way and F. Spencer (London, 1895). Consult further G. Paris, *Hist. poét. de Charlemagne* (reprint, 1905), and *De Pseudo Turpin* (Paris, 1865); P. Rajna, *Le Origini dell' epopea francese* (Florence, 1884); and *Le Fami del Roland* (Florence, 1900); F. Pavesi, *Roland nella storia e nella poesia* (Turin, 1901); G. Paris, "Roncevaux," in *Legendes du moyen âge* (1903), on the topography of the battlefield.

ROLANDECK, a village of Germany, in the Prussian Rhine province, delightfully situated on the left bank of the Rhine, 8 m. above Bonn, with a station on the railway Cologne-Coblenz. The place consists almost entirely of villas and is a favourite summer resort. Crowning the vine-clad hills behind it lie the ruins of the castle, a picturesque ivy-covered arch, whence a fine view is obtained of the Siebengebirge and the Rhine valley as far as Bonn. Immediately below Rolandseck in mid-river is the island of Nonnenwerth, on which is a nursing school under the conduct of Franciscan nuns, established in 1850. The convent which formerly stood here was founded in 1122 and secularized in 1802. Tradition assigns the foundation of the castle of Rolandseck to Charlemagne's paladin, Roland. It was certainly built at a very early date, as it was restored by Frederick, archbishop of Cologne, in 1120, and it was a fortress until the end of the 13th century.

ROLL, ALFRED PHILIPPE (1846—), French painter, was born in Paris on the 1st of March 1846. Pupil of Gérôme and Bonnat at the École des Beaux Arts, he made his *début* at the Salon in 1870 with "Environs de Baccarat" and "Evening," and attracted the widest attention in 1875 by his colossal painting of "The Flood at Toulouse" (now at the Havre Museum). All his early work is imbued with the spirit of romanticism under the influence of Gérôme, whilst his colour tended to Bolognese heaviness with a strong leaning towards dark shadows in the flesh painting, in which he closely followed Courbet. In 1877 he showed at the Salon the "Fête of Silenus" (now at the Ghent Museum), a painting of such vivid colour and exuberant life that it recalls the work of Jordaens. About this time he began to devote himself to the realistic rendering of modern life, especially among the working classes, and together with romantic subjects he abandoned his earlier heavy colouring, and devoted himself to the study of free light. His "Miners' Strike" of 1880 (now at the Valenciennes Museum) placed him in the front rank of modern French painters, and from that date his career was one of continuous and brilliant success. He became "official painter" to the

¹ A proof of the popularity of the legend in Germany is supplied by the so-called Roland statues, of which perhaps the most famous example is that of Bremen. Mention of a *statua Rolandi* is made in a *privilegium* granted by Henry V. to the town of Bremen in 1111. The *Roland's-äule* were probably symbolic of the judicial rights possessed by the towns where they are found, and it has been suggested that the word arises from false etymology with *Rolland's-äule*, red-land-pillar, the symbol of the possession of the power of life and death.

French government, and was entrusted with numerous commissions for the decoration of public buildings and for commemorative pictures, like the "President Carnot at Versailles at the Centenary of the États Généraux" (now at Versailles Palace), and "The Tzar and President Faure laying the Foundation Stone of the Alexandre III. Bridge." For the Hôtel de Ville he executed "The Pleasures of Life" and "The Rosetime of Youth." Besides the pictures already mentioned, a vast number of his works are to be found in the public galleries of France. The museum of the Hôtel de Ville in Paris owns his "National Fête at Paris in 1880"; the Cognac Museum, "Labour, Works at Suresnes"; the Luxembourg, his "War" and "Manda Lametrie, farm-hand." At Avignon Museum is the "Don Juan and Haïdee"; at Laval Museum, "Halt!"; at Fontainebleau Palace, "In Normandy"; at Pau Museum, "Roubey, cementer"; and at the Museum of Geneva, "Marianne Offrey, creuse de vert." In portraiture he is known by his "Yves Guyot," "Coquelin cadet," "Jules Simon," &c., but his greatest success was the group of "Fritz Thaulow and his Wife." In 1905 he replaced Carolus-Duran as president of the Société Nationale des Beaux-Arts, of which he was one of the founders.

ROLL (O. Fr. *rolle, rouille*, mod. *rôle*, Lat. *rotulus*, dim. of *rota*, wheel), something rolled or wound up in a cylindrical form on an axis, or something which "rolls," that is, moves or is moved along a service by a turning motion. Primarily the word is used of a piece of writing material, such as parchment or paper, rolled up for the purpose of convenient storage, handling, &c. This is the meaning of the Med. Lat. *rotulus*, defined by Du Cange as "Scheda, charta in speciem rotulae seu rotae convoluta." It was thus the convenient name for any document kept in this form as an official record, and hence for any register, record, catalogue or official list. "The Rolls" was the name of the building where the records of the Chancery Court were kept, the keeper of which was the Master (*q.v.*) of the Rolls, now the title of the third member of the English Supreme Court of Judicature. Other familiar examples of the use of the word in this sense are the list of those admitted as qualified solicitors, whence the phrase "to strike off the rolls," of removal by the court of a solicitor for offences or delinquencies. There are numerous applications of the word to other objects packed in a cylindrical form, such as tobacco, cloth, &c., and particularly to a small loaf of bread rolled over before baking, the crust being thin and crisp and the crumb spongy.

In architecture a "roll" or "scroll" moulding is a moulding resembling a section of a roll or scroll of parchment with the end overlapping; a "roll and fillet" moulding is a section of a cylindrical moulding with a square fillet running along the centre of the face (see LABEL). For the sense of an object that rolls, the word "roller" is more general, but "roll" is frequent in technical usage for revolving cylinders, especially when working in fixed bearings. For the rolling of steel see ROLLING MILL.

ROLLAND, JOHN (fl. 1560), Scottish poet, appears to have been a priest of the diocese of Glasgow, and to have been known in Dalkeith in 1555. He is the author of two poems, the *Court of Venus* and a translation of the *Seven Sages*. The former, which was printed by John Ros in 1575, may have been written before 1560. The latter was translated from a Scots prose version at the suggestion of an aunt ("ane proper wenche"), who had found his treatment of the courtly allegory involved and uninteresting.

The *Court of Venus* was edited by Walter Gregor for the S.T.S. in 1884. See W. A. Craige's long list of corrections of that edition in the *Modern Language Quarterly* (March 1898). The *Seven Sages* was printed in 1578, and frequently during the earlier decades of the 17th century. It was reprinted by David Laing for the Bannatyne Club (1837). Sibbald, in his *Chronicle of Scottish Poetry* (iii. 287), hinted that Rolland may be the author of the *Thrie Priestis of Pellsis*. There is not a scrap of evidence in support of this; and there are many strong reasons against the ascription.

ROLLE DE HAMPOLE, RICHARD (d. 1349), English hermit and author, was born near the end of the 13th century, at

Thornton (now Thornton Dale), near Pickering, Yorkshire. His father, William Rolle, was perhaps a dependant of the Neville family. Richard was sent to Oxford at the expense of Thomas de Neville, afterwards archdeacon of Durham. At Oxford he gave himself to the study of religion rather than to the subtleties of scholastic philosophy, for which he professed a strong distaste. At the age of nineteen he returned to his father's house, and, making a rough attempt at a hermit's dress out of two kirtles of his sister's and a hood belonging to his father, he ran away to follow the religious vocation. At Dalton, near Rotherham, he was recognized by John de Dalton, who had been at Oxford with him. After satisfying himself of Rolle's sanity, Dalton's father provided him with food and shelter and a hermit's dress. Rolle then entered on the contemplative life, passing through the preliminary stages of purification and illumination, which lasted for nearly three years, and then entering the stage of sight, the full revelation of the divine vision. He is very exact in his dates, and attained, he says, the highest stage of his ecstasy four years and three months after the beginning of his conversion. Richard belonged to no order and acknowledged no rule. He left the Daltons, and wandered from place to place, resting when he found friends to provide for his wants. He seems to have desired to form a rule of hermits, but met with much opposition. The pious compilers of his "office" evidently thought it necessary to defend him against the charge of mere vagrancy. He nowhere says himself that his preaching made many converts, but his example was followed by many recluses in the north of England. After some years of wandering he gave up his more energetic propaganda, contenting himself with advising those who sought him out. He began also to write the songs and treatises by which he was to exert his widest influence. He settled in Richmondshire, twelve miles from the recluse Margaret Kirkby, whom he had cured of a violent seizure. To her some of his works are dedicated. Finally he removed to Hampole, near Doncaster, invited by an inmate of the Cistercian nunnery of St Mary. There he died on the 29th of September 1349. Many miracles were wrought at his shrine, and, in view of an expected canonization, an office was drawn up giving an account of his life and the legends connected with it.

Richard Rolle had a great influence on his own and the next generation. In his exaltation of the spiritual side of religion over its forms, his enthusiastic celebration of the love of Christ, and his assertion of the individualist principle, he represented the best side of the influences that led to the Lollard movement. He was himself a faithful son of the church, and the political activity of the Lollards was quite foreign to his teaching. The popularity of his devotional writings is attested by the numerous existing editions and by the many close imitations of them.

A very full list of his Latin and English works is given (pp. 36-43) in Dr Carl Horstmann's edition (1895-96) of his works in the Library of Early English Writers. Some of his works exist in both English and Latin, and it is often not easy to say which is the original version. The most considerable of them are *The Pricke of Conscience* and his *Commentary on the Psalter*.

The Pricke of Conscience is a long religious poem, in rhyming couplets, dealing with the beginning of man's life, the instability of the world, why death is to be dreaded, of doomsday, of the pains of hell, and the joys of heaven, the two latter subjects being treated with uncompromising realism. Rolle wrote in the northern dialect, but southern transcripts are also found, and the poem exists in a Latin version (*Stimulus conscientiae*). The sources of this work included the *De Contemptu Mundi sive de miseria humanae conditionis* of Pope Innocent III., and Rolle also showed a knowledge of Bartholomew Glanville, Thomas Aquinas and Honorius of Autun. His English devotional commentary on the Psalms follows very closely his Latin *Expositio Psalterii*, which he based partly on Peter Lombard's *Catena*. It often agrees with the English metrical *Psalter* preserved in three MSS. in the British Museum (Cotton Pesp. D. vii., Egerton 614, and Harl. 1770). Dr R. F. Littledale in his edition (1873) of J. M. Neale's *Commentary on the Psalms* called it a "terse mystical paraphrase, which often comes very little short in beauty and depth of Dionysius the Carthusian himself."

There is no complete and accessible edition of his works. The best collection is by C. Horstmann, *Yorkshire Writers: Richard Rolle of Hampole; An English Father of the Church and his Followers*

(2 vols., 1895-96), in the "Library of Early English Writers." This includes many English prose treatises by Rolle, some beautiful examples of his lyric poems, and other treatises in prose and verse from northern MSS., some of which are attributed to Rolle, and others to his followers. Wynkyn de Worde printed in one volume, in 1506, *Richard Rolle Hiermyte of Hampull in his contemplacions of the drede and love of God . . . and the Kenedy ayenset the troubles of temptacions*. Neither of these are accepted by Dr. Horstmann as Rolle's work. His Latin treatises, *De emendatione vite* and *De incendio amoris*, the latter one of the most interesting of his works, because it is obviously largely autobiographical, were translated (1434-35) by Richard Misyng (ed. R. Harvey, Early English Text Soc., 1896). The *Pricke of Conscience* was edited (1863) by Richard Morris for the Philological Society. His *Commentary on the Psalms* was edited by the Rev. H. R. Bramley (Oxford, 1884). Ten prose treatises by Richard Rolle from the Thornton MS. (c. 1440, Lincoln Cathedral Library) were edited by Canon George Perry for the Early English Text Society in 1866. Partial editions of his Latin works are dated Paris (1510), Antwerp (1533), Cologne (1535-36), Paris (1618); and in vol. xxvi. of the "Bibliotheca Patrum Maxima" (Lyon, 1677). The office, which forms the chief authority for Rolle's life, was printed in the *York Breviary*, vol. ii. (Surtees Soc., 1882), and in Canon Perry's edition referred to above.

See also Percy Andree, who collated eighteen MSS. in the British Museum in his *Handschriften des Pricke of Conscience* (Berlin, 1888); *Studien über Richard Rolle von Hampole unter besonderer Berücksichtigung seiner Psalmencommentare*, by H. Middendorff (Magdeburg, 1888), with a list of MSS., sources, &c.; J. Zupitza in *Englische Studien* (Heilbronn, vols. vii. and xli.); A. Hahn, *Quellenuntersuchungen zu Richard Rolle's Englischen Schriften* (Halle, 1900); and for his prosody, G. Sainsbury, *Hist. of English Prosody*, vol. i.

ROLLER, a very beautiful bird, so called from its way of occasionally rolling or turning over in its flight,¹ somewhat after the fashion of a tumbler-pigeon. It is the *Coracias garrulus* of ornithology, and is widely though not very numerous spread over Europe and Western Asia in summer, breeding so far to the northward as the middle of Sweden, but retiring to winter in Africa. It occurs almost every year in some part or other of the British Islands, from Cornwall to the Shetlands, while it has visited Ireland several times, and is even recorded from St. Kilda. But it is only as a wanderer that it comes, since there is no evidence of its having ever attempted to breed in Great Britain; and indeed its conspicuous appearance—for it is nearly as big as a daw and very brightly coloured—would forbid its being ever allowed to escape a gun. Except the bald, scapulars and tertials, which are bright reddish-brown, the plumage of both sexes is almost entirely blue—of various shades, from pale turquoise to dark ultramarine-tinted in parts with green. The bird seems to be purely insectivorous. The genus *Coracias*, for a long while placed by systematists among the crows, has really no affinity whatever to them, and is now properly considered to belong to the heterogeneous group of birds now associated as *Coraciiformes*, in which it forms the type of the family Coraciidae; and its alliance to the bee-eaters (Meropidae) and king-fishers (Alcedinidae) (q.v.) is very evident. Some eight other species of the genus have been recognized, one of which, *C. leucocapthalus* or *C. abyssinicus*, is said to have occurred in Scotland. India has two species, *C. indicus* and *C. affinis*, of which thousands upon thousands used to be annually destroyed to supply the demand for gaudy feathers to bedizen ladies' dresses. One species, *C. temmincki*, seems to be peculiar to Celebes and the neighbouring islands, but otherwise the rest are natives of the Ethiopian or Indian regions. Allied to *Coracias* is the genus *Eurystomus* with some half-dozen species, of similar distribution, but one of them, *E. pacificus*, has a wider range, for it inhabits Australia and reaches Tasmania.

Madagascar has four or five very remarkable forms which have often been considered to belong to the family Coraciidae; and, according to A. Milne-Edwards, no doubt should exist on that point. Yet if any may be entertained it is in regard to one of them,

¹ Gesner in 1555 said that the bird was thus called, and for this reason, near Strassburg, but the name seems not to be generally used in Germany, where the bird is commonly called *Rake*, apparently from its harsh note. The French have kept the name *Roller*. It is a curious fact that the roller, notwithstanding its occurrence in the Levant, cannot be identified with any species mentioned by Aristotle.

Leptosomus discolor, which, on account of its zygodactylous feet, some authorities place among the Cuculidae, while others have considered it the type of a distinct family Leptosomatidae. The genera *Brachypteracias* and *Aetolnis* present fewer structural differences from the rollers, and perhaps may be rightly placed with them; but the species of the latter have long tarsi, and are believed to be of terrestrial habit, which rollers generally certainly are not. These very curious and in some respects very interesting forms, which are peculiar to Madagascar, are admirably described and illustrated by a series of twenty plates in the great work of A. Grandidier and A. Milne-Edwards on that island (*Oiseaux*, pp. 223-250), while the whole family Coraciidae is the subject of a monograph by H. E. Dresser, as a companion volume to his monograph on the Meropidae. (A. N.)

ROLLER. For agricultural purposes the roller formerly consisted of a solid cylinder of timber or stone attached to a frame and shafts, but to facilitate turning two or more iron cylinders revolving on an axle are now generally used. The simplest form has a smooth surface. The diameter of the drum should be as great as possible—30 in. being a good size—because the larger this is the more easily it is pulled (within certain limits), while rollers of small diameter are heavier of draught and do their work less efficiently. The implement is used in spring and summer as an aid in pulverizing and cleaning the soil, by bruising clods and lumps of tangled roots and earth which the cultivator or other implement has brought to the surface; in smoothing the surface for the reception of small seeds or the better operation of the mower or reaper; in consolidating soil that is too loose in texture and pressing it down about the roots of young plants. In the case of young plants the roots are close to the surface, which must therefore be kept moist. This end is attained by the compression by the roller of the top-soil of which the capillarity, *i.e.* the power of drawing water from the sub-soil is thereby increased. On the other hand, when it is desired to conserve the soil-moisture, the roller may be followed by the harrow, which, by pulverizing the surface-soil, breaks the capillarity. Of the variations on the common smooth roller, the clod-crusher and the Cambridge roller are the most important. The clod-crusher combines weight with breaking power. The best-known form was patented about 1841 by Crosskill, and consists of a number of disks with serrated edges threaded loosely on an axle round which they revolve. The Cambridge roller carries on its axle a number of closely packed wheels, the rims of which narrow down to a wedge shape. The tubular roller, instead of drums, has tubes arranged longitudinally, producing a corrugated surface which is reproduced in the condition of the soil after it has been rolled.

ROLLER-SKATING, a pastime which, by the use of small wheels instead of a blade on the skate, has provided some of the pleasures of skating on ice without having ice as the surface (see SKATING). Wheeled skates were used on the roads of Holland as far back as the 18th century, but it was the invention of the four-wheeled skate, working on rubber springs, by J. L. Plimpton of New York, in 1863, that made the amusement popular. Still greater advance was made by the Raymond skate with ball and cone bearings. The wheels or rollers were first of turned boxwood, but the wearing of the edges was a fault which has been surmounted by making them of a hard composition or of steel. The floor of the rink on which the skating takes place is either of asphalt or of wood. The latter is that always used in newly made rinks. The best floors are of long narrow strips of maple. Figure-skating on roller-skates is in some respects easier to learn than on ice-skates, the four points of contact given by the wheels rendering easier the holding of an edge; but some figures, such as loops, are more difficult.

ROLLIN, CHARLES (1661-1741), French historian and educationist, was born at Paris on the 30th of January 1661. He was the son of a cutter, and at the age of twenty-two was made a master in the Collège du Plessis. In 1694 he was rector of the university of Paris, rendering great service among other things by reviving the study of Greek. He held that post for two years instead of one, and in 1699 was appointed principal of the Collège de Beauvais. Rollin held janensist

principles, and even went so far as to defend the miracles supposed to be worked at the tomb of François de Paris, commonly known as Deacon Paris. Unfortunately his religious opinions deprived him of his appointments and disqualified him for the rectorship, to which in 1719 he had been re-elected. It is said that the same reason prevented his election to the French Academy, though he was a member of the Academy of Inscriptions. Shortly before his death (14th December 1741) he protested publicly against the acceptance of the bull *Unigenitus*.

Rollin's literary work dates chiefly from the later years of his life, when he had been forbidden to teach. His once famous *Ancient History* (Paris, 1730-38), and the less generally read *Roman History*, which followed it, were avowed compilations, uncritical and somewhat inaccurate. But they instructed and interested generation after generation almost to the present day. A more original and really important work was his *Traité des études* (Paris, 1726-31). It contains a summary of what was even then a reformed and innovating system of education, including a more frequent and extensive use of the vulgar tongue, and discarded the medieval traditions that had lingered in France.

See Sainte-Beuve, *Causeries du lundi*, vol. vi.

ROLLINAT, MAURICE (1853-1903), French poet, was born at Châteauroux in 1853. His father represented Indre in the National Assembly of 1848, and was a friend of George Sand, whose influence is very marked in young Rollinat's first volume, *Dans les brandes* (1877). The volume, however, attracted little attention, and it was with his second publication, very different in manner, that he made his reputation. In *Les Névroses*, with the sub-title *Les Âmes, Les Luxures, Les Refuges, Les Spectres, Les Ténébreux*, he showed himself as a disciple of Charles Baudelaire. He constantly returns in these poems to the physical horrors of death, and is beset by unpleasant images. *Less outré* in sentiment are *L'Abîme* (1886), *La Nature*, and a book of children's verse, *Le Livre de la Nature* (1893). He was musician as well as poet, and set many of his songs to music. He lost his reason in consequence of his wife's death from hydrophobia, and died on the 26th of October 1903.

ROLLING-MILL, a term which includes several types of machines used for producing the sectional forms (fig. 1) in which wrought iron and steel are required for the use of boiler-makers, platers and bridge-builders, and for constructional work generally. The production of wrought iron has been a diminishing industry for many years, while that of steel increases. Though the plant employed for both is alike in essential principles of design, the growth in the use of steel has revolutionized the practice, chiefly on account of the more massive dimensions in which steel sections are rolled. Iron sections are relatively small, and many are produced by piling, i.e. by building up with small portions of malleable puddled metal. There is no limit in reason to the dimensions in which steel sections can be rolled, and they are never piled, however large, but always rolled from solid cast ingots.

When steel ingots are rolled into sectional forms the reduction in transverse dimensions is very great. The work begins at nearly a white heat, and continues until a low red is reached. Obviously the stresses to which the material is subjected are very severe. For this reason the process of reduction has to be effected very gradually, and especially so in those cases where reduction is being done in two directions at right angles with each other, as in channel sections (fig. 6) and joist or beam sections (figs. 7 and 8).

It might be thought, since steel is always cast previously to rolling, that it might be cast at once into the sectional forms required. But sound results could not be obtained in this way, because the gases occluded in the metal form blow-holes which are sources of weakness. The material itself, even in the solid portions, is not homogeneous. By removing the head of the ingot where the blow-holes chiefly congregate and rolling the remainder at a white or red heat, the metal is improved by consolidation, and by the work done upon it. To this practice there is no exception.

Rolling-mills are known as "two-high," or "three-high," according as two or three rolls are mounted one over the other.

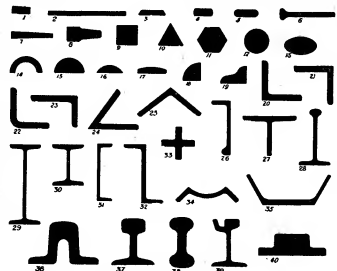

FIG. 1.—Forms of the Principal Rolled Sections.

- 1, 2, Flats. 3, Flat with bevelled edges. 4, 5, Flats with rounded edges. 6, Bulb bar. 7, Wedge bar. 8, Scree or grate bar. 9, Square. 10, Triangular. 11, Hexagonal. 12, Round. 13, Oval. 14, Hollow half-round. 15, Half-round. 16, Convex. 17, Square-edged convex. 18, Tee. 19, O.G. 20, Angle iron. 21, Square root, or square throat angle. 22, Round-backed angle. 23, Unequal-sided angle. 24, Acute angle. 25, Obtuse angle. 26, Bulb angle. 27, Tee. 28, Bulb tee. 29, 30, Beams or joists, or girders, or H-irons. 31, Channel. 32, Zed. 33, Cruciform section. 34, Pillar section. 35, Troughing. 36, 37, 38, Railway rail. 39, Tramway rail. 40, Heavy crane rail.

(figs. 2 and 3). In the two-high type the two rolls revolve in opposite directions, so that an ingot, slab or bloom presented to the entering side is drawn in and between the rolls, which reduce its thickness. In the case of rolls which are two perfectly plain cylinders (plate-rolls) the shape produced is that of broad, long and flat plates or sheets. Several passages (passes) are required to effect the reduction required, because this must be gradual. To regulate the amount the top roll is set down bodily by means of screws pressing on its bearings which slide in the end supports (housings). In the case of plate-rolls, which are plain cylinders, this setting down must be equal at each end. The mass of the top roll is balanced, to avoid shock when a plate is entering. The rolls are made of cast iron, and are either *grain* rolls or *chilled* rolls. The first are formed from a tough strong grade of iron, the quality which is used for all the roughing down and general work. The second are made of a highly mottled iron, cast against a cold mould (chill) of cast iron, by which a steely surface is obtained. These are used for fine finishing, or for imparting a polished surface to a section already nearly reduced to size in grain rolls. In later heavier practice, rolls of cast steel and forged steel are becoming common. They are more costly than iron, but more durable and much lighter for equal strength. They are essential in armour plate rolls. The length of rolls should not exceed about four times their diameter, for otherwise they are liable to spring and produce plates thicker at the centre than towards the edges.

From this elementary design several types are derived. In the two-high mill it is clear that if the direction of the rotation of the rolls is always the same, then the plate being rolled must be taken back after each "pass" to the front of the rolls. Hence there is one "lost pass" for every reduction in thickness. This is the case in the "pull-over" mill, nearly obsolete. In the two-high reversing mill, introduced to avoid this "lost pass," as soon as a plate has gone through, the direction of rotation of the rolls is reversed, and the plate is rolled again on the backward journey, so avoiding the lost

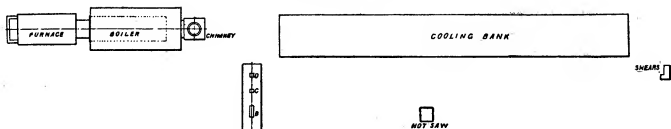

Fig. 2.—General Arrangement of 12-in. Merchant and Guide-Mill Plant. (Thomas Perry & Son Ltd., Bilston.)

A, First roughing rolls. B, Second ditto. C, Guide rolls for ovals or diamonds. D, Ditto for rounds or squares. E, Driving pinions. Engine, 30 in. \times 22 in. cylinder, direct-coupled to rolls. Runs from 100 to 180 revolutions per minute to suit work. The shears are used for cutting the smaller sections, the hot saw for cutting the merchant iron.

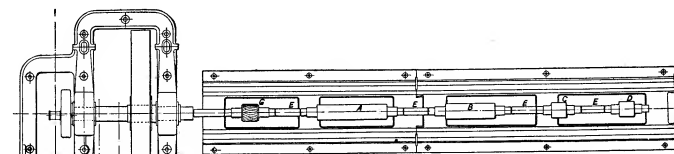
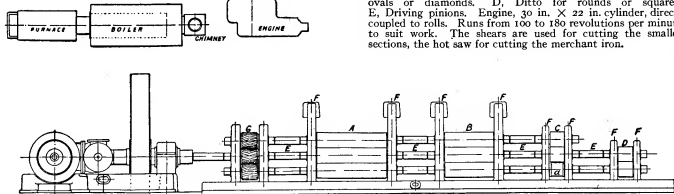

FIG. 3.—12-in. Merchant Guide-Mill and Engine. Four-set mill.

A, B, Three-high sets. C, Works either three-high or two-high; a, being a dummy roll. D, Two-high set (guide rolls). E, Coupling pieces. F, Housings. G, Pinions. The mill is capable of rolling rounds, squares, flats, angles, tees or similar sections by changing the rolls. The guide rolls D are used for small sections, and the second set B for merchant iron (larger sections).

pass. An alternative is the three-high mill, in which three rolls are used. Here the plate is run through the lower rolls and back through the upper ones, so that there is no reversal of direction of the mill as a whole, but the lower and upper rolls draw the plates in opposite directions (see also IRON AND STEEL, § 129).

Plate-Mills.—In Great Britain plate-mills are generally two-high reversing mills, in America three-high mills. Another difference is that in British practice two stands of rolls are used, in America one only. In the two-stand design there are two sets of rolls coupled endwise, one set being grain-rolls for roughing, and the other chilled rolls for finishing. Sets of live rollers conduct the plates to and from the separate rolls. The plate-mills proper are those which roll from $\frac{1}{4}$ in. to about 2 in. thick. Armour plate-mills are a special design for massive plates and sheet-mills are for thin plates or sheets having a less thickness than $\frac{1}{4}$ in. Armour plate-mills are of two-high reversing type usually, with forged steel rolls. They are of immense proportions, the rollers ranging from 10 to 14 ft. in length, by from 3 to 4 ft. in diameter. In sheet-mills, on the other hand,

the rolls seldom exceed 30 in. in diameter, and they are cheaper. The size of sheet-mills has within the last few years been considerably increased (since the introduction of steel sheets), and all new mills are made from 28 to 30 in. diameter. The mills are of the two-high type and are almost the only instance of the retention in present practice of the non-reversing mill. It is found more convenient in this case than the reversing or the three-high mills, because two men roll two pieces at once, one handing over a sheet just rolled to his fellow just as the latter has entered a sheet between the rolls on his side. Strip-mills are a smaller but similar type, used for rolling the thin narrow strips required for the hoops of barrels, ties for cotton bales, &c. The details of these mills cannot be discussed here, nor the numerous arguments in favour of the two systems. English practice retains the two-high reversing mill for all heavy work, the exceptions being those just noted. American practice retains the three-high mill.

Grooved Rolls.—In the mills designed for rolling various sectional forms the same distinction between two-high and three-high remains, but new problems arise. By "sectional forms" is meant all those which are not plates and sheets, such as bars of round and square section, angles, channels, rails and allied sections (fig. 1), for the production of which grooved rolls are required. The shapes and proportions of these grooves are such that reduction is effected very gradually. When metal is squeezed or hammered, one effect is to spread it laterally, since the metal cannot be appreciably squeezed in on itself. But the lateral extension is very much less than

the longitudinal. The most marked effect of reduction in thickness is extension in length. But as there is some lateral extension, three courses are open: one is to gauge the exact amount of width required for extension; another is to turn a bar over at intervals in order to exercise pressure on the portions extended laterally and obliterate them (open passes); and a third is to allow the extensions to take the form of fin to be cut off subsequently (closed passes). The first is generally impracticable. The second can be illustrated by diagrams representing roll sections.

The work of reduction is generally divided between three sets of rolls. The first are the cogging-, or blooming-rolls, as they are termed in America, in which ingots are reduced to blooms with dimensions suitable for rolling the various sections. In these an ingot of say 14 in. square may be reduced to a bloom of 6 in. square. The grooves form rectangular sections (box passes). The top roll being raised, the ingot is passed through the largest groove; then the roll is lowered and it is passed through a second time. Then it is turned round through 90° and re-rolled. Afterwards the same processes are gone through till the last groove is reached. There is a great difference between, say, a plate and a rail, but the cogging-rolls have to be so designed as to produce blooms for varied forms. There are three principal forms: the box just noticed, the gothic and the diamond (fig. 4), all open passes. For plates,

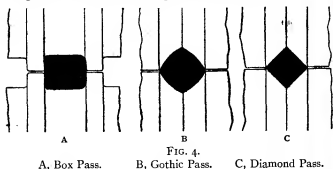

provision is made in "slabbing" rolls for roughing out, first in a box pass, and then in a broad flat groove, alternating with the square groove for correction of the edges. Gothic passes and diamond passes produce blooms which are subsequently used for various shapes are simple, and little difficulty arises in the work of drawing down. The rolls make 40 to 50 revolutions per minute; the difference in the area of the cross section (draught) between adjacent grooves is from 20 to 25%.

The formative rolls for finished sections are of two classes: roughing and finishing. The roughing-rolls approximate much more closely to the finished sections than the cogging-rolls, but the aim is to make them do duty for a wide range of sections, in order to change them as seldom as possible. Thus the gothic pass (fig. 4) will serve alike for rolling square or round bars. Finishing rolls must be changed for every different section, except when slight differences in thicknesses only are made in the webbed portion of a rolled section. With the exception of rounds, sections are usually roughed and finished in closed passes—that is, the bar is wholly enclosed by the rolls. The groove in the lower roll is flanked by collars slightly deeper than the enclosed bar. These enter into grooves turned on the upper roll, and between them the bar is confined (fig. 5). It passes through a succession of these grooves,

reduced in this way and offer no difficulty. The most unfavourable section is the joist or girder, the channels, tees and rails follow, and after these the various angles. In rolling a channel or a girder section (figs. 6, 7, 8), a square bloom is taken, and passed in succession through closed passes. The first produce shallow grooves in

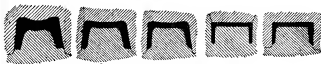

FIG. 6.—Reduction of Channel Section.



FIG. 7.—Reduction of Girder Section in Roughing Rolls.

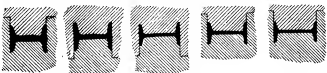

FIG. 8.—Reduction of Girder Section in Finishing Rolls.

the opposite faces, gradually deepening until the insides of the flanges assume a definite slope. The angle of slope becomes gradually lessened, and the thicknesses of web and flanges, and also the radius in the corners, are reduced. At the same time the width over the flanges is being gradually increased. While this is going on, the fibres of the flanges are being strained, because the rolls run at a higher speed at their peripheries than next the body. The metal is being violently thrust and drawn in different ways, so that while economy has to be studied by reducing the number of passes as much as possible, undue stress must be avoided by making the reductions as easy as is practicable. These things cannot be put into a formula, but the roll-turners work by experience and empirical rules gathered by long practice. In order to avoid these deep groovings, and also severe lateral thrusts on the rolls, angle sections are always rolled with the slope of the flanges approximately equalized; so too are zeds (fig. 1, No. 32). The reduction is then effected with the minimum of stress to the metal. Variations are readily made in the thicknesses of rolled sections without changing the rolls, by simply varying the distance between their centres. This is effected by the adjustment of the top roll (fig. 5). Differences in thickness are made in $\frac{1}{8}$ ths of an inch, up to a maximum of about $\frac{1}{2}$ in. Another detail of design in closed passes is so to shape the rolls as to make any pass obliterate the fin produced in the previous groove. Sometimes sections are turned over to effect this, but often the bodies of the rolls are turned of suitable diameters to produce the result. Guards are required to prevent the bars from becoming wrapped round the rolls ("collaring"). With the same object the upper roll is always made larger in diameter than the lower. Its speed is therefore slightly greater than that of the lower one. This stretches the plate or bar very slightly on the upper side, and so imparts a downward movement to it towards the floor, which is what is required. The difference in diameter varies with circumstances, ranging from $\frac{1}{16}$ th to about 1 in.

Besides the standard types of mills noticed, the two-high and three-high, there are special mills. The merchant mill simply denotes either one of the above types used for the production of flat bars. The continuous mills are special designs for rolling small rods to be drawn into wire. In these there are several pairs of rolls placed in series, so that the billet is rolled from one stand to others in succession without re-heating. There are a number of different designs, one of which is the Belgian looping mill, so called because the rod is bent backward and forward in the form of the letter S in its passage through adjacent sets of rolls. In another design a flying shear is employed, which automatically cuts off billets from the bar while the latter is travelling at the rate of 6 or 8 ft. per second. (J. & H.)

ROLLOCK, ROBERT (c. 1555–1599), the first principal of the university of Edinburgh, son of David Rollock of Powis, near Stirling, was born about 1555. He received his early education at the school of Stirling from Thomas Buchanan, a nephew of George Buchanan, and, after graduating at St Andrews, became a regent there in 1580. In 1583 he was

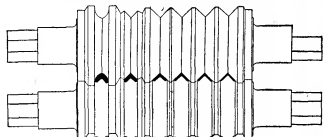

FIG. 5.—Pair of Rolls for producing Angle Sections. (Thomas Perry & Son Ltd., Bilston.)

being diminished in area and extended at each pass. A certain amount of fin is squeezed out, and this is obliterated in the succeeding pass, and more formed, until in the finishing pass the amount of reduction is very slight, a surface finish being the principal result.

Since but a slight amount of lateral extension occurs, it follows that the reduction wholly or mainly in the vertical plane is the most favourable condition. Rounds, squares and flats are wholly

appointed by the Edinburgh town council sole regent of the "town's college" ("Academia Jacobi Sexti," afterwards the university of Edinburgh), and three years later he received from the same source the title of "principal, or first master," and was engaged in lecturing on philosophy. When the staff of the young college was increased by the appointment of additional regents, he assumed with consent of the presbytery the office of professor of theology. From 1587 he also preached regularly in the East Kirk every Sunday at 7 a.m., and in 1596 he accepted one of the eight ministerial charges of the city. He took a prominent part in the somewhat troubled church politics of the day, and distinguished himself by gentleness and tact, as well as ability. He was appointed on several occasions to committees of presbytery and assembly on pressing ecclesiastical business. He was elected moderator of the General Assembly held at Dundee in May 1597. In 1598 he was translated to the parish church of the Upper Tolbooth, Edinburgh, and immediately thereafter to that of the Grey Friars (then known as the Magdalen Church). He died at Edinburgh on the 8th of February 1599.

Rollock wrote Commentaries on the Epistles to the Ephesians (1590) and Thessalonians (1598) and Hebrews (1605), the book of Daniel (1591), the Gospel of St. John (1599) and some of the Psalms (1598); an analysis of the Epistle to the Romans (1594), and Galatians (1602); also *Questions and Answers on the Covenants of God* (1596), and a *Treatise on Effectual Calling* (1597). Soon after his death eleven *Sermons* (*Certain Sermons upon Several Places of the Epistles of Paul*, 1599) were published from notes taken by his students. His *Select Works* were edited by W. Gunn for the Wodrow Society (1844-1849).

A Life by George Robertson and Henry Charteris was reprinted by the Bannatyne Club in 1826. See also the introduction to the *Select Works*, and Sir Alexander Grant's *History of the University of Edinburgh*.

ROMA, a town of Waldegrave county, Queensland, Australia, 318 m. by rail W.N.W. of Brisbane. It is the centre of a rich pastoral and wheat-growing district, in which oranges and vines are largely grown and much wine is produced. The town was incorporated in 1867. Flour-milling is its chief industry. Pop. (1901) of town, 2371; of the district, 7110.

ROMAN, capital of the department of Roman, Rumania, on the main line from Czerowitz in Bukovina to Galatz, and on the left bank of the river Moldova, 2½ m. W. of its junction with the Sereth. Pop. (1900) 14,019, including 6099 Jews. The river is here spanned by a fine bridge of iron. Roman has been the seat of a bishop since 401. Its seminary dates from 1402. There are several ancient churches, including a cathedral, built in 1541. Roman has a transit trade in the products of northern Moldavia. A large annual fair is held in August.

ROMAN ARMY. In the long life of the ancient Roman army, the most effective and long-lived military institution known to history, we may distinguish four principal stages. (1) In the earliest age of Rome the army was a national or citizen levy such as we find in the beginnings of all states. (2) This grew into the Republican army of conquest, which gradually subdued Italy and the Mediterranean world. A citizen army of infantry, varying in size with the needs of each year, it eventually developed into a mercenary force with long service and professional organization. This became (3) the Imperial army of defence, which developed from a strictly citizen army into one which represented the provinces as well as Italy, and was a garrison rather than a field army. Lastly, (4) the assaults of the Barbarian horsemen compelled both the creation of a field force distinct from the frontier garrisons and the inclusion of a large mounted element, which soon counted for much more than the infantry. The Roman army had been one of foot soldiers; in its latest phase it was marked by that predominance of the horseman which characterized the earlier centuries of the middle ages.

So far as we can follow this long development in its details, it was throughout continuous. So unbroken, indeed, is the growth that many of the military technical terms survived in use from epoch to epoch, unchanged in form though deeply modified in meaning, and ordinary readers often miss the

diversity which underlies this unchanged-seeming system. The term *legio*, for example, occurs in all the four stages above outlined. But in each its significance varies. Throughout, it denoted citizen-soldiers: throughout, it denoted also a force which was chiefly, if not wholly, heavy infantry. But the setting of these two constant features varies from age to age. In the first period *legio* was the "levy," the whole host summoned to take the field. In the second period it was not the whole levy, but one of the principal units into which developing organization had divided that levy; the "legion" was now a body of some 5000 men—the number of "legions" varied with the circumstances, and the army included other troops besides citizens, though they were for the most part unimportant. In the third or Imperial age there were many legions (indeed, a fixed number) quartered in fixed fortresses; there were also other troops, numerous and important, if not yet so formidable as the legionaries. Finally, the legions became smaller units, and the other troops of the army, notably the cavalry, became the real fighting-line of Rome (see *LEGION*).

First Stage.—The history of the earliest Roman army is, as one might expect, both ill-recorded and contaminated with much legend and legal fiction. We read of a primitive force of 300 riders and 3000 foot soldiers, in which the horseman counted for almost everything. But the numbers are clearly artificial and invented, while the pre-eminence accorded to the cavalry has no sequel in later Roman history. We reach firmer ground with the organization ascribed to Servius Tullius. In this system the host included all citizens from 17 to 60 years of age, those under 47 for service in the field, those over 46 for garrison duty in Rome. The soldiers were grouped at first by their wealth—that is, their ability to provide their own horses, armour, &c.—into cavalry (18 "centuries"), heavy infantry, a remainder which it would be polite to call light infantry, and some artificers. The heavy infantry counted for most. Armed with long spears and divided into the three orders of *hastati*, *principes* and *triarii* (the origins and real senses of these names are lost), they formed a phalanx, and charged in a mass, while the cavalry protected the wings. The men were enrolled for a year—that is, for the summer campaign; in the autumn, like all primitive armies, they went home. It has been conjectured that about the time of the fall of the kings the normal Roman army comprised some 8500 infantry under 47 years of age, 5000 seniors, 1000 riders and 500 *fabri*, &c. The evidence for the calculation is unfortunately inadequate, but the result is not altogether improbable, and it may help the reader to realize what "may have been." It must be added that this Servian system is closely connected with the political organization (see *ROME, History*).

Second Stage.—From this Servian army a series of changes which we cannot trace in detail produced the Republican army of conquest. Our ancient authorities ascribe the chief reforms to the half-legendary Camillus (*q.v.*), who introduced the beginnings of pay and long service, improved the armour and weapons, abolished the phalanx and substituted for it an open order based on small subdivisions (*maniples*), each containing two centuries.

Whatever the truth about Camillus, some such reforms must at some time have been carried through, to convert the Servian system into the army which was engaged for nearly three centuries (from 350 B.C.) in conquering Italy and the world. This army broke in succession the stout native soldiers of Italy and the mountaineers of Spain and overthrew the trained Macedonian phalanx. Once only did it fail—against Hannibal (see *PUNIC WARS*). But not even Hannibal could oust it from entrenchments, and not even his victories could permanently break its *moral*. Much of its strength lay in the same qualities which made the Puritan soldiers of Cromwell terrible—the excellent character of the common soldiers, the rigid discipline, the high training. Credit, too, must be given to the genius of the Scipios and to the more commonplace capacities of many fairly able generals. But the organism

itself deserves attention, and, as it chanced, we know much about it, mainly from Polybius. Its elements were three:—

(A) The principal unit was the legion, generally a division of 4500 men—3000 heavy infantry, 1200 lighter-armed (*velites*), 300 horse—though sometimes including as many as 6000 men. The heavy infantry were the backbone of the legion. They were levied from the whole body of Roman citizens who had some private means and who had not already served 16 campaigns, and in effect formed a yeoman force. For battle they were divided into 1200 *hastati*, 1200 *principes* and 600 *triarii*; all had a large shield, metal helmet, leather cuirass, short Spanish thrusting and cutting sword, and in addition the *hastati* and *principes* each carried two short heavy throwing spears (*pila*), while the *triarii* had ordinary long spears (see ARMS AND ARMOUR). They were drawn up in three lines: (1) *hastati*, (2) *principes*, (3) *triarii*; the first two were divided into 10 maniples each (of 120 men, when the legion only counted 4500); the third into 10 maniples of half the strength. According to the ordinary interpretation of our ancient authorities, the maniples were arranged in a chess-board fashion (*quincunx*), the idea being that the front row of maniples could retire through the intervals in the second row without disordering it, and the second row could similarly advance. Recent military writers, however,

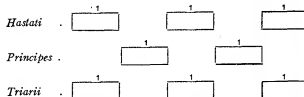

doubt whether this arrangement can be considered workable, and it is possible that our authorities did not really mean what has been supposed. In any case the procedure in fighting seems to have been simple: the front line discharged a volley of *pila* and rushed in with the short sword—a sequence much like the volley and bayonet charge of the 18th century—and if this failed, the second line went in turn through the same process: the third line of *triarii*, armed with spear instead of *pilum*, was a reserve. The *velites*, armed with javelins, were either broken up among the heavy-armed centuries or used as skirmishers or as aids to the cavalry. The 300 cavalry, however, were (it seems) of little account—a natural result if, as we have reason to think, the horses were small and stirrups were not used. The officers of the legion consisted of: (a) Six tribunes, in part elected by the comitia, in part appointed by the consuls, and holding command in rotation. They were either veteran officers, sometimes even ex-magistrates, or young noblemen beginning their career. (b) Six centurions, each commanding one century, or, rather, a pair commanding each maniple. They were chosen by the tribunes from among the veteran soldiers serving at the time and were arranged in a complicated hierarchy, by means of which a centurion might move upwards till he became *primus pilus*, senior centurion of the first maniple of *triarii*, the chief officer of the legion. (c) There were also standard-bearers and other under-officers, for whom reference must be made to specialist publications.

(B) Besides the legions, composed of citizens, the Roman army included contingents from the Italian "allies" (*socii*), subjects of Rome. These contingents appear to have been large; in many armies we find as many *socii* as legionaries, but we are ignorant of details. The men were armed and drilled like the legionaries, but they served not in legions but in cohorts, smaller units of 400–500 men, and their conventional positions seem to have been allied infantry of the legions. They were principally infantry, but included also a fairly large proportion of cavalry. Despite their numbers, they do not appear to have ranked with the heavy legionary infantry, and they were probably used more as detachments from the main army than as infantry of the line.

(C) Besides legionaries and *socii*, the Roman army included non-Italian troops of special kinds, Balearic slingers, Numidian horsemen, Rhodians, Celtiberians and others: at Trasimene, for example (217 B.C.), the Roman army included 600 Cretan archers. The numbers of these *auxilia* varied; probably they were not numerous till the latest days of the Republic. *Composition and Size of Armies in the Second Stage.*—According to the general practice, each of the two consuls, if he took the field alone, commanded an army of two legions with appropriate *socii*. If the two consuls combined their forces, commanding the joint force in rotation (as often occurred), the total would be—according to our authorities—four legions, each of 4200 infantry, the same number of "allied" infantry (in all 33,600 infantry), 1200 legionary cavalry and about 3600 "allied" cavalry = 38,400 men. Such, for example, was the Roman army at Trebia (218 B.C.), where (says Polybius) there fought 16,000 legionaries and 20,000 allied infantry. The total number of men in the field could be increased; we even hear of 23 legions serving at one time in the Second Punic War.

Just before this war, in 225 B.C., the total strength of Rome was reckoned at three-quarters of a million, of which about 65,000 were in the field and 55,000 were in a reserve at Rome; of the total, 325,000 were Roman citizens and 443,000 (apparently a rough estimate) were allies. The battle order in normal circumstances was simple. In the centre stood the legionary infantry: on each side of that was the allied infantry: on the wings the cavalry. But sometimes the legions were held in reserve and the brunt (and honour) of the fight was left to the allies. Sometimes, when the army was a double force, one commander's troops fought and the others lay in reserve. Frequently the attack was begun by one wing, as by Caesar at Pharsalus. At Ilipa in Spain Scipio put his Spanish auxiliaries in the centre, his Roman troops on the wings, and attacked with both wings. The chief command of the army fell (as stated above) to the consul, if present, or, if two consuls acted together, to them in turn. In default of consuls, a proconsul, praetor, or propraetor, in charge of a province, would command.

Development from the Second Stage to the Third.—Towards the end of the Republic many changes began to work themselves out in the Roman army. If Camillus began the system of pay and long service, it was effectually developed by long foreign wars in Spain and in the East. Moreover, the growth of Rome as a wealthy state tended to wreck the old theory that every citizen was a soldier, and favoured a division of labour between (e.g.) the merchant and the military, while the increasing complexity of war required a longer training and a more professional soldier. In consequence, the old restriction of legionary service to men with some sort of private property was abolished by Marius about 104 B.C. and the legionaries now became wholly proletariate and professionals. By a second change, also connected with the name of Marius, the legion was reorganized as a body of 6000 men in 60 centuries, divided into 10 cohorts instead of (as hitherto) into 30 maniples; the unit of tactical action thus became a body of 600 instead of 120. This was probably another adaptation within the legion of the system of cohorts already in use for the contingents of the *socii*. Soon after, the extension of the Roman franchise to all Italians converted allies and subjects into citizens, and the *socii* into legionaries. A fourth change abolished the legionary cavalry and greatly increased the *auxilia* (C above). And, finally, the appearance of great military leaders in place of civilian statesmen, and of pretenders to a throne in place of patriots, familiarized the world with the notion of large standing armies commanded by permanent chiefs, and at the same time destroyed discipline and military loyalty.

Third Stage.—The Imperial Army of Defence.—The evils of the Civil Wars (49–31 B.C.) furnished the first emperor, Augustus, with both the opportunity and the necessity for reforming the army. Disorganization had reigned for twenty years. It was needful to restore loyalty and system alike. Augustus' did this, as he did all his work, by adapting the past: yet there is some truth in the view of his latest historian, von Domaszewski, that his army reforms were his greatest and most original work. The main lines of his work are simple. The Imperial army consisted henceforward of two classes or grades of troops, about equal in numbers if unequal in importance. The first grade were the legions, recruited from Roman citizens, whether resident in Italy or in the provinces. The second grade was formed by the *auxilia*, recruited from the subjects (not the citizens) of the Empire in the provinces, organized in cohorts and *alae* and corresponding somewhat to both the *socii* and the auxiliaries (B, C above) of the Republican army. There were also in Rome special "household" troops (see PRAETORIANS); and a large body of *vigiles* who were both fire brigade and police.

(A) The legion of the Empire was what Marius had left it—6000 heavy infantry divided into 10 cohorts: Augustus added only 120 horsemen to serve as despatch-riders and the like. The supreme command was no longer in the hands of the six tribunes. According to a practice which had sprung up in the latest Republic it was in the hands of a *legatus legionis*, deputy of the general (now of the emperor, commander-in-chief of the whole army) and a man usually of senatorial rank and position. The six tribunes assisted him, in theory; in practice they were now little more than young men of good birth learning their business or wasting their

time. The real officers of the legion were the 60 centurions, men who (at least in the early Empire) generally served up from the ranks, and who knew their work. The senior centurion, *primus pilus*, was an especially important officer, and on retirement frequently became *praefectus castrorum*, "camp adjutant," or obtained other promotion. Below the centurions were under-officers, standard-bearers, *optiones*, clerks and the like. The men themselves were recruited from the body of Roman citizens (though we may believe that birth-certificates were not always demanded). During the 1st century Italy, and particularly north Italy, provided the bulk of the recruits. After A.D. 70, recruiting in Italy for the legions practically ceased and men were drawn from the Romanized towns of the provinces. After Hadrian, each province seems to have supplied most of the men for the legion (if any) stationed in it, and so many sons of soldiers born during service (*castrenses*) flocked to the army that a military caste almost grew up. The term of service was, in full, twenty years, at least in theory, but recruiting was voluntary and when men were short discharges were often withheld. On discharge the ex-legionary received a bounty or land; many *coloniae* (municipalities) were established in the provinces by certain emperors for the special purpose of taking discharged veterans—according to a custom of which the first instances occur in the latest Republican age. On the whole, the legionary was still the typical "Roman" soldier. If he were of citizen rank, and his connexion with the Empire and the government was real. Each legion bore a title and a number (e.g. II. Augusta, III. Gallica). The custom of using such titles and numbers can be detected sporadically in the latest Republic, and many titles and numbers then borne by legions passed on into the Empire with the legions themselves. As Augustus gradually became master of the world, he found himself with three armies, his own and those of Lepidus and Antony; from the three he chose certain legions to form his new standing army, and he left these with the titles and numbers which they had previously borne, although that concession resulted in three legions numbered III. and two numbered IV., V., VI. and X. respectively. Similar titles and numbers were given to legions raised afterwards either to fill up gaps caused by disaster or to increase the army. Here, as elsewhere in the Roman and above all in the Augustan system, precedent defied logic.

(B) Besides the legions Augustus developed a new order of *auxilia*. Auxiliaries (as is said above) had served occasionally in the Republican armies since about 250 B.C., and in the latest Republic large bodies of them had been enlisted in the armies of contending generals. Thus Caesar in Gaul enrolled a division of native Gauls, free men but not citizens of Rome, which ranked from the first in all but legal status as a legion, the "Alaudae," and in due course was formally admitted to the legionary list (legio V.). But this use of non-citizens had been limited in extent and confined in normal circumstances to special troops as slingers or bowmen. This casual practice Augustus reduced, or rather extended, to system, following in many details the scheme of the Republican *socii* and veiling the novelty under old titles. Henceforward, regiments of infantry (*cohortes*) or cavalry (*alae*), 500 or 1000 strong, were regularly raised (apparently, by voluntary recruiting) from the non-citizen populations of the provinces and formed a force almost equal in numbers (and perhaps ultimately much more than equal) to the legions. The men who served in these units were less well paid and served longer than the legionaries; on their discharge they received a bounty and the Roman franchise for themselves and wife and children. They were commanded by Roman *praefecti* or *tribuni*, and were no doubt required to understand Roman orders; they must have generally become Romanized and fit for the citizenship, but they were occasionally (at least in the 1st century A.D.) permitted to retain tribal weapons and methods of fighting and to serve under the command of tribal leaders, who were at once their chiefs and Roman officers. These auxiliaries provided both the whole of the archers, &c., and nearly the whole of the cavalry of the army; they also included many foot regiments. A peculiar arrangement (to which no exact parallel seems to occur in any other army) was that a cohort of 500 men might include 380 foot and 120 horse and a cohort of 1000 men or 700 foot and 240 horse (*cohors equitata*), and an *ala* might similarly include a proportion of foot (*ala pedestris*). Each regiment bore a number and a title, the latter often derived from the officer who had raised the corps (*ala Indiana*, raised by one Julius Indus) or still more often from the tribe which supplied the first recruits (*cohors VII. Gallorum*, *cohors II. Hispanorum* and the like). To what extent recruiting remained territorial is uncertain: after the 1st century, probably, the territorial names meant in most cases very little. The total number of the auxiliary regiments probably varied from time to time and can at present hardly be guessed.

Composition of Armies and Distribution of Troops in the Third Stage.—If the system of legions and *auxilia* in the early Empire was novel, the use made of them was no less so. The latest Republic offers to the student the spectacle of large field armies, and though it also reveals a counter tendency to assign special legions to special provinces, that tendency is very feeble.

Augustus ended the era of large field armies: he could, indeed, leave no such weapons for future pretenders to the throne. By keeping the Empire within set frontiers, he developed the counter tendency. That policy exactly suited the military position in his time. The early Roman Empire had not to face—as Britain or France or Germany might have to face to-day—the danger of a war with an equal enemy, needing the mobilization of all its national forces. From Augustus till A.D. 250 Rome had no continuous foe from whom to fear invasion. Parthia, her one and dangerous equal, was far away in the East and little able to strike home. Elsewhere, her frontiers bordered more or less wild barbarians, who might often harass, but could not do serious harm. To meet this there was need, not of a strong army concentrated in one or two cantonments, but of many small garrisons scattered along each frontier, with a few stronger fortresses to act as military centres adjacent to these garrisons.

Accordingly, a system grew up under Augustus and his immediate successors whereby the whole army was distributed along the frontiers or in specially disorderly districts (such as N.W. Spain) in permanent garrisons. On the actual frontiers and on the chief roads leading to them were numerous cohorts and *alae* of auxiliaries, garrisoning each its own *castellum* of 3-7 acres in extent. Close behind the frontiers, or even on them, were the twenty-five legions, each (with a few exceptions of early date) holding its own fortress (*castra stativa* or *hiberna*) of 50-60 acres. Details varied at different times. Sometimes, where no Rhine or Danube helped, and where outside enemies were many, the frontier was further fortified by a continuous wall of wooden palisades (as in part of Germany, see LIMES) or of earth or stone (as in Britain, see article BRITAIN, ROMAN), or the boundary might be guarded by a road patrolled from forts planted along it (as in part of Roman Africa). The result was a long frontier guard covering Britain, and Europe from the German Ocean to the Black Sea, and the upper Euphrates valley, and the edge of the Sahara south of Tunis and Algeria and Morocco, while the wide Empire behind it was little troubled by the presence of soldiers.

The following table shows the disposition of the legions about A.D. 120 and for many decades subsequently. It would be impossible, even if space allowed, to add the auxiliaries, since the details of their distribution are too little known. But it may be in general assumed that the total number of auxiliaries in any province was little less, and probably rather greater, than the number of legionaries, and the sizes of the various provincial armies can thus be calculated roughly. Thus Britain was held probably by 35,000-40,000 men. Each provincial army was commanded either by the governor of the province or (in a few exceptional cases) by the senior *legatus* of the legions stationed there:—

Britain	II.	Augusta (<i>Isca Silurum</i> , now Caerleon).
"	VI.	Victrix (<i>Eburacum</i> , York).
"	XI.	Valeria (<i>Vetrea</i> , Chester).
Lower Germany (= lower Rhine)	I.	Minervia (<i>Bonna</i> , Bonn).
"	XXX.	Ulpija Victrix (<i>Vetora</i> , Xanten).
Upper Germany	XXII.	Primigenia (<i>Moguntiacum</i> , Mainz).
"	VIII.	Augusta (<i>Argentorata</i> , Strassburg).
Pannonia (Danube to Semlin)	X.	Gemina (<i>Vindobona</i> , Vienna).
"	XIV.	Gemina (<i>Carnuntum</i> , Petronell).
"	I.	Adiutrix (<i>Brigetio</i> , near Komorn).
"	II.	Adiutrix (<i>Aquincum</i> , near Budapest).
Upper Moesia (Middle Danube)	IV.	Flavia (<i>Singidunum</i> , Belgrade).
"	VII.	Claudia (<i>Viminacium</i> , Kostolac).
Dacia (now Transylvania)	XIII.	Gemina (<i>Apulum</i> , Karlsburg).
Lower Moesia (Lower Danube)	I.	Italia (<i>Novae</i> , Sistov).
"	XI.	Claudia (<i>Durostorum</i> , Silistria).
"	V.	Macedonia (<i>Troesmis</i> , Iglitza).
Asia Minor (Cappadocia)	XV.	Apollinaria (<i>Satala</i> , Armenian frontier).
"	XII.	Fulminata (<i>Melitene</i> , on upper Euphrates).

Syria	XVI.	Flavia (<i>Samosata</i> , on upper Euphrates).
"	IV	Scythica
"	VI.	Ferrata } near Antioch (?).
"	III.	Gallica }
Judea	X.	Fretensis (Jerusalem).
Arabia	III.	Cyrenica (<i>Bostra</i>).
Egypt	II.	Trajana (near Alexandria—a disorderly city).
Africa	III.	Augusta (<i>Lambæsis</i>).
Spain	VII.	Gemina (<i>Legio</i> , Leon, in N.W. Spain).

The total of legionaries may be put at about 180,000 men, the auxiliaries at about 200,000. If we exclude the "household" troops at Rome, the police fleets on the Mediterranean, and the local militia in some districts, we may put the regular army of the Empire at about 400,000 men. This army, as will be plain, was framed on much the same ideas as the British army of the 19th century. It was meant not to fight against a first-class foreign power, but to keep the peace and guard the frontiers of dominions threatened by scattered barbarian raids and risings. Field army there was none, nor any need. If special danger threatened or some special area was to be conquered—such as southern Britain (A.D. 43) or a little land across the upper Rhine (A.D. 74)—detachments (*vexillationes*) were sent by legions and sometimes also by auxiliaries in adjacent provinces, and a field force was formed sufficient for the moment and the work.

Change from the Third Period to the Fourth.—Two principal causes brought gradual change to the Augustan army. In the first place, the *pax Romana* brought such prosperity to many districts that they ceased to provide sufficient recruits. The Romans, like the British in India, had more and more to look to uncivilized regions and even beyond their borders. Hence comes, in the 2nd century and after, a new class of *numeri* or *cunei* or *vexillationes* who used (like the earlier auxiliaries) their national arms and tactics and imported into the army a more and more non-Roman element. This tendency became very marked in the 3rd century and bore serious fruit at its close. And, secondly, the old days of mere frontier defence were over. The barbarians began to beat on the walls of the Empire as early as A.D. 160: about A.D. 250 they here and there got through, and they came henceforward in ever-growing numbers. Moreover, they came on horseback, bringing new tactics for the Roman infantry to face, and they came in huge masses. We may doubt if any military system could have permanently stayed this astonishing torrent. But the Empire did what it could. It enlisted barbarians to fight barbarians, and added freely—too freely, perhaps, if there was any choice—to the non-Roman elements of the army. It increased its cavalry and began to form a distinct field force.

Fourth Period.—The results are seen in the reforms of Diocletian and Constantine the Great (A.D. 284—circa 320). New frontier guards, styled *limitanei* or *riparienses*, were established, and the old army was reorganized in field forces which accompanied or might accompany the emperors in war (*comitatenses*, *palatini*). The importance of the legions dwindled; the chief soldiers were the mercenaries, mostly Germans, enlisted from among the barbarians. New titles now appear, and it becomes plain even to the casual reader that in many points the new order is not the old. The details of the system are as complicated as all the administrative machinery of that age. Here it is enough to point out that the significance of such officers and titles as the *dux* and the *comes* (duke, count) lies ahead in the history of the middle ages, and not in the past, the history of the Roman army itself.

War Office, General Staff.—Under the Republic we do not find, and indeed should not expect to find, any central body which was especially entrusted with the development of the army system or military finance or military policy in wars. Even under the Empire, however, there was no such organization. The emperor, as commander-in-chief, and his more or less unofficial advisers doubtless decided questions of policy. But the army was so much a group of provincial armies that

much was left to the chief officers in each province. Here, as elsewhere in the Empire, we trace a love if not for Home Rule, at least for Devolution. There was, however, a central finance office in Rome for the special purpose of meeting the bounties (or equivalent) due to discharged soldiers. This was established by Augustus in A.D. 6 with the title *aerarium militare*, and had, for receipts, the yield of two taxes, a 5% legacy duty and a 1% on sales (or perhaps only on auction-sales). The legacy duty did not touch legacies to near relations or legacies of small amount.

BIBLIOGRAPHY.—Liebenan, "Exercitus," in Pauly-Wissowa, *Realencyclopädie*; Von Domaszewski, in Mommsen-Marquardt's *Handbuch der römischen Altertümer* (2nd ed., Leipzig, 1884), vol. v, pp. 319-612; H. Delbrück, *Geschichte der Kriegskunst*, vol. i, 2nd ed. (Berlin, 1907); E. Lammert, "Die Entwicklung der römischen Taktik," in *Neue Jahrbücher für das klassische Altertum*, ix. 100-28, 1867-87; Cagnat's article "Legio" in Daremberg and Saglio, *Dictionnaire des antiquités grecques et romaines*; E. G. Hardy, *Studies in Roman History* (London, 1906-9); Th. Mommsen, "Das römische Militärwesen seit Diocletian," in *Hermes*, xxiv. 195-279. (F. J. H.)

ROMAN ART. (1) *Introductory: History of Recent Research.*—The scientific study of ancient Roman art dates from a comparatively recent period. The great artists of the Renaissance, headed by Raphael and Michelangelo, showed no lack of appreciation for such models as the bas-reliefs of Trajan's Column; and it is sufficient to name Mantegna's "Triumph of Caesar" in order to recall the influence exerted by Roman historical sculpture upon their choice and treatment of monumental subjects; but their eyes were fixed on the Greek ideal, however imperfectly represented by monuments then accessible, and the supremacy of this standard became established beyond challenge. In the 18th century Winkelmann, the founder of the science of classical archaeology, directed the gaze of students and critics towards the glories of classical Greek art, which he divined behind the copies which filled the palaces and museums of modern Rome; and the rediscovery of the extant remains of that art, which began early in the 19th century and still continues, has naturally absorbed the attention of the great majority of classical archaeologists. Nevertheless, towards the close of the 19th century, when the main lines of Greek artistic development had been firmly traced and interest was aroused in its later offshoots, critics were led to examine more closely the products of the Roman period. As early as 1874 Philippa had published a study of Roman triumphal reliefs;¹ but his intention was to show that they were derived from the paintings exhibited on the occasion of a triumph—a theory which can no longer be maintained—and not to determine their place in the history of art. In 1893, however, Alois Riegl published a series of essays on the history of ornament under the title of *Stilfragen*, in one of which he expressed the opinion that "there was in the antique art of the Roman Empire a development along the ascending line and not merely a decadence, as is universally believed." This thesis was taken up two years later by Franz Wickhoff in a preface contributed to the reproduction in facsimile of the illustrated MS. of Genesis in the imperial library at Vienna. Wickhoff contended that, whilst the art of the Augustan period was the culmination of that which had flourished under the Hellenistic monarchies, it was succeeded by an outburst of genuinely Roman artistic effort, which reached the height of its achievement in the reliefs and portrait-sculpture of the Flavian period, and gave birth in the 2nd century A.D. to the monuments of the "continuous" style of representation exemplified by the imperial columns. Wickhoff's work has become familiar to English readers through Mrs Strong's

¹ The eleventh book of Winkelmann's *Geschichte der Kunst*, which deals with art under the Romans, contains notable proofs of the author's sureness of vision; for example, he divined the true date and affinities of the reliefs in the Villa Borghese, afterwards wrongly attributed to the time of Claudius (see below).

² "Über die römischen Triumphreliefs und ihre Stellung in der Kunstgeschichte" (*Abhandlungen der sächs. Gesellsch. der Wissenschaften*, vi., 1874).

excellent translation, with copious illustrations, which appeared in 1900; in the following year Riegl published the first (which, by reason of his untimely death, remains the only) volume of his *Late Roman Industrial Art in Austria and Hungary*, in the opening chapters of which he endeavours to show that the later transformations of Roman art in the 2nd and succeeding centuries after Christ continue to mark a definite advance. On the other hand, the originality of Roman art under the Empire was called in question by Josef Strzygowski, whose first important work on the subject, *Orient oder Rom*, appeared in 1901. Strzygowski holds that even in the imperial period, Rome was receptive rather than creative; that what is termed "Roman imperial art" is in reality the latest phase of Hellenistic art, whose chief centres are to be sought in Asia Minor, Syria and Egypt; and that this late Hellenistic art was itself gradually transformed by the invading spirit of the East into that Byzantine art which is half Greek and half Oriental, but wholly un-Roman. The problem thus stated will presently be discussed; in the meantime it is to be noted that the principal monuments which fall within our province have been at length rendered accessible to students by a series of adequate reproductions. In sculpture, the reliefs of Trajan's Column have been published by Cichorius, and those of the column of Marcus Aurelius by Petersen and others; in metal-work, the treasure of Bosco Reale has been reproduced in the *Monuments Pict.*, and that of Hildesheim has been published by the authorities of the Berlin Museum; a series of reproductions, including all the important examples of Roman painting, is issued by the firm of Bruckmann under the supervision of Paul Herrmann; and the ancient paintings preserved in the Vatican library, which include some of the most famous examples of the art, were published and described by Dr Nogara in 1907. The discussion of the date to be assigned to the Trophy of Trajan at Adam-Klissi in the Dobruja, initiated by Adolf Furtwängler, has led to a closer study of the remains of Roman provincial art; and the discovery of the foundations of the Ara Pacis Augustae at Rome, together with additional remains of its sculptured decoration, has given an impulse to the study of Roman historical monuments. In this field important contributions to knowledge have been made by members of the British school at Rome, which will be noticed below. Finally, the history of Roman sculpture has for the first time been systematically and comprehensively treated by Mrs Strong in a handbook whose copious and well-chosen illustrations add greatly to its value. Thus the necessary equipment has been furnished for students of the problem presented by Roman art.

(2) *National Roman Art; Landmarks of its History.*—It is impossible to speak of a specifically Roman national art until we approach the latest period of Republican history. The germs of artistic endowment which existed in the Roman character were not developed until her political institutions were matured and her supremacy in the Mediterranean established. Up to that time such works of art as were produced in, or imported into, Rome were without exception Greek or Etruscan. Both in Etruria and in Latium Greek artists were commissioned to decorate the temples in which wood and terra-cotta took the place of the marble which Greece alone could afford to use. In 496 B.C., according to tradition, two Greek artists, Damophilus and Gorgasos, decorated the temple of Ceres, Liber and Libera with paintings and sculpture; when the temple was restored by Augustus their terra-cotta reliefs were carefully removed and framed.¹ But most of the early sculpture preserved in Rome doubtless belonged to the "Tuscan" school, whose works Pliny² quotes as evidence that there was an art of staturary native to Italy. It is true that Etruscan art was dependent for its motives and technique on Greek models; but in its portraiture—notably in the reclining figures which adorn Etruscan sarcophagi—we can trace the uncompromising realism and close attention to detail which are native to Italian

soil; the fragments of temple-sculptures which have been preserved are of less value, since, if not the work of Greeks, they are entirely Greek in conception. Roman portraiture undoubtedly continues the Etruscan tradition. It was a common custom in Etruria to decorate the urn containing the ashes of the dead with a lid in the form of the human head (such urns are called *canopi*), and the same desire to record the features of the departed produced the waxen masks, or *imagines*, which were preserved in the houses of the Roman aristocracy. In architecture, too, Roman builders learnt much from their Etruscan neighbours, from whom they borrowed the characteristic form of their temples, and perhaps also the prominent use of the arch and vault. But the stream of Etruscan influence was met by a counter-current from the south, where the Greek colonies in Campania provided a natural channel by which Hellenic ideas reached the Latin race; and Roman architects soon abandoned the purely Etruscan type of temple for one which closely followed western Greek models. The conquests of the later Republic, however, brought them into more direct contact with the art of Greece proper. Beginning from 212 B.C., when Marcellus spoiled Syracuse of its principal statues, every victorious general adorned his triumph with masterpieces of Greek art, whether of sculpture or of painting, and, when Philhellenism became the ruling fashion at Rome, wealthy connoisseurs formed private collections drawn from the Greek provinces—Greek craftsmen, moreover, were employed in the decoration of the palaces of the Roman nobles and capitalists, which scarcely differed from those of the great Hellenistic cities. Except in portraiture, there was nothing characteristically Roman in the art which flourished in Rome in the time of Caesar and Cicero. But the remains of an altar, preserved partly at Munich and partly in the Louvre (Plate II. fig. 10), which is believed with good reason to have been set up by Cn. Domitius Ahenobarbus shortly before 30 B.C., furnish an early example of the historical, or, to speak more exactly, commemorative art, to whose development the Empire gave so powerful an impulse. On the one face of the altar we find a Greek subject—the marriage of Poseidon and Amphitrite,—on the other a Roman sacrifice, the *suovetaurilia*, with other scenes from the life of the army. Augustus enlisted art, as he did literature, in the service of the new order. The remarkable technical dexterity which characterizes all forms of art in this period—silver plate and stucco decoration, as well as sculpture in the round or in relief—is purely Greek; but the form is filled with a new content. For Augustus determined to enlist art as well as literature in the service of the new régime, and this purpose was served not only by public monuments, such as the Ara Pacis Augustae (Plate II. figs. 11–13), but by the masterpieces of the silversmith's and gem-engraver's art (Plate VII. figs. 32–37). In the art, as in the literature of the Augustan age, classicism was the dominant note, and the naturalism so congenial to the Italian temperament was repressed, though never extinguished. The result of this was that under the Julio-Claudian dynasty academic tradition filled the place of inspiration, and Roman art failed to discover its vocation. A change came under the Flavian emperors. The painters who decorated with fairy landscapes the walls of Roman palaces, untrammelled by the conventions of official art, introduced into Rome a summary method of working, which has much in common with that of the modern impressionist school; and the sculptors of the Flavian period laid to heart the lesson taught by their successful "illusionism" (to borrow Wickhoff's term). We shall see that this is true of all forms of sculpture—historical sculpture, portraiture and decorative ornament; and we are entitled to rank this Flavian art as the specific creation of imperial Rome, whatever may have been the precise nationality of the individual workers who adorned the new capital of the world. But this phase was of short duration; and the Roman spirit, which in harmony with that of Greece had produced such brilliant results, triumphed under Trajan and found its characteristic expression in the "epic in stone" with which his column is adorned. Wickhoff claims the "continuous"

¹H.N. xxxv. 154.

²H.N. xxxiv. 34; cf. 43; and see *Quint.* xii. 10, 1.

style in which the artist recounts the Dacian campaigns of Trajan as a creation of the Roman genius. We shall see that the term is not altogether a happy one; but there is good reason (as will be shown below) for the belief that the designer of the column, however profoundly influenced in his selection of motives and in his composition of individual scenes by Greek tradition, nevertheless worked out his main principles for himself. The realism of the Roman is shown in the minute rendering of details, which makes the reliefs a priceless source of information as to military antiquities. Historical art achieved no less a triumph in the great frieze from Trajan's Forum (Plate II, fig. 16), and in the panels of the arch at Benevento. Imposing as these works are, they suffer from the defects incidental to an art which endeavours to express too much. Overcharged with detail, and packed with meanings which reveal themselves only to patient study, they lack the spacious and reposeful character of Greek art; while, if we regard only their decorative function, we must admit that the excess of ornamental surface mars the effect of the buildings which they adorn. Along the path thus marked out, Roman art continued to progress; it is true that under the influence of Hadrian there was a brief renaissance of classicism which gave birth to the idealized type of Antinous, and to certain eclectic works which belong to Greek rather than to Roman art; but the historical reliefs which survive from the Antonine period, and more especially the sarcophagi, which reproduce scenes of Greek mythology with a close adherence to the letter but a fresh artistic spirit, show that the new leaven was at work. The main fact underlying the changes of the time was the loss of the true principles of plastic art, which even in Hellenistic times had become obscured by the introduction of pictorial methods into relief-sculpture. Colour, rather than form, now took the highest place in the gamut of artistic values. Painting, indeed, so far as our scanty knowledge goes, was not practised with conspicuous success; but the art of mosaic was carried to an extraordinary degree of technical perfection; and in strictly plastic art the choice of material was often determined by qualities of colour and transparency. For example, porphyry, basalt and alabaster of various hues were used by the sculptor in preference to white marble; and new conventions, such as the plastic rendering of the iris and pupil of the eye, were dictated by the ever-growing need for contrasts of light and shadow. This great revolution in taste has been traced, and doubtless with justice, to the permeation of the Graeco-Roman world of the 2nd century by oriental ideas. The East has always preferred colour to form, and richness of ornament to significance of subject; and in art, as in religion, the West was now content to borrow. Roman official art, however, continued to produce the historical monuments which the achievements of the time demanded; but the principles of figure-composition were less fully grasped. The reliefs of the Aurelian Column form a less intelligible series than those of the Column of Trajan; and the panels of the Arch of Septimius Severus, with their bird's-eye perspective, have not inaptly been compared to Flemish tapestries. The extravagance and pomp of the dynasty founded by Septimius Severus filled Rome with such works as the art of the time could produce; and the busts of Caracalla show that in portraiture Roman craftsmen retained their cunning. Even during the anarchy which followed masterpieces such as the portrait of Philip the Arabian were produced; and during the reign of Gallienus (A. D. 253-268), which saw the dismemberment of the Empire, there was a noteworthy outburst of artistic activity, whose products are seen in the naturalistic portraits of the emperor and the court.¹ But by the close of the 3rd century a further transformation had taken place, which coincided with the political revolution by which the absolute monarchy of Diocletian succeeded to the principate of Augustus. The portraits of Constantine and his house can no longer be termed naturalistic; they are

¹ It is very remarkable that the coin-portraits of the Gallic usurper Postumus (A. D. 258-68) are executed in precisely the same style; the coins were struck either at Trier or at Cologne.

monumental, both in scale and in conception, and, above all, their rigid "frontality" carries us back at a bound to the primitive art of the East. The classical standard set by the Greek genius had ceased to govern art, although the fund of types which Hellenism had created still furnished subjects to the artist, or was made the vehicle by which the new ideas derived from Christianity were expressed. The Roman spirit was still strong enough to maintain that interest in the human form and the representation of dramatic events which was lacking in the Oriental; but in the monuments of the Constantinian period, such as the narrow friezes of the Arch of Constantine, we can see nothing but the work of artists who had lost touch with true plastic principles, in spite of the ingenious arguments adduced by Riegl. If we are to seek for signs of progress, it must be rather in the domain of architecture, which had never ceased to make advances in dealing with the spatial and constructive problems presented by the great building works of the Empire; it was now called upon to face a fresh task in providing Christians with a fit place for public worship. In the solution of this problem the architects of the 4th century showed a wonderful fertility of resource; but to describe their achievements would be to pass the confines of Roman art in the proper sense of the word.

(3) *Individual Arts.* (a) *Architecture.*—This branch of the subject may be studied in the article ARCHITECTURE, and illustrations will be found in other articles (CAPITAL; COLUMN; ORDER; TRIUMPHAL ARCH; &c.). Architecture, regarded as a fine art, had been brought by the Greeks to the highest perfection of which it was capable under the limitations which they imposed upon themselves. The Greek temple appeals to the aesthetic sense by the simplicity and harmony of its proportions as well as by the rational correspondence between function and decoration in its several members. On these lines there was no room for progress. It is true that the Etruscans modified the type of the Greek temple and profoundly influenced Roman construction in this respect. The Etruscan temple was not approached on all sides by a low flight of steps, but raised on a high platform (*podium*) with a staircase at the front; it was broad in proportion to its depth, indeed, in many cases, square; and the temple itself (*cella*) was faced by a deep portico, which often occupied half the platform. Moreover, as the use of marble for building was unknown in early Italy, wood was employed in construction and terra-cotta in decoration, and this change of material led to a wider spacing of the columns than was possible in Greece. But these alterations in the system of proportions were disadvantageous to aesthetic effect; and the Romans—though they soon ceased (under the influence of the western Greeks) to build temples of purely "Tuscan" type—preserved certain of their features, such as the high platform and deep portico (see ARCHITECTURE, fig. 26). Nor can we regard as felicitous the design of certain Roman temples, such as that of Concord overlooking the Forum, and the supposed temple of Augustus (see *ROME*), which have a broad front (approached in the temple of Concord by a central portico) and narrow sides. The great temples of the Empire were (in general) inspired by Greek models, and need not therefore concern us; but we may notice Hadrian's peculiar design for the double temple of Venus and Rome, with twin *cellae* placed back to back. To the orders (see ORDER) of Greek architecture the Etruscans added the "Tuscan," a simplified Doric, of which an early example has been found at Pompeii, enclosed within the wall of the Casa del Fauno.² This column, which can scarcely be later than the 6th century B.C., has a smooth shaft with pronounced entasis, a heavy capital with a scotia between abacus and echinus, and a plain circular base. To the Romans we owe the "Composite" order, so called because it contains features distinctive of the Corinthian and Ionic orders (see ORDER, fig. 14). It is really a variety of the Corinthian, with Ionic volutes inserted in the capital; the earliest known example of its use is seen in the Arch of Titus. The Romans, moreover, made frequent use of the figured capital, which, as

² *Römische Mitteilungen* (1902), pl. vii.



Photo, Alinari.
FIG. 1.—DOMITIUS AHENOBARBUS
(SO CALLED).

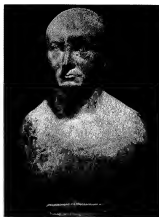

Photo, Anderson.
FIG. 2.—SCIPIO AFRICANUS
(SO CALLED).



Photo, Alinari.
FIG. 3.—UNKNOWN WOMAN.



Photo, Alinari.
FIG. 4.—VESPASIAN.



Photo, F. Bruckmann, Hanck.
FIG. 5.—UNKNOWN PHYSICIAN.



Photo, Girardon.
FIG. 6.—ANTINOUS.



Photo, F. Bruckmann, Hanck.
FIG. 7.—UNKNOWN ROMAN.



Photo, Girardon.
FIG. 8.—GALLIENUS.



Photo, F. Bruckmann, Hanck.
FIG. 9.—UNKNOWN MAN (4TH
CENTURY).



Photo, Girardot.

FIG. 10.—ALTAR OF P

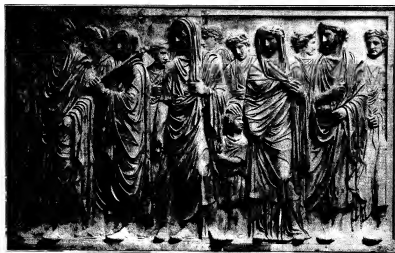

AUGUSTUS AND THE ROYAL FAMILY.



CLAUDIUS

FIGS. 11-13.—PORTIONS OF THE DEO

By permission of the Italian



By permission of the Italian Ministry of Public Instruction.

FIG. 14. RELIEF FROM THE ARCH OF TITUS: TRIUMPH OF TITUS AND THE SPOILS OF JERUSALEM.



MINOTAUROS AND AENEAS.



MINERVA.
RELIEF FROM THE ARA PACIS AUGUSTAE.
By permission of the Italian Ministry of Public Instruction.



THE EARTH GODDESS AND THE SPIRITS OF AIR AND WATER.



RELIEF FROM THE ARA PACIS AUGUSTAE.
15.—PILASTER.



By permission of the Italian Ministry of Public Instruction.
FIG. 16.—RELIEF FROM THE ARCH OF CONSTANTINE: ROMAN CAVALRY CHARGE.



Photo, Anderson.

FIG. 17.—CAESAR AUGUSTUS.



Photo, Anderson.

FIG. 18.—MEDALLION, ARCH OF CONSTANTINE.



Photo, Anderson.

CONSTANTINE DISTRIBUTING A DOLE



Photo, Anderson.

CONSTANTINE ON THE ROSTRUM.

FIG. 19.—BAS-RELIEFS ON THE ARCH OF CONSTANTINE.

the remains of Pompeii show, was an invention of the later Hellenistic age. Reduced copies of statues are found in the decoration of such capitals in the baths of Caracalla; the capitals with Victories and trophies in S. Lorenzo Fuori also belonged to a building of pagan times.

But the specific achievement of the Roman architect was the artistic application of a new set of principles—those which are expressed in the arch, the vault and the dome. The rectilinear buildings of the Greeks, with their direct vertical supports, gave place to vaulted structures in which lateral thrust was called into play. The aesthetic effect of the curves thus brought into prominence was well understood by the Romans; and they were the inventors of the decorative combination of the Greek orders with the arcade. More than this, the erection of vaults and domes of wide span, rendered possible by the use of concrete, gave to the Roman architect the opportunity of dealing artistically with internal spaces. A simple yet grandiose example of this may be found in the Pantheon of Hadrian. Circular buildings were a common feature in Italian architecture; the temple of Vesta, which doubtless represented the primitive hut or dwelling of the king, always had this form, and the theme was repeated with many variations, from the well-known circular temple in the Forum Boarium to the fantastic structure with broken outlines at Baalbek. But in the Pantheon the artist lays stress, not on the exterior, which possesses no special effect, but on the interior, whose proportions are carefully determined and give a most impressive result. The same may be said of the great halls of the Imperial Thermae, and as time went on more elaborate architectural schemes were devised to meet the requirements of the Christian Church.

(b) *Sculpture*.—It was pointed out above that in the late Republican period specifically Roman art was practically confined to portraiture. Of this we have many fine examples, such as the so-called Domitius Ahenobarbus of the Braccio Nuovo (Plate I. fig. 1); and there is a series of busts which possess a special interest in that some of them have been claimed as portraits of Scipio Africanus. The example in the Museo Capitolino (Plate I. fig. 2), with a modern inscription, though executed in the 2nd century A.D., is clearly copied from a famous Republican original. The baldness of the head has been thought to be derived from the technique of the waxen *imagines*, in which the hair was painted; the presence of a scar above the temple, which has given rise to various theories, merely betokens the unsparing realism of the Republican artist. In monumental sculpture our earliest datable example is the altar of Domitius Ahenobarbus, already referred to (Plate II. fig. 10). The ceremonial scene of the *suovetaurilia* fills the centre of the composition; to the left we see the dismissal of veterans for whom *diplomata* are being prepared; to the right the troops on active service, both horse and foot, are represented. The artist was clearly inspired by statuary and other types of earlier date, which are grouped in a somewhat loose composition. Augustan art is adequately represented by the Prima Porta statue of the emperor, discovered in 1863 in the Villa of Livia and now in the Braccio Nuovo (Plate III. fig. 17). The attitude of the figure is that of an emperor addressing his army; but there is a characteristic blending of the real with the ideal, for the emperor is not only bareheaded but barefoot, and beside him is a tiny cupid riding on a dolphin, which indicates the descent of the Julian house from Venus. We note, too, how the Roman artist—or the Greek artist interpreting the wishes of the Roman—is scarcely more concerned for the total effect of his work than for the significant details of the decoration. The chasings of the corselet display, as a central subject, the restoration by the Parthian in 20 B.C. of the standards taken from Crassus at Carrhae (53 B.C.). Not content with this, the artist has added a group of personifications indicating sunrise—Sol, Caelus, Aurora and the goddess of the morning dew—as well as Apollo, Diana, Mars and the earth goddess, and two figures symbolical of the western provinces, Gaul and Spain. It is also to be

noted that the statue shows abundant traces of its original polychrome tints—brown, yellow, blue, red and pink. It must have been executed later—probably not much later than 13 B.C., when Augustus returned from the West, and therefore belongs to the same period as the Ara Pacis Augustae, dedicated January 30, 9 B.C. This altar stood in a walled enclosure with two entrances, measuring $11\frac{1}{2}$ by $10\frac{1}{2}$ metres. The walls, with their plinth, were about 6 metres in height, and were decorated internally with a frieze of garlands and bucrania, and externally with two bands of relief, the lower consisting of conventional scrolls of acanthus varied with other floral motives, and teeming with bird and insect life, the upper showing processions (Plate II. fig. 11) passing from east to west. The most interesting of these is that on the south wall, which included Augustus himself, the *flamines* and the imperial family.² On the western face, towards which the processions are directed, we find a scene of sacrifice, with a landscape background, in which the ideal figures of senate and people appear. To the east front (apparently) belongs the beautiful group of the earth goddess (Tellus) and the spirits of air and water (Plate II. fig. 13). It is impossible to deny the incongruity of this composition with the realistic procession which adjoins it, and we can only suppose that the artist borrowed the group from some Hellenistic precursor and used it in that blend of the real and ideal which, as we saw, was the keynote of the new imperial art.

The lack of public monuments which can be assigned to the Julio-Claudian period is only in part supplied by those of private significance; the most important of these are the sepulchral *cippi* and other altars, decorated sometimes with figure-subjects, but largely with plant and animal forms rendered with the utmost naturalism. The altar with plane-leaves in the Museo delle Terme (fig. 38), though perhaps not

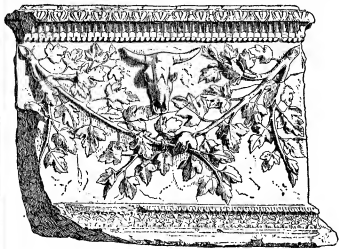

Redrawn from a photo by Anderson.

FIG. 38.—Altar with Plane-leaves.

later than Augustus, is typical of the spirit in which vegetable forms were treated under the first dynasty. We may take a female portrait discovered in an 1st-century house on the right bank of the Tiber (Plate I. fig. 3) as an example of the portraiture of this period, which shows great technical merit but a touch of conventionality.

The sculpture of the Flavian period finds its best-known example in the reliefs of the Arch of Titus. This has but a single archway; the piers had no sculptured decoration, and the narrow frieze which surmounts the architrave is perfunctorily executed. But the long panels on either side of the passage, which represent the triumph of Titus and the spoils of Jerusalem, have been deemed (by Wickhoff) worthy of a place in the history of art beside the masterpieces of Velazquez—the "Hilanderas" and the "Surrender of Breda"; and

² Some doubt has recently been cast on the identification of the emperor and his family.

¹ See Altman, *Die italischen Rundbauten* (1906).

though we cannot subscribe to his view that the artist calculated the effect of natural illumination upon the relief, it remains true that they are eminently pictorial compositions in respect of their depth of focus, yet without sacrifice of plastic effect (Plate II. fig. 14). So far as bas-relief is concerned, the problem of representing form in open space is here solved. Equally admirable in technique, though of less historical importance, are the circular medallions (*tondi*) which now adorn the Arch of Constantine, but originally belonged (as the present writer has shown)¹ to a monument of the Flavian period, perhaps the "temple of the Flavian house" erected by Domitian. The one shown (Plate III. fig. 18) is remarkable in that the head of the emperor has been replaced by a portrait, not of Constantine, but (in all probability) of Claudius Gothicus (A.D. 268-70), who was the first to divert these sculptures from their original destination.

Flavian portraits,² of which two are here figured,—a bust of Vespasian in the Museo delle Terme (Plate I. fig. 4) and a bust, now in the Lateran, found in the tomb of the Haterii, which, as is shown by the snake, represents a physician (Plate I. fig. 5),—must rank as the masterpieces of Roman art. Their extraordinarily lifelike character is due to the fact that the artist, without accumulating unnecessary detail, has contrived to catch the characteristic expression of his subject, and to render it with the utmost technical virtuosity. These portraits differ from the works of the Greek masters, who always subordinated the individual to the type, and therefore gave a less complete impression of reality than the Roman artists.

The same tendency has been noted in ornamental work which may be dated to the Flavian period. Wickhoff selected a pilaster from the monument of the Haterii (Plate II. fig. 15) upon which a column entwined with roses is carved. The flowers are not in fact represented with precise fidelity to nature, but the illusion of reality is no less great than in more accurately worked examples.

Roman sculpture soon passed the zenith of its achievement. We are not able to assign any historical monuments to the earlier years of Trajan's reign, but the portraits of the emperor betray a certain hardness of touch which makes them less interesting than those of the Flavian period. To the latter part of the reign belong a number of monuments which represent Trajanic art at its best. First and foremost come the reliefs, colossal in scale, which appear to have decorated the walls of Trajan's Forum. Four slabs were removed by Constantine's order and used to adorn the central passage and the shorter sides of the attic of his arch. The first of these (Plate II. fig. 16) shows the victorious charge of the Roman cavalry, with the emperor at its head, against their Dacian enemies. Other fragments of this frieze are extant in the Louvre,³ and a much-restored relief, walled up in the garden of the Villa Medici, shows a Dacian on horseback swimming the Danube with Trajan's Bridge in the background. The composition of the battle-scene is very fine, and the heads of the Dacians are full of character; but, although details of armour, &c., are carefully and accurately reproduced, we see clear signs of technical decadence, both in the fact that the human eye is in many cases represented as though in full face on heads which are shown in profile, and also in the naïve attempt to render several files of troops in perspective by means of superposed rows of heads.⁴ The reliefs of the spiral

column in the Basilica Ulpia tell the same tale. The designer borrowed certain motives from Hellenistic art; e.g. we find the suicide of the Dacian king Decebalus represented in precisely the same way as that of a Gallic chief on the well-known sarcophagus in the Capitoline Museum representing a battle between Greeks and Gauls; again, the symmetry of the scene in which the fall of Sarmizegetusa (the Dacian capital) is depicted recalls that of Greek monuments—particularly the painting of the fall of Troy by Polygnotus, described by Pausanias at Delphi. But the loving care with which the arms and accoutrements of the Roman troops—both regular and irregular—are rendered⁵ betrays the nationality of the artist; and his technical deficiencies, especially in the matter of perspective, point in the same direction. It seems probable, moreover, that the artistic conception of a column ornamented with a band of relief was new, and that the designer had to find his own solution for the problem. We find, in fact, that he tells his story in more than one way: (a) Considerable portions of the narrative, e.g. Trajan's march in the opening campaign, consist in a series of isolated and successive scenes; the divisions are usually marked by some conventional means, such as the insertion of a tree, or a change of direction in the action. (b) At other times the scenes unfold themselves against a continuous background, and merge almost insensibly into those which succeed them; to this form of narrative the term "continuous style," brought into use by Wickhoff, more properly applies. (c) The direct progress of the narrative is sometimes broken by passages which can only be called "panoramic"; the great composition showing the siege and fall of Sarmizegetusa falls under this head, and the "continuous" narration of Trajan's journey at the outset of the second war is followed by an extensive panorama illustrating the operations in Moesia in A.D. 105.

The reliefs (as already indicated) tell the story of both of Trajan's wars with the Dacians, a formal division between the two narratives being made by the figure of Victory setting up a trophy; and the design of the second series shows a decided advance in artistic and dramatic effect on that of the first. Clearly the artist learnt the laws of composition applicable to his problem in the course of his work.

Before leaving the Trajanic period a word must be said as to the arch erected at Benevento (see TRIUMPHAL ARCH, fig. 2), from which point a new road—the Via Trajana—ran to Brundisium. The inscription on this arch bears the date A.D. 114, but the prominence given to Hadrian has led to the supposition that the reliefs were executed after his accession. We have already noted that the use of relief as ornament is here carried to excess in the artist's desire to present a summary of Trajan's achievements at home and abroad.⁶ The arrangement of the panels is calculated and significant. On the side which faces the town of Benevento the subjects have reference to Trajan's work in Rome. On the attic we see, to the left, a group of gods with the Capitoline triad—Jupiter, Juno and Minerva—in the foreground; to the right, Trajan welcomed at the entrance to the Capitol by the goddess Roma, the penates and the consuls. He is accompanied by Hadrian, who is designated by the gesture of Roma as the emperor's successor. The two lowest panels likewise form a single picture. To the right Trajan appears at the entrance of the Forum, where he is welcomed by the *praefectus urbis*; to the left, with the Curia as background, we see the representatives of senate, knights and people. The central panels symbolize the military and civil aspects of Trajan's government—veterans to left, merchants to right, are the recipients of imperial favour. On the other

¹ *Papers of the British School at Rome*, vol. iii. pp. 229 ff. Sieveking (*Röm. Myth.* (1907) pp. 345 ff.) believes that four of the medallions only belong to the Flavian period and the rest to Hadrian's reign.

² On this subject see Mr Crowfoot's paper in *Journal of Hellenic Studies*, xx. (1900) pp. 31 ff. A list of examples is given by Mr Wace in *Papers of the British School at Rome*, vol. iii. pp. 290 ff.

³ Mr Wace has recently identified the reliefs which show an emperor sacrificing before the temple of Jupiter Capitolinus as a part of the frieze (*Papers of the British School at Rome*, iv. pp. 229 ff.).

⁴ These features make it clear that the reliefs in the Villa Borghese, (formerly supposed to belong to an arch of Claudius, are Trajanic; see *Papers of the British School at Rome*, iii. pp. 215 ff. (Stuart Jones).

⁵ Thus Cichorius, in his publication of the reliefs, has been able to identify several of the corps which took part in the war; e.g. the "cohorts of Roman citizens" are distinguished from the barbarian auxiliaries by the national emblems on their shields.

⁶ The significance of these reliefs was first demonstrated by Domaszewski (*Jahreshefte des österreichischen archäologischen Instituts*, ii. 1899, pp. 173 ff.); a full account will be found in Mrs Strong's *Roman Sculpture*, ch. 9.

face of the arch we have a series of panels relating to Trajan's work in the provinces. On the attic the gods of the Danube provinces appear to the left, the submission of Mesopotamia on the right; the lowest panels represent negotiations with Germans (left) and Parthians (right); in the centre (as on the other face) we have a military scene (recruiting in the provinces) to left, balancing the foundation of colonies and growth of the *proles Romana* on the right. As the above description will show, this arch is, in respect of its significance, the most important monument of Roman historical art. Technically, the reliefs fall somewhat short of the best work of the Flavian period—the long panels of the archway, which represent a sacrifice offered by Trajan and his benefactions to the *municipia* of Italy, have not the *verve* of those from the Arch of Titus, but are at least as fine as the works executed for Trajan's Forum.

With the accession of Hadrian—the "Greckling," as he was called by his contemporaries—a short-lived renaissance of classicism set in. The eclectic modifications of Greek statuary types which it called forth do not fall within our province; but it should be noticed that in portraiture the most important work of this period was the idealized type of Antinous, here represented by a famous example (Plate I. fig. 6) in the Louvre, which invests the favourite of Hadrian with a divinity expressed in the terms of Hellenic art as well as a pathos which belongs to his own time.¹ The historical monuments of this and the following reign are few in number, and lack the pregnancy of meaning and vigour of execution which distinguish those of the Trajanic period; mention may be made of three reliefs in the Palazzo dei Conservatori, one of which represents the apotheosis of an empress, and of the panels in the Palazzo Rondinini shown by the analogy of a medallion of Antoninus Pius to belong to his time. This is also the place to take note of the ideal figures symbolical of the subject peoples of the Empire. Under Trajan Roman sculptors had produced the fine statues of Dacian captives which now adorn the Arch of Constantine; to the Hadrianic period belong the idealized figures of provinces, classical in pose and motive, several of which are in the Palazzo de Conservatori.²

We pass on to the period of Marcus Aurelius and Commodus, in which Roman art underwent a further transformation. The earliest monument of the time which calls for our attention is the base of the column (now destroyed) erected in honour of Antoninus Pius. Two of its faces are here shown (Plate IV. figs. 21 and 22), and the contrast is remarkable between the classicist representation of the apotheosis of Antoninus and Faustina, witnessed by the ideal figures of Rome and the Campus Martius (holding an obelisk), and the realistic treatment of the *decursio*, a ceremony performed by detachments of the praetorian guard on horse and foot. We note the endeavour of the Roman sculptor to express more than his medium will allow, and his inadequate grasp of the laws of proportion and perspective. Discarding the classical standard and its conventions, the artist disposes his figures like a child's toys, and, when confronted with the problem of the background, waves it aside and reduces the indication of the place of action to a few projecting ledges on which his puppets are supported. The reliefs of the Column of Marcus Aurelius suffer by comparison with those of Trajan's Column. The story which the designer had to tell was doubtless less definite in outline; we cannot trace, as in the former instance, the march of events towards a dramatic climax, and there is some reason to think that, although the two bands of relief, separated (as on Trajan's Column) by a figure of Victory, correspond generally with the "Germanic" and "Sarmatic" wars of Marcus down to A.D. 175, the narrative is not strictly chronological; thus the fall of rain ascribed by Christian tradition to the prayers of the "Thundering" Legion

¹ It is in the portraits of the Hadrianic period that we first meet with the plastic rendering (in marble) of the iris and pupil of the eye: on the significance of this convention see above.

² On these see Lucas's article in *Jahrb. des k. deutschen arch. Instituts* (1900), pp. 1 ff., and Mrs Strong, *Roman Sculpture*, pp. 243 ff.

(Plate IV. fig. 24) is represented at a very early stage, whereas our historians place it towards the close of the war. The figures are smaller and at the same time more crowded than those upon Trajan's Column, and the landscape is less intelligently rendered. The type of the rain-god, which is without doubt the creation of the Roman sculptor, is boldly conceived but scarcely artistic. Still the reliefs show that the designers of the time were making vigorous efforts to think for themselves, and for this reason possess a higher value than the more conventional panels now distributed between the attic of the Arch of Constantine and the Palazzo dei Conservatori, which seem to have decorated a triumphal arch set up in or after A.D. 176.³ The portraiture of the time also shows the invasion of new principles. Even before the reign of Marcus we find a tendency to emphasize the contrast between hair and flesh, the face often showing signs of high polish. In the latter half of the 2nd century the contrast is heightened by a new method of treating the hair, which is rendered as a mass of curls deeply undercut and honeycombed with drill-holes; a fine example is the Commodus of the Palazzo dei Conservatori. The aim of the sculptor is to obtain an ornamental effect by the violent contrast of light and dark—an adaptation for the purposes of plastic art of the *chiaroscuro* which more properly belongs to painting. This tendency may be seen at work in all branches of sculpture. The sarcophagi of the Antonine and later periods, with their crowded compositions and deep shadows, have the same pictorial effect; and in pure ornament the vivid illusionism of Flavian art disappears, and, though plant-forms are lavishly used—from the time of Trajan onwards we note a growing distaste for pure outlines, which are hidden beneath all-per-



(Drawn from photo, Moscow.)

FIG. 39.—Pilaster with Oak Leaf Ornament.

vading acanthus foliage—the interest of the sculptor comes to lie more and more in intricacy of pattern, produced by the complementary effect of lights and shadows. An instance of this may be found in a pilaster now in the Lateran Museum (fig. 39), which Wickhoff justly contrasts with the rose-pillar from the monument of the Haterii.⁴ It is all-important to remember that (as Strzygowski has pointed out)⁴ it is not true shadow which is contrasted with the high lights in later Roman ornament; if so, the plastic effect of the free members would be heightened, whereas the reverse is actually the case, for even the figures on sarcophagi, worked in the round though they be, do not stand out from the background—which indeed is practically abolished—but seem rather to form elements in a pattern. The reason is that pure darkness is set off against the high lights, and the whole surface being thus broken up, there remains no impression of depth.

Under Septimius Severus and his successors, Roman art drifts steadily in its new direction. The reliefs of his arch at the entrance to the Forum represent the emperor's campaigns in the East in a compromise between bird's-eye perspective and the "continuous" style which cannot be called successful;

³ This series of panels is discussed in *Papers of the British School at Rome*, vol. iii. p. 251 ff.

⁴ *Jahrbuch der preussischen Kunstsammlungen* (1904), p. 271.

a better example of the art of this period is to be seen in the relief (Plate IV. fig. 20) now in the Palazzo Sacchetti, recently published by Mr A. J. B. Wace, which probably represents the presentation of Caracalla to the senate as the destined successor of his father. The squat figures of the senators, their grouping, which, though not lacking in naturalism and a certain effectiveness, is not in its main lines aesthetic, and the lavish use of deeply drilled ornament, are features which leave no doubt as to the period to which this work should be assigned. Rome, however, could still boast a school of portrait-sculptors, whose work was of no ordinary merit. The bronze statue of Septimius Severus, which passed into the Somzée collection, has been pronounced by Furtwängler to be of much earlier date, except for the head of the emperor, and we cannot therefore feel confidence in using it as a measure of the artistic achievements of Severus's reign; but the busts of Caracalla, which represent the tyrant in his later years, are masterly both in conception and in execution.

In the second quarter of the 3rd century A.D., when the Empire was torn by internal strife, threatened in its very existence by the inroads of barbarism, and hastening towards economic ruin, art could no longer flourish, and monuments of sculpture become scarce, if we except portraits and sarcophagi. The busts of this period are easily distinguished by the treatment of the hair and beard, which seem to have been closely clipped, and are indicated by a multitude of fine chisel strokes on a roughened surface. But, rough as these technical methods may seem, the artists of the time used them with wonderful effect, and the portraits of the emperor Philip (A. D. 244-49) in the Braccio Nuovo, and an unknown Roman in the Capitoline Museum (Plate I. fig. 7), are hardly to be surpassed in their delineation of craft and cruelty. Amongst the sarcophagi of the 3rd century we select, in preference to those adorned with scenes of Greek mythology, the fine example in the Museo delle Terme (formerly in the Ludovisi collection) decorated with a *mélée* of Romans and Orientals (Plate IV. fig. 23); the principal figure—whose portrait is also to be seen in the Capitoline Museum—has been identified by Mr A. H. S. Yeames as C. Furius Sabinus Aquila Timesitheus, the minister and father-in-law of Gordian III. (d. A. D. 244). Even after the middle of the century, when the Empire was for a time dismembered, portrait-sculpture put forth fresh evidences of life and vigour. Gallienus, who was himself a dilettante and doubtless largely endowed with personal vanity, seems to have called into being a naturalistic school of sculptors, who harked back to the models of the later Antonine period, so that it is not always easy to distinguish the busts of his time from those of a much earlier date. The Louvre bust of the emperor (Plate I. fig. 8) will serve as a type of these works. But this singular renaissance was as short-lived as the eclectic revival of classicism under Hadrian. It is remarkable that the portrait of Gallienus is the last which can be identified by truly individual traits. The period of storm and stress which followed his death has left little or no monumental material for the historian of sculpture; and when the curtain again rises on the art of the new monarchy founded by Diocletian and perfected by Constantine, we seem to move in a new world. The East has triumphed over the West. Just as in Egyptian art, speaking generally, in all oriental art, before the revelation of true plastic principles, which we owe to the Greek genius, the law of "frontality" was universally operative, *i.e.* the pose of sculptured figures was rigidly symmetrical and without lateral curvature, so the portraits of Constantine and his successors are discerned at a glance by their stiff pose and fixed and stony stare. The fact is that the secret of organic structure has been lost; the bust (or statue) is no longer a true portrait, a block of marble made to pulsate with the life of the subject represented, but a monument. It was thus that the absolute monarchs of the Empire, before whom their subjects prostrated themselves in mute adoration, preferred to

be portrayed; and we cannot help recalling Ammianus's description² of the entry of Constantius II. into Rome (A. D. 356). The emperor rode in a golden chariot, turning his head neither to the right nor to the left, but gazing impassively before him "tanquam figmentum hominis." The description fits such a portrait as that of an unknown personage of the 4th century in the Capitoline Museum (Plate I. fig. 9), which has found a pangyrist in Riegl. It remains to note that the narrow bands of relief on the Arch of Constantine, some of which probably date from the reign of Diocletian,³ partake of the same monumental character as the single statues of the time. Where the nature of the subject permits, as in the case of the reliefs here represented (Plate III. fig. 19), the frontality of the central figure, and the strict symmetry of the grouping, which imparts an almost geometrical regularity to the main lines of the composition, are calculated for architectonic rather than for plastic effect. The breath of organic life has ceased to inspire the marble.

We have confined ourselves in the above section to tracing the course of development in what we may call official Roman sculpture, represented in the main, as is natural, by the monuments of the capital. The products of local schools cannot here be treated in detail. The difficult problems which they raise are best illustrated by the case of "Trajan's trophy" at Adam-Klissi in the Dobruja. Although the very name of the monument might seem to furnish sufficient evidence of its date, the late Professor Furtwängler stoutly maintained that Trajan did not restore a monument dating from 29 B.C.⁴ He called attention to the uniformity in style of the grave-monuments of soldiers from north Italy, serving in the legions of the Rhine and Danube; these date from the early imperial period, and represent (according to Furtwängler) a traditional "legionary style." It may be admitted that they are eminently Italian in their hard realistic character; but the tradition was not extinct in the Trajanic period, so that the analogy between these monuments and its rudely carved figures is inconclusive, and the ornament of the trophy, which is far from being homogeneous, contains, as Studniczka⁵ has observed, oriental elements which could not possibly be found in sculpture of the 1st century B.C. Local tradition may also be traced, *e.g.* in southern France, where the Hellenic influence which penetrated by way of Massilia was still strongly felt under the Julio-Claudian dynasty, as the sculptures of the tomb of the Julii at St Rémy and the triumphal arches of Orange and Carpentras suffice to prove. Gallo-Roman art, on the other hand, has a physiognomy of its own, whose outlines have been traced by M. Salomon Reinach (*Antiquités nationales; bronzes figurés de la Gaule romaine*, Introduction). In the Rhineland we find, at a later period, a singular school of realistic sculptors at work; the museum at Trier contains a number of their grave-monuments decorated with scenes of daily life.⁶ Nor must we omit to mention the Palmyrene sculptors of the 3rd century A.D., whose portrait-statues give us the clue to the origin of the "frontal" style of the Constantinian period.⁷

(c) *Painting and Mosaic.*—The arts whose proper medium is colour enjoyed a popularity with the ancients and with the Romans, no less than with the Greeks, at least as great as that of sculpture; we need go no further for evidence of this than the statement of Pliny⁸ that Julius Caesar paid eighty talents (£20,000) for the "Ajax and Medea" of Timomachus of Byzantium, which he placed in his newly built forum. But we are in a difficult position when we try

² Amm. Marc. xvi. 10. 10.

³ See Mr Wace's article in *Papers of the British School at Rome*, iv. pp. 270 ff.

⁴ His view is accepted by Mrs Strong (*Roman Sculpture*, p. 99).

⁵ "Tropeum Trajani" (88 ff.) (*Abhandlungen der sächs. Gesellsch. der Wissenschaften*, xxii., pp. 22 ff.).

⁶ Hettner, *Illustriertes Führer durch das Nationalmuseum zu Trier* (1903), pp. 2 ff.

⁷ Some fine examples are in the Jacobsen collection; see Arndt-Bruckmann, *Griechische und römische Portraits*, pls. 59, 60.

⁸ H. N. xxxv. 136.

¹ *Papers of the British School at Rome*, iv. pl. xxxiv., from which fig. 15 is taken.



By permission of the British School of Rome.

FIG. 20.—PRESENTATION OF CARACALLA TO THE SENATE.



Photo, Moussier.

FIG. 21.—BASE OF COLUMN OF ANTONINUS.



Photo, Moussier.

FIG. 22.—BASE OF COLUMN OF ANTONINUS.



By permission of the Italian Ministry of Public Instruction.

FIG. 23.—MÊLÉE OF ROMANS AND ORIENTALS, FROM A SARCOPHAGUS.



Photo, Anderson.

FIG. 24.—DETAIL OF THE COLUMN OF ANTONINUS.



From Richter & Taylor's *Golden Age of Classic Christian Art*, by permission of the authors and Duckworth & Co.
FIG. 25.—MOSAIC, SHOWING CLOUD AND SKY EFFECTS.



Photo, Sarsini.

FIG. 26.—FRESCO. ODYSSEUS AMONG THE SHADES.



Photo, Brugs.

FIG. 27.—FRESCO FROM POMPEII: EVENING BENEDICTION IN FRONT OF THE TEMPLE OF ISIS.



Photo, Anderson.

FIG. 28.—FRESCO: THE MARRIAGE OF ALDOBRANDINI

to estimate the artistic value of the masterpieces of ancient painting, since time has destroyed the originals, and it is but rarely that we can even recover the outlines of a famous composition from decorative reproductions. For the history of Greek painting we have in Pliny's *Natural History* a fairly full literary record; but this fails us when we come to Roman times, nor do original works, worthy to be ranked with the monuments of Roman historical sculpture, supply the want.

Painting in Italy was throughout its early history dependent on Greek models, and reflected the phases through which the art passed in Greece. Thus the frescoes which adorn the walls of Etruscan chamber-tombs show an unmistakable analogy with Attic vase-paintings. The neutral background, the use of conventional flesh-tones, and the predominant interest shown by the artists in line as opposed to colour, clearly point to the source of their inspiration; and the fine sarcophagus at Florence¹ depicting a combat between Greeks and Amazons, in which we first trace the use of naturalistic flesh-tints, though it bears an Etruscan inscription, can hardly have been the handiwork of native artists.

Roman tradition tells of early wall-paintings at Ardea and Lanuvium, which existed "before the foundation of Rome";² of these the Etruscan frescoes mentioned above may serve to give some impression. We also hear of Fabius Pictor, who earned his cognomen by decorating the temple of Salus on the Quirinal (302 B.C.); and a few more names are preserved by Pliny on account of the trivial anecdotes which attached to them. The chief works of specifically Roman painting in Republican times (other than the frescoes which adorned the walls of temples) were those exhibited by successful generals on the occasion of a triumph; thus we hear that in 263 B.C. M. Valerius Messalla was the first to display in the Curia Hostilia such a battle-piece, representing his victory over Hiero II. of Syracuse and the Carthaginians.³ We may perhaps form some idea of these paintings from the fragment of a fresco discovered in a sepulchral vault on the Esquiline in 1889,⁴ which appears to date from the 3rd century B.C. This painting represents scenes from a war between the Romans and an enemy who may almost certainly (from their equipment) be identified as Samnites; the names of the commanders are indicated, and amongst them is a Q. Fabius, probably Q. Fabius Maximus Rullianus, who played a part in the third Samnite War. The scenes are superposed in tiers; the background is neutral, the colour-scale simple, and there is but little attempt at perspective; but we note the files of superposed heads in the representation of an army, which are found at a later date in Trajanic sculpture.

We pass from this isolated example of early Roman painting to the decorative frescoes of Rome, Herculaneum and Pompeii, which introduce us to the new world conquered by Hellenistic artists. The scheme of colour is no longer conventional, but natural flesh-tints and local colour are employed; the "artist understands," as Wickhoff puts it, how to "concentrate the picture in space" instead of isolating the figures on a neutral background; he struggles (not always successfully) with the difficult problems of linear and aerial perspective, and contrives in many instances to give "atmosphere" to his scene; the modelling of his figures is often excellent; finally, he can, when need requires, produce an effective sketch by compendious methods. It must be premised that this style of wall-decoration was a new thing in the Augustan period. In the Hellenistic age the walls of palaces were veneered with slabs of many-coloured marble (*crustae*); and in humbler dwellings these were imitated in fresco. This "incrustation" style is found in a few houses at Pompeii, such as the Casa di Sallustio, built in the 2nd century B.C.; but before the fall of the Republic it had given place to what is known as the "architectural" style. In this the painter is no longer content to reproduce in stucco

the marble decoration of more sumptuous rooms; by introducing columns and other architectural elements he endeavours to give the illusion of outer space, and this is heightened by the landscapes, peopled, it may be, with figures, which form the background. We shall take as an example of such decoration one of the "Odyssey landscapes" discovered on the Esquiline in 1849; these may be amongst the more recent works of this school, but can scarcely, from the character of their surroundings, be later than the reign of Claudius. Amongst the remains of a large private house was a room whose walls were decorated in their upper portion with painted pilasters treated in perspective, through which the spectator appears to look out on a continuous background of land and sea, which is diversified by scenes from the voyage of Odysseus. It is clearly to such works as these that Vitruvius refers in a well-known passage (vii. 5) where, in describing the wall-paintings of his time, he speaks of a class of "paintings on a large scale which represent images of the gods or unfold mythical tales in due order, as well as the battles of Troy or the wanderings of Odysseus through landscapes (*topia*)."⁵ And it is worthy of note that in a chamber discovered in the 18th century below the Flavian state-rooms on the Palatine (see *ROME*) the tale of Troy seems to have been represented in a very similar manner; drawings of the panel on which the landing of Helen is depicted have been preserved. Of the eight scenes from the Odyssey found on the Esquiline three represent the adventure in the country of the Laestrygonians; the third forms a transition from this subject to the visit of Odysseus to Circe, which occupies the fourth and fifth panels;⁶ the two last depict Odysseus among the shades. The second of these, which is here reproduced (Plate V. fig. 26), is only half as wide as the others, and was probably next to a door or window. It is, however, typical in style and treatment. The artist is mainly interested in the landscape, which is sketched with great freedom and breadth of treatment. He has clearly no scientific knowledge of perspective, and commits the natural error of placing the horizon too high. His figures are identified by Greek inscriptions, and we see that artistic considerations weigh more highly with him than close adherence to his poetical text; for the group of the Danaids in the foreground has no counterpart in the Homeric description. The conventional distinction of flesh-tints between the sexes is to be observed.

The use of landscape in decoration is expressly stated by Pliny (*H.N.* xxxv. 116) to have become fashionable in Rome in the time of Augustus. He attributes this to a painter named Studius, who decorated walls with "villas, harbours, landscape gardens, groves, woods, hills, fish-ponds, canals, rivers, shores," and so forth, diversified with figures of "persons on foot or in boats, approaching the villas by land on donkeys or in carriages, as well as fishers and fowlers, hunters and even vintagers." Vitruvius, too, in the passage above quoted, speaks of "harbours, capes, shores, springs, straits, temples, groves, mountains, cattle and herdsmen"; and existing paintings fully confirm the statements of ancient writers. In the Villa of Livia at Prima Porta the walls of a room are painted in imitation of a park; from the Villa of Fannius Synistor at Bosco Reale we have a variety of landscapes and perspectives; and in the house discovered in the grounds of the Villa Farnesina by the Tiber we find a room decorated with black panels, upon which landscapes exactly conforming to Pliny's description are sketched in with brush-strokes of white. While we have no reason to dispute the accuracy of Pliny's statement, or to refuse credit to the Roman artist for the development of landscape decoration, it is to be noted that the summary methods of impressionist technique which are here employed are probably traceable to Alexandrian influence. Petronius, who puts into the mouth of one of his characters a lament over the decline of art, attributes the decadence of painting to the "audacity of the Egyptians" and their discovery of "a short cut to high art" (*tam magna artis compendiaris*). This has been thought to mean no more than the process of fresco-painting, which led to the substitution of

¹ *Journal of Hell. Stud.* iv. (1883), pls. xxxvi.-xxxviii.

² Pliny, *H.N.* xxxv. 18.

³ *Ibid.* xxxv. 22.

⁴ *Bullettino Comunale* (1889), pls. xi. xii.

⁵ The latter of these is so badly preserved that the subject cannot be precisely identified.

mere wall-decoration for elaborate easel-paintings; but this was no new invention. It has been pointed out by Mrs Strong¹ that amongst the wall-paintings of Pompeii we can distinguish a group executed in bold dashes of colour—especially white—according to the principles of modern impressionism. The most striking example of this betrays its source of inspiration by its subject—the ceremony of the evening benediction in front of the temple of Isis (Plate V. fig. 27).

So far the paintings which we have considered can only be regarded as an extremely ingenious and, in the main, tasteful form of wall-decoration; they tell us little of that which we most wish to know—the style and treatment of substantive works of painting. The gap is in some measure filled by the central panels of Pompeian walls, which are usually adorned with subject-paintings, often mythological in subject, clearly marked off from the rest of the wall and intended to take the place of pictures. †In the Architectural style these are usually framed in a species of pavilion or *œdicula*, painted in perspective;² but this motive gradually loses its importance. In the Third style ("ornate") distinguished by Mau the architectural design ceases to be intelligible as the counterfeits of real construction, and becomes a purely conventional scheme of decoration; and in the Fourth or Intricate style, which again reverts to true architectural forms, however fantastic and bewildering in their complexity, the figure-subjects are plainly conceived as pictures and framed with a simple band of colour. The subjects of these frescoes are for the most part taken from Greek mythology, and it has been argued that in the main we have to deal with reproductions of Hellenistic paintings rather than of contemporary works of art. It is not to be denied that the motives of famous compositions of earlier date may have found their way into the repertory of the Pompeian artists; it is not unnatural, for example, to conjecture that the figure of Medea here reproduced (Plate VI. fig. 30) may have been inspired by the celebrated painting of Timomachus above-mentioned. But there are reasons for thinking that the debt owed by the Pompeian artists to the Greek schools of the Hellenistic age is not so direct as was believed by Helbig, whose *Untersuchungen über die pompeianische Wandmalerei* won a general acceptance for the theory. It seems clear that in the central subjects of walls decorated in the Architectural style we are intended to see, not a picture in the strict sense, but a view of the outside landscape, generally with a small shrine or cult-statue as the centre of the piece; and the importance of the figure-subject was therefore at first subordinate. These subjects are, it is true, taken from Greek mythology, but this only proves that that source of inspiration was as freely drawn upon in the art as in the literature of imperial Rome. In the later styles figure-subjects without landscape are extremely common, but it has been shown that, e.g. in the triclinium of the Casa dei Vettii, which is decorated with a cycle of mythological paintings, the lighting is carefully calculated with a view to illusionistic effect under the local conditions, so that the conception of an outlook into external space is not given up. We sometimes, as in one of the rooms in the "Farnesina" house, find framed pictures directly imitated, and here the models were clearly of a relatively early period; but this is exceptional. The Pompeian paintings, therefore, may fairly be used as evidence for the methods and aims of art in imperial Rome; and when allowance is made for their decorative character and hasty execution, we must admit that they give token of considerable technical skill—the modelling of figures is often excellent, the colour-scale rich, the "values" nicely calculated. The composition of subject-pictures is somewhat theatrical. Amongst the wall-paintings which have been preserved are some which from their classicistic style have been thought to represent Greek originals; the most famous is the "Aldobrandini Marriage" (Plate V. fig. 28), now in the Vatican library. As a matter

of fact, the composition is formed by the juxtaposition of sculpturesque types, after a fashion familiar to Roman wall-painters. Mention may here be made of the combination of ornamental work in plaster with painting which is found at Pompeii, in the work of the Flavian period at Rome, and in tombs of the 2nd century A.D. In the Augustan period we find exquisitely modelled relief-work in plaster, used to ornament vaulted surfaces in the "Farnesina" house; it might seem natural to treat of these under the heading of Sculpture, but in point of fact they are translations from painting into stucco. At a later time both painter and modeller worked in conjunction, with admirable effect; the results are best seen in the tombs on the Latin Way.

Little can be said as to Roman portrait-painting. We know that in this branch of art the technique generally used was that called "encaustic." The colours were mixed with liquefied wax and fixed by heat; whether they were applied in a molten state or not has been disputed, but it seems more likely that the pigments were laid on cold, and a hot instrument used afterwards. Several examples of such wax-paintings have been found in Egypt, where it was the custom during the 2nd and 3rd centuries A.D. to substitute panel portraits for the plastic masks with which mummy-cases were adorned; but these cannot be described as works of high art, though they sometimes have realistic merit. A good example in the Berlin Museum (*Antike Denkmäler*, ii. pl. 13) is executed in tempera on primed canvas. The medium used in ancient as in medieval tempera painting appears from the statements of ancient writers to have been yolk of egg mixed with fig-sap or natural gums.

To the little we know of purely Roman painting something is added by that which we learn from the remains of the sister art of mosaic, which, being less easily destroyed, have survived in large numbers to the present day. It has been estimated by Gauckler that considerably more than 2000 mosaics with figure-subjects have been discovered; and the number is steadily increasing. For the origin of the art reference may be made to the article MOSAIC, where the reader will also find an explanation of the essential differences of principle between the arts of painting and mosaic. It is to the credit of the Roman artists that they were, generally speaking, alive to this distinction of method, and did not seek to produce the impression of painting executed with a liquid medium by the use of solid materials. Indeed, it seems not improbable that in this respect they had a truer conception of the function of mosaic decoration than their Greek forerunners. Amongst the mosaics of Roman date which employ a large number of exceedingly minute cubes in order to produce an illusion akin to that of painting, the most conspicuous examples are the pavement in the Lateran Museum signed by the Greek Heraclitus, which appears to reproduce the "unswept hall" of Sosos of Pergamum (see MOSAIC), and the Mosaic of the Doves from Hadrian's Villa, preserved in the Capitoline Museum, which may be supposed to have been inspired by the "drinking dove" of the same artist. The former of these contains about 120, the latter as many as 160 cubes to the square inch.

As shown in the article MOSAIC, a distinction must be drawn between *opus tessellatum*, consisting of cubes regularly disposed in geometrical patterns, and *opus vermiculatum*, in which a picture is produced by means of cubes irregularly placed. The two methods were commonly used in conjunction by the Romans, who recognized that a pavement should emphasize the form of the room to which it belonged by means of a geometrical border, while figure-subjects should be reserved for the central space. A good example is furnished by a mosaic pavement discovered on the Aventine in 1858, and preserved in the Museo delle Terme (Plate VI. fig. 29). Enclosed within a geometrical framework of guilloches and scroll-work, diversified with still-life subjects and scenic masks which break its monotony, we find a landscape evidently taken from the banks of the Nile, as the hippopotamus and crocodile, as well as the papyrus and lotus, clearly show. These Egyptian scenes are likewise found

¹ *The Elder Pliny's Chapters on the History of Art*, p. 238.

² The most striking example is that from the "House of Livia" on the Palatine.

at Pompeii, and the celebrated pavement at Palestrina, with a bird's-eye view of the Nile and its surroundings, is the finest, as well as the latest, example of the class. The conclusion to be drawn is that the Roman mosaic-workers of the early Empire owed much to Alexandrian models. Their finer works, however, were restricted in size, and formed small pictures isolated in geometrical pavements. Such mosaic-pictures were called *emblemata*, and were often transported from the great centres of production to distant provinces, where pavements were prepared for their reception. The subjects of these *emblemata*, like those of the wall-paintings of Pompeii, were, for the most part, taken from Greek mythology, and it is not easy to determine what degree of originality is to be assigned to Roman artists. We note a certain interest in the great figures of literature and philosophy. A subject of which two somewhat different versions have been preserved, commonly known as "The Academy of Plato," shows us a group of Greek philosophers engaged in discussion. In provincial pavements it is not uncommon to find portraits of poets or philosophers used to fill ornamental schemes of decoration, as in the famous mosaic at Trier signed by *Monnus*. And it is possible to trace the growth of interest in Roman literature at the expense of that of Greece. Fig. 31 (Plate VI.) shows a mosaic discovered in the *tablinum* of a villa at Sousse (Susa) in Tunis (the ancient *Hadrumentum*). It represents the poet Virgil seated, with a scroll on his knee, upon which is written *Aen. i. 8*; beside him stand the muses of tragedy and history. In one of the side-wings (*alae*) of the *atrium* was a mosaic representing the parting of Aeneas from Dido, and this was no doubt balanced by another scene from the *Aeneid*. It has also been shown that the mythological scenes depicted by the mosaic-workers of the later imperial period are frequently inspired, not by Greek poetry or even Greek artistic tradition, but by the works of Ovid; and the popularity of the legend of Cupid and Psyche is doubtless to be traced to its literary treatment by Apuleius.

The mosaic shown in fig. 31 is notable for the simplicity of its composition; and it may be laid down as a general rule that the later workers in this field preferred such subjects, consisting of few figures on a neutral background, which lend themselves to broad treatment, and are best suited to the genius of mosaic. The finer pavements discovered in the villas of the landed proprietors of the African provinces, Gaul, and even Britain, are distinguished by the excellent taste with which ornament and subject are adapted to the space at the disposal of the artist. Beside a well-chosen repertory of geometrical patterns, the mosaic-workers make use of vegetable motives taken from the vine, the olive, the acanthus or the ivy, as well as conventional figures, such as the seasons,¹ the winds, the months and allegorical figures of all kinds, forming elements in a scheme of decoration which, though often of great richness, is never lacking in symmetry and sobriety.

It is much to be regretted that the destruction, partial or complete, of the great *thermae* and palaces of the early Empire has deprived us of the means of passing judgment on the *opus musivum* proper (see *MOSAIC*), i.e. the decoration of vaults and wall-surfaces with mosaics in glass, enamel or precious materials. Effective as are the pavements constructed with tesserae of marble or coloured stone, they must have been eclipsed by the brilliant hues of the wall-mosaics. We can form but little idea of these from the decoration of fountains at Pompeii and elsewhere, and must depend chiefly on the compositions which adorn the walls and apses of early Christian basilicas. An attempt has, indeed, been made to prove that one of these—the church of S. Maria Maggiore—is nothing else than a private basilica once belonging to a Roman palace, and that its mosaics date from the period of Septimius Severus;² but it is impossible to accept this theory. The earliest monument of the class which we are now considering is the baptistry of S. Costanza at Rome, built by Constantine in the early years

of the 4th century A.D. Unfortunately the mosaics of the cupola were destroyed in the 16th century, and we derive our knowledge of them from drawings made by Francesco d'Olanda. The tambour was decorated with a maritime landscape diversified with islands and filled with a crowd of *putti* fishing; and the cupola itself was divided into twelve compartments, containing figure-subjects, by acanthus motives and caryatids. The mosaics of the annular vault which surrounds the baptistry are extant, though much restored, and purely pagan in design, showing that the decorative schemes (*Eros* and *Psyche*, vine-patterns, medallions, &c.), commonly found in pavements were also used by the *musivarii*. The mosaic-panels of the nave of S. Maria Maggiore already mentioned are (in the absence of earlier examples) very instructive as to the artistic quality of Roman *opus musivum*. Richter and Taylor's publication of some of the unrestored portions, which unfortunately form but a small fraction of the whole, serve to show that the *musivarii* had an accurate conception of the true function of mosaic destined to be seen at a distance. Their effects are produced by a bold use of simple means; a few large cubes of irregular shape serve to give just the broad impression of a human face or figure which suits the monumental surroundings and subdued light. Very remarkable is the success with which the atmospheric backgrounds are treated. To seek delicate gradations of tint by elaborate means would be waste of labour for the mosaic-worker, but the artists of S. Maria Maggiore are able to produce sky and cloud effects (cf. Plate V. fig. 25) of great beauty, when seen from the floor of the church, with the aid of broad masses of colour. Their gamut of tones is of the richest; and it is to be remarked that *no gold* is used except in the restored parts. Doubtless gold was employed in decorative wall-mosaics before the Constantinian period; but the Roman *musivarii* knew the secret of making a true mosaic picture with natural tints alone.

(4) *Work in Precious Metals.*—In the article *PLATE* the history of this branch of art in ancient times is treated, and it is there shown that it continued to be a living art, capable of producing works of the highest merit, in Roman times. The sections of Pliny's *Natural History* (xxxiii. 154 sqq.) which treat of *caelatura* deal only with the works of Greek artists, and Pliny ends with the statement that, as silver-chasing was in his time a lost art, specimens of embossed plate were valued according to their antiquity; but the extant remains of Roman plate suffice to disprove his statement, and in a previous passage (xxxiii. 139) he names the principal *ateliers* where such works were produced. The famous treasure of Bosco Reale (see *PLATE*) comprises specimens of silver-work belonging to various dates, many of which bear the inscription "Maximae"; this doubtless gives the name of the owner of the objects, whose skeleton was found near the treasure. But some of them had passed through other hands; for example, four "salt-cellars," probably of pre-Roman date, are also inscribed with the name of "Pamphilus, the freedman of Caesar." Certain pieces, too, seem older and more worn than others; two ewers, decorated with Victories sacrificing to Athena, are probably of Alexandrian origin—the lotus-flower on their handles most probably points to their Egyptian provenance. On the other hand, the various decorative styles characteristic of Augustan art are well represented,—not merely the elaborate and conventional plant-systems of the Ara Pacis Augustae, teeming with animal life, which adorn two splendid canthari, but also the naturalistic treatment of vegetable forms, of which a cup decorated with sprays of olive furnishes a good example (Plate VII. fig. 32). But the most important pieces in the collection are those which show the silversmith at work on specifically Roman subjects. Amongst the cups with *emblemata* (for the meaning of the term see *PLATE*) were two which originally contained small portraits of the master and mistress of the house to which the collection belonged. One of these became detached, and is now in the British Museum; the other is in the Louvre in its original setting. The lady's coiffure resembles that of the empresses of the later Julio-Claudian period; but this is not

¹ At least fifty examples of these have been found.

² See Richter and Taylor, *The Golden Age of Classic Christian Art* (1904).

conclusive as to date, and the style of the male portrait (which recalls the realistic bronze busts found at Pompeii) points rather to an early Flavian date. Amongst the finest pieces of this collection is a large bowl with an *emblemata* in high relief (Plate VII. fig. 35), which was at first taken to represent the city of Alexandria, on account of the *sistrum* which appears amongst the attributes of the figure. It seems, however, to be a personification of the province of Africa, which was conventionally represented with a headdress formed by an elephant's scalp with trunk and tusks. We have in this *emblemata* the earliest example of the ideal types which the Roman artists of the Empire called into being to symbolize the subject-countries; the inexhaustible fertility of the African soil is indicated by the cornucopae and the fruits carried in the bosom of the figure. But there is some trace of that overcharging of symbolism to which we drew attention in discussing the Prima Porta statue of Augustus; and, though the bowl was in a very fine state of preservation, there is little doubt that this was due to the care with which it had been kept—it was of course an ornament reserved for the table or side-board—and that we should date it to the Augustan period. The same is clearly true of the most important pieces comprised in the treasure—the pair of cups reserved by Baron Edmond de Rothschild and forming part of his collection (Plate VII. figs. 33 and 34). In these we have examples of the *crustae*, or plaques decorated in repoussé, which were mounted on smooth silver cups. The manufacture of these—or at least the designing thereof—was a special branch of *caelatura*, and Pliny mentions an artist named Teucer who achieved distinction therein; we may possibly identify him with the gem-engraver whose signature is read on an amethyst at Florence. Upon one of these (Plate VII. fig. 34), we see a seated figure of Augustus, approached by a processional group on both sides. To the left are three divinities, the foremost of whom presents a statuette of Victory to the emperor; to the right is Mars in full panoply, in whose train follow the conquered provinces, symbolized by female figures, amongst whom we recognize Africa with her elephant headgear (see above). On the other face of the cup we see Augustus again seated, receiving the homage of a group of barbarians ushered into his presence by a Roman commander. The schemes which are here found for the first time, became typical in Roman historical art, and thence passed into the service of Christianity to portray the homage of the Magi. The second cup celebrates the glories of Tiberius, whose triumphal procession appears on the one face, and a finely conceived scene of sacrifice on the other. For the occasion various dates have been suggested (13–12 or 8–7 B.C.); but it seems most likely that the return of Tiberius from Dalmatia in A.D. 9 is here commemorated.

The fortunate preservation of the Bosco Reale treasure has enabled us to appraise Roman silverwork at its true value. It also affords some confirmation of the rapid decadence of the art, which Pliny laments. Amongst the cups are two decorated with still-life subjects and signed by an artist who writes a Roman name (Sabinius) in Greek characters, which clearly belong to the last years of Pompeii, and are coarser in execution than the earlier pieces. And the simple *emblemata* of the classical period, which stand out against the background of the bowl in which they are framed, give place to such a crowded group as we find on a gold patera¹ found at Rennes and preserved in the Cabinet des Médailles, where the artist has surrounded the central *emblemata* with a frieze which detracts from its effect. This and still later specimens of Roman silversmiths' work are described in the article PLATE.

(5) *Gem-Engraving and Minor Arts.*—The art of the gem-engraver, like that of the silversmith, was naturally held in high esteem by the wealthy Romans both of the Republic and

Empire;² and the period of its highest excellence coincides almost precisely with that which gave birth to the masterpieces of Roman silver-chasing. By far the greater part of the ancient gems which exist in modern collections belong to the Roman period; and the great popularity of gem-engraving amongst the Romans is shown by the enormous number of imitative works cast in coloured glass paste, which reproduce the subjects represented in more precious materials. Not only were *intagli* thus produced to suit the popular demand, but fine cameos were at times cut (not cast) in coloured glass; the most notable example of these is a portrait of Tiberius in turquoise-coloured glass bearing the signature of Herophilus (see below).

In the style of Roman *intagli* we can trace each of the phases through which Roman plastic art has been shown to pass.³ A black agate in the Hague Museum (Furtwängler, pl. xvii. 13) supplies a characteristic portrait of the Ciceronian age; the splendid cornelian of the Tyszkiewicz collection (Furtwängler, pl. l. 19) with the signature $\text{HOPIA} \cdot \text{AABAN}$ which portrays Augustus in the guise of Poseidon in a chariot drawn by four hippocamps, is doubtless (as Furtwängler showed) to be referred to the victory of Actium; the classicism of the early Empire is exemplified by a sardonyx in Florence (Furtwängler, pl. lix. 11), which probably displays an empress of the Julio-Claudian line with the attributes of Hera; a sardonyx in the hermitage at St Petersburg (Furtwängler, pl. lviii. 1) is noteworthy because the subject is borrowed from painting and occurs on a Pompeian fresco discovered in 1897; the portraiture of the Flavian epoch is seen at its best in the aquamarine of the Cabinet des Médailles signed by Euhodos, which represents Julia, the daughter of Titus (Furtwängler, pl. lxviii. 8). Amongst later gems one of the finest is the "Hunt of Commodus" in the Cabinet des Médailles (Furtwängler, pl. l. 41), which is engraved in one of the stones most popular with the Roman artists—the "Nicolo," a sardonyx with a bluish-grey upper layer used as background and a dark brown under layer in which the design is cut.

But the masterpieces of Roman gem-cutting are to be found in the great cameos, the finest of which no doubt belonged to the treasures of the imperial house. These were engraved in various materials, including single coloured stones such as amethyst or chalcedony; but the stone most fitted by nature for this branch of art was the sardonyx in its two chief varieties—the Indian, distinguished by the warmth and lustre of its tones, and the Arabian, with a more subdued scale of colour. As examples of these we shall take the two master-works of the art—the "Grand camee de France" (Plate VII. fig. 37), and the "Gemma Augustea" (Plate VII. fig. 36), preserved in the imperial collection at Vienna. The latter is attributed by Furtwängler to Dioscorides, the artist who, as Pliny tells us, enjoyed the exclusive privilege of portraying the features of Augustus. We possess several gems inscribed with his name, as well as with those of his sons and pupils—Eutyche, Herophilus (see above) and Hyllos; and, though several of these are Renaissance forgeries, enough genuine material exists for an appreciation of his style. The Arabian sardonyx was amongst his favourite stones, and the Vienna cameo at least represents the work of his school. Blending the real with the ideal, the artist has represented in the upper zone Augustus and Rome enthroned. Behind them is a group of divine figures—the inhabited Earth, Time and Tellus, according to the most probable interpretation; to the left we see Tiberius descending from a chariot driven by Victory, before which stands a youth, probably Germanicus. We seem to have here, as first in the Bosco Reale cup, a scene from the triumphal

¹ Works of pure gold have but rarely survived to modern times; but traces of gilding remain upon many of the specimens of plate described above. In the law-books we have mention of cups adorned with golden *crustae*.

² We first hear of collections of gems in the last century of the Republic. Pompey dedicated that which had belonged to Mithridates the Great on the Capitol; Julius Caesar placed six collections in the temple of Venus Genetrix; and Marcellus dedicated another in the temple of Apollo on the Palatine.

³ The references given in the text are to Furtwängler's great work, *Die antiken Gemmen*, in which all ancient gems of any considerable importance are reproduced.

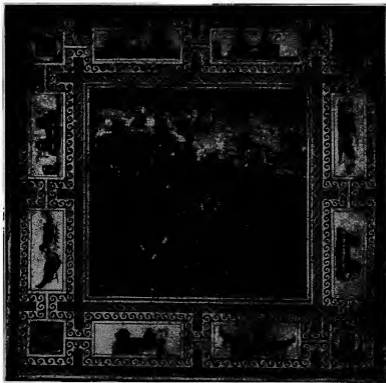

By permission of the Italian Ministry of Public Instruction.

FIG. 29.—MOSAIC PAVEMENT (MUSEO DELLE TERME).



Photo, Brugs.
FIG. 30.—MEDEA.
XXIII. 48a.



From Piat's Monument, by permission of Ernest Letoux.

FIG. 31.—THE VIRGIL MOSAIC.



*Photo.
Girardon.*

FIG. 32.—CUP DECORATED WITH SPRAYS OF OLIVE.



FIG. 33.—CUP IN THE BARON ROTHSCHILD COLLECTION.



FIG. 34.—CUP IN THE BARON ROTHSCHILD COLLECTION.



*Photo.
Girardon.*

FIG. 35.—SILVER BOWL (LOUVRE).

EMBLEMA, IN HIGH RELIEF, PERSONIFICATION OF THE PROVINCE OF AFRICA.



FIG. 36.—THE "GEMMA AUGUSTEA."



FIG. 37.—THE "GRAND CAMÉE DE FRANCE."

From Furtwängler, *Die Antiken Gemmen*, by permission of Giesecke and Devrient.

procession of A.D. 12, in the course of which, as Suetonius tells us, Tiberius stepped down from his car and did homage to his stepfather. In the lower zone we find loosely composed groups of captives and Roman soldiers, some of whom are setting up a trophy.

But the supreme triumph of imperial jewelry is attained in the Great Cameo of the Bibliothèque Nationale. This is an Indian sardonyx cut in five layers, the largest extant example of its class. There is a marked advance on the Vienna cameo in composition; the lower zone is reduced to the proportions of an exergue, whilst heaven and earth are kept clearly apart in the main subject, yet at the same time united in a single picture. In the centre are the living members of the Julio-Claudian house—Tiberius and Livia enthroned, together with Germanicus, his mother, and the rising generation—while above them hovers the deified Augustus, together with other deceased members of the family and an ideal figure in Phrygian garb bearing a globe, probably Iulus (Ascanius), or even Aeneas himself. The moment depicted is the departure of Germanicus for the East in A.D. 17, and amongst the figures of the central group we note the muse of history, bearing a scroll upon which to record the hero's deeds, and a personification of Armenia.

Engraved gems are not the only examples of Roman work in precious materials. Amongst the portraits of the first dynasty none is finer than a small head of Agrippina the younger (recently acquired by the British Museum) in *plasma* (root-of-emerald), a material much used by Roman gem-cutters. Vases, again, were carved in precious stones, such as the famous onyx vase at Brunswick (Furtwängler, *Die antiken Gemmen*, figs. 185-88), adorned with reliefs relating to the mysteries of Eleusis. A smaller, but finer, onyx vase in the Berlin Museum (Furtwängler, *op. cit.*, figs. 183, 184) represents the infancy of a prince of the Julian line—a rock surmounted by a small temple recalls the sculptures of the Ara Pacis, and the work seems to be of Augustan date.

It was mentioned above that coloured glass was used as a substitute for gems, and it is to the school which produced the cameo of the early Empire that we owe the exquisite vases in white and blue glass of which the Portland vase is the most famous example.¹ Pompeii furnishes a second in the amphora, decorated with vintage scenes, in the Naples Museum.

We must also class amongst the fine arts that of the die-sinker. Not only are the imperial portraits found on coins worthy of a place beside the works of the sculptor, but in the "medallions" of the 2nd century A.D. we find figure-subjects, often recalling those of contemporary reliefs, treated with the utmost delicacy and finish.

Of the purely industrial arts it is unnecessary to speak at length. The finds made in Gaul, Germany and Britain have enabled archaeologists to trace their history—particularly that of pottery—in some detail; but the chief importance of these discoveries lies in the fact that they prove the gradual diffusion of artistic talent throughout the provinces. In the last century of the republic a flourishing manufacture of red-glazed pottery was established with its chief centre at Arretium (Arezzo); the signatures of the vases enable us to distinguish a number of workshops owned by Romans who employed Greek or Oriental workmen. The repertory of decorative types used by these humble artists reflects the cross-currents of classicism and naturalism which were contending in the decadence of Hellenistic art; but, if we cannot set a high substantive value on their works, it is important to note that in the 1st century A.D. the Italian fabrics were gradually driven out of the market by those of Gaul, where the industry took root in the Cevennes and the valleys of the Rhone and the Allier; and before long north-eastern Gaul and the Rhineland became centres of production in the various minor

arts,² which continued to flourish until the breakdown of the imperial system in the 3rd and 4th centuries A.D.

(6) *Summary: the Place of Roman Art in History.*—Just as the establishment of the Roman Empire gave a political unity to the ancient world, and the acceptance of Christianity by its rulers assured the triumph of a universal religion, so the growth of a Graeco-Roman nationality, due to the freedom of intercourse between the subjects of the emperors, led to a unity of culture which found expression in the art of the time. Yet no sooner was the fusion of the elements which contributed to the new culture complete than the process of disruption began, which issued in the final separation of the Eastern from the Western Empire. In the first, the oriental factors, which produced a gradual transformation in Graeco-Roman art, definitely triumphed; and the result is seen in Byzantine art. But in the West it was otherwise. The realism native to Italy remained alive in spite of the conventions imposed upon it; the human interest asserted itself against the decorative. The Christian art of the West, therefore, is the true heir of the Roman, and, through the Roman, of the classical tradition. The mosaics of S. Maria Maggiore, already referred to, show how strongly this tradition was at work in the 1st century of the Christian Empire; and monuments of the 5th century A.D., such as the consular diptychs of ivory and the carved doors of S. Sabina at Rome, tell the same tale. As we have seen, Roman art in its specific quality was an historical art; and it was for this reason eminently fitted for the service of an historical religion. The earliest Christian art whose remains are preserved is that of the catacombs; and this is not only devoid of technical merit, but is also dominated by a single idea, which governs the selection of subjects—that of deliverance from the grave and its terrors, whether this be conveyed by scriptural types or by representations of Paradise and its dwellers.³ Not until the church's triumph was complete could she command the services of the highest art and unfold her sacred story on the walls of her basilicas; but, when the time came, the monumental art created by the demands of imperial pride was ready to minister *ad majorem gloriam Dei*.

BIBLIOGRAPHY.—F. Wickhoff's *Roman Art* (1900), translated by Mrs Strong from the author's *Wiener Genesis*, is well illustrated and indispensable to the student. A. Riegl's *Spätromische Kunstindustrie in Österreich-Ungarn* (1901) also repays close study. The views of Strzykowski are expressed in a large number of monographs and essays; the most important are *Orient oder Rom* (1901), *Kleinasiens, ein Neuland der Kunstgeschichte* (1903), "Mschatta" (*Jahrbuch der preussischen Kunstsammlungen*, 1904), *Der Dom zu Aachen und seine Entstehung* (1904), and articles in *Byzantinische Zeitschrift*, *Byzantinische Denkmäler*, and other periodicals. A summary of the debate raised by these writers will be found in the *Quarterly Review*, January 1906 (Stuart Jones). The controversy carried on by Furtwängler and Studniczka as to the date of the Trophy of Adam-Klissi is instructive. Furtwängler's articles appeared in the *Transactions of the Munich Academy for 1903-4*, Studniczka's ("Tropeum Trajani") in *Abhandlungen der sächsischen Gesellschaft der Wissenschaften*, xvii. (1904).

Of Roman sculpture Mrs Strong's handbook (*Roman Sculpture*, 1907), which has a great number of excellent illustrations, gives a general survey. Special branches are treated by E. Courbaud (*Le Bas-relief romain à représentations historiques*, 1899), W. Altmann (*Die römischen Grabaltäre der Kaiserzeit*, 1905), A. J. Wace ("The Evolution of Art in Roman Portraiture," *Transactions of the British and American Archaeological Society of Rome*, 1906). There has been much recent discussion of historical monuments in Rome in the *Papers of the British School at Rome*, the *Römische Mitteilungen* of the German Archaeological Institute, the *Jahreshefte der Österreichischen Archäologischen Institute*, and the *Neue Jahrbücher für Philologie*. Important publications of single monuments are: O. Benndorf (and others), *Das Tropeum von Adamklissi* (1895); E. Petersen, *Ara Pacis Augustae* (1903; further discoveries since this date are discussed by the author in *Jahreshefte des österreichischen arch. Instituts* (1906), 298 ff., and Sieveking in the same journal (1907), 175 ff.); C. Cichorius, *Die Reliefs der Trajanssäule* (1896-1900), criticized by E. Petersen, *Trajans dakische Kulte*

² For bronze-work see Willers in *Rheinisches Museum* (1907), pp. 133 ff.

³ This principle is consistently applied by von Sybel, *Christliche Antike* (Marburg, 1907).

¹ The tradition that this was found in the well-known sarcophagus of the early 3rd century now in the Capitoline Museum, formerly supposed to contain the ashes of Severus Alexander, is without foundation.

(1899-1903); E. Ferrero, *L'Arc d'Auguste à Suse* (1901); E. Petersen (and others), *Die Marcussäule* (1896).

For Roman portraits J. Bernoulli's *Römische Ikonographie* (4 vols., 1882-94) gives abundant material but little aesthetic criticism. Many of the finest portraits are included in Arndt-Bruckmann's series of *Griechische und römische Porträts*, and Brunn-Bruckmann's *Denkmäler griechisch-römischer Skulptur* contain reproductions of several Roman reliefs. The monuments collected by T. Schreiber under the title of *Hellenistische Relieffbilder* (1894) are largely of Roman date.

For Roman painting we have as yet no handbook; W. Helbig's *Untersuchungen über die campanische Wandmalerei* (1873) are still of great value, though the theory advanced is overrated. His *Campaniens Wandgemälde* (1868) gives a catalogue raisonné of Pompeian paintings, and has been supplemented by A. Sogliano, *Le pitture murali Campane* (1879). Those since discovered are described in the *Notizie degli Scavi*. A. Mau's *Geschichte der Wandmalerei* is also indispensable. Hermann-Bruckmann, *Denkmäler der Malerei des Alterthums* (1907-), will give reproductions, partly in colour, of all important specimens of ancient painting. *Die Nasse Aldobrandine*, &c., by B. Nogara (1907), contains both coloured and photographic reproductions of the paintings preserved in the Vatican library. For the Fayûm portraits see G. Ebers, *Antike Porträts* (Leipzig, 1893); F. Petrie, *Howara*, ch. vii.; and C. Edgar, *Catalogue des antiquités du musée du Caire*, "Græco-Egyptian Coffins," p. xi. ff. On the technique of ancient painting Otto Donner von Richter's introduction to Helbig's *Campaniens Wandgemälde* should be consulted. P. Girard's sketch of ancient painting (*La Peinture antique*, n.d.) is slight. For the bibliography of mosaics see that article (especially Gaucher in Daremberg and Saglio, *Dictionnaire des antiquités*, s.v. "Muséum Opus"); for work in gold and silver see the article PLATE. For gem-engraving A. Furtwängler's *Die antiken Gemmen* (3 vols., 1900) is the standard work. The history of Roman pottery is summarized by H. B. Walters, *History of Ancient Pottery*, vol. ii. 430 ff.; the most important works are J. Déchelette, *Les Vases ornés de la Gaule romaine* (1904), and H. Dragendorff's articles on "Terra sigillata" in the *Bonner Jahrbücher*.

Sections on Roman art will be found in general handbooks, such as Springer-Michaelis, *Handbuch der Kunstgeschichte* (6th ed., 1904); L. von Sybel, *Weltgeschichte der Kunst* (2nd ed., 1902); and C. Guritz, *Geschichte der Kunst*, vol. i. (1902). (H. S. J.)

ROMAN CATHOLIC CHURCH, the name generally given to that great branch of the Christian Church which acknowledges the pope, or bishop of Rome, as its head, and holds as an article of faith that communion with and submission to the authority of the see of Rome is essential to effective membership of the Catholic Church as founded by Christ. This belief is based upon the commission given by Christ to Peter as "prince of the apostles," "Feed my sheep" (John xxi. 15-17); the saying, "Thou art Peter, and upon this rock I will build my church; and the gates of hell shall not prevail against it. And I will give unto thee the keys of the kingdom of heaven: and whatsoever thou shalt bind on earth shall be bound in heaven; and whatsoever thou shalt loose on earth shall be loosed in heaven" (Matt. xvi. 18, 19). The authority thus conferred upon St Peter is held by Roman Catholics to be permanently vested in the bishop of Rome, as successor to Peter, first bishop of the imperial see. As such, the pope is regarded as "vicar of Christ, head of the bishops, and supreme governor of the whole Catholic Church, of whom the whole world is the territory or diocese." His peculiar powers as pope he exercises immediately on election. Thus he may grant indulgences, issue censures, give dispensations, canonize saints, institute bishops, create cardinals—in short, perform all the acts of his *jurisdiction*, even though he be no more than a layman; but by custom certain of his more solemn acts are postponed till after the ceremony of his coronation, from which his pontificate is officially dated. To exercise the *actus ordinis* of a priest or bishop, however, he must, if not already in orders, be specially ordained and consecrated. Hence his office is a dignity, not of order, but of jurisdiction (see PAPACY and POPE).

The most distinctive characteristic of the Roman Catholic Church, at least as contrasted with the various Protestant communions, is its vigorous insistence on the principle of ecclesiastical authority. Of this authority the pope is regarded as the centre and source, so far as the interpretation of the Divine Will to the world is concerned in matters of faith and morals. His pronouncements are held to be infallible when

he defines a doctrine concerning faith or morals *ex cathedra* to be held by the universal church (see INFALLIBILITY and VATICAN COUNCIL).

The government of the Roman Catholic Church being centred at Rome, an elaborate organization has been developed there for the administration of its affairs. At the head of this is the college of cardinals, who are the princes and senators of the Church, the counsellors of the pope, and his vicars in the functions of the pontificate. By those of them who are members of the various Congregations and other offices of the Curia the greater part of the government of the Church is directed. (For accounts of the organization of the Roman Curia the reader is referred to the articles CARDINAL and CURIA ROMANA.) The characteristic note of the Roman Curia is its intense conservatism and its slowness to move, whether in approving or condemning new developments of opinion or action. This is explained by the nature of its organization and by the tradition on which it is based. For, just as the Roman Church as a whole preserves in the spiritual sphere the spirit and much of the organization of the Roman Empire, so the administration of the Curia carries on the tradition of Roman government, with its reverence for precedent and its practice of deciding questions, not on their supposed abstract merits, but in accordance with the rules of law as defined in the codes or by previous decisions. Thus the genius of Rome remains, as it always has been, administrative rather than speculative. The great dogmas of the Christian Church were shaped by the interplay of the subtle wits of the theologians of the Oriental Churches. The new dogmas promulgated by the Holy See from time to time have been the outcome of the slow growth of ages, built up from precedent to precedent, and only defined at last when the accumulated weight of evidence in their favour, or the necessity for precise definition to meet the contradictions of heretics, seemed to demand a decision. This temper and the process in which it finds expression are well illustrated in the case of the dogma of the Immaculate Conception (*q.v.*) and in the authorization given to the cult of the Sacred Heart (*q.v.*).

This conservative spirit and extreme reverence for authority pervades the whole Roman Catholic Church in exact proportion to the degree of effective control which the see of Rome has succeeded in obtaining over its branches in various countries. To pretend to an independent judgment in questions of faith or morals is for a Roman Catholic to commit treason against his Church; and even in the wide sphere of questions lying beyond the dogmas defined as *de fide* a too curious discussion is discouraged, if not condemned. As opposed to the critical and analytical tendencies of the modern world, then, the Roman Catholic Church assumes the function of the champion of moral and intellectual discipline, an attitude defined, in its extremest expression, by Pius IX.'s *Syllabus* of 1864 (see SYLLABUS), and the famous encyclical *Pascendi* of Pius X. in 1907. The development of this attitude, known—in so far as it depends on the full pretensions of the Papacy—as Ultramontanism, since the definition of the Roman Catholic Church by the council of Trent in 1564, will be found sketched in the historical section attached to this article. The earlier history, which is that of the Latin Church of the West, will be found in the articles PAPACY, CHURCH HISTORY and REFORMATION.

Under the supreme authority of the pope the Roman Catholic Church is governed and served by an elaborate hierarchy. This, so far as its *potestates ordinis* are concerned, is divided into seven orders: the three "major orders" of bishops and priests, deacons, and subdeacons (bishops and priests forming two degrees of the *ordo sacerdotium*), and the four "minor orders" of acolytes, exorcists, readers, and door-keepers. These various orders do not derive their *potestas ordinis* from the pope, but from God, in virtue of their direct ministerial succession from the apostles.¹ So far as jurisdiction is concerned, however, those

¹ Thus sacraments administered by validly ordained or consecrated priests and bishops are regarded as valid, even when those who administer them are heretics or schismatics.

members of the hierarchy known as prelates (*praelati*), who possess this power (*potestas jurisdictionis in foro externo*), whether bishops or priests, derive it from the pope.

These jurisdictions are of very varied character, and in most cases are not peculiar to the Roman Catholic Church. They include those of patriarchs, archbishops, metropolitans and bishops in the first rank of the hierarchy, with their subordinate officials, such as archdeacons, archpriests, deans and canons, &c., in the lower ranks. All of these will be found described under their proper headings (see also ECCLESIASTICAL JURISDICTION). The basis of the organization of the Church is territorial, the world being mapped out into dioceses or, in countries where the Roman Church is not well developed—e.g. missions in non-Christian lands—into Apostolic Vicariates. The dioceses are grouped in various ways; some are immediately dependent upon the Holy See; some are grouped in ecclesiastical provinces or metropolitanates, which in their turn are sometimes grouped together to form a patriarchate.

According to the official *Parochia Cattolica*, published at Rome, there were in 1909 ten patriarchates, with fourteen patriarchal sees (including those of the Oriental rite, i.e. those Eastern communities which, though in communion with Rome, have been allowed to retain their peculiar ritual discipline). Of these the four greater patriarchates are those of Alexandria (with two patriarchs, Latin and Coptic); Antioch (with four, Latin, Graeco-Melchite, Maronite and Syriac); Constantinople (Latin) and Jerusalem (Latin). The lesser patriarchates are those of Babylon (Chaldaic), Cilicia (Armenian), the East Indies (Latin), Lisbon (Latin), Venice (Latin) and the West Indies (Latin). (See PATRIARCH.)

The archiepiscopal sees number 204. Of these 21 are immediately subject to the Holy See, while those of the Latin rite having ecclesiastical provinces number 164. There are 19 of the Oriental rite: 3 with ecclesiastical provinces, viz. Armenian, Graeco-Rumanian and Graeco-Ruthenian respectively; the rest are subject to the patriarchates, viz. 2 Armenian, 3 Graeco-Melchite, 3 Syriac, 2 Syro-Chaldaic, 6 Syro-Maronite.

Of episcopal sees of the Latin rite 6 are suburbicane sees of the cardinal bishops, 85 are immediately subject to the Holy See, and 662 are suffragan sees in ecclesiastical provinces. Of those of the Oriental rite one (Graeco-Ruthenian) is immediately subject to the Holy See; 9 are suffragan sees in ecclesiastical provinces, viz. 3 Graeco-Rumanian and 6 Graeco-Ruthenian; the rest are subject to the patriarchates, viz. 15 Armenian, 2 Coptic, 9 Graeco-Melchite, 5 Syriac, 9 Syro-Chaldaic, 2 Syro-Melchite.

The whole number of these residential sees, including the patriarchates, is 1023. Besides these there are 610 titular sees, formerly called sees in *partibus infidelium*, the archbishops and bishops of which are not bound to residence. These titles are generally assigned to bishops appointed to Apostolic Delegations, Vicariates and Prefectures, or to the office of coadjutor, auxiliary or administrator of a diocese. (See ARCHBISHOP and BISHOP.)

The dioceses are divided into parishes, variously grouped, the most usual organization being that of deaneries. In the parish the authority of the Church is brought into intimate touch with the daily life of the people. The main duties of the parish priest are to offer the sacrifice of the mass (*q.m.*), to hear confessions, to preach, to baptize and to administer extreme unction to the dying. It is true to say that in the "cure of souls" the confessional plays a larger part in the Church than the pulpit (see CONFESION and ABSOLUTION). For the official costume of the various orders of clergy see the article VESTMENTS.

The clergy of the Roman Catholic Church are furthermore divided into regular and secular. The regular clergy are those attached to religious orders and to certain congregations (see MONASTICISM). Of these the former are outside the normal organization of the Church, being exempt from the ordinary jurisdiction of the diocesan bishops, while the more recently formed congregations are either wholly or largely subject to episcopal authority. By far the most powerful of the religious orders are the Jesuits (*q.v.*). The secular clergy, on the other hand, are bound by no vows beyond those proper to their orders. Both regular and secular clergy (those at least in major orders) are under the obligation of celibacy, which, by cutting them off from the most intimate common interests of the people, has proved a most powerful disciplinary force in the hands of the popes (see CELIBACY). The more complete isolation of the regular clergy, however, together with their direct relation to the Holy See, has made them, not only the

more effective instruments of papal authority, but, more obnoxious to the peoples and governments of countries where they have gained any considerable power. Their privileged position, moreover, leads everywhere to a certain amount of friction between them and the secular clergy.

In doctrine the Roman Catholic Church is divided from the orthodox communions of the East mainly by the claims of the papacy, which the Orientals reject, and the question of the "Procession of the Holy Ghost" (see CHURCH HISTORY). From the Protestant communities which were the outcome of the Reformation the divergence is more profound, though the central dogmas of the faith are common to Roman Catholics and orthodox Protestants. The difference lies essentially in the belief held as to the means by which the truths defined in these dogmas are to be made effective for the salvation of the world. It was defined in the canons of the council of Trent, as promulgated by Pope Pius IV. in 1564, in which the main theses of the Reformers as to the character of the Church, the sufficiency of Holy Scriptures, the nature of the sacraments, and the like were finally condemned (see TRENT, COUNCIL OF).

The Roman Catholic Church is by far the most widespread, numerous and powerful of all the Christian communions. It is the dominant Church in the majority of European states, in South and Central America and in Mexico; it is the largest single religious body in the United States of America, while in certain Protestant countries, e.g. Prussia and the United Kingdom, it has great religious and political influence. Any statistics of its membership, however, must necessarily be misleading. Those published are generally based on the principle of deducting the Protestant from the general population of "Catholic" countries and ascribing the rest to the Roman Church. This may be possible in Germany and other countries where there is a religious census; but it is, at best, a rough-and-ready method where, as in Italy or France, besides the class of "political" or "non-practising" Catholics, large numbers of the people are more or less actively hostile to Christianity itself. (For Roman Catholic missionary work see MISSIONS.)

The Uniat or United Oriental Churches.—The overwhelming majority of the adherents of the Roman Catholic Church throughout the world belong to the Latin rite, i.e. follow the usages and traditions of the Western Church.¹ Ever since the schism of East and West, however, it has been an ambition of the papacy to submit the Oriental Churches to its jurisdiction, and successive popes have from time to time succeeded in detaching portions of those Churches and bringing them into the obedience of the Holy See. This has only been possible owing to the temper of the Oriental mind which, while clinging tenaciously to its rites, values dogma only in so far as it is expressed in rites. The popes, then, or at least the more politic of them, have been content to lay down as the condition of reunion no more than the acceptance of the distinctive dogmas of the Roman Catholic Church, especially the supremacy and infallibility of the pope; the *ritus* of the Uniat Oriental Churches—liturgies and liturgical languages, ecclesiastical law and discipline, marriage of priests, beards and costume, the monastic system of St Basil—they have been content for the most part to leave untouched. The attempts of Pius IX., who in 1862 established the *Congregatio de propaganda fide pro negotiis ritus orientalis*, to interfere in a Romanizing sense with the rites of the Armenians and Chaldaeans (by the bulls *Reversurus* of 1867 and *Cum Ecclesiastica* of 1869) led to a schism; and Leo XIII., who more than all his predecessors interested himself in the question of reunion, reverted to and developed the wiser

¹The Latin word *ritus* covers not only the ordinary meaning of the modern English word "rite," i.e. "a formal procedure or act in a religious or other solemn function," or any "custom or practice of a formal kind," but the sense in which it is now obsolete in England—except in the religious connotation here used—of "the general or usual custom, habit or practice of a country, people, class of persons, &c." (*New English Dict. s.v.*) For the liturgies of the Latin and Oriental Churches see LITURGY.

principle of not aiming at any assimilation of rites, but only at "the full and perfect union of faith" (Encyclical *Præclara gratulatiois* of June 1804). This principle has even been carried to the extent of recognizing several bishops having jurisdiction over the adherents of various rites in the same see; thus there are three uniat patriarchs of Antioch (Græco-Melchite, Maronite and Syrian).

Exact statistics of the membership of the Churches of the Oriental rite are almost impossible to obtain; the numbers of their adherents, moreover, are apt to vary suddenly with the shifting currents of political forces in the East, for political factors have always played a considerable part in these movements towards reunion or the reverse. In 1908 their numbers were estimated at approximately 5,500,000. The Churches of the Oriental rite fall under four main divisions: Greek, Armenian, Syrian, Coptic; and—with the exception of the Armenian—these are again subdivided according to nationality or to peculiarities of cult or language. The Churches may be further grouped according to the character of their constitution, i.e. (1) those having their own rite only in a restricted sense, since they have no hierarchy of their own but are subordinate to Latin bishops, i.e. the Greeks in Italy (*Italo-græci*), the scattered Bulgarian Uniat, the Abyssinians, some of the Armenians and the "Christians of St Thomas"; (2) those having their own bishops and sometimes their own metropolitans, as in Austria-Hungary; (3) the Eastern patriarchates.

Geographically, the Uniat Churches may be grouped as follows:—

(A) EUROPE, where their association with the Roman Church is at once the oldest and the most intimate.

(1) The *Italo-græci*. These are distributed in scattered groups throughout Italy, but are most compact in Apulia and Sicily, and number in all some 50,000. They are under the jurisdiction of the Latin diocesan bishops, but their priests are ordained by bishops of their own rite specially appointed by the pope.

(2) The Uniat Churches of Austria-Hungary. With the exception of the Armenians, these are all of the Greek rite, but are divided according to nationality and ritual language into the following groups:—(a) *Ruthenian Church*.—This, though still the most important numerically of all the Uniat Churches, is but a fragment of the Church which proclaimed its union with Rome at the synod of Brest in Lithuania in 1596, a union which, after long and bitter resistance, was completed by the submission of the dioceses of Lemberg and Lutzk in 1700 and 1702. The Church was broken up by the successive partitions of Poland, and those parts of it which fell to Russia were, notably under Catherine II. and Nicholas I., forcibly absorbed into the Orthodox Church. The Church, however, still numbers some 3,000,000 adherents in Galicia, and 500,000 in Hungary. In Galicia it has an independent organization under the Greek-Catholic archbishop of Lemberg, with two suffragan sees: Przemysl, for West Galicia, and Stanislawow for East Galicia. In Hungary there are two bishoprics, Munkacs and Eperies, under the Latin primate of Hungary, the archbishop of Gran. The Serb bishopric of Kreutz in Croatia, under the Latin archbishop of Agram, may be also grouped with the Ruthenian Church, since their Latin is identical, its adherents number about 15,000 to 20,000. The liturgical language of the Uniat Slav Churches is Old Slavonic, and, so far as their rite is concerned, they differ from the Orthodox Slav Churches only in using the Glagolitic instead of the Cyrillic alphabet. (b) *Rumonian Church*.—This numbers about 1,000,000 adherents and has its own organization under the metropolitan of Fogarasch or Alba Julia, with three suffragan sees: Lugos, Gross-Wardein and Szamos-Uvjár. It has had its own ritual language since the 17th century. (c) *Armenian Church*.—This numbers in Austria-Hungary only some 4000 to 5000 members. It has an archbishopric at Lemberg, which has jurisdiction also over the Uniat Armenians at Verone.

(3) Uniat Churches in Russia and Turkey in Europe. (a) In Russia the Uniat Ruthenian Church (see above) ceased to exist with the incorporation of the little Polish diocese of Chelm in the Orthodox Russian Church under Alexander II. in 1875. The Holy See, however, has never withdrawn its claim to jurisdiction over it, nor have the Ruthenians ever been wholly reconciled to their absorption in the Russian Church. The *ukaz* of Nicholas II. (Easter, 1905), granting liberty of worship, produced a movement in the direction of Rome; but this appears to have been checked by the refusal of the government, even now, to recognize in Russia a Roman Catholic Church of the Greek rite. Converts to Rome have, therefore, to accept the Latin rite (see Prince Max of Saxeony, *Vorlesungen über die orientalischen Kirchenfragen*, 1907). The scattered communities of the Uniat Armenian Church in Russia are subordinate to Latin vicars apostolic. The Uniat Armenian Church in the Caucasus, however, is under the jurisdiction of the patri-

archate of Cilicia. (b) In European Turkey the Uniat Churches are represented by tiny groups, scattered about the Balkan Peninsula, attached to Latin "missions." The movement in favour of the union of the Bulgarian Church with Rome, which grew up in 1860, was the outcome of the national opposition to the Greeks, and with the establishment of the Bulgarian exarchate in 1872 it died away. There are not more than 10,000 to 15,000 Uniat Bulgarians, who have been ruled since 1883 by three vicars apostolic belonging to the Eastern patriarchates.

(B) ASIA AND AFRICA.—The Uniat Churches in Asia and Africa occupy a peculiar position in so far as Rome has recognized the traditional rights of the patriarchates (see, e.g., Leo XIII's encyclical *Præclara gratulatiois* of June 1804), and they therefore enjoy almost complete autonomy; thus the patriarchs nominate their own suffragans and have the right to summon synods for specific purposes (see PATRIARCHS).

There are six Uniat Patriarchates:—

(1) The *Patriarchatus Ciliciæ Armenorum*. The Armenian patriarch, whose jurisdiction embraces the Catholic Armenians in the Balkan Peninsula, in Russian Armenia and in Asiatic Turkey, formerly resided in Lebanon, but has had his seat since 1867 at Constantinople. Under him are 10 dioceses, including a small one in Persia. The number of Catholic Armenians under his jurisdiction is, roughly, 100,000 (see ARMENIAN CHURCH).

(2) The three patriarchates of Antioch. (a) The Melchite (*Patriarchatus Antiochenus Græco-Melchitarum*). The patriarch resides in the monastery of Ain-Traz in the Lebanon and has jurisdiction over all the Uniat of Greek nationality in the Turkish Empire, who number about 120,000. Under him are 3 archbishoprics and 9 bishoprics (see MELCHITES). (b) The Maronites (*Patriarchatus Antiochenus Syro-Maronitarum*), whose seat is in the Lebanon. The patriarch has jurisdiction over about 500,000 people (see MARONITES). (c) The Syrian (*Patriarchatus Antiochenus Syrorum*). The patriarch, who resides at Mardin near Diarbek on the upper Tigris, is obeyed by 15,000 to 20,000 people, who represent a secession from the Jacobite Church (see JACOBITE CHURCH). He has 3 archbishoprics and 5 bishoprics under his jurisdiction.

(3) The Chaldaean (*Patriarchatus Chaldaeorum Babyloensis*). The patriarch has jurisdiction over the Uniat Nestorian Church, which numbers, roughly, about 50,000 adherents, and is divided, under the patriarch, into 11 dioceses (see NESTORIANS).

(4) The Coptic (*Patriarchatus Alexandrinus Coptorum*). This was founded on the 19th of November, 1895 by Pope Leo XIII. The patriarch, who was given two suffragan bishoprics, has his seat at Cairo. The number of Uniat Copts is nominal.

(5) The Uniat Abyssinian Church. This has scarcely any adherents. Such as there are are under the authority of a vicar apostolic residing at Keren.

(6) The Christians of St Thomas (Malabar coast). For these Leo XIII. established in 1887 three special vicariates apostolic (*Vicariatus apostolicus Syro-Malabarorum*); the vicars apostolic are Latins, but have the right to pontificate and to confirm according to the Syrian rite. The number of Christians of St Thomas in the obedience of Rome is said to be about 100,000.¹ (W. A. P.)

The Church in Europe since the Reformation.

The term "Romish Catholic" is as old as the days of Queen Elizabeth.² It is not happily chosen, for catholic means universal, and what is universal cannot be peculiar to Rome. But the term is inoffensive to Roman Catholics, since it advertises their claim that communion with the see of Rome is of the essence of Catholicity, and to Protestants, since it serves to emphasize the fact that the religion of modern Rome differs widely in many important respects from that of the undivided medieval Church. The change has brought both good and evil. Protestant controversialists have some show of reason on their side when they argue that Luther saved the Roman Church by forcing it to put an end to many intolerable abuses. On the other hand, under stress of his revolt the papacy could not but develop in a strongly anti-Protestant direction, laying exaggerated emphasis on every point he challenged. The more fiercely he denounced infallibility, the confessional, the sacramental system, the larger these things bulked in the eyes of Rome.

Not that this consequence showed itself at once. The Reformation was well established before it attracted any serious

¹ This account of the Uniat Churches is largely condensed from the excellent article "Uniate Orientales," by F. Kattenbusch in Herzog-Hauck *Realencyclopædie* (3rd ed., Leipzig, 1908), where numerous authorities are given.

² It was officially adopted in the Relief Act of 1791 in place of the designation "Protesting Catholic Dissenters," to which the vicars apostolic objected.

notice at Rome. The popes of the Renaissance were profoundly uninterested in theology; they were far more at home in an art gallery, or in fighting to recover their influence as temporal Italian princes, gravely shattered during the long residence of the papal court at Avignon in the 14th century. But these secular interests came to an end with the so-called sack of Rome in 1527, when Charles V. turned his arms against Clement VII., and made the pope a prisoner in his own capital. Thenceforward there was no more thought of territorial aggrandisement. The popes, as the phrase went, became Spanish chaplains, with a fixed territory guaranteed to them by Spanish arms; apart from the addition of Ferrara and one or two other petty principalities on the extinction of the reigning house, its boundaries remained unchanged till Napoleonic times. Under Clement's successor, Paul III., a new state of things began to dawn. Hitherto the way had been blocked by a horde of protonotaries, dataries and other officials—purveyors of indulgences, dispensations and such-like spiritual favours—to whom reform spell ruin. Even the Reformation did not move them; if less money came in from Germany, that was all the more reason for leaving things unchanged in France and Spain. But among Paul's cardinals were three remarkable men, the Italians Contarini and Sadolet, and the Englishman Reginald Pole, afterwards archbishop of Canterbury under Mary. All three were disciples of Erasmus, the great apostle of a new, tolerant, scholarly religion very different from the grimy pedantry of the medieval doctors. It was better, he said, to be weak in Duns Scotus, but strong in St Paul—than to be crammed with all the learning of Durandus, and ignorant of the law of Christ. Men trained in this school were not likely to be tender towards vested interests in darkness, least of all when they stood in the way of a reconciliation with the Protestants: for the cardinals thought that the strength of the Reformation lay much less in the attractiveness of Luther's doctrines than in his vigorous denunciations of the vices of the clergy. Once root out abuses with a firm hand, and they believed that a few timely concessions on points of doctrine would tempt most Protestants back within the Roman pale. This belief was shared by the

The Council of Trent. Charles V. Together they persuaded the unwilling pope to call a general council. It met in December 1545, at the Tirolese city of Trent, with Pole as one of the three presidents (see TRENT, COUNCIL OF).

As a means of reconciliation the council was a signal failure. The Protestants refused to attend an assembly where even the most conciliatory prelate could hardly condescend to meet them on equal terms. Nor was Pole allowed to use the only possible means of overcoming their reluctance. He had wished to begin by reforming abuses before proceeding to sit in judgment on doctrinal errors. But this arrangement was cried down as a revolutionary departure from all established precedent; and he had much ado to secure the compromise that doctrines and practical reforms should be simultaneously discussed. But in the midst of its labours the council was prorogued (March 1547) in consequence of a quarrel between the pope and emperor. In 1551 it met again, only to be again prorogued in 1552. Ten years later it met again for a third and final session, lasting throughout 1562 and 1563. During those ten years great changes had taken place. Charles V. had followed Pole and his peace-loving colleagues to the grave; in his place stood his son, Philip II. of Spain, while the intellectual leadership of the council fell to Jaime Laynez, general of the newly founded Society of Jesus. There was no longer any question of reconciliation with the Protestants. North Germany, England, Scandinavia were irrevocably lost to Rome; wars of religion had broken out in France. Clearly the one hope was to enter into a desperate struggle for the possession of such countries as still hung in the balance; and that could best be done by striking at the heart of the Reformation. Protestantism centred—or was by Catholics supposed to centre—in a mysterious "right of private judgment"; the council accordingly retorted by hymning the praises of obedience, of submitting to authority and never thinking for

oneself. To waverers it held up an absolutely sure and uniform Rule of Faith, contrasting impressively with the already multitudinous variations of the Protestant Churches. Moreover, thanks to Laynez, it accomplished this task without running the obvious danger of tying itself hand and foot to the past. When old-fashioned theologians talked about the canons and councils of antiquity, Laynez answered that the Church was not more infallible at one time than another; the Holy Ghost spoke through the decrees of Trent quite as plainly and directly as through the primitive Fathers. Thus the council's authority became at once peremptory and elastic. But the real gainer was the pope. Hitherto infallibility had been thought of as the supreme weapon of the Church's armoury, destined only for use at some extraordinary crisis; hence it was naturally conceived of as residing only in the extraordinary authority of a general council presided over by the pope. Since the outbreak of the Reformation, however, extraordinary crises, calling for immediate decision, might arise at any moment. It was no longer possible to wait for the assembling of a general council; stronger and stronger grew the tendency to ascribe infallibility to the pope alone, as being always on the spot.

Doctrine and discipline once settled at Trent, the work of counter-reformation could begin. Rebels were won back by force wherever force could be applied. In Spain **The Counter-Reformation.** the Inquisition soon snuffed out the few Reformers. In Italy, though declared Protestants were few, there was widespread sympathy with some of Luther's ideas; a committee of cardinals at Rome was accordingly organized into an Inquisition, with branches at the chief Italian towns. For half a century trials were many at Venice and elsewhere, but actual executions were only common at Rome; the most illustrious victim was the philosopher Giordano Bruno, burnt in 1600. In the imperial dominions, however, there could be no recourse to the stake. The peace of Augsburg (1555) forbade the German princes to persecute, though it recognized their right to determine to what religion their subjects should belong, and to banish nonconformists. At first this compromise had worked in favour of the Reformation, but presently the Catholic princes began to turn it against their Protestant subjects. "Governments learned to oppress them wisely, depriving them of church and school, of pastor and schoolmaster; and by those nameless arts with which the rich used to coerce the poor in the good old days. Fervent preachers came amongst them, widely differing in morality, education, earnestness and eloquence from the parish clergy, whose deficiencies gave such succour to Luther. Most of those who, having no taste for controversy, were repelled by scandals were easily reconciled. Others, who were conscious of disagreement with the theology of the last thousand years, had now to meet disputants of a more serious type than the adversaries of Luther, and to meet them unsupported by experts of their own. Therefore it was by honest conviction, as well as by calculated but not illegal coercion, that the Reformation was driven back" (Acton, *Lectures on Modern History*, p. 123).

This system was not an unmixed success; for its extension to Bohemia early in the 17th century brought about the Thirty Years' War. But it obliged the authorities to pay anew attention to the training of the clergy. The "seminary system" came into being—that is, the custom of obliging candidates for ordination to spend several years in a theological college, whence lay influences were carefully excluded. But ecclesiastical learning of a wider type was also promoted. Gregory XIII. (1572-85) and Sixtus V. (1585-90) dreamed of making Rome once more the capital of European culture. Gregory reformed the Calendar, and founded the university that bears his name. Five years of power were enough for Sixtus to reform the central government of the Church and the administration of the Papal States, to set on foot the Vatican press and issue an official edition of the Vulgate. Their efforts bore fruit in many quarters. In Rome arose Cardinal Baronius, first of

modern Church historians; Spain produced Suarez, most philosophical of divines. A generation later the French Oratory became the home of Malebranche and of Richard Simon, father of Biblical criticism. Mabillon and his Benedictines of Saint-Maur paved the way for the systematic investigation of historical records. The Flemish Jesuit Bolland brought the light of criticism to bear on the legends of the saints (see BOLLANDISTS). His French colleague, Petau, better known under his latinized surname of Petavius, opened still wider floodgates when he taught that theological dogmas, like everything else, have a history. Lastly, the Jansenist "hermitage" at Port Royal contributed the historian Tillemont, whose biography Edward Gibbon declares to be overbalanced by his erudition, veracity and scrupulous minuteness. Other such communities and "congregations"—semi-monastic bodies standing in closer touch with the world than did the medieval orders—undertook the diffusion of knowledge. Wherever they went the Jesuits opened grammar-schools, which had the double advantage of being excellent and cheap. An Italian sisterhood, the Ursulines, was founded for the higher instruction of girls; late in the 17th century a French priest started the Christian Brothers, pioneers of elementary education. Other communities again devoted themselves to parochial work. Such were the Oratorians of St Philip Neri, founded to evangelize the middle classes of Rome. Such, again, were the Lazarists of St Vincent de Paul, whose duty was to preach in neglected country districts. But the most interesting of all these new foundations was the Sisters of Charity, also founded by St Vincent de Paul. This admirable body represents a significant departure from medieval ideals. The old-fashioned nun had spent her time behind high walls in prayerful contemplation; the one object of the Sister of Charity was the service of her neighbour.

Not that medieval ideals were by any means dead; they never burned more brightly than in the Spain of St Teresa (1515-82). Her first idea had been to combat alike the heresies and the worldliness of her time by a return to the austerities of a more heroic age. With this object she founded her order of "Discalced" or barefooted Carmelites; it presently became the refuge of Louise de la Vallière and many another penitent of rank. But mere bodily rigours were not enough for Teresa; she felt the need of rising to a state of complete detachment from all earthly interests and ties. Her whole theology centres in the lines—

"The love of God flows just as much
As that of ebbing self subsides;
Our hearts, their scantiness is such,
Bear not the conflict of these rival tides."

How, then, subdue the rivalry? Teresa turned to the mystical writers, and learnt from them how to root out the last relics of self-love from the mind by a long discipline of mystical trance and "contemplation." These ideas, in a very modified form, were introduced into France by the great devotional writer, St Francis of Sales; in the latter half of the 17th century they were pushed to the extravagant length known as Quietism by Fénelon, and especially by Madame Guyon and Michel de Molinos. Meanwhile, the leading conception from which St Teresa started had developed along characteristically different lines in the mind of her compatriot and contemporary, Ignatius Loyola. He quite agreed that self-will was the enemy; but was there no quicker way of checkmating it than an interminable course of ecstasies and austerities?

**The
Jesuits.**

The thoughts of the converted soldier flew back to the military virtue of obedience. In the long-run no self-imposed hardships could prove quite as disagreeable as always being under the orders of some one else. Obedience accordingly became the typical virtue of Ignatius's society (see JESUITS). The individual Jesuit obeyed his superior, who obeyed the rector, who obeyed the provincial, who obeyed the general, who obeyed the pope, who took his orders straight from God Almighty. Such a theory was of untold practical value to the Church of Rome, more especially during the era of the Reforma-

tion. Laynez at the council of Trent has given one signal instance of its working, but its operations were by no means confined to the abstract field of dogma. If men were really to be made obedient, it could only be by stopping them from thinking for themselves about the everyday problems of conduct; and the best way to do this was to furnish them beforehand with a ready-made code of answers to such problems, warranted to meet all needs. Hence casuistry and the confessional loomed large on the Jesuit horizon. The casuist's duty was to apply the general precepts of the Church to particular cases. He explained, for instance, when a man was strictly bound to tell the truth; when he might avail himself of the mild licence of an equivocation; and when the Church placed at his service the greater indulgence of a mental reservation. The confessor brought the casuist's principles to bear on the conscience of his penitents, and thus saved them from the danger of acting on their own responsibility (see CASUISTRY).

In its origin this system was a perfectly honest attempt to widen the sphere of obedience by making morality wholly objective and independent of the vagaries of the individual conscience. But what was begun in the interest of obedience was carried on in those of laxity. Experts proverbially differ, and the casuists were no exceptions to the rule. But when great authorities were at variance, it ill became an average priest or penitent to decide. Whatever a grave doctor said must have some solid reasons behind it—*aliqua nisi probabilitate*—and humble lay-folk could act upon it without a twinge of conscience. Thus arose lax casuists of the type of Antonio Escobar (1589-1669), the central figure of Pascal's *Provincial Letters*. Their whole business was to hunt through the older authorities in search of "benign" decisions. Their temptation is easy to understand. Half Europe was full of waverers between Protestantism and Catholicism tolerably certain to decide for the Church that offered them the cheapest terms of salvation; and even in wholly Catholic countries many, especially of the upper class, might easily be scared away from the confessional by severity. Thereby their money and influence would be lost to the Church, and their souls robbed of the priceless benefit of priestly absolution. On the other hand, these "Escobarine morals" by no means passed unchallenged; ever since the foundation of the society the aims and methods of the Jesuits had called forth lively opposition in many parts of Catholic Europe, and not least in Loyola's native land of Spain. But the most effective protest against them was a movement which began when Michel de Bay, a professor at the Flemish university of Louvain, put forward certain theories on grace and free-will in the latter part of the 16th century. In 1640 a much more elaborate statement of the same ideas appeared in a posthumous treatise on the theology of St Augustine from the pen of Cornelius Jansen, also a Louvain professor (see JANSENISM). Into the technical detail of the controversy there is no need to enter. It is enough to say that two rival doctrines of grace and free-will were struggling for mastery in the Roman Church. One theory emphasized the necessity of grace; having been put together by St Thomas Aquinas, it was known as Thomism, and was especially championed by the Dominicans. The other laid the chief stress on free-will; it was known as Molinism from its inventor, the Jesuit Louis de Molina, and was in great favour with the society. The two orders came into violent collision at Rome between 1588 and 1606. But the quarrel, known as the controversy *de auxilii gratiae*, was brought to an end by Pope Paul V., who closed the debates and adjourned his decision *sine die*.

At first sight this abstract question seemed endlessly remote from the practical policy of Escobar; really there is a close connexion between the two. The whole system of the Jesuits rested on a basis of free-will. Their quarry was the average man; and the best way of impressing the average man is to set before him duties that he feels himself fully capable of performing. Then he will really feel morally responsible if he leaves them undone, hence the necessity of free-will. On

the other hand, as Jansen pointed out, free-will tends to make the average man's estimate of his own powers into the supreme criterion of all that is good and right. God must therefore be satisfied with whatever common sense thinks it fair and reasonable that He should expect. Jansen accordingly denounced free-will as dishonouring to God, and destructive of the higher interests of morality. But, if men threw over common sense, what was to be their guide in life? Jansen answered with his doctrine of Irresistible Grace. This was simply a cumbersome way of saying that God awakens in the righteous heart an intuitive faculty of discerning right from wrong. "This holy taste or relish," says a follower of Jansen, "distinguishes between good and evil without being at the trouble of a train of reasoning; just as the nature and tendency of a heavy body, let fall from a height, shows the way to the centre of the earth more exactly in a moment than the ablest mathematician could determine by his most accurate observations in a whole day." That being so, the Jansenist obeyed his Inner Light, and paid little heed to the earth-bound standards of unregenerate common sense. Nor was he much more respectful towards the official standards of the Church. Why should he consult a casuist rather than his Inner Light? Thus the Jesuits saw themselves menaced by a grave revolt. What would become of the confessional if penitents were allowed to act on what they fondly took to be a heaven-sent inspiration? In a twinkling they would be off to some spiritual Wonderland, where no confessor could bring them to book. On the other hand, only preach to them a strong doctrine of free-will, and all these dangers vanished. They would feel bound to disregard their sporadic intuitions, and act only for reasons that would be clearly set out in black and white. Their past performances could then be checked, and their future actions forecast by the priest; and there was small danger of their straying beyond the limits marked out by authority.

Thus within the spiritual sphere free-will led up to Jesuit obedience. But in the secular world this paradox failed to obtain; there free-will was only too ready to come into conflict with the Church. The 15th and 16th centuries had seen the final break-up of the medieval system of reverence for authority and tradition. In art and learning, morals and government, the old walls came crashing down; in the general bankruptcy of authority men were forced to depend on themselves. And the contemporaries of Machiavelli soon learned to take the fullest advantage of this liberty to pursue their own best interests in the way that pleased them best. But if individuals might be guided by self-interest, why should that privilege be denied to associations of men? On the ruins of a medieval Christendom, hierarchically organized under the pope, grew up the "new monarchy," or modern state, owning no law but its own will. Yet the popes laid aside none of their medieval claims, or even their traditional weapons.

In 1606 Paul V. laid Venice under an interdict, on the ground that the republic had infringed the immunities of the clergy; the doge replied by threatening with death any one who took any notice of the papal thunders. Thenceforward the thunders continued chiefly on paper. In 1625 Catholic Europe was scandalized by the *De Schismate* of the Jesuit Santarelli, in which he claimed for the pope an absolute right to interfere in the concerns of secular princes, whenever he chose to declare that the interests of religion were in any way concerned. He could dictate their policy at home and abroad, revise their statute-book, upset the decisions of their law-courts. If they refused to listen he could punish them in any manner he thought fit; in the last resort he could release their subjects from allegiance and head a crusade of Catholic powers against them. These pretensions roused a special burst of indignation in France. There, on the divisions of the wars of religion, had followed an irresistible reaction towards patriotism and national unity. France had suddenly grown to her full stature; like the contemporary England

of John Milton, she was become a "noble and puissant nation, rousing herself like a strong man after sleep." Even the clergy were swept away by the current, and meant to be patriots like every one else. "Before my ordination," said the eminent theologian Edmond Richer, "I was a subject of the king of France: why should that ceremony make me a subject of the pope?" Subjection to the pope implied an Italianization of French religion; and most Frenchmen looked on the Italians as an inferior race. Why, then, should the right to decide ecclesiastical disputes be taken away from their own highly competent fellow-countrymen, and reserved for a set of incapable judges in a foreign land? Germany and Spain might let themselves be bit and bridled if they chose, but for centuries France had prided herself that, thanks to her Gallican liberties, she stood on a different footing towards Rome.

The Liberties in question were certain ancient rights, whose origin was lost in the mists of time. One forbade papal bulls to be published in France without the consent of the crown. Another exempted French subjects from the jurisdiction of the Inquisition and other Roman tribunals—such as the Index of Prohibited Books. In the 17th century such immunities were all the more valuable since French statesmen found themselves in an awkward position. The great aim of Henry IV. and Richelieu was to exalt France at the expense of Vienna and Madrid. But Madrid and Vienna were the official champions of the papacy; hence to make war on them was indirectly to make war on the pope. This was enough to trouble the consciences of many excellent men; and it became necessary to devise a compromise that should set their minds at rest, by showing them that they could be at once good citizens and good Catholics. This compromise is known as Gallicanism. In the hands of Bossuet and other eminent divines it was developed along both theological and political lines. Theological Gallicanism refused to recognize papal decisions on questions of doctrine, until they had been ratified by the bishops of France. Political Gallicanism maintained that lawful sovereigns held their power directly of God, and not mediately through the pope. Hence no amount of misgovernment, or neglect of Catholic interests, could justify Rome in interfering with them. In other words, Bossuet only answered Santarelli by setting up the divine right of kings. However, this dogma by no means scandalized the subjects of Louis XIV., for the worship of the sovereign was one of their most cherished instincts. And Louis's ecclesiastical policy flattered their national pride. He introduced no theological novelties; all he did was to insist that, in matters of administration, he would be master in his own house. He supported pope and bishops so long as they took their marching orders from him. If they refused he was perfectly ready to make war on the one and send the others to the Bastille. It is eminently characteristic of his methods that, just at the same time as he was turning loose dragoons on his Protestant subjects after the revocation of the edict of Nantes (1685), he was employing other dragoons to invade the papal territory at Avignon, to punish Innocent XI. for having refused institution to some of his nominees to bishoprics.

The revocation of the edict of Nantes owes quite as much to the dream of political absolutism, inherited from Richelieu, as to religious bigotry. In the words of Saint-Simon, the Huguenots were "a sect that had become a state within the state, dependent on the king no more than it chose, and ready on the slightest pretext to embroil the whole country by an appeal to arms." So long as they were powerful, the crown had treated with them; but when once their power began to dwindle, it was certain that the crown would crush them. But during Louis's latter years, when the War of the Spanish Succession had brought a rain of disasters thickly upon him, bigotry got the upper hand. The broken old man became feverishly anxious to propitiate offended Heaven, and save himself another Blenheim or Malplaquet, by exterminating the enemies of the Church. And his Jesuit confessors had no doubt

that the first and foremost of those enemies were the Jansenists. Not only did their doctrine of grace defy the favourite Jesuit principle of obedience to authority, but it bade fair to set aside the whole Catholic machinery of infallibility and sacraments. If God spoke directly to the individual conscience, what was the use of intermediaries? Led by his Jesuits, Louis wrung from the unwilling Clement XI. the Bull *Unigenitus* (1713), which was intended to deprive believers in individual inspiration of all possible foothold within the Roman Church. The bull caused a violent uproar. Fénelon, although personally an admirer, admits that public opinion credited it with "condemning St Augustine, St Paul, and even Jesus Christ"; and the few Jansenist bishops appealed and "re-appealed" against it. But the government was inexorable; in 1730 the *Unigenitus* became part and parcel of the law of the land. Still, to make a law is one thing; to get it administered is quite another. The *parlement* of Paris was a strongly Gallican body, and had many grievances to avenge on Louis XV. and his ministers. To annoy them, it put every possible difficulty in the way of an execution of the bull. Under the fostering care of the judges, a belief sprang up that to call oneself a "Jansenist," and oppose the *Unigenitus*, was to show oneself a lover of civil and religious liberty. This feeling was intensified by the conviction that every blow struck against the bull was a blow against the Jesuits, its authors. For the Society, as befitted the great exponent of authority and the keeper of the consciences of many kings, had always been on the side of political autocracy; and therefore it became increasingly unpopular, when once the tide of French intelligence began to set in the direction of revolutionary reform. Nor were the Jesuits in much better odour among other nations. Their perpetual meddling in politics, and even in speculation and finance, stank in the nostrils of every government in Europe; while their high-handedness and corporate greed in the matter of ecclesiastical privileges and patronage alienated the clergy. Their reform was more than once discussed; and death alone prevented Benedict XIV. (1740-58), the most remarkable of the 18th-century popes, from taking some very stringent measures. A year after Benedict's death the

first blow fell. Pombal, the great reforming minister in Portugal, expelled them from that country on a charge of having conspired against the life of the king. Two years later the Paris *parlement* had its chance. La Valette, superior of the Jesuit missions in Martinique, had set up as a West-India merchant on a large scale. His enterprises were unsuccessful; in 1761 he became insolvent, and the Society refused to be responsible for his debts. The French courts made the consequent bankruptcy proceedings the excuse for a general inquiry into the Society's constitution, and ended by declaring its existence illegal in France, on the ground that its members were pledged to absolute obedience to a foreigner in Rome. Louis XV. now proposed that the French Jesuits should be placed under some special organization, less obnoxious to his *parlement*. The general only made the famous reply: "Sint ut sunt, aut non sint." Thereupon Louis let the judges have their way. In 1762 the Society was suppressed in France; in 1767 it was also declared illegal by Spain, Naples and other Italian powers. Pressure was now put on Clement XIII. to dissolve the Society altogether. He refused; but his successor, Clement XIV., was more pliable, and in 1773 the Jesuits ceased to be.

In France the *philosophes* and the quarrels over the *Unigenitus* had effectually killed the spirit of religion; nor was the Christianity of other countries at a much higher ebb. Spain was utterly dumb; Italian fervour could only boast the foundation of two small orders of popular preachers—the Passionists (1737), and the Redemptorists, instituted in 1732 by St Alfonso Liguori (*q.v.*), who also won for himself a dubious reputation on the unsavoury field of casuistry. German Catholicism was still in a very raw, unsoftened state. It is characteristic that, while Paris had its Bossuets and Bourdaloues, Vienna was listening to Abraham a Sancta Clara, the punning Capuchin

whom Schiller, regardless of dates, introduces into the opening scene of his *Wallenstein*. However, from Germany was to come a serious attempt at reform. There the vision of a reunion with the Protestants had haunted many Catholic brains ever since Bossuet and Leibniz had corresponded on the subject. Faithful to the ancient tradition of Contarini and Pole at Trent, these good men persisted in supposing that the Reformation was nothing more than a protest against practical abuses: remove the abuses, and the rest would follow of itself. And, inasmuch as they held that most abuses were due to the slippery and procrastinating greed of Roman officials, the first step should be ruthlessly to curtail the power of Rome and extend that of local Churches. Such was the theme of a book, *De statu Ecclesie, ad revivendos dissidentes in religione Christianos composuit*, published by one Justinus Febronius in 1763. The author was Johann Nikolaus von Hontheim (*q.v.*), suffragan in *partibus* to the elector-archbishop of Treves. Hontheim's theories could not but prove attractive to the local Churches, more especially when they were governed by bishops who were also temporal great lords. The three ecclesiastical electors and the prince-archbishop of Salzburg met in congress at Ems in 1786, and embodied Hontheim's proposals, though in a very modified form, in a document known as the "punctuation of Ems" (see FEBRONIANISM). Meanwhile, their overlord, the emperor Joseph II. (1780-90), was dealing with the question of a much more radical spirit, and actually abolishing abuses wholesale. The reign of "Brother Sacristan," the nickname given to Joseph by Frederick the Great, was one continual suppression of superfluous abbeys, feast-days, pilgrimages. More dignified were his attempts to broaden the minds of the clergy. Instead of being brought up in diocesan seminaries, centres of provincial narrowness, candidates for ordination were to be collected into a few large colleges set up in university towns. Still, Joseph only touched the surface; his brother, the grand-duke Leopold of Tuscany, aspired to cut deeper, and provoke a religious revival on the lines of Jansenism. His plans, which made a great stir at the time, were outlined at a synod held at Pistoia in 1786 (see PISTOIA, SYNOD OF).

Three years later, however, the world had more important things to think of than Leopold's ecclesiastical reforms. At first the French Revolution was by no means anti-Catholic—though the Constituent Assembly remembered too much of the quarrels about the *Unigenitus* not to be bitterly hostile to Rome—and its great aim was to turn the French Church into a purely national body. Hence it decreed the "civil constitution of the clergy." Bishops and rectors were made elective, with salaries paid by the state; and all priests were required to take an oath of fidelity to the government: those who refused the oath rendered themselves liable to banishment. Three years later the triumph of the Jacobins brought with it the "abolition of Christianity," and a spell of violent persecution, which gradually slackened under the Directory (1795-99). In 1799 Napoleon became First Consul, and at once set himself to deal with the ecclesiastical problem. There must clearly be a Church, and the small success of the Civil Constitution made clear that public opinion would not put up with a Church practically detached from Rome. On the other hand, Napoleon quite agreed with Louis XIV. in wishing to be master in his own house, and to turn the clergy into a supplementary police. Accordingly, in 1801 he negotiated with Pius VII. a Concordat, which remained in force till 1905 (see CONCORDAT). The state undertook to pay the bishops and parochial clergy; it was directly to appoint the one, and to have a veto on the appointment of the other. But for the religious orders no provision was made; and Napoleon refused to tolerate the presence of unsalaried clerics on whom the government had no hold. When his fall brought about the restoration of Louis XVIII. (1815), this restriction was relaxed, and the "congregations" returned in large numbers to France. But the Bourbon government had no intention of encouraging them

Suppression of the Jesuits.

Febronianism.

The French Revolution.

France and the Papacy.

too much; it clung as closely as Napoleon himself to the idea of a State Church, taking its orders from the government. In this way Gallicanism, which had once stood for all that was national and progressive, now came to mean subservience to a feeble autocracy already tottering to its fall. "A free Church in a free State" became the motto of the group of brilliant men, led by Lamennais, Montalembert and Lacordaire, who started up as soon as the July Revolution of 1830 replaced Charles X. by Louis Philippe. They felt that Catholicism was strong enough to stand alone, without artificial support. For the Revolution had not "abolished Christianity," even among the educated classes, quite so thoroughly as it imagined. Many were only kept back from going to church by the fear that their neighbours would think them superstitious or narrow-minded. But in 1802 Chateaubriand had published his epoch-making *Génie du Christianisme*, in which he declared that of all religions Christianity was "the most poetical, the most human, the most favourable to freedom, art and letters." If that were so, no one need be ashamed to profess it; and the younger generation of Frenchmen began to gravitate back to the Church. Meanwhile, Germany was being profoundly influenced by the great aesthetic revival known as the Romantic Movement, which began with the worship of medieval art and literature, and ended with the worship of medieval religion. And even Italy and Spain presently began to play their part in the Christian reaction. Rosmini in one country, and Balme in the other, "brought piety to the learned, and learning to the pious."

These writers, however, only touched the few; and the great aim of Lamennais and his friends was to reach the mass of the people. Immediately after the accession of Louis Philippe they started their famous newspaper, *L'Avenir*, hoping thereby to reconcile the Church with democracy, and make the pope the leader of the party of progress. The enterprise was hazardous, since democracy had hitherto brought nothing but ill to Rome. In 1798 French troops had entered the papal states, proclaimed a republic in Rome, and kept Pius VI. a prisoner till his death (1799). In 1808 Napoleon arrested his successor, Pius VII., threw the papal states into his new Italian kingdom, and dragged Pius about from prison to prison till the eve of his own fall in 1814. When the congress of Vienna gave the pope back his dominions, the one thought of the broken old man was to restore, as far as possible, the ancient order of things. But the traditional methods of Roman administration were deplorably ineffective; on the accession of Gregory XVI. (1831-46), the powers presented a memorandum strongly urging reform. Some reforms of detail were introduced; but Gregory declared that to grant a constitution to the States of the Church would be incompatible with the principle of the papacy. Such a man was hardly likely to listen to the plans of Lamennais. In 1832 the *Avenir* was condemned, and the disgusted Lamennais left the Roman Church. Lacordaire and Montalembert, however, continued their democratic campaign, by no means without success; for the revolution of 1848, which drove Louis Philippe from the throne, was far less hostile to Catholicism than that of 1830. Under the short-lived Second Republic (1848-52) the position of the Church grew even stronger, for the introduction of universal suffrage brought to the polls great masses of new voters strongly clerical in sympathies. In 1850 was passed the *Loi Falloux*, which broke down the Napoleonic idea of a state-monopoly of teaching, and allowed the opening of voluntary schools. Of this concession the religious orders took full advantage.

Meanwhile in Rome things had gone from bad to worse. Gregory XVI.'s refusal to grant a constitution called forth a series of sporadic outbursts, inspired by Mazzini and the "Young Italian" party, between 1832 and 1838. These were put down by French and Austrian arms, with the result of focusing the hatred of Young Italy on the pope. One last attempt was made to save him. In 1843 the Piedmontese priest Gioberti brought out a remarkable book, in which he

urged his countrymen to combine into an Italian confederation with the pope at its head. For a moment it seemed as though Gioberti's dream were about to translate itself into reality. In 1846 Gregory died, and was succeeded by Pius IX., one of the youngest of the cardinals, and well known for his popular sympathies. He at once granted an amnesty to political prisoners, of whom the Roman gaols were full; two years later (March 1848) he issued a constitution to the papal states, and seemed about to throw in his lot with the forces making for Italian independence. But the first step thereto was deliverance from the Austrian yoke; and Pius, the Italian prince, was grievously hampered by his position as head of the Church. How could a pope make war on Austria, the one power that had never faltered in its allegiance to the Church? Accordingly Pius soon drew back, and his popularity waned. In the autumn the revolutionary fever, which had swept through all Europe earlier in the year, spread to Rome. The pope's prime minister, Count Rossi, was murdered, and Pius himself, escaping to Gaeta, threw himself under Neapolitan protection. In Rome Mazzini proclaimed a republic. Once more France and Austria intervened; in 1850 Pius went back to Rome, and ruled there under the shadow of foreign bayonets. Meanwhile the Second Republic had come to an end in France; in 1852 the prince-president, Louis Napoleon, was elected emperor. At first he greatly needed the support of the clergy to secure him on his precarious throne. But, as he grew stronger, his desire for their good opinion paled before an overmastering propensity to meddle in the affairs of foreign nations. He allied himself with Victor Emmanuel, and marched into Italy in 1859, with the object of expelling the Austrians from the peninsula. This expedition led directly up to the unification of Italy. Two years later Victor Emmanuel was master of the whole country, except Venice and the "Patrimony of St Peter." This last—about one-third of the papal states—was all that was left to Pius; and even this was only held for him by French troops. When Napoleon withdrew his garrison in 1866, Garibaldi immediately raised a body of volunteers to march on Rome; and Napoleon was obliged to send back his troops. Three years later, the outbreak of the Franco-Prussian War (July 1870) led to their recall. In the following September, ten days after the final collapse of Louis Napoleon at Sedan, the troops of Victor Emmanuel entered Rome; and the temporal power of Pius came to an end.

Pius might no longer rule over the papal states; but there was consolation in the thought that, within the realm of conscience, his power had increased by leaps and bounds. The whole history of the 19th century is one vast conspiracy to exalt the importance of the papacy. At its opening both the intellectual and administrative guidance of the Church was entirely in French and Italian hands; and the first instincts of those countries is to lean on an all-sufficing government. The French Revolution had supposed itself to be fighting for the "rights of man"; really it was trying to replace an autocratic kingship by an equally autocratic "general will" of the multitude. And it failed because no general will could make its voice rise above the conflict of particular inclinations. Thankfully did men bow before Napoleon, who undertook to relieve them of the responsibility of having to make up their minds. Nor did the emperor's fall by any means entail the fall of his ideas; Count Joseph de Maistre, the great orator of ultramontanism, did little more than transplant them on to the ecclesiastical domain. Bossuet and the old-fashioned divines had believed in an elaborate system of checks and balances—popes, councils, bishops, temporal sovereigns each limiting and controlling the other—just as Montesquieu and Alexander Hamilton had believed in a careful separation of the executive from the legislative power. Napoleon swept away the checks and balances, and made the will of a single man the one and only sanction of government. In like manner de Maistre proposed to sweep away the ecclesiastical checks and balances, and vest the whole of the Church's authority in

End
of the
Temporal
Power.

"Ultra-
montan-
ism."

the pope. That would bar out for ever all risk of a conflict of clerical wills. Fortune favoured his enterprise. The French bishops of the age of Bossuet had been a powerful estate of the realm, able in some degree to make their own terms with the king himself; their successors in the 19th century were a mere group of salaried public officials. Still more significant changes took place across the Rhine. An appreciable part of the Holy Roman Empire had been in the hands of clerical rulers. At their head stood the electors of Cologne, Mainz and Treves, temporal princes of no mean rank, usually chosen from the cadets of royal houses. But in 1803 electors and prince bishops came to an end. Their domains were secularized, and divided up among their lay neighbours, Prussia securing the lion's share. Thenceforward the German bishops became mere officials, as in France, and Rome had no cause to fear the opposition of another Febronius.

Still remoter was the danger of another Louis XIV. or Joseph II. The time had gone by when sovereigns could decide what particular shade of Catholicism their subjects should assume. Everywhere there was a growing belief that a man's religious tenets were his private affair, with which the state had nothing to do; and that a government only made itself ridiculous if it attempted to lay down which creeds were true and which were false. Hence the clergy were left to do as they pleased, so long as they respected the law of the land; and most of the modern collisions between Church and State have occurred on the debatable ground where their respective spheres overlap, over questions concerning education or the marriage-laws. Noticeable among these quarrels were the so-called *Ökumenische Wirren* of 1837-40, when the archbishop of Cologne defied the Prussian government over the question of "mixed marriages," and paid for his rashness by a long imprisonment. Such conflicts did much to increase the power of the pope, by encouraging local Churches to turn to him as their protector. To ride rough-shod over individual bishops was nothing to Prussia; but to quarrel mortally with Rome was a serious matter for a sovereign reigning over millions of Catholic subjects. Even more successful were the papal incursions on to a more ethereal domain. Ever since the time of Kant and Goethe, the intellectual leadership of Europe had been slowly passing into the hands of the Germans, and Catholic theology shared the lot of other branches of learning. But the German divines were much more in touch with the world at large than were their brethren in Italy or France; and more than one interesting attempt was made to bring theology into line with modern schools of thought. Joseph von Görres read the medieval mystics in the light of the newer mysticism of Schelling. Hermes of Bonn defended Catholicism from the standpoint of Kant and Fichte. Continuing his work on a bolder scale, the Viennese priest Günther undertook to show that the articles of the Christian creed are only a rough-and-ready popular statement of the conclusions of philosophy.

Catholic developments in Germany.

Of more enduring value have been the researches of the historical school, founded by John Adam Mähler (1796-1838), whose famous *Symbolik* (1832) was perhaps the heaviest literary blow ever dealt at the Reformation. On his early death his mantle fell on to the shoulders of Ignatius Döllinger (1799-1890). This school claimed that its methods, unlike those of Hermes and Günther, avoided all danger of speculative caprice. Catholicism was considered as an organic growth, developing from certain seminal principles in accordance with certain definite laws. The business of a sound theology was to discover and apply those laws, not to patch up fleeting compromises with the intellectual fashions of an age. On the other hand, the Historical School found but little favour at Rome. "Truth," as Malebranche quaintly says, "always has a few hairs on her chin"; and the conclusions of sound learning must needs be slow, fragmentary and tentative. But Italian taste was all for bold, highly-coloured, slashing statements, that any one could understand; what it wanted was a method that should be at once intel-

lectually impressive, and free from the usual clouds that beset the scholar's path. It found what it asked for, when the Jesuits, whom Pius VII. had recalled to life (1814), revived the methods of Aquinas and the medieval Schoolmen. Under the fostering care of Pius IX., this "neo-Scholasticism" spread from Italy to the German Catholic universities, and especially the seminaries of France. The secret of its power was that it gave scope for an immense amount of intellectual subtlety, and at the same time saved men from all danger of independent thought. Although a metaphysic, it was not, and did not pretend to be, an unbiased search for truth. It admittedly started by taking the truth of Catholicism for granted; and its only object was to make intelligible to reason the dogmas that faith already accepted. Thus the whole neo-Scholastic movement played straight into the hands of authority. So comprehensive were its methods, so self-confident its bearing, that those who had once fallen under its spell would never need to doubt or hesitate again. They knew exactly what to think on every conceivable subject; and there was small danger of their suspecting that there might be things in heaven and earth undreamed of in its philosophy.

To the learned Rome might serve up authority with a garnish of neo-Scholastic metaphysics; for average mankind authority pure and simple was enough. Terrified out of their lives at the way in which science and criticism were taking one theological citadel after another, the more militant section of the clergy declared war on thought itself. Not only was faith made independent of reason, but it was considered all the purer, the less it owed to any kind of mental process. If it was a merit to believe without evidence, it was a shining virtue to believe in the teeth of evidence. *Credo, quia absurdum* was applied, notably by the popular writers of the French Second Empire, in a fashion grotesquely literal enough to scandalize Tertullian himself. "There had always existed in France, as elsewhere, those who loved traditional stories of a marvellous nature, and tended to multiply the number which were presented as facts rather than legends. The existence of this school has always been inseparable from the element of pious belief which enters so much into popular devotion. But in pre-Revolution days there had also been the critical school of the Maurists, which offered an alternative to minds averse from implicit reliance on tradition. This had passed away, and was not yet replaced. The *Acta sincera Martyrum* by Ruinart was replaced by the thoroughly uncritical and inexact *Actes des martyrs* of Guéranger. Church history was allowed to be represented by such men as the Abbé Darraas; and many French Catholics were ready to accept without question what the Bollandist Père de Smedt has not hesitated to call the historical errors and lies of Charles Bartélémy. Incredible and unsupported stories in history, and extravagances in dogma were the order of the day. Those traditions or doctrines which were most ungenial to the modern world were placed in strong relief; and the disparagement of the individual intellect was extended to the disparagement of scientific research itself" (Wilfrid Ward, *Life of W. G. Ward*, vol. ii. p. 119). The faithful were encouraged to drown all tendency to thought in an ever-increasing flood of sensuous emotionalism. In thirty years Pius IX. canonized more saints than all his predecessors together for a century and a half. In 1854 he gave a great impulse to the cultus of the Virgin by proclaiming her Immaculate Conception **plus IX. and the New Dogmas.** a dogma of the Church (see IMMACULATE CONCEPTION). In the following year he imposed on Catholicism in large a special "devotion" to the Heart of Mary Immaculate. Next year he added a similar devotion to the Sacred Heart of Jesus (see SACRED HEART).

That these things only widened the breach between the Church and the outside world was of no account to Pius. Ever since his return from Gaeta, he had made up his mind to a policy of no surrender; and the curtailment of his own dominions in 1860 only made him the keener to denounce the iniquities of other rulers. In 1864 appeared the encyclical *Quanta Cura*,

together with a Syllabus of eighty of the most important "errors of our time" (see SYLLABUS). These two documents caused

The Syllabus of 1864. an excitement nowadays hard to understand. Apart from some fulminations against such modern pests as "socialism, communism, secret societies, Bible societies, clerico-liberal societies," the Syllabus says nothing that the papacy had not been saying for hundreds of years. Its real object is to attack such professedly Catholic governments as have fallen in with modern ideas—as for instance, by allowing freedom of worship to their Protestant subjects, or by refusing to punish brawling in Catholic churches more severely than other breaches of the peace. In other words, Pius utterly rejected the whole principle of toleration, and declared that the Church would still impose itself by force, whenever it got the chance to do so. However, any hopes he may have had of finding another Philip II. were soon dashed to the ground. Eighteen months after the publication of the Syllabus broke out the Austro-Prussian War (June 1866), when the one faithful ally of Rome was trampled under the feet of the arch-Protestant Hohenzollerns. But the pope's spirit was not broken. If he could not lord it over one sphere, at least he could be master in another. In 1866 he summoned a general council at the Vatican, avowedly for the purpose of getting it

Definitio of the dogma of papal infallibility. to declare his personal infallibility. For although the old rivalry between pope and council had long ago been practically settled in favour of the pope, no council had yet formally acknowledged its defeat. Indeed, many prominent French and German divines still denied papal infallibility altogether; and Louis Napoleon had regularly fallen back on Richelieu's old device of stirring up the embers of Gallicanism, whenever the French clergy grew restive about his alliance with Victor Emmanuel. And even the more moderate believers in the pope's infallibility maintained that it was merely negative, a heaven-sent immunity against falling into error. But Pius and his immediate circle argued that this was not enough. The great need of the age was authority; and authority was most likely to strike the imagination of the faithful if it found a vivid concrete embodiment in the person of the pope. He must not simply be immune from error; truth must stream down on his head from heaven, and on his head alone. "We all know only one thing for certain," wrote the great Catholic pamphleteer, Louis Veillout, "and that is that no one knows anything, except the man with whom God is for ever, the man who carries the thoughts of God." This view was too extreme for the council; the most Pius could hope for was to be declared immune from error, instead of positively inspired. Even this negative infallibility was stoutly contested by the French and German bishops during the eight months that the council lasted (December 1869 to July 1870). But they were richer in talents than numbers: out of six hundred prelates they only commanded eighty votes. Most left Rome before the final session; only two—one from Naples, one from the United States—continued their protest up to the end. On the 18th of July the pope's decrees were declared "irreformable of themselves, irrespectively of the consent of the Church," always provided that they dealt with doctrines of faith and morals, and were delivered *ex cathedra*—that is, with the intention of binding the consciences of all Catholics. These limitations were the work of the moderate infallibilists, but the real hero of the day was Pius. Theologians might draw their fine-spun distinctions between realms where the pope was actually infallible and realms where he was not; but Pius knew well that loyal Catholic common sense would brush their technicalities aside and hold that on any conceivable question the pope was fifty times more likely to be right than any one else (see VATICAN COUNCIL and INFALLIBILITY).

So absolute became the papal sovereignty over conscience that more than one government took alarm. While the council was still sitting the Bavarian minister, Prince Chlodwig zu Hohenlohe-Schillingsfürst, suggested to Bismarck that the Powers would do well to bring its deliberations to an end; and

immediately after the publication of its decrees Austria notified the pope that so vast an extension of the Church's claims would necessitate a revision of the concordat. And when the ex-communication of Döllinger and other anti-infallibilist divines (1871) led to the formation of an independent Old Catholic Church (see OLD CATHOLICS) Bavaria, Switzerland and other countries gave it a warm welcome. So also did Berlin. The new German empire, consolidated through wars with Catholic Germany and Catholic France, was of all countries least likely to tolerate Roman attempts to dictate to its subjects. Tension was increased by the fact that the Centre, or Catholic, party in the Reichstag was led by Windhorst, formerly prime minister to the dispossessed king of Hanover, and thus naturally became identified with the opposition of the smaller German states to the supremacy of Prussia. The quarrel began in 1871 when the Prussian government supported some teachers in state-aided Catholic schools whom the bishops wished to dismiss on account of their anti-infallibilist opinions. A year later, under the ministry of Falk, it developed into what the great scientist, Rudolf Virchow, called a *Kulturkampf*, or conflict of civilizations. The famous May laws (1873) were a determined attempt to bring the literary education, appointment and discipline of the clergy under state control, and to regulate the use of such spiritual penalties as deprivation and excommunication. When the bishops refused to obey, Falk fell back on force. The Jesuits were banished from the German Empire, and most of the other orders from Prussia. The archbishops of Gnesen and Cologne and many minor dignitaries were imprisoned (1874); and the so-called "Bread-basket Law" was passed to coerce the parish clergy by suspending the salaries of the disobedient. The result of these severities was exactly the opposite of what Falk intended. He had meant only to lop off a few ultramontane extremists; he succeeded in sending Catholics of every shade and colour pell-mell into the arms of Rome. And the effect remained long after the cause had died away. On the death of Pius IX. (February 1878) his successor, Leo XIII., at once showed himself willing to come to terms. Negotiations were long and difficult; for Bismarck would not abolish the May laws outright, and Leo had much ado to hold in check the *zealanti* of the Vatican. But Falk retired in 1879; various mutual concessions were made which led to a gradual abrogation of the May laws. Yet—thanks to its organization, its press, and the elaborate network of alliances spun by Windhorst—the Ultramontane Centre still remains a powerful force in German politics.

This conciliatory policy towards Berlin was the first-fruits of a new régime; Leo XIII. was in every way a complete contrast to Pius IX. Pius had fed on inspirations; Leo was a man of calm, deliberate judgment, little likely to yield to the promptings of his *monsignori*. He was a polished scholar of the old-fashioned type; early in his reign he threw open the Vatican Archives to the students of the world. Having spent his youth in the papal diplomatic service—he was nuncio at Brussels from 1843-46—he had a certain knowledge of the workings of parliamentary institutions, while the years immediately before his accession had been spent as archbishop of Perugia, so that he was not closely identified with any of the Vatican parties. The results of a change of master were soon seen. Pius IX. had died at war with almost every country in Europe. He had quarrelled with Austria; Russia was persecuting its Catholic subjects; France was under the spell of Gambetta and his doctrine that clericalism was the enemy; Spain and Belgium followed France; even Switzerland was waging a *Kulturkampf* on a small scale. In a few years Leo had made peace with Austria, pacified Switzerland and Belgium, opened up negotiations with Russia; while his elevation of Newman to the cardinalate (1879) made a great impression in Great Britain. About 1886 hopes even ran high that he was on the eve of a reconciliation with King Humbert at the Quirinal. These hopes were vain. Leo was absolutely convinced that a territorial sovereignty was required to

Old Catholicism.

The Kulturkampf.

Pope Leo XIII.

ensure the moral independence of the papacy; and he believed that the new Italian kingdom was a mushroom growth, that might fall in pieces at any moment. Hence he followed in the steps of Pius IX. and refused to recognize the existence of the *de facto* government in any way whatsoever; he would not accept the subsidies it offered him, or allow Catholics to take any part in political life. During the earlier years of his reign he undoubtedly had hopes of recovering his lost dominions with the help of Germany, and Bismarck was not the man to discourage such expectations. They were suddenly blasted when Germany, Italy and Austria entered into a Triple Alliance at the end of 1887. Thereafter Leo turned to France. Already in 1884 he had warned the French clergy against meddling in royalist intrigues; in 1892 he issued a much more stringent exhortation to French Catholics to rally to the Republic. An idea got abroad that he was looking to the time when the old dream of Lamennais and Gioberti might become a reality, and Italy would split up into a number of republics, amongst which the temporal power of the pope might find a place.

Certainly his public pronouncements took on an increasingly democratic tone. From the first he had shown great interest in social questions; and his encyclicals deal much less with theology than with citizenship, socialism, labour, the marriage-laws. Under his influence a Christian Socialist movement sprang up in France and Belgium, and soon spread to Italy, Germany and Austria. It had undoubtedly done much to awaken interest in social problems, and to call forth philanthropic zeal; but the movement soon travelled far beyond the limits that Leo would have set to it. In Germany, in particular, it has grown into a political party connected with the Social Democrats; nor have the democratic socialists been slow to exploit their Christian allies for their own ends. And in other countries the attempt to bring religion into politics has sometimes had the effect of lowering religion, rather than ennobling politics. In an age of universal suffrage public men cannot afford to appeal to pure reason, or even to pure sentiment. Christian socialism becomes a real force when it translates itself into anti-Semitism; and anti-Semitism is at its strongest when it is pursuing one particular Jewish captain in the French artillery. Much on the same lines stands the Italian Catholic attempt to show that the Freemasons are the real founders of Italian independence, and to take the field against them with the help of Léon Taxil and "Diana Vaughan." And, quite apart from their political colouring, such attempts to meet the devotional tastes of the masses as the miracles of Lourdes, or the modern French religious press, lie well within the range of criticism. Nor have they even had the dubious merit of success. Dying in 1903, Leo XIII. was spared from seeing the failure of his policy of reconciliation with the French Republic; for the "denunciation of the concordat" (December 1905) and consequent

separation of Church and State took place under his successor, Pius X. What results this measure may have on France it must be left to the future to decide. Nor is it yet possible to forecast the result of the only other sensational event that the reign of Pius X. has yet produced—his condemnation in 1907 of the complex movement known as

Modernism. Modernism. This began as an attempt to break loose from the neo-Scholasticism so ardently patronized both by Pius IX. and Leo XIII., and to supplant the critical methods of the medieval doctors by those of modern scholarship; and its leaders have won special distinction in the fields of Biblical criticism and ecclesiastical history. But Modernism soon broadened into a thoroughgoing revolt against the modes of thought and methods characteristic of the latter-day Vatican; its motto is that Catholicism is the strength of popery, but popery the weakness of Catholicism. By "popery" must here be understood the belief that spiritual doctrines always lend themselves to a precise embodiment in black and white, and can thereafter be dealt with like so many clauses of an act of parliament. Modernists deny that the spirit of religion can be thus imprisoned in an unchangeable formula;

they hold that it is always growing, and therefore in continual need of readjustment and restatement. On the other hand, they maintain that the present always has its roots in the past, and therefore they are opposed to any violent change; they consider, for instance, that northern Europe would have done better to listen to Erasmus than to Luther. But progress can leave little room to individual initiative, if it must always be orderly and systematic; and the Modernists accordingly show little sympathy with Protestantism. The core of their creed is a fervid belief in the infallibility of Catholic instinct, if only Catholic theology can be induced to leave it to develop in peace. Hitherto the theologians have shown small disposition to hold their hand; and several of the leading Modernists have been excommunicated (see especially the article LOISY, A. F.), while the whole movement was condemned in bitter and scathing language by Pius X.'s encyclical (*Pascendi gregis*) against the Modernists. But ideas are difficult to kill, and it is possible that the Modernist movement may yet prove to be the opening chapter of a mighty revolution within the Church of Rome.¹

BIBLIOGRAPHY.—The literature on the Roman Catholic Church is, of course, vast. Many works will be found in the lists of authorities appended to the articles to which cross-reference is made above, notably PAPACY. Here it is only possible to give a few outstanding books of reference. The most compendious of all works of reference on the subject, though partly antiquated, is the *Encyclopédie théologique* of the Abbé Migne (1844-66), Ser. I., 50 vols., Ser. II., 52 vols., Ser. III., 66 vols. This is a series of dictionaries, and contains Fr. Périnès's *Dictionnaire de bibliographie catholique*, 5 vols. (Paris, 1858-60). A useful systematized bibliography is also given in the Subject Index of the London Library (1909), pp. 945-51. Other encyclopaedias are WATZER and WELT'S *Kirchenlexikon*, 13 B. (2nd ed., Hergeneröther, &c., 1882-1903), *Roman Catholic* (there is a French translation of the 1st edition, ed. T. Goschler, 1870); Herzog-Hauck, *Realencyclopädie für Protestantische Theologie und Kirche* (3rd ed., Leipzig, 1896-1909), Protestant, but containing articles of universally recognized scientific authority on many aspects of the Roman Catholic Church; the *Catholic Encyclopedia* (London and New York, 1907 ff.), invaluable as an authoritative account of Roman Catholicism in all its phases, by eminent Catholics of all nations. All these encyclopaedias are also bibliographies. (St C.)

The Church in England.

The origin of the English Roman Catholics as a community separated from the National Church is generally held to date from the accession of Queen Elizabeth in 1558. In the following year was passed an Act of Supremacy, whereby all public officials, clerical and lay, were required to acknowledge the supremacy of the queen "as well in spiritual things or causes as temporal." This declaration all the existing bishops, with two exceptions, refused to make; some fled the country, some were imprisoned, others simply deprived and placed under surveillance.² To the parish clergy the declaration was not systematically tendered; of those deprived of their livings a large number were allowed to remain on as chaplains in private families. From laymen, unless they happened to hold some public office, no declaration was expected; and during the earlier years of Elizabeth's reign most of them continued to attend at their parish church. The line of division became much more acute when Pius V. deposed Elizabeth from her throne (1570); thenceforward her government looked on every Catholic as a potential rebel. Already it had passed a severe act against the Catholics in 1562; this was followed by other measures in 1571, 1580, 1584, 1585, 1593. During the forty-five years of Elizabeth's reign, however, only about 180 persons suffered death—less than half the number of those whom the Catholic zeal

¹ For a criticism of the modern tendencies of the Roman Catholic Church from an outside point of view see ULTRAMONTANISM.

² From the Roman Catholic point of view the ancient English hierarchy came to an end with the death of Thomas Goldwell, some time bishop of St Asaph, at Rome on the 3rd of April 1585. Some six months previously Thomas Watson, formerly bishop of Lincoln, had died in prison in England.

³ Not as heretics, by burning, but as traitors, by hanging, drawing and quartering. But, since to say or hear mass was constructive treason, the distinction was, in many cases, without a difference.

of her sister, Queen Mary, had burnt in one-ninth of the time. Under James I. an attempt was made to distinguish between the loyal and disloyal Catholics, the latter comprising all those who maintained the pope's right to depose sovereigns from their throne. This led to a violent division among the Catholics themselves. Many forswore the deposing power; the majority, acting under imperative orders from Rome, refused to deny it. The government retorted by adding several new penal laws to the statute-book, though less than thirty Catholics were brought to the scaffold during James's reign. Under Charles I. the position of the Catholics was greatly improved, largely owing to the king's marriage with a French princess. Although not actually repealed, the penal laws were seldom put in force, and mass was openly celebrated in London and elsewhere. On the outbreak of the Civil War the Catholics naturally sided with the king, and a great many fell fighting for the royalist cause; towards the survivors Cromwell was unexpectedly merciful. Very few were put to death, though a number of estates were confiscated. Under Charles II. came a new period of prosperity; two Catholics, Lords Arlington and Clifford, were admitted to the inner circles of the government. Protestant suspicion was excited; in 1673 was passed the Test Act, obliging all office-holders to receive the sacrament in the Established Church, and to declare their disbelief in transubstantiation.¹ Five years later (1678) popular exasperation found a more savage outlet, and greedily swallowed the tales of Titus Oates about a mythical "popish plot." A number of victims were brought to the scaffold, and Catholics were declared incapable of sitting in either house of parliament. James II., however, was utterly indifferent to the feelings of his subjects. He packed the privy council, the army and the universities with Catholics, and tried to legalize the exercise of their religion by an utterly unconstitutional Declaration of Indulgence. Three years were enough to convince the nation that he was "endeavouring to subvert and extirpate the Protestant religion, and the laws and liberties of this kingdom"; and on his deposition in 1688 Roman Catholics, or persons married to Roman Catholics, were declared incapable of succeeding to the throne. A new oath of allegiance was imposed on all holders of civil or military office; they were required to swear that no foreign prelate had, or ought to have, any jurisdiction, whether civil or ecclesiastical, within the realm. Further, a number of statutes were passed with the object of putting every possible obstacle in the way of Catholics educating their children in their own creed, or of inheriting or buying land. That they remained so long "utterly disabled from bearing any public office or charge" was due to the participation of many of their number in the Jacobite revolts of 1715 and 1745. After Culloden, however, it was seen that all serious danger of a Stuart restoration was passed; and in 1778 Catholics who abjured the Pretender and denied the civil authority of the pope were relieved from their most pressing disabilities. A proposal to extend this measure to Scotland led to violent agitation in that country. Feeling soon spread to England, and culminated in the Gordon riots of 1780. Meanwhile, however, strenuous efforts were being made by the Roman Catholics to obtain relief by establishing a reasonable *modus vivendi* with the government. Within the Catholic body itself there was even at this time a more or less pronounced anti-Roman movement, a reflection of the Gallican and Febronian tendencies on the continent of Europe, and the "Catholic Committee," consisting for the most part of influential laymen, which had been formed to negotiate with the government, was prepared to go a long

¹ This declaration, which denounced the mass as "idolatrous and superstitious," was taken by all office-bearers, including bishops on taking their seats in the House of Lords, until the Relief Act of 1829. It was imposed by the Act of Settlement on the sovereign also, in order to make impossible any repetition of the policy of James II. This "Declaration of the Sovereign" formed the subject of heated debate on the accession of kings Edward VII. and George V., and in August 1910 parliament substituted for it a simple declaration of adhesion to the Protestant religion.

way in repudiating the extreme claims of the Holy See, some even demanding the creation of a national hierarchy in merely nominal dependence on Rome, and advocating the substitution of English for Latin in the services. This attitude led to a somewhat prolonged conflict between the Committee and the vicars apostolic, who for the most part represented the high ultramontane view. The outcome of the Committee's work was the great Protest, signed by 1500 bishops, priests and leading laymen, in which the loyalty of Catholics to the crown and constitution was strenuously affirmed and the ultramontane point of view repudiated in the startling declaration, "We acknowledge no infallibility in the pope." As the result of the negotiations preceding and following this action, the government in 1791 passed a bill relieving from all their more vexatious disabilities those Roman Catholics² who rejected the temporal authority of the pope; and during the first quarter of the 19th century a series of attempts was made to abolish Catholic disabilities altogether. To this, however, George III. and his successors were bitterly opposed; only in 1829 did George IV. give way, and allow the passage of the Catholic Relief Act. This virtually removed all restrictions on Catholics, except that it left them incapable of filling the offices of Regent, Lord Chancellor, or Lord Lieutenant of Ireland; and it expressly debarred their priests from sitting in the House of Commons.

Ecclesiastical Administration.—During the reign of Elizabeth this was necessarily in a chaotic state. As the Marian clergy died out, their place was taken by priests trained at theological colleges established for this purpose at Douai, Rome, Valladolid and other places. These were the "seminary priests," objects of great suspicion to the government. About 1580 Jesuit missionaries began to come, and soon became involved in bitter quarrels with the secular missionaries already at work. Mutual jealousies were only increased when the seculars were grouped together under an arch-priest in 1599. Nor were matters much bettered when the papacy took advantage of the presence of a Catholic queen in England, and sent over in 1625 a vicar-apostolic³—that is, a prelate in episcopal orders, but without the full authority of a diocesan bishop. He was soon compelled to withdraw, and the direction of affairs fell to an intermittent series of papal envoys accredited to Henrietta Maria or Catherine of Braganza. On the accession of James II. a new vicar-apostolic—John Leyburne, bishop of Adrumetum *in partibus*—was at once appointed (1685); three years later England was divided into four districts—the London, Midland, Northern and Western—each under a vicar-apostolic. This arrangement lasted till 1840, when the number of vicariates was doubled by the addition of the Welsh, Eastern, Lancashire and Yorkshire districts. In 1850 came the "restoration of the hierarchy" by Pope Pius IX., when England was mapped out into an arch-bishopric of Westminster⁴ and twelve suffragan sees, since increased to fifteen (sixteen including the Welsh see of Menevia). This "papal aggression" caused great excitement at the time, and an Ecclesiastical Titles Act was passed in 1851, though never put in force, forbidding Roman Catholic prelates to assume territorial designations.⁵

² They were described in the first draft of the bill as "Protesting Catholic Dissenters," but this was changed, in deference to the strenuous remonstrances of the vicars-apostolic, into "Roman Catholics."

³ Richard Smith, bishop of Chalcedon *in partibus* (d. 1655).

⁴ Cardinal Wiseman (*q.v.*) was the first archbishop of Westminster. It was on his advice that Pope Gregory XVI. increased the number of English vicariates-apostolic in 1839, and from 1840 onward, as vicar-apostolic first of the Midland and afterwards of the London district, he was mainly instrumental in bringing the English Roman Catholic Church into closer touch with "the spirit of Rome." The outward sign of this was the substitution of the Roman ritual for the English pre-Reformation use hitherto followed in the services, while English Roman Catholicism became increasingly ultramontane in temper, a tendency much strengthened under Cardinal Manning.

⁵ The titles of the sees could not by law be the same as those of the Established Church. In several cases, however (e.g. Birmingham, Liverpool, Southwark, Newcastle), sees have since been created by

Population.—No trustworthy figures are forthcoming as to the numbers of the English Roman Catholics at the different stages of their history. At the accession of Elizabeth they undoubtedly formed a large proportion of the population. During her reign they greatly decreased, and the decrease continued during the 17th century. A return, made with some apparent care soon after the accession of William III., estimates their total number at barely 30,000. During the 18th century they began to increase; a return presented to the House of Lords in 1780 estimates their number at nearly 70,000. Joseph Berington, himself a distinguished Catholic priest, considers that this number was above the mark; he reports that his co-religionists were most numerous in Lancashire and London; next came Yorkshire, Northumberland and Staffordshire. In many of the southern counties there were scarcely any Catholics at all. Even in Berington's time, however, there was a certain tendency to increase; and the great number of conversions that followed the Relief Act of 1791 was a stock argument of opponents of the act of 1829. Of late years, notably since the Oxford Movement within the Established Church, the number of converts has been much increased; for some time past it has averaged about 8000 souls a year. But a far more potent factor in swelling the numbers of the Catholics has been the immigration of the Irish, which began early in the 19th century, but was enormously stimulated by the famine of 1846. In 1870 Mr Ravenstein reckoned the total number of Roman Catholics in England as slightly under a million, of whom about 750,000 were Irish, and 50,000 foreigners. By 1910 the general total is considered to have risen to about a million and a half. (ST. C.)

AUTHORITIES.—Alphons Bellesheim, *Cardinal Allen und die Englischen Seminare* (Mainz, 1885); *Katholische Kirche in Schottland* (Mainz, 1886; translated and engraved by D. O. Hunter-Blair, O.S.B., Edinburgh, 1887); *Katholische Kirche in Irland* (1890); Charles Dodd (as pseudonym of Hugh Tootell), *Church History of England* (1737); edited by M. A. Tierney, London, 1839); Joseph Berington, *State and Behaviour of the English Catholics* (1780); Charles Butler, *Historical Memoirs respecting the English, Irish and Scottish Catholics* (London, 1819); T. F. Knox, *The Douay Diaries* (1878) and *Letters of Cardinal Allen* (2 vols., J. Morris, Catholic England in Modern Times (1892); T. Murphy, *Catholic Church in England during the Last Two Centuries* (1892); W. J. Amberst, *History of Catholic Emancipation* (2 vols., London, 1886); F. C. Husenbeth, *Life of John Bishop Milner* (Dublin, 1862); Willard Ward, *Life and Times of Cardinal Wiseman* (2 vols., London, 1897); E. S. Purcell, *Life of Cardinal Manning* (2 vols., London, 1895); Bernard Ward, *Dawn of the Catholic Revival in England, 1781-1803* (2 vols., 1909). For the sufferings under the penal laws see, for general reference, R. Stanton, *A Menology of England and Wales* (with supplement, London, 1892), and Bishop Challoner's *Missionary Priests* (1741 ff.), which still remains the standard work on the subject.

English Law relating to Roman Catholics.—The history of the old penal laws against Roman Catholics in the United Kingdom has been sketched above and in the article IRELAND, History.¹ The principal English acts directed against "popish recusants" will be found in the list given in the article repealing them (7 & 8 Vict. c. 102, 1844; 9 & 10 Vict. c. 59, 1846). The principal Scottish act was 1700, c. 3; the principal Irish act, 2 Anne c. 3. Numerous decisions illustrating the practical operation of the old law in Ireland are collected in G. E. Howard's *Cases on the Popery Laws* (1775). The Roman Catholic Emancipation Act 1829 (10 Geo. IV. c. 7), although it gave Roman Catholic citizens in the main complete civil and religious liberty, at the same time left them under certain disabilities, trifling in comparison with those under which they laboured before 1829. Nor did the act affect in any way the long series of old statutes directed against the assumption of authority by the Roman see in England. The earliest of these which is still law is the Statute of Provisors of 1351 (25 Edw. III. st. 4). The effect of the Roman Catholic Charities Act 1832 is to place Roman Catholic schools, places of worship and education, and charities, and the property held therewith, under the laws applying to Protestant nonconformists. The Toleration Act act of parliament bearing the same titles, so that there are now often two bishops bearing the same style. From the point of view of the State, that of the Roman Catholic bishop's is, of course, only a title of courtesy, the Anglican bishop alone having the legal right to bear it.

¹ See also Stephen's *History of the Criminal Law*, vol. ii. p. 483; Anstey, *The Law affecting Roman Catholics* (1842); Lilly and Wallis, *Manual of the Law specially affecting Catholics* (1893).

² A recusant signified a person who refused duly to attend his parish church.

does not apply to Roman Catholics, but legislation of a similar kind, especially the Relief Act of 1791 (31 Geo. III. c. 32), exempts the priest from parochial offices, such as those of churchwarden and constable, and from serving in the militia or on a jury, and enables all Roman Catholics scrupling the oaths of office to exercise the office of churchwarden and some other offices by deputy. The priest is, unlike the nonconformist minister, regarded as being in holy orders. He cannot, therefore, sit in the House of Commons, but there is nothing to prevent a peer who is a priest from sitting and voting in the House of Lords. If a priest becomes a convert to the Church of England he need not be re-ordained. The remaining law affecting Roman Catholics may be classed under the following five heads:—

(1) **Office.**—There are certain offices still closed to Roman Catholics. By the Act of Settlement a papist or the husband or wife of a papist cannot be king or queen. The act of 1829 provides that nothing therein contained is to enable a Roman Catholic to hold the office of guardian and justice of the United Kingdom, or of regent of the United Kingdom; of lord chancellor, lord keeper, or lord commissioner of the great seal of Great Britain or Ireland or lord lieutenant of Ireland; of high commissioner to the General Assembly of the Church of Scotland, or of any office in the Church of England or Scotland, the ecclesiastical courts, cathedral foundations and certain colleges. The disability in the case of the lord chancellor of Ireland was removed by statute in 1867, with necessary limitations as to ecclesiastical patronage. The act of 1829 precluded the liability of Roman Catholics to take certain oaths of office, but these have been modified by later legislation (see 29 & 30 Vict. c. 19; 30 & 31 Vict. c. 75; 31 & 32 Vict. c. 72; 34 & 35 Vict. c. 48). Legislation has been in the direction of omitting words which might be supposed to give offence to Roman Catholics. The only offices which Roman Catholics are not legally capable of holding now are the lord chancellorship of England and the lord lieutenancy of Ireland (see, however, Lilly and Wallis, pp. 36-43).

(2) **Title.**—The act of 1829 forbids the assumption by any person, other than the person authorized by law, of the name, style or title of an archbishop, bishop or dean of the Church of England. The Ecclesiastical Titles Act 1851 went further, and forbade the assumption by an unauthorized person of a title from any place in the United Kingdom, whether or not such place were the seat of an archbishop, bishop or deanery. This act was, however, repealed in 1867, but the provisions of the act of 1829 are still in force.

(3) **Religious Orders.**—It was enacted by the act of 1829 that "every Jesuit and every member of any other religious order, community or society of the Church of Rome bound by monastic or religious vows" was, within six months after the commencement of the act, to deliver to the clerk of the peace of the county in which he should reside a notice or statement in the form given to the schedule to the act, and that every Jesuit or member of such religious order coming into the realm after the commencement of the act should be guilty of a misdemeanour and should be banished from the United Kingdom for life, with an exception in favour of natural-born subjects duly registered). A secretary of state, being a Protestant, was empowered to grant licences to Jesuits, &c., to come into the United Kingdom and remain there for a period not exceeding six months. An account of these licences was to be laid annually before parliament. The admission of any person as a regular ecclesiastic by any such Jesuit, &c., was made a misdemeanour, and the person so admitted was to be banished for life. Nothing in the act was to extend to religious orders of females. These provisions exist *in posse* only, and have, it is believed, never been put into force.

(4) **Superstitious Uses.**—Gifts to superstitious uses are void both at common law and by statute. It is not easy to determine what gifts are to be regarded as gifts to superstitious uses. Like contracts contrary to public policy, they depend to a great extent to their illegality upon the discretion of the court in the particular case. The act of 23 Hen. VIII. c. 10 makes void any assurance of lands to the use (to have obits perpetual) or the continual service of a priest for ever or for threescore or fourscore years. The act of 1 Edw. VI. c. 14 (specially directed to the suppression of chantries) vests in the crown all money paid by testators and all lands appointed in the will to the finding or maintenance of any priest, or any anniversary or obit or other like thing, or of any light or lamp in any church or chapel maintained within five years before 1547. The act may still be of value in the construction of old grants, and in affording examples of what the legislature regarded as superstitious uses. Gifts which the courts have held void on the analogy of those mentioned in the acts of Henry VIII. and Edward VI. are a devise for the good of the soul of the testator, a bequest to certain Roman Catholic priests (the testator may have the benefit of their prayers and masses, and a bequest in trust to apply a fund to circulate a book teaching the supremacy of the pope in matters of faith, or a bequest to maintain a taper for evermore before the image of Our Lady. The court may

compel discovery of a secret trust for superstitious uses. Since 2 & 3 Will. IV. c. 115 gifts for the propagation of the Roman Catholic faith are not void as made to superstitious uses. It should be noticed that the doctrine of superstitious uses is not confined to the Roman Catholic religion, though the question has generally arisen in the case of gifts made by persons of that religion. The Roman Catholic Charities Act 1860 enables the court to separate a lawful charitable trust from any part of the estate subject to any trust or provision deemed to be superstitious. It also provides that in the absence of any written document of use of twenty years is to be conclusive evidence of the application of charitable trusts.

(5) *Patronage*.—A Roman Catholic cannot present to a benefice, prebend, or other ecclesiastical living, or collate or nominate to any free school, hospital or donative (3 Jac. I. c. 5). Such patronage is by the act vested in the universities, Oxford taking the City of London and twenty-five counties in England and Wales, mostly south of the Trent, Cambridge the remaining twenty-seven. The principle is affirmed in subsequent acts (1 Will. and Mary, sess. 1, c. 26; 12 Anne, st. 2, c. 14; 11 Geo. II. c. 17). If the right of presentation to an ecclesiastical benefice belongs to any officer under the crown, and that office is held by a Roman Catholic, the archbishop of Canterbury exercises the right for the time being (10 Geo. IV. c. 7, s. 17). No Roman Catholic may advise the crown as to the exercise of its ecclesiastical patronage (Ibid. s. 18). A Roman Catholic, if a member of a lay corporation, cannot vote in any ecclesiastical appointment (Ibid. s. 15). Grants and devises of advowsons, &c., by Roman Catholics are void, unless for valuable consideration to a Protestant benefice (11 Geo. IV. c. 17, s. 5). Where a *quære impedit* is pending before any court, the court may compel the patron to take an oath that there is no secret trust for the benefit of a Roman Catholic.

(J. W.)

The Church in the United States.

The history of Roman Catholicism in the New World begins with the Norse discoveries of Greenland and Vinland the Good. In the former the bishopric of Gardar was established in 1112, and extinguished only in 1492. To the latter (the coast of New England), the Northmen during the same period made "temporary visits for timber and peltries, or missionary voyages to evangelize for a season the natives." Beyond these facts, the Norse sagas and chronicles contribute little that is certain (cf. "The Norse Hierarchy in the United States," *Amer. Cath. Quart. Review*, April 1890). Although a bishop was appointed by the pope for the vaguely defined territory of Florida so early as 1528, the oldest Catholic community in what is now the United States dates from 1565, when the Spanish colony of St Augustine was founded. Hence the aboriginal tribes of the South were evangelized. In 1582 the missions of New Mexico were undertaken, and from 1601 Catholic missionaries were at work along the Pacific coast, especially in California. Early in the 17th century trading posts and mission centres were established on the coast of Maine, and during the same century French priests laboured zealously in northern New York, along the entire coast of the Mississippi from Wisconsin to Louisiana, and around the Great Lakes. Their principal concern was for the savages, over whom they acquired an extraordinary influence. Political jealousies, human avarice and treachery arrested the progress of most of their missions.

The English colony of Maryland, planned by the Catholic George Calvert (1st Lord Baltimore), and founded (1634) by his son the Catholic Cecilus Calvert (2nd Lord Baltimore), and Pennsylvania, founded (1681) by the tolerant Quaker William Penn, first permitted the legal existence of Catholicism in English-speaking communities of the New World. It is from these centres that it spread during the 18th century. In 1784 the Rev. John Carroll was appointed prefect-apostolic for the Catholics of the English colonies hitherto dependent on the vicar-apostolic of London. In 1790 Father Carroll was made bishop of the see of Baltimore, and given charge of all the Catholic interests in the United States. There were then about 24,500 Catholics in the land, of which number 15,800 were in Maryland, and 7000 in Pennsylvania, 200 in Virginia and 1500 in New York. In 1807 they had grown to 150,000 with 80 churches. In the following year Baltimore found itself the first metropolitan see of the United States, with New York, Philadelphia, Boston and Bardstown as suffragans.

The growth of the Catholic population by decades since 1820

was calculated by a competent historian, the late John Gilmary Shea, as follows:—

1820	244,500	1860	3,000,000
1830	361,000	1870	4,685,000
1840	1,000,000	1880	7,067,000
1850	1,726,470	1890	10,627,000

The number in 1906 was 12,079,142 (U.S. Census, *Special Report*, 1010). The main source of this growth has been immigration. Originally the Irish and the Germans furnished the greater quota. Later the French-Canadians, Italians, Poles and Bohemians added notably to the number; an appreciable percentage of Oriental Catholics is also found,—Greeks, Syrians, Armenians, &c. Natural increase, especially among the first Catholic immigrants, and a certain percentage of conversions from Protestantism, are contributory sources. Being under the protection of the constitution, and enjoying the advantages of the common law, Catholicism could not meet with any official opposition; such few outbursts of fanaticism as there have been were but temporary or local, and did not represent the true feelings of the country. As to the future of the Church in the United States, all Catholics feel, with their latest historian, that "the Catholic Church is in accord with Christ's revelation, with American liberty, and is the strongest power for the preservation of the Republic from the new social dangers that threaten the United States as well as the whole civilized world. She has not grown, she cannot grow so weak and old that she may not maintain what she has produced—Christian civilization."

Internally, Catholicism in the United States has been free from any noteworthy schisms or heresies that might impede its development—its doctrinal history offers nothing of importance. The discipline differs little from that of the other churches of Catholicism. The unity of doctrine, liturgy and moral ideals is preserved by an intimate union with the see of Rome. The general canonical legislation of the Church, the legislation by papal rescript and the Congregation of the Propaganda, the decisions of the Apostolic Delegation at Washington, and a certain amount of immemorial custom and practice, form the code that governs its domestic relations. Decennially each bishop of the United States is expected to pay a visit to Rome (*Ad Limina Apostolorum*), and to make a report of the spiritual condition of religion within his diocese. In addition a system of synods provides for local unity among bishops, priests and laity. Thus each province or body of bishops under a metropolitan holds provincial councils, while at greater intervals a plenary or national council is held. Of these last three have taken place—their decrees, when approved at Rome, are binding on all Catholics in the United States.

In education the Catholic Church endeavours to keep abreast with the best. There are, according to Hoffmann's *Directory* (Milwaukee, 1907), 4364 parochial schools, in which 1,096,842 children of both sexes receive instruction. The total number of children in Catholic institutions is given as 1,266,175. There are 498 colleges for boys and 678 academies for girls. This system of education is crowned by the Catholic University of America at Washington, established by Leo XIII, and the American hierarchy, and endowed with all the privileges of the old pontifical universities of Europe. In addition there are several other schools that rank as universities. The education of the clergy is provided for by 86 seminaries, in which there are 5697 students. The charitable institutions in the Church are very numerous. There are 255 orphan asylums, with 40,588 inmates. The other charitable institutions are 992 in number, and include every form of public and private charity; no diocese is without one or more such establishments. The actual government of the Church in the United States is represented by one cardinal, 14 archbishops, 89 bishops, 11,135 diocesan clergymen, under the sole and immediate direction of the bishop, 3958 members of religious orders subject to episcopal supervision—in all 15,093 clergymen. There are 8072 churches with resident priests, and 4076 mission churches—in all 12,148, to which must be added 3358 chapels. Several hundred weekly publications are printed in English and foreign tongues, to minister to the needs of the Catholic population. There exist also several literary and academical magazines and reviews of a high order of merit.

The principal religious events in the recent history of the Church were the holding of the Third Plenary Council of Baltimore (1884),

the Catholic Congress (1889), the opening of the Catholic University (1889), the Columbian Educational Exhibit at Chicago (1893), the establishment of the Apostolic Delegation at Washington (1893).

The Catholic Church in the United States conducts no foreign missions, but takes care of its own percentage of Indians and Negroes. Of the Indian population of the United States about 48,194 are Catholics, and they are attended by 65 priests, who look after 96 churches or chapels; there are 50 schools conducted by members of 16 sisterhoods, in which 4430 children are educated. The Catholic negroes are about 138,573 in number. They have 47 churches conducted by 43 white clergymen; 114 schools, in which 6294 children are educated by 31 sisterhoods, who also conduct 11 charitable institutions. The expenses of these missions are borne by private charity, and by a general annual collection.

AUTHORITIES.—General History: John Gilmary Shea, *Life and Times of Archbishop Carroll* (New York, 1888); *The Catholic Church in Colonial Days* (New York, 1886); *The Hierarchy of the Catholic Church in the United States* (New York, 1886).—Bishop O'Gorman, *A History of the Catholic Church in the United States* (1895). This work contains a useful bibliography.—Clarke, *Lives of the Deceased Bishops* (1872). Statistics: *The Annual Directory of the Catholic Clergy*. Of these, two are published; one by D. & J. Sadlier, New York, the other (Hoffmann's) by M. Wiltzky & Co. of Milwaukee. The Catholic general statistics of the eleventh (1890) census may be found in *The Religious Forces of the United States*, by H. K. Carroll (New York, 1893). See also U.S. Census, *Special Report on Religious Bodies in 1900* (1910). Legislation: *Acta et Decreta Concilii Plenarii Baltimorensis*, iii. (Baltimore, 1886). This is illustrated and brought into relation with the general laws of the Church in Smith's *Elements of Ecclesiastical Law* (New York). In connexion with this may be read Humphrey's *Urbs et Orbis* (London, 1899), an account of the general government of Roman Catholicism.

(*) J. G.)

ROMANCE, originally a composition written in "Romance" language: that is to say, in one of the phases on which the Latin tongue entered after or during the dark ages. For some centuries by far the larger number of these compositions were narrative fictions in prose or verse; and since the special "Romance" language of France—the earliest so-called—was the original vehicle of nearly all such fictions, the use of the term for them became more and more accepted in a limited sense. Yet for a long time there was no definite connotation of *fiction* attached to it, but only of narrative story; and the French version of William of Tyre's *History of the Crusades*, a very serious chronicle written towards the close of the 12th century, bears the name of *Roman d'Éracle* simply because the name of the emperor Heraclius occurs in the first line. But if the explanation of the name "Romance" is quite simple, certain and authentic, the same is by no means the case with its definition, or even with the origin of the thing to which that name came mostly to be applied. For some centuries an abstraction has been formed from the concrete examples. "Romance," "romanticism," "the romantic character," "the romantic spirits," have been used to express sometimes a quality regarded in itself, but much more frequently a difference from the supposed "classical" character and spirit. The following article will deal chiefly with the matter of Romance, excluding or merely referring to accounts of such individual romances as are noticed elsewhere. But it will not be possible to conclude without some reference to the vaguer and more contentions significance.

Speculations on the origin of the peculiar kind of story which we recognize rather than define under the name of romance have been numerous and sometimes confident; but a wary and well-informed criticism will be slow to accept most of them. It is certain that many of its characteristics are present in the *Odyssey*; and it is a most remarkable fact that these characteristics are singled out for reprehension—or at least for comparative disapproval—by the author of the *Treatise on the Sublime*. The absence of central plot, and the prolongation rather than evolution of the story; the intermixture of the supernatural; the presence and indeed prominence of love-affairs; the juxtaposition of tragic and almost farcical incident; the variety of adventure arranged rather in the fashion of a panorama than otherwise: all these things are in the *Odyssey*, and they are all, in varying degrees and measures, characteristic

of romance. Nor are they absent from the few specimens of ancient prose fiction which we possess. If the *Satyricon* was ever more than a mass of fragments, it was certainly a romance, though one much mixed with satire, criticism and other things; and the various Greek survivals from Longus to Eustathius always and rightly receive the name. But two things were still wanting which were to be all-powerful in the romances proper—Chivalry and Religion. They could not yet be included, for chivalry did not exist; and such religion as did exist lent itself but ill to the purpose except by providing myths for ornament and perhaps pattern.

A possible origin of the new romance into which these elements entered (though it was some time before that of chivalry definitely emerged) has been seen by one of the least hazardous of the speculations above referred to in the hagiology or "Saint's Life," which arose at an early though uncertain period, developed itself pretty rapidly, and spreading over all Christendom (which by degrees meant all Europe and parts of Asia) provided centuries with their chief supply of what may be called interesting literature. If the author of *On "Saint's Life"* *The Sublime* was actually Longinus, the minister of Zenobia, there is no doubt that examples both sacred and profane of the kind of "fiction" ("imitation" or "representation") which he deprecated were mustering and multiplying close to, perhaps in, his own time. The Alexander legend of the pseudo-Callisthenes is supposed to have seen the light in Egypt as early as A.D. 200, and the first Greek version of that "Vision of Saint Paul," which is the ancestor of all the large family of legends of the life after death, is pretty certainly as old as the 4th century and may be as old as the 3rd. The development of the Alexander was to some extent checked or confined to narrow channels as long as something like traditional and continuous study of the classics was kept up. But hagiology was entirely free from criticism; its subjects were immensely numerous; and in the very nature of the case it allowed the tendencies and the folklore of three continents and of most of their countries to mingle with it. Especially the comparative sobriety of classical literature became affected with the Eastern appetite for marvel and "unhesitating acceptance of it; and the extraordinary beauty of many of the central stories invited and necessitated embroidery, continuation, episode. Later, no doubt, the adult romance directly reacted on the original saint's life, as in the legends of St Mary Magdalene most of all, of St Eustace, and of many others. But there can be very little doubt that if the romance itself did not spring from the saint's life it was fostered thereby.

Proceeding a little further in the cautious quest—not for the definite origins which are usually delusive, but for the tendencies which avail themselves of opportunities and the opportunities which lend themselves to tendencies—we may notice two things very important to the subject. The one is that as Græco-Roman civilization began to spread North and East it met, to appearance which approaches certainty, matter which lent itself gladly to "romantic" treatment. *The gathering of matter*. That such matter was abundant in the literature and folk-lore of the East we know: that it was even more abundant in the literatures and folk-lore of the North, if we cannot strictly be said to know, we may be reasonably sure. On the other hand, as the various barbarian nations (using the word in the wide Greek sense), at least those of the North, became educated to literature, to "grammar," by classical examples, they found not a few passages in these examples which were either almost romances already or which lent themselves, with readiness that was almost insistence, to romantic treatment. Apollonius Rhodius had made almost a complete romance of the story of Jason and Medea. Virgil had imitated him by making almost a complete romance of the story of Aeneas and Dido; and Ovid, who for that very reason was to become the most popular author of the middle ages early and late, had gone some way towards romancing a great body of mythology. We do not know exactly who first applied to the legendary tale of Troy the methods which the

pseudo-Callisthenes and "Julius Valerius" applied to the historical wars of Alexander, but there is every reason to believe that it was done fairly early. In short, during the late classical or semi-classical times and the whole of the dark ages, things were making for romance in almost every direction.

It would and did follow from this that the thing evolved itself in so many different places and in so many different forms that only a person of extraordinary temerity would put his finger on any given work and say, "This is the first romance," even putting aside the extreme chronological uncertainty of most of the documents that could be selected for such a position. Except by the most meteoric flights of "higher" criticism we cannot attain to any opinion as to the age and first developed form of such a story as that of Weland and Beadholm (referred to in the *Complaint of Deor*), which has strong romantic possibilities and must be almost of the oldest. The

much more complicated Volsung and Nibelung story, though we may explore to some extent the existence backwards of its Norse and German forms, baffles us beyond certain points in each case; yet this, with the exception of the religious element, is romance almost achieved. And the origin of the great type of the romance that is achieved—that has all elements present and brings them to absolute perfection—the Arthurian legend, despite the immense labours that have been spent upon it and the valuable additions to particular knowledge which have resulted from some of them, is still more than its own Grail, a quest unachieved, probably a thing unachievable. The longest and the widest inquiries, provided only that they be conducted in any spirit save that which determines to attain certainty and therefore concludes that certainty has been attained, will probably acquiesce most resignedly in the dictum that romance "grew"—that its birthplace is as unknown as the grave of its greatest representative figure.

But when it has "grown" to a certain stage we can find it, and in a way localize it, and more definitely still analyse and comprehend its characteristics from their concrete expressions.

Approaching these concrete expressions, then, without at first too hard and fast requirements in regard to the validation of the claims, we find in Europe about the 11th century (the time is designedly left loose) divers classes of what we should now call imaginative or fictitious literature, nearly all (the exceptions are Scandinavian and Old English) in verse. These are: (i) The saints' lives; (ii) the Norse sagas, roughly so-called; (iii) the French *chansons de geste*; (iv) the Old English and Old German stories of various kinds; (v) perhaps the beginning of the Arthurian cycle; (vi) various stories more or less based on classical legend or history from the tales of Alexander and of Troy down to things like *Apolonius of Tyre*, which have no classical authority of either kind, but strongly resemble the Greek romances, and which were, as in the case named, pretty certainly derived from members of the class; (vii) certain fragments of Eastern story making their way first, it may be, through Spain by pilgrimages, latterly by the crusades.

Now, without attempting to fence off too rigidly the classical from the romantic, it may be laid down that these various classes possess that romantic character, to which we are, by a process of netting and tracking, slowly making our way, in rather different degrees, and a short examination of the difference will forward us not a little in the hunt.

With i. (the saints' lives) we have least to do: because by the time that romance in the full sense comes largely and clearly in view, it has for the most part separated itself off—the legend of St Eustace has become the romance of Sir Isumbras, and so forth. But the influence which it may, as has been said, have originally given must have been continually re-exerted; the romantic-dynamic suggestion of such stories as those of St Mary of Egypt, of St Margaret and the Dragon, of St Dorothea, and of scores of others, is quite unmistakable. Still, in actual result, it works rather more on drama than on narrative romance, and produces the miracle plays.

In ii. (the sagas), while a large part of their matter and even not a little of their form are strongly romantic, differences of handling and still more of temper have made some demur to their inclusion under romance, while their final ousting in their own literatures by versions of the all-conquering French romance itself is an argument on the same side. But the Volsung story, for instance, is full of what may be called "undistilled" romance—the wine is there, but it has to be passed through the still—and even in the most domestic sagas proper this characteristic is largely present.

It is somewhat less so in iii. (the *chansons de geste*), at least in the apparently older ones, though here again the comparative absence of romantic characteristics has been rather exaggerated, in consequence of the habit of paying disproportionate and even exclusive attention to the *Chanson de Roland*. There is more, that is, of romance in *Aliscans* and others of the older class, while *Amis and Amiles*, which must be of this class in time, is almost a complete romance, blending war, love and religion—*salus, venus, virtus*—in full degree.

The other four classes, the miscellaneous stories from classical, Eastern and European sources, having less corporate or national character, lend themselves with greater ease to the conditions of romantic development; but even so in different degrees. The classical stories have to drop most of their original character and allow something very different to be superinduced before they become thoroughly romantic. The greatest success of all in this way is the story of *Troilus and Cressida*. For before its development through the successive hands of Benoît de Sainte-More, Boccaccio (for we may drop Guido of the Columns as a mere middleman between Benoît and Boccaccio) and Chaucer, it has next to no classical authority of any kind except the mere names. In the various Alexandroids the element of the marvellous—the Eastern element, that is to say—similarly overpowers the classical. As for the Eastern stories themselves, they are particularly difficult of certain unravelment. The large moral division—such as *Barlaam and Josaphat*, the *Seven Wise Masters* in its various forms, &c., comes short of the strictly romantic. We do not know how much of East and how much of West there is in such things as *Flore et Blanchefleur* or even in *Huon of Bordeaux* itself. Contrariwise we ought to know, more certainly than apparently is known yet, what is the date and history of such a thing as that story of Zumurrud and Ali Shahr, which may be found partly in Lane and fully in the complete translations of the *Arabian Nights*, though not in the commoner editions, and which is evidently either copied from, or capable of serving as model to, a Western roman d'aventures itself.

We come, however, much closer to the actual norm itself—closer, in fact, than in any other place save one—in the various stories, English, French, and to a less extent German,¹ which gradually received in a loose kind of way the technical French term just used, a term not to be translated without danger. Nearly all these stories were drawn, by the astonishing centripetal tendency which made France the home of all romance between the 11th and the 13th centuries, into French forms; and in most cases no older ones survive. But it is hardly possible to doubt that in such a case, for instance, as *Havelok*, an original story of English or Scandinavian origin got itself into existence before, and perhaps long before, the French version was retransferred to English, and so in other cases. If, once more, we take our existing English *Havelok* and its sister *King Horn*, we see that the latter is a more romanced form than the former. *Havelok* is more like a *chanson de geste*—the love interest in it is very slight; while in *King Horn* it is much stronger, and the increased strength is shown by the heroine being in some forms promoted into the title. If these two be studied side by side the process of transforming the mere story into the full romance is to no small extent seen in actual

¹ Italian romance seems to have modelled itself early on French, and it is doubtful, rich as is the late crop of Spanish romances, whether we have any that deserve the name strictly and are really early.

operation. But neither exhibits in any considerable degree the element of the marvellous, or the religious element, and the love interest itself is, even in *Horn*, simple and not very dramatically or passionately worked out. In the later *roman d'aventures*, of which the 13th century was so prolific (such as, to give one example out of many, *Amadas and Idoine*), these elements appear fully, and so they do in the great Auchinleck collection in English, which, though dating well within the 14th, evidently represents the meditation and adaptation of French examples for many years earlier.

The last of our divisions, however, exhibits the whole body of romantic elements as nothing else does. It is not our business in this place to deal with the Arthurian legend generally as regards origin, contents, &c., nor, in the present division of this actual article, to look at it except for a special purpose and in connexion with and contradistinction to the other groups just surveyed. Here, however, we at last find all the elements of romance, thoroughly mixed and thoroughly at home, with the result not merely that the actual story becomes immensely popular and widely spread; not only that it receives the greatest actual development of any romantic theme; but that, in a curious fashion, it attracts to itself great numbers of practically independent stories—in not a few cases probably quite independent at first—which seem afraid to present themselves without some tacking on (it may be of the loosest and most accidental description) to the great *polycentric* cycle, the stages of which gather round Merlin, the Round Table, the Grail and the Guinevere-Lancelot-Mordred catastrophe. All the elements, let it be repeated, are here present: war, love and religion; the characteristic extension of subject in desultory adventure-chronicles; the typical rather than individual character (though the strong individuality of some of the unknown or half-known contributors sometimes surmounts this); the admixture of the marvellous, not merely though mainly as part of the religious element; the presence of the chivalrous ideal. The strong dramatic interest of the central story is rather superadded to than definitely evolved from these elements; but they are still present, just as, though more powerfully than, in the weakest of miscellaneous *romans d'aventures*.

A further step in the logical and historical exploration of romance may be taken by regarding the character-and-story classes round which it instinctively groups itself, and which from the intense community of medieval literature—the habit of medieval writers not so much to plagiarize from one another as to take up each after each the materials and the instruments which were not the property of any—is here especially observable. Prominent above everything is the world-old motive of the quest; which, world-old as it is, here acquires a predominance that it has never held before or since. The object takes pretty various, though not quite infinitely various, forms, from the rights of the disinherited heir and the hand or the favour of the heroine, to individual things which may themselves vary from the Holy Grail to so many hairs of a sultan's beard. It may be a friendly knight who is lost in adventure, or a felon knight who has to be punished for his trespasses; a spell of some kind to be laid; a monster to be exterminated; an injured virgin or lady, or an infirm potentate, to be succoured or avenged; an evil custom to be put an end to; or simply some definite adventure or exploit to be achieved. But quest of some sort there must almost certainly be if (as in *Sir Launfal*, for instance) it is but the recovery of a love forfeited by misbehaviour or mishap. It is almost a *sine qua non*—the present writer, thinking over scores, nay hundreds, of romances, cannot at the moment remember one where it is wanting in some form or another.

It will be observed that this at once provides the amplest opportunity for the desultory concatenation or congregation of incident and episode which is of the very essence of romance. Often, nay generally, the conditions, localities and other circumstances of the quest are half known, or all but unknown, to the knight, and he is sometimes

intentionally led astray, always liable to be incidentally called off by interim adventures. In many (perhaps most) cases the love interest is directly connected with the quest, though it may be in the way of hindrance as well as of furtherance or reward. The war interest always is so connected; and the religious interest commonly—almost universally in fact—is an inseparable accident. But everything leads up to, involves, eventuates in the fighting. The quest, if not always a directly warlike one, always involves war; and the endless battles have at all times, since they ceased to be the great attraction, continued to be the great obloquy of romance. It is possible no doubt that reports of tournaments and single combats with lance and sword, mace and battle-axe, may be as tedious to some people as reports of football matches certainly are to others. It is certain that the former were as satisfactory in former times to their own admirers as the latter are now. In fact the variety of incident is almost as remarkable as the sameness. And the same may be said, with even greater confidence, of the adventures between the fights in castle and church and monastery, in homestead or hermitage. The actual stories are not much more alike than those who have read large numbers of modern novels critically know to be the case with them. But the absence, save in rare cases, of the element of character, and the very small presence of that of conversation, show up the sameness that exists in the earlier case.

This same deficiency in individual character-drawing, and in the conversation which is one of its principal instruments, brings out in somewhat unfair relief some other classes of apparent sameness—the “common forms” of story and of character itself. The disinherited heir, the unfaithful or wronged wife, the wicked stepmother, the jealous or wrongly suspected lover, are just as universal in modern fiction as they are in medieval—for the simple reason that they are common if not universal in nature. But the skeleton is more obvious because it is less clothed with flesh and garments over the flesh; the texture of the canvas shows more because it is less worked upon. Some of these common forms, however, are more peculiar to medieval times; and some, though not many, allow excursions into abnormalities which, until recently, were tabooed to the modern novelist. Among the former the wickedness of the steward is remarkable, and of course not difficult to account for. The steward or seneschal of romance, with some honourable exceptions, is as wicked as the baronet of a novel, but here the explanation is not metaphysical. He was constantly left in charge in the absence of his lord and so was exposed to temptation. The extreme and almost Ephesian consolableness of the romance widow can be equally rationalized—and in fact is so in the stories themselves—by the danger of the fief being resumed or usurped in the absence of a male tenant who can maintain authority and discharge duties. While such themes as the usually ignorant incest of son with mother or the more deliberate passion of father for daughter come mostly from very popular early examples—the legend of St Gregory of the Rock or the story of Apollonius of Tyre.

The last point brings us naturally to another of considerable importance—the singular purity of the romances as a whole, if not entirely in atmosphere and situation, yet in language and in external treatment. It suited the purposes of the Protestant controversialists of the Renaissance, such as our own Ascham, to throw discredit upon work so intimately connected with Catholic ceremony and belief as the *Morte d'Arthur*; and it is certain that the knights of romance did not even take the benefit of that liberal doctrine of the *Cursor Mundi* which regards even illicit love as not mortal unless it be “with spouse or sib.” But if in the romances such love is portrayed freely, and with a certain sympathy, it is never spoken of lightly and is always punished; nor are the pictures of it ever coarsely drawn. In a very wide reading of romance the present writer does not remember more than two or three passages of romance proper

Of persons.

Characters of romance proper.

Of incident.

(that is to say before the later part of the 13th century) which could be called obscene by any fair judge. And the term would have to be somewhat strained in reference even to these. The contrast with the companion divisions of *Fabliaux* and farces is quite extraordinary; and nearly as sharp as that between Greek tragedy on the one hand and Greek comedy or satiric play on the other. It is brought out for the merely English reader in Chaucer of course, but in him it might have been studied. In the immense *corpus* of known or unknown French and English writers (the Germans are not quite so particular) it comes out with no possibility of deliberation and with unmistakable force.

The history of the forms in which romance presents itself follows a sufficiently normal and probable course. The oldest are always—save in the single case of part of the *Development.* Arthurian division, in which we probably possess none of the *actually* oldest, and in some of the division of Antiquity which had a long line of predecessors in the learned languages—the shortest. They become lengthened in a way continued and exemplified to the present moment by the tendency of writers to add sequels and episodes to their own stories, and made still more natural by the fact that these poems were in all or almost all cases *recited*. "Go on" is the most natural and not the least common as well as the most complimentary form of "Bravo!" and the reciter never seems to have said "no" to the compliment. In not a few cases—*Huon of Bordeaux*, *Ogier the Dane*, *Guy of Warwick*, are conspicuous examples—we possess the same story in various stages; and can see how poems, perhaps originally like *King Horn* of not more than a couple of thousand lines or even shorter in the 13th century, grew to thirty, forty, fifty thousand in the 15th. The transference of the story itself from verse to prose is also—save in some particular and still controverted instances—regularly traceable and part of a larger and natural literary movement. While, also naturally enough, the pieces become in time fuller of conversation (though not as yet often of conversation that advances the story or heightens its interest), of descriptive detail, &c. And in some groups (notably that of the remarkable *Amadis* division) a very great enlargement of the proportion and degradation of the character of the marvellous element appears—the wonders being no longer mystical, and magical only in the lower sense.

And so we come to the particular characteristics of the kind or kinds in individual examples. Of these the English reader has a matchless though late instance in the *Characteristics* *d'Arthur* of Malory, a book which is at once a *corpus* *examples.* and a pattern of romance in gross and in detail. The fact that it is not, as has been too often hastily or ignorantly asserted, a mere compilation, but the last of a singular series of rehandlings and redactions—conducted with extraordinary thought for the most part indistinctly traceable instinct of genius—makes it to some extent transcend any single example of older date and more isolated composition. But it displays all the best as well as some of the less good characteristics of most if not all. Of the commonest kind—the almost pure *roman d'aventures* itself—the Gareth-Beaumonts episode (for which we have no direct original, French or English, though *Lybius Disconus* and *Ipomedon* come near to it in different ways) will give a fair example; while its presentation of the later chapters of the Grail story, and the intertwined plot and continuing catastrophe of the love of Lancelot and Guinevere, altogether transcend the usual scope of romance pure and simple, and introduce almost the highest possibilities of the romantic novel. The way in which Malory or his immediate authorities have extruded the tedious wars round the "Rock of the Saxons," have dropped the awkward episode of the false Guinevere, and have restrained the uninteresting exuberance of the continental wars and the preliminary struggles with the minor kings, keeps the reader from contact with the duller sides of romance only. Of the real variety which rewards a persistent reader of the class at large it would be impossible to present even a miniature hand-index here; but something may be done

by sample, which will not be mere sample, but an integral part of the exposition. No arbitrary separation need be made between French and English; because of the intimate connexion between the two. As specially and symptomatically noteworthy the famous pair—perhaps the most famous of all—*Guy of Warwick* and *Besivis of Hampton*, should not be taken. For, with the exception of the separation of Guy and Felise in the first, and some things in the character of Josiane in the second, both are somewhat spiritless concoctions of stock matter. Far more striking than anything in either, though not consummately supported by their context, are the bold opening of *Blancandin et Forguilleuse d'amour*, where the hero begins by kissing a specially proud and prudish lady; and the fine scenes of fight with a supernatural foe at a grave to be found in *Amadis et Idoine*. Reputation and value coincide more nearly in the charming fairy story of *Parthenopex de Blois* and the Christian-Saracen love romance of *Flore* (Florie and other forms) *et Blanchefleur*. Few romances in either language, or in German, exhibit the pure adventure story better than *Christien de Troyes's Chevalier au Lyon*, especially in its English form of *Yvain and Gawain*; while the above-mentioned *Lybius Disconus* (*Le Beau Déconu*) makes a good pair with this. For originality of form and phrase as well as of spirit, if not exactly of incident, *Gawain* and the *Green Knight* stands alone; but another *Gawain* story (in French this time), *Le Chevalier aux deux épées*, though of much less force and fire, exceeds it in length without sameness of adventure. Only the poorest romances—those ridiculed by Chaucer in *Sir Thopas*—which form a small minority, lack striking individual touches, such as the picture of the tree covered with torches and carrying on its summit a heavenly child, which illuminates the huge expanse of *Durmart le Gallois*. The various forms of the *Seven Wise Masters* in different European languages show the attitude of the Western to the Eastern fiction interestingly. The beautiful romance of *Emarè* is about the best of several treatments of one of the exceptional subjects classed above—the unnatural love of father for daughter, while if we turn to German stories we find not merely in the German variants of Arthurian themes, but in others a double portion of the mystical element. French themes are constantly worked up afresh—as indeed they are all over Europe—but the Germans have the advantage of drawing upon not merely Scandinavian traditions like those which they wrought into the *Nibelungen Lied* and *Guðrun*, but others of their own. And both in these and in their dealings with French they sometimes show an amount of story-telling power which is rare in French and English. No handling of the *Tristan* and *Iseult* story can compare with Gottfried's; while the famous *Der arme Heinrich* of Hartmann von Aue (the original of Longfellow's *Golden Legend*) is one of the greatest triumphs and most charming examples of romance, displaying in almost the highest degree possible for a story of little complexity all the best characteristics of the thing.

What, then, are these characteristics? The account has now been brought to a point where a reasoned résumé of it will give as definite an answer as can be given.

Even yet we may with advantage interpose a consideration of the answer that was given to this question universally (with a few dissidents) from the Renaissance to nearly the *Summary* end of the 18th century and not infrequently since; and while it is not impossible that, in the well-attested *re-* *and fact.* volutions of critical thought and taste, it may be given again. This is that romance on the whole, and with some flashes of better things at times, is a jumble of incoherent and mostly ill-told stories, combining sameness with extravagance, outraging probability and the laws of imitative form, childish as a rule in its appeal to adventure and to the supernatural, immoral in its ethics, barbarous in its aesthetics, destitute of any philosophy, representing at its very best (though the ages of its lowest appreciation were hardly able even to consider this) a necessary stage in the education of half-civilized peoples, and embodying some interesting legends, much curious folklore and a certain amount of distorted historical evidence. On

the other hand, for the last hundred years and more, there have been some who have seen in romance almost the highest and certainly the most charming form of fictitious creation, the link between poetry and religion, the literary embodiment of men's dreams and desires, the appointed nepenthe of more sophisticated ages as it was the appointed pastime of the less sophisticated. Between these opposites there is of course room for many middle positions, but few of these will be occupied safely and inextinguishably by those who do not take heed of the following conclusions.

Romance, beyond all question, enmeshes and retains for us a vast amount of story-material to which we find little corresponding in ancient literature. It lays the foundation of modern prose fiction in such a fashion that the mere working out and building up of certain features leads to, and in fact involves, the whole structure of the modern novel (*q.v.*). It antiquates (by a sort of gradual "taking for granted") the classical assumption that love is an inferior motive, and that women, though they "may be good sometimes" are scarcely fit for the position of principal personages. It helps to institute and ensure a new unity—the unity of interest. It admits of the most extensive variety. It gives a scope to the imagination which exceeds that of any known older literary form. At its best it embodies the new or Christian morality, if not in a Pharisæic yet in a Christian fashion, and it establishes a concordat between religion and art in more ways than this. Incapable of exacter definition, inclining (a danger doubtless as well as an advantage) towards the vague, it is nevertheless comprehensible for all its vagueness, and, informal as it is, possesses its own form of beauty—and that a precious one. These characteristics were, if perceived at all by its enemies in the period above referred to, taken at their worst; they were perceived by its champions at the turn of the tide and perhaps exaggerated. From both attitudes emerged that distinction between the "classic" and the "romantic" which was referred to at the beginning of this article as requiring notice before we conclude. The crudest, but it must be remembered the most intentionally crude (for Goethe knew the limitations of his saying), is that "Classicism is health; Romanticism is disease." In a less question-begging proposition of single terms, classicism might be said to be method and romanticism energy. But in fact sharp distinctions of the kind do much more harm than good. It is true that the one tends to order, lucidity, proportion; the other to freedom, to fancy, to caprice. But the attempt to reimpose these qualities as absolutely distinguishing marks and labels on particular works is almost certain to lead to mistake and disaster, and there is more than mere irony in the person who defines romance as "Something which was written between an unknown period of the Dark Ages and the Renaissance, and which has been imitated since the later part of the 18th century." What that something really is is not well to be known except by reading more or less considerable sections of it—by exploring it like one of its own forbidden countries. But something of a sketch-map of that country has been attempted here.

To illustrate and reinforce the above, see in the first place articles on the different national literatures, especially French and Icelandic; as also the following:—

Classical or Pseudo-Classical Subjects.—APOLLONIUS OF TYRE; LONGUS; HELIODORUS; APULEIUS; TROY; THEBES; CAESAR; JULIUS; ALEXANDER THE GREAT; HERCULES; JASON; OEDIPUS; ULYSSES.

Arthurian Romance.—ARTHUR; GAWAIN; PERCEVAL; LANCELOT; MERLIN; TRISTAN; ROUND TABLE; GRAIL; and the articles on romance writers such as Malory, Wolfram von Eschenbach, Chrétien de Troyes, Gottfried of Strassburg, &c.

French Romance.—CHARLEMAGNE; GUILLAUME D'ORANGE; DOON DE MAYENCE; OGIER THE DANE; ROLAND; RENAUD DE MONTAUBAN (*Quatre fils Aymon*); HUON OF BORDEAUX; GRIART DE ROUSSILLON; AMIS ET AMILES; MACAIRE; PARTONOPEUS DE BLOIS; ROBERT THE DEVIL; FLORE AND BLANCHEFEUR; GARIN LE LOHERAIN; RAUL OF CAMBRAI; GUILLAUME DE PALERME; ADÈNES LE ROI; BENOÎT DE SAINTE-MORE, &c.

Anglo-Norman, Anglo-Danish, English Romance.—BEVIS OF HAMPTON; HORN; HAVELOK; GUY OF WARWICK; ROBIN HOOD; MAID MARIAN.

German.—NIBELUNGENLIED; ORTNIIT; DIETRICH OF BERN; WOLF-

DIETRICH; HELENBUCH; WALTHARIUS; GUDRUN; HILDEBRAND, LAY OF; RUODLIEF.

Northern.—SIGURD; WAYLAND; HAMLET; EDDA.

Spanish.—AMADIS DE GAULA.

Various.—REYNARD; ROMAN DE LA ROSE; GRISELDA and kindred stories; GENEVIÈVE OF BRABANT; GESTA ROMANORUM; BARLAAM AND JOSAPHAT; SEVEN WISE MASTERS; MAELDUNE, VOYAGE OF.

AUTHORITIES.—The first modern composition of importance on romance (putting aside the dealings of Italian critics in the 16th century with the question of romantic *v.* classical unity) is the very remarkable dialogue *De la Lecture des vieux romans* written by Chapelain in mid-17th century (ed. Feillet, Paris, 1870), which is a surprising and thoroughgoing defence of its subjects. But for long afterwards there was little save unintelligent and mostly quite ignorant depreciation. The sequence of really important serious works almost begins with Hurd's *Letters on Chivalry and Romance* (1762). In succession to this may be consulted on the general subject (which alone can be here regarded) the dissertations of Percy, Warton and Ritson; Sir Walter Scott, "Essay on Romance" in the supplement to the *Encyclopaedia Britannica* (1816-24); Dunlop, *History of Fiction* (1816, to be usefully supplemented and completed by its latest edition, 1888, with very large additions by H. Wilson); Wolf, *Allgemeine Geschichte der Romane* (Jena, 1841-50); Ward, *Catalogue of Romances in the British Museum* (vol. i. 1883, vol. ii. 1893) (the most valuable single contribution to the knowledge of the subject); G. Saintsbury, *The Flourishing of Romance and the Rise of Allegory* (Edinburgh, 1897), and its companion volumes in *Periods of European Literature* (W. P. Ker, *The Dark Ages* (1904); Snell, *The Fourteenth Century* (1899); Gregory Smith, *The Transition Period* (1900); Hannay, *The Later Renaissance* (1898)); W. P. Ker, *Eric and Romance* (1897).

ROMANCE LANGUAGES, the name generally adopted for the modern languages descended from the old Roman or Latin tongue, acted upon by inner decay or growth, by dialectic variety, and by outward influence, more or less marked, of all the foreign nations with which it came into contact.

During the middle ages the old Roman Empire or the Latin-speaking world was called Romania, its inhabitants Romani (adj. *Romanicus*), and its speech *Romānium*, Vulgar *Romancio*, Italian *Romanzo*, from *Romanice loqui*=to speak Romance; in Old French nominative *romans*, objective *roman(i)*, Modern French *roman*, "a novel," originally a composition in the vulgar tongue. In English some moderns use Romanic (like Germanic, Teutonic) instead of Romance; some say Neo-Latin, which is frequently used by Romance-speaking scholars. By successive changes Latin, a synthetical language, rich in inflexions, was transformed into several cognate analytical tongues of few inflexions, most of the old forms being replaced by separate form-words. As the literary language of the ancient Roman civilization died out, seemingly extinguished by the barbarism of the middle ages, all the forms of the old classical language being confounded in the most hopeless chaos, suddenly new, vigorous and beautiful tongues sprang forth, ruled by the most regular laws, related to, yet different from, Latin. How was this wonderful change brought about? How can chaos produce regularity? The explanation of this mystery has been given by Diez, the great founder of Romance philology. The Romance languages did not spring from literary classical Latin, but from popular Latin, which, like every living speech, had its own laws, not subject to the changing literary fashions, but only to the slow process of phonetic change and dialectic variety. It is interesting to observe that much that is handed down to us in the oldest Latin literature (notably in the vocabulary) reappears in the most recent phase of Latin—the Romance languages. Thus, a verb *nièvre*, "to snow," is known to Pacuvius, but does not again appear until the time of Venantius Fortunatus, and then with a change of conjugation—*nièvre*, while it has now a new term of life in French and Rhaeto-Romanic dialects. It is obvious that there was no break of continuity in the vulgar language, for if in the later imperial ages a verb had been formed from *mix*, *nivis*, it must have been *nivare*, or *nivare* (Fr. *neiger*). Here especially the words of Horace come true:—

"Multa renascentur, quae jam cecidere, cadentque
Quae nunc sunt in honore vocabula, si volet usus,
Quem penes arbitrium est et vires loquendi."

The present article, embracing all the Romance languages, aims at tracing on the one hand their common origin and their common development, on the other hand at pointing out the peculiarities of the individual languages and the possible explanations of the growth of these peculiarities. Their common development is mainly dealt with under LATIN LANGUAGE. The relation of the early vulgar Latin to the literary language, the spread of Latin following the spread of Roman rule, the prevalence of Latin over Oscan, Umbrian, Etruscan, and late Iberian and Gallic—all these matters concern rather the history of Latin than of the Romance languages. But we may say broadly that the language spoken throughout the Roman Empire at the time of Augustus was fairly uniform, and that naturally differentiations took place (varying according to regions) which were not, however, strongly marked, and which even tended to be obliterated in later times.

The main causes of these variations were twofold. (1) The process of Romanizing the various districts took place at epochs far remote one from the other, and between the earliest and the latest of these epochs Latin itself was modified. (2) We have the reaction on Latin of the languages of the pre-Roman populations.

Applying this first point of view, we should find that the oldest form of Latin (oldest, that is, for our present purposes) was introduced into Sardinia (238 B.C.); next comes Spain (197 B.C.), Illyria (167 B.C.), South Gaul (120 B.C.), North Gaul (50 B.C.), Raetia (15 B.C.), Dacia (A.D. 107). And we can actually trace some of the results of these differences in date, chiefly perhaps in the vocabulary and morphology of the Romance languages. When, for example, we find the dative *illis* (Ital., Fr., Rum. *lui*) missing in the Iberian peninsula, we may infer that it was unknown to the Latin introduced there, and conversely that Latin still used the ancient *cosu* (Sp. *cava*, "cava") and not the more recent *cava* (Ital. *cava*, also *domaga*, "cuma", which we only know from Lucilius, Sp. *domas*, *goma*).

We may be justified in assigning to these historic causes the beginnings of the divergence from the original uniformity. Neither active intercourse, nor the dislocations of tribes and populations brought about by the exigencies of military or colonizing enterprise, ever effected a complete fusion of these divergences. To this we must add, as a second element, ethnic considerations.

To begin with, we seem to find in Italy itself, among the Italic population in country districts, the survival of isolated forms which had been discarded by the literary language with its leveling tendencies, and in consequence also by what may be called "Average Latin" (*Durchschnittslatein*). In early Latin *d* becomes *r* before labials, e.g. *ar* *medias* occurs in Plautus; *artorsus*, *arger* from **arger* are the ancient forms. Only *arbilis* has survived as a word of the official language and because in general feeling the noun was consciously connected with the verb *baetere*, though it was soon discarded. *Arger*, under the influence of *aggerere*, *aggestus*, became *agger*, and *artorsus* was replaced by *adorus*. In Abruzz. we have *arbedidà*, "to repose," beside Sicil. *abintari* which suppose **armentare* beside *adensari*. In Abruzz. *armuri*, "to put out the fire," represents Lat. **armoris* instead of *admoris*; *arukkà* is found beside Ital. *adobare*.

All these forms are only attested in Italy, and they might by reason of their prefix be classed as Umbrian, since in Umbrian *ar* for *ad* is even commoner, cf. the place-name *Arestaffele* in Molise, which in Latin would be *ad Stabula*, save that the limitation to the cases that are in line with the Latin rule prove precisely that this is not a case of Umbrian influence, but of a preservation of ancient and popular forms. Beyond the limits of Italy *arger* has been preserved, e.g. Sp. *arzen*, and not only Ital. *argine*; further *armisarius*, "stallion," in the Lex Salica and in Rum. *armesariù*; perhaps Sp. *almuerzo*, "breakfast," for **armesero* beside Lat. *adpersus*.

In the second place we have, especially in Italy, clearly Umbro-Oscan forms. Contrary to Latin use, these two dialects, the most important in ancient Italy, have *f* between vowels from an early *bh*, *dh*, as against Latin *b*, *d*; and Umbrian, Paclignan, &c., *z*, *ð*, from an early *st*, *su*, as against Latin *s*, *z*. Thus *crepat* (in the glosses), as against Latin *crebra*, is both by right of its vowel and consonant, an Umbrian form. And with this we must compare Ital. bifolco beside Lat. *bulbucos*; Ital. *iaffiori*, "to feast," beside *tabulari*; *iafano*, "horsefly," beside Lat. *tabanus*; *bufalo*, beside Lat. *bulbulus*. Further, Neap. *Outfuro*, "October," *morfende*, "eye-teeth," Lat. *mordeite*, &c. There is a special interest in cases like the French *mandarin* beside Ital. *manfano*. What has come down to us is *manfari*, which is not Greek, its *ph* notwithstanding, but which owing to its *f* we must take to be Osco-Umbrian; while the corresponding Latin form would be **mandar*. The Latin supplies the French, the Osco-Umbrian the Italian form. As to the other

instance, Varro points to *nello* beside *villa* as rustic, and to this we must add Ital. *stegola*, Sardin. *isteva*, Sp. and Port. *esteva* ("steva for stiva"), "plough tail"; Ital. *elce*, Sardin. *elge*, Fr. *yeuse*, "holly" (**elx* for **elox*), or Ital. *pomice*, Fr. *ponce*, Sp. *pomes*, "pumice-stone" (**pomice* for *pumice*).

It must not be overlooked that the last word denotes an object found chiefly in Sicily and near Naples, that is, in the ancient seat of the Oscans. We have to be clear that we are dealing chiefly with words connected with agriculture, and it is remarkable that those of the second category spread all over the empire, while those of the first were entirely, or almost entirely, limited to Italy.

As a parallel we may cite the vocabulary of North and South Gaul, which yields a number of Gallic elements, and one may safely infer that in the first few centuries after the Roman conquest these elements were more numerous than at a later stage, and there is in fact a definite justification for this inference. The so-called Endlicher's glossary of the 5th century is a compilation, by a native of South Gaul, of Gallic words which were clearly at that time still current in the south of France. And in this we have not only *dunum*, "montem," *campiare*, "pro re dano" (Fr. *changer*); *caio*, "breialio sive bigardio" (Fr. *quai*); *nanto*, "valle," Savoy. *nà*, "stream," but also *avalio*, "poma," which was lost in later times but is preserved in its derivative *amelanche*, "medlar."

Another Gallic word recorded by ancient tradition—*legia*, "hut"—still exists to-day with this meaning in the Venetian and Raetic Alps, and moreover plays an important part in toponymy—Fr. *Arthies* from Gall. *are Tegias*, "at the huts," N. Ital. *Teeze*; but in the oldest Gallo-Romance it may have been in use as an appellative, whence we have passed into *lanque* in Basque, *leg*, "hut." The permeation of the Latin vocabulary by Gallic elements dates from the time of the contact of Gauls and Roman forces. Many of these elements—e.g. *bracce*, *camisia*—were widely used so early a stage as to have penetrated into Rumania (Rum. *îmbărcă*, "put on," *cămeșă*, "chemise"); others again have scarcely, if at all, passed beyond their ancient limits, even those that Roman literature has preserved for us. It is true that Martial says—

"Barbara de pinctis veni bascauda Britannis
Sed me jam mavult dicere Roma sibi,"

but only in France has *bachoua* been preserved up to the present, while so far no traces of *bascauda* have been established for Italy.

Glancing over the Gallic contributions to the Gallo-Romance vocabulary, we see at once that they belong to a considerable extent to the sphere of agriculture, and that among the implements mentioned it is chiefly vehicles of all kinds which have Gallic names. The record of Roman times supplies us with *benna*, *carpentum*, *currum*, *caruca*, *agredum*, *petrorium*, *rhedu*, but *currum* alone gained a firm footing; *caruca* in the form of *charrua*, "plough," survives in France, and *benna* (Fr. *banne*, Ital. *benna*) in its ancient home. Under this heading we may perhaps add *laratrum*, "gimlet," in Isidore, Fr. *larrière*, Engad. *larere*, Sp. *taladro*, Port. *trado*; Fr. *janie*, "felloe of a wheel" (Bret. Kammad); Fr. *iaranche*, Gall. *iarinca*. With *caruca* we may class *co*, "plough-share," and O. Fr. *raie*, Mod. Fr. *rayon*, "furrow," Gallic *rica* (cf. Cymr. *rych*).

A further group is formed by *cerwise*, "beer," from Gall. *cerwista*, O. Fr. *braiz*, Mod. Fr. *brai*, "malt," *brasser*, "to brew," Gall. *brace*; *lie*, "yeast." Among the names of plants Gallic *betulla* has survived wherever the tree is common. Within narrower bounds we find Fr. *if*, "yew," Gall. **yuv* (cf. Fr. *ie*); probably also **cassanus*, "oak," Fr. *chêne*, Prov. *casser*; Fr. *verne*, "alder" (cf. Ir. *fern* and the Gall. place-name Vernodubrum, "alderwater"); *beloce*, "sloe," *bullicca*, and S. Fr. *aranson*, "sloe" (Ir. *airne*). Many more names, "mari," as being in use among the Gauls as manure for soil, from the diminutive *marilla*, Fr. *marne*. An agricultural measure was called *arpenis*, Fr. *arpen*. Fields were separated by a hedge—Prov. *gorce* (cf. O. Fr. *gori*, "fence"), a hedged-round piece of land is called in French *land*, Ir. *land*. Another method of demarcation was by means of hurdles, Fr. *clate*, Piedm. *cia* (cf. Ir. *clath*); or of barricades, Fr. *combre* (whence the verbs *encombrier*, *décombrer*), which corresponds to a Gallic **comboros*. Inside the hurdles the sheep and cows were kept whose milk yielded *mégues*, "whey" (Ir. *medg*). The wood needed for the erection of fences was cut with the "wood-knife," Gall. *adabânium*, Fr. *woge*. We may notice further the group *broga*, "enclosure," "preserve," Prov. *brogo* and the diminutive *brogiolo*, Fr. *breuil*.

In north Italy we find *fruda*, "torrent" (cf. Cymr. *fruth*), which is a parallel to *na* mentioned above; also *Comar*, *dren*, "blackberry," Ir. *dren*, "thorn," and (over a large part of north Italy) *bar*, "bunch," "tuft," O. Ir. *barr*. To single out a few words, there is Prov. *ban*, "horn," Cymr. *ban*; Piedm. *vinterra*, from a word that has come down to us as Latin, but is really Gallic: *vi-terra*, "Cymr. *gywyer*, Gaelic *georgh*," "weasel" and in the Rhaeto-Rom. *ostendland carno*, "black" and Gallic "ermine," which is cognate with O.H.G. *harmo*, Mod. H.G. *hermelin*, "ermine."

¹ Cf. G. Gröber, *Archiv für lat. Lexicographie*, i. 35 ff.

² Cf. H. Zimmer Kuhn's *Zeitschr. für vergl. Sprachforschung*, 32, 230.

In this way we might amplify examples, and it should not escape notice that we have to deal chiefly with substantives, with few adjectives and hardly any verbs.¹

In precisely the same way the Spanish vocabulary must have been enriched with traces of Iberian elements. But the process of elimination took place more rapidly and thoroughly in this case, so that the number of Iberian or Celtic-Iberian words that have resisted time and change is small. On a Latin inscription from Spain we find *paramve* 'plain,' and *param* occurs in this day in this sense. As the Iberian does not know the sound *p*, the word cannot be Iberian, and must be Celtic.

In Isidore we find *baia*, "bay," which should be read *baia*, as Sp. and Port. *bahia* prove—doubtless an Iberian word, since Fr. *baie* and Ital. *baia* are forms quite recently borrowed from Spanish. This *baia* is perhaps somehow connected with the place-name Bayona. Again, the *lapides lausiae* of the Lex Metallii Vipascensis are Celtic rather than Iberian (cf. Sp. *losa*, Port. *losa*, as well as Prov. *lousa*, Piedm. *losa*). Considering our ignorance of Iberian, and the pronounced colouring of Basque and Spanish words, it is not often easy to decide on which side the indebtedness lies, when we meet with a word in Spanish and Basque whose etymology is still uncertain.

Much discussion centres round the question as to how far the pre-Romanic nations influenced the phonology of the Romans in the process of their assimilation. Opinions are strongly divergent. While G. I. Ascoli has repeatedly assumed influences of this kind on a large scale, the present writer is very sceptical.² It may be well to give the essential points.

Plautus uses *disennille* and *disennille* instead of *disendille* and *disendille*—forms imported from his native Umbria. And like the Umbrians, the Romans pronounced *nd* instead of *nd'*. Later we find this same change throughout the whole of south and central Italy, and even in Rome, whereas it is not observed in Tuscany, north Italy and other Romanic countries. We may therefore confidently assume that this is due to a reaction of the Oscan-Umbrian dialects. Similarly it is in accordance with Umbrian pronunciation to convert breathed plosives into voiced after nasals, e.g. *iuenga*=Lat. *iuvencia*; and similarly we have *cingue* in central and south Italy besides *Tusc. cinque* (*quinque*).

But even in this particular the change affects not only the regions of ancient Umbria, but also those of the Oscan and Messapians, though again it must be admitted that we do not know what the pronunciation of the ancient Messapians was. And finally, we find the Latin *d* represented in Umbrian between vowels by a sound which has a separate sign in the national alphabets and which in Latin is reproduced as *-rs*. And since the Paellian alphabet too has a sign for a modified *d*, one may perhaps assume that in these districts *d* had a specialized sound as *th*, or *r*; and this view agrees with the fact that in the dialects of central and southern Italy *d* was pronounced sometimes like *r*, sometimes like *th*. And probably this sums up all we can say with certainty.

It has always been maintained that French *u* (pronounced as German *ü*), derived from *ū*, is due to the influence of Gallic. The *u* (with modern sound) identified with the whole area of the French language except part of the Walloon, part of French Switzerland, and Piedmont, Genoa, Lombardy, the Grisons, Tirol and the northern part of the Emilia, but not Friuli, Venetia and Istria. On the other hand, the ancient *ū* became *i* in Cymric, to which *ū* must be regarded as an intermediary step, that may therefore have existed in Gallic. But in the first place we must observe that Greek writers always render the Gallic *ū* by *ou*, never by *i*; that the Romans too write *ū*, never *i*; and further, that over a large part of the area *i* came in, in consequence of the Oscan and Messapian inscriptions the combination *ct* (Tr. *nocht*, "night") is as old as Ancient Gallic. And since the preliminary stage of the Fr. *fait* from *factum*, *nuît* from *noctē*, is likewise *cti*, it is natural to suppose a relation between these facts, and all the more because the Iberian Peninsula on the one hand, and a large part of the western and central area of upper Italy on the other, show an identical process; but in Venetian, central and southern Italy *ct* became *tt*. Thirdly, nasalized vowels are in evidence chiefly in the ancient seats of the Celts—in northern and southern France, in Piedmont, Genoa, Lombardy and partly in Rhetia, also in Portugal, but not in southern Emilia. At this point again evidence from the Gallic falls completely. Finally, an attempt has been made to trace back the general characteristics of the French and the Gallo-Romanic dialects of Italy to the peculiarities of the Gallic accent. It is assumed that there was a decided stress-accent, which brought about an over-emphasis of the stressed syllable at the expense of the unaccented ones, with the result of a marked weakening of the unaccented vowels, and particularly of those following the stressed syllable. Here again we can only

say that Gallic itself affords no evidence for this assumption, and that, on the contrary, this peculiar accentuation may be due to other reasons, unknown to us. To turn to morphology, the method of enumerating—as we find it, for example, in Fr. *quatre-vingts*, &c.—would seem to be Gallic, since it is common to all the Celts.

But even if we admit certain regional variations, all these were overlaid by the "Average Latin" which presents a number of essential features uniformly over the whole area, and which differed from the literary language. These characteristics (in historical sequence) are as follows: (1) Loss of final *m* in polysyllabic words (which we find exemplified in the very oldest inscriptions); (2) loss of the *h*-sound, a loss which outside the towns was of great antiquity (cf. *anser*), and at the beginning of imperial times was fairly common; (3) loss of *n* before *s* coupled with the lengthening of the vowel, for which Varro is evidence in his alternations of *mensa* and *mesa*; (4) the assimilation of *rs* to *ss*—e.g. *sussum* from *sursum* (Ital. *suaso*, O. Fr. *sus*, Mod. Fr. *dessus*). Toward the end of the Republic *v* is lost before *u*—e.g. *vius* instead of *vius*, *ruis* instead of *ruius* (Ital. Sp. *rio*, *antius* instead of *antiquus* (Ital. *antico*). In the first century A.D. *b* became *v* between vowels, thus merging itself into the latter sound, so that in examining the Romance languages it is impossible to decide whether the original was *v* or *b*. And this change spreads in sentences to the initial *b* (as in the inscription *manduca vire lude e beni ad me*), which leads in some cases to some uncertainty in the use of *v* and *b*. And lastly, we have the case of *d* and *t*—e.g. *velus* (Ital. *vecchio*, Fr. *vieil*, Sp. *viejo*, Port. *velho*, Rom. *viechîu*) instead of *vetulus*; the reduction of *d* before vowels, of *j*, *g* before *e*, *i*, and of *s* to a single sound *j*, or rather *đ*, in consequence of which we have *durrum* (Ital. *giorno*, Fr. *jour*); *iuvencis* (Ital. *giovane*, Fr. *jeune*); *gener* (Ital. *genere*, Fr. *gendarme*); *gelosus* (Ital. *geloso*, Fr. *jaloux*), all represented by the same initial *j*.

To turn to vowels, we must first notice that, according to Varro, *ae* was pronounced *e* in the country, but that in the cities the diphthong was maintained at first, while the simple sound was only admitted during the course of the 1st century A.D. If this is an instance of an early spreading of a rustic pronunciation, we have in another case a victory for that of the bourgeoisie and aristocracy. *O* for *au* belongs to Umbrian, Volscian and vulgar Latin, which explains why Appianus Claudius Fulcher changed his name to Clodius when he deserted to the patricians and went over to the plebeians. And there is other evidence of this change of sound. But in the inscriptions of the Empire *o* for *au* is very rare, save in proper names, and the Romance languages have partly preserved the *au* to this day with little or no change (cf. Rum. *aușt*, Prov. *aușir*, Port. *ouvir* from *audire*), or only changed it to *o* at a later stage (cf. Fr. *chose*, where *ch* could only have arisen before *o*, *no*), so that one may assume that the "Average Latin" always preserved the *au*.

Then, without entering into detail, we must mention the prothesis of *i* before *st*, *sp*, *sc*, a phenomenon which arose, judging from the inscriptions, in the 2nd century A.D. We find it at the beginning of the sentence, and also within it after *co*, *no*, *so*, *no*, but not after vowels; e.g. *illa spata*, but *illas ispata*; *istare*, *istã*, but *tu istã*, &c.

Most important of all are the modifications that affect the accented vowels, which give a new look to the language as a whole. In Old Latin and even towards the end of the Republican age, vowels varied solely according to their quantity, e.g. *ã* was longer than *ã*, *ẽ* longer than *ẽ*, but the vowel sound was the same, or at any rate the difference in quality between long and short must have been quite insignificant, seeing that Cicero and Quintilian wished the word *divisio* to be avoided in speech from motives of decorum, because of the likeness in sound to *visio*. Quantity was not influenced by the length of the consonants following; *accipere* was pronounced with *ã*, *factus* with *ã*, &c. In the course of the 1st century approximately quality was differentiated in addition to quantity in all vowels except *a*—short vowels being pronounced with an open, long ones with a close, sound. The written language expresses this change by writing *ae* for *e*; *i* for *e*, *i* for *i*, *u* for *o*, *o* for *ã*. In addition there are statements of the grammarians, though they mention only the double pronunciation of *e* and *o*, not that of *i* and *u*. It was probably in the course of the 4th century that the further change took place, by which all vowels were lengthened before a long consonant, and shortened before *st*, *sp*, or more, e.g. *sistã* became *sistã* while *sumum* became *istã*. But the older quality variations were maintained so that even now *sistis* and *vistis*, or *ictum* and *ictum* did not contain the same vowel-sound, the former having a close, the latter an open, vowel. (Cf. Ital. *sete*, *vite*, Fr. *soif*, *vis*, Sp. *sed*, *vid*; or Ital. *letto* and *letto*, Fr. *loit* and *lit*.) It is at the end of the 4th century that Augustine says: "Africa aures de corruptione vocalium vel production non iudicant," and the uncertain practice of the poets in the matter of quantity points to the breaking down of the old conditions. This was not the end of the process of development; but the most important stages were already accomplished. In this, too, we are concerned with changes affecting the whole Romance region. The final *a* was taken when open *i* and close *e*, open *u* and close *o*, were reduced to one sound which may be called close *e* (or *o*). This step was not taken by the eastern regions, excepting as to *e*, and Sardinia remained completely unaffected (*v. infra*).

¹ Cf. R. Thurneysen, *Keltoromanisches* (Halle, 1888); W. Meyer-Lübke, *Einführung in die romanische Sprachwissenschaft*, p. 38 ff.

² G. I. Ascoli, *Una Lettera glottologica* (1880); *Archivio glottologico italiano*, n. 260; *Sprachwissenschaftliche Briefe* (1887); cf. H. Schuchardt, *Zeitschrift für rom. Phil.* iv. 140 and elsewhere; and Meyer-Lübke, *loc. cit.* 205 ff.

The vowel-system that developed in course of time is thus as follows:—

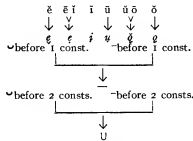

In the department of flexion we find less radical changes. The genitive was the first case to disappear. In general its functions were usurped by the preposition *de*. But for the possessive sense the dative was adopted, cf. *Hic REQUIESCUNT MEMBRA AD DUOS FRATRES*, in an inscription from Gaul. The accusative serves for the case after prepositions under all circumstances, and therefore even in places where the older language used the ablative, e.g. *magister cum suis discipulis* in a Pompeian inscription. Nouns of the third declension with monosyllabic nominative, e.g. *lens*, *straps*, *ars*, &c., form a disyllabic nominative, e.g. *lenti*, *strapsi*, &c. The dividing line between masculine and neuter, at all times doubtful, is frequently broken down, especially in the singular, e.g. *cutibus* instead of *cutibus*, and there are converse cases. The absorption of the fourth declension by the second is almost complete. In the declension of the pronouns the genitives *ipsius*, *illius*, dat. *ipsui*, *illui*, fem. *illae*, *illae*, are found in several inscriptions, but do not belong to the common language, since, as we have already said, they are not at home in the Iberian peninsula. On the other hand, all the Romance languages show that **eo* took the place of *ego*. The use of *ille* as personal pronoun, and also of *ipse*, and of both these forms as articles, dates from ancient times. We find a parallel to the weakening of the demonstratives in the amalgamation of the pronominal combinations to be found as early as Plautus with *ecce*, *ecum*, which results in new forms, e.g. *eccellie* (C. F. C), Mod. Fr. *celui*) or *ecculle* (Ital. *quegli*, Sp. *aquel*); *eccellie* (Fr. *ce* (f)); *ecculle* (Ital. *questo*, Sp. *aqueste*). In the verb-system, a characteristic change is the disappearance of the future and passive forms, the explanation of the phenomenon in both cases being psychological rather than formal. Popular language is not familiar with the future, and replaces it by the present—or, more strictly speaking, the vulgar person deals only with the present or the past. The case of the passive is similar. The transposition of active into passive is too complicated a process for the simple mind. The object of the action remains the object; when the subject of the action is not known, they resorted to the indefinite third person plural, e.g. *vendunt casum* is the popular mode of expressing *domus venditur*. And further, the perfect *amatus sum* was replaced by *amatus fui*, since *fui* was a perfect and could now take over the function of a present. For the moment, all other tenses and moods of the verb were preserved, only of the infinite forms, the gerundive, perfect infinitive and the two supines disappeared. Of the gerund nothing remained but the ablative. In compensation, however, we soon find a form *habere cantatum* springing up beside *cantavi* in use as perfect, e.g. *liberos scriptas habeo* meant in the first instance, "I possess written letters," with nothing implied as to who wrote the letters; but later this usage is limited to cases where the owner is also the originator of the state of things expressed in the participle, and thus it attains to the force of a perfect.

There is little change in the formation of individual verb-forms. It is natural that the infinitives *esse*, *velle*, *posse*, being exceptional, should have been brought into line with all the rest. This was done by simply adding *-re* on to *esse* (Ital. *essere*, Fr. *être*), while the other two were constructed from the forms of the verb whose ending was accented, or from the perfect, e.g. *volobam*, *potobam*, *potui*, gave rise to **volere*, **potere*, on the analogy of *docobam*, *docui*, *docuim*, *docuim*, *docui*, *docui*, &c. (cf. Ital. *vollere*, *potere*, Fr. *vouloir*, *possouvoir*, Sp. and Port. *podere*, *verea*, *putea*). In other infinitives there is much confusion, especially as between *-ere*, and *-ere* verbs, noticed by the Latin grammarians themselves; we have evidence, too, that at an early stage the present forms in *-io*, *-iam* led to a confusion of the *-ire* and *-ere* conjugation, e.g. Plautus has *morire* (Ital. *morire*, Fr. *mourir*, Sp. *morir*, Rum. *muri*); Lucretius has *cupire*; Cato has *fidere*, &c. For the rest we may note as important that perfect-forms without *u-*, such as *astit*, *astit*, *arunt*, inflected the first person singular, e.g. *-it* instead of *-astit*. A new type in *-idi* arose on the model of *venidi*, and then affected other verbs in *-edere*, e.g. *descendidi* (in Gellic), *prehendi* (in the grammarian Probus) and in general verbs of the third conjugation. But its spread was slow, so that it can scarcely be said to have been common to all the languages.

In the formation of words the popular language probably had far greater freedom than the written language. We find not only a marked preference for diminutives in *-ulus* and *-illus*, but many other types are established, or new ones created. And as the chief ones

we must mention the post-verbalia (nouns constructed out of verbs). Thus *pujanare*, being itself derived from *pujanum*, then produces *pujna* (on the pattern of *planta*, *plantare*), and these formations soon became extremely common, and not only in *a-* verbs, but also in *ere*-verbs, cf. in particular *dolus*, "grief" (not to be confused with the ancient *dolus*, "craft"), C.I.L. x. 4510 (Rum. dor. Ital. *dulo*, Fr. *doulo*, Sp. *duelo*). We can exemplify other types with the *ardere* and *arsura* which we can trace back to *ardura* = contamination of *ardor* and *arsura*, which extended to *ferura*; also to *strictura* beside *strictus*; *directura* beside *directus*, when the old participles had separated both in form and in meaning from the verbal-system and had become adjectives, whose *t* was felt to be part of the stem. Another feature of the verb is the gradual retreat of old simple formations in favour of derivatives from the participle, e.g. *cantare*, *adjutare*, *ausare*, &c., in place of *canere*, *adjuvare*, *audere*; then for denominatives *-icare* and the Gr. *-izare* (Ital. *-eggiare*, Fr. *-oyer*, Sp. *-ear*) which, coming in with Christianity, was soon added on to Latin stems, e.g. (in Fulgentius) *citharizantium* *aut* *sozzantium*.

Among points of syntax we may single out the replacing of infinitival sentences (following verbs of feeling, seeing, hearing, wishing) by clauses with *ut*, *quod* or *quia*, whence Ital. *che*, Fr. *que*. The latter particle spread most rapidly, and soon took precedence over the other conjunctions, not only in the cases just mentioned, but in introducing object-, subject-and final-clauses.

It is in the vocabulary that it is most difficult to define the relations of the common and the literary language. So much of the Latin vocabulary as appears over the whole Romance area comes of course from the everyday language which was used from the mouth of the Ebro to that of the Danube, but it is by no means all. It is more interesting to inquire whether anything can be reconstructed from Romance, and if so, how much. The existence of a form *aiutare*, for example, mentioned above (Ital. *ajutare*, Fr. *aider*, Sp. *ayudar*, Rum. *aiuda*) and appearing in all the Romance languages, is indisputable. Between Fr. *grolle* ("crow"), Lyon. *grôla*, Gascon. *agrasulo*, Tirol. *grola*, and (with change of gender) Apul. *rasulo*, Rum. *grasar*, the connexion, both in form and meaning, is so close that one is led to assume a common base for all these words. This basis is **graulus*, *-a*, and it is safe to assume that such a word goes back to Latin, though remembering that it was not found in the western regions. Rum. *afid*, Sic. *asciari*, Sp. *hallar*, Port. *achar*, Griss. *afiar*, Dalm. *afjar*, "to find," all point to *afflare*, and in this case, too, the change in meaning may be safely attributed to Latin. This *afflare* in fact Gaul is only included in Rum. *aripâ*, Fr. *aube*, Prov. *aubo*, Sp. *alabe*, "paddle-board," in Rum. meaning also "wing" and in Sp. also "the wickerwork on both sides of a vehicle." In Port. "the wing of a parapet," point to a form **alapa*, which meant "wing" and which must have belonged to the vulgar language, even though no trace of it survives in Italy. Many other points could be enumerated, but problems are involved which have as yet hardly been taken up.¹

In dealing with the division of this common language into a number of individual languages there are still further points of view to be considered. Before we can touch upon these, we must first take general survey of these languages. There are altogether nine—Rumanian, Dalmatian, Sardinian, Italian, Raeto-Romanic, French, Provençal, Spanish and Portuguese. Of these nine languages, Dalmatian is now extinct, and even what we learn of it from the ancients is very meagre. On the one hand, Ragusa and the plains of Dalmatia never attained the degree of independence in literature which would have brought about a *floruit* in the language such as Provençal has to show. Neither, on the other hand, was its political independence stable enough, nor was it sufficiently remote to escape intercourse with the rest of the world, like the Raeto-Romanic dialects. The hordes of Slavs pressing forward from the inner regions of the *hinterland* soon put an end to the Romanic civilization, first in the country and then in the towns. And when the Venetians, who were, both in point of culture and of commerce and of politics, on a higher level, regained their power over the Dalmatians by occasional conquests, chiefly over the cities, the result was of course all in favour of the Venetian dialect. On the island of Veglia alone there were still living about the middle of the 19th century a few people who still spoke Old Dalmatian. The last of these is now dead. Our approximate notions of this language are gleaned from the speech of these natives of Veglia, from a few more ancient notes, place-names, proper names and from the Romance element of the Servo-Croatian dialect of Ragusa? We may begin by reducing these nine languages to seven groups—Dacian, Dalmatian, Sardinian, Italic, Raetic, Gallic and Iberian. The most striking peculiarity of the first three of these groups is the absence of Germanic words in the vocabulary. In other words, they were withdrawn from the influence of the general "Average-Latin" before the beginning of the more decided permeation of Latin by Germanic elements. There are other signs of their antiquity. In Central Sardinian *c* before *e*, *i*, and

¹ Cf. G. Gröber, *Archiv. f. lat. Lexicographie*, i. 204 ff.

² Cf. M. G. Bartoli, "Das Dalmatische" (1906), (*Schriften der Balkan-Kommission der K. Akademie der Wissenschaften*, linguistische Abteilung, Bd. iv. and v.).

in Dalmatian *c* before *e* are always preserved as velars, and in south Sardinian and in Rumanian the palatalization is more recent, and secondary. The preservation of the tenues between vowels as breathed fortes is peculiar to Rumano-Dalmatian, but as north Sardinian used breathed lenes in their place, while the dialect of Nuoro, in Sardinia, preserves the tenues as the primary ground for assuming that central and south Sardinia also possessed either fortes or lenes in earlier times. Moreover, south Italy, Sicily and a large part of central Italy as far as the Apennines replace the old Latin tenues either with breathed fortes or breathed lenes, in marked contrast to the regions of the Po, to Gallic and the Iberian group. All these phenomena may perhaps be explained in conjunction with two historical events. By the abandonment of the province of Dacia (in A.D. 270), Rumanian lost its close touch with the languages of nearest affinity; and the division of the empire into Diocletian and Constantine necessarily entailed a linguistic division. At that epoch the linguistic conditions were roughly as follows:—

The principal changes in the vowel-system, especially the development of qualitative beside quantitative variations, had been accomplished, but there was still a difference between *i* and *e*, *u* and *o*. The old future had disappeared, and no tendency to produce a substitute had as yet appeared. The Latin pluperfect subjunctive still maintained its old usage, probably also the imperfect subjunctive, and the perfect subjunctive, the declension *-mbrum*, *-m*, had begun to spread; but *corpus*, *-ora*, was still in existence. Sardinia seems to have been, perhaps owing to its isolation, the first to have detached itself from this group. For it was not content with differentiating *e* and *i*, but it also retains *-s*, whereas the East-Rumanian and an Italian group suppressed *-s*, and in consequence also the difference between the nominative and the accusative singular. This and the leveling of neuters in *-us* and masculines in *-u* made it possible for the types *membra* and *corpora* to spread at the expense of the type *loci*—a possibility of which South Italian and Rumanian made the fullest use.

On the given basis the various languages carried on their various developments, influenced partly by contiguity of other idioms, partly by causes unknown to us. Among neighbouring idioms, Greek had by right of its degree of civilization and its political power great influence in giving Rumanian and South Italian a similar direction, and that at a time when every trace of a geographical connexion between these two language-groups had long vanished. In the replacing of the construction *illu* with *illu* by *illu* will that we may look into the rise of Greek and was passed on to Rumanian and Apulia. The rise of the new future *poŭ cantă*, "I will sing," in Rumanian is probably due to Greek influence. In Latin itself both *ille caballus* and *caballus ille* are found, the position depending on the accentual conditions of the sentence. Then the loss of *s* made room for the form *caball[u] ille* with a victory for the inverted order. In Rumania alone *illu* was the actual process, under the influence of the surrounding speech—Illyrian or Bulgarian, or perhaps independently of them, in this latter case serving as a prototype to these languages. Dalmatian and South Italian, on the other hand, were so closely connected with the languages that preserved *s* and therefore prefixed the article that in this particular they separated from Rumanian. This is not the place to show how the Rumanian vocabulary and the structure of words was permeated markedly by elements from Slav, less markedly by elements from Turkish, Mod. Greek and Hungarian, which gave the language an alien appearance in point of vocabulary.

In consonants, and, as far as one can judge, in its morphology, Dalmatian has preserved the stamp of antiquity. But in its vowel-system there are marked changes, especially in the substitution of diphthongs for close vowels, *e*, *e* changing a to *e*, *u* through the *u* stage to *oi*, *i* to *ei*, *o* to *ou*, *e* to *ai*. Diphthongs such as they appear also in Istrian and Abruzzian, so that we must presuppose some sort of connexion.

It may be that Sardinian took another course of development because (A.D. 458) the island was rent from Rome and incorporated in the African empire of Genseric, king of the Vandals. Therefore the sympathies of Sardinia were alienated from Italy, and turned on the one hand towards Africa (and unfortunately we have no information as to the "latinity" of this region), on the other towards the Iberian peninsula. These conditions lasted for a while, but later we find Genoa and Pisa fighting at intervals for supremacy in Sardinia, their organization being in many points identical with that of the island. On the whole, this new combination has not materially affected the language, especially in Logodoro. The vowel-system of greatest antiquity, and the most archaic pronunciation of *c* before *e*, *i*, remained unchanged, neither did they attempt as to adopt the future-forms current on the mainland; on the contrary, the Sardinians arrived independently and later at their usage of *depo cantare* or *haia a cantar*. But the use of *ipse* as an article in Sardinia, Mallorca, and in the earliest times also in the Catalanian-Gascon area, clearly proves the linguistic connexion which for a time covered this area, and we may also see some connexion in the fact that the lenes became voiced between vowels. On the whole, and in spite of everything, Sardinian is the most archaic of the

Romance languages. Owing to its retaining *s*, it has failed to extend the *membra-tempora* types of formation, indeed it has almost rejected them entirely. It has retained the imperfect subjunctive to this day, and as a corollary it has lost the pluperfect of that mood. And though every Romance language has a number of Latin words that are not common to the rest, yet in this language the number of these *frases* is very great, more than in others, and especially worthy that these have here survived such common expressions as *domo*, "house," *manu*, "great," with other examples.

The East-Rumanian group (coupled with Sardinia) finds its counterpart in the great group based upon the Latinity of Gaul, the Iberian peninsula, and north Italy. This group contains a considerable number of fundamental peculiarities in phonology, morphology and vocabulary which prima facie lead us to assume a fairly long period of contact.

The chief of these peculiarities is the final change of the vowel-system, *i*, the loss of the distinction between *e* and *i*, between *o* and *u*; then the change of breathed plosives and fricatives between vowels into voiced plosives and fricatives respectively; the use of the pluperfect subjunctive instead of the lost imperfect subjunctive (Ital. *cantasse*, Fr. *que je cantasse*, Sp. *cantasse*, Port. *cantasse*), the formation of a new future from the infinitive of the verb and the present, or (as the case may be) the imperfect or perfect of *habere*, *e.g.* Ital. *cantere*, *canterei*, Fr. *je chanterai*, *chanterais*; Sp. *cantaré*, *cantaría*; Port. *cantarei*, *cantaria*. It is safe to assume that this latter formation had its origin in places where we find it most firmly rooted, we are led to assign it to the north of France. For it is only there that both elements in the formation are inseparably connected from the beginning of our record. In the old Provengal the two constituent parts are still separable; in the oldest Spanish and Portuguese their position is not fixed (*i.e.* the auxiliary may follow or precede the verb). In north Italy we frequently find the form *avò cantare* instead of *cantare*, obviously because this formation is not properly acclimatized. But at any rate it is clear that the change of function from *cantare habeo* to *cantabo* belongs to the time when the three great groups were still in close contact, and the evidence of the Latin texts falls into line with this view, showing this construction well established from the second half of the 4th century.¹ In the vocabulary we must note, among other things, the introduction of Germanic words, *e.g.* *elmo*, Fr. *heaume*, Sp. *yelmo*, "helmet"; *harpa*, "harp," Ital. *arpa*, Fr. *harpe*, Sp. and Port. *arpa*; *medus*, "meed," which is found in Antimus and Isidore, but disappears later (cf. Fr. *medes*, "meed"); *বাদیان*, Ital. *guadagnare*, Fr. *gagner*, Sp. *guadagnar*, "to win."

The further steps in the process of differentiation were conditioned by the breaking up of the Roman empire by the great migrations. The establishment of the rule of the Franks in north Gaul, of the Visigoths in south Gaul and the Iberian peninsula, loosened old ties, created new nations and in consequence new and independent groups of languages.

The Iberian group was marked primarily by a striking simplicity in its flexions. The three-case system was given up at an early stage, even in prehistoric times, and has left no traces whatever. Owing to the preservation of *-s* the type *membra* was doomed to perish, and thus we find, from the beginning of our record and therefore presumably soon after the great cleavage took place, the prevalence in nouns of the following simple rule: sing. *-e*, *-o*, *-a*; plur. *-es*, *-os*, *-as*. The loss of the dative may have some connexion with the fact that the form *illui* for the 3rd personal pronoun had not yet established itself; and the desire for uniformity may have ousted the nominative of *o*-stems. There are *quæres* (*quæres*), *instans*, *vellus*; *quæres* (*quæres*) instead of *manere*, *collas* (deris), *uncerunt* for *facere*, *hablar* (*jabular*), "to speak"; *llegar* (*plicare*), "to arrive"; *dejar* (?) instead of *laare*, &c. Further, we may mention the preference of *tenere* to *habere* even for the formation of perfect-forms, of which examples are to be found in Orosius, and of *magis* to *plus* for expressing comparisons, for which also we may find examples in Latin authors or the Iberian peninsula. The influence of the Goths or Suevi and Vandals on the vocabulary is inconsiderable, and when we trace it is not easy to explain; *e.g.* Galician *lancu*, "lark," is clearly from Gothic, but in Gal. *lauser*, but it is difficult to see why the name for this bird should have been supplied by the Germanic. To sum up, one may say that the Latin of Iberia was a self-contained language, at first showing little modification by influences from Iberian, or later by those from Germanic; further, that its development was slow, and that it aimed at simplicity.

At the present day there are three great groups, running almost

¹ See Thielmann, in *Archiv f. lat. Lexikogr.* ii. 48 seq.

parallel from N.E. to S.W., e.g. Catalanian on the coast of the Mediterranean, akin to Provençal, Spanish in the centre, Galician-Portuguese on the Atlantic. From the historical point of view one part might be called Gothic-Romance, the other Suevo-Romance. But the national and linguistic history of the times and countries we are dealing with is still very obscure. The difference between the two idioms is chiefly one of phonetics, while in their morphology and vocabulary they do not greatly differ. Spanish may be described as a language which favours vowels at the expense of consonants, and which therefore shows, more than other Romance languages, a weakening even of initial consonants. It changes voiced stops first to fricatives, then to mere noises or "burrs" which finally disappear altogether, and *s* before a consonant or finally, becomes *h* (through a middle stage *ʃ*) and is finally lost. The preferential treatment of vowels, however, entailed not a single change except that *ē* was changed to the diphthong *ie*, *o* to *ue*; all else were preserved, e.g. *dies* (*decem*), *tempo* (*tempus*), *bueno* (*bonus*), *fuerte* (*fortis*); but *hacer* (*habere*), *hid* (*tielo*), *corona* (*corona*), *hama* (*hamsus*). The weakness of the initial sound is shown in *clero* (*januarius*), *hazer* (*facere*), *llamar* (*clamare*) with a transitional **clyamar*, *llaga* (*plaga*), &c. The written language has no sign for voiced plosives between vowels, but *-atho* or *-ao* is spread over nearly the whole region.

In contrast to Spanish, Portuguese has a strong pronunciation of initial sounds, and so does not go beyond *janairo*, *facero*, and changes *cl* (with transitional form *clj*, *ky*), and also *pl* (via *ply*, *py*) to *ch*, e.g. *chamar*, *chaga*. On the other hand, it has a careless articulation of vowels and consonants, and consequently no diphthongs. The unaccented vowels are weakened to the final sound is shown in *claro*. It shows further a fusion of nasals with the preceding vowel, so as to form a nasal vowel, and this new nasality takes the colour of the preceding vowel, e.g. *vina* becomes *vinho*, but *una* becomes *uma*, otherwise before a vowel the nasal finally disappears; *cheio* and *cheia*, from *plenus*, *plena*. Similarly *l* was lost between vowels, e.g. *ceo* (*caelum*); before consonants it became *l*, or *u*, e.g. *outro* (*alter*), *caído* (*caidū*). Voiced plosives have a weak pronunciation between vowels, and these are sometimes made fricatives. In relation to the somewhat careless articulation we note a marked loss of the final vowel in the final vowel (*e*, *o* now has a close vowel, *noza* an open one), and also by the following consonants: *l* velarizes, *s* palatalizes preceding sounds, hence *estās* pronounced *istas*, "thou art," with reduced *i*, but *devedor* (*debitor*), "debtor," with reduced *e*. Lastly, the division between words is not sharp—the interaction of initial sounds and finals being very striking. *Devedor* has a plosive *d*, a *devedor* has a fricative; *istas* has a breathed *-s*, but *istas nos ceus*, "thou art in heaven," has a voiced *-s*; *seja*, "be," has a reduced *a*; *o nome* is pronounced *u nome*, but *seja o nome* is pronounced *sej o nome*, with an open *o* from *a+o*, &c.

The separation of Gaul took place likewise in the half of the 5th century, when the Visigoths had settled down in the south, the Burgundians in the east, and the Franks in the north. The type of language that was evolved here is distinct from Spanish primarily and principally in the loss of final vowels except *a*, or, when the formation of the word was incompatible with this loss, in a weakening to *e*. On the other hand, the declension is strongly conservative. Nowhere are the old case-endings so clearly preserved as in this region, e.g. *reis*, "king," but *la rei fille* (*regi filia*), "the king's daughter"; *veit le rei*, "videt regem"; *danet le rei*, "donat dno regi"; these are the modes of expression, and they last till far into the literary period. But at an early stage there was a breach between the Franks of the north and the Burgundians of the east on the one hand, and the Visigoths of the south on the other. For while the latter (the Visigoths) retained the old system of accented vowels, the former changed *ē* to a diphthong *ie*, *ō* became *uo*, *ue*, and moreover *ē* and *ī* became *ei*, *ō* and *ū* became *ou*; *a* was changed to *ā*, assuming that these vowels were long in accordance with the later Latin pronunciation, e.g.—

Lat. <i>debere</i>	<i>nepote</i>	<i>pede</i>	<i>mola</i>	<i>pratu</i>
North Fr. <i>devoir</i>	<i>nevet</i>	<i>piet</i>	<i>mole</i>	<i>prat</i>
South Fr. <i>dever</i>	<i>nebot</i>	<i>pe</i>	<i>mole</i>	<i>prat</i>

The northern group, moreover, weakened the consonants still further. *D* and *g*, secondary consonants from *t* and *c*, disappear like the primary ones, and thus *prællus* becomes *preau*, *S. Fr. pradeli*; *advocatus* becomes *avoué*, *S. Fr. avogal*; a secondary *p* (from *b*) becomes *r*, as we see by the form which replaces *nepos* above. If we are right in ascribing this to the effort to stress the accented vowel at the expense of the other constituents of the word, we may take this to be connected with the weakening of *a* where final, and between two accented syllables, e.g. *N. Fr. arme* from *arma* as against *S. Fr. armé* or in one case *armeur* (Mod. Fr. *armure*), in the other *armadura*, from *armatura*.

Parallel to the preservation of *-r* on the one hand, and the close following of the old flexions on the other, we find the type *membra* preserved at first, though not spreading, whereas the *tempora*-type is abandoned. In the verb the variety in Latin perfect forms is still fairly well preserved, though there is a distinct extension of the *u*-perfect and the *dedi*-perfect. As we might expect, the vocabulary seems to be strongly coloured by Germanic elements of Frankish, Burgundian and Gothic origin.

The Raetic dialects, in their prehistoric phase, are less clear than others. Their contact, at an age nearing the Carolingian, with the French of the south-east in Valais seems to have caused a similar process of growth, especially as they change *e* and *o* into the diphthongs *ei* and *ou*, leaving at the same time the consonants more intact. At an early stage the inroads of the migrating nations cut off Raetia from the Po valley, and the pressure of the German tribes severed its union with the Romance-speaking nations of the west. The isolated words that follow its own course. This language also preserved at first the three cases and the type *membra*, the latter being developed later freely in use as a collective plural. But its further development was checked by the Lombards and Venetians.

But the most difficult problems are those that arise in Italy. Though one may say generally that the dialects of the region of the Po, and those of Liguria, belong to the types of north and western Romance, that is to say that the breathed plosives between vowels became voiced, yet they approach the typically Italian groups by their vowels. This means that when the whole Italian peninsula was separated from Gaul as well as from Iberia (after the close of the 5th century) and became again one homogeneous whole, the forms without *s* found their way into the north of Italy only slowly, so that *s* has remained in the west, i.e. in Piedmont, in monosyllabic words to this day, e.g. *as*, "thou hast," *ses*, "thou art"; the same rule prevailed in older times in the east, in Venice, and there the *s* was also preserved (in questions) in polysyllabic words, e.g. *venis-tu*, "comest thou?"; and the old form maintained itself in Milanese in the single form *sistis*, "art thou?" To the loss of *s* we owe the distinction of *de* and *des*, but as its action began to take effect later, the *membra*-type gained little footing, the *tempora*-type none at all. In the vocabulary the Lombard elements are numerous, extending, like the supremacy of the Lombards, over the whole peninsula. It may be that *s* was lost under the influence of central Italy acting on the north. If so, we may surmise that a similar influence has changed *cl*, *pl*, and *ʃ* to *chi*, *pi*, *ʃi* (*chiamare*, *pianta*, *flamma*). For it is precisely this point that differentiates both the Raetic dialects and Provençal from the contiguous Italian dialects, and the change certainly took place only after the latter were completely detached. On the other hand the Italian vocabulary has been strongly influenced by the north, especially in Tuscan.

The rise and development of the Romance languages, in its large outline, appeals to the imagination as a vast historical phenomenon closely bound up with the fate of nations. One other element must not be overlooked on which we have touched more than once in the above sketch, for it bears so directly on the Romance vocabulary as to deserve the tribute of a general survey: this is the Germanic.

The mercenaries of Germanic origin pervaded the Roman army. Germanic words (often their roots) first entered the languages of the camp, and thence into the vulgar language generally. And at that stage perhaps many words may actually have been imported which were, partly at any rate, lost again later. Roman and Greek authors admit a considerable number of Germanic words, including terms belonging to warfare, e.g. *bandum*, "standard," used by Procopius, which still continues in the form of *O. Fr. ban*, *Ital. bandiera*, *Sp. bandera*, &c. *Brutis*, "bride," "daughter-in-law," which occurs frequently in inscriptions, may date from the period of camp life, but for the rest it is retained only in *Fr. brut*, "rich," and *Dalmatian*. On the other hand, *compagnio* is clearly a Latinization of Gothic *ga-hafla*, the meaning of which carries us back to the same sphere. Other old words express ideas of culture, or names of animals which the Romans learned to know in the German-speaking north, e.g. *ganta*, "wild goose" (in Pliny), *O. Fr. ganle*, *Prov. ganla*; or *lazo*, "badger," *Ital. lassone*, *Fr. laisson*, *Sp. lejon*. But the impression made was not pronounced until the age of the Germanic invasions, and then we find a great variety in the various Romance countries. In Italy we have two invasions to consider—by the Goths, and by the Lombards. But the destruction of the rule of the Lombards by Charlemagne, and the introduction of Frankish elements consequent upon it, should not be considered under the same head, since these Franks may themselves have been a Romance-speaking tribe. Goths as well as Lombards have left a trail as noticeable in the language as elsewhere. Thus we find in several instances some uncertainty as between *b* and *p* as an initial sound in Italian words borrowed from Germanic, e.g. *banca* and *panca*, *balla* and *palla*, the forms with *b* being Gothic, those with *p* Lombardic. Or again *recare*, "to bring up," goes back to Gothic *rikan*, "heap up," in *Fr. recare*, "rich," and to Lomb. *rīhō*, &c. We have the vocabulary so thoroughly Germanic in the case of the nationalities, the Lombards have left their stamp unmistakably on the proper names. Speaking generally, Italy as well as the other Romance countries follows the rule that medieval names of persons are either "Christian" (in the strict sense) and therefore of Hebrew or Graeco-Roman origin, or on the other hand Germanic. Roman names that are not also Christian seem to have survived only in south Italy in any great number, while on the contrary the Germanic are not represented at all in Dalmatia. One of the characteristics

of Gothic is the change of *z* to *i*, so that it has names ending in *-mir*. Of these we find no trace whatever in Italy, on the contrary we find *Gundimar*, *Idmar*, &c. Then we have abbreviated forms in *izzo*, e.g. *Gaudizzo*, *Albizzo*, &c., which are distinctly Lombardic; but not Gothic ones in *-ila*. There is no parallel to all this in the Iberian peninsula. As we have already said, the Gothic contribution to the vocabulary is very slight. But on the other hand in the 11th century the great majority of proper names is Gothic; e.g. *Aljonus*, *(Hadd)fonus*, *Gasimirus*, *Scimitrus*, &c.; or *Recila*, *Fafila*, or *Elvira*, O. Port. *Gelvira*, Goth. *Gatalvira*, and scores of others, all proving the great influence of Gothic.

And lastly, France possesses the largest number of Germanic elements in its vocabulary, Gothic in the south, Frankish in the north (though it is often impossible to ascertain to which class they belong). But beside these there are many Old High German words, and again Anglo-Saxon and northern ones, more particularly those connected with shipping and the sea. These Germanic elements cover nearly all branches of human activity. Thus *bât*, Fr. *bâtir*, "to build", from **bastyann*, "to bind together with bast," "to plait"; *hourder*, "to cover with boards," from *hurdi*, "hurdle, margin," *Isidore magis* (Frankish rather than Gothic) referred to house-building; *broder* from **brodraz*, *broder* from **brudanz*, point to the occupations of women, and *danser* from *dinsan* and O. Fr. *treschier*, "to dance," from *treskan*, "to thresh," to their amusements. Women's work is probably denoted further in *rouir*, *rotjan*, and E. Frank. *naissier*, *natjan*, "to net"; the same remark applies to the dyeing of cloths (Fr. *lousille*, Engl. "towel," from *lthwילה*), and ribbons (*bande* from *binda*) with *gude*, "woad," and other colouring matters, whence we have, e.g. *brun*, *bleu*, *blond*, *blanc*.

But while the vocabulary has been with its accretions drawn from various races, the proper names show the same rules as in Italian, i.e. Frankish gains the sole supremacy. We find, it must be admitted, some names of Gothic origin in the Romance period, but these were not maintained as late as the Romance period, such was the influence of the victorious northern race.

Even after political and literary independence had enabled the individual Romance languages to grow as separate units on their own basis, they retained their interconnection and were open to mutual influence. But this influence is only partial, i.e. it affects nothing but the vocabulary, and has a certain relation to various tendencies in the developments of civilization. And under this head the most important point is the really enormous influence which France (both south and north) has exercised on the Romance world, just as she has on the Germanic world, an influence which has hitherto not been duly recognized. The first traces go back to the invasions of Charlemagne already mentioned. To instance only one, we have *schavino*, "justice, alderman," which cannot be derived directly from the Germanic, as is shown by the *v*. The second important period is the age of chivalry and the literary tendencies centring round it. A word like *budriere*, "baldrick," is derived from Fr. *baudrier*, not directly from Germanic *Baldreich*; Ital. *banda* goes back to O. Fr. *bande*, and this again to *binda*; Ital. *gallo* is not from *galbinus* but from O. Fr. *jaline* (Mod. Fr. *jaune*), derived from that word, &c. But it seems that in one of the prehistoric periods the Tuscan vocabulary was strongly affected by that of the Gallo-Romanic. Whereas in the Iberian peninsula, in Sardinia, in south Italy, Rumania and Rhaetia *dies* survives, in O. Fr. *di* has been almost completely ousted by *jour*, but in Tuscan and the Italian literary language we find *giorno* and *di* side by side. Thus *trouver*, Prov. *trobar*, spreading from France into Italy, drove the old *affrare* more and more back towards the south. The most recent layer was introduced during the reign of the house of Anjou chiefly in south Italy and Sicily, and kept its hold to the present day in spite of the Sicilian Vespers, e.g. *Sicuzzeri*, "butcher," from *fr*, the form of the Germanic **sax*.

The Iberian peninsula can likewise bear witness as to French influence, e.g. O. Sp. *fonta*, "shame," is not from Goth. **haunitha*, but from Fr. *honte*; O. Port. *saluar* not from Lat. *salutare*, but O. Fr. *saluer*. On the whole, Portuguese seems to possess more of these Gallicisms than Spanish, history supplying a simple explanation.

Italy too yielded its contributions, especially in the 15th and 16th centuries, many military terms (noble and ignoble), e.g. French *carogne* and *canaille*; *poignard*, "dagger," from Ital. *pugnale*, instead of Fr. *poignee*; *panache*, "plume," from Ital. *penacchia*, and many others that have become common property. But the influence of the Iberian peninsula on the contrary was not so strong as to be more than sporadic; the Sicilian and Neapolitan vocabularies alone are more closely akin to Spanish, and this is easily explained on the ground of their political and commercial relations.

As to the Romance languages beyond Europe we have but little to say. There is a distinction to be made between Creole and genuine Romance. Belonging to the latter we have the French of Canada, the Spanish of Central and South America, the Portuguese of the Brazils. Speaking generally we may say that the particular language which has formed the language in the 16th and 17th centuries, that is to say that of the time of the immigration, and that they developed along the lines already established.

This in Mexican Spanish the loss of *d*, *g*, between vowels, of *s* before consonants and as a final, has been carried further than in the mother-country. There are no proved traces of any noticeable influence from the languages of the natives.

LITERATURE.—The real founder of scientific Romance philology and linguistics is Friedrich Diez, in his *Grammatik der romanischen Sprachen* (3 vols., Bonn, 1836-42), and *Etymologisches Wörterbuch der romanischen Sprachen* (2 vols., 1852). All questions concerning Romance philology and the historic grammar of the different Romance languages are treated in G. Gröber's *Grundriss der romanischen Philologie* (2nd ed., Strassburg, 1906), and in W. Meyer-Lübke's *Grammatik der romanischen Sprachen* (4 vols., Leipzig, 1890-1900); *Einführung in die romanische Sprachwissenschaft* (2nd ed., Heidelberg, 1909). The principal magazines devoted to the subject are *Zeitschrift für romanische Philologie* (ed. Gröber; since 1877); *Zeitschrift für neufranzösische Sprache und Literatur* (ed. Behrens; since 1879); *Romanische Forschungen* (ed. Vollmöller; since 1885); *Archiv für das Studium der neueren Sprachen* (since 1846); *Romania* (ed. G. Paris and P. Meyer; since 1812); *Archivio glottologico italiano* (ed. G. L. Ascoli; since 1873). The great development of Romance philology after Diez is due principally to A. Tobler, G. Gröber, W. Förster and H. Suchier in Germany; A. Mussafia (d. 1905), H. Schuchardt in Austria; G. Paris (d. 1905), P. Meyer in France; G. L. Ascoli (d. 1907), and F. d'Ovidio in Italy. (W. M.-L.)

ROMAN DE LA ROSE, a French poem dating from the 13th century. The first part was written about 1230 by Guillaume de Lorris (*q.v.*), whose work formed the starting-point, about forty years later, for the more extensive section written by Jean de Meun (*q.v.*). Guillaume de Lorris wrote an allegory, possibly of an adventure of his own, which is an artistic and beautiful presentation of the love philosophy of the troubadours. In a dream the Lover visits a park to which he is admitted by Idleness. In the park he finds Pleasure, Delight, Cupid and other personages, and at length the Rose. Welcome grants him permission to kiss the Rose, but he is driven away by Danger, Shame, Scandal, and especially by Jealousy, who entrenches the Rose and imprisons Welcome, leaving the Lover disconsolate. The story, thus left incomplete by its inventor, was finished in 19,000 lines by Jean de Meun, who allows the Lover to win the Rose, but only after a long siege and much discourse from Reason, the Friend, Nature and Genius. In the second part, however, the story is entirely subsidiary to the display of the author's encyclopaedic knowledge, to picturesque and poetic digressions, and to violent satire in the manner of the fabliaux against the abuse of power, against women, against popular superstition, and against the celibacy of the clergy. The length of the work and its heterogeneous character proved no bar to its enormous popularity in the middle ages, attested by the 200 MSS. of it which have survived.

The *Roman of the Rose* was translated into English by Chaucer (see the prologue to the *Legende of Good Women*), but the English version of that, extending to about one-third of the whole work, which has come down to us (see an edition by Dr Max Kaluza, Chaucer Society, 1891), is generally admitted to be by another hand. For a list of books on the vexed question of the authorship of the English translation see *Chaucer's *Works** (ed. G. F. Johnson, Münster, 1905, 4th ed. p. 184). A Flemish version by Hein van Aken appeared during Jean de Meun's lifetime, and at the beginning of the 14th century a free imitation, in the form of a series of sonnets, *Il Fiore*, was written in Italian by the Tuscan poet Dante. Three editions of the *Roman de la Rose* were printed at Lyons between 1473 and 1490; two by Antoine Verard (Paris, 1490? and 1496?), by Jean du Pré (Paris, 1493?), by Nicholas Desprez for Jean Petit (Paris), by Michel le Noir (Paris, 1509 and 1519). In 1503 Jean Molinet produced a prose version. Marot altered and modernized the text (1516), and his corrections were followed in subsequent editions. Modern editions are by Mœon (4 vols., 1813), by F. Taubert (2 vols., 1864), by Croissandeau (pseudonym for Pierre Marteau), with a translation into modern French (Orleans, 5 vols., 1878-80), and a critical edition by E. Langlois, author of *Origines et sources du Roman de la Rose* (Paris, 1890). There is a modern English version by F. S. Ellis (Temple Classics, 3 vols., 1900).

ROMAN EMPIRE, LATER. The reign of Constantine the Great forms the most deep-reaching division in the history of Europe. The external continuity is not broken, but the principles which guided society in the Greek and Roman world are replaced by a new order of ideas. The emperor-worship, which expressed a belief in the ideal of the earthly empire of Rome, gives way to Christianity; this is the outward sign that

a mental transformation, which we can trace for 300 years before in visible processes of decay and growth, had reached a crisis.

Besides the adoption of Christianity, Constantine's reign is marked by an event only second in importance, the shifting of the centre of gravity of the Empire from the west to the east by making Byzantium a second capital, a second Rome. The foundation of Constantinople (*q.v.*) determined the subsequent history of the state; it established permanently the division between the eastern and western parts of the Empire—a principle already introduced—and soon exhibited, though not immediately, the preponderance of the eastern half. The eastern provinces were the richest and most resourceful, and only needed a Rome in their midst to proclaim this fact; and further, it was eastward that the Empire fronted, for here was the one great civilized state with which it was in constant antagonism. Byzantium was refounded on the model of Rome, had its own senate, and presently a *praefectus urbi*. But its character was different in two ways: it was Christian and it was Greek. From its foundation New Rome had a Christian stamp; it had no history as the capital of a pagan empire. There was, however, no intention of depressing Rome to a secondary rank in political importance; this was brought about by the force of circumstances.

The Christian Roman Empire, from the first to the last Constantine, endured for 1130 years, and during that long period, which witnessed the births of all the great modern nations of Europe, experienced many vicissitudes of decline and revival. In the 5th century it lost all its western provinces through the expansion of the Teutons; but in the 6th asserted something of its ancient power and won back some of its losses. In the 7th it was brought very low through the expansion of the Saracens and of the Slavs, but in consequence of internal reforms and prudent government in the 8th century was able before the end of the 9th to initiate a new brilliant period of power and conquest. From the middle of the 11th century a decline began; besides the perpetual dangers on the eastern and northern frontiers, the Empire was menaced by the political aggression of the Normans and the commercial aggression of Venice; then its capital was taken and its dominions dismembered by Franks and Venetians in 1204. It survived the blow for 250 years, as a shadow of its former self.

During this long life its chief political rôle was that of acting as a defender of Europe against the great powers of western Asia. While it had to resist a continuous succession of dangerous enemies on its northern frontier in Europe—German, Slavonic, Finnic and Tatar peoples—it always considered that its front was towards the east, and that its gravest task was to face the powers which successively inherited the dominion of Cyrus and Darius. From this point of view we might divide the external history of the Empire into four great periods, each marked by a struggle with a different Asiatic power: (1) with Persia, ending *c.* 630 with the triumph of Rome; (2) with the Saracens, who ceased to be formidable in the 11th century; (3) with the Seljuk Turks, in the 11th and 12th centuries; (4) with the Ottoman Turks, in which the Roman power went down.

Medieval historians, concentrating their interest on the rising states of western Europe, often fail to recognize the position held by the later Empire and its European prestige. Up to the middle of the 11th century it was in actual strength the first power in Europe, except in the lifetime of Charles the Great, and under the Comneni it was still a power of the first rank. But its political strength does not express the fulness of its importance. As the heir of antiquity it was confessedly superior in civilization, and it was supreme in commerce. Throughout the whole period (to 1204) Constantinople was the first city in the world. The influence which the Empire exerted upon its neighbours, especially the Slavonic peoples, is the second great rôle which it fulfilled for Europe—a rôle on which perhaps the most speaking commentary is the doctrine that the Russian Tsar is the heir of the Roman Caesar.

The Empire has been called by many names—Greek, Byzantine, Lower (Bas-empire), Eastern (or East-Roman). All these have a certain justification as descriptions, but the only strictly correct name is *Roman* (as recognized in the title of Gibbon's work). The continuity from Augustus to Constantine XI. is unbroken; the emperor was always the Roman emperor; his subjects were always Romans (*Ῥωμαῖοι*; hence *Romani*—Modern Greek). "Greek Empire" expresses the fact that the state became predominantly Greek in character, owing to the loss, first of the Latin provinces, afterwards of Syria and Egypt; and from the middle of the 6th century Greek became the official language. "Lower Empire" (*Later* is preferable) marks the great actual distinction in character between the development before Constantine (Haut-empire) and after his adoption of Christianity. "Byzantine" sums up in a word the unique Graeco-Roman civilization which was centred in New Rome. *Eastern* is a term of convenience, but it has been used in two senses, not to be confused. It has been used, *loosely*, to designate the eastern half of the Empire during the 80 years or so (from 395) when there were two lines of emperors, ruling formally as colleagues but practically independent, at Rome and Constantinople; but though there were two emperors, as often before, there was only one Empire. It has also been used, justifiably, to distinguish the true Roman Empire from the new state founded by Charles the Great (800), which also claimed to be the Roman Empire; *Eastern* and *Western Empire* are from this date forward legitimate terms of distinction. But between the periods to which the legitimate and ill-define uses of the term "Eastern Empire" apply lies a period of more than 200 years, in which there was only one Empire in any sense of the word.

A chronological table of the dynasties will assist the reader of the historical sketch which follows.

Succession of Emperors arranged in Dynasties.

1. CONSTANTINIAN DYNASTY.—A.D. 324–363.
Emperors (founder of dynasty, Constantius I., 305–306):
Constantine I. (306, sole emperor since), 324–337.
In west—Constantine II., 337–340; Constans, 337–350.
In east—Constantine II., 337–340.
Sole emperors: Constantius II., 350–361; Julian, 361–363.
INTER-DYNASTY.—Jovian, 363–364.
2. VALENTINIANEA DYNASTY.—A.D. 364–392.
Emperors:
In west—Valentinian I., 364–375; Gratian, 367–383;
Valentinian II., 375–392.
In east—Valens, 365–378 (Theodosius I., 379–392).
3. THEODOSIAN DYNASTY.—A.D. 392–457.
Emperors: Theodosius I. (379), 392–395.
In east—Arcadius, 395–408; Theodosius II., 408–450;
Marcian, 450–457.
In west—Honorius, 395–423; Constantius III., 422;
Valentinian III., 425–455; (non-dynastic) Maximus,
455; Avitus, 455–456.
4. LEONINE DYNASTY.—A.D. 457–518.
Emperors:
In east—Leo I., 457–474; Leo II., 474; Zeno, 474–491;
Anastasius I., 491–518.
In west—non-dynastic, Majorian, 457–461; Severus,
461–465; (Leo I., 465–474); Anthemius,
467–472; Olybrius, 472; Glycerius, 473–474; Julius
Nepos, 474–480; (usurper, Romulus Augustulus, 475–
476).
5. JUSTINIANEA DYNASTY.—A.D. 518–602.
Emperors: Justin I., 518–527; Justinian I., 527–565;
Justin II., 565–578; Tiberius II., 578–582; Maurice,
582–602.
INTER-DYNASTY.—Phocas, 602–610.
6. HERACLIAN DYNASTY.—A.D. 610–711.
Emperors: Heraclius, 610–641; Constantine III., 641;
Heraclonas, 641–642; Constans II., 642–668; Con-
stantine IV. (Pogonatus) 668–685; Justinian II.
(Rhynchmetus), 685–695; (non-dynastic) Leontius, 695–
698 and Tiberius III. (Apsimar), 698–705; Justinian II.
(restored), 705–711.
INTER-DYNASTY.—Philip Bardanes, 711–713; Anastasius II.,
713–716; Theodosius III., 716–717.
7. ISAURIAN (SYRIAN) DYNASTY.—A.D. 717–802.
Emperors: Leo III., 717–740 (alias 41); Constantine V.
(Coprpnymus), 740–775; Leo IV. (Khazar), 775–780;
Constantine VI., 780–797; Irene, 797–802.
INTER-DYNASTY.—Niciphorus I., 802–811; Stauracius (son of
Niciphorus), 811; Michael I. (Rhangabé, father-in-law
of Stauracius), 811–813; Leo V. (Armenian), 813–820.
8. PHRYGIAN OR AMORIAN DYNASTY.—A.D. 820–867.
Emperors: Michael II. (Stammerer), 820–829; Theophilus,
829–842; Michael III. (Drunkard), 842–867.
9. MACEDONIAN DYNASTY.—A.D. 867–1057.
Emperors: Basil I. (Macedonian), 867–886; Leo VI. (philoso-
pher) and Alexander, 886–912; Constantine VII.

(Porphyrogennetos), 912-959; Romanus I. (Lecapenus), 920-944; Romanus II., 959-963; Basil II. (Bulgaroctonus) and Constantine VIII., 963-1025; (non-dynastic) Nicephorus II. (Phocas), 963-969, and John Zimisceus, 969-976; Constantine VIII., alone, 1025-1028; Romanus III. (Argyros), 1028-1034; Michael IV. (Paphlagonian), 1034-1041; Michael V. (Calaphates), 1041-1042; Constantine IX. (Monomachus), 1042-1054; Theodora, 1054-1056; Michael VI. (Stratioticus), 1056-1057.

INTER-DYNASTY.—Isaac I. (Comnenus), 1057-1059; Constantine X. (Ducas), 1059-1067; Michael VII. (Parapinaces), Andronicus and Constantine XI., 1067; Romanus IV. (Diogenes), 1067-1071; Michael VII., alone, 1071-1078; Nicephorus III. (Botaniates), 1078-1081.

10. COMNENIAN DYNASTY.—A.D. 1081-1204.
Emperors: Alexius I. (nephew of Isaac I.), 1081-1118; John II., 1118-1143; Manuel I., 1143-1180; Alexius III., 1180-1183; Andronicus I., 1183-1185; Isaac II. (Angelus), 1185-1195; Alexius III. (Angelus), 1195-1203; Isaac II. and Alexius IV., 1203-1204.

INTER-DYNASTY.—Alexius V. (Murtzuphlus), 1204.
Capture of Constantinople and dismemberment of the Empire by the Venetians and Franks, A.D. 1204-1205.

11. LASCARID DYNASTY.—A.D. 1206-1259.
Emperors: Theodore I. (Lascaris), 1206-1222; John III. (Vatatzes or Batatzes), 1222-1254; Theodore II. (Lascaris), 1254-1259.
12. PALAEOLOGIAN DYNASTY.—A.D. 1259-1453.
Emperors: Michael VIII. (Palaologus), 1259-1282; Andronicus II. (Elder), 1282-1288; Andronicus III. (Younger), 1288-1341; John V., 1341-1391; (non-dynastic), John (Cantacuzenus), 1347-1355; Manuel II., 1391-1425; John VI., 1425-1448; Constantine XI., or XII. (Dragases), 1448-1453.

Historical Sketch.—Diocletian's artificial experiment of two Augusti and two Caesars had been proved a failure, leading to twenty years of disastrous civil wars; and when Constantine the Great (*q.v.*) destroyed his last rival and restored domestic peace, he ruled for the rest of his life with undivided sway. But he had three sons, and this led to a new partition of the Empire after his death, and to more domestic wars, Constantine first annexing the share of Constantine II. (340) and becoming sole ruler of the west, to be in turn destroyed by Constantius II., who in 350 remained sole sovereign of the Empire. Having no children, he was succeeded by his cousin, Julian the Apostate (*q.v.*). This period was marked by wars against the Germans, who were pressing on the Rhine and Danish frontiers, and against Persia. Julian lost his life in the eastern struggle, which was then terminated by a disadvantageous peace. But the German danger grew graver, and the battle of Adrianople, in which the Visigoths, who had crossed the Danube in consequence of the coming of the Huns (see *GOTH* and *HUNS*), won a great victory, and the emperor Valens perished (378), announced that the question between Roman and Teuton had entered on a new stage. Theodosius the Great saved the situation for the time by his Gothic pacification. The efforts of a series of exceptionally able and hard-working rulers preserved the Empire intact throughout the 4th century, but the dangers which they weathered were fatal to their weaker successors. On the death of Theodosius the decisive moment came for the expansion of the Germans, and they took the tide at the flood. There were three elements in the situation. Besides the Teutonic peoples beyond the frontier there were dependent people who had settled within the Empire (as Visigoths in Moesia, Vandals in Pannonia), and further there were the semi-Romanized Germans in the service of the Empire, some of whom had risen to leading positions (like Merobaudes and Stilicho). A Germanization of the Empire, or part of it, in some shape was inevitable, but, if the rulers of the 5th century had been men of the same stamp as the rulers of the 4th, the process might have assumed a different form. The sons of Theodosius were both incapable; and in their reigns the future of the state which was divided between them was decided. The dualism between the east (under Arcadius) and the west (under Honorius) developed under the rule of these brothers into antagonism verging on hostility. The German danger was averted in the east, but it led in a few years to the loss of many of the western provinces, and at the end of ninety years the

immediate authority of the Roman Emperor did not extend west of the Adriatic. The reign of Honorius saw the abandonment of Britain, the establishment of the Visigothic kingdom in Aquitaine, the occupation of a great part of Spain by Vandals and Sueves (Suebi). Under Valentinian III. the Vandals founded their kingdom in North Africa, the Visigoths shared Spain with the Sueves, the Burgundian kingdom was founded in S.E. Gaul. The last Roman possession in Gaul passed to the Franks in 486 (see *GOTH*; *VANDALS*; *FRANKS*). It is significant that the chief defender of the Empire against the Germans who were dismembering it were men of German race. Stilicho, who defended Italy against Alaric, Aëtius, whose great work was to protect the imperial possessions in Gaul, and Ricimer. It was also a German, Fravitta, who played a decisive part in suppressing a formidable Gothic movement which menaced the throne of Arcadius in 399-400. It was characteristic of this transformation of Europe that the Germans, who were imbued with a profound reverence for the Empire and its prestige, founded their kingdoms on Roman soil in the first instance as "federates" of the Emperor, on the basis of formal contracts, defining their relations to the native provincials; they seized their dominions not as conquerors, but as subjects. The double position of Alaric himself, as both king of the Visigoths and a *magister militum* of the Empire is significant of the situation.

The development of events was complicated by the sudden growth of the transient empire of the Huns (*q.v.*) in central Europe, forming a third great power, which, reaching from the Rhine to the Caucasus, from the Danube to the Baltic, might be compared in the extent of its nominal supremacy, but in nothing else, to the empires of Rome and Persia. The Huns, whose first appearance had precipitated the Germans on the Empire, now retarded for some years the process of German expansion, while they failed in their own attacks upon the Empire. On Attila's death (453) his realm collapsed, and his German vassals (Ostrogoths, &c.) founded important kingdoms on its ruins.

After the death of Valentinian III., the worst of his house, the Theodosian dynasty expired in the west, and the authority of the western emperors who succeeded him in rapid succession reached little beyond Italy. For most of this period of twenty years the general Ricimer, of German birth, held the scales of power in that peninsula, setting up and pulling down emperors. After his death the western throne was no longer tenable. First there was a usurpation; the general Orestes set up his child-son Romulus Augustulus against the legitimate Augustus, Julius Nepos, who was acknowledged by the eastern emperor; but this temporary government was overthrown (476) by a Germanic military revolution headed by Odoacer, who appropriated part of the soil to his German soldiers and founded an Italian kingdom under the nominal supremacy of the emperor at Constantinople, who, however unwilling, recognized his position (after the death of Julius Nepos).

The escape of the eastern provinces from the fate of the western illustrates the fact that the strength of the Empire lay in the east. These provinces were more populous and presented greater obstacles to the invaders, who followed the line of least resistance. But it was of immense importance that throughout this period the Empire was able to preserve a practically unbroken peace with its great eastern rival. The struggle with Persia, terminated in 364 by the peace of Jovian, was not renewed till the beginning of the 6th century. It was of greater importance that the rulers pursued a discreet and moderate policy, both in financial administration and in foreign affairs; and the result was that at the end of a hundred years the diminished Empire was strong and consolidated. Theodosius II. was a weak prince, but his government was ably conducted by Anthemius, by his sister Pulcheria and by the eunuch Chrysaphius. His reign was important for the Armenian question. Theodosius I. had committed the error of consenting to a division of this buffer state in the Roman and Persian spheres of influence, Persia having much the larger. The

Sassanid government tried to suppress the use of the Greek language. But the government of Theodosius II. officially supported the enterprise of translating the Bible into Armenian (Mesrob had just invented the Armenian alphabet), and this initiated the production of an abundant literature of translations from the Greek, which secured the perpetual connexion of Armenia with European culture, and not with Oriental. This reign is also distinguished by the building of the great landwalls of Constantinople, by the foundation of a university there and by the collection of the imperial laws in the *Codex Theodosianus*, which is a mine of material for the social condition of the Empire. It reveals to us the decline of municipal liberty, the decay of the middle classes in the West, the evils of the oppressive fiscal system and an appalling paralysis of Roman administration which had once been so efficient; it shows how the best-intentioned emperors were unable to control the governors and check their corruption; and discloses a disorganization which facilitated the dismemberment of the Empire by the barbarians.

In the reign of Zeno it seemed probable that an Ostrogothic kingdom would be established in the Balkan peninsula, but the danger was diverted to Italy (see *GOTHS*). The kingdom which Theodoric founded there was, in its constitutional aspect, a continuation of Odoacer's régime. He, like Odoacer and Alaric, held the double position of a German king and a Roman official. He was *magister militum* as well as *rex*. His powers were defined by capitulations which were arranged with the emperor Anastasius and loyally observed. The right of legislation was reserved to the emperor, and Theodoric never claimed it; but for all practical purposes he was independent.

In the 6th century the emperor Justinian, whose talents were equal to his ambitions, found himself, through the financial prudence of his predecessors, in a position to undertake the reconquest of some of the lost western provinces. The Vandal power had declined, and Africa was won back in one campaign by Belisarius in 533. The conquest of Italy was far more difficult. Begun by Belisarius in 535, it was not completed till 554, by Narses. A portion of southern Spain was also won from the Visigoths, so that the Romans again commanded the western straits. Justinian, possessed by large ideas and intoxicated with the majesty of Rome, aspired to be a great conqueror, a great lawgiver, a great pontiff, a great diplomatist, a great builder, and in each of these spheres his reign holds a conspicuous place in the annals of the Empire. His legal work alone, or the building of Santa Sophia was enough to ensure him immortal fame. But deep shadows balance the splendour. The reconquest of Africa was thoroughly justified and advantageous, but Italy was bought at a ruinous cost. In the first place, the Persian empire was at this time ruled by one of its greatest kings, Chosroes I. (*q.v.*), who was far from peacefully inclined. Justinian was engaged in a long Persian and a long Gothic war at the same time, and the state was unequal to the strain. In the second place, it was all-important for his western policy to secure the goodwill of the Italian provincials and the Roman bishop, and for this purpose he involved himself in an ecclesiastical policy (see below) which caused the final alienation of the Syrian and Egyptian provinces. The reconquest of the West was purchased by the disunion of the East. Thirdly, the enormous expenses of the Italian and Persian wars, augmented by architectural undertakings, caused a policy of financial oppression which hung as a cloud over all the brilliance of his reign, and led to the decline which ensued upon his death. Nor is it to be forgotten that he had at the same time to fulfil the task of protecting the Danube against the Germans, Slavs and Bulgarians who constantly threatened the Illyrian provinces. He spared no expense in building forts and walls. Justinian's name will always be associated with that of the gifted Theodora, an actress of doubtful fame in her early life, who shared his throne. Their mosaic portraits are preserved in the contemporary church of San Vitale at Ravenna. She possessed great political influence, and the fact that she was a heretic (monophysite), while Justinian was devoted to orthodox,

did not mar their harmony, but only facilitated the policy of extending secret favour to the heretics who were publicly condemned, and enabled the left hand to act without the knowledge of the right. The events of the half-century after Justinian's death exhibited the weakness to which his grandiose policy had reduced the Empire. It was attacked on the west, on the north and on the east, and at all points was unequal to coping with its enemies. (1) Italy fell a victim to the Lombards (*q.v.*), and in a few years more than half of the peninsula had passed under their sway. (2) The Avars, a Hunnic people who had advanced from the Caspian, took possession of Pannonia and Dacia, and formed an empire, consisting of Slavonic and Bulgarian subjects, which endured for about sixty years. Their chief occupation was to invade the Illyrian peninsula and extort tribute and ransoms from the emperors. So far as the Avars themselves were concerned, these incursions had no permanent significance, but the Slavs who overran the provinces did more than devastate. These years saw the beginning of the Slavonic settlements which changed the ethnical character of the peninsula, and thus mark the commencement of a new period. Slavs occupied Moesia and a large part of Macedonia, even close to Thessalonica, which they besieged; they penetrated southward into Greece and made large settlements in the Peloponnese (see *GREECE, History, "Roman period," ad fin.*). They occupied the north-western provinces, which became Croatia and Servia, as well as Dalmatia (except some of the coast towns). In the northern part of the peninsula the Slavonic element remained dominant, but in Greece it was assimilated to the Greek (after the 9th century) and has left little record of itself except in place names. (3) The Empire was simultaneously engaged in the perennial strife with Persia. A short interval of peace was secured when the emperor Maurice assisted Chosroes II. to dethrone a usurper, but after Maurice's death (602) the final and mortal struggle began (see *PERSIA, History, section viii. "The Sassanian Empire"*). Throughout the incompetent reign of Phocas the eastern provinces were overrun by the Persians, as the Illyrian were overrun by the Slavs. The unpopular rule of this cruel usurper was terminated in 610 by the intervention of the governor of Africa, whose son Heraclius sailed to Constantinople and, welcomed by an influential party, met with little resistance. Phocas, murderer of Maurice, was murdered by the people, and the victor was crowned emperor to find himself in presence of a desperate situation. Antioch, Damascus and many other great cities were captured by the Persians; and in 614 Jerusalem was destroyed and the Holy Cross, along with the patriarch, carried off to Ctesiphon. This event produced a profound sensation in Christendom. In 616 Egypt was conquered. The army had fallen into utter disorder under Phocas, and Heraclius so deeply despaired of saving Constantinople that he thought of transferring the imperial capital to Carthage. But the extreme gravity of the situation seems to have wrought a moral change among his subjects; the patriarch Sergius was the mouthpiece of a widespread patriotic feeling, and it was not least through his influence that Heraclius performed the task of creating a capable army. His efforts were rewarded in a series of brilliant campaigns (622-28), which, in the emphasis laid on the contrast between Christianity and fire-worship and on the object of recovering the Cross, had the character of crusades. Heraclius recovered his provinces and held Persia at his mercy (decisive battle at Nineveh, end of 627).

This war is remarkable for the attempt of the Persians to take Constantinople (626) in conjunction with the Avars and Slavs. Soon afterwards the Avar power began to decay, and the Slavs and Bulgarians shook off their yoke. It seemed as if the Roman government would now be able to regain the control in the Illyrian lands which it had almost entirely lost. It seems probable that Heraclius came to terms with the Slavs—Croats and Servians—in the north-west; their position was regularized, as vassals of the Empire. But fate allowed no breathing-time to do more; the darkest hour had hardly passed when a new storm-cloud, from an unexpected quarter, overspread the heavens.

At this point we have to note that the Hellenic element in the state had definitely gained the upper hand before the end of the 6th century, so that henceforward the Empire might be described as Greek. Justinian's mother-tongue was Latin, and he was devoted to the Latin traditions of Rome, but even he found it necessary to publish his later laws in Greek, and from his reign Greek was the official language.

Many of the Latin official terms were already represented by Greek equivalents (*πάτρις = consul, τραπεζός = praefectus, &c.*), but they were preserved in great numbers, translated and often corrupted (e.g. *κύβητ, μάγιστρος, ἀσκήρητης = a secretis, καγκελάριος, πραιπόσιτος, αὐτομαρ = quaesitor, σάκκος παλάτιου, θόβηκιον, θήκιον = obsequium*). *Φῆξ, rex*, was always used of barbarian potentates, *βασιλεύς* being reserved as = the emperor (but also applied to the Persian king). In military drill many Latin words of command continued to be used.

It is to be noted that the year 630 marks the beginning of a period of literary (and artistic) sterility in the Greek world (see GREEK LITERATURE, section *Byzantine*).

With the rise of Islam (see CALIPHATE; MAHOMET) two universal religions, for the first time, stood face to face, each aspiring to win the universe. The struggle therefore which then began was not only a new phase of the "Eternal Question," the strife between Europe and Asia, but was one in which the religious element was fundamental. Fire-worship was only a national religion and did not present the danger of Islam. The creation of the political power of the Mahomedans was so sudden that it took the world by surpris. Bostra, the fortress of Roman Arabia, fell into their hands in 634, and before the death of Heraclius in 641 they had conquered Syria and all Egypt, except Alexandria, which opened its gates to them in 643. The religious alienation of the Syrian and Egyptian peoples from Constantinople, expressing as it did a national sentiment antagonistic to the Greeks, was an important political factor in the Mahomedan (as in the previous Persian) conquest. Thus the Mahomedans definitely cut the Empire short in the East, as the Germans had cut it short in the West; Egypt was never recovered, Syria only for short periods and partially, while the integrity of Asia Minor was constantly menaced and Cilicia occupied for many generations. By their conquest of Persia the Caliphs succeeded to the position of the Sassanids; this led to the conquest of Armenia (c. 654); while, in the West, Africa was occupied in 647 (though the conquest was not completed till the capture of Carthage and other strong places in 698). Thus within twenty years from the first attack the Empire was girt about by the new aggressive power from the precincts of the Caucasus to the western Mediterranean.

Fortunately Constans II., grandson of Heraclius, was a man of eminent ability and firmness. The state owed to him the preservation of Asia Minor, and the creation of a powerful fleet (see below) which protected the Aegean coasts and islands against the naval power which the Mahomedans created. He was responsible for completing a new, efficient military organization, which determined the lines of the administrative reforms of Leo III. (see below). In his last years he turned his eyes to Italy and Africa. He dreamed of restoring Old Rome as the centre of the Empire. But he did not succeed in recovering south Italy from the Lombards (Duchy of Beneventum), and having visited Rome he took up his residence in Syracuse, where he was assassinated, having lost two fleets which he sent against the Arabs of Africa. The strain lasted for another fifty years. Constantinople sustained two great sieges, which stand out as crises, for, if in either case the enemy had been successful, the Empire was doomed.

The first siege was in 673-77, under the caliph Moawiyah; his fleet blockaded the capital for five years, but all its efforts were frustrated by the able precautions of Constantine IV.; "Greek fire" (see below) played an important part in the defence; and the armada was annihilated on the voyage back to Syria by storms and the Roman fleet. The second crisis was at the accession of Leo III., when the city was besieged by land and sea by Suleiman for a year (717-18), and Leo's brilliant defence, again aided by Greek fire, saved Europe. This crisis marks the highest point of Mahomedan aggression, which never again caused the Empire to tremble for its existence.

The Heraclian dynasty, which had fallen on evil times and rendered inestimable services to the Empire, came to an end in anarchy, which was terminated by the elevation of the Syrian (commonly called Isaurian) Leo III., whose reign opens a new period. His reforming hand was active in every sphere of government, but the ill-fame which he won by his iconoclastic policy obscured in the memory of posterity the capital importance of his work. His provincial organization was revolutionary, and his legislation departed from the Roman tradition (see below). From his reign to the middle of the 10th century the continuous warfare by land with the Caliphs consisted of marauding expeditions of each power into the other's territory, captures of fortresses, guerilla fighting, but no great conquests or decisive battles. The efficiency of the army was carefully maintained, but the neglect of the navy led to the losses of Crete (conquered by Moslem adventurers from Spain 826) and Sicily (conquered by the Saracens of Africa), Panormus taken 832, Syracuse 878 (see SICILY). The Africans also made temporary conquests, including Bari, in south Italy. This period saw the loss of the exarchate of Ravenna to the Lombards (750), the expansion of the Frankish power under Pippin and Charlemagne in Italy, and in close connexion therewith the loss of Old Rome.

The iconoclast emperors pursued a moderate foreign policy, consolidating the Empire within its contracted limits; but under the "Macedonian" dynasty, which was of Armenian descent, it again expanded and became the strongest power in Europe. The 9th century also witnessed a revival of learning and culture which had been in eclipse for 200 years. The reign of Basil I. was marked by an energetic policy in south Italy, where his forces co-operated with the western emperor Louis II. The Saracens were expelled from their strongholds, Bari recovered, Calabria saved, and the new province (Theme) of Longobardia formed. This secured the entrance to the Adriatic, and the increase of dominion here at the expense of the Lombards was a compensation for the loss of Sicily. Leo VI. did much for reorganizing the navy, but his reign was not fortunate; Saracen pirates plundered freely in the Aegean and, under the able renegade Leo of Tripolis, captured Thessalonica and carried off countless captives (904). But a great tide of success began fifty years later. Nicephorus Phocas won back Crete (961) as general of Romanus II., and then as emperor recovered Cilicia and North Syria (with Antioch) 968. Cyprus was also recovered. The tide flowed on under his equally able successor, John Zimisces (of Armenian race) and under Basil II.; these reigns mark the decisive victory of the Empire in the long struggle with the Saracens, whose empire had been broken up into separate states. The eastern frontier was strengthened by the active policy of Basil II. in Armenia, which was more fully incorporated in the Empire under Constantine IX.

The reign of Basil II. marks the culmination of the power of the Eastern Empire, for it also witnessed the triumphant conclusion of another conflict which had lasted almost as long. In the reign of Constantine IV. the Bulgarians (see BULGARIA) had founded a kingdom in Lower Moesia, reducing the Slavonic tribes who had occupied the country, but less than two centuries sufficed to assimilate the conquerors to the conquered, and to give Bulgaria the character of a Slavonic state. The reign of Constantine V. was marked by continuous war with this enemy, and Nicephorus I. lost his life in a Bulgarian campaign. This disaster was followed up by Prince Krum, who besieged Constantinople in 815. His death was followed by a long peace. Prince Boris was converted to Christianity (reign of Michael III.); a metropolitan see of Bulgaria was founded, dependent on the patriarch of Constantinople; and the "civilization of the Bulgarians, and beginnings of their literature, were entirely under Byzantine influence. The conversion was contemporary with the work of the two missionaries Cyril and Methodius, who (while the field of their personal activity was in Great Moravia and

Pannonia laid the south-eastern Slavs under a deep debt by inventing the Glagolitic (*g.v.*), not the so-called "Cyrillic" alphabet (based on Greek cursive) and translating parts of the Scriptures into Slavonic (the dialect of the Slavs of Macedonia). The most brilliant period of the old Bulgarian kingdom was the reign of Simeon (893-927), who extended the realm westward to the shores of the Adriatic and took the title "Tsar [*i.e.* Caesar] of Bulgaria and autocrat of the Romans." The aggression against the Empire which marked his ambitious reign ceased under his successor Peter, who married a daughter of Romanus I., and the Bulgarian Patriarchate founded by Simeon was recognized at Byzantium. But the Byzantine rulers only waited for a favourable time to reduce this formidable Slavonic state. At length Zimisce subjugated eastern Bulgaria and recovered the Danube frontier. But while Basil II. was engaged in contending with rivals, the heroic Samuel (of the Shishmanid family) restored the Bulgarian power and reduced the Servians. After a long and arduous war of fourteen years Basil (called the "Bulgar-slayer") subdued all Bulgaria western and eastern (1018). He treated the conquered people with moderation, leaving them their political institutions and their autocephalous church, and to the nobility their privileges. Some Bulgarian noble families and members of the royal house were incorporated in the Greek nobility; there was Shishmanid blood in the families of Comnenus and Ducas. Greek domination was now established in the peninsula for more than 150 years. The Slavs of Greece had in the middle of the 9th century been brought under the control of the government.

In the reign of Basil II. the Russian question also was settled. The Russian state (see RUSSIA) had been founded before the middle of the 9th century by Norsemen from Sweden, who were known in eastern Europe as Russians (*Росы*), with its centres at Novgorod and Kiev. They did for the eastern Slavs what the Bulgarians had done for the Slavs of Moesia. The Dnieper and Dniester gave them access to the Euxine, and the Empire was exposed to their maritime attacks (Constantinople was in extreme danger in 860 and 941), which recall the Gothic expeditions of the 3rd century. In 945 a commercial treaty was concluded, and the visit of the princess Olga to Byzantium (towards the end of the reign of the learned emperor Constantine VII., Porphyrogenetos) and her baptism seemed a pledge of peace. But Olga's conversion had no results. Sviatoslav occupied Bulgaria and threatened the Empire, but was decisively defeated by Zimisce (971), and this was virtually the end of the struggle. In 988 Prince Vladimir captured Cherson, but restored it to the emperor Basil, who gave him his sister Anna in marriage, and he accepted Christianity for himself and his people. After this conversion and alliance, Byzantium had little to fear from Kiev, which came under its influence. One hostile expedition (1043) indeed is recorded, but it was a failure. Much about the same time that the Russians had founded their state, the Magyars (see HUNGARY; the Greeks called them Turks) migrated westward and occupied the regions between the Dnieper and the Danube, while beyond them, pressing on their heels, were another new people, the Petchenegs (*Patzinaks*). The policy of Byzantium was to make use of the Magyars as a check on the Bulgarians, and so we find the Romans (under Leo VI.) and the Magyars co-operating against the tsar Simeon. But Simeon played the same game more effectively by using the Petchenegs against the Magyars, and the result was that the Magyars before the end of the 9th century were forced to move westward into their present country, and their place was taken by the Petchenegs. From their new seats the Magyars could invade the Empire and threaten the coast towns of Dalmatia. The conquest of Bulgaria made the Petchenegs immediate neighbours of the Empire, and during the 11th century the depredations of these irreclaimable savages, who filtered into the Balkan peninsula, constantly preoccupied the government. In 1064 they were driven from the Dniester regions into Little Walachia by the Kumans (or Polovtsi), a people of the same ethnical group as themselves. They were

crushingly defeated by Alexius Comnenus in 1091, and exterminated by John Comnenus in 1123.

In the Macedonian period a grave domestic question troubled the government. This was the growth of the large estates of the rich nobles of Asia Minor, at the expense of small properties, to an excess which was politically and economically dangerous. The legislation against the evil began under Romanus I. and was directed to the defence of the poor against the rich, and to protecting the military organization which was based on holdings of land to which the obligation of military service was attached. There was also danger in the excessive influence of rich and powerful families, from which the great military officers were drawn, and which were extensively related by alliances among themselves. The danger was realized in the struggle which Basil II. had to sustain with the families of Sclerus and Phocas. Various kinds of legislation were attempted. Under Romanus I. alienation of property to the large landowners was forbidden. Nicephorus Phocas, whose sympathies were with the aristocracy to which he belonged, holding that there had been enough legislation in favour of the poor, sought to meet the difficulty of maintaining a supply of military lands in the future by forbidding further acquisitions of estates by the Church. Basil II. returned to the policy of Romanus, but, with much greater severity, resorting to confiscation of some of the immense private estates; and he endeavoured to keep down the aristocrats of Asia Minor by very heavy taxation. Through the recovery of the Balkan provinces he gained in Europe a certain political counterpoise to the influence of Asia Minor, which had been preponderant since the seventh century. Asia Minor meant the army, and opposition to its influence expressed itself in the 11th century in a fatal anti-military policy, which is largely responsible for the conquests of a new enemy, the Seljuk Turks, who now entered into the inheritance of the Caliphs (see CALIPHATE *ad fin.* and SELJUKS). Constantinople was haunted by the dread of a military usurpation. An attempt of the military hero George Maniaces (who had made a remarkable effort to recover Sicily) to wrest the crown from Constantine IX. had failed; and when Isaac Comnenus, who represented the military aristocrats of Asia Minor, ascended the throne, he found himself soon compelled to abdicate, in face of the opposition. The reign of Constantine X., of the rival family of Ducas, marked the culmination of this antagonism. The senate was filled with men of the lower classes, and the military budget was ruthlessly cut down. This policy reduced the army and stopped the supply of officers, since there was no longer hope of a profitable career. The emperor thought to meet dangers from external enemies by diplomacy. The successes of the Seljuks (after the fall of the great Armenian fortress of Ani in 1064) at length awoke the government from its dream of security. The general Romanus Diogenes was proclaimed emperor. He had to create an army and to train it; he did not spare himself, but it was too late. He was defeated and captured by Alp Arslan on the decisive field of Manzikert (1071). Released by the sultan, who honoured his bravery, he was deposed in favour of Michael Ducas, and falling into the hands of his enemies, was blinded. The east and centre of Asia Minor were thus lost; the Seljuk kingdom of Rûm was founded; Nicaea was captured by the Turks in 1080. The provinces which escaped the Seljuk occupation were thoroughly disorganized, a prey to foreign and native adventurers and usurpers (see SELJUKS).

Thus in the seventies of the 11th century the Empire seemed through incompetence and frivolity to have been brought to the verge of dissolution. The disorder was terminated by the accession of the extraordinarily able statesman Alexius Comnenus (1081), who effected a reconciliation with the rival family of Ducas, established a strong government and founded a dynasty. He had to deal with three great dangers—the Seljuks, the Petchenegs (see above), and in the west the Normans. The Normans had wrested from East Rome its possessions in South Italy (1041-71; see NORMANS)—succeeding where German emperors had failed—and throughout the Comnenian period

the Empire was threatened by their projects of conquest beyond the Adriatic, projects which aimed at Constantinople itself.

Four great attempts against the Empire were made by the Normans; they were unsuccessful, but they heralded the Western conquest of 1204. (1) Expedition of Robert Guiscard, 1081-85, repelled by Alexius with help of Venice (2) Bohemond's expedition, 1105-7, foiled by the able strategy of Alexius; (3) the invasion of Greece by Roger of Sicily, 1147; Venice supported Manuel Comnenus, and the Normans were driven from Corfu, 1149; (4) the expedition of William II. of Sicily, 1185, who succeeded in capturing Thessalonica; the invaders were defeated at Demetritsa, but they gained the islands of Cephalonia and Zacynthus.

The two most important events in the reign of Alexius were the prices which he paid for help against his enemies. (1) He was obliged (1084) to grant to Venice (which had become independent of the Empire in the 9th century; see VENICE), in return for her naval aid against the Normans, commercial privileges which practically made the Empire commercially dependent on the Republic. (2) He sought auxiliary forces in western Europe to help him against the Seljuks; the answer of the pope and Latin Christendom was the First Crusade—a succour very different from that which he desired. Through his tact and discretion, the state was safely steered through the dangers with which the disorderly hosts of barbarous allies menaced it, and the immediate results were salutary; large parts of Asia Minor, including Nicaea, were restored to the Empire, which was thus greatly strengthened in the East while the Turks were weakened (see CRUSADES). But for this help Byzantium might not have recovered the transient strength and brilliance which it displayed under Manuel. In Asia Minor the crusaders kept the terms of their agreement to restore to the emperor what had belonged to him; but on capturing Antioch (1098) they permitted the Norman Bohemond to retain it, in flagrant violation of their oaths; for to Antioch it was to any place the emperor had a right, as it had been his a few years before. This was in itself sufficient to cause a breach between Byzantium and the Latin kingdom of Jerusalem (founded 1099). But otherwise the new political situation created by the Crusade was dangerous, ultimately fatal, to the Empire. For its lands and seas became a highway from western Europe to the Latin colonies in Syria; the Byzantine government was forced to take precautions to protect itself against the crusading expeditions which travelled to the Holy Land; and these precautions were regarded by the western powers as a hindrance to the sacred objects of the crusades. The bitter religious antagonism between the Greek and Latin Christians increased the mutual distrust and the danger.

The history of the new relations between East and West dating from the First Crusade is closely connected with the history of the futile attempts at bringing about a reunion between the Greek and Latin Churches, which had severed communion in 1054 (see below). To heal the schism and bring the Greek Church under the domination of Rome was a principal object of papal policy from Gregory VII. forward. The popes alternated between two methods for attaining this, as circumstances dictated: namely, a peaceful agreement—the policy of union; or an armed occupation of the Empire by some western power (the Normans)—the policy of conquest. Their views varied according to the vicissitudes of their political situation and their struggles with the western emperors. The eastern emperors were also constantly preoccupied with the idea of reconciliation, constantly negotiating with a view to union; but they did not care about it for its own sake, but only for political advantages which it might bring, and their subjects were bitterly opposed to it. Manuel Comnenus during the first part of his reign was the close friend and ally of the western emperor Conrad III., but after Conrad's death, he formed the ambitious plan of realizing in Europe a sovereignty like that of Justinian, and hoped to compass it in conjunction with Rome, the enemy of the Hohenstaufen. His forward policy carried war into Italy; he seized Ancona. But his strength was unequal to such designs. His Latin sympathies, no less than his financial extravagance, made him highly unpopular at

home; and the national lack of sympathy with his Western policy was exhibited—after the revolution which overthrew his son Alexius and raised his cousin Andronicus I. to the throne—by the awful massacre of the Latin residents at Constantinople in 1182, for which the expedition of William of Sicily (see above) and the massacre of the people of Thessalonica was the revenge. The short reign of the wicked and brilliant Andronicus was in all respects a reaction, prudent, economical and popular. His fall was due to the aristocracy against whom his policy was directed, and the reign of Isaac Angelus undid his efforts and completed the ruin of the state. Oppressive taxation caused a revolt of the Bulgarian and Walachian population in the European provinces; the work of Zimisce and Basil was undone, and a new Bulgarian kingdom was founded by John Asen—a decisive blow to the Greek predominance which the Macedonian emperors seemed to have established.

In the fatal year 1204 the perils with which the eastward expansion of western Christendom (the Crusades, and the commercial predominance and ambitions of Venice) had long menaced the Empire, culminated in its conquest and partition. It was due to a series of accidents that the cloud burst at this moment, but the conditions of such a catastrophe had long been present. Isaac Angelus was dethroned by his brother Alexius III., and his son escaped (1201) to the west, where arrangements were being made for a new crusade, which Venice undertook to transport to the Holy Land. The prince persuaded Philip of Swabia (who had married his sister) and Boniface of Montferrat to divert the expedition to Byzantium, in order to restore his father and himself to the throne, promising to furnish help to the Crusade and to reconcile the Greek Church with Rome; Venice agreed to the plan; but Pope Innocent III., the enemy of Philip, forbade it. Isaac and his son, Alexius IV., were restored without difficulty in 1203, and the crusading forces were prepared to proceed to Palestine, if Alexius had performed his promises. But the manner of this restoration, under Latin auspices, was intensely unpopular; he was not unwilling, but he was unable, to fulfil his pledges; and a few months later he was overthrown in favour of one who, if an upstart, was a patriot, Alexius V. Then the Crusaders, who were waiting encamped outside the city, resolved to carry out the design which the Normans had repeatedly attempted, and put an end to the Greek Empire. The leaders of the Fourth Crusade must be acquitted of having formed this plan deliberately before they started; it was not conceived before 1204. They first arranged how they would divide the Empire amongst themselves (March); then they captured the city, which had to endure the worst barbarities of war. In partitioning the Empire, which was now to become the spoil of the conquerors, the guiding mind was the Venetian leader, the blind doge, Henry Dandolo. He looked to the interests of Venice from the narrowest point of view, and in founding the new Latin Empire, which was to replace the Greek, it was his aim that it should be feeble, so as to present no obstacles to Venetian policy. The Latin Empire of Romania was a feudal state like the kingdom of Jerusalem; the emperor was suzerain of all the princes who established themselves on Greek territory; under his own immediate rule were Constantinople, southern Thrace, the Bithynian coast, and some islands in the Aegean. But he was hampered from the beginning by dependence on Venice, want of financial resources, and want of a fleet; the feudal princes, occupied with their separate interests, gave him little support in his conflict with Greeks and Bulgarians; at the end of ten years the worthless fabric began rapidly to decline, and the efforts of the popes, for whom it was the means of realizing Roman supremacy in the East, were unavailing to save it from the extinction to which it was doomed in its cradle.

The original Act of Partition (which gave $\frac{1}{2}$ of the Byzantine territory to the future emperor, $\frac{1}{4}$ to Venice, the remaining $\frac{1}{4}$ to the Crusaders) could hardly be carried out strictly, as the territory was still to be won. The most important vassal state was the kingdom of Thessalonica, including Thessaly, which was assigned to Boniface of Montferrat. But it was conquered by the Greeks of Epirus in 1222. The chief of the territories taken by Venice

was Crete. For the Latin states in Greece and the Aegean see GREECE. The first Latin emperor, Baldwin of Flanders, was captured and put to death by the Bulgarians in 1205. He was succeeded by his brother Henry, an able statesman, after whose death (1216) the decline began.

Three Greek states emerged from the ruin of the Roman Empire. A member of the Comnenian house had founded an independent state at Trebizond, and this empire survived till 1461, when it was conquered by the Ottomans. A relation of the Angeli maintained in Europe an independent Greek state known as the Despotate of Epirus. But the true representative of the imperial line was Theodore Lascaris, who collected the Byzantine aristocracy at Nicaea and was elected emperor in 1206. He and his successors advanced surely and rapidly against the Latin Empire, both in Europe and Asia. It was a question whether Constantinople would fall to the Walacho-Bulgarians or to the Greeks. But an astute diplomat and general, the emperor Michael Palaeologus, captured it in 1261. His object was to recover all the lost territory from the Latins, but he was menaced by a great danger through Charles of Anjou, who had overthrown the rule of the Hohenstaufens in the two Sicilies, and determined to restore the Latin kingdom of Romania. To avert this peril, Michael negotiated with Pope Gregory X.; he was ready to make every concession, and a formal union of the Churches was actually brought about at the council of Lyons in 1274. The emperor had the utmost difficulty in carrying through this policy in face of clerical opposition; it aroused disgust and bitterness among his subjects; and it was undone by his successor. Meanwhile the pope had with difficulty bridled Charles of Anjou; but in Martin IV. he found a more pliable instrument, and in 1282 he made vast preparations for an expedition against the Greek Empire. It was saved by the Sicilian Vespers (see SICILY), to be the prey of other powers.

The end of the 13th century saw the rise of the Ottoman power in Asia and the Servian in Europe. The Empire was assisted by a band of Spanish mercenaries (the Catalan Grand Company; see GREECE, *History*, "Byzantine Period") against the advance of the Ottoman Turks in Asia Minor; they distinguished themselves by saving Philadelphia (1304). In 1326 Brusa (Prusa) became the Ottoman capital, while on the other side the Servians (crushing the Bulgarians in 1330) were gradually closing in on Byzantium. Under Stephen Dušan (1331-1355) Servia attained the height of her power. The enemies were strengthened by the domestic struggles within the Empire, first between Andronicus II. and his son, then between John VI. and the usurper Cantacuzenus. But before the fate of Byzantium was settled the two enemies on its flanks came face to face. In 1387 the Servian power was crushed on the field of Kossovo by the Ottomans (who had crossed the Hellespont in 1360 and taken Philippopolis in 1363). Sultan Bayezid I. won Philadelphia, the last Asiatic possession of the Empire, and conquered Trnovo, the Bulgarian capital, in 1393. Constantinople was now surrounded. The Ottoman power was momentarily eclipsed, and the career of conquest checked, by the Mongol invasion of Timur and the great defeat which it sustained in the battle of Angora (1402). Mahommed I. found it necessary to ally himself with the emperor Manuel. But the pause was brief. Murad II. took Adrianople, and tried (1422) to take Constantinople.

It was small compensation that during this time the Palaeologi had been successful against the Franks in Greece. The situation was desperate. The Turks were in possession of the Balkan peninsula, threatening Hungary; there was no chance of rescue, except from western Europe. John VI. and Manuel had both visited the West in search of help. The jeopardy of the Empire was the opportunity of Rome, and the union of the Churches became the pressing question. It was taken up earnestly by Pope Eugenius IV., and the result was the Decree of Union at the council of Florence in 1439. The emperor and the higher clergy were really in earnest, but the people and the monks did not accept it, and the last agony of Byzantium was marked by ecclesiastical quarrels. Eugenius IV. preached a crusade for the rescue of the Empire, and in 1443 an army of Hungarians and Poles, led by the Hungarian king, won a victory over Murad,

which was more than avenged in the next year on the memorable field of Varna. The end came nine years later under Murad's successor, Mahommed II. An army of about 150,000 blockaded the city by land and sea, and Mahommed began the siege on the 7th of April. The emperor Constantine XI., Palaeologus, on whom the task of the forlorn defence devolved (and whose position was all the more difficult because he was alienated from his subjects, having embraced the Latin rite), can have had little more than 8000 men at his disposal; he received no help from the Western powers; but an experienced Genoese soldier of fortune, John Justiniani, arrived with two vessels and 400 cuirassiers and aided the emperor with his courage and advice. The resident foreigners, both Venetians and Genoese, loyally shared in the labours of the defence. The final storm of the land walls took place on the night of the 29th of May. All looked to Justiniani for salvation, and when he, severely wounded, retired from the wall to have his wound looked to, a panic ensued. The enemy seized the moment, and the Janissaries in a final charge rushed the stockade which had been constructed to replace a portion of the wall destroyed by the Turkish cannon. This decided the fate of the city. Constantine fell fighting heroically. Soon after sunrise (May 30) the Mahommedan army entered Constantinople (Stambul = ἡ ἑὴν πόλις, "the city"), which was in their eyes the capital of Christendom.

The ultimate responsibility for this disaster is generally imputed to the political adventurers who dismembered the Empire in 1204. It may indeed be said that at that time the Byzantine state seemed already stricken with paralysis and verging to dissolution, and it was menaced by the re-arisen power of Bulgaria. But more than once before (in the 7th century and in the 11th) it had recovered its strength when it was weak and in dire peril; and, considering what the emperors of Nicaea and Michael VIII. accomplished, it seems probable that, if there had been no Fourth Crusade, it might have so revived and consolidated its forces in the course of the 13th century, as to be able to cope successfully with the first advances of the Ottomans. The true statement is that the Fourth Crusade was only an incident (not in itself decisive) in a world-movement which doomed the Eastern Empire to extinction—namely, the eastward movement of western Europe which began in the 11th century with the rise of the Normans and the First Crusade. Henceforward the Empire was a middle state, pressed between expanding forces on the east and on the west, and its ultimate disappearance was inevitable.

Church and State.—In making the state Christian, Constantine made the Church a state institution, and therefore under imperial control. Caesaro-papism was the logical consequence. The sacerdotium was united with the imperium in the person of the monarch as in the pagan state. The Church acquiesced, and yet did not acquiesce, in this theory. When a heretical emperor sought to impose his views, champions of ecclesiastical freedom never failed to come forward. At the very beginning Athanasius fought for the independence of the Church against the emperor Constantius. But the political principle which Constantine had taken for granted, and which was an indispensable condition of his adoption of Christianity, was fully recognized under Theodosius I., and, notwithstanding protests from time to time, was permanent. It is significant that Constantinople, which had become a second Rome politically, with its senate and capitol, became then a second Rome ecclesiastically, and that the elevation of the see of Constantinople to patriarchal rank next to the Roman see was due to Theodosius (381), who gave a permanent form to the dualism of the Empire. The patriarch became a state minister for religion. The character of the Church as a state institution is expressed above all in the synods. The general councils are not only summoned by the emperor, but are presided over by him or by his lay deputies. The order of the proceedings is modelled on that of the senate. The emperor or his representative not only keeps order but conducts the deliberations and intervenes in the theological debates. It has been erroneously thought that at the council of Chalcedon (451) the legate of Pope Leo presided; but the

acts of that assembly teach us otherwise; the privilege which the Roman legates possessed was that of voting first (the right of the *princeps senatus*). The first general council at which a churchman presided was the seventh (at Nicea, 787), at which the emperor (or empress) deputed, not a layman, but the patriarch Tarasius to preside. The resolutions of these ecclesiastical state-councils did not become the law of the Empire till they were confirmed by imperial edicts.

The emperors, in their capacity as heads of the Church, did not confine themselves to controlling it by controlling the councils. They soon began to issue edicts dealing with theology, by virtue of their own authority. It has been said that the council of Chalcedon closed an epoch of "parliamentary constitutionalism"; a general council was not summoned again for more than one hundred years, though the Empire during that period was seething with religious disunion and unrest. The usurper Basiliscus in his short reign set an example which his successors were not slow to follow. He issued an edict quashing the decision of Chalcedon. Zeno's *Henötikon* (see below) a few years later was the second and more famous example of a method which Justinian largely used, and of which the *Ecthesis* of Heraclius, the *Type* of Constans II, and the iconoclastic edicts of Leo III. are well-known instances. It was a question of political expediency (determined by the circumstances, the intensity and nature of the opposition, &c.) whether an emperor supported his policy or not by an ecclesiastical council.

The emperor was always able to control the election of the patriarch, and through him he directed the Church. Sometimes emperor and patriarch collided; but in general the patriarchs were docile instruments, and when they were refractory they could be deposed. There were several means of resistance open to a patriarch, though he rarely availed himself of them. His participation in the ceremony of coronation was indispensable, and he could refuse to crown a new emperor except on certain conditions, and thus dictate a policy (instances in 812, Michael I.; 909, John Zimisces). There was the power of excommunication (Leo VI. was excommunicated on account of his fourth marriage). Another means of resistance for the Church was to invoke the support of the bishop of Rome, who embodied the principle of ecclesiastical independence and whose see admittedly enjoyed precedence and primacy over all the sees in Christendom. Up to the end of the 8th century he was a subject of the emperor, and some emperors exerted their ecclesiastical control over Rome by drastic measures (Justinian and Constans II.). But after the conquest of Italy by Charles the Great, the pope was outside the Byzantine domination; after the coronation of Charles in 800 he was associated with a rival empire; and when ecclesiastical controversies arose in the East, the party in opposition was always ready to appeal to him as the highest authority in Christendom. Under the iconoclastic emperors the image-worshippers looked to him as the guardian of orthodoxy.

As to the ecclesiastical controversies which form a leading feature of Byzantine history, their political significance alone concerns us. After the determination of the Arian controversy in 381 new questions (as to the union of the divine and human elements in the person of Christ: one or two natures?) arose, and it may seem surprising that such points of abstruse theology should have awakened universal interest and led to serious consequences. The secret was that they masked national feelings; hence their political importance and the attention which the government was forced to bestow on them. The reviving sense of nationality (anti-Greek) in Syria and in Egypt found expression in the 5th century in passionate monophysitism (the doctrine of one nature): theology was the only sphere in which such feelings could be uttered. The alienation and dissension which thus began had fatal consequences, smoothing the way for the Saracen conquests of those lands; the inhabitants were not unwilling to be severed politically from the Empire. This ultimate danger was at first hardly visible. What immediately troubled the emperors in the first half of the

5th century was the preponderant position which the see of Alexandria occupied, threatening the higher authority of Constantinople. The council of Chalcedon, called by Marcian, an able statesman, was as much for the purpose of ending the domination of Alexandria as of settling the theological question. The former object was effected, but the theological decision of the council was fatal, it only sealed and promoted the disunion. The recalcitrant spirit of Syria and Egypt forced Zeno, thirty years later, to issue his *Henötikon*, affirming the decisions of previous councils but pointedly ignoring Chalcedon. This statesman-like document secured peace in the East for a generation. Rome refused to accept the *Henötikon*, and when Justinian resolved to restore imperial supremacy in the Western kingdoms, conciliation with Rome became a matter of political importance. For the sake of this project, the unity of the East was sacrificed. The doctrine of Chalcedon was reasserted, the *Henötikon* set aside; New Rome and Old Rome were again hand in hand. This meant the final alienation of Egypt and Syria. The national instinct which had been alive in the 5th century grew into strong national sentiment in the 6th. One of the chief anxieties of Justinian's long and busy reign was to repair the mischief. Deeply interested himself in matters of dogma, and prepared to assert to its fullest extent his authority as head of the Church, he has been called "the passionate theologian on the throne"; but in his chief ecclesiastical measures political considerations were predominant. His wife Theodora was a monophysite, and he permitted her to extend her protection to the heretics. He sought new formulae for the purpose of reconciliation, but nothing short of repudiation of the Chalcedon acts would have been enough. The last great efforts for union were made when the Saracens invaded and conquered the dissident provinces. A new formula of union was discovered (One Will and One Energy). This doctrine of monothelism would never have been heard of but for political exigencies. The Egyptians and Syrians would perhaps have accepted this compromise; but it was repudiated by the fanatical adherents of Chalcedon. Heraclius sought to impose the doctrine by an edict (*Ecthesis*, 638), but the storm, especially in Italy and Africa, was so great that ten years later an edict known as the *Type* was issued by Constans forbidding all disputation about the number of wills and energies. Constans was a strong ruler, and maintained the *Type* in spite of orthodox opposition throughout his reign. But the expediency of this policy passed when the Saracens were inexpugnably settled in their conquests, and in his successor's reign it was more worth while to effect a reconciliation with Rome and the West. This was the cause of the 6th Ecumenical Council which condemned monothelism (680-681).

In the Hellenic parts of the Empire devotion to orthodoxy served as a chrysalis for the national sentiment which was to burst its shell in the 10th century. For the Greeks Christianity had been in a certain way continuous with paganism. It might be said that the old deities and heroes who had protected their cities were still their guardians, under the new form of saints (sometimes imaginary) and archangels, and performed for them the same kind of miracles. Pagan idolatry was replaced by Christian image-worship, which by the Christians of many parts of Asia Minor, as well as by the Mahomedans, was regarded as simply polytheism. Thus in the great iconoclastic controversy, which distracted the Empire for nearly 120 years, was involved, as in the monophysitism, the antagonism between different racial elements and geographical sections. Leo III., whose services as a great deliverer and reformer were obscured in the memory of posterity by the ill-fame which he won as an iconoclast, was a native of Commagene. His first edict against the veneration of pictures evoked riots in the capital and a revolt in Greece. The opposition was everywhere voiced by the monks, and it is not to be overlooked that for many monks the painting of sacred pictures was their means of existence. Leo's son Constantine V. pursued the same policy with greater rigour, meeting the monastic resistance by systematic persecution, and in his reign a general council condemned image-worship

(753). Iconoclasm was supported by the army (*i.e.* Asia Minor), and a considerable portion of the episcopate, but it was not destined to triumph. When the Athenian Irene, wife of Leo IV., came to power after her husband's death, as regent for her son Constantine VI., she secured the restoration of the worship of icons. The Iconoclastic Council was reversed by the 7th Ecumenical Council of 787. The iconoclastic party, however, was not yet defeated, and (after the neutral reign of Nicephorus I.) came again to the helm in the reigns of the Armenian Leo V. and the first two Phrygian emperors, Michael II. and Theophilus. But the Empire was weary of the struggle, and on the death of Theophilus, who had been rigorous in enforcing his policy, icon-worship was finally restored by his widow Theodora (843), and the question was never reopened. This was a triumph for the Greek element in the Empire; the "Sunday of orthodoxy" on which iconoclasm was formally condemned is still a great day in the Greek Church.

The ablest champions who wielded their pens for the cause of icons, defending by theological arguments practices which really had their roots in polytheism, were in the early stage John of Damascus and in the later Theodore (abbot of the monastery of Studium at Constantinople). The writings of the iconoclasts were destroyed by the triumphant party, so that we know their case only from the works of their antagonists.

In this struggle the Greeks and Latins were of one mind; the image-worshippers had the support of the Roman see. When the pope resisted him, Leo III. confiscated the papal estates in Sicily and Calabria; and the diocese of Illyricum was withdrawn from the control of Rome and submitted to the patriarch of Constantinople. But when iconoclasm was defeated, there was no question of restoring Illyricum, nor could there be, for political reasons; since the iconoclastic schism had, with other causes, led to the detachment of the papacy from the Empire and its association with the Frankish power. By the foundation of the rival Roman Empire in 800 the pope had definitely become a subject of another state. No sooner had the iconoclastic struggle terminated than differences and disputes arose between the Greek and Latin Churches which finally led to an abiding schism, and helped to foster the national self-consciousness of the Greeks. A strife over the patriarchal chair between Ignatius (deposed by Michael III. and supported by Rome) and Photius the learned statesman who succeeded him, strained the relations with Rome; but a graver cause of discord was the papal attempt to win Bulgaria, whose sovereign Boris had been baptized under the auspices of Michael III. (*c.* 865), and was inclined to play Old Rome against New Rome. Photius stood out as the champion of the Greeks against the claim of the Roman see, and his patriarchate, though it did not lead to a final breach, marks the definite emancipation of the Greeks from the spiritual headship of Rome. This is the significance of his encyclical letter (867), which formulated a number of differences in rite and doctrine between the Greek and Latin Churches, differences so small that they had never proved a barrier to union, if on one side there had been no question of papal supremacy, and if the Greek attitude had not been the expression of a tenacious nationality. There was a reconciliation about 900, but the Churches were really estranged, and the open and ultimate breach which came in 1054, when the influence of the Cluny movement was dominant at Rome (Leo IX. was pope and Michael Cerularius patriarch), sealed a disunion which had long existed. Subsequent plans of reunion were entertained by the emperors merely for political reasons, to obtain Western support against their foes, or to avert (through papal influence) the aggressive designs of Western princes. They were doomed to futility because they were not seriously meant, and the Greek population was entirely out of sympathy with these political machinations of their emperors. The Union of Lyons (1274) was soon repudiated, and the last attempt, the Union of Florence in 1439, was equally hollow (though it permanently secured the union of the Rumanians and of the Ruthenians). Part of the historical significance of the relations between the Greek and Latin

Churches lies in the fact that they illustrate, and promoted by way of challenge, the persistence of Greek national self-consciousness.

The emperors legislated against paganism and against heresy, not merely under ecclesiastical pressure, but because they thought religious uniformity politically desirable. Theodosius the Great, a Spaniard, with no sympathy for Hellenic culture, set himself the task of systematically eradicating pagan institutions and customs. Though his persecution accomplished much, paganism was far from being extinct either in the East or in the West in the 5th century. Not only did heathen cults survive in many remote districts, but the old gods had many worshippers among the higher classes at Rome, Constantinople, Antioch, Alexandria and Athens. The most distinguished Greek literati of that period were non-Christian. Justinian, who united theological enthusiasm with belief in the ideal of uniformity and, like Theodosius, was cut of sympathy with Hellenism ("Hellen" now came to mean "pagan"), persecuted polytheism more earnestly and severely than his predecessors. His measures created a panic among the higher classes at Byzantium, of whom many, as he suspected, were addicted to the ancient religion. He instituted a regular inquisition, exacted oaths of orthodoxy from all officials and teachers, and closed the philosophical schools of Athens. Missionaries (and it is remarkable that he employed monophysite heretics) were sent to abolish the old heathen worship which survived in many parts of Asia Minor where Christianity had hardly penetrated. By the end of the 6th century formal paganism had practically disappeared.

In Asia Minor, especially in the east, there were many dissident communities which asserted independence of the Church of Constantinople and of all ecclesiastical traditions, founding their doctrines directly on the Bible. Most important of these heretics were the Paulicians (*g.r.*), a dualistic sect whom the Church regarded as Manichaeans.

The Autocracy and its Constitutional Forms.—With Diocletian the Principate of Augustus had become undisguisedly an absolute monarchy, and this constitution prevailed to the end. There is virtually no constitutional history in the proper sense of the term in the later Roman Empire, for there was neither evolution nor revolution. The monarchical system remained in all its essential points unchanged, and presents a remarkable example of an autocracy of immense duration which perfectly satisfied the ideas of its subjects. No attempt was made to alter it,—to introduce, for instance, a limited monarchy or a republican government; all revolts and conspiracies were aimed at the policies of particular autocrats, not at autocracy itself; generally they only represented sectional antagonisms and personal ambitions. The emperors inherited a deeply rooted instinct of legality as a tradition from Old Rome; and this respect for law which marked their acts, along with the generally good administration of justice, was a palladium of the monarchy. They were supreme in legislation, as well as in the administrative and judicial spheres; but they were on the whole moderate in wielding legislation as an instrument of policy.

There were, however, recognized constitutional principles which it would have been impossible for the emperor to override.

(1) The elective principle, inherited from the Republic, was never changed. A new emperor had to be elected by the senate and acclaimed by the people. The succession never became automatic. But even Augustus had indirectly introduced the dynastic principle. Theodosius the Great, by causing his two sons, Arcadius and Honorius, to be elected Augusti in their infancy, practically elevated the dynastic idea into a constitutional principle; henceforward it was regarded as in the regular course that the son born to a reigning sovereign should in his infancy be elected Augustus. Thus the election, though always an indispensable form, was only a reality when a dynasty came to an end.

(2) When the position of Christianity was assured by the failure of Julian's reaction, it was evident that profession of that religion would henceforward be a necessary qualification for election to the throne. This was formally and constitutionally recognized when the coronation of the emperor by the patriarch was introduced in 457, or perhaps in 450.

(3) The sovereignty of the emperor was personal and *not territorial*. In this respect it always retained the character which it had inherited as the offspring of a Roman magistracy. Hence no Roman territory could be granted by the emperor to another power. For instance, the Western emperor Conrad III. could promise to hand over Italy to Manuel Comnenus as the dowry of his wife, but it would have been constitutionally illegal for Manuel to have made such a promise to any foreign prince; an Eastern emperor had no right to dispose of the territory of the state. Tendencies towards a territorial conception begin indeed to appear (partly under Western influence) in the time of the Palaeologi, especially in the custom of bestowing appanages on imperial princes.

(4) While the senate of Rome generally lost its importance and at last became a mere municipal body, the new senate of Constantinople preserved its position as an organ of the state till the fall of Constantinople. For the imperial elections it was constitutionally indispensable, and it was able sometimes to play a decisive part when the throne was vacant—its only opportunity for independent action. The abolition, under Diocletian's system, of the senatorial provinces deprived the senate of the chief administrative function which it exercised under the Principate; it had no legislative powers; and it lost most of its judicial functions. It was, however, still a judicial court; it tried, for instance, political crimes. In composition it differed from the senate of the Principate. The senators in the 4th century were chiefly functionaries in the public service, divided into the three ascending ranks of *clarissimi*, *spectabiles*, *illustres*. The majority of the members of the senatorial order lived in the provinces, forming a provincial aristocracy, and did not sit in the senate. Then the two lower ranks ceased to have a right to sit in the senate, which was confined to the *illustres* and men of higher rank (Patricians). The senatorial order must therefore be distinguished from the senate in a narrower sense; the latter finally consisted mainly of high ministers of state and the chief officials of the palace. It would be a grave mistake to underrate the importance of this body, through an irrelevant contrast with the senate of the Republic or even of the Principate. Its composition ensured to it great influence as a consultative assembly; and its political weight was increased by the fact that the inner council of imperial advisers was practically a committee of the senate. The importance of the senate is illustrated by the fact that in the 11th century Constantine X., in order to carry out a revolutionary, anti-military policy, found it necessary to alter the composition of the senate by introducing a number of new men from the lower classes.

(5) The memory of the power which had once belonged to the *populus Romanus* lingered in the part which the inhabitants of New Rome, and their representatives, played in acclaiming newly elected emperors, and in such ceremonies as coronations. In the 6th century the factions ("demes") of the circus, Blues and Greens, appear as political parties, distract the city by their quarrels, and break out in serious riots. On one occasion they shook the throne ("Nika" revolt, 522). The emperors finally quelled this element of disturbance by giving the factions a new organization, under "demarchs" and "democrats," and assigning them a definite quasi-political *locus standi* in the public ceremonies in the palace and the capital. The duty of providing *panem et circenses* was inherited from Old Rome; but the free distribution of bread cannot be traced beyond the 6th century (had the loss of the Egyptian granary to do with its cessation?), while the spectacles of the hippodrome lasted till the end. Outside the capital the people took little interest in politics, except when theology was concerned; and it may be said generally

that it was mainly in the ecclesiastical sphere that public opinion among the masses, voiced by the clergy and monks, was an influence which made itself felt.

The court ceremonial of Constantinople, which forms such a marked contrast to the ostensibly simple establishments of Augustus and the Antonines, had in its origin a certain constitutional significance. It was introduced by Diocletian and Diocletian, not, we must suppose, from any personal love of display, but rather to dissociate the emperor from the army, at a time when the state had been shaken to its foundations by the predominance of the military element and the dependence of the emperor on the soldiers. It was the object of Diocletian to make him independent of all, with no more particular relation to the army than to any other element in the state; the royal court and the inaccessibility of the ruler were calculated to promote this object. The etiquette and ceremonies were greatly elaborated by Justinian, and were diligently maintained and developed. The public functions, which included processions through the streets to various sanctuaries of the city on the great feast-days of the Church, supplied entertainment of which the populace never wearied; and it did not escape the wit of the rulers that the splendid functions and solemn etiquette of the court were an effective means of impressing the imagination of foreigners, who constantly resorted to Constantinople from neighbouring kingdoms and dependencies, with the majesty and power of the Basileus.

The imperial dignity was collegial. There could be two or more emperors (*imperatores*, *Basileis*) at the same time; edicts were issued, public acts performed, in their joint names. Through the period of dualism, in the 4th and 5th centuries, when the administration of the Eastern provinces was generally separate from that of the Western, the imperial authority was also collegial. But after this period the system of divided authority came to an end and was never renewed. There was frequently more than one emperor, not only in the case of a father and his sons, or of two brothers, but also in the case of a minority, when a regent or a minor emperor (Romanus I.; cf. Nicephorus II. and John Zimisces). But one colleague always exercised the sole authority, was the real monarch, the "great" or the "first" Basileus; the other or others were only sleeping partners. Under the Comneni a new nomenclature was introduced; a brother, e.g., who before could have become the formal colleague of the ruler, received the title of *Sebastocrator* (Sebastos was the Greek equivalent of Augustus).

Legislation.—The history of the legislation of the Eastern Empire is distinguished by three epochs associated with the names of (1) Justinian, (2) Leo III., (3) Basil I., and Leo VI.

(1) The Justinianean legislation (see JUSTINIAN) is thoroughly Roman in spirit, and inspired by piety, a return to the traditions of the past; but it admitted modifications in the light of the accordance with tendencies which had been long since making themselves felt: consideration is accorded to principles of humanity in the laws affecting persons, and to the principle of public interest in the laws relating to things. Justinian not only sanctioned changes which time had brought about, like the mitigation of the strict *patria potestas* and the greater independence of wives, but introduced a revolutionary change in the law of succession to property, abolishing inheritance by *agnatio* or relationship through males, and substituting inheritance by blood relationship whether through males or females.

(2) Justinian's reign was followed by a period in which juristic studies decayed. The seventh century, in which social order was profoundly disturbed, is a blank in legal history, and it would seem that the law of Justinian, though it had been rendered into Greek, almost ceased to be studied or understood. Practice at least was modified by principles in accord with the public opinion of Christian society and influenced by ecclesiastical canons. In a synod held at Constantinople in the reign of Justinian II., numerous rules were enacted, differing from the existing laws and based on ecclesiastical doctrine and Mosaic principles, and these were sanctioned as laws of the realm by the emperor. Thus Church influence and the decline of Roman tradition, in a state which had become predominantly Greek, determined the character of the ensuing legislative epoch under the auspices of Leo III., whose law book (*A.D.* 740), written in Greek, marks a new era and reflects the changed ideas of the community. Entitled a "Brief Selection of Laws" and generally known as the *Ecdloga*, it may be described as a Christian law book in regard to the *patria potestas* and in regard to a father's gift for emancipation from paternal control when the son comes to years of discretion, and the paternal is to a certain extent replaced by a parental control over minors. The law of guardianship is considerably modified. The laws of marriage are transformed under the influence of the Christian conception of matrimony; the institution of *concubinatus* is abolished. Impediments to marriage on account of consanguinity and of spiritual relationship are multiplied. While Justinian regarded marriage as a contract, and therefore, like any other contract, dissoluble at the pleasure of the parties, Leo III. accepted the Christian view that it was an indissoluble bond. Ecclesiastical influence is written

large in the criminal law, of which a prominent feature is the substitution of mutilation of various kinds for the capital penalty. Death is retained for some crimes, such as murder and high treason; other offences were punished by amputation (of hand, nose, &c.). This system (justified by the passage in the New Testament, "If thine eye offend thee," &c.), though to modern notions barbaric, seemed a step in the direction of leniency; and it may be observed that the tendency to avoid capital punishment increased, and we are told that in the reign of John Comnenus it was never inflicted. (The same spirit, it may be noted, is apparent in the usual, though by no means invariable, practice of Byzantine emperors to render dethroned rivals or members of a deposed dynasty innocuous by depriving them of eyesight or forcing them to take monastic orders, instead of putting them to death.) The Church, which had its own system of penalties, exercised a great influence on the actual operation of criminal law, especially through the privilege of asylum (recognized by Justinian, but with many reserves and restrictions), which was granted to Christian churches and is admitted without exceptions in the *Edoğa*.

(3) The last period of legislative activity under Basil I. and Leo VI. represents a reaction, in a certain measure, against the *Edoğa* and a return to Justinian. The *Edoğa* had met practical needs, but the Isaurian and Phrygian emperors had done nothing to revive legal study. To do so was the aim of Basil, and the revival could only be based on Justinianic law books or their Greek representatives. These books were now treated somewhat as Justinian and his lawyers had treated their own predecessors. A handbook of extracts from the Institutes, Digest and Code was issued in 879, and was intended to be used, it is said, to fulfil somewhat the same function as the Institutes. Then a collection of all the laws of the Empire was prepared by means of two commissions, and completed under Leo VI. It was entitled the *Basilikā*. In many points (in civil, but not in criminal, law) the principles of the *Edoğa* are set aside in favour of the older jurisprudence. Thus the Justinianic ordinances on the subject of divorce were revived, and there remained henceforward a contradiction between the civil and the canon law.

After this there was no legislation on a grand scale; but there was a great revival of legal study under Constantine IX., who founded a new law-school, and there were many learned specialists who wrote important commentaries, such as John Xiphilinos (11th century), Theodore Balsamon (12th century), Harmenopoulos (14th century). The civil code of Moldavia (published 1816-17) is a codification of Byzantine law; and modern Greece, although in framing its code it took the Napoleonic for its model, professes theoretically to base its civil law on the edicts of the emperors as contained in the *Hexabiblos* of Harmenopoulos.

Administration.—Three principles underlay the administrative reform of Diocletian: the separation of civil from military functions; the formation of small provincial units; and the scalar structure which deepened on the interposition of the vicar of a diocese and the praetorian prefect between the provincial governor and the emperor. This system lasted unchanged for three and a half centuries. The few unimportant alterations that were made were in harmony with its spirit, until the reign of Justinian, who introduced certain reforms that pointed in a new direction. We find him combining some of the small provinces into large units, undermining the scalar system by doing away with some of the dioceses and vicars, and placing in some cases military and civil authority in the same hands. The chief aim of Diocletian in his general reform had been to secure central control over the provincial governments; the object of Justinian in these particular reforms was to remedy corruption and oppression. These changes, some of which were soon cancelled, would hardly in themselves have led to a radical change; but they prepared the way for an administrative revolution, brought about by stress of external necessities. In the 7th century all the energies of the Empire, girt about by active enemies, were centred on war and defence; everything had to give way to military exigencies; and a new system was gradually introduced which led ultimately to the abolition of the old. The change began in Italy and Africa, at the end of the 6th century, where operations against the Lombards and the Berbers were impeded by the friction between the two co-ordinate military and civil authorities (masters of soldiers, and praetorian prefects). The military governors were made supreme with the title of *exarchs*, "viceroys"; the civil authority was subordinated to them in case of collision, otherwise remaining unaltered. The change is an index of the dangerous crisis through which these provinces were passing. In the East similar circumstances

led to similar results. The Saracen danger hanging imminent over Asia Minor imposed a policy of the same kind. And so before the end of the 7th century we find the Empire divided into six great military provinces, three in Europe and three in Asia: (1) Exarchate of *Africa*, (2) Exarchate of *Italy*, (3) *Strategia of Thrace*, (4) County of *Opsikion* (= *obsequium*), including Bithynia, Honorias, Paphlagonia, parts of Hellespontus and Phrygia, (5) *Strategia of the Anatoliki*, most of west and central Asia Minor, (6) *Strategia of the Armeniakoi*, eastern Asia Minor. In addition to these there was a naval circumscription, (7) the *Strategia of the Karabisianoi* (from *κάρβος*, a vessel), including the southern coastland of Asia Minor, and the Aegean (see below under *Navy*).

The lands of the old prefecture of Illyricum were not included in the system, because this part of the Empire was then regarded as a lost position. On the contrary, here military powers were committed to the Prefect of Illyricum, whose actual sphere extended little beyond Thessalonica, which was surrounded by Slavonic tribes.

The Eastern changes, perhaps initiated by Heraclius, but probably due mainly to Constans II., did not interfere with the civil administration, except in so far as its heads were subordinated to the military commanders. But Leo III., who as a great administrative reformer ranks with Augustus and Diocletian, did away with the old system altogether. (1) Reversing Diocletian's principle, he combined military and civil powers in the same hands. The strategos or military commander became also a civil governor; his higher officers (turmarshs) were likewise civil functionaries. (2) The scalar principle disappeared, including both the vicars and the praetorian prefect of the East (some of whose functions were merged in those of the prefect of the city); no authority interposed between the strategoi and the emperor. (3) The new provinces, which were called *themes* (the name marks their military origin: *thema* = corps), resembled in size the provinces of Augustus, each including several of the Diocletian divisions. This third and last provincial reform has, like its predecessors, its own history. The list of themes in the 11th century is very different from that of the 8th. The changes were in one direction—the reduction of large provinces by cutting off parts to form smaller themes, a repetition of the process which reduced the provinces of Augustus. Hence the themes came to vary greatly in size and importance. Leo himself began the process by breaking up the Anatolic command into two themes (Anatolic and Thracasian). The principle of splitting up was carried out systematically by Leo VI. (who was also responsible for a new ecclesiastical division of the Empire).

The development will be exhibited by a list of the themes in the middle of the 10th century. A. Asia: (1) Opsikion, (2) Optimaton, (3) Paphlagonia, (4) Bukellariani=old Opsikion, (5) Anatolic, (6) Thracasian, (7) Samos (naval), (8) Cappadocia, (9) Seleucia=old Anatolic, (10) Armeniac, (11) Colonea, (12) Sebastea, (13) Charsianon, (14) Chaldia, (15) Mesopotamias=old Armeniac, (16) Cibyrhaet, (17) Aegean (=Dodekaneisos). B. Europe: (1) Thrace, (2) Macedonia, (3) Strymon, (4) Thessalonica, (5) Hellas, (6) Peloponnesus, (7) Nicopolis, (8) Dyrrhachium, (9) Longibardia, (10) Cephallenia, (11) Cherson.

It is interesting to note that up to Leo VI. the district between Constantinople and the wall of Anastasius formed a separate theme or government, entitled the Wall (ὁ *πύργος*) or the Ditch (ὁ *ράβδος*); Leo VI. united it with the theme of Thrace.

In the central administration, the general principles seem to have remained unchanged; the heads of the great administrative bureaux in Constantinople retain the *palatine* character which belonged to most of them from the beginning. But there were many changes in these offices, in their nomenclature and the delimitation of their functions. There are great differences between the administrative corps in the 5th, in the 10th and in the 15th centuries. We can hardly be wrong in conjecturing that, along with his provincial reform, Leo III. made a rearrangement of the central bureaux; the abolition of the Praetorian Prefecture of the East entailed, in itself, modifications. But minor changes were continually being made, and we may note the following tendencies: (1) Increase in the number of ministers directly responsible to the emperor, (2) subordinate offices in the bureaux being raised to the rank

of independent ministries; (b) new offices being created and old ones becoming merely titular. (2) Changes in nomenclature; substitution of Greek for Latin titles. (3) Changes in the relative importance and rank of the high officials, both civil and military.

The Prefect of the City (*ἐπαρχος*) controlled the police organization and administration of justice in the capital; he was vice-president of the imperial court of justice, and, when the office of Prefect of the East was abolished, he inherited the functions of that dignity as judge of appeals from the provinces. But the *praefectus vigilum*, commander of the city guards, who was subordinate to him, became an independent officer, entitled Drungary of the Watch, and in the 11th century superseded him as vice-president of the imperial court. We are told that in the last years of the Empire the Prefect of the City had no functions at all; but his office survives in the *Shehr-imaneti*, "city prefecture," of the Ottomans, in whose organization there are many traces of Byzantine influence.

Instead of the Quaestor of the Sacred Palace, whose duty was to draft the imperial laws and rescripts, we find in the 9th century a quaestor who possesses certain judicial and police functions and is far lower in the hierarchy of rank. It has been supposed that the later quaestor really inherited the duties of another officer, the *quaesitor*, who was instituted by Justinian. In the latest period the quaestor, if he still existed as a name, had no functions.

The Master of Offices, who supervised the bureaux in the palace and was master of court ceremonies, also performed many functions of a minister of foreign affairs, was head of the imperial post (*cursor*), and of the corps of *agentes in rebus* or Imperial Messengers. This ministry disappeared, probably in the 8th century, but the title was retained as a dignity at all events till the end of the 9th. The most important functions, pertaining to foreign affairs, were henceforward performed by the Logothete of the Post (*λογοθέτης τοῦ ὁδοῦ*). In the 12th century this minister was virtually the chancellor of the Empire; his title was changed to that of Great Logothete by Andronicus II.

The two financial ministers, *comes sacrarum largitionum* and *comes rei privatae*, continued to the end under the titles *λογοθέτης τοῦ γενικοῦ* (General Logothete) and *ἐπί τοῦ ἰσικῶ* (Anastasius added a third, the Count of the Sacred Patrimony, but he was afterwards suppressed). But in the 9th century we find both these ministers inferior in rank to the *Sacellarius*, or private pursekeeper of the emperor. Besides these there was a fourth important financial department, that of the military treasury, under a Logothete.

The employment of eunuchs as high ministers of state was a feature of the Byzantine Empire from the end of the 4th century. It is laid down as a principle (A.D. 900) that all offices are open to them, except the Prefecture of the City, the quaestorship, and the military posts which were held by "Domestics." There were then eight high posts which could only be held by eunuchs, of which the chief were the *parakoimōmenos* and the *protovestiarhos* (master of the wardrobe).

An emperor who had not the brains or energy to direct the affairs of the state himself, necessarily committed the task of guiding the helm to some particular minister or court dignitary who had gained his confidence. Such a position of power was outside the constitution, and was not associated with any particular office; it might be held by an ecclesiastic or a eunuch; it had been held by the eunuchs Eutropius and Chrysaphius in the reigns of Arcadius and Theodosius II. respectively. In later times, such a first minister came to be denoted by a technical term, *ὁ παρὰβουαρρέων*. This was the position, for instance, of Stylianus, the father-in-law of Leo VI. Most of the emperors between Basil II. and Alexius Comnenus were under the influence of such ministers.

The orders of rank (which must be distinguished from titles of office) were considerably increased in later times. In the 4th and 7th centuries there were the three great classes of the *illustres*, *spectabiles* and *clarissimi*; and above the *illustres* a small, higher class of patricians. In the 9th century we find an entirely different system; the number of classes being largely augmented, and the

nomenclature different. Instead of epithets like *illustres*, the names are titles which had designated offices; "patrician" alone survives. The highest rank is now (1) the *magistroi*; then come the patricians in two classes: (2) proconsular patricians, (3) respectable patricians; below these (4) *protospatharioi*; (5) *dishypatoi* (= *bis consules*); (6) *spatharokandidatoi*; (7) *spatharioi*; and other lower ranks. Particular ranks do not seem now to have been inalienably attached to particular offices. The strategos of the Anatolic Theme, e.g., might be a patrician or only a *protospathar*. Whoever was promoted to one of these ranks received its insignia from the emperor's hand, and had to pay fixed fees to various officials, especially to the palace eunuchs.

In the provinces ordinary justice was administered by judges (*κπραι*) who were distinct from the governors of the themes, and inherited their functions from the old provincial governors of Diocletian's system. In Constantinople higher and lower courts of justice sat regularly and frequently. The higher tribunals were those of the Prefect and the Quaestor, before whom different kinds of cases came. Appeals reached the emperor through the bureau of Petitions (*τῶν δεησίων*); he might deal with the case immediately; or might refer it to the imperial court of appeal, of which he was president; or else to the special court of the Twelve Divine Judges (*θεῖοι δίκασται*), which was instituted by Justinian.

While the administration of justice was one of the best features of the Eastern Empire, its fiscal system, likewise inherited from the early Empire, was one of its worst. If the government had been acquainted with the principles of public economy, which have not been studied till comparatively recent times, a larger revenue might have been raised without injuring the prosperity of the inhabitants. Taxes were injudiciously imposed and oppressively collected. The commerce of the Empire was one of its great sources of strength, but the government looked on the merchants as a class from which the utmost should be extorted. The chief source of revenue was the land. The main burdens which fell upon the landed proprietors throughout the whole period were the land tax proper and the *annona*. The land tax (*capitatio terrena*)=the old *tributum* of the imperial, *stipendium* of the senatorial, provinces) was based, not on the yearly produce, but on the capital of the proprietor, the character and value of the land being taken into account. In later times this seems to have become the *καπνικόν*, or hearth tax. The *annona* was an additional impost for supporting the army and imperial officials; it was originally paid in produce. In later times, we meet it under the name of *συναρμία* or *συνωμή*. The province was divided into fiscal districts, and the total revenue to be derived from each was entered in a book of assessment. The assessment was in early times revised every fifteen years (the "indiction" period), but subsequently such revisions seem to have been very irregular. The collection of the taxes was managed through the curial system, while it lasted (till 7th century?). The decurions, or municipal councillors, of the chief town in each district were responsible for collecting and delivering the whole amount, and had to make good the sums owed by defaulters. This system of collective responsibility pressed very heavily on the decurions, and helped to cause their decay in the Western provinces. After the abolition of the curial organization, the principle of collective responsibility remained in the form of the *ἐπιβολή* or additional charge; that is, if a property was left without an owner, the taxes for which it was liable became an extra charge on the other members of the district (*ὁ δόμοσπότης*). The taxes were collected by *praktōres*, who were under the General Logothete. The peasant proprietors were also liable to burdens of other kinds (*corvées*), of which the most important was the furnishing of horses, vehicles, postboys, &c., for the state post (see *ANGARIA*).

The history of landed property and agrarian conditions in the Eastern Empire still awaits a thorough examination. It may be noted that individual hereditary proprietorship was always the rule (on crown and monastic lands as well as in other cases), and that the commonly supposed extensive existence of communities possessing land in common is based on erroneous interpretation of documents. When imperial lands were granted to monasteries or as fiefs (*πρόσοια*) to individuals, the position and rights of the peasant proprietor on the estates were not changed, but in many

cases the imposts were paid to the new master instead of to the fisc. In the 4th, 5th and 6th centuries the cultivators were attached to the soil (*coloni, ascriptici*; see SERFDOM), in the interests of the fiscus; it has been supposed, on insufficient grounds, that this serfdom was abolished for a time by Leo III., though it is probable that the condition of the peasants was largely changed by the invasions of the 7th century. In any case the system of compulsory attachment of peasants to their lands remained in force, and the class of adscriptici (*ἀσκητοὶ*) existed till the latest times. The chief sources for agrarian conditions are besides the imperial laws, monastic records, among which may be mentioned as specially valuable those of the Monastery of Lemboi near Smyrna.

Army and Navy.—The general principle of the military defence of the Empire in the 4th century consisted in large forces stationary on the frontiers, and reserve forces, stationed in the interior provinces, which could be moved to any point that was in danger. Thus the army was composed of (1) the *limitanei*, frontier-troops (under *duces*), and (2) reserve forces (under *magistri militum*) of two denominations, (a) *palatini* and (b) *comitatenses*. The *limitanei* were the more numerous; it has been estimated that if they numbered about 350,000, the *comitatenses* and *palatini* together amounted to less than 200,000. It is to be noted that for the old legion of 6000 men a smaller legion of 1000 had been substituted, and that the proportion of cavalry to infantry was small. In the 6th century the fundamental principles of the system were the same; but the cavalry had become a much more important branch of the service, and in the wars of Belisarius the *foederati*, barbarian mercenaries of various races, commanded by their own chiefs, played a great rôle. The peasants of Illyria and Thrace, the mountaineers of southern Asia Minor still supply an important part of the army, but the number of barbarians (Heruli, Vandals, Goths, Slavs, Arabs, &c.) is much larger. Solidity and a corresponding want of mobility characterized at this time both cavalry and infantry; their great merit was straight and rapid shooting; Belisarius ascribed his success in Italy to the excellence of the archery. It is remarkable with what small forces (not more than 25,000) the first conquest of Italy was achieved, though Belisarius was far from being a military genius and the discipline in his army was flagrantly defective.

Frontier Defence.—Justinian carried out on the frontiers and in the exposed provinces a carefully devised and expensive system of defensive works. Fortified towns along the *limes* were connected by intervening forts, and at some distance behind was a second line of more important fortresses more strongly garrisoned, which furnished both a second barrier and places of refuge for the inhabitants of the open country. There was an elaborate system of signals by which the garrisons of the front stations could announce not only the imminence of a hostile invasion, but the number and character of the enemy. In North Africa there are abundant remains of the fortifications of the 6th and 7th centuries, displaying the military architecture of the period and the general frontier system. The typical fortress had three defences: the wall flanked by square towers of three storeys; at a few yards' distance a second wall of stone; and outside a deep foss about 20 yds. wide, with vertical sides, filled with water, and along its edge a rampart of earth.

We have already seen how the disasters and losses of the 7th century led to a radical change in the military organization, and how the Empire was divided into themes. The preponderant influence which Asia Minor won and retained till the 11th century is reflected in the military establishment, which mainly depended on the Asiatic provinces. The *strategos* of a large theme commanded a corps of 10,000 and the scheme of the divisions and subordinate commands has a remarkable resemblance to the organization of some of the armies of modern Europe.

The recorded scheme was probably not uniform in all the themes, and varied at different periods. The *thēma* (corps) consisted of 2 *turmai* (brigades) under *turmarchai*; the *turma* of 5 *banda* (regiments), each under a *drungarios* (colonel); the *bandon* of 5 *penarkhiai* (companies) under a *komētēs* (captain). The *pentarkhia*, containing 200 men, had 5 subdivisions under *pentekomarkhiai* (lieutenants); and there was a smaller unit of ten men under the *dekarhies* (corporals). The total strength in the 9th century was 120,000; in Justinian's time it was reckoned at 150,000.

Distinct from the military forces (*θλαυρα*) of the provinces were the forces (*ράγματα*) stationed in or near the capital. The most important of these were the *Scholae* and the *Excubitores*. The *Scholarii* troops were in early times under the Master of Offices, but subsequently their chief officer, the Domestic of the Schools, became the highest military commander in the Empire next to the *Strategos* of the Anatolic Theme. In war, when the emperor did not assume the chief command himself, he might entrust it to any

commander, and he often entrusted it to the Domestic. In the 11th century, after the conquest of Bulgaria, there were two *Domestics*, one for the east and one for the west, and under Alexius Comnenus the Domestic of the west received the title Great Domestic. Under the *Palaeologi* the Great Domestic was superior in rank to all other ministers.

Besides the *Scholarii*, and the *Excubitores* (who had been organized in the 5th century), there were the regiments of the *Hikanatoi*, the *Ariftoi*, the *Numeroi*, the *Numeroi* were foot-soldiers. The *Optimatoi* also infantry, properly belonged to the same category, though they were constituted as a theme. It is to be observed that the demes or corporations of Constantinople were partly organized as militia, and were available for purposes of defence.

The great difference between this Byzantine army and that of the earlier Empire is that its strength (like that of the feudal armies of the West) lay entirely in cavalry, which the successors of Heraclius and the *Isaurian* emperors developed to great perfection. The few contingents of foot were quite subsidiary. The army was free from the want of discipline which was so notable in the 6th century; it was maintained in Asia Minor, which was the great recruiting ground, by a system of military holding of land (an extension of the old Roman system of assigning lands in the frontier districts to federate barbarians and to veterans). The conditions of the marauding expeditions and guerrilla warfare, continuously carried on against and by the Saracens in the 8th, 9th and 10th centuries, were carefully studied by generals and tacticians, and we possess the theory of the Byzantine methods in a treatise composed by the emperor Nicephorus Phocas, and edited by one of his pupils. Every detail of an inroad into Saracen territory is regulated.

In the 8th and 9th centuries there was a system of signals by which an approaching Saracen incursion was announced to Constantinople from the Cilician frontier. The news was flashed across Asia Minor by eight beacon fires. The first beacon was at Lulon (which commanded the pass between Tyana and the Cilician gates), the last on Mt. Auxentius in Bithynia. When this fire appeared, a light was kindled in the pharos of the imperial palace at Constantinople. The system was discontinued in the reign of Michael III., probably after the capture of Lulon by the enemy in 860, and was not renewed, though Lulon was recovered in 877. It should be noted that this famous telegraphic system was only an application on a large scale of the frontier signalling referred to above.

At least a great part of the army of the Seljuks, and the disorganization of the provinces which they did not acquire, seriously weakened the army, and the emperors had recourse more and more to foreign mercenaries and barbarian auxiliaries. The employment of Scandinavians had begun in the 10th century, and in 988 was formed the Varangian guard, consisting chiefly of English adventurers. In the arsenal of Venice are two lions, which were transported from the Peiraieus, inscribed with obscure Runic characters, carved perhaps by Scandinavians in the army of Basil II. Under Michael IV, the famous Norwegian prince Harald Hardrada (described by a Greek writer as Araltes, son of the king of Varangia (?) fought for the Empire in Sicily and in Bulgaria. But in the latter part of the 11th century foreign mercenaries greatly increased in numbers and importance.

The note of the Byzantine army was efficiency, and nowhere is the immeasurable superiority of the civilization of the Eastern Empire to the contemporary states of Europe more apparent. The theory of military science was always studied and taught; constant practice, interpreting and correcting theories, safeguarded it against pedantry; and a class of magnificent staff officers were trained, who in the 10th century were the terror of the enemy. The particular tactics of the various foes whom they had to face were critically studied. We have a series of military text-books, from the time of Anastasius I. to that of Basil II., in which we can learn their principles and methods. In this army there was plenty of courage, a distinct professional pride, but no love of fighting for fighting's sake, nor the spirit which in western Europe developed into chivalry. The Byzantines despised such ideas as characteristic of barbarians who had physical strength and no brains. The object of a good general, as Leo VI. shows in his important treatise on Tactics, was in their opinion not to win a great battle, but to attain success without the risks and losses of a great battle. The same author criticizes the military character of the Franks. Paying a tribute to their fearlessness, he points out their want of discipline, the haphazard nature of their array and order of battle, their eagerness to attack before they were ready, their want of facility for strategy or tactical combinations, their incapacity for operations on difficult ground, the ease with which they could be deceived by simple artifices, their carelessness in pitching camps, and their lack of a proper intelligence department. These criticisms, borne out by all we know of feudal warfare, illustrate the contrast between a western host, with its three great "battles," rushing headlong at the foe, and the Byzantine army, with its large number of small units, co-operating in perfect harmony, under a commander who had been trained in military science, had a definite plan in his head, and could rely on all his subordinates for strict and intelligent obedience.

Under the early Empire, as Rome had no rival in the Mediterranean, it was natural that the navy and naval theory should be neglected. When Constantine the Great decided to besiege Byzantium by sea, both he and his opponent Licinius had to create fleets for the struggle. Even when the Vandals in Africa made transmarine conquests and became a naval power, the Romans did not seriously address themselves to building an efficient navy and securing their own thalassocracy; the Vandals harried their coasts; their expeditions against Africa failed. And even when the Vandal power was in its decline and Belisarius set forth on his successful expedition of conquest, his fears for the safety of his squadron in case he should be attacked at sea allow us to suspect that the fleet of the enemy was superior to the Roman. The conquest of Africa secured for Justinian the undisputed command of the Mediterranean, but he did nothing for the naval establishment. It was not till the Saracens, aspiring to conquer all the Mediterranean coastlands, became a naval power that the Roman Empire was forced, in a struggle for its being, to organize an efficient fleet. This, as we saw, was the work of Constans II., and we saw what it achieved. In this first period (c. 650-720) the naval forces, designated as the *Karabisianoi*, were placed under the command of an admiral, with title of *strategos*. They consisted of two geographical divisions, each under a *dunargios*: the province of the *Cybhrrhaeots* (probably named from the smaller *Cybra* in Pamphylia) which included the southern coast districts of Asia Minor, and the Aegean province, which embraced the islands and part of the west coast of Asia Minor. The former was the more important; the marines of this province were the hardy descendants of the pirates, whose subjugation had taxed the resources of the Roman government in the last years of the Republic. It was a new principle to impose the burden of naval defence on the coast and island districts. Distinct from these fleets, and probably organized on a different principle, was the naval contingent stationed at Constantinople. Leo III. changed the naval administration, abolishing the supreme command, and making the *Cybhrrhaeot* and Aegean provinces separate independent themes under *strategoi*. The change was due to two motives. There was a danger lest a commander of the whole navy should become over powerful (indicated in the political rôle played by the navy before Leo's accession); but apart from this, the general reform of Leo, which united civil and military powers in the same hands, naturally placed the commanders of the two branches of the navy on a new footing, by making them provincial governors. In this and the following reigns, the tendency was to neglect the fleet; the interest of the government was concentrated on the army. For a time this policy proved successful, but under the Omeyyad dynasty was growing weak, and then under the Abbasids who transferred the capital from Damascus to Bagdad, the sea-power of the caliphate declined. But the neglect of the fleet was avenged in the 9th century, when Crete and Sicily were wrested from the Empire, the loss of south Italy was imminent, and Moslem squadrons sailed in the Adriatic,—losses and dangers which led to a reorganization of the navy under Basil I. and Leo VI. After this reform we find the navy consisting of two main contingents: the imperial fleet stationed at Constantinople, and the provincial fleets, three in number, of (a) *Cybhrrhaeot* theme, (b) Aegean theme, (c) theme of Samos. A small distinct contingent was supplied by the *Mardaites* who, natives of Mt. Lebanon, had been transplanted (partly to Pamphylia, partly to Epirus, the Ionian Islands, and Peloponnesus). The imperial fleet seems to have consisted of about 100 warships manned by 23,000 marines (the same men fought and rowed); the provincial fleets of 77 warships manned by 17,000. When the fleets acted together, the admiral in supreme command for the time was called the "diamond of the naval forces." The warships (*βρόνται*, "dromons") were mainly birmes, but there were also unirmes, built for speed, called "galleys" (*γαλαται*). Pyrotechnic was an important department in the naval establishment; the manufacture of the terrible explosive known as *liquid or marine fire* (see GREEK FIRE) was carefully guarded as a state secret.

The navy, active and efficient in the 10th century, is described by a military and therefore unprejudiced officer of the 11th as the glory of Rome. But towards the end of the 11th century it declined, the main cause being the disorganization of the naval provinces of Asia Minor, which, as we saw, was a result of the Seljuk conquest of the interior. This decline had important indirect consequences; it led to the dependence of the Empire on the Venetian navy in the struggle with the Norman power, and for this help Venice exacted commercial privileges which injured Byzantine commerce and opened the door to the preponderant influence of the Venetians in eastern trade. In the period of the Palaeologi the imperial navy, though small, was active; and the importance which it possessed for the state is illustrated by the high rank at court which the admiral (who in the 11th century had received the title of Great Duke, *μῆγας δόξας*) then occupied; the only minister who was superior to him was the Great Domestic.

Diplomacy.—In protecting the state against the barbarians who surrounded it, diplomacy was a weapon as important in the eyes of the Byzantine government as soldiers or fortifications.

The peace on the frontiers was maintained not only by strong military defences, but by more or less skilful management of the frontier peoples. In the later Empire this kind of diplomacy, which we may define as the *science of managing the barbarians*, was practised as a fine art; its full development was due to Justinian. Its methods fall under three general heads. (1) One people was kept in check by means of another. The imperial government fomented rivalry and hatred among them. Thus Justinian kept the Gepidae in check by the Lombards, the Kuturgurs by the Utigurs, the Huns by the Avars. (2) Subsidies were given to the peoples on the frontiers, in return for which they undertook to defend the frontier adjacent to them, and to supply fighting men when called upon to do so. The chiefs received honours and decorations. Thus the Berber chiefs on the African border received a staff of silver, encrusted with gold, a silver diadem, white cloak, embroidered tunic, &c. More important potentates were invested with a costlier dress. In these investitures precedence was carefully observed. The chiefs thus received a definite position in the Empire, and the rich robes, with the ceremony, appealed to their vanity. In some cases they were admitted to posts in the official hierarchy,—being created Patricians, Masters of soldiers, &c. They were extremely fond of such honours, and considered themselves half-Romans. Another mode of winning influence was to marry barbarian princes to Roman wives, and rear their sons in the luxury of the palace. Dissatisfied pretenders, defeated candidates for kingship, were welcomed at Constantinople. Thus there were generally some princes, thoroughly under Byzantine influence, who at a favourable opportunity could be imposed on their compatriots. Throughout Justinian's reign there was a constant influx of foreign potentates to Constantinople, and he overwhelmed them with attentions, pompous ceremonies and valuable presents. (3) Both these methods were already familiar to the Roman government, although Justinian employed them far more extensively and systematically than any of his predecessors. The third method was new and characteristic. The close connexion of religion and politics at Constantinople prepares us to find that Christian propaganda should go hand-in-hand with conquest, and that the missionary should co-operate with the soldier. The missionary proved an excellent agent. The typical procedure is as follows. In the land which he undertakes to convert, the missionary endeavours to gain the confidence of the king and influential persons, and makes it a special object to enlist the sympathies of the women. If the king hesitates, it is suggested that he should visit New Rome. The attraction of this idea is irresistible, and when he comes to the capital, the pomp of his reception, the honours shown him by the emperor, and the splendour of the religious ceremonies overcome his last scruples. Thereafter imperial influence is predominant in his domain; priests become his advisers; a bishop is consecrated, dependent on the patriarch of Constantinople; and the barbarians are transformed by the penetration of Byzantine ideas. By the application of these various means, Justinian established Roman influence in Nubia, Ethiopia and South Arabia, in the Caucasian regions, and on the coast of the Euxine. The conversion of the Lazi (of Colchis) was specially notable, and that of the Sabiri, who were politically important because they commanded the eastern pass of the Caucasus known as the Caspian Gates. It will be observed that the great prestige of the Empire was one of the conditions of the success of this policy.

The policy had, of course, its dangers, and was severely criticized by the one of Justinian's contemporaries, the historian Procopius. Concessions encouraged greater demands; the riches of the Empire were revealed. It was a system, of course, which could not be permanently successful without military power behind it, and of course it was not infallible; but in principle it was well-founded, and proved of immeasurable value. Less prejudiced writers than Procopius fully admit the far-sightedness and dexterity of the emperor in his diplomatic activity. A full account of it will be found in Diehl's *Justinian*.

In the 10th century we have again the means of observing how the government conducted its foreign policy on carefully

thought out principles. The Empire was then exposed to constant danger from Bulgaria, to inroads of the Magyars, and to attacks of the Russians. The key to the diplomatic system, designed to meet these dangers, was the cultivation of friendly relations with the Petchenegs, who did not menace the provinces either by land or sea and could be incited to act against Russians, Bulgarians or Magyars. The system is explained in the treatise (known as *De administrando imperio*) composed by the emperor Constantine Porphyrogenetos (c. 950). The series of these northern states was completed by the kingdom of the Khazars (between the Caucasus and the Don), with which the Empire had been in relation since the time of Heraclius, who, to win its co-operation against Persia, promised his daughter in marriage to the king. Afterwards the Khazars gave two empresses to New Rome (the wives of Justinian II. and Constantine V.). Their almost civilized state steered skilfully between the contending influences of Islam and Christianity, and its kings adopted the curious means of avoiding suspicion of partiality for either creed by embracing the neutral religion of the Jews. Commercial and political relations with the Khazars were maintained through the important outpost of the Empire at Cherson in the Crimea, which had been allowed to retain its republican constitution under a president (*ἑταίρειον*) and municipal board (*ἀρχόντες*), though this freedom was limited by the appointment of a *strategos* in 833, a moment at which the Khazars were seriously threatened by the Petchenegs. The danger to be feared from the Khazars was an attack upon Cherson, and it seems probable that this was a leading consideration with Leo III. when he wedded his son Constantine V. to a Khazar princess. In the 9th century it was an object of the government to maintain the Khazars (whose army consisted mainly of mercenaries) against the Petchenegs; and hence, if it should become necessary to hold the Khazars in check, the principle was to incite against them not the Petchenegs, but other less powerful neighbours, the Alans of the Caucasus, and the people of "Black Bulgaria" on the middle Volga (a state which survived till the Mongol conquest).

For this systematic diplomacy it was necessary to collect information about the peoples whom it concerned. The ambassadors sent to the homes of barbarous peoples reported everything of interest they could discover. We owe to Priscus a famous graphic account of the embassy which he accompanied to the court of Attila. We possess an account of an embassy sent to the Turks in Central Asia in the second half of the 6th century, derived from an official report. Peter the Patrician in Justinian's reign drew up careful reports of his embassies to the Persian court. When foreign envoys came to Constantinople, information was elicited from them as to the history and domestic politics of their own countries. It can be shown that some of the accounts of the history and customs of neighbouring peoples, stored in the treatise of Constantine Porphyrogenetos referred to above (furnishing numerous facts not to be found anywhere else), were derived from barbarian ambassadors who visited Constantinople, and taken down by the imperial secretaries. We may conjecture with some probability that the famous system of the *Relazioni*, which the Venetian government required from its ambassadors, goes back originally to Byzantine influence.

BIBLIOGRAPHY.—1. General works: Gibbon's *Decline and Fall of the Roman Empire*; Finlay's *History of Greece* (ed. Tozer; vols. i.-iv., 1877); Hof's *Geschichte Griechenlands* (in Ersch and Gruber, *Encyclopädie* 1. Sekt., vols. lxxv., lxxvi., 1876-78); Hertzberg, *Geschichte der Byzantiner und des osmanischen Reiches bis gegen Ende des 16. Jahrhunderts* (1883); Παπαρηγοπούλου, *ἱστορία τοῦ ἑλληνικοῦ ἔθνους* (5 vols., 2nd ed., 1878-88); Oman, *The Byzantine Empire* (1892) (a popular sketch); Gelzer, *Abriß der byzantinischen Kaisergeschichte*, in Krumbacher's *Geschichte der byzantinischen Literatur* (ed. ii., 1897) (a summary but original outline). 2. Works dealing with special periods, or branches of the subject: Schiller, *Geschichte der römischen Kaiserzeit* (vol. ii., 1877) (Diocletian to Theodosius the Great); Hodgkin, *Italy and her Invaders* (8 vols., 1879-99) (to A. D. 800); Bury, *History of the Later Roman Empire*, A. D. 395-800 (2 vols., 1889); Diehl, *Justinian* (1901); Diehl, *L'Afrique byzantine*

(1896); Pernice, *L'Imperatore Eraclio* (1905); Rambaud, *L'Empire grec au dixième siècle* (1870); Schlumberger, *Nicéphore Phocas* (1 vol.) and *L'Épopée byzantine* (3 vols., 1890-1905); 4 vols., finely illustrated, covering the period 960-1057); Gay, *L'Italie méridionale et l'empire byzantin, 867-1071* (1904); Neumann, *Die Weltstellung des byzantinischen Reiches vor den Kreuzzügen* (1894); Meliarakes, *ἱστορία τοῦ βασιλείου τῆς Νικαίας καὶ τοῦ βυζαντινοῦ τῆς Ἑλλάδος* (1898); Gerland, *Geschichte des lateinischen Kaiserreiches von Konstantinopel* (part i., 1905); Fallmerayer, *Geschichte des Kaiserthums Trapezunt* (1877); Norden, *Das Papsttum und Byzanz* (1903); Pears, *The Fall of Constantinople, being the story of the Fourth Crusade* (1885), and *The Destruction of the Greek Empire* (1903).

(J. B. B.)

ROMANES, GEORGE JOHN (1848-1894), British biologist, was born at Kingston, Canada, on the 20th of May 1848, being the third son of the Rev. George Romanes, D.D., professor of Greek at the university of that town. He was educated in England, going in 1867 to Gonville and Caius College, Cambridge. He early formed an intimate friendship with Charles Darwin, whose theories he did much during his life to popularize and support. When studying under Sir J. Burdon Sanderson at University College, London, in 1874-76, he began a series of researches on the nervous and locomotor systems of the Medusae and Echinodermata, which provided him with material for his Croonian lecture in 1876. Subsequently he continued the inquiry, partly in conjunction with Professor J. Gossett Ewart, and the results were published in *Jelly-fish, Star-fish, and Sea-urchins* (1885). Meantime he had been also devoting his attention to broader problems of biology. In 1881 he published *Animal Intelligence*, and in 1883 *Mental Evolution in Animals*, in which he traced the parallel development of intelligence in the animal world and in man. He followed up this line of argument in 1888 with *Mental Evolution in Man*, in which he maintained the essential similarity of the reasoning processes in the higher animals and in man, the highest of all. In 1892 he brought out an *Examination of Weismannism*, in which he upheld the theory of the hereditability of acquired characters. In 1890 he left London and settled at Oxford, where he founded a lecture similar to the "Rede" of Cambridge, to be delivered annually on a scientific or literary topic. In 1893 he published the first part of *Darwin and after Darwin*, a work dealing with the development of the theory of organic evolution, and based on lectures, which he delivered as Fullerian professor of physiology at the Royal Institution in 1888-91; a second part appeared in 1895 after his death, which occurred at Oxford on the 23rd of May 1894.

Romanes was awarded the Burney prize at Cambridge in 1873 for an essay on "Christian Prayer and General Laws." Five years later, under the pseudonym "Phyciscus," he issued *A Candid Examination of Theism*, in which he showed himself out of accord with orthodox religious beliefs. In 1882 he published an article on the "Fallacy of Materialism," and in his Rede lecture of 1885 he appeared as a monist. Subsequently his views again changed in the direction of orthodoxy, as is shown by his *Thoughts on Religion*, written shortly before his death and published in 1895.

His *Life and Letters*, by his widow, appeared in 1896.

ROMANIN, SAMUELE (1808-1861), Venetian historian, was born of a poor Jewish family at Trieste. Being left an orphan at an early age, he provided for his younger brothers and sister by giving French and German lessons. In 1821 he settled in Venice, where he afterwards translated Hammer-Purgstall's *Geschichte des osmanischen Reiches* into Italian. He next published his own *Storia dei Popoli Europei* (Venice, 1843-44). He taught in a private school and was sworn interpreter in German to the courts of justice; on the expulsion of the Austrians in 1848 he was appointed professor of history by the provisional government, and he lectured on Venetian history at the Ateneo Veneto. In 1852 he began to publish his monumental *Storia documentata di Venezia*, but although he finished the work, carrying it down to the fall of the republic in 1798, he did not live to see the publication completed, as he died of apoplexy on the 9th of September 1861; among his papers were found all the documents which were to be added,

and the index. The tenth and last volume was issued in 1861.

After Romanin's death his lectures on Venetian history were published in two volumes (Florence, 1875). Among his minor works we may mention: *Gli Inquisitori di Stato di Venezia* (Venice, 1858), *Bajamonte Tiepolo e le sue ultime vicende* (Venice, 1851), and *Venezia nel 1789* (Venice, 1860).

ROMAN LAW.¹ The term "Roman law" is indefinite and ambiguous, being used in more than one sense. First, in a wide sense, it comprehends the totality of the laws of the Roman state, which were observed by its subjects during about thirteen centuries, from Romulus to Justinian. In a second and stricter meaning it indicates the law as consolidated by Justinian or, in other words, the law contained in the *Corpus Juris Civilis*, which is the name that has been given since the 16th century to Justinian's legislative works as a whole, and distinguishes them from the *Corpus Juris Canonici*. In this acceptation it is equivalent to, and is often called, "civil law" as contrasted with canon law. In a third and loose sense Roman law embraces, in addition to the *Corpus Juris*, the interpretations of it after Justinian by medieval and modern courts, jurists and commentators adapting it to the customs and laws of their own countries and times. The German expression, for example, *modernes* (or *heutiges*) *römisches Recht*, indicates the Roman law as it was applied in Germany in modern times. Such medieval and modern interpretation, however, is also sometimes expressed, in English usage at least, by the term "civil law" as contrasted with native or common law; writers in this field being usually styled civilians rather than Romanists. It is to the Roman law in the first of the above-mentioned three significations that the present article is devoted.

To give a proper sketch of Roman law it must be treated historically. Nearly all systems of positive law are the product more or less of an historic development, but the Roman has this great advantage over other systems, that it was at all times a homogeneous body complete in itself.

For the Romans were comparatively little indebted to other peoples for their jurisprudence, and, when they did borrow legal ideas and institutions from others, they generally transformed or modified these in adapting them to their own native system, so that they became substantially Roman. Moreover, the various stages of progress of the law from its genesis to its maturity and ultimate consolidation can be traced in unbroken continuity. Beginning in 753 B.C., the traditionally accepted date of the foundation of Rome, it continued its course till the death of Justinian in A.D. 565. Allowing for the first three centuries being without historic evidence, we have at least an authenticated evolution of about 1000 years. Of no other system of law, ancient or modern, can anything like the same thing be said.

As to the proper method of historic treatment there have been different opinions. Without going into these, it is enough to say that the subject may be treated from two sides, viz. on the one side in relation to the external sources of the law, including therein the political and social conditions and the various constitutional changes at different periods affecting the development of the law, as well as the modes in which the law manifested itself and the legal literature from which our knowledge of it is derived; on the other side it may be treated in relation to the several departments or institutions of the law in view of their development or changes through time or circumstance, such as marriage, slavery, property, and so forth. This corresponds to what Leibnitz described as *external* and *internal* history respectively, terms which are now rather out of vogue. Of course it is possible to treat the historic sources of the law, constitutional and literary, independently of the doctrines, and this is now often done; but unless both are discussed the field of Roman law is not covered. Both the external and the

internal history, however, may be treated together or in a measure interwoven, and it is in this way that the subject is treated in the following pages. But constitutional events affecting the law are only noticed very summarily, details about these being given in separate articles.

Modern writers on the history of the Roman law have as a rule, for the purpose of systematic treatment, divided the subject into definite historic periods. Gibbon, in the 44th chapter of his *Decline and Fall of the Roman Empire*, seems to have been the first to suggest this mode of treatment, though the particular periods of division he selected (being based on an artificial symmetry of about three hundred years each) are not satisfactory.² In the present article, the division made by Muirhead in his article in the 9th edition of this Encyclopaedia into five historic epochs has been left unaltered. These are: (1) the regal period; (2) the *jus civile*, representing the period from the establishment of the Republic until the subjugation of central and southern Italy; (3) the *jus gentium* and *jus honorarium*, representing the latter half of the Republic; (4) the *jus naturale* and maturity of Roman jurisprudence, representing the period of the Empire until the beginning of the reign of Diocletian; (5) the period of codification, i.e. from Diocletian to Justinian. Not that there is any sharp or fundamental division between these or, indeed, between any historic epochs. The law is a unity; it has its roots in the past and grows with the nation itself, and, like it, decays; there is no break in its continuity. The division is made merely for convenient treatment of the subject.

It must be kept in view that our knowledge of Roman customs and laws earlier than the XII. Tables and even for some time after them cannot be based on strict historical evidence; it is almost entirely traditional and conjectural, and different writers will take different views according to the relative value they place upon this or that piece of presumptive evidence.

It is only the private law that is dealt with in the present article.

I. THE REGAL PERIOD

1. *The People and the Law.*

The Beginnings of the State.—The early Romans were not different from other Indo-European communities in their essential characteristics. The tribe, the clan, the family, the individual: each of these appears in course of development prior to the XII. Tables. Putting aside much of the traditional accounts of Livy, Dionysius, and other ancient historians, regarding the foundation of Rome and its early political and social life, as mythical, modern critical historians are none the less agreed that in the earliest period of their existence as a settled community the Romans were subjected to the government of a king (*rex*), with a council of elders (*senatus*) and an assembly of burghers (*comitia curiata*).

It used to be a somewhat common opinion that the primitive Romans were a sort of amalgam of three different races—Latin, Sabine and Etruscan. This opinion is mainly based upon the tradition that the state was originally formed by a union of three tribes called Ramnes, Tities and Luceres; the Ramnes being of the Latin race, the Tities of the Sabine and the Luceres of the Etruscan. Attempts have even been made to find in the Roman laws and institutions traces of the influence of each of these races, and especially of the first two—*patria potestas* and *manus*, for example, being attributed to the Latin or dominant race; adoption and confarreatio to the Sabine; forms and ceremonial (such as lictors, fasces, &c.) to the Etruscan.³ But this attractive theory of a union of three races, apart from the suspicion of a symbolic trichotomy (*tres tribus*) due to later times, is based on no substantial evidence;⁴ many of the

² See as to historic epochs Muirhead, *Hist. Intro. to the Law of Rome* (2nd ed. by Goudy, 1899), p. 421.

³ See Muirhead, *Historical Introduction* (2nd ed., 1899), pp. 3-5, and authorities there cited.

⁴ Some writers deny the existence of the tribes altogether, but this goes too far. See Bruns-Lenel in Holtzendorff's *Encyclopädie d. Rechtswissenschaft*, i. p. 867.

¹ This article represents a recast of the article contributed to the 9th edition of the *Encyclopaedia* by the late Professor Muirhead. A large part of that article has been retained by the present writer, and the plan of arrangement, though altered in some respects, has been adhered to in the main.

institutions attributed to the Sabines and Etruscans were, as Mommsen and others have shown, common to all peoples of Greek-Italian stock, and could not be strange to the Latins. We must hold that the Romans were essentially a Latin race, though influenced by a considerable admixture with Sabine and, to a lesser degree, Etruscan races (see *ROME*).

Patricians, Clients and Plebeians.—But whatever their ethnographic descent, it is pretty certain that the Roman civitas *Divisions* was in the earliest period an organization that was patriarchal in its essence, but in which there was to be distinguished, on the one hand, a dominant class enjoying all the rights of citizenship, and, on the other, a semi-servile or quasi-vassal class excluded from such rights. The former class were called *patricii* or *Quirites*;¹ the latter were called *clientes* and (later) *plebeii*.

Patricians.—There was part of the law of Rome that even in the Empire was known by the name of *jus Quiritium*, and this in the regal period was the only law. The patricians at first were the *Quirites*, and prior at least to the time of Servius Tullius they alone enjoyed rights under this law. From their number the council of elders was selected; they alone could take part in the curiate comitia; they alone could contract a lawful marriage and make a testament; in a word, all the peculiar institutions of early Rome were for their benefit alone.

But these rights and prerogatives they enjoyed as members of *gentes* or clans, the clans being aggregations of families bearing a common name and theoretically at least tracing their descent from a common ancestor. These clans, of which there were normally three hundred altogether according to a rather doubtful tradition, were organized constitutionally in curies. Of the curies, again, there were thirty in all, there being probably ten in each of the three tribes, organized primarily for military and secondarily for political and religious purposes. Though for the federation of the *curiae* and *gentes* Rome required a common ruler and common institutions, religious, military and political, yet it was long before such federation into a state displaced entirely the separate institutions of the several *gentes*. Every clan had its own cult peculiar to its own members. It had its common property and its common burial-place. It probably had some common council or assembly, for we read not only of special gentile customs, but of gentile statutes and decrees. Tradition records instances of wars waged by individual *gentes*, indicating that they had the right to require military service alike from their members and dependants. Widows and orphans of deceased clansmen were under the guardianship of the *gens* or of some particular member of it to whom the trust was specially confided. If a clansman left no descendants, his property passed to his fellow-gentiles. Finally, its members were always entitled to rely upon its assistance, to have maintenance when indigent, to be ransomed from captivity, and to be avenged when killed or injured.

Along with the gentiles there were in Rome from the earliest period other persons known by the name of *clientes* (clients).

Clients. Their origin is wholly unknown. Some of them may have been the original inhabitants of Rome and their descendants, but more probably they were mostly immigrants from other communities or citizens of conquered towns whom the Romans were unable or unwilling to treat as slaves. Some may have been slaves to whom liberty *de facto* had been given. Following a custom familiar both to Latins and Sabines, such persons were placed under the protection of the heads of patrician families. The relationship was hereditary on both sides, and known as that of patron and client. The client²

¹ The derivation of the name is uncertain, and ancient writers differed about it. It probably comes either from *quiris*, a Sabine word for a spear, or from *curia*. The derivation from *Cures* is inadmissible. See Mommsen, *Röm. Staatsrecht* (1887, 1888), iii. 1, p. 5 n.

² The derivation of *cliens* from *cluere* indicates the relationship—one who is called on, who hearkens. The theory that clientage

became a dependent member of his patron's clan—not *gentilis* but *gentilicium*. His patron had to provide him with what was necessary for his sustenance and that of his family; and, as ownership or possession of lands increased in extent, it was probably not unusual for the patron or his *gens* to give him during pleasure a plot of land to cultivate for himself. The patron had, moreover, to assist him in his transactions with third parties, and obtain redress for him when injured. The client, on the other hand, had to maintain his patron's interests by every means in his power. But the advantage must have been chiefly on the side of the client, who, without becoming a citizen, obtained directly the protection of his patron and his clan, and indirectly that of the state. A large number of clients attached themselves to and received protection from the king as patron—"royal clients," as Cicero calls them.

The plebeians (*plebs*, from *πληθος*, meaning crowd), as distinguished from the clients, must be regarded as a heterogeneous mass of non-gentile freemen. It used to be the prevailing opinion among modern writers, following the Roman historians, that the plebeians existed as a body since the very beginning of the city. They were thought to be mainly composed of immigrants and refugees who, while being allowed personal liberty, declined to submit themselves to a patron. But recently a theory of Mommsen, based on solid philological and other grounds, has obtained wide adhesion and tends to become the dominant one. Mommsen's view is that at first there were only two classes in the community, the patricians and clients, or, in other words, that the only plebeians were the clients who, as such, possessed only quasi-liberty (*Halbfreiheit*), and that it was not till after a century or two that the practice of voluntary clientage began to decay and the class of plebeian freemen arose. This was partly due to *gentes* dying out, so that the clients attached to them were left without patrons; partly to the numbers of foreigners at Rome (through transplantation of the inhabitants of conquered cities and otherwise) having become so large that they felt themselves sufficiently powerful to do without protection; and partly to other causes.³

However this be, it is generally admitted that, during the latter part of the present epoch at least, plebeians existed as a body composed of individuals of mixed races not united by any gentile organizations of their own nor attached to any Roman *gentes*. Tradition attributes to Numa the formation of guilds or societies of craftsmen, such as potters, carpenters, gold- and silver-smiths (*collegia officinam*) at Rome, eight or nine in number. This, though probably a myth as regards Numa, may be taken as slight evidence of the creation among the plebeians of associations for trade and other purposes, that to some extent compensated them for the want of gentile organization. These guilds seem to have had a common cult and a common council to arrange disputes and consolidate customs. Between the brethren (*sodales*) there was a bond of close alliance and interdependence, each owing duty to the other similar to what might be claimed from a guest or a kinsman.

The Regulations of Public and Private Order.—It would be absurd to expect any definite system of law in those early times. What passed for it was a composite of *fas*, *jus* and *boni mores*, whose several limits and characteristics it is extremely difficult to define. This may to some extent be accounted for by the fact that much of what was originally within the domain of *fas*, once it had come to be enforced by secular tribunals, and thus had the sanction of human authority, was no longer distinguishable from *jus*; while it may be that others of its bests, once pontifical punishments for their contravention had gone into desuetude, sank to nothing higher than precepts of *boni mores*.

arose from the voluntary subjection of poorer citizens to the rich is an hypothesis supported by no satisfactory authority.

³ Mommsen, *Staatsrecht*, iii. 1, pp. 66 seq. and pp. 127 seq. For a different view, Karlowa, *Röm. Rechtsgeschichte*, i. 62. Cf. Cuq, *Instit. Jurid. des Romains* (2nd ed., 1904-8), i. 11-12.

By *fas*¹ was understood the will of the gods, the laws given by heaven for men on earth, much of it regulative of ceremonial, but a by no means insignificant part embodying rules of conduct. It appears to have had a wider range than *jus*. It forbade that a war should be undertaken without the prescribed fetial ceremonial, and required that faith should be kept even with an enemy when a promise had been made to him under sanction of an oath. It enjoined hospitality to foreigners, because the stranger guest was presumed, equally with his entertainer, to be an object of solicitude to a higher power. It punished murder, for it was the taking of a god-given life; the sale of a wife by her husband, for she had become his partner in all things human and divine; the lifting of a hand against a parent, for it was subversive of the first bond of society and religion,—the reverence due by a child to those to whom he owed his existence; incestuous connexions, for they defiled the altar; the false oath and the broken vow, for they were an insult to the divinities invoked; the displacement of a boundary or a landmark, not so much because the act was provocative of feud, as because the march-stone itself, as the guarantee of peaceful neighbourhood, was under the guardianship of the gods. Some breaches of *fas* were expiable, usually by a peace-offering to the offended god; others were inexecutable. When an offence was inexecutable, the punishment was usually what is called *sacratio capitis*, excommunication and outlawry of the offender. The precepts of the *fas* therefore were not mere exhortations to a blameless life, but closely approached to laws, whose violation was visited with punishments none the less effective that they were religious rather than civil.

The derivation of the word *jus* is disputed. The usual derivation is from the Sanskrit, *ju*, to "join, bind or unite," from which some deduce as its signification "that which binds," "the bond of society," others "that which is regular, orderly or fitting." Bréal identifies it with the *jos* or *jans* of the Vedas, and the *jaes* or *joos* of the Zend-Avesta—words whose exact meaning is controverted, but which he interprets as "divine will or power."² If Bréal's definition can be adopted we obtain a very significant interpretation of the words addressed by the presiding magistrate to the assembled comitia in asking them whether they assented to a law proposed by him.—*Veliis, jubeat, Quirites, &c.*, "Is it your pleasure, Quirites, and do you hold it as the divine will, that," and so on. As legislation by the comitia of the curies and centuries was regarded as a divine office, and their vote might be nullified by the fathers on the ground that there had been a defect in the *auspicia*, and the will of the gods consequently not clearly ascertained, this explanation of Bréal's seems not without support,—*vox populi vox dei*. If it be right, then the main difference between *fas* and *jus* was that the will of the gods, which both embodied, was in the one declared by inspired and in the other by merely human agency.

This *jus* might be the result either of traditional and inveterate custom (*jus moribus constitutum*) or of statute (*lex*).³ As to the customs, it can well be believed that at the outset they were far from uniform; that not only the customs of the three original tribes but those also of the different *gentes* varied,

¹ Bréal derives *fas* from the Greek *θεός*. It signifies the divinely inspired word. Bréal et Bailly, 101.

² *Novae. rev. hist.* (1883), p. 605. But see J. Schmidt in Mommsen, *Staatsrecht*, iii. 310 n.

³ For the distinction between *jus* and *lex*, see Mitteis, *Römischer Privatrecht* (1908), i. 30 seq. There is some controversy about the etymology of the word *lex*. See Bréal, *l.c.* p. 610; Schmidt in Mommsen, *S.R.* iii. 308 n. While *lex* is often used like *jus* to express law generally, it early acquired two distinct meanings, viz. (1) an obligation of any kind expressly incorporated in a private deed (*lex privata*), as in the phrases *lex mancipii*, *lex contractus*, &c.; (2) a comital enactment, hence occasionally called *lex publica* (Gaius, i. 3 and ii. 104). But by the jurists of the Republic this latter meaning was extended so as to cover all laws resulting from the will of the people, including, for example, plebiscites and even senatorial or proconsular ordinances (*leges datae*).

and that they only gradually approximated, and in course of time consolidated into a general *jus Quiritium*. Of legislation there was, so far as is known, practically almost nothing.

What went by the name of *boni mores* (as distinct from *jus moribus constitutum*) must also be regarded as one of the regulatives of public and private order. Part of what fell within their sphere might also be expressly regulated by *fas* or *jus*; but there was much that was only gradually brought within the domain of these last, and even down to the end of the Republic not a little that remained solely under the guardianship of the family tribunal or the censor's *regimen morum*. The functions of those who took charge of *boni mores* were twofold: sometimes they restrained by publicly condemning—though they could not prevent—the ruthless and unnecessary exercise of legal right, as, for example, that of the head of the house over his dependants, and sometimes they supplied deficiencies in the law by requiring observance of duties that could not be enforced by any legal process. Dutiful service, respect and obedience from inferiors to superiors, chastity, and fidelity to engagements, express or implied (*fides*), were among the *officia* that were thus inculcated, and whose neglect or contravention not only affected the reputation, but often entailed punishments and disabilities, social, political or religious. It was the duty of those in authority to enforce their observance by such *animadversio* as they thought proper—the *paterfamilias* in his family, the *gens* among its members, the king in relation to the citizens generally; and many a wrong was prevented not by fear of having to make reparation to the party injured but by the dread of the penalties that would follow conduct unbecoming an upright citizen.

That the bulk of the law during the regal period was customary is universally admitted, and that no laws were committed to writing prior to the XII. Tables is generally believed. Yet the jurist Pomponius, a contemporary of Hadrian, speaks of certain laws enacted by the comitia of the curies, which he calls *leges regiae* and which, he says, were collected by one Sextus Papirius, a prominent citizen in the reign of Tarquinius Superbus, under the name of *Jus Papirianum*.⁴ We are also told by Paul that this work was commented on by a certain Granius Flaccus,⁵ who was, it is supposed, of the time of Julius Caesar or Augustus. No remains of this *Jus Papirianum* are extant, but we have a considerable number of so-called *leges regiae* cited by Livy, Dionysius and others, which contain rules of the private law relating almost entirely to matters of *fas* and which appear to have been enacted under the kings. We are also told by Servius, the commentator on Virgil, that there was a work known to Virgil called *de Ritu Sacrorum*, in which *leges regiae* were collected.⁶ The authenticity of these laws, however, is disputed, and the question is one of difficulty. Some modern writers of high authority (e.g. Mommsen hold that the *Jus Papirianum* is an apocryphal compilation made from pontifical records about the close of the Republic.⁷ It has even been attributed (the suggestion was first made apparently by Gibbon) to Granius Flaccus himself. Nevertheless, the internal evidence from the character and language of the laws themselves (apart from the weight that must be given to the testimony of Pomponius, Servius and other ancient writers) is favourable to their great antiquity, and it is best to accept the view that the *leges regiae* are authentic remains of laws of the regal period. This does not, however, involve the belief that they were collected by Papirius, nor that they were enactments of the *comitia curiata*, as Pomponius says. They seem rather to have been regulations made by the king at his own hand.

⁴ *Dig. i. 2. 2. § 2* and § 36. In the latter passage Papirius is given the praenomen Publius.

⁵ *Dig. i. 16. 144.*

⁶ Serv., in *Aeneid*, 12, 836, cited in Bruns, *Fonnes*, p. 3.

⁷ It has been suggested that a work of the jurist Manlius mentioned by Pomponius (*Dig. i. 2. 2. § 39*) is its source (*Zeitschrift f. Sav. Stif.* xxiv. 420).

or perhaps old-established customs formulated by the higher pontiffs and ascribed to the kings.¹

It is also stated by Dionysius that under Servius Tullius various laws, fifty in number, dealing with contracts and delicts, were enacted in the comitia of the curies.² But we have no corroboration of this, and recent writers are now generally agreed in regarding the statement as a legend.

ii. Reforms of Servius Tullius.

It is generally agreed that towards the end of the regal period, and connected with the king traditionally called Servius Tullius, a great reform of the constitution took place, which exercised much influence on the subsequent development of the law. No doubt there is a good deal of myth attached to the name of Servius, who seems to have been regarded by later Romans as a popular monarch, like Alfred by the English, but the main features of the traditional account of the constitutional reforms of this period may be taken as based on fair presumptive evidence. That all of them indeed were evolved from one brain is hardly credible, and that some of them were in observance *de facto* before being made constitutionally binding is very likely.

The design attributed to Servius was that of altering the old constitution in order to promote an advance towards equality between patricians and plebeians. He is credited with having desired, on the one hand, to ameliorate the position of the plebs and, on the other, to make them bear a proportionate share of the burdens of the state—in particular, to serve in the army and contribute to the war tax (*tributum*). He effected this by giving them qualified rights of citizenship, not indeed by admitting them into the gentile organizations, but by creating a new political assembly of a distinctly military character in which they as well as the gentiles could take part. The so-called Servian reforms may be roughly summarized under the following four heads, viz. (1) a division of the Roman territory within the city walls into four local wards called *tribus* (to which a number of tribes outside the city—*tribus rusticæ*—were afterwards in course of time added); (2) the establishment of a register of the citizens (*census*) which was to contain, in addition to a record of the strength of their families, a statement of the value of their lands, with the slaves and cattle employed in their cultivation, and which was to be revised periodically; (3) a division of the people, as appearing in the census, into five classes for military purposes, determined by the value of their holdings in land and its appurtenances, with a subdivision of each class into so-called *centuriæ*; (4) the creation of a new assembly with legislative power called *comitia centuriata*, in which the vote was to be taken by *centuriæ*. While it may be an open question how far these reforms, and particularly the institution of the centuriate comitia, were actually due to Servius, or only a result of his arrangements, the whole conception of the new constitution is obviously of early date and indicative of considerable statesmanship.

The plebeians were thereby made constitutionally part of the *populus Romanus*; they became citizens (*Quirites*).³ They got *commercium* and also *connubium* so far that their marriages *inter se* were recognized as legal marriages. Rights and duties

¹ See Clark, *Hist. of Rom. Law* (1906), i. 16-19; Kipp, *Geschichte d. Quellen* (1903), pp. 24-25. The most comprehensive treatise on these royal laws, which also contains references to the earlier literature, is that of Voigt, *Über die Leges Regiæ* (Leipzig, 1876). An exhaustive collection of them, including numerous references to royal institutions by Livy, Dionysius and others, is given in Bruns, *Fontes Juris*, 6th ed. i. 1 seq. Another collection is in Girard, *Textes*, 3rd ed. pp. 3 seq.

² Dion. iv. 10, 13.

³ The view of some recent writers that the plebeians had at all times participated in the *jus Quiritium* and were admitted to the curiate comitia and even had gentile rights (see Lenel in Holtzendorff's *Encyclopædie d. Rechtswissenschaft*, 6th ed. i. 90 n. 2, and authorities there cited), must be decidedly negatived. Not only does it render the whole tradition about the Servian reforms untrustworthy, but the accounts of the struggles between patricians and plebs in the early Republic are left largely without meaning.

were so far to be measured by each citizen's position as a holder of lands; the amount of land (including slaves and cattle appurtenant thereto)⁴ held by him on *quiritarian* title was to determine the nature of the military service he was to render, the tribute he was to pay, and his right to take part in the new political assembly. It is indeed probable that a good while before Servius the conception of individual ownership of lands and things necessary for their cultivation had been reached, and that such ownership was recognized not only among the gentiles, but also *de facto* even more largely among the plebeians. The common lands of the *gentes* had become split up, to a considerable extent, among families and individuals. However this be, the creation of the *census* ensured, as far as possible, certainty of title, as it was declared that no transfers of property enrolled in it would be recognized unless made by public conveyance with observance of certain prescribed formalities.⁵ The form of conveyance thus legally sanctioned was called originally *mancipium*, afterwards *mancipium*, and at a still later period *mancipatio*, while the lands and other things that were to pass by it came to be known as *res mancipii* (or *mancipi*). Hence arose a distinction of great importance in the law of property (which lasted till Justinian formally abolished it), between *res mancipi* and *res nec mancipi*; the former being transferable only by mancipation or surrender in court, the latter by simple delivery (see *infra*, p. 541).

iii. Institutions of the Private Law.

*Law of the Family.*⁶—The word *familia* in Roman law had at once a more extensive and a more limited meaning than it has in its English form. Husband, wife and *The children* did not necessarily constitute an independent family among the Romans, as with us, nor were they all necessarily of the same one. Those formed a family who were all subject to the power—originally *manus*,⁷ later *paterfamilias* or *jus*—of the same head (*paterfamilias*). The *paterfamilias* was himself a member of the family only in the sense in which a king is a member of the community over which he rules. He might have a whole host dependent on him, wife and sons and daughters, and daughters-in-law and grandchildren by his sons, and possibly remoter descendants related through males; so long as they remained subject to him they constituted but one family, that was split up only on his death or loss of citizenship. But if his wife had not passed in *manum* (a result apparently unknown among the patricians at this period), she did not become a member of his family: she remained a member of the family in which she was born, or, if his head were deceased or she had been emancipated, she constituted a family in her own person. Both sons and

⁴ Modern writers are not agreed as to whether movable *res mancipi* were included with lands in the valuation of property for fixing the classes.

⁵ Or else by *cessio in jure*, though this may not have been before the XII. Tables, and it was in any case of very limited operation.

⁶ On tribal family and matriarchy among the Romans in pre-historic times, consult Westermarck, *History of Human Marriage* (London, 1891); Post, *Grundriss der ethnologischen Jurisprudenz* (1894), i. 15-160. *Familia* and family are used in this section solely to designate the group of free persons subject by birth, marriage or adoption to the same *paterfamilias*. Strictly the word *familia* meant the household and all belonging to it. It had also the following principal meanings: (1) a *gens* or branch of a *gens* (group of families in the stricter sense); (2) the whole body of agnate kinsmen (*familia communi jure*); (3) the family estate or *patrimonium*, as in the provisions of the XII. Tables about intestate succession, e.g. *agnatus proximus familiam habeto*; (4) the family slaves collectively, as in the phrase *familia rustica*. See Mommsen, *Staatsr.* iii. 10 n. 16 n. 22; Rivier, *Précis du droit de famille romain* (Paris, 1891), § 1.

⁷ This word *manus*, though in progress of time used technically to express the power (hand) of a husband over his wife in *familia*, was originally the generic term for all the rights exercised, not only over the things belonging but also over the persons subject to the head of the house—as seen, for example, in the words “*manumissionem*” and “*emancipationem*.” Cf. *Inst.* i. 5 pr. It should be observed that among uncivilized peoples there is always a very small vocabulary, and the same word often has to do duty in several senses—e.g. *familia*, *mancipium*, *nexum*, *caput*.

daughters on emancipation ceased to be of the family of the *paterfamilias* who had emancipated them. A daughter's children could never as such be members of the family of their maternal grandfather; for children born in lawful marriage followed the family of their father, while those who were illegitimate ranked from the moment of birth as *paterfamilias* and *matresfamilias*.

With the early Romans, as with the Hindus and the Greeks, marriage was a religious duty a man owed alike to his ancestors and to himself. Believing that the happiness of the dead in another world depended on their proper burial and on the periodical renewal by their descendants of prayers and feasts and offerings for the repose of their souls, it was incumbent upon him above all things to perpetuate his race and his family cult. The Romans were always strictly monogamous. In taking to himself a wife, he was about to detach her from her father's house and make her a partner of his family mysteries. With the patrician at least this was to be done only with divine approval, ascertained by *auspicia*. His choice was limited to a woman with whom he had *connubium* (*ἐκγαμία*) or right of intermarriage. This was a matter of state arrangement; and in the regal period Roman citizens could have it outside their own bounds only with members of states with which they were in alliance, and with which they were connected by the bond of common religious observances. A patrician citizen, therefore, if his marriage was to be reckoned lawful (*justae nuptiae*), had to wed either a fellow-patrician or a woman who was a member of an allied community. In either case it was essential that she should be outside his sobriental circle, i.e. more remote in kinship than the sixth degree. The ceremony was a religious one, conducted by the chief pontiff and the flamen of Jupiter, in presence of ten witnesses, representatives probably of the ten curies of the bridegroom's tribe, and was known as *farreum* or *confarreatio*. Its effect was to dissociate the wife entirely from her father's house, and to make her a member of her husband's; for confarreate marriage involved in *manum conventio*, the passage of the wife into her husband's "hand" or power, provided he was himself *paterfamilias*; if he was not, then, though nominally in his hand, she was really subject like him to his family head. Any property she had of her own—which was possible only if she had been independent before marriage—passed to him as a matter of course; if she had none, her *paterfamilias* usually provided her a dowry (*dos*), which shared the same fate. In fact, so far as her patrimonial interests were concerned, she was in much the same position as her children; and on her husband's death she had a share with them in his inheritance as if she had been one of his daughters. In other respects *manus* conferred more limited rights than *patria potestas*; for Romulus is said to have ordained that, if a man put away his wife except for adultery or one or two other grave offences, he forfeited his estate half to her and half to Ceres, while if he sold her he was to be given over to the infernal gods.¹

Patria potestas was the name given to the power exercised by a father, or by his *paterfamilias* if he was himself in *potestate*, over the issue of such *justae nuptiae*. The Roman jurists boasted that it was a right enjoyed by none but Roman citizens; and it certainly was peculiar to them in this sense, that nowhere else, except perhaps among the Latin race from which they had sprung, did the paternal power attain such an intensity. The omnipotence of the *paterfamilias* and the condition of utter subjection to him of his children in *potestate* became greatly modified in the course of centuries; but originally the children, though in public

life on an equality with the house-father, in private life, and so long as the *potestas* lasted, were subordinated to him to such an extent as, according to the letter of the law, to be in his hands little better than his slaves. They could have nothing of their own: all they earned was his; and, though it was quite common when they grew up for him to give them *pecunia*, "cattle of their own," to manage for their own benefit, these were only *de facto* theirs, but *de jure* his. For offences committed by them outside the family circle, for which he was not prepared to make amends, he had to surrender them to the injured party, just like slaves or animals that had done mischief. If his right to them was disputed, he used the same action for its vindication that he employed for asserting his ownership of his field or his house: if they were stolen, he proceeded against the thief by an ordinary action of theft; if for any reason he had to transfer them to a third party, it was by the same form of conveyance that he used for the transfer of things inanimate. Nor was this all; for, according to the old formula recited in that sort of adoption known as *adrogatio*, he had over them the power of life and death, *jus vitae necisque*.

It might happen that a marriage was fruitless, or that a man saw all his sons go to the grave before him, and that the *paterfamilias* had thus to face the prospect of the extinction of his family and of his own descent to the tomb without posterity to make him blessed. To obviate so dire a misfortune, he resorted to the practice of adoption, so common in India and Greece. If it was a *paterfamilias* that he adopted, the process was called *adrogatio* (*adrogatio*); if it was a *filiusfamilias* it was simply *adoptio*. The latter, unknown probably in the earlier regal period, was, as we first know it, a somewhat complicated conveyance of a son by his natural parent to his adopter, the purpose of course being expressed; its effect was simply to transfer the child from the one family to the other. But the former was much more serious, for it involved the extinction of one family that another might be perpetuated. It was therefore an affair of state. It had to be approved by the pontiffs, who probably had to satisfy themselves that there were relatives of the adoptee to attend to the *manes* of the ancestors whose cult he was renouncing; and on their favourable report it had to be sanctioned by a vote of the curies, as it involved the deprivation of his *gens* of their possible right of succession to him and possible prejudice to creditors through *capitis deminutio*. If it was sanctioned, then the *adrogatus*, from being himself the head of a house, sank to the position of a *filiusfamilias* in the house of his adopting parent; if he had had wife or children subject to him, they passed with him into his new family, and so did everything that belonged to him and that was capable of transmission from one person to another. The adopting parent acquired *potestas* over the adopted child exactly as if he were the issue of his body; while the latter enjoyed in his new family the same rights exactly that he would have had if he had been born in it.

The *manus* and the *patria potestas* represent the masterful aspects of the patrician's domestic establishment. Its conjugal and parental ones, however, though not so prominent in the pages of the jurists, are not to be lost sight of. Domestic relations. The patrician family in the early history of the law was governed as much by *fas* as by *jus*. The husband was priest in the family, but wife and children alike assisted in its prayers, and took part in the sacrifices to its lares and penates. As the Greek called his wife the house-mistress, *δὲσπορα*, so did the Roman speak of his as *materfamilias*,² the house-mother. She was treated as her husband's equal. As for their children, the *potestas* was so tempered by the natural sense of parental duty on the one side and filial affection on the other that in daily life it was rarely felt as a grievance; while the risk of an arbitrary exercise of the domestic jurisdiction, whether in the heat of passion or under the impulse of justifiable resentment, was

¹ See Plutarch, *Rom.* 22; Marquardt, *Röm. Altert.* v. 7. The question whether a husband could in early law sell his wife is one on which modern writers are not agreed. The better opinion is that he could not do so if the marriage was by confarreatio. Apart from the *lex regia* above mentioned, it would have been inconsistent with her dignity as *materfamilias*. There is certainly no trace of its having been done. In marriages by coemption and *usus*, on the other hand, it is not improbable that it was allowed, though here also there is no evidence of it.

² *Materfamilias* is used in the texts in two distinct senses—(1) as a woman *sui juris*, i.e. not subject to any family head; and (2) as a wife in *manu mariti*.

guarded against by the rule which required in grave cases the *paterfamilias* to consult in the first place the near kinsmen of his child, maternal as well as paternal. Even the incapacity of the children of the family to acquire property of their own cannot in those times have been regarded as any serious hardship; for, though the legal title to all their acquisitions was in the house-father during his life, yet in truth they were acquired for and belonged to the family as a whole, and he was little more than a trustee to hold and administer them for the common benefit.

The *patria potestas*, unless the *paterfamilias* voluntarily put an end to it, lasted as long as he lived and retained his status. The marriage of a son, unlike that of a daughter passing into the hand of a husband, did not release him from it, nor did his children become subject to him so long as he himself was in *potestate*. On the contrary, his wife passed on marriage into the power of her father-in-law, and their children as they were born fell under that of their paternal grandfather; and the latter was entitled to exercise over his daughters-in-law and grandchildren the same rights that he had over his sons and unmarried daughters. But there was this difference, that, when the *paterfamilias* died, his sons and daughters who had remained in *potestate* and his grandchildren by a predeceased son instantly became their own masters (*sui juris*), whereas grandchildren by a surviving son simply passed from the *potestas* of their grandfather into that of their father.

The acquisition of domestic independence by the death of the family head frequently involved the substitution of the guardianship of tutors (*tutela*) for the *potestas* that had come to an end. This was so invariably in the case of females *sui juris*, no matter what their age: they remained under guardianship until they had passed by marriage in *manum mariti*. It was only during pupillarity, however, that males required tutors, and their office came to an end when puberty was attained. It is improbable that during the regal period a testamentary appointment of tutors by a husband or parent to wife or children was known in practice. In the absence of it the office devolved upon the *gens* to which the deceased *paterfamilias* belonged.

Family Organization among the Plebeians.—If perfect identity of customs cannot be assumed to have existed amongst the patrician *gentes* in the regal period of Rome, far less can it be supposed to have existed amongst the heterogeneous population (Latins, Etruscans, Greeks, &c.) of which the *plebs* was constituted. Nevertheless, contiguity of residence and community of interests tend inevitably to unify customs and cause dissimilarities to disappear, and the plebeians must have not only gradually brought their own customs into unison *inter se*, but adapted them at the same time in many respects to those of the patricians. Even to those of non-Latin race *manus* over their wives and *potestas* over their children would become a desideratum. Though the plebeians seem to have been always excluded from confederation, and their matrimonial unions must have been at first informal and irregular from the point of view of the *Quirites*, two civil modes of acquiring marital *manus* were available to them after they obtained citizenship, viz. *coemptio* and *usus*. Some writers hold that neither of these modes was legally recognized prior to the XII. Tables.¹ This may be so, but it is improbable. As the plebeians obtained by the Servian constitution full capacity for quiritarian ownership, it was at once open to them to adapt the modes sanctioned for acquiring property to the acquisition of marital *manus*. *Coemptio* was just a simple adaptation of mancipation above referred to (see also *infra*, p. 540). It was, as we may infer from what we know of it at a later time, a sale of the woman to the man *per aes et libram* for a nominal price. The price being fictitious, a piece of copper (*raudusculum*) was used to represent it, and this was handed over to the seller, who would ordinarily be the woman's *paterfamilias*, or, if she were *sui juris*, her gentile tutor. The nuptial words used in the ceremony have unfortunately not been preserved; necessarily, of course, they

varied from those of an ordinary mancipation of property.² Though called by the jurists a mode of constituting marriage, *coemptio*, as we know it, was strictly a mode of creating *manus*; for, though usually contemporaneous with, it might, as Gaius informs us, follow the marriage at any distance of time, and was not dissolved by divorce, but required a separate act of remanipation. Students of comparative law have observed that in *coemptio* there are clear traces of earlier bride purchase, so common even nowadays among uncivilized tribes, where a real price in cattle or sheep, and not a mere nominal one, has to be paid for the bride. *Usus*, on the other hand, was a mode of acquiring marital *manus* by possession of the woman as wife for a certain period of time—long cohabitation.³ Whether this was recognized by the law prior to the XII. Tables depends probably upon whether usucaption, as a mode of acquiring property, was settled by custom earlier than the Tables. Some writers, however, think it older than *coemptio*, and as a *de facto* relation prolonged cohabitation as man and wife must have existed from very early times. Comparative historians with good reason trace in *usus* the relics of primitive bride capture. Both *coemptio* and *usus*, from the time they were first recognized by the *jus Quiritium*, undoubtedly created *patria potestas* and agnatic rights.

Law of Property.⁴—The history of the early Roman community, like many other primitive communities, is marked by the disintegration of the *gentes* and the growth of individual property. Yet the distribution of land *in laud.*—amongst the early Romans is one of the puzzling *Patrician* problems of their history. The Servian constitution apparently classified the citizens and determined their privileges, duties and burdens according to the extent of their lands; and yet we know nothing for certain of the way in which these were acquired. All is conjectural. We have indeed a traditional account of a partition by Romulus of the little territory of his original settlement into three parts, one of which was devoted to the maintenance of the state and its institutions, civil and religious, the second (*ager publicus*) to the use of the citizens and profit of the state, and the third (*ager privatus*) subdivided among his followers. Varro and Pliny relate that to each *paterfamilias* among his followers he assigned a homestead (*heredium*) of two jugera, equal to about an acre and a quarter. These *heredia* were to be held by him and his heirs for ever (*quae heredem sequerentur*); Pliny adding that to none did the king give more. This can only be accepted as a partially correct account of what may have taken place at some early period during the kingly régime. There can be little doubt that a portion of the Roman territory, gradually augmented through new conquests, was early reserved by the state as *ager publicus*; that is sufficiently attested by the complaints made for centuries by the plebeians of its monopolization by the patricians. It is also probable that *heredia* (i.e. plots of land within the city) may have been granted to the heads of the gentile families, many of whom would be living in *poggi* on their respective gentile lands outside the city. Such *heredia* became family property, administered as such by the *paterfamilias*, but inalienable by him. In this respect the position would be very similar to what existed among the ancient Germans and exists to-day in India among the Hindus. Even late in the Republic, when the idea of

¹ One or two writers of the later Empire (e.g. Servius, in *Georg.* i. 31) describe *coemptio* as a mutual purchase, the man and woman taking alternately the position of *emptor* and using nuptial words as such; but this seems to be a misapprehension and not consistent with what Gaius says. See the arguments in favour of it in Muirhead, *Historical Introduction*, 2nd ed. pp. 414-415. Girard, *Manuel*, 4th ed. p. 150, gives a probable explanation of the mistake of these late authors.

² It would thus cure defects in a *coemptio* just as usucaption did defects in mancipation.

³ See Girard, *Recherches sur le droit de propriété chez les Romains* (Aix, 1838); Macé, *Histoire de la propriété &c.*, chez les Romains (Paris, 1851); Hillebrand, *De antiquissimae aeri Romani distributionis fide* (Jena, 1862); Cuq, *Inst. jurid.*, 2nd ed., vol. 1. pp. 77 seq.; Beaudouin, *La Limitation des fonds de terre* (1894), pp. 259 seq.

⁴ See as to *coemptio*, Cuq, *Institutions juridiques*, 2nd ed., i. p. 62.

Individual ownership was paramount, it was still considered a disgrace for a man to alienate his *heredium*. But though the existence of monogamous families seems to imply private ownership to some extent, yet, as formerly indicated, a large part of the Roman territory at, and for a good while after, the foundation of the city must have been gentile lands held by the separate clans for the use of their members. The fact that the majority of the rural tribes bore the names of well-known patrician *gentes* favours the conclusion that even in the later regal period a good many of the clans still held lands in their collective capacity. It was at some uncertain time before Servius that there began to be a break-up of these gentile lands and their appropriation by individual members. Under the influence of this movement lands were acquired and held by families and individuals to a large extent. A patrician's holding must have been sometimes pretty large so as to enable him to make grants (so often alluded to by ancient writers) to his clients, but we have no means of estimating the normal size. The *heredia* were small; even during the Republic there is some evidence (e.g. the traditional story about Cincinnatus) that seven jugera were regarded as the normal extent of a patrician's holding for his own and his family's use. On the other hand, twenty jugera are commonly supposed to have been the qualification for enrolment in the first of the Servian classes. Of course it must be kept in view that a patrician did not necessarily hold all his lands by gratuitous assignation or concession either from the state or from his *gens*; purchase from the former was by no means uncommon, and it may have been on his purchased lands that his clients were usually placed. Those dependants were also probably employed in large numbers upon those parts of the *ager publicus* which were occupied by the patricians and were in historic times known as *possessionses*. These, of course, were not the property of their occupants; it was the lands acquired by assignation or purchase that were alone, apart from the *heredia*, regarded as theirs *ex jure Quiritium*.

The traditional accounts of the early distribution of lands among the plebeians are even, if possible, more vague than those regarding the patricians. They had apparently become holders *de facto* of land in large numbers before the Servian reforms. But they can have attained that position only by gradual stages. While their earliest grants of land, probably from the kings, can only have been during pleasure, latterly, as they increased in number and importance, they were allowed to have permanent possession. That those who had means also acquired lands by purchase from the state may be taken for granted. The distinction between *de facto* possession and ownership was at best a very vague one at this period, and, like the holders of provincial lands in later times, the plebeians might have the benefits of ownership without ownership. The result of the Servian constitution was to convert this *de facto* property or permanent possession into *quiritarian* ownership.¹

There are some writers who maintain that in the regal period, prior to the Servian reforms, though after the collective ownership of the *gentes* had begun to disintegrate, there was no private property in movables. This proposition can at most be accepted only in a qualified sense. If it be meant that movables generally were not then recognized as objects of *quiritarian dominium* which could be vindicated by any real action, it may be admitted. But otherwise the distinction between *meum* and *tuum* must have been well recognized, *de facto* at least. Men must have been in the habit of transferring things from one to another by simple delivery in respect of barter, sale or otherwise, and any violent or "theftuous" appropriation of things in a man's occupation would be punished by magisterial authority or by ordinary self-redress by the injured party. A sort of ownership in

possession must at least have been recognized for movables generally.²

But apart from this, we must believe that certain kinds of movables, viz. those which have been described as *appurtenant* to land and necessary for its cultivation—which with land formed the real objects, as distinct from the personal subjects, of the *familia*—were treated from the time of Romulus downwards, as *in manu* of the *paterfamilias*. These were the *res mancipi* already referred to. *Quiritarian* ownership in them, as we have seen, was recognized both for patricians and plebs by the Servian constitution, periodical registration of them in the census and transference by the quasi-public act of mancipation being probably required. Earlier even than with lands, the conception of private ownership, it has been said, connected itself with them.³

A short explanation may now be given of the ceremony of mancipation and the nature of *res mancipi*.

Mancipation is described by Gaius, with particular reference to the conveyance of movable *res mancipi*, as a pretended sale in presence of not less than five citizens as witnesses and *libripens* holding a pair of copper scales. The transferee, with one hand on the thing being transferred, and using certain words of style, declared it his by purchase with a piece of copper (which he held in his other hand) and the scales (*hoc aere aeneae libra*); and simultaneously he struck the scales with the *as*, which he then handed to the transferee as figurative of the price. The principal variation when it was an immovable that was being transferred was that the mancipation did not require to be on the spot: "the land was simply described by its known name in the valuation roll. Although in the time of Gaius only a fictitious sale—in fact the formal conveyance—upon a relative contract—yet it was not always so. Its history is very simple. The use of the scales fixes its introduction at a time when coined money was not yet current, but raw copper nevertheless had become a standard of value and in a manner a medium of exchange. That, however, was not in the first days of Rome. Then, and for a long time, values were estimated in cattle or sheep, fines were imposed in them, and the deposits in the *legis actio sacramento* (*infra*, p. 549) took the same form. The use of copper as a substitute for them in private transactions was probably derived from Etruria. But, being only raw metal or foreign coins, it could be made available for loans or payments only when weighed in the scales—passed by weight, not by tale. There is no reason for supposing that the weighing was a solemnity, that it had any significance beyond its obvious purpose of enabling parties to ascertain that a vendor or borrower was getting the amount of copper for which he had bargained.

It was this practice of everyday life in private transactions that Servius apparently adopted as the basis of his mancipatory conveyance, engrafting on it one or two new features intended to give it publicity and, as it were, state sanction, and thus render it more serviceable in the transfer of considerable property. Instead of the parties themselves using the scales, an impartial balance-holder, probably an official, was required to undertake the duty, and at least five citizens were required to attend as witnesses, who were to be the vouchers to the census officials of the regularity of the procedure. Whether they were intended as representatives of the five classes in which Servius had distributed the population, and thus virtually of the state, is disputed, though the fact that, when the parties appealed to them for their testimony, they were addressed not as *testes* but as *Quirities* lends some colour to this view.⁴ Servius is also credited with the introduction of rectangular pieces of copper of different weight but carefully adjusted weights, stamped by his authority with various devices (*aes signatum*), which are

¹ The position of the plebeians in this respect did not differ from that of the patricians.

² Mancipation seems to have been a very ancient mode of conveyance. The use of the balance in barter or sale was known to the ancient Egyptians at least as early as 2000 B.C., as may be seen on reliefs in the temple of Dehr-el-Bahri in Upper Egypt. The derivation of *mancipium* (*mancipatio*) from *manu capere*, to seize with the hand, is given by Gaius and is confirmed by the fact that at all times in its history the acquirer had to lay his hand on the thing being acquired, during the ceremony, if a movable. So when several things were being mancipiated in a lot, this had to be done to each separately. With lands and other immovables it was different: they might be mancipiated in absence, which goes some way to prove that mancipation must have been extended to them at a later period. The derivation of *mancipatio* given by Muirhead (*Historical Introduction*, 2nd ed., pp. 59 seq.) from *manum capere*, i.e. to acquire power (*manus*), is open to the objection that it places the abstract idea of power before the concrete symbol of it. Cf. Cuij, *Institutiones jurisprudentiae*, 2nd ed., i. p. 80 n.

³ See Gai. ii. § 104.

⁴ On this question of land-holding among the early patricians and plebeians, consult Cuij, *Institutiones jurisprudentiae des Romains*, 2nd ed., vol. i. pp. 73-76; Bourcart (French translation of Muirhead's *Historical Introduction*), p. 580, and authorities there cited.

usually supposed to have been intended to take the place of the raw metal (*aes rude*) formerly in use, and so facilitate the process of weighing; but there is more reason for thinking they were cast and stamped as standards to be put into one scale, while the raw metal whose weight was to be ascertained was put into the other.

Instead, therefore, of being a fictitious sale, as Gaius describes it, and as it became after the introduction of coined money in the 4th century of the city, the mancipation, as regulated by Servius, was an actual completed sale in the strictest sense of the term. What were the precise words of style addressed by the transferee to the transferrer, or what exactly the form of the ceremonial, we know not. But, as attendance during all the time that some thousands of pounds, perhaps of copper, were being weighed would have been an intolerable burden upon the five citizens convoked to discharge a public duty, it may be surmised that it early became a common practice to have the price weighed beforehand, and then to reweigh, or pretend to reweigh, before the witnesses only a single little bit of metal (*raudusculum*), which the transferee then handed to the transferrer as "the first pound and the last," and thus representative of the whole.¹ And where no real price was intended, as in constituting a *dos* or in coemption, a *raudusculum* would also be employed. Whatever may have been its form, however, its effect was instant exchange of property against a price weighed in the scales. The resulting obligation on the vendor to maintain the title of the vendee, and the qualifications that might be superinduced on the conveyance by agreement of parties

—the so-called *leges mancipii*—will be considered below in connexion with the provisions of the XII. Tables on the subject (*infra*, p. 542). The things included in the class of *res mancipii* were lands and houses held on Quiritarian title, together with rights of way and aqueduct, slaves, and the following domestic beasts of draught or burden, viz. oxen, horses, mules and donkeys; all others were

res nec mancipii. Many theories have been propounded to account for the distinction between these two classes of things, and to explain the principle of selection that admitted oxen and horses into the one, but relegated such animals as sheep and swine to the other. But there is really little difficulty. Under the arrangement of Servius, what was to determine the nature and extent of a citizen's legal qualifications, military duties and financial burdens, was apparently the value of his *hereditas* and other lands, if he had any, and what may be called its appurtenances—the slaves that worked for the household, the slaves and beasts of draught and burden that worked the farm, all of which lived and worked in common with the free members of the *familia*. But the cattle a man depastured on the public meadows were no more *res mancipii* than his sheep, a fact which, though ultimately in the later Empire lost sight of, was still understood in the time of Gaius.² To say that the things classed as *res mancipii* were selected for that distinction by Servius because they were what were essential to the family engaged in agriculture is a *post hoc ergo propter hoc* of the truth. They constituted the *familia* in the sense of the family estate proper; whereas the herds and flocks, and everything else belonging to the *paterfamilias*, fell under the denomination of *pecunia*. So the words are to be understood perhaps in the well-known phraseology of the mancipationary testament, *familia pecuniaque mea*.³

The public solemnity of *mancipatio* thus sanctioned as a mode of transferring a Quiritarian right of property, for which *manus* was probably as yet the only descriptive word in use, was not long in being adapted to and utilized for other transactions in which other kinds of things were to be acquired. During the *res mancipii* adaptations, if confined at first for the most part to plebeians, were also soon made use of by the patricians, perhaps before as well as after the XII. Tables, and became by custom part of the common law. Such were, for example, coemption (as explained above), emancipation and adoption of *filiifamilias*, and *mortis causa alienatio* of a *familia* and *nexum*.

Law of Succession.—The legal order of succession during the regal period was extremely simple. It was this, upon the death of a *paterfamilias* his patrimony devolved upon those of his descendants in *potestate* who by that event became *sui juris*, his widow (being *loca filiae*) taking an equal share with him, and no distinction being made between movables and immovables. Such persons were styled self-heirs (*sui heredes*). Failing widow and children,

¹ The conjecture is suggested by the words of style in the *solutio per aes et libram*, Gai. ii. §§ 173, 174. There were some debts from which a man could be effectually discharged only by payment (latterly fictitious) by copper and scales in the presence of a *libripens* and the usual five witnesses. In the words addressed to the creditor by the debtor making payment these occurred—*hanc tibi libram primam postremamque expendo* ("I weigh out to you this the first and the last pound"). The idea is manifestly archaic, and in the words, taken strictly, are quite inappropriate to the transaction in which it had assumed long before the time of Gaius.

² Ulpian, *frat. xix.*
³ Gai. ii. 154. By the time of the XII. Tables the sharp distinction between these two terms is tending to disappear.

his patrimony went to his *gens*. The notion that between the descendants and the *gens* came an intermediate class under the name of agnates does not seem well founded as regards the regal period; the succession of agnates as such seems to have been first legally recognized by the XII. Tables, probably to meet the case of the plebeians, who, having no *gentes*, were without legal heirs in default of children.⁴

The later jurists more than once refer to the perfect equality of the sexes in the matter of succession in the ancient law.⁵ But it was rather nominal than real. A daughter who had passed into the hands of a husband during her father's lifetime of course could have no share in the latter's inheritance, for she had ceased to be a member of his family. One who was in *potestate* at his death, and thereby became *sui juris*, did become his heir, unless he had prevented such a result by testamentary arrangements; but even then it was in the hands of the *gens* to prevent risk of prejudice to themselves. For she could not marry, and so carry her fortune into another family, without their consent as her guardians; neither could she without their consent alienate any of the more valuable items of it; nor, even with their consent, could she make a testament disposing of it in prospect of death. Her inheritance, therefore, was hers in name only; in reality it was in the hands of her guardians.

Of primogeniture or legal preference of one member of the family over the others there is not the faintest trace. And yet we are told of *hereditas* remaining in a family for many generations—a state of matters that there was impossible had every death of a *paterfamilias* necessarily involved a splitting up of the family estate. It is conceivable that this was sometimes prevented by arrangement amongst the heirs themselves; and the practice of every now and then drafting the younger members of families to colonies, diminished the number of those who had a claim to participate. But the simplest plan of avoiding the difficulty was for the *paterfamilias* to regulate his succession by testament, and this was probably had recourse to, not so much for instituting a stranger heir when a man had no issue—according to patrician notions his duty then was to perpetuate his family by adopting a son—as for partitioning the succession when he had more children than one.

There were two sorts of testaments made use of by the patricians of the regal period—that made in the *comitia* of the curies (*test. calatis comitiis*) and that made in the presence of the army (probably represented for this purpose by a few comrades) on the eve of battle (*test. in procinctu factum*). The first at least—and the second was just a substitute for it on an emergency—was far from being an independent exercise of the testator's *voluntas*. For, though in course of time, and under the sanction of the *uti legassit ita jus esto* of the XII. Tables, the curies may have become merely the recipients of the oral declaration by the testator of his last will, in order that they might testify to it after his death, it is impossible not to see in the comitial testament what must originally have been a legislative act, whereby the testator's peers, for reasons which they and the presiding pontiffs thought sufficient, sanctioned in the particular case a departure from the ordinary rules of succession. The pontiffs were there to protect the interests of religion, and the curies to protect those of the testator's *gens*; and it is hardly conceivable that a testament could have been sanctioned by them which so far set at naught old traditions as to deprive a *filiusfamilias* of his birthright, at least in favour of a stranger.

⁴ It is quite true, however, that from the first the order of succession was agnatic; for it was those only of a man's children who were agnate that had any claim to his inheritance; and the *gens* was, theoretically at least, just a body of agnates. The supposed mention of agnates in a law attributed to Numa is a conjecture of P. E. Huscik's (in *Analecta litteraria*, Leipzig, 1826, p. 375). The law is preserved in narrative by Servius, *In Virg. Eclog.* iv. 43, which runs thus: "In Numae legibus cautum est, ut si quis imprudens occidisset hominem, pro capite occisi et natis ejus in cautione (Scalig. concione) offerret universum." Huscik's substitution of *agnatis* for *et natis* is all but arbitrarily adopted; but, even were it necessary, it need mean nothing more than his children in *potestate* or his *gens*.

⁵ The Voconian law of 169 B.C. avowedly introduced something new in prohibiting a man of fortune from instituting a woman, even his only daughter, as his testamentary heir; but even then it did not touch the law of intestacy. See Girard, *Manuel*, 4th ed. p. 816.

It may safely be assumed that by custom at all events the children of a plebeian usually took his estate on his death intestate. But, as he was not a member of a *gens*, there was no provision for the devolution of his succession on failure of children. The want of them he could not supply by adoption, as he had for long, it is thought, no access to the assembly of the curies; and it is doubtful if adoption of a *filiiusfamilias* was known before the XII. Tables. If therefore, as seems probable, the XII. Tables first introduced the succession of agnates, a plebeian unsurvived by children was necessarily heirless, that is to say, heirless in law. But custom seems to have looked without disfavour on the appropriation of his *heredium* by an outsider: a brother or other near kinsman would naturally have the earliest opportunity, and, if he maintained his possession of it in the character of heir for a reasonable period, fixed by the XII. Tables at a year, the law dealt with him as heir, and in course of time the pontiffs imposed upon him the duty of maintaining the family *sacra*. This was probably the origin, and a very innocent and laudable one, of the *usuapico pro herede*, which Gaius condemns as an infamous institution, and which undoubtedly lost some of its *raison d'être* once the right of succession of agnates had been introduced.

There is no trace of testamentary succession among the *plebs* prior to the Servian constitution, nor is it in the least degree likely that there was any such. Primitive communities are slow to realize the conception of private testaments, and the plebeians could not at this period make a public one either *calatis comitiis* or in *procinctu*. But not long after their admission to citizenship there is reason to conjecture that mancipation was employed by them, not indeed to make a testament instituting an heir and taking effect only on the testator's death, but to make a conveyance of a whole patrimony *mortis causa*. The transaction took the form of an absolute acquisition, in exchange for a price (usually nominal), of the transferrer's *familia*,¹ by a friend, technically called *familiae emptor*, on trust to distribute, on the transferrer's death and according to his instructions, whatever the transferee was not authorized to retain for himself. The transferrer may also have had power to reserve in the mancipation a usufruct of the estate while he lived.² Like so many other of the transactions of the early law, it was legally unprotected so far as the third parties were concerned whom the transferrer meant to benefit; they could only trust to the *fides* of the transferee. This *mortis causa* alienation, whatever the date of its introduction, was the forerunner of the so-called testament *per aes et libram*, to be afterwards described (*infra*, p. 543).

Contract and its Breach.—To speak of a law of obligations in connexion with the regal period, in the sense in which the words were understood in the later jurisprudence, would be a misapplication of language. It would be going too far to say, however, as is sometimes done, that before the time of Servius Rome had no conception of contract; for men must have bought and sold, or at least bartered, from earliest times—must have rented houses, hired labour, made loans, carried goods and been parties to a variety of other transactions inevitable amongst a people engaged to any extent in pastoral, agricultural or trading pursuits. It is true that a patrician family with a good establishment of clients and slaves had within itself ample machinery for supplying its ordinary wants, and was thus to a great extent independent of outside aid. But there were not many such families. There must therefore have been contracts and some customary rules to regulate them, though these were presumably very imperfect. In many cases, such as those alluded to, one of the parties at least must have trusted to the

¹ The *familia*, as the collective name for a man's lands and mancipable appurtenances, became itself capable of mancipation. The conveyance was universal. There would be, it is thought, nothing discreditable in a man's conveying his *heredium* in this form.

² For a different view of cf. Maine, *Ancient Law*, ed. Pollock, pp. 214 seq.

good faith of the other. What was his guarantee, and what remedy had he for breach of engagement?

His reliance in the first place was on the probity of the party with whom he was dealing—on the latter's reverence for Fides, and the dread he had of the disapprobation of his fellows should he prove false, and of the penalties, social, religious or pecuniary, that might consequently be imposed on him by his *gens* in the case of a patrician, by his *gild* in the case of a craftsman, or by the king in the case of any other plebeian.³ If the party who had to rely on the other's good faith was not satisfied with his promise and the grasp of the right hand that was its seal,⁴ he might require his solemn oath (*jusjurandum*); and it can hardly be doubted that, whatever may have been the case at a later period, in the time of the earlier kings he who forswore himself was amenable to pontifical discipline. If he preferred a more substantial guarantee, he took something in pledge or pawn from the other contractor; and, though he had no legal title to it, and so could not recover it by judicial process if he lost possession, yet so long as he retained it he had in his own hand a *de facto* means of enforcing performance. Upon performance he could be forced to return it or suffer a penalty—not by reason of obligation resulting from a contract of pledge, for the law as yet recognized none, but because, in retaining it after the purpose was served for which he had received it, he was committing theft and liable to its punishment. At this stage breach of contract, as such, does not seem to have founded any action for damages or reparation before the tribunals; but it is not improbable that, where actual loss had been sustained, the injured party was permitted to resort immediately to self-redress by seizure of the wrong-doer or his goods. Self-help was according to the spirit of the time—not self-defence merely in presence of imminent danger, but active measures for redress of wrongs already completed.

There was one contract, however, notorious in after years under the name of *nexum*, that must have received legal sanction soon after the Servian reforms, though probably, like mancipation of property itself, known in practice earlier. In the XII. Tables it is apparently referred to as an existing institution. In its normal character it was a loan of money, or rather of the raw copper that as yet was all that stood for money. How far in its original use it was accompanied by any formalities beyond the weighing of it in a pair of scales (which was rather substance than form) we know not; and what right it conferred on the creditor over his debtor who failed to repay can be only matter of speculation. Apparently the result of the Servian reforms was the regulating and ensuring the publicity of the contract and making the creditor's right of self-redress by apprehension (*manus injectio*) and imprisonment, &c., of his debtor conditional on the observance of the prescribed formalities of the *nexum*. In its character and effects, however, of this the earliest independent contract of the *jus civile*, are much disputed and will be explained below on p. 545 seq.

Public and Private Offences and their Punishment.—For anything like a clear line of demarcation between crimes and civil injuries we look in vain in regal Rome. Offences against the state itself, such as trafficking with an enemy for its overthrow (*proditio*) or treasonable practices at home (*perduellio*) were matter of state prosecution and punishment from the first. But in the case of those that primarily affected an individual or his estate there was a halting between, and to some extent a confusion of, the three systems of private vengeance, sacral

³ Such as debarment from gentile or gild privileges, exclusion from right of burial in the gentile or gild sepulchre, fines in the form of cattle and sheep, &c.

⁴ Some of the old writers (e.g. Liv. i. 21, § 4, xxiii. 9, § 3; Plin. H.N. xi. 45; Serv. in *Aen.* iii. 687) say that the seal of Fides was in the right hand, and that to give it (*promittere dextram*)—is this the origin of the word "promise" (?) in making an engagement was emphatically a pledge of faith. See a variety of texts illustrating the significance of the practice, and testifying to the regard paid to Fides before foreign influences and example had begun to corrupt men's probity and trustworthiness, in Lasaulx, *Ueber d. Ewig. bei Römern* (Würzburg, 1844), p. 5 seq.; Dinzl, *Der sacrale Schutz im röm. Rechtsverkehr* (Jena, 1857), pp. 139, 140. Cf. Pernice, *Latæo*, vol. ii. (2nd ed., Halle), p. 459 seq.

Contract
"per
aes et
libram."

Offences
and their
punishment.

atonement and public or private penalty.¹ These may be said to have followed in sequence but overlapped each other. The same sequence is observable in the history of the laws of other nations, the later system gradually gaining ground upon the earlier and eventually superseding it.² The remarkable thing in Rome is that private vengeance should so long not only have left its traces but continued to be an active power. According to tradition it was an admitted right of the *gens* or kinsmen of a murdered man in the days of Numa; a law of his is said to have provided that, where a homicide was due to misadventure, the offering to them of a ram should stay their hands (*supra*, p. 533). And this seems to have been also prescribed in the XII. Tables (VIII., 24). To avenge the death of a kinsman was more than a right; it was a religious duty, for his *manes* had to be appeased; and so strongly was this idea entertained that, even long after the state had interfered and made murder a matter of public prosecution, a kinsman was so imperatively bound to set it in motion that if he failed he was not permitted to take anything of the inheritance of the deceased. The talion we read of in the XII. Tables is also redolent of the *vindicta privata*, although practically it had become no more than a means of enforcing reparation. And even the nexal creditor's imprisonment of his defaulting debtor (*infra*, p. 551), which was not abolished until the 5th century of the city, may not unfittingly, in view of the cruelties that too often attended it, be said to have savoured more of private vengeance than either punishment or procedure in reparation.

Expitio, supplicium, sacerdotio capitis, all suggest offences against the gods rather than against either an individual or the state. But it is difficult to draw the line between different classes of offences, and predicate of one that it was a sin, of another that it was a crime and of a third that it was but civil injury. They ran into each other in a way that is somewhat perplexing. Apparently the majority of those specially mentioned in the so-called *leges regiae* and other records of the regal period were regarded as violations of divine law, and the punishments appropriate to them determined upon that footing. Yet in many of them the prosecution was left to the state or to private individuals. It is not clear, indeed, that there was any machinery for public prosecution except in treason and murder—the former because it was essentially a state offence, the latter because it was comparatively early deemed expedient to repress the blood-feud, which was apt to lead to deplorable results when clansmen and neighbours appeared to defend the alleged assassin.

Take some of those offences of which no sanction was *sacroto capitis*. Breach of duty resulting from the fiduciary relation between patron and client, maltreatment of a parent by his child, exposure or killing of a child by its father contrary to the Romulan rules, the ploughing up or removal of a boundary stone, the slaughter of a plough-ox—all these were capital offences; the offender, by the formula *sacer esto*, was devoted to the infernal gods. Festus says that, although the rules of divine law did not allow that he should be offered as a sacrifice to the deity he had especially offended (*neq. fas est eum immolari*), yet he was so utterly beyond the pale of the law and its protection, that any one might kill him with impunity. But, as the *sacer esto* was usually coupled with forfeiture of the offender's estate or part of it to religious uses, it is probable that steps were taken to have the outlawry or excommunication judicially declared, though whether by the pontiffs, the king or the curies does not appear; such a declaration would, besides, relieve the private avenger of the incensed god of the chance of future question as to whether or not the citizen he had slain was *sacer* in the eye of the law.

That there must have been other wrongful acts that were regarded in early Rome as deserving of punishment or penalty of some sort, besides those visited with death, sacration or forfeiture of estate, total or partial, cannot be doubted; no community has ever been so happy as to know nothing of thefts, robberies and assaults. The XII. Tables contained numerous provisions in reference to them; but it is extremely probable that, down at least to the time of Servius Tullius, the manner of dealing with them rested on custom, and was in the main self-redress, restrained by the intervention of the king when it appeared to him that the injured party was going beyond the bounds of fair reprisal, and frequently bought

off with a composition. When the offence was strictly within the family or the *gens*, it was for those who exercised jurisdiction over those bodies to judge of the wrong and prescribe and enforce the penalty.

Jurisdiction and Procedure.—Of the course of justice, whether in criminal or civil matters, during the regal period we know little that can be relied on. Ancient writers speak of the king as having been generally supreme in his jurisdiction. But this can be accepted only with considerable reservation. The king was the *paterfamilias*, aided by a council in cases of importance, was judge within the family—his jurisdiction sometimes excluding that of the state, at other times concurring with it, and not to be stayed even by an acquittal pronounced by it. He alone was competent in any charge against a member of the family for a crime or offence against the domestic order—adultery or unchastity of wife or daughter, undutiful behaviour of children or clients, or the like. Death, slavery, banishment, expulsion from the family, imprisonment, chains, stripes, withdrawal of *peculium*, were all at his command; and it may readily be assumed that in imposing them he was freer to take account of moral guilt than an outside tribunal. The indications of criminal jurisdiction on the part of the *gens* are slight; but its organization was such that it is difficult not to believe that it must occasionally have been called on to exercise such functions. And it must not be lost sight of that, as murder seems to have been the only crime in regard to which private revenge was absolutely excluded, the judicial office of the kings must have been considerably lightened, public opinion approving and not condemning self-redress so long as it was kept within the limits set by usage and custom.

The boundary between civil and criminal jurisdiction, if it existed at all, was extremely shadowy. Theft and robbery, for example, if one may conclude from the position they held in the later jurisprudence, were regarded not as public but as private wrongs; and yet when a thief was caught in the act of theft by night he might be slain, and when by day might be scourged and thereafter sold as a slave. But in both cases it may also be assumed that a practice, afterwards formally sanctioned by the XII. Tables—that of the thief compounding for his life or freedom—was early admitted, and the right of self-redress thus made much beneficial to the party wronged than when nothing was attained but vengeance on the wrongdoer. In assaults, non-mortal thefts, and other minor wrongs, self-interest would in like manner soon lead to the general adoption of the practice of compounding; what was originally a matter of option in time came to be regarded as a right; and with it there would be occasional difficulty in settling the amount of the composition, and consequent necessity of an appeal to a third party. Here seems to be the origin of the king's jurisdiction in matters of this sort. He was the natural person to whom to refer such a dispute; for he alone, as supreme magistrate, had the power to use coercion to prevent the party wronged insisting on his right of self-redress, in face of a tender by the wrongdoer, of what had been declared to be sufficient reparation. But that self-redress was not stayed if the reparation found due was withheld; as the party wronged was still entitled at a much later period to wreak his vengeance upon the wrongdoer by apprehending and imprisoning him, it cannot reasonably be doubted that such also was the practice of the regal period.

How far the kings exercised jurisdiction in questions of quiritarian right, such as disputes about property or inheritance, is by no means obvious. Within the family, of course, such questions were impossible, though between clansmen they may have been settled by the *gens* or its chief. The words of style used in the sacramental action (*infra*, p. 548) suggest that there must have been a time when the spear was the arbiter, and when the contending parties, backed possibly by their clansmen or friends, were actual combatants, and victory decided the right. Such a procedure could not long survive the institution of a state. In Rome there seems to have been very early substituted for it what from its general complexion one would infer was a submission of the question of right to the pontiffs as the repositories of legal lore. Their proper functions, however, being sacred, they had to bring what was a question of purely civil right within their jurisdiction, by engraving on it a sacral element, viz. by requiring each of the parties to make oath to the verity of his contention, and the point that in form they decided was which of the two oaths was false and therefore to be made atonement for. In substance, however, it was a finding on the real question at issue; and the party in whose favour it was pronounced was free to make it effectual if necessary by self-redress in the ordinary way.

Of Servius, Dionysius says—using, as he often does, language more appropriate to the republican than to the regal period—that he drew a line of separation between public and private judicial processes, and that, while he retained the former in his own name, he referred the latter to private judges, and regulated the procedure to be followed in causes brought before them.³ Something of the sort was absolutely necessary. He was enormously increasing the number of the citizens,—that is to say, of

¹ See Rein, *Das Criminalrecht der Römer* (Leipzig, 1844), pp. 24 seq.; Clark, *Early Roman Law: Regal Period* (London, 1872), pp. 34 seq.; Mommsen, *Strafrecht*, pp. 6, 36, 900.

² Probably every offence at first was an act attributable to the whole family, and it was upon them or by them and not upon the individual wrong-doer or by the injured party that vengeance was taken.

³ Dion. Hal. iv. 25.

those who were to enjoy in future the privileges of *quiritarian right*,—and multiplying the sources of future disputes that would have to be determined by the tribunals. The nature of the jurisdiction created by him, if any, to meet the new aspect of things is much controverted. He has been credited with the institution of the collegiate courts of the *Centumviri* and the *Decemviri (stiltibus judicandis)* as well as the private judge (*unus iudex*), but the arguments in support of this view are not strong, and are, of course, based wholly on presumptions. However, it will be convenient to say a few words about each of these courts here.

The centumviral court¹ is often referred to by Cicero, and the range of its jurisdiction in his time seems to have included every possible question of *manus* in the old sense of the word—status of individuals, property and its easements, and instances of interference whether testamentary or intestate. By the time of Gaius the only matters apparently that were in practice brought before it were questions of inheritance by the *jus civile*, though theoretically it was still competent in all real actions, and the lance, the emblem of *quiritarian right* generally, was still its ensign. During the later Republic the *Centumviri* formed a quasi-corporate body of private judges selected originally from the tribes (afterwards from the ordinary list of *centuriones*) annually by the urban praetors.² Scarcely a century later the *Centumviri* consisted of the Romanian senate of 100; others attribute its institution to Servius Tullius and hold that it was a plebeian court at first; others make it contemporaneous with the XII. Tables; others bring it down to the 6th century of the city; while the weight of recent authority is in favour of the view that it is not earlier than the beginning of the 7th century. The arguments in support of these several views cannot be gone into here. It is enough to say that we have no positive proof of its existence earlier than the 7th century, though presumptions are in favour of its having been somewhat earlier. In the exercise of their office the *Centumviri* acted more independently than private judges ventured to do, and even introduced some considerable reforms into the law.

There was a court at Rome during the Republic called the *Decemviri stiltibus judicandis*.³ These decemvirs in historic times constituted a quasi-corporate body of judicial magistrates, whose duty it was to try certain kinds of actions, especially those relating to personal liberty. During the Principate, while ceasing to act as a separate court, they presided over the divisions into which the centumviral court had been under Augustus divided. Their origin is quite unknown. Pomponius indeed says that they were originally created soon after the institution of the peregrin praetorship in 242 B.C. for this very purpose of presiding over centumviral cases,⁴ but this statement is generally discredited and, if true, their practice of so presiding must quickly have gone into disuse. Those writers who attempt to trace back the *Centumviri* to the regal period give, as a rule, a like antiquity to the *Decemviri stiltibus judicandis*. On the other hand, some authorities identify them with the *decemviri iudices* mentioned by Livy⁵ as having been declared by the *lex Valeria Horatia* to be as sacrosanct as the tribunes of the *plebs*. But these latter judges seem to have been a purely plebeian court which early went into desuetude, and there is really no evidence of identity.

So far back as historic evidence goes we find that actions were tried and judgments pronounced by *iudices* and *arbitri*. There never was more than a single judge (*unus or unicuique iudex*) appointed to try a case, but there might be more than one *arbitrator*, and frequently there were three. All kinds of actions, even a sacramental action *in rem*, could be brought before the *unus iudex*, but especially appropriate to him were all personal claims of alleged indebtedness, whether arising out of a loan or illegal detention, either in toto or only as to the amount. Matters of that sort involved as a rule no general principle of law but rather mere disputes as to facts, which could well be decided by a single individual. There is much more reason for crediting Servius with the institution of the single judge (the arbiters may have been a creation of the XII. Tables) than with either of the collegiate courts. If we believe that in the early regal period the king acting with the pontiffs kept all jurisdiction in his own hands, it is plain that this must have become a practical impossibility after the admission of the plebeians to citizenship. For the trial of disputed facts it would be necessary to delegate jurisdiction, and

the earliest *iudices* may have been the king's commissioners for such cases. If this be right, it was the beginning of a system that bore wondrous fruit in after years, and that, as will be shown in the sequel, helped the praetors to build up, through the *formulae*, the whole body of equity.

Under the kings it is not improbable that several of the *legis actiones*, more or less undeveloped, were already in use, *Civile pro- cedure* the nature of these actions will be more conveniently considered later on (*infra*, p. 566).

II. THE IUS CIVILE

(From the establishment of the Republic until the subjugation of central and southern Italy.)

i. Constitutional Events affecting the Law.

Jus Civile contrasted with *Jus Quiritium*.—The term *jus civile*, as used to designate this chapter, though almost synonymous with, may be taken as somewhat more comprehensive than, *jus Quiritium*. It is a term of *"Jus Civile,"* later origin than the latter. *Jus Quiritium* was based entirely on old custom and legislation, finding, one might say, its culmination in the XII. Tables; whereas in the *jus civile*, as here understood, there appears the element of doctrinal interpretation of both statute and custom—the magistrates and jurists (particularly the pontiffs) adding much to the earlier law by introducing into it this element. We can say that the *jus civile* in this sense is *jus Quiritium* as developed by interpretation. It is as yet, however, little influenced, as was the more comprehensive *jus civile* of later periods, by the elements of *jus gentium* and equity. Still nowhere, we must note, are the terms *jus Quiritium* and *jus civile* placed in contrast by the jurists; they were each *jus proprium civium Romanorum*. In the classical law the term *jus Quiritium* seems to be used principally in formulae framed in accordance with old custom.

Though our information regarding the present period is less legendary than that of the kings, it is still far from being completely authentic, as no original documents belonging to it are extant. There is little dispute among critics that Rome was sacked and burned by the Gauls about 387 B.C. or a few years later, and it is probable that the original pontifical annals (*Annales Maximi*) upon which Livy and other Roman historians have presumably based their narratives of early history were destroyed at that time along with all other written records. What credence, then, we may give to the ancient historical narratives, for the period of the Republic antecedent to this event, depends largely upon how far the pontiffs managed to have their lost records restored. In any case, however, there is sufficient presumptive evidence to warrant belief in such prominent events of the early Republic as the creation of two annually elected patrician consuls, with *potestas* similar to that of the kings, the creation of tribunes of the *plebs*, the enactment of the decemviral code, and periodic struggles between patricians and *plebs*, the one to keep and the other to gain political power. To know the exact dates of these events is relatively of little importance.

Legislation in Favour of the Plebs.—In their uphill battle for social and political equality the plebeians conquered stage by stage. The more important of their successes may here just be mentioned, with all reserve as to credibility, in the order of their traditional dates. By the *lex Valeria (de provocazione)* of 509 B.C. it was provided that no Roman citizen should be deprived of life, liberty or citizenship (*i.e.* suffer *poena capitis*), or be scourged, by any magistrate within the city, without an appeal (*provocatio*) to the *comitia centuriata*. This statute was often referred to by later Romans as a sort of Magna Carta; Livy calls it *unicum praesidium libertatis*. In 494 or 471 B.C. the tribunes of the *plebs* were created with right of intercession, and about the same time plebeian *aediles* and *iudices decemviri* (the latter to act as judges or arbiters in litigations); the persons of all these officials being declared inviolable during their tenure of office. About 471 B.C. the *concilium plebis* became legislatively recognized, the tribunes

¹ Literature: Huschke, *Servius Tullius*, pp. 585 seq.; Keller-Wach, *Röm. Civil Process* (1883), § 6; Bethmann-Hollweg, *Geschichte d. C. P.* i. § 23; Wlassak, *Process-Gesetze*, i. 125 seq. and ii. 201 seq.; Girard, *Organisation judiciaire des Romains*, i. 23 n.; Martin, *Le tribunal des centumviri* (Paris, 1904). In this last-named work a succinct account of the court and the various theories about it is given.

² On the question of their election, see Greenidge, *Legal Procedure in Rome*, pp. 41 and 264.

³ Girard, *Organisation judiciaire*, i. 159; Pauly-Wissowa, *Encyclopädie*, s.v. "Decemviri."

⁴ *Dig.* i. 2, § 29.

⁵ Livy, ix. 46, 5; Karlowa, *Röm. R.G.* i. 176.

Historic evidence.

were elected in it, and its resolutions (*plebiscita*) became directly binding on plebeians. The XII. Tables, twenty years later, were the fruit of the agitation of the plebeians for a revision and written embodiment of the law. In 449 plebiscita were—subject presumably to *auroritas patrum*—declared by the *lex Valeria-Horatia* binding on the whole *populus*, while about the same time, or perhaps a little earlier, the patrician-plebeian *comitia* of the tribes was instituted.¹ By the *lex Canuleia* of 445 B.C. intermarriage between patricians and plebeians was sanctioned. Repeated protests by the plebeians against the monopolization of the public domain land by members of the higher order resulted in the definite admission of their right to participate in its occupation by one of the Licinian laws of 367 B.C. The long course of cruel oppression of insolvents (mainly plebeians) by their patrician creditors was put an end to by the Poetilian law about 326 B.C., depriving nexal contract of its privileges and generally prohibiting the use of chains and fetters on persons incarcerated for purely civil debt. By the Hortensian law of about 287 B.C. plebiscita were declared binding (presumably without *auroritas patrum*) on the whole body of citizens. And from 421 B.C., when one of their number first reached the regular state magistracy as quaestor, down to 252 B.C., when one was elected *pontifex maximus*, the plebeians gradually vindicated their right as citizens to share in all the honours of the state. There is also evidence that plebeians were early in the Republic admitted to the senate and also to the *comitia curiata*.

The legislative bodies during the present period were thus three in number: the *comitia* of the centuries, the *concilium plebis* and the *comitia tributa*. As to the *comitia* of the curies, it seems to have hardly concerned itself with general legislation, but met merely to confer *imperium* on the higher magistrates and to sanction testaments and adrogations of the gentiles. The legislation of the centuries dealt for the most part (though the XII. Tables were enacted by it) with questions affecting public and constitutional rather than private interests. It could be convened only by a magistrate having military *imperium*, i.e. at first only the consuls, for the reason that it was theoretically a military assembly met for civil purposes (*exercitus civilis*). It is called in the XII. Tables *comitiales maximus*. Its procedure was cumbersome and ill-adapted for legislation. As to the relation of the *concilium plebis* to the *comitia tributa* there is much controversy. The old opinion which identified them is now generally abandoned. According to Mommsen² they differed in the following points: (1) the *comitia* was an assembly of the whole people voting in tribes instead of centuries, while the *concilium* was an assembly of the *plebs* alone; (2) the *comitia* was always convoked and presided over by a patrician magistrate (often the praetor), while the *concilium* had to be convoked and presided over by a plebeian official (usually a tribune); (3) in the *comitia* auspices had to be taken beforehand, but not in the *concilium*; (4) an enactment of the *comitia* was a *lex* binding on all the *populus*, while an enactment of the *concilium* was a plebiscitum binding only on the *plebs*. It is, however, not possible to take Mommsen's view that plebiscita were not binding on the whole *populus* prior to the *lex Hortensia*, without disregarding distinct statements of Livy as to the *lex Valeria-Horatia* and the *lex Publilia*.³ But whatever the relation of these two legislative assemblies to each other may have been originally, it is certain that the Hortensian law equalized them so far as their effects were concerned, and, looking to the small number of patricians compared with the *plebs*, it would probably be a matter of indifference in which assembly the vote was taken. The greater part of the legislation dealing with the private law in the later Republic consisted of plebiscita.

¹ There is diversity of opinion about this. Mommsen thinks the *comitia tributa* was earlier than the XII. Tables, and that the *lex Valeria-Horatia* applied to it. See next note.

² Mommsen, *Röm. Forschungen*, i. 177 seq.; *Röm. Staatsrecht*, iii. 322 seq.

³ Livy, iii. 55. 3; viii. 12, 14.

ii. The XII. Tables.

Causes of their Enactment.—The change from monarchy to republic brought of itself no benefit to the *plebs*, but rather the reverse. One of their chief complaints was against the administration of justice. They complained that they were kept in ignorance of the laws, and that in particular the consuls used their magisterial punitive powers (*coercitio*) unfairly and with undue severity when a plebeian was the object of them. The state of matters gradually became so intolerable that in the year 462 B.C., according to the ancient tradition, a proposal for a statute was made by C. Terentilius Arsa, one of the tribunes, by which a commission should be appointed to draw up a code of laws in writing. He carried a rogation in the *concilium plebis* to this effect. The senate at first strenuously resisted, but after a few years was induced to give way, and its assent to the proposal was obtained.

Tradition records that the first practical step towards its realization was the despatch of a mission to Athens, to study the laws of Solon and collect any materials that might be of service in preparing the projected code. On the return of the commissioners in 452 B.C. all the magistracies were suspended, and a body of ten patricians, called *decemviri legibus scribendis*, was appointed with consular powers, under the presidency of Appius Claudius, for the express purpose of putting the laws into shape. Before the end of the ensuing year (451) the bulk of the code was ready and was at once passed into law by the *comitia* of the centuries and published on ten tables (whether of brass or wood is doubtful), which were set up in the Forum. Next year, owing to additions being found necessary, the decemvirate was renewed, with, however, a change of membership (some plebeians being chosen), and in the course of a few months it had completed the supplemental matter. On the downfall of the decemvirate, these new laws, after being duly accepted by the *comitia*, were published on two other tables, thus bringing the number up to twelve. The code then received the official name of *Lex XII. Tabularum*.

The foregoing account of the enactment of the Tables is an attempt to summarize what is stated by Livy and other Roman writers on the subject. Though inconsistent and sometimes even contradictory about details, these writers are on the main facts in concordance. Until a few years ago, the fact of the publication of such a code about the date above given had been accepted by modern historians, even the most iconoclastic, without question; unlike the *leges regiae*, the XII. Tables had always been regarded as authentic. But in his *History of Rome*, published in 1898, Professor Pais of Turin⁴ emitted the view that the decemviral code was really a private compilation made about the year 304 B.C. by Cn. Flavius, the scribe of Appius Claudius the censor, and probably at the latter's instigation; or, in other words, that it was just the so-called *lex Flavianum* which all writers had hitherto regarded as a work dealing with the styles of *legis actiones* and the calendar of court days. In Pais's view the annalists, in accordance with a habit of theirs, duplicated the same event by counterfeiting an earlier Appius Claudius, &c., in order to magnify the antiquity and authority of the laws collected by Flavius, while the whole account of the decemviral legislation was invented by them. More recently Professor Lambert of Lyons has attempted by similar arguments to prove that the XII. Tables were a private compilation of customs already in observance, and of sacerdotal and other rules already in circulation, made about 107 B.C. by the jurist Aelius Paetus, and were in fact identical with the *Trispetitio* or *Jus Aelianum*, which had always heretofore been supposed to contain merely a recension of the Tables with an interpretation and commentary.⁵ This is not the place to discuss these theories. Though of course incapable of positive disproof, the weight

⁴ Pais, *Storia di Roma* (Turin), i. 566 seq.

⁵ *Nouvelle Revue historique* (1902), xxvi. 149 seq.; *Revue générale du droit*, nos. 5 et 6; *Mélanges*, Appleton (1903), pp. 126 seq.

of presumptive evidence is against them; they have hitherto found little or no support from other Romanists, and they have, in our opinion, been sufficiently refuted on philological and other grounds by Girard¹ and others.²

There were provisions in the Tables that were almost literal renderings from the legislation of Solon; and others bore a remarkable correspondence to laws in observance in Greece, but they may have been only indirectly borrowed.³ By far the greater proportion of them, however, were native and original—not that they amounted to a general formalization of the hitherto floating customary law, for notwithstanding Livy's eulogium of them as the "fountain of the whole law, both private and public," it seems clear that many branches of it were dealt with in the Tables only incidentally, or with reference to some point of detail. The institutions of the family, the fundamental rules of succession, the solemnities of such formal acts as mancipation, *nexum*, and testaments, the main features of the order of judicial procedure, and so forth,—of all of these a general knowledge was presumed, and the decemvirs thought it unnecessary to define them. What they had to do was to make the law equal and to remove every chance of arbitrary dealing, by distinct specification of penalties and precise declaration of the circumstances under which rights should be held to have arisen or been lost, and to make such amendments as were necessary to meet the complaints of the plebeians and prevent their oppression in the name of justice. Probably very little of the customary law, therefore, was introduced into the Tables, that was already universally recognized, and not complained of as either unequal, defective or oppressive. Only one or two of the laws ascribed to the kings (assuming their greater antiquity) reappeared in them; yet the omission of the rest did not mean their repeal or implied denial of their validity, for they continued still in force during the Empire, and are founded on by Justinian in his *Digest*. Neither apparently were any of the statutes of the Republic anterior to the Tables embodied in them, although for long afterwards many a man had to submit to prosecution under these laws and to suffer the penalties they imposed.

The original Tables are said to have been destroyed when Rome was sacked and burned by the Gauls. But they were probably *Remains*, at once reproduced, and transcripts of them in more or less modernized language must have been abundant if, as Cicero says, they were still in vogue when the children were required to commit them to memory as an ordinary school task. This renders all the more extraordinary the fact that the remains of them are so fragmentary and their genuineness in many cases so debatable. They were embodied, as above mentioned, in the *Tripartita* of Sextus Aedius Paetus in the year 179 B.C., who probably republished them in somewhat modernized language and from whose work, it is thought, all later writers took their contents. They must have formed the basis of all the writings on the *ius civile* down to the time of Servius Sulpicius Rufus, who first took the praetor's edicts as a text; and they were the subjects of monographs even by authors later than Sulpicius, amongst them by M. Antistius Laebee in the early years of the Empire, and by Gaius, probably in the reign of Antoninus Pius. Yet a couple of score or so are all that can be collected of their provisions in what profess to be the *ipissima verba* of the Tables, though in a form in most cases more modern than what we encounter in other remains of archaic Latin of the 4th century of the city. These are contained principally in the writings of Cicero, the *Noctes Atticae* of Aulus Gellius, and the treatise *De verborum significatione* of Festus; the two latter dealing with them rather as matters of antiquarian curiosity than as rules of the law. There are also many allusions to particular provisions in the pages of Cicero, Varro, Gellius and the elder Pliny, as well as in those of Gaius, Paul, Ulpian and other ante-Justinian jurists; but these are not to be implicitly relied on, as we have evidence that they frequently represent the (sometimes divergent) glosses of the interpreters rather than the actual provisions of the statute. Reconstruction has therefore been a work of difficulty, and the results far from satisfactory, that of the latest editor, Voigt, departing very considerably from the versions generally current during the last half-century.⁴

¹ *Textes*, pp. 3-4; *Nouv. Rev. hist.* xxvi. 381 seq.

² Ermann, *Sav. Stift.* (1903), xxiii. 450; Lenel, *Z. d. Sav. Stift.* (1905), xxvi. 498.

³ The decemvirs may have obtained them either from Magna Graecia or from Etruria, as the story of a mission to Athens is improbable.

⁴ Dirksen's *Übersicht der bisherigen Versuche zur Kritik u. Herstellung d. Zwölftafel-Fragmente* (Leipzig, 1824), supplies the basis of almost all the later work on the Tables anterior to that of Voigt. Schoell, in his *Legis XII. Tab. reliquiae* (Berlin, 1866), made a valuable contribution to the literature of the subject from a philological point of view. His version has been adopted substantially by E. Blass in his *Pomponii*, pp. 118 seq. (6th ed. by Mommsen and Gradenwitz), and Girard in his *Textes* (3rd ed., Paris, 1903). See

In form the laws contained in the Tables were of remarkable brevity, terseness and pregnancy, with something of a rhythmic cadence that must have greatly facilitated their retention in the memory. Rarely, if ever, were the rules they embodied permissive; they were nearly all in the imperative mood, sometimes entering into minute detail but generally running on broad lines, surmounting instead of removing difficulties. Their application might cause hardship in individual instances, as when a man was held to the letter what he had declared in a *nexum* or mancipation, even though he had done so under error or influenced by fraudulent misrepresentations; the decemvirs admitted no exceptions, preferring a hard-and-fast rule to any qualifications that might cause uncertainty. The system as a whole is one of *ius* as distinguished from *fas*. In the royal laws execration (*sacratio capitis, sacer esto*) was a common sanction; and in the Tables it occurs only once pure and simple, and that with reference to an offence that could be committed only by a patrician,—material loss caused by a patron to his client (*patronus, si clienti fraudem fecit, sacer esto*). In all other cases the idea that a crime was an offence against public order, for which the community was entitled in self-protection to inflict punishment on the criminal, is prominent. Hanging and beheading, flogging to death, burning at the stake, throwing from the Tarpeian rock,—such are secular penalties that are met with in the Tables; but often, though not invariably, the hanging and so forth is at the same time declared a tribute to some deity to whom the goods of the criminal are forfeited (*consecratio bonorum*). The Tables also recognize the system of self-help.

The *manus injectio* of the third Table—the execution done by a creditor against his debtor—was probably in essence the same procedure as under the kings, but with the addition of some regulations intended to prevent its abuse. Against a thief taken in the act the same procedure seems to have been sanctioned; it was lawful to kill him on the spot if the theft was nocturnal, or even when it was committed during the day if he used arms in resisting his apprehension. According to Cicero there was a provision in these words: "si telum manu fugit magis quam jecit, arietem subicito"; this is perhaps just a re-enactment in illustrative language of the law attributed to Numa, that for homicide by misadventure—"if the weapon have sped from the hand rather than been aimed"—"a man was to be treated as really offending if the kind of him who had been slain. The original purpose must have been to stay the blood revenge, but in the Tables it can only have been intended to stay the prosecution which it was incumbent on the kinsmen of a murdered man to institute. So with talionic penalties: "si membrum rupit ni cum eo pacit, talio esto"—such, according to Gellius, were the words of one of the laws of the Tables, and they undoubtedly recognize talion, "an eye for an eye, a tooth for a tooth"; while at the same time regulating it by enabling the injured man to bring an action and sanctioning a money recompense (*Wergeld*) in lieu of it.

The structure of the provisions of the Tables was not such as to enable the plain citizen to apply them to concrete cases, or to know how to claim the benefit of them in the tribunals, without some sort of professional advice. Pomponius states that no sooner was the decemviral legislation published than the necessity was felt for its interpretation, and for the preparation by skilled hands of styles of actions by which its provisions might be made effectual. Both of these duties fell to the pontiffs as the only persons who, in the state of civilization of the period, were well qualified to give the assistance required; and Pomponius adds that the college was really appointed one of its members to be the adviser of private parties and of the *judices* in those matters. The *interpretatio* commenced by the pontiffs and continued by the jurists during the Republic, which, Pomponius says, was regarded as part of the *ius civile*, was not confined to explanation of the words of the statute, but was in some cases their expansion, in others their

Interpretation
of the
Tables.

also Muirhead, *Historical Introduction* (2nd ed., 1899), and Wordsworth, *Fragments and Specimens of Early Latin* (Oxford, 1874), pp. 253 seq. The last-named writer in a subsequent part of his volume (pp. 502-38) has added notes, historical, philological and exegetical, which constitute a valuable commentary on the Tables as a whole. Voigt's two volumes, under the title of *Geschichte und System des Civil- und Criminalrechts der Römer* (Leipzig, X. II. *Tafeln nach deren Fragmenten* (Leipzig, 1883), contain an exposition of the whole of the earlier *ius civile*, whether embodied in the Tables or not. The history of them occupies the first hundred pages or thereabouts of the first volume; his reconstruction of fragments and allusions—a good deal fuller than any earlier one and supported by an imposing array of authorities, which, however, often rest on arbitrary assumptions—is in the same volume, pp. 693-737.

⁵ There is little doubt that *talio* was actually enforced under the decemviral code, just as it was under the Jewish and Mohammedan codes, and as we see it among semi-civilized communities (e.g. the Abyssinians) at the present day. See *Code de Kharak*, *Ann. de la Fac. de Droit*, xvii. 20; Lane, *Modern Egyptians*, p. 94. Many references are given by Lenel in *Z. d. Sav. Stift.* xxiv. 509.

limitation, and in many the deduction of new doctrines from the actual *jus scriptum*, and their development and exposition. An event that did much to diminish the influence of the pontiffs in connexion with it was the divulgement in the year 304 B.C., as already mentioned, by Cn. Flavius, of a formulary of actions and a calendar of lawful and unlawful days, which got the name of *Jus Flavianum*. The practice adopted in the beginning of the 6th century by Tiberius Coruncanus, the first plebeian chief pontiff, of giving advice in law in public had a still greater effect in popularizing it; and the *Tripartita* or *Jus Aetianum*, some fifty years later—a collection that included the Tables, the *interpretatio* and the current styles of actions—made it as much the heritage of the laity as of the pontifical college.

Subsequent Legislation.—Of legislation during the 4th and 5th centuries that affected the private law we have but scanty record. The best-known enactments are the Canuleian law of 445 B.C. above mentioned; the Genucian, Marcian and other laws about usury and the rate of interest; the Poetilian law of 326 B.C. abolishing imprisonment of nexal debtors by their creditors; the Silian law, probably not long afterwards, which introduced a new form of process for actions of debt; and the Aquilian law about 287 B.C., which amended the decemviral provisions for actions of damages for culpable injury to property, and continued to regulate the law on the subject even in the books of Justinian.

iii. Development of the Substantive Institutions of the Law.

The Citizen and his "Caput."—The early law of Rome was essentially personal, not territorial. A man enjoyed the benefit of its institutions and of its protection, not because he happened to be within Roman territory, but because he was a citizen,—one of those by whom and for whom its law was established. The theory of the early Romans was that a man sojourning within the bounds of a foreign state was at the mercy of the latter and its citizens, that he himself might be dealt with as a slave, and all that belonged to him appropriated by the first comer; for he was outside the pale of the law. Without some sort of alliance with Rome a stranger had no right to claim protection against maltreatment of his person or attempt to deprive him of his property; and even then, unless he belonged to a state entitled by treaty to the international judicial remedy of *recuperatio*, it was by an appeal to the good offices of the supreme magistrate, or through the intervention of a citizen to whom he was allied by the (frequently hereditary) bond of *hospitium*, and not by means of any action of the *jus civile* set in motion by himself. A non-citizen—originally *hostis*, and afterwards usually called *peregrinus*¹—in time came to be regarded as entitled to all the rights recognized by so-called *jus gentium* as belonging to a freeman, and to take part as freely as a Roman in any transaction of the *jus gentium*; but that was not until Rome, through contact with other nations and the growth of trade and commerce, had found it necessary to modify her jurisprudence by the adoption of many new institutions of a more liberal and less exclusive character than those of the *jus civile*.

A citizen's civil personality was technically his *caput*. The extent of it depended on his family status. It was only among citizens that the supremacy of the *paterfamilias* and the subjection of those *in manu, potestate* or *mancipio* were recognized—only among them therefore that the position of an individual in the family was of moment. While in public life a man's supremacy or subjection in the family was immaterial, in private life it was the *paterfamilias* alone who enjoyed full jural capacity. Those subject to him had a more limited personality; and, so far as capacity to take part in transactions of the *jus civile* was concerned, it was not inherent in them but derived from their *paterfamilias*: they were the agents of his

will, representatives of his *persona* in every act whereby a right was acquired by them for the family to which they belonged.

Whenever a citizen either ceased altogether to be a member of a Roman family or passed, either permanently or temporarily, into subjection to some *paterfamilias* outside his own "*Capitis deminutio.*"² there was technically *capitis minutio* or *capitis deminutio*. To harmonize with the gradually established conception of jural personality in non-citizens, and perhaps also from their partiality for tripartite divisions, the jurists about the end of the Republic divided *capitis deminutio* into three degrees, viz. *maxima*, *media* and *minima*—a division unknown to lawyers of an earlier period when *civitas* was theoretically identified with *libertas*. When a citizen forfeited his freedom, his *capitis deminutio* was said to be *maxima*; he lost all capacity, whether under the *jus civile* or the *jus gentium*. When, retaining freedom, he went into exile or joined a Latin colony, or otherwise became a peregrin, the loss (*deminutio*) of his capacity was only *media* or *minor*; it was his rights and privileges under the *jus civile* that alone were affected. When both freedom and citizenship remained, and there was produced merely the severance of connexion with a particular family (*familiae mutatio*), the loss was said to be *minima*. Illustrations of *c. d. minima* present themselves in the case of a *paterfamilias* becoming *filiusfamilias* by adoption, or a *materfamilias* passing into the hand of a husband by confarration or coemption; in both cases he or she who had been *sui juris* thereby became *alieni juris*. It was immaterial whether the change was from a higher family position to a lower, or from a lower to a higher,³ or to the same position in the new family that had been held in the old—as when a *filiusfamilias* was transferred by his father into the *potestas* of an adopter, or when the *filiifamilias* of a person giving himself in adoption passed with him into the *potestas* of the adopter: in every case there was *capitis minutio*. It was not the change of family position that caused it, but the subjection to a new *potestas*. Thus the civil personality of Titius while a *filiusfamilias* in the *potestas* of Sempronius, e.g. the expectancy of succession, the agnatic relationships, the derivative capacity for being a party to a mancipation or a *ponio* that resulted from the relationship, all came to an end through the subjection to a new *paterfamilias*, temporary or permanent. He might acquire another and independent capacity on becoming *sui juris* by emancipation, or another derivative capacity on passing into the *potestas* of Maevius by adoption; but while subject to a new *paterfamilias* his old personality *quoad civilia* was extinguished. This is what some of the jurists mean when they say that *capitis deminutio* was civil death.⁴

An important consequence of *minima capitis deminutio* was that it not only extinguished *patria potestas* where it existed, but severed the bond of agnation between the *capite minutus* and all those who had previously been related to him as agnates. There was no longer any right of succession between them on intestacy; their reciprocal prospective rights of tutory were defeated, and the *minutio* of either tutor or ward put an end to a subsisting guardianship, assuming always that it was a *tutele legitima* or agnatic *cura furiosorum*. Very remarkable, yet quite logical, was the doctrine that the *minutio* extinguished the claims of creditors of the *minutus*; their debtor, the person with whom they had contracted, was civilly dead, and dead without an heir, and therefore there was no one against whom an action of the *jus civile* could be directed in order to enforce payment. But equity eventually provided a remedy, by

¹ This is Mommsen's theory. See *Staatsrecht*, iii. 1, p. 8.

² Children who became *sui juris* by their parent's death, as they came under no new *potestas*, were not regarded as *capite minutus*.

³ Owing to the ill-defined views among the Roman jurists themselves regarding the nature of *cap. dem.* various theories more or less divergent have been maintained about it by modern writers, of none of which can it be said that it has been generally accepted. Mommsen's theory, above adopted, seems to present fewest difficulties. See the subject discussed and authorities cited by Goudy in 2nd edition of Muirhead's *Historical Introduction*, pp. 422-27.

⁴ Neither "alien" nor "foreigner" is an adequate rendering of *peregrinus*. For *peregrinus* included not only citizens of other states, independent or dependent, but also *ἀλλοτρίαι*,—men who could not call themselves citizens (*cives*) at all, as, for example, the *deductici* whom Rome had vanquished and whose civic organization she had destroyed, offenders sent into banishment, &c., and also, until Caracalla's general grant of the franchise, the greater portion of her provincial subjects.

giving the creditors a praetorian action in which the *minutio* was held as rescinded, and which the new *paterfamilias* was bound to defend on pain of having to give up all the estate he had acquired through the adrogation or *in manum conventio*. In other respects also the strict effects of this *capitis minutio* were attenuated or done away with by the jurists of the Empire, e.g. as regards personal servitudes.

The Law of the Family Relations.—So far as appears no serious inroad was made by the XII. Tables on the law affecting husband and wife, unless in the recognition of the legality of so-called "free" marriages, i.e. entered into without any solemnity, and not involving that subjection of the wife to the husband (*manus*) which was a necessary consequence of the patrician confarreatio and plebeian coemption. These latter were left untouched, while on the other hand acquisition of marital *manus* through *usus* was fully recognized. As formerly mentioned, it had become a practice with some of the plebeians to tie the marriage bond rather loosely in the first instance, possibly in consequence of objection by the women (as became quite general even among patricians at a later period) to renounce their independence and right to retain their own property and earnings, but more probably because taking a woman to be merely the mother of children (*matrimonium*) had been practically forced upon them before coemption had been introduced as a means of making her a lawful wife, and so they had become in a manner habituated to it. But the idea that, as a man might acquire the ownership of a thing to which his legal title was defective by prolonged possession of it, so he might acquire *manus* over the woman with whom he had thus informally united himself by prolonged cohabitation with her as his wife had probably matured and become customary law. The Tables accepted it; all that was needed was to define the conditions under which *manus* should be held to have been superinduced, and the wife converted from a doubtful *uxor* into a lawful *materfamilias*. Hence the provision that, if a woman, married neither by confarreatio nor coemption, desired to retain her independence, she must each year absent herself for three consecutive nights from her husband's house (*trinoctialis usurpatio*)—twelve months' uninterrupted cohabitation being required to give him that power over her which would have been created instantly had the marriage been accompanied by either of the recognized solemnities.

Amongst the fragments of the Tables so industriously collected there is none that refers to a wife's marriage portion (*dote*); but it is hardly conceivable that it was as yet unknown. Justinian says in ancient times it was regarded as a donation to the husband with his wife, rather than as a separate estate that was to be used by him while the marriage lasted but to revert to her or her representatives on its dissolution. And it is easy to see that, where there was *manus*, the wife becoming a member of her husband's family and everything of hers becoming his, such must originally have been its character.¹ But even then, when a man gave his daughter (*filiafamilias*)—who could have nothing of her own—in marriage, and promised her husband a portion with her, there must have been some process of law for compelling him to pay it; and Voigt's conjecture that an *actio dictae dotis* was employed for the purpose has something in its favour.² As regards divorce, Cicero alludes vaguely to a provision in the Tables about a man depriving his wife of the house-keys and turning her out of doors, with some such words as "take what is thine and get thee gone." This can only refer to free or non-*manus* marriages, but even for hand marriages, while repudiations by husbands (but not by wives) were competent, the statement of the historians is that they were few and far between until the 6th century of the city, and that, until the same date, any man who turned his wife away, however serious the ground, without the cognition of the family council, was liable to penalties at the hands of the censors.³

Of the two or three provisions of the Tables known to us that affected details of the *patria potestas*, which itself was assumed to be so well established by customary law as to need no statutory sanction or definition, one was in the words "si pater (familias) ter filium venum ducit, a patre filius liber esto." This came to be construed by the pontifical lawyers as meaning that so powerful

was the bond of the *potestas* over a son that it could not be completely loosed until the father had three times gone through the process of fictitious sale by which emancipation was effected. But the conception of the law seems to indicate that its original purpose must have been rather to impose a penalty on the father and confer a benefit on a son *in potestate*, by declaring him *ipso iure* free from it on a certain event, than to place difficulties in the way of his emancipation. "If a house-father have thrice sold his son, the latter shall be free from his father." It reads as if the intention were to rescue the son from what, by its frequent repetition, was suggestive of a total absence of parental affection rather than reluctant obedience to overwhelming necessity. May not its object have been to restrain the practice, which did not wholly disappear even in the late Empire, of men selling their sons or giving them to the *latores* in security for their debts, and then pledging, at the time of the Tables, being effected only by an actual transfer of the child *per aes et libram* as a free bondman (*in mancipii causa*), accompanied by, in the case of a loan, a pact for reconveyance when the loan was repaid? Whatever its ratio, however, and whatever the earlier practice, it was upon this law that the interpreting pontiffs based the rules for adoptions and emancipations of *filiafamilias*. The usual procedure in adoptions was as follows: The natural father emancipated his son to a friend for a nominal price, and the latter then adopted him, the son thus returning to his father's *potestas*. This was repeated a second time with the same result. After the third sale (*patria potestas* being extinguished) the purchaser reconveyed to the parent. In the latter's hands the son was now *in causa mancipii*, and so in a position in which he could be permanently transferred to the adopter. This was effected by an *in iure cessio*, in which the adopter averred that the child was his *filiusfamilias*, and in which judgment was at once given in his favour on the natural parent's admission or tacit acquiescence. A similar method was followed in emancipation of a *filius*, except that of course there was no *cessio in iure*, but instead thereof the parent manumitted immediately after the reconveyance to him. Neither in adoption nor emancipation, however, was reconveyance to the *paterfamilias* essential, though it was usual, and in the case of emancipation carried with it important rights of succession and tutory. For daughters and grandchildren the pontifical jurists by a casuistic interpretation of the *six* law held emancipation to be in all cases enough to extinguish the *patria potestas*.

The nature of the relation between master and slave, like that of *manus* and *patria potestas*, seems also to have been too notorious to require exposition in the Tables. We find recorded only two references to it, one dealing with the case of a slave who had a conditional testamentary gift of freedom (*statu liber*), the other with noxal surrender (*noxae deditio*). The provision about noxal surrender was not limited to a slave; it was apparently to the effect that if a member of a man's family (a man, or a woman, or a daughter *in potestate* or a slave) committed a theft of, or did mischief to, property belonging to a third party, or a domestic animal belonging to one man did harm to another, the father of the delinquent child, or the owner of the slave or animal, should either surrender him or it to the person injured or make reparation in damages. In course of time the surrender came to be regarded as a means of avoiding the primary obligation of making reparation. But comparative jurisprudence recognizes in the enactment of the Tables a modification of survival of the ancient right of an injured party to have the delinquent *corpus*—man, beast or thing—given up to him to wreak his revenge upon it privately, the modification consisting in the alternative of reparation offered to the owner. This noxal surrender, failing reparation, had gone out of use in the case of daughters *in potestate* before the time of Gaius, and in the case of sons before that of Justinian; but it was still sanctioned so far as slaves and domestic animals were concerned even in that emperor's legislation.

Guardianship and the Introduction of the Order of Agnates.—So long as Rome was patrician the *gens* apparently charged itself with the guardianship of a clansman's orphan pupil (*gentile guardianship*), and his widow and unmarried daughters (*gentile guardianship*) above pupillarity after his decease (*tutela*), as well as with that of male members of his family who were *sui juris*, but above the age of pupillarity, when they chanced to be lunatic, imbecile, prodigal or helplessly infirm (*cura, curatio*). The *gens* in council, in all probability, appointed one of its members to act as tutor or curator as the case might be, itself prescribed his duties, and itself called him to account for any failure in his administration.

But, as this gentile tutory could not be extended to the plebeians, among whom some law of guardianship was as much required as among their fellow-citizens of the higher order, the decemvirs found it expedient to devise a new one of universal application. The Tables contained no express authority for testamentary nomination of tutors to the widow

¹ See Cicero, *Top.* iv. 23.

² Voigt, *XII. Tafeln*, ii. p. 486. It has not, however, received any support from more recent writers.

³ See Esmein, *Mélanges*, pp. 23 seq.

of the testator, or to his pupil children and grown-up unmarried daughters; but such appointment, if unknown previously, was soon held to be justified by a liberal interpretation of the very inclusive provision, "uti legassit suae rei, ita jus esto." In the absence of testamentary appointment the nearest male agnates of lawful age were to be tutors. This tutory of agnates was an invention of the decemvirs, just as was the agnates' right of succession on intestacy. The plebeians had no *gentes*, at least until a much later period; so, to make the law equal for all, it was necessary to introduce a new order of heirs and tutors. "Tutores . . . ex lege XII. Tabularum introducuntur . . . agnati" is the very notable language of Ulpian. And his words are very similar in speaking of their right of succession; for, while he says of testamentary inheritances no more than that they were confirmed by the XII. Tables, he explains that the *legitima hereditates* of agnates and patrons were derived from them.¹ The phrases *legitima cognatio*, *legitima hereditas*, *legitimi heredes*, *tutela legitima*, *tutores legitimi* themselves proclaim the origin of agnation, agnatic inheritance and agnatic tutory; for, though the word *legitimus* might be applied to any institution based on statute, yet in the ordinary case it indicated one introduced by the XII. Tables, the law of laws.

A man's agnates, in the strict sense, were those of his collateral kinsmen who were subject to the same *patria potestas* as himself, or would have been had the common ancestor been still alive. A man's sons and daughters *in potestate*, therefore, whether the relationship was by birth or adoption, and his wife *in manu* (being *filiae loco*) were each other's agnates. But a wife not *in manu* was not their agnate; nor were children who had been emancipated or otherwise *capite minuti* the agnates of either their brothers and sisters or their mother *in manu*. A man was an agnate of his brother's children, assuming always that there had been no *capitis deminutio* on either side; but he was not an agnate of his sister's children, for they were not *eiusdem familiae*: they were agnates of their father's family, not of their mother's. In like manner, and again assuming the absence of *minutio capitis*, the children of brothers were each other's agnates, but not the children of a brother and a sister or of two sisters. Brothers and sisters were agnates of the second degree; a man and his brother's children were of the third, the children of two brothers (*patrueles*) of the fourth, and so on,—it being a condition, however, that the kinship should always result either from lawful marriage or from adoption in one or other of its forms.

When, therefore, a man died leaving pupil male descendants or unmarried female descendants who by his death became *sui juris*, they got their brothers of lawful age as their tutors; if he was survived by his wife, and she had been *in manu*, her sons, or it might be stepsons, acted for her in the same capacity; in either case they took office as the nearest qualified male agnates. If the widow had no sons or stepsons of full age, and the children consequently no qualified brothers, the tutory devolved on the agnates next in order,—i.e. the brothers german and consanguineal of the deceased husband and father; for they were agnates of the third degree. And so with agnates of the fourth and remoter degrees.² Failing agnates who could demonstrate their propinquity, the tutory passed to the *gens* when the ward happened to belong to one. This is nowhere expressly stated; but Cicero gives what he represents to be an enactment of the Tables, making the fellow-gentiles of a lunatic his guardians on failure of agnates; and analogy seems to justify the extension of the same rule to the case of sane pupil and female wards.³

The curatory of minors above pupillarity was of much later date than the Tables. The only curatories they sanctioned were those of lunatics (*furiis*) and spendthrifts (*prodigi*). A

¹ Ulp. *Frag.* xxvii. 5. "legitima hereditatis jus . . . ex lege Duodecim Tabularum descendit." This derivation of agnatic inheritance from the XII. Tables was specially noticed by Danz in his *Gesch. d. röm. Rechts* (2nd ed., Leipzig, 1871-73), ii. 95, but is generally ignored.

² To determine the degree of propinquity between two persons it was necessary to count the generations upwards from the first to the common ancestor and downwards from him to the second. Consequently brothers were related in the second degree, uncle and nephew in the third, first cousins in the fourth, and so on.

³ See Gal. i. 165.

lunatic was committed to the care of his agnates, and, failing them, of his fellow-gentiles; and a few words in Festus seem to suggest that arrangements had to be made by them for his safe custody.

Mancipation and the Law of Property.—In the early law, as we have seen, there was no technical word for ownership of things: it was an element of the house-father's *manus*. In time, although it is impossible to say when, the word *dominium* came into use, but, so far as can be discovered, it did not occur in the XII. Tables, and must have been of later introduction. In those days, when a man asserted ownership of a thing, he was content to say, "It is mine," or "It is mine according to the law of the Quirites." It is said by some jurists of eminence that under the law of the Tables what afterwards came to be called "dominium ex jure Quiritium" was competent only in the case of *res mancipi*—of a man's house and farm, and things appurtenant thereto, as slaves and animals with which he worked them. There is much to be said for this hypothesis, but it is so far contradicted by Ulpian and Paul, who tell us that *tigna juncta* (that is, building materials, vine stakes and the like, which undoubtedly were *res nec mancipi*) were exceptionally excluded from vindication. On the other hand, these texts may be explained as mere deductions by interpretation at a later time of the words "ne solvito" of the XII. Tables.⁴ At any rate it is pretty certain that before the close of the present period *res nec mancipi* as well as *res mancipi* could be held in quiritarian ownership.

The modes in which these two classes of things might be acquired in property were various. But there was this important difference: that, while a natural mode of acquisition sufficed in the case of *res nec mancipi*, some civil one was necessary for the derivative acquisition, at all events, of *res mancipi*. The most important were mancipation, surrender in court, usucapion and bequest as singular modes, and inheritance, *in manu conventio*, adrogation and purchase of a confiscated estate, as universal ones. All of these, with the exception of mancipation, applied equally to *res mancipi* and *res nec mancipi*. But there was, in addition, for *res nec mancipi*, what was the commonest of all the modes of transferring things of this class, simple tradition. If the transfer of these was by the owner, with the intention of passing the property, then the simple delivery of possession (*traditio*) was enough, unless indeed it was in virtue of a sale; in which latter case the ownership remained with the vendor, notwithstanding the change of possession, until the price was paid or security given for it.⁵ Only mancipation, surrender in court and usucapion, however, need be noticed at present.

The origin of the distinction between mancipable and non-mancipable things, and of the form of conveyance by mancipation applicable to the first, has been explained (*supra*, p. 529).⁶ Originally mancipation was not the imaginary sale that Gaius speaks of, but as real a sale as could well be conceived—the weighing in scales, held by an official, of the raw metal that was to be the consideration for the transfer of a *res mancipi*, and the handing of it by the transferee to the transferee, with the declaration that thereby and therewith the thing in question became his in quiritary right. On the introduction of coined money weighing became unnecessary. The price was counted out before the ceremony, or sometimes left to be done afterwards; and though, in that spirit of conservatism that was so marked in the adhesion

⁴ Dig. xlvii. 3. 1 pr. and xlvii. 3. 98, § 8. See Cug. *Inst. Jurid.* 2nd ed. i. 91 n.; and on *tignum junctum* in general, Girard, *Manuel de droit romain*, 4th ed. p. 330.

⁵ Our only authority for attributing this fundamental rule to the XII. Tables is Justinian's *Institutes*, ii. 1, § 41, where there is clear evidence of a Tribonianism. The rule undoubtedly must have been applied to *res mancipi* in the Tables, and possibly its extension to tradition of *res nec mancipi* may have been due to interpretation. See Girard, *ut supra*, p. 288; cf. Cug. *Institutions Jurid.* i. p. 87.

⁶ Literature: Leist, *Mancipation und Eigenthumstradition* (Jena, 1865); Jhering, *Geist d. röm. Rechts*, vol. ii. § 46; Bechmann, *Der Kauf nach gemeinem Recht* (Erlangen), i. pp. 47-302; Voigt, *XII. Tafeln*, vol. i. § 22, vol. ii. §§ 84-88; Kalowa, *Röm. Rechtsgesch.* ii. pp. 303-81.

Ownership in "res mancipi" and "res nec mancipi."

to time-honoured forms after their *raison d'être* was gone, the scale-bearer and the scales were still retained as indispensable elements of the mancipation, yet the scales were simply touched by the purchaser with a *raudusculum* or a single coin, in order that he might be able to recite the old formula: "I say that this slave is mine in quiritary right, and that by purchase (for such and such a price, with these scales and this bit of copper)." And that one coin, says Gaius, was then handed by the transferee to the transferee as if it were in fact the price of the purchase (*quasi pretii loco*). Thus transformed, the mancipation was undoubtedly an imaginary sale; for the real price might have been paid weeks or months before, or might not be paid until weeks or months afterwards. The mancipation had become nothing more than a conveyance, and in this form it continued down to the end of the 3rd century of the Empire, or at least to the appropriate mode of transfer of things (*res mancipi*, or of things of conferring on the transferee of such a thing as complete legal title (*commissum ex jure quiritium*). After that, however, it seems gradually to have gone into disuse, being inapplicable to lands out of Italy that did not enjoy what was called *jus Italicum*; and long before the time of Justinian it had practically disappeared.

The effects of a mancipation, provided the price had been paid or security given for it, were that the property passed instantly to the purchaser, and that the transferee was held to warrant the transferee against eviction from the moment the price was received. In the absence of the payment of the price, the transferee remained with the vendor, so that it was in his power, by means of a real action, to get back what had been mancipated, even though it had passed into the possession of the vendee. The vendor's liability to the vendee in the event of eviction is usually supposed to have arisen *ipso jure*—that is to say, without anything expressly said about it; the acceptance by the transferee of the coin with which the scales had been struck was held to have imposed upon him an obligation to maintain the transferee in possession, under a penalty of double the amount of the price, recoverable by the latter, by what is usually called an *actio auctoritatis*. But this *ipso jure* obligation did not arise when the mancipation was either really or fictitiously gratuitous (*nummo uno*),—really, in the case of donations, &c., fictitiously, when, on purpose to exclude the warranty, the recital of the transferee was that the price was a single sestertius.

The right of a vendee to sue an *actio auctoritatis* arose only when eviction resulted from a decree in a regular judicial process at the instance of the true owner, or of a person claiming a legal title on his having done all that was necessary on his part to bring his vendor (*auctor*) into the field to defend his own interests. And the duration of the *auctoritas* was limited by the Tables to two years in the case of lands and houses, to one year in the case of other things. As possession for those periods was sufficient to cure any defect in the vendee's title, it was but reasonable that with their expiry the vendor's liability on his warranty should be at an end.

By a provision of the Tables in the very inclusive terms, *cum nemo faceret mancipationem, in omnia nuncupatio, ita jus esto*,¹ the importance of mancipation was immensely increased for any sort of qualification germane to the transaction itself, superinduced upon it, and the range of its application thus greatly extended. Such qualifications were spoken of as *leges mancipii*,—self-imposed terms, conditions or qualifications of the conveyance and, as integral parts of the transaction *per aes et libram*, they partook of its binding character and were law between the parties. The matter of oral declaration might be the acreage of lands, their freedom from burdens or right to easements, reservation of a usufruct, undertaking to reconvey on a certain event, or what not, so long as it did not express a term or condition; the result was just so many obligations created *per aes et libram*, whose contravention or denial (Cicero tells us) was punished with a twofold penalty.² Ordinarily the words spoken in the hearing of the witnesses fixed the beginning and the end of the liability; it was enough that they were literally complied with, however much the other party might be injured by something inconsistent with their spirit, or that the party had not taken the precaution to require should be made matter of declaration. But there was an exception (although not introduced until long after the Tables) in the case of that particular mancipatory agreement which was known by the name of *fiducia*, i.e. where the mancipation was by a creditor in security or to a friend for safe custody, and the engagement was to return the thing mancipated, in the one case when the debt secured by it was paid and in the other on demand. In such cases the transferee took the conveyance more in the transferrer's interest than his own; he became a sort of trustee, entitled to be treated with consideration and not to be murdered in a way when his inability to reconvey was due to no fault of his, nor forced to reconvey until relieved of charges incurred by him in reference to

the property. Accordingly it became the practice to import into the mancipation a reference to *fides*—*fidi fiducia causa meum esse aio*,³ with explanation of the purpose, conditions, &c., of the *fiducia*, and this explanation as a rule not in the nuncupatory words, forming a relative *lex mancipii*, but in a separate agreement or *pactum fiduciae*. This pact then became enforceable not by ordinary *legis actiones* as part of the mancipation, but separately on grounds of good faith alone. It gave rise to an *actio fiducia* which some writers think was just an application of the *legis actio pro judicis postulationem*, but which more probably was originally an action *in factum* granted by the urban praetor by virtue of his *imperium*. In any case it was one of the earliest instances of an action *inter cives* based on principles of good faith. The fiduciary clause had the effect of freeing alike the right of the vendor and the obligation of the vendee from the hard-and-fast lines of the *jus strictum*, and subordinating them to the principles of *bona fides*.⁴

Of the civil modes of acquiring property a singular title applicable to both *res mancipi* and *res nec mancipi* surrender in court (*in jure cessio*) was just a *rei vindicatio* arrested in its initial stage. The parties, cedent and cessionary, having previously arranged the terms of transfer—sale, donation or otherwise—appeared before the magistrate; the cessionary, taking the position of plaintiff, declared the thing his in quiritary right; the cedent, as defendant, was asked what he had to say in answer; and, on his admission or silence, the magistrate at once pronounced a decree (*adjudicium*) which completed the transfer, but which might be subject to a fiduciary reservation or deduction of a servitude. It was probably more resorted to for the constitution of servitudes, both real and personal, and transfer of such rights as *patria potestas*, tutor-at-law of a woman, or an agnatic inheritance that had already opened, than for conveyance of property. For it was not only inconvenient, inasmuch as it required the parties to appear before the supreme magistrate in Rome, and could not be carried through by any one under power (as conveyance might), but it had also the serious disadvantage that it did not *ipso jure* imply any warranty of title by the cedent in the event of eviction or give rise to an action *de modo agri*. Nor did it, like mancipation and tradition, make payment of the price a condition precedent of the transfer of property. The reason was that in form the right of the cessionary flowed from the magisterial decree: "Since you say the thing is yours, and the cedent does not say it is his, I declare it yours," and not from any act or word of the cedent's, who was passive in the matter.

Usucapion,⁵ regulated by the XII. Tables, but not improbably recognized previously in a vague and uncertain way, converted uninterrupted possession (*usus*) into quiritary property by efflux of time. The provision in the Tables, as given by Cicero, was to this effect: "*usus auctoritas fundi biennium est, ceterarum rerum omnium annus est*." The relation in which the words *usus* and *auctoritas* stand to each other has been a subject of much discussion: the prevailing opinion amongst modern civilians is that the two words should be taken disjunctively, the first alone referring to usucapion, and the second to the warranty of title incumbent on the vendor in a mancipation, and that both were limited to two years in the case of lands (and, by extensive interpretation, houses), and to one year in the case of anything else. In the later jurisprudence the possession required to be based on a sufficient title and the possessor to be in good faith. But the decemviral code, as is now generally admitted, contained no such requirements; any citizen occupying immovables or holding movables as his own, provided they were usucaptable and he had not taken them theftuously, acquired a quiritary right in two years or one, as the case might be, simply on the strength of his possession. Originally, therefore, it was simply the conversion of *de facto* possession, no matter how acquired so long as not by theft, into legal ownership when prolonged for the statutory period,—too often the maintenance of might at the cost of right. But in time it came to be regarded rather as a remedy for some defect of title, arising either from irregularity of conveyance or incapacity of the party from whom a transfer had been taken; and with the progress of

¹ There is much diversity of opinion about *fiducia*. See Oertmann, *Fiducia im röm. Privatrecht* (Berlin, 1890); Girard, *Manuel*, 4th ed. pp. 519-23; Söhm, *Institutionen* (Eng. trans., 2nd ed.), pp. 63-65.

² Literature: Stintzing, *Das Wesen von bona fides und titulus in d. röm. Usucapionslehre* (Heidelberg, 1852); Schirmer, *Die Grundzüge d. Usucapion im röm. Recht* (Berlin, 1855); Pernice, *Lehrb. über d. röm. Recht*, 2d ed., § 10, 11; *Festschr. v. d. K. u. K. Anst. d. R.G.*, ii. 387 seq.; Esmein, "Sur l'histoire de l'usucapion," *Mélanges* (1886), pp. 171 seq.

³ *Cic. de Off.* iii. 16, § 65. Some writers, e.g. Girard, *Manuel de droit romain*, p. 550, n. 5, take the view that, apart from the *actio auctoritatis*, there is another, the extent of which was limited to the *actio de modo agri* (that the penalty of a *duplum* was *ipso jure* incurred. But this puts a gloss on Cicero's language.

Surren-
der court.

Usu-
capio.

jurisprudence it developed into the carefully regulated positive prescription which has to a greater or less extent found a place in every modern system.

The conception of the abstract notion of a real right in (or over) the property of another person (*jus in re aliena*) is not to be looked for as so early a period in the history of the law as that now under consideration. The rural servitudes of way and water were no doubt very early recognized, for they ranked as *res mancipi*, and the XII. Tables contained various regulations in reference to the former. Usufruct, too, was probably not unknown; but the urban praedial servitudes bear the impress of a somewhat later jurisprudence. Pignorate and hypothecary rights were certainly unknown as rights protected by action.¹ Between private parties the only thing legally recognized of the nature of a real security was the *fiducia* that is described above. Approaching more nearly to the modern idea of a mortgage was the security *praedibus praediisque* required by the state from those indebted to it in assurance of their obligations. Here there was the double guarantee of sureties (*praedes*) and mortgages of lands of theirs (*praedia subsignata*); but how they were dealt with when the debtor made default is by no means clear.

Changes in the Law of Succession.—The two forms of testament of the regal period, viz., that made in the *comitia* of the curies and that by soldiers on the eve of battle, still remained in use in the early Republic; though before the end of the Republic they were displaced by the general adoption of that executed with the copper and scales (*testamentum per aes et libram*). It seems to be the general opinion that it was to the first two alone that the words applied which stood in the forefront of the provisions of the XII. Tables about inheritance: "uti legassit suae rei, ita jus esto." Whether resort was to the *comitia* or to the army, the testator's own will in the matter was henceforth to be supreme. There was to be no more reference to the pontiffs as to the expediency of the testament in view of the interests of the family *sacra* and of creditors of the testator's; from legislators, sanctioning a departure from the ordinary rules of succession, the assembled Quirites became merely witnesses—recipients of the oral declaration of the testator's will in regard to his inheritance.²

The testament with the copper and the scales is depicted by Gaius as a written instrument. But he presents it in what might be described as the third stage of its history. Its probable origin has been explained (*supra*, p. 534). It was originally not a testament but only a makeshift for one. A plebeian was not qualified in the regal period to make a testament in the *comitia*; so, instead, he transferred his estate to a friend on whom he could rely, with instructions how to distribute it on his death. The transferee was called *familiae emptor*, because the conveyance was in form a mancipation for a nominal price.

It is not at all unlikely that the same device may occasionally have been resorted to by a patrician who had neglected to make a regular testament, and was seized with mortal illness before he had an opportunity of appealing to the curies.³ But such a disposition was not a testament, and may not have been so called. A testament was the nomination of a person as the testator's heir. It made the person instituted as fully the representative of the testator after his death as his heir-at-law would have been had he died

intestate. The original *mortis causa* mancipation that opened the way for the testament *per aes et libram* conferred upon the *familiae emptor* no such character. Gaius says that he stood in place of an heir (*heredis loco*), inasmuch as he had such of an heir's rights and duties as the *familiae venditor* had it in his power to confer and impose; but the transaction was but a conveyance of estate, with a limitation of the right of the grantee. It has been argued that, as the law did not recognize conditional mancipation, the conveyance must have operated as a complete and immediate divestiture of the grantee. But this does not follow. For it was quite competent for a man, in transferring property by mancipation, to reserve to himself a life interest; and apparently it was equally competent for him to postpone delivery of possession, without infringing the rule that the mancipation itself could not be *ex certo tempore*. So far as one can see, therefore, there was nothing to prevent the grantor of the conveyance (or quasi-testator) bargaining that he was to retain the possession till his death; and, as the *familia* was an aggregate of estate (*universitas rerum*) which retained its identity notwithstanding any change in its component elements, he must in such case have been as free to operate on it while he survived, as if he had never conveyed it by mancipation.

Cicero incidentally remarks⁴—what indeed the nature of the transaction of itself very distinctly suggests—that the true testament with the copper and the scales had its statutory warrant, not in the *uti legassit suae rei* of the XII. Tables, but in the provision contained in the words: "cum nexum faciet mancipiumque, uti lingua nuncupasset, ita jus esto." Reflection on the import and comprehensiveness of these words led the pontifical interpreters to the conclusion that there was nothing in them to prevent the direct institution of an heir in the course of the *verba muncupata* engrafted on a mancipation. From the moment this view was adopted and put in practice the *familiae mancipatio* ceased to be a transfer of the testator's estate to the *familiae emptor*; the latter's purchase was now for form's sake only, though still an indispensable form, since it was it alone that, according to the letter of the statute, imparted efficacy to the *nuncupatio*. But it was the *nuncupatio*—the oral declaration addressed to the witnesses—that really contained the testamentary disposition, i. e. the institution of an heir, with such other provisions as the testator thought fit to embody in it. This was the second stage in the history of the testament *per aes et libram*. The third was marked by the introduction of tablets in which the testamentary provisions were set out in writing, and which the testator displayed to the witnesses, folded and tied up in the usual manner, declaring that they contained the record of his last will.

Gaius narrates the words spoken by the *familiae emptor* and addressed to the testator as follows: "Your estate and belongings (*familia pecuniaque tua*), be mine by purchase with this bit of copper and these copper scales, subject to your instructions, but in my keeping, that so you may lawfully make your testament according to the statute (*quo tu iure testamentum facere possis secundum legem publicam*)."⁵ The meaning of the words "in my keeping (*in tuo custodiam*)" is not quite obvious; they are probably remnants of an older style, but may be due to a clerical error of the writer of the Verona MS. Certain it is that they no more imported a real custody than a real property in the *familiae emptor*; for the testator remained so entirely master of his estate that for the very next day if he pleased he might mancipate it anew to a different purchaser, and nuncupate fresh testamentary writings. The nuncupation by the testator was in these terms: "As is written in these tablets so do I give, so do I legate, so do I declare my will; therefore, Quirites, grant me your testimony"; and, adds Gaius, "whatever the testator had set down in detail in his testamentary tablets, he was regarded as declaring and confirming by this general statement." To the appeal of the testator the witnesses responded by giving their testimony in words which unfortunately are not preserved; and then the testament was sealed by testator, officials and witnesses, the seals being outside according to the early fashion.⁶

Although this testament with the copper and the scales was justified in the first instance by the provision of the XII. Tables as to the effect of nuncupative words annexed to a mancipation, yet in course of time it came to be subordinated to that other one which dealt directly with testamentary dispositions: *uti legassit suae rei, ita jus esto*. Upon the words *uti legassit* the widest possible meaning was put by the interpreters: not only was a testator held entitled on the strength of them to appoint tutors to wife and children, to enfranchise slaves and make bequests to legatees, but he might

¹ Hypothecary rights were unknown until near the end of the Republic. But Festus (s. v. "Nancitor"; see Bruns, *Fontes*, 6th ed., iii. 16) speaks of a provision in the Cassian league between Rome and the Latin states of the year 262 u. c.—"Si quid pignoris nasciscitur, sibi habeto"—which may suggest that the Romans at this period were not altogether unacquainted with pledge or pawn of movables as a transaction of some value *de facto* if not *de jure*.

² See Girard, *Manuel de droit romain*, 4th ed. p. 800. On the "uti legassit" law of the XII. Tables see *ibid.* p. 782, and cf. Cug., *Institutiones Juridiques*, 2nd ed. pp. 124-125.

³ The *comitia*, Gaius tells us (l. ii. § 102), met only twice a year to sanction testaments. In Olmsen's view, *Röm. Chronologie* (1859), pp. 241 seq., these days were the 24th of March and the 24th of May.

⁴ Cic. *De Orat.* i. 57, § 245.

⁵ On the above passage of Gaius, see Sohm, *Inst.* § 99.

even disinherit a child in his *potestas* (*suius heres*) in favour of a stranger, so long as he did so in express terms. Institution of a stranger, without specific mention of the *suius heres*, however, was fatal, if the latter was a son; for without express disinheritance (*exhereditatio*) his father could not deprive him of the interest he had in the family property as in a manner one of its joint owners. It can hardly be supposed that disinheritance was contemplated by the compilers of the Tables; it was foreign to the traditional conception of the family and the family estate. But it was a right whose concession could not be resisted when claimed as embraced in the *uti legassit*, although generally discontingent, and as far as possible restrained by the strictness of the rules imposed on its exercise.

In the absence of a testament, or on its failure from any cause, the succession opened to the heirs *ab intestato*. So notoriously were the *sui heredes* entitled to the first place—and that not so much in the character of heirs as of persons now entering upon the active exercise of rights hitherto existing, though in a manner dormant—that the compilers of the XII. Tables thought it superfluous expressly to declare it. "If a man die intestate, leaving no *suius heres*, his nearest agnate shall have his estate. If the agnate also fail, his gentiles shall have it." It has been pointed out, in dealing with the tutory of agnates, that the notion of agnation, as a bond distinct from that which connected the gentile members of a clan, was due to the decemvirs. They had to devise a law of intestate tutory and succession suitable alike to the patricians who had *gentes* and to the plebeians who had none. To put the latter in exactly the same position as the former was beyond their power; for the fact had to be faced that the plebeians had no gentile institutions, and to create them was impossible. The difficulty was overcome by accepting the principle of agnation upon which the patrician *gens* was constructed, and establishing an agnatic circle of kinsmen (perhaps at first limited to the sixth degree) to which the *gens* as a collective body should be postponed in the case of the patricians, and which should come in place of it in the case of the plebeians. It was not perfect equalization, but the nearest approach to it that the circumstances permitted. The difference was that, when the agnates of a plebeian intestate failed, his inheritance was vacant; whereas, on failure of those of a patrician, there was evolution to his *gens* in its collective capacity. Two "interpretations" put upon the statute had an important bearing in this connexion, viz. (1) that, if the nearest agnates in existence declined the succession, those next in degree were not allowed to take it; and (2) that no female agnate could take it more remote than a sister of the deceased intestate. The division among two or more agnates was always *per capita*, not *per stirpes*.

The order of intestate succession thus established by the XII. Tables, which prevailed until amended by the praetors probably in the 8th century of the city, was first to the *sui heredes* of the deceased, next to his nearest agnate or agnates, and finally, if the deceased was a patrician, to his *gens*.¹ His *sui heredes*, speaking broadly, were those of his descendants in his *potestas* when he died who by that event (or even after it, but before his intestacy became manifest) became *sui juris*, together with his wife in *manu* (who, as regarded his succession, was reckoned as a daughter); but they did not include children whom he had emancipated or daughters who had passed in *manum* of a husband. Emancipated children did not even come in as agnates on failure of *sui*; for emancipation severed the tie of agnation as well as that of *potestas*. For the same reason no kinsman who had been emancipated, and so cut off from the family tree, could claim as an agnate; for those only were agnates who were subject to the same *patria potestas*, or would have been had the common family head been still alive.

The opening of a succession (technically *delatio hereditatis*) in favour of *sui heredes*, whether in virtue of a testamentary institution or by operation of law on intestacy, at once invested them with the character, rights and responsibilities of heirs. No acceptance was necessary, nor, according to the rules of the *ius civile*, was any declinatory competent. They

had been all along in a manner joint owners with their parent of the family estate, which by his death had become, nominally at least, an inheritance; and, as he had not thought fit to terminate their interest in it by emancipating or disinheriting them, they were not now allowed to disown it. Hence they were spoken of as necessary heirs (*heredes sui et necessarii*). A slave, too whom his owner had instituted in his testament with gift of liberty was a necessary heir; he could not decline, and was invested with the character of heir the moment the testator died. Not so with stranger institutes or agnates taking on intestacy; they were free to take or reject the inheritance as they saw fit; consequently, an act of acceptance (*aditio*) was necessary on their part to make them heirs.

This was a formal declaration before witnesses, which got the name of *cretio*.² It was not unusual for a testator, in instituting an heir, to require that he should make a formal declaration of acceptance within a limited time, failing which his right should pass to a substitute, who in turn was required to enter within a certain time; and so on with any number of substitutes, the series ending with one of his slaves, who became heir without entry, and thus saved the testator from the disgrace of *post mortem* bankruptcy in the event of the inheritance proving insolvent. The *sui legassit* of the Tables, as interpreted by the pontiffs, conferred upon a testator very great latitude of testamentary disposition, even to the extent of disinheritance of *sui heredes*. This was a course, however, that was probably rarely resorted to unless when a child had been guilty of gross ingratitude, or when the parent had reason to believe his estate was insolvent and desired to protect his children from responsibility of inheritance. Usually his *sui*, if he had any, would be his institutes, and the purpose of the testament either to apportion the estate amongst them as he thought expedient, or to give him an opportunity of appointing tutors, bequeathing legacies, or enfranchising slaves. On intestacy the *sui* took equally, but *per stirpes*; that is to say, grandchildren by a son who had predeceased or been emancipated, but who themselves had been retained in their grandfather's *potestas*, took amongst them the share to which their father would otherwise have been entitled, instead of taking equal shares with their surviving uncles. It was by no means unusual, when the whole inheritance descended to sons, and so on to hold in common for many generations, the *consortium*; but any one of them was entitled at any moment to claim a partition which was effected judicially, by an arbitral procedure introduced by the XII. Tables, termed a *judicium* (or *arbitrium*) *familiae eriscundae*. Where two or more strangers were instituted testamentarily, whether to equal or unequal shares, if one of them failed either by predecease or declinatory his share accrued *ipso jure* to the others; for it was a rule that early became proverbial that a man could not die partly testate and partly intestate. There was the same accrual among agnates on intestacy; and so the heir and stranger or testamentary institutes had the same action for division of the inheritance that was made use of by *sui heredes*.

According to Gaius it was as a stimulus to heirs to enter as soon as possible to an inheritance that had opened to them, and thus make early provision alike for satisfying the claims of creditors of the deceased and attending to his family *sacra*, that the law came to recognize the somewhat remarkable institution of usucapion or prescriptive acquisition of the inheritance in the character of heir (*usucapio pro herede*). Such usucapion was impossible where there was no room for it if the deceased had been testate, for the inheritance vested in them the moment he died. But, if there were no *sui heredes*, then any person taking possession of the property that had belonged to the deceased, and holding it for twelve months without interruption, thereby acquired it as if he were heir; in fact, according to the views then held, he acquired the inheritance itself. Gaius characterizes it as a dishonest acquisition, inasmuch as the usucapient knew that what he had taken possession of was not his. But, as already explained, the usucapion of the XII. Tables did not require *bona fides* on the part of the usucapient; he might acquire ownership by prolonged possession of what he knew did not belong to him so long as he did not appropriate it theftuously, i.e. knowing that it belonged to another. But an inheritance unappropriated by an heir who had nothing more than a right to claim it belonged in strictness to no one; and there was no theft, therefore, when a person took possession of it with a view to usucapion in the character of heir. There can be little doubt that on the completion of his possession he was regarded as heir just as fully as if he had taken under a testament or as heir-at-law on intestacy—that is to say, that he was held responsible to creditors of the deceased and required to charge himself with the family *sacra*. Gaius does not say so; but so it was in the *Ulpianian* and the *Mucian* edict³ imposed the latter burden upon him who had usucapied by possession the greater part of a deceased person's estate; and it is but reasonable to suppose that the burden of debts must in like manner have fallen on the usucapient or usucapient in proportion to the shares they had taken of the deceased's property.

Usucapio
pro
herede.

¹ This was for freeborn citizens; for freedmen, the patron (or his children in *potestate*) took the place of the nearest agnates.

² Gai. ii. 164-173.

³ Cic. de leg. ii. 48, 49.

The Law of Obligations.—In his *Liber Aureorum* Gaius says obligations arise from either contract or delict, or miscellaneous causes (*variae causarum figuree*). But those arising from contract fill a place in the later jurisprudence vastly greater than those arising from delict. In the XII. Tables it was different. In them delicts were much more prominent than contracts—wrongs entitling the sufferer to demand the imposition of penalties upon the wrong-doer that in most cases covered both reparation and punishment. The disproportion in the formulated provisions in reference to the two sources of obligation, however, is not surprising. For, first of all, the purpose of the decemviral code was to remove uncertainties and leave as little as possible to the arbitrariness of the magistrates. In nothing was there more scope for this than in the imposition of penalties; and, as different offences required to be differently treated, the provisions in reference to them were necessarily multiplied. In the next place, the intercourse that evokes contract was as yet very limited. Agriculture was the occupation of the great majority; of trade and commerce there was little; coined money had hardly begun to be used as a circulating medium. Lastly, the safeguards of engagement then lay to a great extent in the sworn oath or the pledged faith, of which the law (*jus*) hardly yet took cognisance, but which found a protection quite as potent in the religious and moral sentiments that had so firm a hold on the people.

It may be asked—If a man purchased sheep or store cattle, a plough, a toga, a jar of wine or oil, had he no action to compel delivery, the vendor no action for payment of the price? Did the hire of a horse or the loan of a bullock create no obligation? Was partnership unknown, and deposit, and pledge, and suretyship in any other form than that of *vadimonium*? One can have no hesitation in answering that, as transactions of daily life, they must all have been more or less familiar. It does not follow, however, that they were already regulated by law and protected by the ordinary tribunals. Modern historical jurists are pretty well agreed that not only the real contracts of loan (*mutuum* and *commodatum*), deposit, and pledge, but also the consensual ones of sale, location, partnership, and mandate, and the verbal one of suretyship, were as yet barely recognized by law. The law recognized conveyance but hardly contract. Sale was the offspring of barter—of instant exchange of one thing for another. With such instant exchange there was no room for obligation to deliver on either side. The substitution of coined money for the raw metal can hardly have effected any radical change; the ordinary practice of those early times must still have been ready-money transaction—an instant exchange of ware for price; and it can only have been when, for some reason or other, the arrangement was exceptionally for delivery or payment at a future date, say next market day, that obligation was held to have been created. Was that obligation enforceable by the civil tribunals?

Some jurists hold that it was—that at no time were the *jus gentium* contracts outside the protection of judicial remedies, although by a simpler procedure than that resorted to for enforcement of the contracts of the *jus civile*. But two provisions in the XII. Tables seem to prove that it was not so enforceable when they were drawn up. The first is that already referred to as recorded by Justinian—that, where a thing was sold and delivered, the property, nevertheless, was not to pass until the price had been paid or sureties (*vades*) for it accepted by the vendor. Far from being a recognition of the obligatory nature of the transaction, this provision is really a recognition of the inability of the law to enforce payment of the price by the vendor; it is a declaration that, on the latter's failure to pay, the vendor, unprotected by any personal action, should be entitled to get back the thing sold as still his own, no matter in whose hands he found it. The second related to the case of a person who had bought a victim for sacrifice, but had failed to pay for it. A real action for its revindication by the seller after it had been consumed on the altar was out of the question; so he was authorized by the Tables, by the process of *pignoris capio*, to his own hand to appropriate in satisfaction a sufficient equivalent out of the belongings of the purchaser, against whom he had no personal action.

It was a principle of the law of Rome through the whole of its history, though in course of time subject to an increasing number of exceptions, that mere agreement between two persons did not give him in whose favour it was conceived a right to demand its enforcement. To entitle a man to claim the intervention of the civil tribunals to compel implement of an engagement undertaken by another, it was necessary (subject to those exceptions)

either that it should be clothed in some form prescribed or recognized by the law, or that it should be accompanied or followed by some relative act which rendered it something more than a mere interchange of consent. Under the jurisprudence of the XII. Tables the formalities required to elevate an agreement to the rank of contract and make it civilly obligatory sometimes combined ceremonial act and words of style, sometimes did not go beyond words of style, but in all cases took place before witnesses. *Dotis dictio*, the undertaking of a parent to provide a dowry with his daughter whom he was giving in marriage, and *vadimonium*, the guarantee of a surety for the due fulfilment of the undertaking either of a party to a contract or a party to a litigation (some think only the latter), probably required nothing more than words of style before persons who could if necessary bear witness to them; whereas an engagement incident to a mancipation, or an undertaking to repay borrowed money, required in addition a ceremony with the copper and the scales. This undertaking to repay arose from the contract of *nexum*, which was, it is thought, older than the Tables; both it and the verbal contract by *spōsio* or stipulation, which was younger, require here further consideration.

The Nexal Contract.—The tumults and seditious so frequent in Rome during the first two centuries of the Republic are as frequently attributed by ancient writers to the abuses of the law of debt as to any other cause, social or political. The circumstances of the poorer plebeians were such as to make it almost impossible to avoid borrowing. Their scanty means were dependent on the regular cultivation of their little acres, and on each operation of the agricultural year being performed in proper rotation and at the proper season. But this was every-now and again interfered with by wars which detained them from home at seed-time or harvest, practically rendering their farms unproductive, and leaving them and their families in straits for the commonest necessities of life.

The practice of lending *per libram* was doubtless of great antiquity—indeed, the intervention of the scales was a necessity when money or what passed for it had to be weighed instead of counted; and not improbably old custom conceded to a lender who had thus made an advance in the presence of witnesses some very summary and stringent remedy against a borrower who failed in repayment. How, after the Servian reforms, it was subjected to much the same formalities as were required for mancipation has been shown already. With the introduction of a coinage the transaction, instead of being *per libram* simply, became one *per aes et libram*; the scales were touched with a single piece, representing the money which had already been or was about to be paid, a formula recited whereby the obligation of repayment was imposed on the borrower, and an appeal made to the witnesses for their testimony. Unfortunately this formula is nowhere preserved. Huschke assuming that the lender was the only speaker, formulates it thus—“quod ego tibi mille libras hoc aere aeneaque libra nexas dedi, eas tu mihi post annum jure nexi dare damnas esto”—“whereas with this coin and these copper scales I have given thee a thousand asses, be thou therefore bound *jure nexi* to repay them to me a year hence.” The phrase *damnas esto*, like the rest of the formula, is unsupported by any conclusive authority;

¹The modern literature on the subject of *nexum* is very large and the views taken of it are discordant. The fundamental work is that of Huschke, *Über d. Recht des Nexum* (Leipzig, 1846). Danz (*Gesch. d. rom. Rechts*, II, 2nd ed., 1873, § 146) gives a list of the more important writings about it and a résumé of the principal theories. To this list, which comes down to 1870, may be added Bekker, *Die Aktionen des röm. Privatrechts*, I. (Berlin, 1871), c. 1; Brinz, “Der Begriff obligatio” in *Grünhuts Zeitschr.* i. (1874), 11 seq.; and Voigt, *XII. Tafeln*, i. §§ 63-65; Girard, *Manuel*, 4th ed. pp. 476-482; Schlossmann, *Nexum* (1904); Mittels, “Über das Nexum,” *Zisch. d. Sav. Stift.* xxi. 96 seq., and xxv. 282-283; Mommsen, *Zisch. d. Sav. Stift.* xxiii. 348 seq.; Lenei, *Z. d. S.* xxiii. 84 seq.; Bekker, *Z. d. S.* xxiii. 11-23 and 429-430; Kübler, *Z. d. S.* xxv. 254 seq.; Senn, *Nouv. Rev. hist.* (1905), pp. 49 seq.

Causes of plebeian borrowing.

Nexal contract.

but, as it is in harmony with the formula which is given by Gaius for dissolving an obligation of this kind, and with that most frequently employed in the Republic for imposing by a public act liability to pay a fixed and definite sum, it may not be wide of the mark.

What was the effect of this procedure? The question is one not easily answered. Brinz expressed the opinion that the creditor was entitled in virtue of the *nexum* to take his debtor into custody at any time when he considered such a course necessary for his own protection, even before the conventional term of repayment—that the debtor was in bonds, virtually a pledge, from the very first, and the tightness or looseness of them a matter in the discretion of his creditor.¹ Voigt holds that the *nexum* did not give the creditor any peculiar hold over his debtor, and that on the latter's failure to repay an ordinary action was necessary, to be followed by the usual proceedings in execution if judgment was in favour of the former. These views may be said to be the two extremes; and between them lie a good many others, more or less divergent. The difficulty of arriving at a conclusion is caused to some extent by the ambiguity of the words *nexus* and *nexum*. The transaction itself was called *nexum* and occasionally also *nexus*; the money advanced was *nexum aēs* (hence *nexi*, *s. e. aeris, datio*); the bond was *nexus* (of the fourth declension); and the debtor on whom the bond was laid was also *nexus* (of the second). All this is simple enough. But we find the same word *nexum* employed by the historians as almost synonymous with *vinculus*—to denote the condition of debtor put in fetters by his creditor. That might be the condition either of a nexal borrower or of an ordinary judgment-debtor. The former in such a case was doubly *nexus*; he was at once in the bonds of legal obligation and in those of physical constraint. In many passages in which Livy and others speak of the *nexi* it is extremely difficult, sometimes impossible, to be sure in which sense they use the word. It is therefore not surprising that there should be considerable diversity of opinion on the subject.²

Since Huschke, the great majority of writers—Voigt,³ Lenel and Mitteis are distinguished exceptions—concur in opinion that the nexal contract entitled the creditor, after expiry of thirty days from the conventional date of repayment of the loan, to proceed against his debtor by *manus injectio* without any antecedent action or judgment, and failing settlement to detain him, and put him to servile labour, and subject him to servile treatment, until the loan was repaid. The parallel of such a course is to be met with amongst many ancient nations—Jews, Greeks, Scandinavians, Germans, &c.⁴ And it was not altogether unreasonable. If a borrower had already exhausted all available means of raising money, had sold or mortgaged everything he possessed of any value, what other course was open to him in his necessity except to impledge himself? That the creditor should have been entitled to realize the right he had thus acquired without the judgment on a day of court of law is equally intelligible. It was just a case of regulated self-help. The nexal contract was a public act, carried out in the presence of the five citizen witnesses and *libripens*, who were witnesses alike of the acknowledgment of indebtedness and of the tacit engagement of the debtor. The only valid objection apparently that could be stated against the creditor's apprehension of his debtor in execution was that the indebtedness no longer existed—that the loan had been repaid. But a nexal debt

could be legally discharged only by *nexi liberatio*, which also was a solemn procedure *per aes et libram* in the presence of five citizen witnesses. What need for a judicial inquiry in the presence of facts so notorious? A creditor would rarely be daring enough to proceed to *manus injectio* if his loan had been repaid; if he did, the testimony of the witnesses to the discharge would at once procure the release of his alleged debtor. It was probably to give opportunity for such proof, if there was room for it, that the XII. Tables required that a creditor who had apprehended a nexal debtor should bring him into court before carrying him off into detention.

Whether there was room for a *manus* and for a magisterial addition of the debtor after sixty days, with power to kill or sell into slavery after addition, are disputed questions, but there seems no good reason for distinguishing a nexal from a *judicialis* debtor in these respects. Untenable is the notion at any rate that the *nexus* by the mere contract was placed in *loco servi*, or that by arrest he was in a worse position than one condemned for a judgment debt, of whom Quintilian states distinctly that he still retained his position in the census and in his tribe. Many a time when the exigencies of the state required it, were the *nexi* temporarily released in order to obey a call to arms—to fulfil the duty incumbent on them as citizens. The nexal debtor's position after arrest by regard to his family rights is obscure. If originally they shared his nexal condition, this did not long continue to be the law. If he was a house-father he seemingly still retained his *manus* over his wife and *potestas* over his children. Their earnings legally belonged to him, and did not fall to his creditor. It was the body of his debtor that the creditor was entitled to, and too often he wreaked his vengeance on it by way of punishment; there was as yet no machinery for attaching the debtor's goods in substantial reparation for the loss caused by his breach of contract.

The abuses to which this system of personal execution gave rise were great. Livy tells us that in the year 428 B.C. (326 B.C.) a more than ordinarily flagrant outrage committed by a *Poetillan* creditor upon one of his young *nexi*, who had given himself up as responsible for a loan contracted by his deceased father, roused the populace to such a pitch of indignation as to necessitate instant remedial legislation. The result was the *Poetillan law* (*Lex Poetillia Papiria*). So far as can be gathered from the meagre accounts of it we possess, it contained at least these three provisions—(1) that fetters and neck, arm or foot blocks should in future be applied only to persons undergoing imprisonment for crime or delict; (2) that no one should ever again be the *nexus* of his creditor in respect of borrowed money; and (3) that all existing *nexi* should be released. The first was intended to prevent unnecessary restraint upon judgment debtors formally given over to their creditors. The second did not necessarily abolish the contract of *loan per aes et libram*, but only what had hitherto been an *ipso jure* consequence of it—the creditor's right to incarcerate his debtor without either the judgment of a court or the warrant of a magistrate. For the future, execution was to be done against a borrower only as a judgment-debtor formally made over to his creditor by magisterial decree, and under the restrictions and limitations imposed by the *Poetillan law* itself. This very soon led to the disuse of nexal obligation; once it was deprived of its distinctive processual advantages it rapidly gave place to the simpler engagement by stipulation usually enforceable *per conditionem*. As for the release of the then existing *nexi*, Cicero, Livy and Dionysius say nothing of any condition annexed to the boon the statute conferred upon them; but Varro limits it to those *qui bonam copiam jurarunt*—those apparently who were able to declare on oath that they had done their best and could do no more to meet their creditors' claims.⁵ Such a limitation can hardly be called unreasonable, even were we to assume—as probably we ought to do—that the release spoken of was only from the bonds of physical restraint, not from those of legal obligation.

*Introduction of the Stipulation.*⁶—Few events in the history of the private law were followed by more far-reaching consequences than the introduction of the stipulation. It exercised an enormous influence on the law of contract; by means of it there was created a unilateral obligation that in time became adaptable to almost every conceivable undertaking by one man in favour of another. By the use of certain words of style in the form of question and answer any lawful agreement could thereby be made not only

Stipulation.

¹ The meaning of these words, however, is disputed. See Greenidge, *Infamia*, 206, and authorities there cited.

² Literature: Gneist, *Die formellen Verträge d. röm. Rechts* (Berlin, 1845), pp. 113 seq.; Heimbach, *Die Lehre vom Creditum* (Leipzig, 1849); Danz, *Der sacrale Schutz im röm. Rechtsverkehr* (Jena, 1857), pp. 102–142, 236 seq.; Schlesinger, *Zur Lehre von den Formalcontracten* (Leipzig, 1858), § 2; Voigt, *Jus. nat. &c.*, d. *Röm. vol. II.* § 33, vol. IV. Beilage XIX.; Bekker, *Aktionen*, I. 385–401; Krutten, *Die Stipulation* (Kostock, 1878); Voigt, *Röm. Rechtsgeschichte*, II. 7; Girard, *Manuel*, 483 seq.; Karlowa, *Röm. Rechtsgeschichte*, II. 699 seq.

¹ Brinz, in Grünhut's *Zeitschr.* i. 22. He likens the position of the *nexus* to that of a thing—land, say—mortgaged to a creditor in order of payment. See also security of the *Kontrahent*, can be constantly speak of as *res obligata*, and sometimes as *res iusta*. As Brinz observes, the thing was *obligata* from the first, and continued so as long as the debt it secured was unpaid, even though the creditor found it unnecessary to reduce it into possession or interfere with it in any way.

² As to the use of the terms *nexum* and *nexus* by the classical jurists, see Roby, *Roman Private Law* (1902), vol. II. pp. 296 seq.

³ He holds that the obligation created *nexo* did not impose any immediate liability on the borrower which the lender could enforce without judicial intervention, but that the latter required to proceed against the former in ordinary course, by what he calls an *actio pecuniae nunciata*. Mitteis, *Ulp. supra*, supports, to a considerable extent, Voigt's views as to the necessity of further proceedings after the nexal contract, and rejects the notion of non-judicial *manus injectio*, but regards the *actio pecuniae nunciata* as nonexistent. Cf. Mitteis, *Röm. Privatrecht* (1908), p. 137 seq. According to Lenel, *Z. d. Sar. Stift.* 84 seq., there never existed any nexal contract of loan, and the whole doctrine on the subject has therefore no solid foundation.

⁴ See authorities in Brinz's paper in Grünhut's *Zeitschr.* i. 25. The Greek phrase was *ἐνὶ ὄψει βαρέως*. There is a curious style in Marcellus (*Form. II.* 27), in which a borrower engages that, until he shall have repaid his loan, his creditor shall have right to his services so many days a week, and shall have power to inflict corporal punishment if there be dilatoriness in rendering them.

morally but legally binding, so that much which previously had no other guarantee than a man's sense of honour now passed directly under the protection of the tribunals. Stipulations became the complement of engagements which without them rested simply on good faith, as when a vendor gave his stipulatory promise to his vendee to guarantee peaceable possession of the thing sold or its freedom from faults, and the vendee in turn gave his promise for payment of the price. The question and answer in the form prescribed by law made the engagement fast and sure. Hence the generic name of the contract; for Paul's derivation of it from *stipulum*, "firm" (which itself comes from *stipes*, a staff), is to be preferred to that of Varro and Festus from *stips* (money), or to a later and rather fanciful one from *stipula* (a straw). It was round the stipulation that the jurists grouped most of their disquisitions upon the general doctrines of the law of contract—capacity of parties, requisites of consent, consequences of fraud, error and intimidation, effects of conditions and specifications of time, and so forth. It may well be said, therefore, that its introduction marked an epoch in the history of the law.

There is, however, no certainty either as to the time or as to the manner of its introduction. So far as appears, it was unknown at the time of the enactment of the XII Tables, at least in private life; one of the first unmistakable allusions to it is in the Aelian law of about 287 B.C. The mention of it in that enactment, however, is with regard to a phase of it which cannot have been reached for many years after it had come into use; and the probability is that it originated before the middle of the 5th century of the city, its first statutory recognition being in the Silian law introducing the *legis actio per conditionem* (infra, p. 550). In its earliest days it bore the name not of *stipulatio* but of *sponsio*, for the reason that the interrogatory of the party becoming creditor was invariably formulated with the word *spondeo*—e.g. *centum dare spondeo?*—while the answer was simply *spondeo*.

There has been much speculation as to the origin of the contract. Modern criticism has three theories: (1) that it was the verbal remnant of the *nexum*, after the business with the copper and the scales had gone into disuse; (2) that it was evolved out of the oath (*fides iurandum* or *sponsio*) at the great altar of Hercules and its appeal to *Jupiter* (supra, p. 534); (3) that it was imported from Latium, which it had reached from some of the Greek settlements farther south. The last view is the most probable, though there is much to be said also in favour of the second theory.¹ Verrius Flaccus, as quoted by Festus, connects it with the Greek *σπονδή* and *σπονδή*; and Gaius incidentally observes that it was said to be of Greek origin. A libation (*σπονδή*) is frequently referred to by Homer and Herodotus as an accompaniment of treaties and other solemn covenants—a common offering by the parties to the gods which imparted sanctity to the transaction. Leitz² is of opinion that the practice passed into Sicily and Lower Italy, but that gradually the libation and other religious features were dropped, although the word *σπονδή* was retained in the sense of an engagement that bound parties just as if the old ritual had been observed, and that it travelled northward into Latium and thence to Rome under the name of *sponsio*, being used in the first instance in public life for the conclusion of treaties, and afterwards in private life for the conclusion of contracts. The meaning of *spondeo* as a question by a creditor to his debtor (although latterly, we may well believe, unknown to them) thus came to be "Do you engage as solemnly as if the old ceremonial were gone through between us?" There are many examples of such simplification of terms, none more familiar than when a man says, "I give you my oath upon it," without either himself or the individual addressed thinking it necessary that the form should be gone through.

It is not a little remarkable that the use of the words *spondeo* and *spondeo* in contracting were, down at least to the time of

Gaius, confined in Rome to Roman citizens. The *stipulatio* as a form of contract was essentially *juris civilis*. So at first were the later and less solemn forms of stipulation—*promissio*?, *promitto*, *fideipromissio*?, *fideipromitto*. Gaius speaks of these latter, along with such simple forms as *dabine*?, *dabo faciesne*?, *faciam*, as *juris gentium*, i.e. binding even between Romans and peregrins. Such they became eventually, but peregrins probably could not make use of the stipulation until a good while after the *lex Silia*. Yet although *juris civilis*, both the *sponsio* and the later forms were

¹ See the arguments in favour of this theory in Girard, *Manuel*, 4th ed. pp. 484 sqq.

² *Græco-Italische Rechtsgeschichte* (Jena, 1884), pp. 465-70. Upon the *ponsionis vinculum* internationally, see Livy, ix. 9.

from the first free from many of the impediments of the earlier *actus legitimi*. No witnesses were required to assist at them; and they were always susceptible of qualification by conditions and terms. It was long, however, before parties had much latitude in their choice of language; *spondeo* was so peculiarly solemn that no equivalent could be admitted; and even the later styles may be said to have remained stereotyped until well on in the Empire. And it was the use of the words of style that made the contract. It was formal, not material; that is to say, action lay upon the promise the words embodied, apart from any consideration whether or not value had been given for it. In time this serious disadvantage was abated by praetorian exceptions and otherwise, as will be noted below. Originally the stipulation was employed only in regard to engagements whose terms were in every respect definite and certain, and was enforced by the *legis actio per conditionem*, or sometimes possibly by *actio sacramento in personam*. But in time it came to be employed in engagements that were from the first indefinite. This seems to have been due to the intervention of the praetors, and to have received special impetus after the system of the *legis actiones* had begun to give place to that *per formulas*. The remedy in such a case was not spoken of as a *conditio* but as an *actio ex stipulata*.

iv. The *Actioes* of the Law.

The *Legis Actiones* generally.³—We owe to Gaius the only connected (though, owing to the state of the Verona MS., rather fragmentary) account we possess of the *legis actiones*, as the system of judicial procedure was called which prevailed in Rome down to the substitution of that *per formulas* by the Aebutian and Julian laws—the first either in the 6th or early in the 7th century of the city, and the second in the age of Augustus. He tells us that as *genera agendi* or generic forms of process they were five in number, each taking its name from its characteristic feature, viz. (1) *sacramento*, (2) *per judicis postulacionem*, (3) *per conditionem*, (4) *per manus injectionem*, and (5) *per pignoris capionem*. The third was unknown in the decemviral period, and was introduced by the Silian law formerly mentioned. The other four were all more or less regulated by the XII Tables, but must in some form have been anterior to them. It is utterly impossible, however, to say of any one of them, apart from the *condictio*, at what time it was introduced, or what was the statute (*lex*) by which it was sanctioned; it may well be that they were not of statutory introduction at all, but were called *legis actiones* simply because recognized and indirectly confirmed by the Tables. In character and purpose each of the five had its peculiarities. The first three were directly employed for determining a question of right or liability, which, if persistently disputed, inevitably resulted in a judicial inquiry. The fourth and fifth might possibly result in judicial intervention; but primarily they were proceedings in execution, in which the party moving in them worked out his own remedy. As regards their comparative antiquity, there is much to be said for the opinion of Jhering and Bekker that *manus injectio*, as essentially nothing more than regulated self-help, must have been the earliest of the five, and that the *legis actio sacramento* and the *judicis postulatio* must have been introduced in aid of it, and to prevent too hasty resort to it where there was room for doubt upon questions either of fact or law.

³ The literature on the subject is very voluminous, great part of it in periodicals. Amongst the leading works are those of Keller, *Der röm. Civilprozess u. die Actiōnes* (6th ed. by Wach, Leipzig, 1883), §§ 12-21; Bethmann-Hollweg, *Der röm. Civilprozess* (3 vols. Bonn, 1864-1866), the first volume of which is devoted to the *legis actiones*; Bonamici, *Delle Legis Actiones nell' antico diritto romano* (Pisa, 1868); Bekker, *Die Actiōnes d. röm. Privatrechts* (2 vols., Berlin, 1871-1873), particularly vol. i. (pp. 18-74; Karlowa, *Der röm. Civilprozess zur Zeit d. Legislationen* (Berlin, 1872); Padeletti, "Le Legis Actiones," in the *Archivio Giuridico* (1875), xviii, 321 sqq.; Schultze, *Privatrecht u. Prozess in ihrer Wechselbeziehung* (Freiburg, 1883), i. 439-532, in which some novel and not unimportant views are presented; Jobbé-Duval, *Études sur l'histoire de la procédure civile chez les Romains* (1896), vol. i.; Girard, *Organisation judiciaire*, i. 15-20, 56-104, 167-252.

In the three judicial *legis actiones* the first step was the *in jus vocatio* or procedure for bringing the respondent into court, minutely regulated by the provisions of the first of the XII. Tables. This was not done by any officers of the law; there was no writ of summons of any sort; the party moving in the contemplated litigation had himself to do what was needed. If the defendant did not appear there could be no trial. One of the two magistrates (the *magistratus* or praetor), the plaintiff stated his contention. If admitted or not disputed by the defendant, the magistrate at once pronounced his decree, leaving the plaintiff to work out his remedy as the law prescribed. But, if the case presented was met either with a denial or counterclaim, the magistrate remitted it for trial either to a collegiate tribunal or to one or more private citizens as judges or arbiters. The act of remit was technically *litis contestatio* or *ordinatio iudicii*, the first so named because originally the parties called upon those witnesses to the issue that was being sent for trial. This was the ordinary practice under both the system of the *legis actiones* and that of the *formulae*, and continued to exist until the time of Diocletian. In the first stage the proceedings were said to be *in iure*, and the duties of the magistrate in reference to them were part of his *iurisdictio*; in the second they were said to be *in iudicio*, those presiding in it being styled *iudices*. All that the judge or judges had to do was to pass judgment on the question remitted to them. They were "right-declarers" only, not "right-enforcers." If their judgment was for the plaintiff, and he failed to obtain an amicable settlement, he had himself to make it operative by subsequent proceedings by *manus injectio*, and that under the eye of the magistrate, not of the judge.

From an enumeration in Cicero of a variety of causes proper to the centumviral court the conclusion seems warranted that it was its peculiar province to decide questions of quiritary right in the strictest acceptance of the word. They were all apparently in his time real actions (*vindicationes*)—claims of property in land or of servitudes over it, of right as heir under a testament or in opposition to it, of rights of tutory and succession *in intestato* as agnate or gentile, and so forth. It was a numerous court of Quirites, determining by its vote the question of quiritary right submitted to it. Many such questions in course of time, and possibly at first of express consent of parties, came to be referred to a single judge; but some, and notably claims of inheritance under or in opposition to a testament, were still frequently remitted to the centumviral court even in the classical period. Personal actions, however, do not appear ever to have fallen within its cognizance; they were usually sent to a single judge—selected by the parties, or appointed by the magistrate, and to whom the latter administered an oath of office. But, in a few cases in which an action involved not so much a disputed question of right as the exercise of skill and discretion in determining the nature and extent of a right that in the abstract was not denied, the remit was to a plurality of private judges or arbiters, usually three.

*The Legis Actio Sacramento.*¹—The characteristic feature of this *legis actio*, as described by Gaius, was that the parties, after a somewhat dramatic performance before the magistrate, each challenged the other to stake a certain sum, the amount of which was fixed by the Tables, and which was to abide the issue of the inquiry by the court or judge to whom the cause was eventually remitted. This stake Gaius refers to indifferently as *sacramentum*, *summa sacramenti*, and *poena sacramenti*. The formal question the court had to determine was—whose stake had been justified, whose not (*cujus sacramentum iustum, cuius iniustum*); the first was returned to the staker, the second forfeited originally to sacred and afterwards to public uses. But the decision on this formal question necessarily involved a judgment on the matter actually in dispute, and if it was for the plaintiff, entitled him, failing an amicable arrangement, to take ulterior steps for making it effectual. The procedure was still employed in the

time of Gaius in the few cases that continued to be referred to the centumviral court, but otherwise it had been long in disuse.

Gaius explains that it was resorted to both in real and personal actions. Unfortunately the MS. of his Institutes is defective in the passage in which he described its application to the latter. We possess the greater part of his account of the *actio in rem* as employed to raise and determine a question of ownership; but his illustration is of vindication of a slave, and not so interesting or instructive as the proceedings for vindication of land. These, however, can be reconstructed with tolerable certainty with the aid derived from other sources, especially from Cicero, Varro and Gellius.

The parties appeared before the magistrate, each carrying a rod (*festuca*) representing his spear (*quir* or *hasta*), the symbol, as Gaius says, of quiritarian ownership. The first word was spoken by the raiser of the action, and addressed to his opponent: "I say that the land in question [describing it sufficiently for identification] mine is, and that the right [meaning *ius quiritarium*]; therefore I require you to go there and join issue with me in presence of the magistrate (*in iure manum conserere*)." Thereupon, according to the earliest practice, the magistrate and the parties, accompanied by their friends and backers, proceeded to the ground for the purpose: the court was transferred from the forum to the land itself. As distances increased, however, and the engagements of the consuls multiplied, this became inconvenient. Instead of it, the parties went to the spot without the magistrate; but on his command, and there joined issue in the presence of their countrymen who had been ordered to accompany them, and who probably made a report of the due observance of formalities on their return. Still later the procedure was further simplified by having a turf or sod brought from the place beforehand, and deposited a few yards from the magistrate's chair; and, when he ordered the parties to go to the ground and join issue, they merely brought forward the turf and set it before him, and proceeded to make their formal vindications upon it, as representing the whole land in dispute.

The ritual was as follows: The raiser of the action, addressing his adversary, again confirmed his ownership, but this time with the significant addition: "As I have asserted my right by word of mouth, look you, so do I now with my *vindicta*"; and therewith he touched the turf with his rod, which was called *vindicta* when employed for this purpose. The magistrate then asked the other party whether he meant to counter-vindicate. If he replied in the negative or made no response, there was instant decree (*addictio*) in favour of the first party, and the proceedings were at an end. If he answered in the affirmative, it was by repeating the same words and going through the same form as his adversary: "I say that the land is mine in quiritary right, and I too lay my *vindicta* upon it." The verbal and symbolical vindication and counter-vindication completed what was technically the *manus conserio*. The parties were now in this position: each had asserted his ownership, and had figuratively had recourse to arms in maintenance of his contention. But the matter was to be settled judicially, so the magistrate once more intervened and ordered each to draw away from the land. The catalogue was then resumed, the vindicator demanding to know from his opponent upon what pretence (*causa*) he had counter-vindicated. In the illustration in Gaius he avoided the question and pleaded the general issue: "I have done as is my right in laying my *vindicta* on the land." But there can be little doubt that in certain circumstances the counter-vindicator would deem it expedient to disclose his title. This was very necessary where he attributed his right to a conveyance upon a case to two years' possession had not yet followed; in such a case he had to name his author (*autorem iudicare*) if he desired to preserve recourse against the latter on the warranty implied in the mancipation. That probably entailed a suspension of the proceedings to allow of the author's citation for his interest; and on their resumption, if he appeared and admitted his *auctoritas*, he was formally made a party to the action.

The proceedings had now reached the stage at which the sacrament came into play. The first challenge came from the vindicator,—"Since you have vindicated unrightfully, I challenge you with a sacrament of 500 asses," to which the counter-vindicator responded, "And I you." This was technically the *sacramentum proscissio*. The magistrate thereupon remitted the matter for trial to the centumviral court, or to a single judge, having declared what exactly was the question put in issue which the court or judge was to decide. The parties then called upon the bystanders to be witnesses of the magistrate's remit, this appeal to witnesses being, as is generally held, the *litis contestatio*.² At the same time, according to Gaius's account of the procedure, the magistrate required sureties from the parties for the eventual payment by him who was unsuccessful of the sacrament he had offered to

¹ To the literature in the last note may be added Asverus, *Die legis actio sacramenti* (Leipzig, 1837); Huschke (rev. Asverus), in Richter's *Krit. Jahrbuch*, vol. iii. (1839), pp. 665 sqq.; Stintzing, *Verhältniss d. l. a. sacramentum zum Verfahren durch sponso proiudicialis* (Heidelberg, 1853); Danz, *Die sponso proiudicialis*—selected; Danz, *Die l. a. Sacram. u. d. Lex Papiria*, in the *Zeitschr. f. Rechtsgeschichte*, vol. i. (1867), pp. 339 sqq.; Huschke, *Die Multa u. d. Sacramentum* (Leipzig, 1874); Lotmar, *Zur l. a. sacramentum in rem* (Munich, 1876); Brinz (crit. Lotmar), "Zur Controvindicatio in d. l. a. sac.", in the *Festgabe zu Spengel's Doctor-Jubiläum* (Munich, 1877), pp. 95-146; Münderloh, "Ueber Schein u. Wirklichkeit an d. l. a. sacramenti," in the *Z. f. Rechtsgesch.*, vol. xiii. (1878), pp. 445 sqq.; E. Roth, in the *Z. d. Savigny-Stiftung*, vol. iii. (1882), *Röm. Abth.* pp. 121 sqq.; Fioretti, *Leg. act. sacramentum* (Naples, 1883); Jhering, *Die l. a. Rem u. Arn* in *Abtr. u. Proz.*, in the *Zeitschr. f. Rechtsgesch.*, *Erst in der Jurisprudenz* (Leipzig, 1885), pp. 175 sqq.; Schulin, *Lehrbuch*, pp. 525 sqq.; Pfäuger, *Die legis actio sacramentum* (Leipzig, 1898).

² But see Colassak, *Die Litis contestation* (1889), pp. 69 sqq., for a different view.

stake, and which became a forfeit to the exchequer. (The original practice probably was for the stake to be deposited by both parties in the hands of the pontiffs before they were heard by the judge or judges; after judgment that of the gainer was restored to him, while that of the loser was retained for religious uses.) The magistrate also made arrangements for the interim possession of the land by one or other of the litigants (but preferably, it is thought, by the possessor, taking security from him), but, if eventually unsuccessful, should be returned to his opponent, along with all the fruits and profits drawn in the interval. At the trial, as both parties were vindictors, there must have been a certain burden of proof upon both sides. The vindicator, one may believe, must have been required to establish in the first instance that the thing he claimed had at some time been his; and then, but probably not till then, the counter-vindicator would have to prove a later title in his person sufficient to exclude that of his opponent. The judgment, as already observed, necessarily involved a finding on the main question; but in form it was a declaration as to the sacrament: that of the party who prevailed was declared to be just, and that of his unsuccessful opponent unjust.

Looking at this ritual as a whole, the conviction is irresistible that it could not have been so devised by one brain. It reveals and combines three distinct stages in the history of procedure—appeal to arms and self-help, appeal to the gods and the spiritual power, appeal to the civil magistrate and his judicial office. As Gellius says, the real and substantial fight for might, that in olden days had been maintained at the point of the spear, had given place to a civil and festucarian combat in which words were the weapons, and which was to be settled by the interposition of the praetor. But this does not explain the *sacramentum*. Various theories have been proposed to account for it. According to Gaius, it was nothing more than the sum of money staked by each of the parties, which was forfeited originally to sacred and afterwards to public uses by him who was unsuccessful, as a penalty for his rashly running into litigation; and substantially the same explanation is given by Festus in one of his definitions of the word. But this is far from satisfactory, for it involves the apparent absurdity of declaring that a penalty imposed by law could be just in the case of the party who was in the right, and unjust in the case of him who was in the wrong. There is another definition in Festus—“a thing is said to be done *sacramentum* when the sanction of an oath is interposed”—that lends support to the opinion that there was a time when parties to a question of right were required to take an oath to the verity of their respective assertions; that they were also required concurrently to deposit five bullocks or five sheep, according to the nature or value of the thing in dispute, to abide the issue of the inquiry; that the question for determination was whose oath was just and whose unjust; and that he who was found to have sworn unjustly forfeited his cattle or sheep as a *pietamentum*—a peace-offering to the outraged deity—while the other party claimed his from the repository in which they had been detained in the interval. It is a curious opportunity doubtless by the priests to get some profit for their temples.

¹ It was the *Lex Aemilia Tarpeia* of the year 454 B.C. that commanded the five bullocks and five sheep into 500 and 50 lb of copper respectively (*De Rep.* ii. 35). In the words of the word, usually printed “de multa *sacramentum* should read “de multa et *sacramentum*.” See Festus, s.v. “*Pecculatus*” (in Bruns, *Fontes*). As to the relative value of oxen and sheep, it is interesting to note that, by the customs of the modern Ossetians, ten sheep are also held to be equivalent to one ox. See Kovalevsky, *Costume contemporaine*, p. 11. For the pounds’ weight of raw metal the XII. Tables substituted the same number of *asses*, declaring that 500 should be the *summa sacramenti* when the cause of action was worth 1000 *asses* or more, so when worth less or the question one of them or of *denarii* (Gai., iv. 14).

² Varro, *De Re Rust.* 186, says that, even after the *summa sacramenti* had been converted into money, it was deposited *ad pontem*—some bridge, he does not say which, where there was a sacred “pond.” (Curiously enough, the Irish spelling of “pond” is “pont.”; Skeat’s *Etyim. Dict.*, s.v. “Pound.”) A most ingenious and plausible explanation was suggested by Danz in 1867, in the *Zeitschr. f. Rechtsgesch.* vi. 359. Recalling the facts that there had been discovered in the Tiber Island *saecula* of Jupiter Jurarius and Dius Fidius, the two deities to whom solemn oaths were usually addressed, and that the island was spoken of as “inter pontes,” because connected with the island by a bridge over by bridges bearing no particular names, he suggested that the island may have been the place to which disputants resorted to make their *sacramenta*, and that the cattle, sheep or money were deposited in a place for the purpose before the bridge was crossed. Much the same explanation was offered by Huschke two years later in his book *Das alte römische Jähr* (Breslau, 1869), p. 360, apparently without being aware of Danz’s speculation. He adds, on the authority of the Iguvine Tables, that, while bullocks were offered to Jupiter, only sheep were offered to Dius Fidius. The island, he thinks, must have been selected as neutral ground to which all parties might have access, and which obviated intrusion into

the writers who adopt this form are far from being unanimous as to details. But there seems to be enough to render it more than probable that, at an intermediate stage between the *vera solida vis* of ancient times and the *vis civilis et festucaria* which Gellius and Gaius depict, there was a procedure by appeal to the gods through means of oaths of verity sworn by the parties, in the manner and with the consequences that have been indicated. That in time it should have dropped out of the ritual is quite in the order of things. Its tendency was to become a mere form, imposing no real restraint on reckless litigation. The restraint was rather in the dread of forfeiture of the sacramental cattle, sheep or money that would follow a verdict that an oath had been unjust. And it must have been felt besides that it was unfair to brand a man as a false-swearer, needing to expiate his offence by an offering to the gods, whose oath had been perfectly honest. That he should suffer a penalty for his imprudence in not having taken more care to ascertain his position, and for thus causing needless annoyance to others, was reasonable, but did not justify his being dealt with as one who had knowingly outraged the deity to whom he had appealed. So the oath—the original *sacramentum*—disappeared, the name passing by a natural enough process to the money which had been wont to be deposited before the oath was sworn, but which now ceased to be an offering in expiation by a false-swearer, and became a mere penalty (forfeited to the state) of rash litigation (*poena temere litigantis*). So when *praedes* later took the place of actual deposits, they became bound as state debtors for the *sacramentum*.

It may well be assumed that in most cases the finding of the court as to the justness or unjustness of the respective sacraments of the parties was the end of the case—that it was at once accepted and royally given effect. Even if in regard to the party to whom writim possession had been given by the magistrate there could be no difficulty; he retained the object in dispute with the fruits and profits he had drawn in the interval between *litis contestatio* and judgment. If, however, the finding was for the other party, and amicable arrangement was not come to, it is not clear what course was followed. Gaius says that in awarding interim possession (*viudicium dicens*) the praetor required the grantee to give security by sureties (*praedes*) to his adversary for restitution to the latter in the event of his success; while Festus preserves a law of the XII. Tables which, according to Mommsen’s rendering, declared that if the sureties furnished to the praetor necessarily were awarded to the wrong party, it was to be in such party’s power to demand the appointment of three arbiters who should ascertain the value of the object of vindication and its fruits, and assess the damages due for non-restitution at double the amount. This provision seems to have been intended to afford the wrongful interim possessor, who was not in a position to make specific restitution to his successful opponent, a means of avoiding the apprehension and imprisonment which were the statutory consequences of failure to implement a judgment. It is probable that in time this duplicated money payment came into general use as the satisfaction to which the successful party in a vindication was entitled in every case in which, no matter for what reason, he was unable to obtain the thing itself and its fruits from their interim possessor; that consequently an *arbitrium litis aestimandae*, or reference to arbiters to assess their value, resulted in every such case; and that it was to assure its payment that the praetor required the party to whom the interim possession was awarded to give to his opponent the sureties (*praedes litis et vindicatarum*) to whom Gaius alludes.³

This procedure in the sacramental action for vindication of land was applicable to every kind of *manus* which a man could claim to have over others, or things that were necessarily *res mancipii* or less or more important in the ritual. But the sacramental action was also quite common for claims in *personam*. As regards personal actions, the ordinarily received opinion, which rests, however, on slender foundations, is that from the first the parties met on equal terms; that, if it was a case of money debt, the creditor commenced the proceedings with the averment that the defendant owed him the sum in question,—“I say that you ought to pay me (*dare oportere*) 1000 *asses*”; that this was met with a denial; and that a sacramental challenge followed on either side. All are agreed that the remit was to a single *iudex* after an interval of thirty days from the proceedings in *jure*; that when the claim was in every case to the plaintiff himself to establish his case to the letter; and that his sacrament was necessarily declared unjust if he failed to prove his claim by a single penny. But there is considerable diversity of opinion as to whether by this form of process a claim of uncertain amount

the temples of the two gods on the Capitol and Quirinal respectively. And it is to its use as the scene of the sacramental procedure that he attributes its name of “holy island,” rather than to the fact of its having been the seat of the temple of Aesculapius. Huschke recurs to and enforces this view in his *Multa und Sacramentum* (1874), p. 410, where he does refer to Danz’s paper.

³ Another theory is that, while the interim possessor could not be proceeded against, the *praedes*, who were really bound in his place and not merely as accessories, were directly subject to execution as debtors of the state. On this and other theories, see Cuénot in *Now. Rev. hist.* pp. 345 sqq.; Girard, *Manuel*, pp. 328–29.

could be insisted on—as, for example, for damages for breach of a warranty of acreage of lands sold, or of their freedom from burdens. If it could, then probably the question raised and dealt with *sacramento* was the abstract one of liability—Was the warranty given, and has it failed?—the sum due in respect of the breach being left to be dealt with in a subsequent arbitral process (*arbitrium liti aestimanda*).

The *Legis Actio per Judicis Postulationem*.¹—The defects of the Verona MS. have deprived us of Gaius's account of this *legis actio*. There is little elsewhere that can with any certainty be said to bear upon it. The most important is a note in Valerius Probus—*T.P.R.I.A.V.P.V.D.*, which is generally interpreted—*te, praetor, judicium arbitrum postulo uti des*. This petition to the magistrate to appoint a judge, arbiter or arbiters (as the case might be) in all probability was part of the procedure in the action, and that from which it derived its distinctive name. Beyond this all is conjecture, alike as to the nature and form of the action and the cases to which it was applicable. Gaius says of the *legis actio sacramento* that it was general, and that it was the procedure that was to be resorted to where no other was prescribed by statute. There are, however, nowhere indications of an express instruction that proceedings in any particular case were to be *per judicis postulationem*.

While it is impossible with certainty to trace the history of this procedure to its first beginnings, yet the impression is general that it must have originated in the regal period. It is commonly held to have been applicable to the divisory actions, and some others triable by arbiters as directed by the XII. Tables. Some eminent writers hold that it was employed in certain actions in which equitable considerations were allowed to be taken into account by the judge (e.g. the *actio fidejuciae*), and generally in so-called *juris* as contrasted with *lites*. But this theory has many difficulties to contend with. It has no support from any ancient writer, and it leads to the result that the courts by *legis actiones* had power to take into consideration questions of *bona fides*, which is not only in contradiction with what Gaius says (iv. 11), but inconsistent with their character.²

The *Legis Actio per Conditionem*.³—This, the youngest "action of the law," was introduced, Gaius says, by the Silian law as a means of recovering a liquid money debt (*certa pecunia*), and afterwards made available by the Calpurnian law for enforcing personal claims (as distinguished from real rights) for anything else definite and certain (*omnis res certa*), and in both its forms, therefore, essentially an action of debt. The date of both enactments is matter of controversy, although there is no question that the Silian was the earlier. Gaius says of it that its purpose was far from obvious, as there was no difficulty in recovering money either by a sacramental action or one *per judicis postulationem*. But it is probable, as above stated, that money due under a nexal contract was recoverable by neither of these processes, but by the much more summary one of *manus injectio*, a procedure which would be practically put an end to by the Poetilian law of 326 B.C. We are disposed to regard the *lex Silia* and the new procedure it authorized as a result of the change made by this last-mentioned statute. To have put off a creditor for money lent either with a sacramental action or one *per judicis postulationem*, would have been to deprive him of the advantages of *manus injectio* to a greater extent than was called for. At any rate, it seems to have been provided by the Silian law that *certa man*, a man disputed his liability for what was called *pecunia certa credita*, and forced his creditor to litigation, the plaintiff was entitled, if he pleased, to require from him an engagement to pay one-third more by

way of penalty in the event of judgment being against him, while the *soi-disant* creditor had similarly to undertake to pay as penalty the same amount in case of judgment in favour of the alleged debtor. Those engagements (*sponsio et restipulatio tertiae partis*) were not allowed in every case in which a definite sum of money was claimed *per conditionem*, but only when it was technically *pecunia credita*. In Cicero's time *credendum* might arise either from loan, stipulation or literal contract (*expensatio*); but the last dated probably at soonest from the beginning of the 6th century, and stipulation apparently was a result of the Silian law itself, so that the *pecunia credita* of this enactment can have referred only to borrowed money. The same phrase, according to Livy, was employed in the Poetilian law; it was thereby enacted, he says, that for *pecunia credita* the goods, not the body of the debtor, ought to be taken in execution. A connexion, therefore, between the Poetilian law and the disuse of the *nexum* on the one hand, and the Silian law and the introduction of the *legis actio per conditionem* on the other, can hardly be ignored, and raises a probability that the latter statute was a consequence of the former, and was passed immediately or soon after the year 326 B.C. In the action on the Calpurnian law, it is probable that there was no penalty of a third part on either side. A peculiarity of the *legis actio per conditionem* is that the plaintiff could when before the magistrate refer the case to the defendant's oath (*juramentum necessarium*). Taking the oath involved absolution. Refusal involved condemnation.

Little is known of the procedure in this *legis actio*, for, in consequence of the loss of a leaf in the Verona MS., we are without part of Gaius's account of it. It got its distinctive name, he says, from the *conditio* or requisition made by the plaintiff on the defendant, who he had brought on to court in the usual way, to attend again on the expiry of thirty days to have a judge appointed. The procedure on the reappearance of the parties on the thirtieth day (provided a settlement had not been arrived at in the interval) varied according as the action was (1) for a definite sum of money falling under the category of *pecunia credita*, or (2) for any other definite sum of money or a definite thing or quantity of things. In the action for *pecunia credita* the *sponsio et restipulatio tertiae partis* were exchanged; and it is probable that, if either party refused on the praetor's command so to oblige himself towards the other, judgment was at once pronounced in favour of the latter without any remit to a *judex*. How the issue was adjusted when the *sponsio* and *restipulatio* were duly given we are not informed, but, judging by analogy from the procedure in an action for breach of interdiction under the formular system, and on the broader ground that there must have been machinery for a condemnation of the plaintiff on his restipulation in the event of his being found in the wrong, it may reasonably be concluded that there were in fact three concurrent issues sent to the same *judex*—the first on the main question, the second on the defendant's *sponsio* and the third on the plaintiff's restipulation. When a sum of money other than *pecunia credita* or a thing or quantity of things other than money was sued for, those subsidiary issues were unnecessary if the view above expressed be correct.

As Baron has demonstrated, it was not the usual practice to introduce any words explanatory of the ground of indebtedness when the action was either for money (other than *pecunia credita*) or for a thing or quantity of things. It might be loan, or quest, or sale, or purchase, or delivery, or other kind of contract, or of a hundred *causae*; it would have to be stated of course before the judge; but in the initial stage before the praetor and in the issue all that was necessary was the averment that the defendant was owing such a sum of money or such a thing. It was for the judge to determine whether or not the averment was established and, in certain cases, that non-delivery was due to the fault of the defendant; the plaintiff, however, was bound to make his averment good to the letter of his claim. In the event of the plaintiff being successful in an action for *certa pecunia*, but delay was made by the defendant in satisfying the judgment, execution followed in ordinary form. How the matter was arranged in an action on the Calpurnian law for a *certa res* is not so obvious. What the plaintiff wanted was specific delivery or damages, and by some the opinion is entertained that he formulated his claim alternatively. Of this there is no evidence; and Gaius's statement that under the system of the *legis actiones* condemnation was always in the *ipso res*, i.e. the specific thing sued for, leads to the assumption that a judgment for the plaintiff, on which specific implement failed, must have been followed by an *arbitrium liti aestimanda* for assessment of the damages in money, and that execution proceeded thereon as if the judgment had been for a sum of money in the first instance. The general opinion, however, is that the judge to whom the issue was remitted

¹ To the literature on p. 548, note 1, add Baron, "Zur leg. act. per judicis arbitri postulationem," in the *Festschrift für Aug. W. Heffler* (Berlin, 1873), pp. 29 sqq.; Huschke, *Multa*, &c., pp. 394 sqq.; Adolf Schmidt, "Ueber die l. a. per jud. post.," in the *Zeitschr. d. Sav. Stift.* (1881), vol. ii., *Röm. Abtheil.* pp. 145 sqq.; Voigt, *XII. Tafeln*, vol. i. § 61.

² See on this Mitteis, *Römische Privatrecht* (1908), p. 31 and p. 44 n. 11.

³ To the literature on p. 548, note 1, add Bekker, *Aktionen*, vol. i. cap. 4-7; Voigt, *Jus Naturale*, &c., d. *Römer* (Leipzig, 1856-75), vol. iii. §§ 98, 99; Baron, *Die Conditionem* (Berlin, 1881), §§ 15, 16; Jobbé-Duval, *Procédure Civile* (1896), i. 61 sqq.

assessed the damages himself and as a matter of course—that the instruction to him was *quanti res erit, tantum pecuniam condemnato*.

The *Legis Actio per Manus Injectionem*.¹—This "action of the law" was ordinarily employed as a means of execution against the body of a judgment-debtor or one who had confessed liability in the first stage of a process. But, in certain cases, it is conjectured, it was thought proper that a creditor should have a more summary remedy than was afforded by a sacramental action or one *per judicis postulationem*, and he was allowed to apprehend his debtor without any antecedent judgment or confession; in which cases, if the debtor disputed liability, the question could be tried only in proceedings at his instance, or sometimes at that of a third party on his behalf, for a stay of execution. It will simplify matters, however, to confine our attention to it in the meantime as a means of execution against the body of a judgment-debtor.

Gaius's description of it is very general; for details we are indebted principally to the *Noctes Atticæ* of Aulus Gellius, in an account which he gives (put into the mouth of Cæcilius Africanus, a well-known jurist of about the same time as Gaius, and a contemporary of his own) of the provisions of the XII. Tables in reference to it. Africanus is made to say that according to his belief (*opinor*) the words of the statute were these: "For admitted money debts and in causes that have been regularly determined by judgment (*aeris confessi rebusque jure judicatis*) there shall be thirty days' grace. After that there may be *manus injectio*. The apprehending creditor shall then bring his debtor before the magistrate. If he still fail to satisfy the judgment, and no *vindex* come forward to relieve him, his creditor may carry him home and put him in chains. He may live at his own cost; if not, his creditor must give him daily a pound of spelt, or more if he please." Africanus continues *narratitè*: "There was still room for the parties to come to terms; but, if they did not, the debtor was kept in chains for sixty days. Towards the end of that time he was brought before the prætor in the *comitium* on three consecutive market-days, and the amount of the judgment-debt proclaimed on each occasion. After the third proclamation *capite poenas dabit*"—what these words mean will be considered in the sequel—"or else he was sent across the Tiber to be sold to a foreigner. And this capital penalty, sanctioned in the hope of deterring men from unfaithfulness to their engagements, was one to be dreaded because of its atrocity and of the new terrors with which the decemvirs thought proper to invest it. For, if it was to more creditors than one that the debtor had been adjudged, they might, if they pleased, cut up and divide his body. Here are the words of the statute—" *Tertius nudandis partis secanto. Si plus minusve secuerunt, se fraude esto.* "

Such is Gellius's account of the provisions of the XII. Tables in reference to this *legis actio*, and he is to a considerable extent corroborated by Quintilian, Tertullian and Dio Cassius. But it is to be borne in mind that he does not vouch for its accuracy; the Tables were already in his time matter of antiquity, and even the jurists knew little about them beyond what was still in observance. That he has reproduced them only partially seems almost beyond question; for in another chapter he himself quotes a couple of sentences that are to all appearance from the same context. We have to face, therefore, the extreme probability that the record is incomplete and the possibility besides that it is not literally accurate. There is room for error, consequently, in two directions; but the nature and effect of the procedure in its main features may be gathered from the texts as they stand with reasonable certainty.

It was competent only after thirty days from the date of judgment or confession.² It was apprehension of the debtor by the

creditor himself,—in its first stage, at least, an act of pure self-help. The debtor had at once to be brought before the magistrate, in order that his creditor might solemnly go through the required formalities before he could carry him away and provisionally confine him in the domestic lock-up. It was this appearance before the magistrate that made it a *legis actio*. Such a course, however, was avoided either (1) by instant payment or other implement of the judgment or arrangement with the creditor, or (2) by the intervention of a *vindex* or champion. The position taken by the latter was not that either of a surety or of an attorney for the *judicatus* demanding a rehearing of the case; he appeared rather as a controvertor in his own name of the right of the creditor to proceed further with his execution, on the ground that the judgment was invalid. This might necessitate an action between the *vindex* and the creditor, in which the former was plaintiff, but to which the debtor was not a party. If it failed, then the *vindex* was liable for double the amount of the original debt, as a penalty on him for having improperly interfered with the course of justice; his interference was treated as a delict, but on payment he had presumably relief against the original debtor who had been liberated through his intervention. Failing a *vindex* and failing payment, the creditor took his debtor home and incarcerated him, dealing with him for sixty days in the manner above described. On their expiry, without any arrangement, there was a magisterial decree (*addictio*) awarding the debtor to his creditor.

What right did this *addictio* confer upon the creditor? The debtor, says Gellius, "*capite poenas dabit*," which he interprets as meaning that his creditor might put him to death, the alternative being his sale as a slave beyond the Tiber. There is, however, a diversity of opinion among the modern writers as to the true meaning of these words. While some hold, and rightly it is thought, that the Gellian interpretation is correct, others object to it as extravagant. It is objected to by Muirhead on the ground, *inter alia*, of its incredible severity in the case of petty debtors. He holds that *capite poenas dabit* meant simply that the debtor "paid the penalty with his person," in contradistinction to "his means." *Caput* is thus merely used in opposition to *bona*. Even more numerous are the writers who object to Gellius's statement that the body of the *addictus* when killed might be cut in pieces where there were several creditors. They hold that the words *partis secanto* of the Tables referred not to the body but to the belongings of the debtor,—that when there were concurrent creditors they shared his *familia* amongst them.³ But these views are, it is thought, somewhat fundamentally erroneous. *Poenas dabit* does not mean death, slavery or deprivation of citizenship; there is nothing more astonishing in a creditor's right to kill his debtor than in a father's right to kill his child; and comparative law gives many instances, of a parallel kind, of the harshness of primitive law to defaulting debtors. The *partis secanto* was probably a relic of earlier times, and Gellius admits that he never heard or read of a dissection having taken place.

The cruelties and indignities to which creditors subjected both their judgment and nexal debtors led, as above noticed, to many a commotion in the first two centuries of the Republic. The latter were probably much more numerous than the *judicati*, and, being in great part the victims of innocent misfortune, it was the sufferings they endured at the hands of relentless creditors that so often roused the sympathies and indignation of the populace. But the judgment-debtors had suffered along with them; and some of the provisions of the Poetilian law of 326 B.C., already mentioned, were meant to protect the former against the needless and unjustifiable severity that had characterized their treatment by their creditors. The *manus injectio* itself was not abolished, nor the possible intervention of a *vindex*; neither were the *domum ductio* that followed, and the provisional imprisonment with the light chains, authorized by the Tables while it lasted; nor apparently was the formal *addictio* of the debtor to his creditor when the sixty days had expired without arrangement. But after addition, if it was for nothing more than civil debt, there were to be no more dungeons and stripes, fetters and foot-blocks; the creditor was to treat his debtor and his industry as a source of profit that would in time diminish and possibly extinguish his indebtedness, rather than as an object upon which he might perpetrate any cruelty by way of punishment. Although the edict of P. Rutilius of 107 B.C. provided a creditor with machinery for debtors, but this view has, it is thought, insurmountable objections to overcome.

¹ For fuller explanation, see Muirhead, *Hist. Introduction*, 2nd ed. pp. 198 seq., and authorities there cited. See also Kleineidam, *Personalexekution*, pp. 235 seq. Lenel must be added to those writers who think that "*partis secanto*," &c., refers to the goods of the debtor (*Zeitschr. d. Sav. Stift.* xxvi. pp. 507-509).

¹ To the literature on p. 548, note 1, may be added Huschke, *Nexum* (1846), pp. 79 seq.; Savigny, "Das älteste Schuldrecht," in his *Verm. Schriften* (1850), il. 396 seq.; Hoffmann, *Die Forsten u. Sanaen, nebst Anhang über d. altröm. Schuldrecht* (Vienna, 1866), pp. 84 seq.; Vainberg, *Le nexum et la contrainte par corps en droit romain* (Paris, 1874), pp. 36 seq.; Voigt, *XII. Tafeln*, vol. I. §§ 63-65; Jhering (as above), pp. 548), pp. 196 seq., 222 seq.; Cuius *Institutiones Juridicæ*, 2nd ed. p. 141 seq.; Schlossmann, *Altromisches Schuldrecht* (1904); Kleineidam, *Personalexekution der XII. Tafeln* (1904).

² In his *Historical Introduction*, 2nd ed., pp. 192-193, Muirhead maintains that the "*aeris confessi*" of the Tables refers to nexal

attaching the estate of his debtor, he had still the alternative of incarceration. This might be avoided under the Julian law of *cessio honorum* by the debtor's making a complete surrender of his goods to his creditor; but, failing such surrender, incarceration continued to be resorted to even under the legislation of Justinian. During the Empire, of course, it was not by *manus injectio* that the incarceration was affected; for it went out of use with the definitive establishment of the formular system of procedure.

It was as directed against judgment and nexal debtors that *manus injectio* was of most importance and chiefly made its mark in history. But there were other cases in which it was resorted to under special statutory authority, where a remedy seemed advisable more sharp and summary than that by ordinary action. In some of these it was spoken of as *manus injectio pro iudicio* (i.e., as if upon a judgment), in others as simple *manus injectio (manus injectio pura)*. In the first the arrestee was not allowed to dispute his alleged indebtedness in person; he could do so only through a *vindex*; and if no one intervened for him in that character he was carried off and dealt with by his arresting creditor as if a judgment had been obtained against him. In the second he was not required to find a *vindex*, but might himself dispute the verity of the charge made against him, under penalty, however, as is generally supposed (though it is disputed), of a duplication of his liability if he failed in his contention. By a *lex Vallia*, probably in the latter half of the 6th century of the city, this *manus injectio pura* was substituted for that *pro iudicio* in all cases in which the ground of arrest was neither judgment nor so-called *depensum*, i.e. payment by a surety or other party on account of the true debtor, who failed to relieve the former within six months of such payment.¹

The *Legis Actio per Pignoris Capionem*.²—In the ritual of the *actio sacramenti vis civilis et festuvaria* was a reminiscence of the *vera solida vis* with which men settled their disputes about property in the earliest infancy of the commonwealth. *Manus injectio* was a survival from earlier times when the wronged was held entitled to lay hands upon the wrongdoer, and himself subject him to punishment; custom and legislation intervened merely to regulate the conditions and mode of exercise of what essentially was still self-help. In *pignoris capio* self-help was likewise the dominant idea. It may be fairly enough described by the English legal term distress—the taking by one man of property belonging to another in satisfaction of or in security for a debt due by the latter which he had failed to pay. The seizure, however, did not proceed upon any judgment, nor did it require the warrant of a magistrate; it might be resorted to even in the absence of the debtor, and on a *dies nefastus*; but it required to be accompanied by certain words of style, spoken probably in the presence of witnesses. It was only in a few exceptional cases that it was competent, in some by force of custom, in others by statute, nearly all of which seem to be given by Gaius,³ and all of them being of a military, religious or fiscal character. What was the procedure, and what its effects, are far from certain. Jhering, founding on some expressions of Cicero's, conjectures that, whether the debt was disputed or not, the distrainer could neither destroy nor sell nor definitely appropriate his *pignus* without magisterial authority,—that in every case he was bound to institute proceedings in justification of his caption, and to take in them the position of plaintiff. The idea is ingenious, and puts the *pignoris capio* in a new and interesting light. It makes it a summary means of raising a question of right for whose judicial arbitration no other process of law was open,—with the additional advantage that it secured instant satisfaction to the raiser of it in the event of the question being determined in his favour. If against him, the inevitable result, in substance at least, must have been a judgment that he had no right to retain his pledge, with probably a finding

that he was further liable to its owner in the value of it, as a punishment for his precipitancy.⁴

Judicial or Quasi-Judicial Procedure outside the Legis Actiones.—Whatever may have been the extent of the field covered by the actions of the law, they did not altogether exclude other judicial or quasi-judicial agencies. The supreme magistrate was frequently called upon to intervene in matters brought under his cognizance by petition or complaint, in which his aid was sought not so much to protect a vested right of property or claim as to maintain public order, or to prevent the occurrence or continuance of a state of matters that might prove prejudicial to family or individual interests. The process was not an action, with its stages *in iure* and *in iudicio*, but an inquiry (*questio*) conducted from first to last by the magistrate himself; and his finding, unless it was a dismissal of the complaint or petition, was embodied in an order (*decretum, interdictum*) which it was for him to enforce by such means as he thought fit,—*manu militari*, or by fine or imprisonment. Some jurists are disposed to give a very wide range to this magisterial intervention. One of its most important manifestations was in connexion with disputes about the occupancy of the public domain lands. These did not belong in property to the occupants, so that an action founded on ownership was out of the question. But, as the occupancy was not only recognized but acted upon by statute, it was right, indeed necessary in the interest of public order, that it should be protected against disturbance. In the measures resorted to for its protection Niebuhr recognized the origin of the famous possessory interdict *uti possidetis*; and, although opinions differ as to whether protection of the better right or prevention of a breach of the peace was what primarily influenced the magistrate's intervention, there is, apart from some distinguished exceptions, a pretty general accord in accepting this view. Another illustration of this magisterial intervention is to be found in the interdiction of a spectatitius, a decree depriving of his power of administration a man who was squandering his family estate and reducing his children to penury; a third presents itself in the removal of a tutor from office on the ground of negligence or maladministration, on complaint made to the magistrate by any third party in what was called *postulatio suspecti tutoris*; and a fourth in the putting of a creditor in possession of the goods of an insolvent debtor, which must have been common enough even before the general bankruptcy regulations of the Rutilian edict. These are to be taken merely as examples of this magisterial intervention, which may be met in various directions, and it is not necessary to see how largely such procedure might be utilized for remedying the grievances of persons who, from defect of complete legal title, want of statutory authority, or otherwise, were not in a position to avail themselves of the "actions of the law."

In one of the Valerio-Horatian laws consecrated on the second secession of the plebeians there was mention of ten judges (*iudices decemviri*), whose persons were declared as inviolable as those of the tribunes of the people and the plebeian aediles. These were, it is generally supposed, a body of judges elected to officiate on request from a tribune or aedile in questions arising between members of the plebeian body. We are without details as to the institution of this plebeian judiciary, the questions that fell under its cognizance, the forms of process employed, the law administered by it and the effect of its judgments. It is not much referred to by the historians; and its decadence has been attributed to the fact that the *Lex Hortensia* of 287 B.C. made the *mundinae* lawful court-days (*dies fasti*), and so made it possible for the country folk coming to the city to market to carry on their processes before the praetor. It has also been identified by some writers* with the *decemviri stitibus iudicandis*, whose jurisdiction has been already noticed (*supra*, p. 536).

All in a manner exercising judicial or quasi-judicial functions must also be mentioned the pontiffs, the consuls, and afterwards the censors as *magistri morum*, the chiefs of the *gentes* within the gentile corporations, and heads of families within their households. While it may be the fact that with the enactment of the XII. Tables the jurisdiction of the pontiffs⁵ was materially narrowed,

⁴ Cf. Gaius, iv. § 32. This would be according to the spirit of the early system, which endeavoured to check reckless or unfounded litigation by penalties,—e.g. forfeiture of the *summa sacramenti* and duplication of the value of unrestored property and profits in a *causae* in which the defendant had been convicted of the cause, when judgment was against the defendant in an action upon an engagement embodied in a *lex mancipii* or *lex nexi*; duplication against a *vindex* who interfered ineffectually in *manus injectio* against a judgment-debtor; duplication against an heir who refused without judicial compulsion to pay a legacy bequeathed *pro damnationem*; the addition of one-third more by way of penalty where a debtor was found liable in an *actio certae creditae pecuniae* (Gai. iv. 171), &c.

⁵ See Voigt, *Röm. Rechtsgeschichte*, i. Beilage i.; contra, Wlassak, *Prolegomena*, i. 144, seq.

⁶ See Cauby, *Le droit pontifical chez les anciens Romains* (Caen, 1869); Bouché-Leclercq, *Les pontifes de l'ancienne Rome* (Paris, 1871); Marquardt, *Röm. Staatsverw.* iii. 290 seq.

¹ On *manus injectio pro iudicio* and *pura*, see Gaius, iv. 22–25. To the literature on p. 548, note 1, add Degenkolb, *Die Lex Hieronica* (Berlin, 1861), pp. 95 seq.; Jhering, *Geist d. röm. Rechts*, vol. i. § 11c; Voigt, *XII. Tafeln*, i. 502 seq.; Girard, *Manuel*, pp. 977 seq.; Wlassak, *Prolegomena*, i. 252 seq. For a comparative view, see Maine, *Early Institutions*, pp. 275 seq.; Jenks, *Laws and Politics in the Middle Ages*, pp. 261 seq.

² For a case not mentioned by Gaius, see Girard, *Textes*, 3rd ed. p. 122; Bruns, *Fontes*, 5th ed. p. 12.

it certainly did not disappear,—witness the famous case in which Cicero made before them the oration of which he was so proud, *Pro domo sua*. The action of the consuls and afterwards of the censors as guardians of public morals, and the social and political disqualifications and pecuniary penalties with which they visited persons who had been guilty of perjury or gross perfidy, did not a little to foster fidelity to engagements. Through the same agency the exercise of a variety of rights whose abuse could not be made matter of action—the husband's power over his wife, the father's over his children—was controlled and kept within bounds. It was not on light grounds, indeed, that the majesty of the *paterfamilias* within the household could be left in question; it was only when he forgot that in the exercise of serious discipline within his family he was bound to act judicially. For he also was a judge—*judex domesticus*, as he is often called, though in all cases of gravity he was required to invoke the advice of his kinsfolk in a family council. On him lay the duty of controlling his family; if he failed to do so he was himself in danger of censorial animadversion.¹

Between citizens and foreigners with whom Rome was in alliance by a treaty (temporary or permanent) conferring reciprocal rights of action, the proceedings took the form known as *reciperatio*. The proceedings were usually limited to ten. How execution proceeded upon it, if it were for the plaintiff, does not clearly appear; Voigt, founding on a few words in Festus, concludes it must have been by something like *pignoris capio*. This recuperatory procedure in time came to be resorted to in processes *de libertate* and even in some litigations where both parties were citizens. There are numerous instances of the latter in Cicero; and it is remarkable that in the praetorian actions *ex delicto* the remit was usually not to a *judex* but to recuperators. The explanation may be in the comparative summariness of the remedy.

III. THE JUS GENTIUM AND JUS HONORARIUM

(Latter half of the Republic.)

i. Influences that operated on the Law.

Growth of Commerce and Influx of Foreigners.—While it may be admitted that commerce was beginning to take root in Rome in the 5th century, yet it was not until the 6th that it really became of importance. The campaigns in which Rome was engaged until the end of the First Punic War absorbed all its energies. But after that time the influx of strangers, and their settlement in the city for purposes of trade, became very rapid—not only of Latins and other allies, but Greeks, Carthaginians and Asiatics. To them and the regulation of their affairs the *jus civile*—the law peculiar to Rome and its citizens—was applicable only if they were members of allied states to which *commercium* and *recuperatio* were guaranteed by treaty. But many were not in this favoured position; and even those who were soon found the range of Roman modes of acquiring property and contracting obligations too narrow for their requirements. Very early a *jus gentium* was gradually developed² which very hence in its history drove treaty covenants³ which were out of use; its application may for a time have been limited to transactions between non-citizens or between citizens and non-citizens, but it was eventually accepted in the dealings of citizens *inter se* and became part and parcel of the *jus*

Romanorum. Gaius and Justinian speak of it as “the common law of mankind,” “the law in use among all nations”; but the language must not be taken too literally. The Roman *jus gentium* was not built up by the adoption of one doctrine or institution after another that was found to be generally current elsewhere. In the earliest stages of its recognition it was “an independent international private law, which, as such, regulated intercourse between peregrins or between peregrins and citizens on the basis of their common *libertas*”;⁴ during the Republic it was purely empirical and free from the influence of scientific theory, but its extensions in the early Empire were the creation of the jurists—a combination of comparative jurisprudence and rational speculation. To say that it was *de facto* in observance everywhere is inaccurate; on the contrary, it was Roman law, built up by Roman jurists, though called into existence through the necessities of intercourse with and among non-Romans.

It may be a little difficult for a modern jurist to say with perfect precision what were the doctrines and institutions of the *jus gentium* as distinguished from the *jus civile*. But the distinction was quite familiar to the Romans, as witness, for example, the statement of Marcian, in reference to the *ἀπόλλοες*, that they enjoyed all the rights competent to a man under the former, but none of those competent to him under the latter.

Institution of the Peregrin Praetorship.—The praetorship,⁵ as already mentioned, was an outcome of the Licinian laws of the year 367 B.C. (see PRAETOR). Down to the end of the 5th century of the city the praetor so appointed superintended single-handed the administration of justice, alike between citizens and foreigners. But with the altered condition of things in the beginning of the 6th century, and the influx of strangers which has already been alluded to, the work seems to have been found too onerous for a single magistrate, and a second praetor was created. The date is generally assumed to have been about the year 242 B.C.; Pomponius says distinctly that the creation of the new office was rendered necessary by the increase of the peregrin population of Rome, and that the new magistrate got the name of *praetor peregrinus* because his principal duty was to dispense justice to this foreign element. After the submission of Sicily and Sardinia the number of the praetors was increased to four and after the conquest of Spain to six; Sulla raised the number to eight, and Caesar eventually to sixteen. But all the later creations were for special purposes; the ordinary administration of justice within the city was left with the representatives for the time of the two earliest, who came to be usually distinguished as *praetor qui inter cives jus dicit* (or *urbanus*) and *praetor qui inter cives et peregrinos jus dicit* (or *peregrinus*). It would be going too far to speak of the latter as the principal author of the *jus gentium*; for a large proportion of the actions for enforcing *jus gentium* rights were civil, not honorary—a fact which proves that the rights they were meant to protect and enforce had their origin in the *jus civile*, although moulded to meet new requirements by tacit consuetude and the agency of the jurists. But even in this view the peregrin praetor must have had a powerful influence in giving shape and consistency to the rising jurisprudence, by means of the formulae he adjusted for giving it practical effect.

Simulation of Procedure and Introduction of New Remedies under the Aebutian Law.—The *lex Aebutia* is only twice mentioned by ancient writers (once by Aulus Gellius and once by Gaius), and we know neither its precise date nor its specific provisions. And yet, to judge by its effects, it must have been one of the most important pieces of legislation in the latter half of the Republic, for Gellius speaks of it as having given the death-blow to many of the institutions of the XII. Tables, and Gaius couples it with two Julian laws of the time of Augustus as

¹ Voigt, *Jus nat.* ii. 661. He distinguishes the *jus civile*, *jus gentium* and *jus naturale* as the systems which applied respectively to the citizen, the freeman and the man.

² See Labatut, *Histoire de la Préture* (Paris, 1868); Mommsen, *Staatsrecht*, ii. 176 seq.; Karlowa, *Röm. Rechtsgeschichte*, i. 217 seq.; Girard, *Organisation judiciaire*, i. 160 seq., and on the peregrin praetorship in particular, pp. 206 seq.

¹ On *Judex domesticus*, see Greenidge, *Legal Procedure in Cicero's Time*, pp. 376-384.

² See Sell, *Die recuperatio der Römer* (Brunswick, 1837); Huschke (rev. Sell), in Richter's *Krit. Jahrbücher*, i. (1837), 868-911; Voigt, *Jus naturale*, &c., ii. §§ 28-32; Karlowa, *Röm. Civilproceß*, pp. 218-230; Girard, *Organisation judiciaire des romains* (1901), i. 97 seq.

³ On the Roman *jus gentium*, see Voigt, *Das jus naturale. aequum et bonum, und jus gentium*, d. Römer (4 vols., Leipzig, 1856-1875); Nettleship, in the *Journal of Philology*, (1885), xiii. 169 seq.; Krüger, *Gesch. d. Quellen*, §§ 16, 17; Mommsen, *Staatsrecht*, iii. 604 n.

The
peregrin
praetor.

Reforms
of Aebu-
tian law.

the statutory instrument whereby the formular system of procedure was substituted for that *per legis actiones*. Its date was probably about the end of the 6th or beginning of the 7th century of the city. Girard, who has examined the question with great care, places it in the first third of the 7th century,¹ and, though his reasoning is not quite conclusive, it largely refutes the arguments of older writers, who in many cases put the date a century and more earlier. It is the opinion of Wlassak² that it was a piece of tentative legislation, and that as regards citizens it in no wise abolished the actions of the law but merely made the formular procedure alternative to them, according as the praetor, on the representation of the parties, might determine in each case; formulae, in his view, being first made compulsory, subject to a few exceptions, by the Julian laws. This is a probable theory and is now adopted by many recent writers. The main purpose of the statute seems to have been to empower the urban praetors to adapt existing remedies to altered circumstances, and *inter alia* to fashion new actions on the *jus civile* for the use of the peregrins, to whom the *legis actiones* were rarely, if at all, available. But, whatever may have been its actual provision, the result was the adoption of a procedure which gradually supplanted that by the actions of the law, which was much more plant than the latter, and whose characteristic was this—that, instead of the issue being declared by word of mouth by the parties, and requiring as a rule to embody with perfect accuracy the statutory provision on which it was based, it was formulated in writing under the direction of the praetor, in the shape of an instruction to the judge to inquire into the merits of the dispute, with power to condemn or acquit according to his finding. A statute was necessary for accomplishing such a transition, not only because the existing procedure was expressly prescribed by statute, but also among other reasons because the *legis actiones* were favourites of the pontifical colleges (being often profitable to them), and any attempt by the magistrates to dispense with them would have been opposed by these powerful bodies. It is now the dominant opinion among modern writers, and it seems based on reasoning which cannot be gainsaid, that even prior to the *lex Aebutia* written formulae were employed in practice, particularly if not exclusively in the peregrin praetor's court, and that one of the objects of the statute was to legalize similar procedure in civil actions.³ All such forms granted by the peregrin praetor of olden date have been *in facta* consuetudine. Rights we hold this view it is difficult to see by what means the rights and obligations of peregrins in their transactions *inter se* or with citizens could have been enforced, as civil actions, save perhaps in exceptional cases where by treaty they enjoyed *jus commercii*, were not open to them. Written instructions to the recuperators or other judges for trying suits in which a peregrin was a party would be a practical necessity, for these judges would have to decide according to *jus gentium*, whose rules would probably be strange to them, and their instructions would therefore have to be precise and definite. Verbal instructions could have led to misinterpretation of justice. From this point of view we can see how the peregrin praetor became the primary organ in developing *jus gentium*. But there is some reason for holding that the urban praetor had also, before the Aebutian law, occasionally exercised his imperium by granting actions *in factum*, and in this way perhaps enforced a number of contracts and other obligations in which elements of equity and good faith were present and which the *jus civile* left remediless. Actions of this kind among *civies* would be in the nature of *arbitria* accepted voluntarily by the parties. The latter view certainly explains several apparent anomalies in the later law, for which no other good explanation can be found, as, for instance, the fact that in deposit and commodate actions *in factum* as well as *in jus* might be brought. Also the *actio in factum* for enforcing a contract of *fiducia* can in this way be explained. It also serves to throw light upon the development of some of the *bonae fidei* contracts.⁴

Provincial Conquests.—The growth of commerce and the enormous increase of wealth, which made great capitalists and enabled them through the agency of freedmen and slaves to carry on trade on a scale hitherto unknown, and which thus helped to foster the *jus gentium*, were no doubt due to a large extent to provincial conquests. But these operated also in other directions. The officials who proceeded to the conquered provinces as governors found themselves face to face with laws and institutions in many respects differing from those of Rome. Political considerations dictated how far these were to be respected, how far subverted. In

some provinces, more especially the Eastern ones, it was thought unnecessary to do more than supplement the existing system by the importation of doctrines of the *jus gentium* and the procedure of the praetor's edicts; while in others, in which it was deemed expedient to destroy as rapidly as possible all national feeling and every national rallying point, a Romanizing of all their institutions was resorted to, even to the extent of introducing some of the formal transactions which previously had been confined to citizens. But in either case there was a reflex action. The native institution had to be studied, its advantages and disadvantages balanced, the means considered of adapting it to the praetorian procedure, and the new ideas so presented as to make them harmonize as far as possible with the old. All this was a training of no small value for those who, on their return to Rome, were to exercise an influence on legislation and the administration of the law. They brought back with them not merely an experience they could not have obtained at home, but sometimes a familiarity with foreign institutions that they were very willing to acclimatize in Italy. Rome thus enriched its law from the provinces, deriving from them their emphatic tenure of land, its hypothec, its Rhodian law of general average and a variety of other features that were altogether novel. They were sanctioned by tacit recognition, by edicts of the praetors and in other ways; but, in whatever way received, they were indirectly fruits of provincial conquest.

Spread of Literature and Philosophy.—The effect on Roman civilization of the addition of educated men in the later Republic to literature and philosophy is a matter for consideration in connexion with Rome's general history. It is not proposed to consider here the question how far specific doctrines of Roman law bear the impress of the influence of the schools, especially that of the Stoics; it is a subject much too large to be disposed of in a few lines.⁵ The matter is mentioned simply for the sake of noting that the spirit of critical inquiry aroused and fostered by literary and philosophical study, seriously and conscientiously undertaken, contributed greatly to promote a new departure in jurisprudence that became very marked in the time of Cicero—the desire to subordinate form to substance, the word spoken to the will it was meant to manifest, the abstract rule to the individual case to which it was proposed to apply it. This was the first effort of what then was called equity to temper and keep within the bounds the rigour of the *jus strictum*. The praetors, the judges and the juriconsults all had their share in it. Although modern jurists are prone to speak of praetorian equity as if it were a thing apart, yet the same spirit was leavening the law in all directions and in the hands of all who had to deal with it, the difference being that the form and publicity of the edict gave to its applications by the praetors a more prominent and enduring record than was found in the decisions of private *judices* or the opinions of counselling juriconsults.

Decline of Religion and Morals.—It would be equally out of place to enlarge here on the causes and manifestations of that decline in religious sentiment and public and private virtue which was fraught with such disastrous results in the later days of the Republic. The private law was influenced by it to a considerable extent, alike in those branches which regulated the domestic relations and those which dealt with property and contract.

The ever-increasing disregard of the sanctity of the marriage tie is one of those features in the history of the period which strikes even the most unobservant. While from the first the law had denounced causeless separation and visited it with penalties, in principle it maintained the perfect freedom of repudiation on the part of the husband. With the simple and frugal habits of the first five centuries of Rome, and the surveillance of the *consilium domesticum*, the recognition of this principle produced no evil results; family misunderstandings were easily smoothed over, and divorces were of rare occurrence. But during the 6th and 7th centuries of the Republic a change to looser morals took place, and the family council lost much of its control. This was doubtless largely due to the decay of hand marriages, wives consequently remaining outside their husband's *familia* and often holding

¹ It is one that was discussed with much greater fervour a century ago than it is now. Of the later literature may be mentioned—Van Vollenhoven, *De exiguâ et quam philosophia Graeca habuit in Efformanda Jurisprudentia Romana* (Amsterdam, 1834); Ratten, *Had die Stoïcijns bediening Ethicus gehab* (82 v. Kiehl, 1830); Voigt, *Jus. nat. etc.*, vol. i. §§ 49–51; Laferrière, *De l'influence du Stoïcisme sur la doctrine des juriconsultes Romains* (Paris, 1860); Hildenbrand, *Gesch. u. System d. Rechts- und Staats-Philosophie* (Leipzig, 1860), vol. i. §§ 141, 142. The earlier literature is given in Hildenbrand, p. 593.

¹ Girard, *Zisch. d. Sav. Stift.* xiv. 11–54 and xxix. 113 seq.; *Manuel*, 4th ed. p. 993; cf. *Mitteis, Röm. Privatrecht* (1908), p. 52 n.; and Wlassak, *Z. d. Sav. Stift.* xviii. 81 seq. and xxviii. 1 seq.

² Wlassak, *Röm. Prozessgesetz* (1888), i. pp. 62–73, pp. 85 seq. and pp. 103–139.

³ See Schömann, *Institutionen*, Ledlie's translation (2nd edn.), pp. 69, 80; Wlassak, *Prozessgesetz*, ii. 304 seq.; *Cuj. Institutiones Jurid.* (2nd ed.) i. 285–286.

⁴ These points are well stated by Mitteis, *Röm. Privatrecht* (1908), pp. 39 seq.; see authorities cited by him in note 2, p. 39. *Contra*, Girard, *Z. d. Sav. Stift.* xxix. 154–158.

property of their own. With increasing luxury and licentiousness divorce became common.¹

This looseness of the marriage bond, as was naturally to be expected, had its effect on the other family relations. The right of children to take their father's inheritance began to be lightly esteemed. The law—or rather the interpretation put upon the *uti legassit* of the XII. Tables—had empowered him testamentarily to disinherit them, or in instituting them to limit their right to a mere fraction of the inheritance; but it was assumed that this power would be exercised with discretion and only when justified by circumstances. But in the later days of the Republic, amid the slackened ties of domestic life, paternal as well as conjugal duty seems to have often been lost sight of, and children were disinherited or cut off with a nominal share of the inheritance in order that a stranger might be enriched. This led to the recognition by the centumviral court, without apparently any legislative enactment or praetor's edict to warrant it, of what was called the *querela inofficiosi testamenti*—challenge of a testament by a child whose natural claims had been capriciously and causelessly disregarded. While the practice may for a time have been hesitating and uncertain, yet early in the empire, through means of this *querela*, the rule came to be established that every child was entitled, notwithstanding the terms of his father's testament, to at least a fourth (*portio legitima*, *quarta legitima*)² of what would have come to him had his parent died intestate, unless it appeared that the latter had had adequate grounds for excluding him or limiting him to a smaller share. A parent might in like manner challenge an unfulfilling testament made by his child to his prejudice; and ultimately in certain cases so might brothers and sisters *inter se*.

The decline of morals had an equally marked effect on the transactions of daily life, calling for precautions and remedies that had not been found requisite in the hey-day of the *πίστις τῶν Ῥωμαίων*. Men no longer relied on each other's good faith unless backed by stipulations, securities (*cautiones*) and guarantees. The Rutilian bankruptcy arrangements and the *actio Pauliana* for setting aside alienations in fraud of creditors indicate a laxity in mercantile dealings that was perhaps an inevitable consequence of the growth of trade and commerce. But, that such remedies as, for example, the *exceptio rei venditae et traditae* or the *exceptio non numeratae pecuniae* should have been found necessary—the one an answer to a vendor (with the price in his pocket) who attempted to dispossess his vendee because some of the formalities of conveyance had been neglected, the other an answer to an action on a bond for repayment of money that by some accident had never been advanced—proves that the law had now to encounter fraud in all directions, and that *Graeca fides* had to a great extent displaced the old Roman probity.

ii. Factors of the Law.

Legislation.—It cannot be said that during the period of nearly two centuries and a half embraced within the present epoch the private law owed much to legislation. The vast majority of the enactments of the time referred to by the historians dealt with constitutional questions, municipal and colonial government, agrarian arrangements, fiscal policy, sumptuary prohibitions, criminal and police regulations, and other matters that affected the public law rather than the private. Those of the latter class mentioned by Gaius and Ulpian in their institutional works barely exceed a score in number; and of these not above half a dozen can be said to have exercised a permanent influence on the principles (as distinguished from the details) of the law. Most of them were enactments of the *concilium plebis* or of the *comitia* of the tribes, to which ordinary legislation had passed as

more readily convened and more easily worked than the *comitia* of the centuries.

Edicts of the Magistrates.—The practice of promulgating edicts was very ancient, and had been followed by kings and consuls long before the institution of the praetorship. It was one of the most obvious ways of exercising the *imperium* with which the supreme magistrate was invested—to lay an injunction upon a citizen and enforce his obedience, or to confer upon him some advantage and maintain him in its enjoyment. It was one of the ways in which public order was protected where there had been no invasion of what the law regarded as a right, and where, consequently, there was no remedy by action. That the earlier edicts of the praetors were of this character—issued, that is to say, with reference to particular cases, and what afterwards came to be called *edicta repentina* or *prout res incidit posita*—there is little reason to doubt. In time a new class of edicts appeared which got the name of *edicta perpetua* (or *perpetuae jurisdictionis causa promulgata*)—announcements by the praetor, published on his album (as the white boards displayed for the purpose in the forum were called), of the remedy he would be prepared to grant on the application of any one alleging that the state of facts contemplated had arisen. The next year's praetor was free to adopt the edicts of his predecessor or not; but it was usual for him to do so if they had been found beneficial in practice, he adding to them new provisions suggested by demands made upon past praetors for *edicta repentina*, but which they had not generalized, or even proposing for acceptance some remedy entirely of his own devising. As each new praetor entered upon office he revolutionized his jurisdictional programme, *ex gratia*, as it was called from this particular point of view, by far the greater part of it *tralatitium*, i. e. transmitted from his predecessors, and only a few paragraphs, diminishing in number as time progressed, representing his own contribution. And so it went on in the first years of the Empire, until the praetorian function was eclipsed by the imperial; and at last, after having, by instruction of Hadrian, been subjected to revision, and consolidated along with the Aedilian Edicts, by Salvius Julianus, it was, as will be noticed below, sanctioned as binding on the whole Empire. The term "Edict" is applied both to the single edicts and also to the whole body of them together.

There is some reason for supposing that the edict attained considerable proportions in the time of Cicero; for he mentions that, whereas in his youth the XII. Tables had been taught to the boys in school, in his later years these were neglected, and young men directed instead to the praetor's edicts for their first lessons in law. Of a few of them the date and authorship are known with tolerable precision; but of the history of the majority, including some of the most important, such as those introducing *restitutio in integrum* on the ground of lesion through error, absence, minority and the like, and those revolutionizing the law of succession, we are to a great extent in the dark. It was one of the great advantages the edicts had over legislative enactments that they might be dropped, resumed or amended by a new praetor according to his judgment of public requirements. For the edict was *viva vox juris civilis*—intended to aid, supplement and correct it in accordance with the ever-changing estimate of public necessities; and this would have been impossible had its provisions from the first been stereotyped as they became by the consolidation in the time of Hadrian.

The edict seems to have contained two parts—the first what may be called the edict proper, and the second styles or actions, &c., whether derived from the *jus civile* or from the *jus praetorium*. The styles or formulae for civil actions were published without any corresponding edict; for praetorian actions styles were published appropriate to their corresponding edicts. There were also independent formulae for interdicts, processual stipulations, &c. The contents of the edicts proper were in detail very various, but all devoted to an exposition of the ways in which the praetor meant to exercise his jurisdiction during his year of office. They were not didactic or dogmatic formulations of law, but rather announcements of what remedy he would grant in such and such circumstances, or direct orders to do or prohibitions against doing certain things. A party claiming an action or whatever else it might be under any of them did so not of right, as he would have done had his claim had a statutory or customary foundation, but of grace—and on the strength of the praetor's promise to grant him what he claimed and make the grant effectual. That was why originally such an action had to be raised and concluded within the particular praetor's year of office—a rule which in time, by abuse, was converted into the somewhat different one that a purely praetorian action (i. e. not originally of the *jus civile*) had to be raised within a year of the occurrence to which it referred.

As already observed, the praetor's edicts proceeded upon lines of equity; that is to say, they were directed against the strictness and formalism of the jurisprudence of the XII. Tables. Such may be said to have been the general tendency of the edicts as a whole.

¹ Voigt, *Die Lex Maenia de dote* (Weimar, 1866), attributes to a *lex Maenia* of 168 B.C. the creation of the *judicium de moribus* which superseded the family council as a divorce court by providing for a penal action on divorce. The extension, however, of a statute for this purpose has not been proved, and is discredited by most recent writers. See Czychlarz, *Das römische Dotalrecht* (Giessen, 1870).

² From this the legitim of children recognized by most continental countries nowadays is derived.

³ See Lenel, *Beiträge zur Kunde des praetorischen Edicts* (Stuttgart, 1878), and the introductory chapters in his *Edictum Perpetuum* (Leipzig, 2nd ed., 1907); Karlowa, *Röm. Rechtsgesch.* vol. i. § 60; Voigt, *Röm. Rechtsgesch.* §§ 19, 20

But it was the tendency of the whole jurisprudence of the time, and by no means peculiar to the praetorian creation. Nowhere in the texts are the praetors spoken of as the mouthpieces of equity as distinguished from law. Such a distinction recurs frequently in Cicero; he identifies *aequitas* with the spirit of a law or agreement, and *ius* with its letter, but it is in order to sing the praises not of the praetors but of the pleaders who maintained the former as against the latter, and of the judges who were persuaded by their arguments. Much of what was contained in the edict might quite as well have been embodied in statute, and we know that in time statute came to its aid; witness a very remarkable provision of it—"I will give *honorum possessio* as may be enjoined by statute, whether comital enactment or *senatusconsultum*."

Of the edicts of the peregrin praetor and their relation to that of his urban colleague little is known. That they differed in some respects there can be no doubt, for in the *lex Rubria* (49 B.C.) for settling the government of Cisalpine Gaul the magistrates are directed, with reference to a certain action, to formulate it in the way prescribed in the edict of the peregrin praetor. The latter, therefore, must to some extent have been in advance of that of the urban praetor, probably in this respect, that, being prepared primarily for the regulation of questions affecting non-citizens, it more thoroughly than the other avoided formalities that were competent only to citizens, and thus to a greater extent simplified procedure. The edicts of the provincial governors must have varied according to circumstances, being in all cases composites of provisions, more or less numerous, borrowed from the edicts of the praetors; and it is interesting to suggest that the peculiar wants of the different provinces for which they were framed (*provinciale genus edicendi*). As for those of the curule aediles, who amongst other duties were charged with the supervision of markets, their range was very limited; their most important provisions having reference to open sales of slaves, horses and cattle, and containing regulations about the duties of vendors exposing them, and their responsibility for latent faults and vices. They also had cognisance of certain delicts committed in the streets and markets. As the aediles had no *imperium* their restricted *ius edicendi* may have been conferred on them by custom or statute.

Consuetudo, Professional Jurisprudence and Res Judicatae.—Great as may be the difficulty experienced by philosophical jurists in defining the ground of the authority of consuetudinary law, there is no room to dispute the importance of its contributions to every system of jurisprudence ancient and modern. The men who first drew, accepted and endorsed a bill of exchange did as much for the law as any lawyer has ever accomplished. They may or may not have acted on the advice of jurists; but, whether or not, they began a practice which grew into custom, and as such was recognized by the tribunals as a law-creating one—often conferring rights and imposing obligations. There is much of this—far more probably than is commonly imagined—in the history of every system of law.

In Rome the process was sometimes wonderfully expeditious; witness what Justinian narrates of the introduction and recognition of testamentary trusts and of codicils to last wills, both in the time of Augustus. It can hardly be doubted that the literal contract *per expensationem* originated in the same way, probably in the end of the 5th or the beginning of the 6th century of the city. The keeping of domestic accounts, books may have been enjoined and enforced by the censors; but it was custom, and neither statute nor praetor's edict, that made an entry in them to another person's debit creative of a claim against the latter for *certa pecunia credita*, that might be made effectual by an action under the Silian law. It must have been in exactly the same way that *mutuum*, formless loan of money, came to be regarded as the third variety of *certa credita pecunia*, and to be held recoverable under the same action. True, this could not have been attained without the co-operation of the jurists; but, whether or not, they began a practice which grew into custom, whose office ended with his judgment, and who was untrammelled by the authority of any *series rerum iudicatarum*.¹ He had simply to decide whether in his view expensation or formless loan created such an obligation as was covered by the words *pecuniam dari oportere*. There may for a time have been a divergent practice, contradictory findings, as Cicero says there were in his day upon the question whether *aequitas* or *ius strictum* was to be applied to the determination of certain matters; but the eventual unanimity of judicial opinion in one direction was but the expression of the general sentiment of the citizens, of whom the *judices* were the representatives.

These are but examples of the way in which consuetudinary law was constructed. It required the combined action of the laity and the *judices*, both at times acting under professional advice; in some cases even that of the praetors was necessary. It would have

¹ It was not until the Empire that a "series rerum perpetuo similiter iudicatarum," a uniform series of precedents, was held to be law. During the Republic a judge was much freer, and not only entitled but bound to decide according to his own notion of what was right, taking the risk of consequences if his judgment was knowingly contrary to law.

been impossible, for instance, to have introduced the consensual contracts into the Roman system and determined what were the obligations they imposed on either side, without magisterial co-operation in framing the formulae that were to be submitted to the judges. Taking the action on sale as an illustration, the formula substantially was this: "It being averred that the defendant sold such or such a thing to the plaintiff, whatever, judge, it shall appear that the defendant ought in good faith to give or do for the plaintiff in respect thereof, in the money equivalent thereof condemn the defendant; otherwise, acquit him." It is very manifest that the free hand here given to the judge must immensely have facilitated the reception of customary doctrine into the law. The judge was to a great extent the spokesman of the forum; his judgment was formed in accordance with current public opinion, which he had ample opportunity of gauging; it was the reflection of that general sentiment of right, which, phrase it how we may, is the real basis of all customary law. And so in an action for establishing a right of property in a *res mancipi*. The formula was very simple: "If it appear that such or such a thing belongs to the plaintiff in quiritary right, then, judge, whatever be its value for the plaintiff, in that condemn the defendant; should it appear otherwise, acquit him." The primary duty of a judge on such a remit was to determine whether the title on which the plaintiff founded his pretensions gave him a right that came up to property; and it can hardly be disputed that it was by the decisions of a series of judges, in a series of such actions, that the long list of natural modes of acquiring property given by Justinian under technical names was gradually brought into view. These modes of acquisition, whether upon the obligations of a vendor, direct or indirect, or upon the sufficiency of a title founded on by a party averring a right of property by natural acquisition, doubtless were in many cases arrived at under professional advice, and were in all cases embodied in judgments. But that does not in the least deprive the doctrine deduced from them of its character of customary law. It was not until the Empire that the opinions of the jurists submitted to a judge (*responsa prudentium*) were invested with binding authority. During the Republic, if a judge referred to them, it was simply because he regarded them as in consonance with judgments of high-quality public opinion, and what a series of consistent judgments of this sort built up was in the strictest sense a law based on consuetude.

As regards the professional jurists in particular it has already been observed that, according to the testimony of the Roman historians, the law was a monopoly of the patricians down at least to the middle of the 5th century of the city. Livy goes so far as to speak of it as in *penetrationibus pontificum repositum*, among the secrets of the pontifical college. It was so down to the middle of the 3rd century B.C., the end of the domination of the XII Tables. This could be the case only in a qualified sense, the pontiffs becoming the official interpreters of that which in the letter was patent to the world. The *Jus Flavianum*, with its formulary of actions, about the year 304 B.C., the practice of giving advice in law in public adopted by Tib. Coruncanian in the beginning of the 6th century, and the *Triperita* (also called *Jus Aelianum*), embodying the current *interpretatio*, some fifty years later, put an end not only to pontifical but to patrician monopoly.² From this time onwards there was a series of jurists (*jurisconsulti, jurisperiti, jurisprudentes* or *prudentes*, as they were styled), gradually increasing in number and eminence, of whom a list is given by Pomponius, and many of whom are signalized by Cicero, particularly in his *Orator* and *Brutus*. They occupied themselves in giving advice to clients (see *PATRON AND CLIENT*), teaching, pleading at the bar, framing styles of contracts, testaments, and various other deeds of a legal character, or writing commentaries or shorter treatises on different branches of the law.³

iii. Substantive Changes in the Law during the Period.

The *Publician Edict*.—There were necessarily many changes during the period in the law of property and of minor real rights, several of them of no mean importance. But the greatest of all was that effected by the *Publician Edict*,⁴ indirectly recognizing the validity (1) of what Theophilus calls bonitary ownership as an actual though inferior ownership of *res mancipi*, and (2) of what got the name of *bonae fidei possessio*

¹ There is some doubt whether the *Jus Aelianum* mentioned by Pomponius (*Dig. i. 2, 2, 7*) was not an independent collection of actions by Sextus Aelius different from his *Triperita* mentioned (*Dig. i. 2, 2, 38*). See Bremer, *Jurispr. Ante-Hadriana* (1896), i. p. 15.

² Sanio, *Zur Geschichte der röm. Rechtswissenschaft* (Königsberg, 1858); Grellet-Dumazeau, *Études sur le barreau romain* (2nd ed., Paris, 1858); Karlowa, *Röm. Rechtsgesch.* i. § 61; Roby, *Introd. to Digest*, chaps. vii. and viii.; Jörs, *Röm. Rechtswissenschaft* (1888), vol. i.; Bremer, *Jurispr. Antehadriana*, vol. i.

³ See Hübner, *De bonae fidei possessore et de rebus ad proprietatem pretorianam* (Paris, 1867); Huschke, *Das Recht der Publicianischen Klage* (Stuttgart, 1874); Schulin (rev. Huschke), in the *Krit. Vierteljahrsschrift*, xviii. (1876), 526 seq.; Lenel, *Beiträge zur Kunde d. praetorischen Edicts: I. Das Public. Ed.* (Stuttgart, 1878); Appleton, *Histoire de la propriété pretorienne* (Paris, 1889);

as a fictitious ownership of either *res mancipi* or *res nec mancipi*, valid against all the world except the true *dominus*. The accounts we possess of this edict are somewhat inconsistent and even contradictory; the explanation may be that it went through a process of amendment and expansion at the hands of successive praetors, and that eventually it may have had more than one section, without our always being able to say to which of them the criticism of a particular commentator is directed. But there is no doubt of its general tendency—the defects it was meant to correct and of the way in which the correction was accomplished.

One of the defects was this: if a man had taken a transfer of a *res mancipi* from its rightful owner, but simply by tradition instead of by mancipation or cession in court, he did not acquire *dominium ex jure Quiritium*, and the transferee remained undivested. The result was that the latter was in law entitled to raise a *rei vindicatio* and oust the transferee whose money he might have in his pocket, while if a third party had obtained possession of the thing, but in such a way as not to be amenable to an interdict, the transferee could have no effectual vindication against him, as he was not in a position to prove *dominium ex jure Quiritium*. The first difficulty was overcome by the issue of *rei vindicatio et traditio*, as a praetorian remedy, and probably older than the Publician; to the transferee's vindication on the strength of his unextinguished quiritary right the transferee pleaded sale and delivery as an effectual praetorian defence. But, when a third party was in possession, and the transferee by simple delivery had to take the initiative, the position was more complicated. Such third party might be in perfect good faith; he might even have acquired from the original transferee and fortified his acquisition with a formal conveyance. But that was no sufficient reason in equity why he should be allowed to defeat the prior right of the original transferee, who, if he had possessed for the requisite period of usucapion, before the third party came upon the scene would have cured the defect of the informal delivery and acquired an unassailable quiritary right. So the praetor announced in his edict that, if a man came to him and represented that he had bought a *res mancipi* from its owner, and had had it delivered to him, but had lost possession within the period of usucapion, he (the praetor) would allow him a vindication embodying a fiction of completed usucapion (*infra*), with which he might proceed either against the transferee or any third party withholding the thing in question.

The publication of such an edict and the formula of the action based upon it (which, though of praetorian origin, was in many respects dealt with as if it were a variety of the *rei vindicatio*) had almost the same effect as if the legislature had directly enacted that in future delivery of a *res mancipi* in pursuance of a sale or other good cause would confer a right of ownership in it even before usucapion had been completed. Till completed, however, the transferee was not quiritary owner: the thing in question was only in *bonis*, "of his belongings," and the legal title, though an empty one—*nudum jus Quiritium*—remained in the transferee; it was only with the completion of the usucapion that it became the transferee's *pleno jure*. The inevitable result of the recognition of this tenure in *bonis* was that mancipation came to be regarded in many cases as an unnecessary formality; and the marvel is that it continued to hold its ground so long. The explanation may be that it afforded a substratum for and gave force of law to the *verba nuncupata* that accompanied the *negotium per aes et libram*; and, although many of these might quite well be thrown into the form of stipulations, yet there were others that it may have been thought safer to leave to take effect under the provisions of the earlier law.

The second case that was met by the Publician Edict—whether as originally published or by an amendment of it cannot be determined—was that of the *bona fide* transferee of a thing by purchase or other sufficient title who, having lost possession of it before usucapion, found to his cost that the transferee had, before its owner, that no ownership therefore had been transmitted, and that he himself was not consequently he was not in a position to raise a vindication with its avowment of *dominium ex jure Quiritium*.¹ As against the true owner, whose property had been disposed of by a stranger behind his back, there would be no

equity in such an action, and the owner was given an effectual *exceptio justi domini*; but as against all the world except the true owner (and perhaps a person who also was in *causa usucapiendi*), his "better right" was recognized by the praetor, who accorded to him a vindication proceeding on a fiction of completed usucapion, for usucapion would cure the defect of his title, just as it did that of the bonitarian owner. In this way the praetors introduced that *bonae fidei possessio* which was worked out with much skill by the jurists of the early Empire, and which assumed very large proportions in the Justinian law when the term of prescription had been greatly extended, and the difficulty of proving property (as distinguished from *boniana fidei possessio*) consequently very much increased. The Publician action was also in time made applicable in modified form to servitudes and other real rights as much as to property.

*Development of the Law of Contract.*²—It is impossible within the limits of an article such as this to indicate a title of the amendments that were effected on the law of obligations during the period whose distinguishing features were the rise of a *jus gentium* and the construction of the praetor's edict.

In every branch of it there was an advance not by steps but by strides. The obligations arising from contract, of those arising from delict, and of those arising from acts and circumstances, such as unjustifiable enrichment at another person's cost.³ The law of suretyship, in its three forms of *spōsio*, *fidepromissio*, and *fidejussio*, received considerable attention, and formed the subject of a series of legislative enactments for limiting a surety's liability; while that of agency, which was sparingly admitted in Rome, had a valuable contribution from the praetorian edict in the recognition of a man's liability, more or less qualified, for the contractual debts of his *filifamilias* and slaves, as also, and without qualification, for the debts properly contracted of persons, whether domestically subject to him or not, who were managing a business on his account, or whom he had placed in charge of a ship belonging to him. The development of the law in the matter of obligations generally was greatly facilitated by the praetorian simplification of procedure and the introduction of new forms of actions—the instruction to a judge, "Whatever in respect thereof the defendant ought to give to or do for the plaintiff, in that condemn him," preceded by a statement of the cause of action, giving wide scope for the recognition of new sources of liability.

The origin of the verbal contract of stipulation and its actionability under the Silian and Calpurnian laws have already been explained. It was theoretically a formal contract, *i. e.* a negative obligation on the strength of the formal question and answer interchangeably by the parties, even though no substantial ground of debt might underlie it; but in time it became the practice to introduce words—the single word *recte* was enough—excluding liability in case of malpractice (*clausula doli*); and finally even that became unnecessary when the praetors had introduced the general *exceptio doli*, pleadable as an equitable defence to any personal action. And it was essentially productive only of unilateral obligation, *i. e.* the respondent in the interrogatory alone incurred liability; if mutual obligations were intended it was necessary that each should promise for his own part, with the result that two contracts were executed which were perfectly independent. Originally the only words that could be employed were *spōsio* on the one side, *spōsio* on the other; and in this form the contract was *juris civilis* and competent only to citizens and non-citizens enjoying *commercium*? In time the words *promissio*? *promitto*, came to be used alternatively. They were, eventually at least, competent to peregrins as well as to citizens, although that may not have been until the stipulation had become of daily use amongst the former in the still simpler phraseology *dabis*? *dabo*, *facies*? *faciam*. Originally competent only for the creation of an obligation to pay a definite sum of money, and afterwards one for delivery of a specific thing other than money, the contract came in time, by the simplification of the words of interrogatory and response and especially by the substitution of the conditions of the formal system for the *legis actiones* of the Silian and Calpurnian laws, and the introduction of the *actio ex stipulatu* to meet cases of indefinite promise—to be adaptable to any sort of unilateral agreement, whether initiated by it or only confirmed. It was of immense service too outside the ordinary range of contract in what were called necessary (in contradistinction to voluntary) stipulations, of which a variety of illustrations are given *infra*, p. 569. In all directions advantage was taken of it to bind a man by formal contract either to do or to refrain from doing what in many cases he might already be bound *ipso jure* to do or to abstain from doing, and that because of the simplicity of the remedy—an action on

Changes
in law of
contract.

Lenel, *Palingenesia*, ii. pp. 511 seq.; Girard, *Manuel*, 4th ed. pp. 348 seq.; Lenel *Edict. Perpet.* 2nd ed. 164, and references in n. to that work.

¹ This case is the only one alluded to by Justinian (*Inst.* iv. 6, 4). He had abolished the distinction between quiritarian and bonitarian property, which had, he says, become in practice a mockery (*Cod.* vii. 25), and so it was unnecessary for him to mention the other. Lenel, in the second edition of his *Edictum Perpetuum*, i. p. 164, gives strong reasons for holding that there was from the beginning only one edict and one formula which was applied alike to bonitarian ownership and *bona fidei* possession. Cf. Appleton, *l. c.* i. p. 49. For the different theories, see Girard, *Textes*, 3rd ed. pp. 137-38. What was the nature of the so-called *actio Publiciana recessoria* in which completed usucapion was feigned not to have taken place seems doubtful. *Inst.* iv. 6 § 3 s. 5. See Cuij., *l. cit.* *Jurid.* vol. ii. 2nd ed. p. 722 n.; Lenel, *Edict. Perpet.* pp. 117-19.

² See Bekker, *Aktionen*, i. c. 5-8, and App. D, E, F and vol. ii. c. 15, 16; Voigt, *Jus naturale*, &c., vol. iii. §§ 106-24, and vol. iv. App. xix., xxi.

³ Such obligations—usually imposing the duty of restitution of unjustifiable gains—filled a considerable space in the practice and doctrine of the period, and early gave rise to a variety of brocads, e.g., "Nemo cum alterius damno lucrari debet," "Nemo damnatum sentire debet per lucrum alterius," &c.

his stipulation—that would lie against him in the event of his failure.

A second form of contract that came into use to a considerable extent in the latter half of the Republic is what is commonly called the literal contract, or, as Gaius phrases it with greater accuracy, the *nomen transscripticum*.¹ Notwithstanding

the prolific literature of which it has been the subject, it must be admitted that in many points our knowledge of it is incomplete and uncertain. The prevalent opinion formerly was the discovery of the Verona MS. has made known Gaius's description of it, and almost universally adhered to ever since, in that such contracts were created by entries in the account-books which the censors insisted that all citizens of any means should keep with scrupulous regularity. They are often alluded to by the lay writers; but the text principally relied on is what remains of Cicero's speech for the player Roscius. From the tenor of the argument in that case, and incidental remarks elsewhere, the conclusion has been formed that a citizen who made an entry in his *codex*—whether of the nature of a cash-book or a ledger is much disputed—to the debit of another, thereby made the latter his debtor for a sum recoverable by an *actio certae creditae pecuniae*. Gaius in his description of the contract does not mention the *codices*; but his account is not inconsistent with the notion that the entries (*nomina*) of which he speaks were made in them. He says that those entries were of two sorts, *nomina arcaria* and *nomina transscripticia*. The former were entries of cash advances; and of them he observes that they did not create obligation, but only served as evidence of one already created by payment and receipt of the money by the borrower. These entries were posted periodically (usually each month) from a day-book (*adversaria*), and there were distinct pages in the *codex* for that was thus paid out, and the *arca* (*expensum*) and what was paid in. Of the *nomina transscripticia* Gaius says that there were two varieties, the entry transcribed from thing to person and that transcribed from one person to another, and that both of them were not probative merely but creative of obligation. The first was effected by a creditor (A) entering to the credit of his debtor (B) the liquidated amount of what the latter was already owing as the price of something purchased, the rent of a house leased, the value of work done, or the like, and then on the opposite page of the *codex* debiting him with the same sum as *expensum*. The second was effected by A transcribing B's debt in a similar way to the debit of a third party (C), hitherto a debtor of B's, and who was credited to the transaction—A at the same time crediting B with the sum thus booked against C, and marking it as paid to A (*expensatio*). These *nomina transscripticia* were purely fictitious entries so far as any passing of money was concerned, though they had to be made by the direction (*jussus*) of the person made chargeable as debtor. Corresponding entries in the debtor's own *codex*, though usual, do not seem to have been necessary.

All this at first sight seems just a series of book-keeping operations. But it was much more than that for the Roman citizens who first had recourse to it. There was a time, as formerly stated, when sale, and lease and the like, so long as they stood on their own merits, created no obligation enforceable at law, however much it might be binding as a duty to Fides or (as moderns would say) in the forum of conscience; to found an action at law it required to be clothed in some form approved by the *jus civile*. The *nexum* may possibly have been one of those forms, the vendee or tenant being fictitiously dealt with as borrower of the price or rent due under his purchase or lease; stipulation was another, the obligation to pay the price or rent being made legally binding by its embodiment in formal question and answer. But stipulation was competent only between persons who were face to face, whereas *expensatio* was competent also as between persons at a distance from each other. The use of such a *nexum* *expensatio*—which, originally at least, was as much a *negotium juris civilis* as the *spontio*—one advantage over stipulation. But it had also a further advantage, which was not affected by the subsequent recognition of the real and consensual contracts as productive of legal obligation on their own merits: it enabled subsequent transcription of debts from one person to another to be effected. This last must have been of infinite convenience in commerce, not only by enabling traders to dispense with a reserve of coin, but by obviating the risks attending the transit of money over long

distances. It was this that led, as Theophilus says was the case, to the conversion even of stipulatory obligations into book-debts; it was not that thereby the creditor obtained a tighter hold over his debtor, but that an obligation was obtained from him which in a sense was negotiable and therefore more valuable. But in other respects it was much more restricted than stipulation. Thus it only applied to money debts; it did not admit of conditions (though it did admit of a term); and it was never available to peregrins, though the Sabinians proposed that transcription *a re in personam* should be binding on them.

The evolution of the four purely consensual contracts—sale, location, partnership and mandate—supplies matter for one of the most interesting chapters in the whole history of the law. But, as it is impossible in such an article as this to attempt to mark the successive stages in the progress of all of them, we shall confine ourselves to sale. The others did not and could not follow identically the same course: location ran most nearly parallel with sale; but partnership and mandate, from their nature, not only started at a different point from the other two, but reached the same goal with them—that of becoming productive of obligation simply on the strength of consent, interchanged by the parties—by paths that were sometimes far apart. Nevertheless, a sketch of the history of the origin of the contract of sale may be sufficient to indicate generally some of the milestones that were successively passed by all four.²

Going back as far as history carries us, we meet with it under the names of *emptio* and *venditio*, but meaning no more than barter; for *emere* originally signified simply "to take" or "acquire" (*accipere*). Sheep and cattle (*pecus*, hence *pecunia*) may for a time have been a very useful article of exchange on one side, and then came raw metal weighed in the scales. But it was still exchange, instant delivery of goods on one side against simultaneous delivery of so many pounds or weight of copper on the other. With the reforms of Servius Tullius, as we have seen, came the distinction between *res mancipi* and *res nec mancipi*, and with it a regulated mancipation of the former. It was still barter; but along with it arose an obligation on the part of the transferee of the *res mancipi* to warrant the transferee against eviction—a warranty that was implied in the mancipation. Whether this rule obtained from the first or was the growth of custom it is impossible to say; but it is probable that it was the XII. Tables which fixed that the measure of the transferee's liability to the transferee in the event of eviction which he double the amount of the price. Equally impossible is it to say when the practice arose of embodying declarations, assurances and so forth in the mancipation (*leges mancipii*), which were held binding on the strength of the *negotium juris civilis* in which they were clothed. They received statutory sanction in the Tables, in the words already referred to more than once—"cum nexum faciet mancipiumque, uti lingua nuncupasset, ita jus esto," which means in effect "whatever shall by word of mouth be declared by the parties in the course of a transaction *per aes et libram* in definition of its terms shall be law as between them."

The substitution, by or soon after the decemvirs, of coined money, that was to be counted, for rough metals that had been weighed, converted the object of transfer on one side into price (*pretium*), as distinguished from article of purchase (*merx*) on the other; and sale thus became distinct from barter. In contemplation of the separation of the mancipation and the price-paying, and the transition of the former into a merely imaginary sale, the decemvirs enacted that, mancipation notwithstanding, the property of what was sold should not pass to the purchaser until the price had been paid or security by sureties (*nades*) given for it to the vendor; and it was probably by the interpretation of the pontiffs that to this was added the rule—that until the price was paid no liability for eviction should attach to the transferee (or *actor*). The reason perhaps of the provision in this point in the XII. Tables was that a vendor who had mancipated or delivered a thing sold by him before receiving the price had no action to enforce payment of the latter; and in such circumstances it was thought but right to give him the opportunity of getting back the thing itself by a real action. It might be, however, that the price had been paid, and yet the vendor refused to mancipation. It was long, apparently, before the purchaser could in such a case compel him to do so. After the introduction of the *legis actio per conditionem* he (the purchaser) had undoubtedly the power to recover the money on the ground of the vendor's unjustifiable enrichment—that the latter had got it for a consideration which had failed (*causa data, causa non secuta*); and it is possible that before that time had a similar remedy *per judicis postulatiorem* or by an action *in factum*.

Down to this point, therefore, say the beginning of the 6th century, there were several obligations consequent on sale of a *res mancipi*; but not one of them arose directly out of the sale itself.

² The literature on the history of the contract of sale is profuse, but mostly scattered in periodicals and much of it fragmentary. It may be enough to refer to Bechmann, *Der Kauf nach Gemeinem Recht* (3 vols., 1876, 1884 and 1905); Karlowa, *Röm. R. G. ii. pp. 611-32*; Girard, *Notw. Rev. historique* (1883), pp. 539, rec. and in his *Manuel*, 4th ed. pp. 533 seq.

¹ Literature: Savigny, "Über den Literalcontract der Römer" (originally 1816, with additions in 1849), in his *Verh. Schriften*, i. 205 seq.; Keller, in Sell's *Jahrb. f. hist. u. dogm. Bearb. des röm. Rechts*, i. (1841), 93 seq.; Gneist, *Die formellen Verträge d. röm. Rechts* (Berlin, 1845), 321 seq.; Danz, *Gesch. d. röm. Rechts*, ii. 42 seq. (where there is a résumé of the principal of the older theories); Buonicami, in the *Archiv f. Geschichte*, xvi. (1876), 3 seq.; Gide, *Leçon sur le négotium* (Paris, 1879), 185, seq.; Voynow, "Über die Banker's," 515, seq., in *Abhandl. d. K. Gesellsch. d. Wissensch. in Bärn*, x. 5, seq., and a review of this work by Niemyer in *Z. d. Sav. Stifft.* (1890), xi. 312 seq.; Karlowa, *Röm. R. G. ii. 746-57*; Mitteis, *Z. d. Sav. Stifft.* xix. 230 seq.

or could be enforced simply on the ground that it had taken place. The vendor was bound to support the purchaser in any action by a third party disputing his right, and to repay him the price twofold in the event of that third party's success; and he was bound, moreover, to make good to him any loss he had sustained through a deficiency which he had guaranteed, non-existence of servitudes he had declared the lands evicted, existence of others from which he had stated they were free,¹ incapability of a slave for labour for which he was vouched fit, and so on. But breaches of these obligations were probably all regarded as of a delictual character; the obligations were binding, not in virtue of the sale *per se*, but of the transaction *per aes et libram* superinduced upon it; and, if the vendor had at any time to return the price on failure to mancipate what he had sold, it was not because he had committed a breach of contract, but because he had unjustly enriched himself at the purchaser's expense.

In sales of *res mancipi*, just as in those of *res mancipi*, a vendor who had been incautious enough to deliver his wares before he had been paid, or had got stipulatory security for the price, or had converted it into a book-debt, might recover them by a real action if payment was unduly delayed; while the purchaser who had paid in advance but failed to get delivery might also get back his money from the vendor on the plea of unwarrantable enrichment. But, as mancipations were generally supposed to be a mode of carrying the property of some other machinery had to be resorted to than that of the copper and the scales for imposing upon the vendor an obligation of warranty against eviction, defects and so forth. What it was is a question much controverted among modern writers. It may be that, until trade began to assume considerable proportions, and when a transaction was between citizens, a purchaser was content to rely partly on the honesty of his vendor, partly on the latter's knowledge that he ran the risk of an action for theft if what he sold belonged to another; and partly on the maxim common in all ages and climes, *caveat emptor*. When it was one between a citizen and a peregrin, a different set of rules of course came into operation; for between them disputes were settled by actions *in factum* before recuperators, whose decisions were arrived at very much on considerations of natural equity. On the whole, while admitting it to be quite maintainable that the urban praetors, under the influence of *ius gentium*, granted *arbitria* for enforcing obligations of parties in sales *inter cives* even a good while prior to the *actio empti*, the *actio empti* was, in this sense, in favour of the venditor that it was the popularization of the stipulation that facilitated the development of sale into a *bonae fidei* contract.

We read of a *salsitatio secundum mancipium, a stipulatio habere licere* and a *stipulatio duplae*. The nature of the first is obscure; it seems to have been connected with mancipatory sales, and probably to have been the guarantee of a sponsor for the liabilities imposed upon the vendor by the transaction *per aes et libram*, and the *verba nuncupata* that were covered by the *actio*. The stipulation *habere licere* occurs in Varro, in a collection of styles of sales of sheep, cattle, &c., some of which he says were abridgments of those of M. Manilius, who was consul in the year 149 B.C. It was the guarantee of the vendor of a *res nec mancipi*, or even occasionally of a *res mancipi* sold without mancipation, that the purchaser should be maintained in possession of what he had bought; it entitled him to reparation on eviction, measured not by any fixed standard but according to the loss he had sustained. It cannot have been introduced, therefore, until after the *Lex Aebutia* and the promulgation by the praetor of the *actio ex stipulatu*. The *stipulatio duplae* was one binding the vendor for double the price in case of eviction, and was entered into not only where no mancipation of a *res mancipi* took place or one which might be challengeable for invalidity, but also where valuable *res nec mancipi* were sold.

The idea of the *stipulatio duplae* may have been borrowed from the *duplum* incurred by a vendor on the eviction of a purchaser acquiring a thing by mancipation; for one of its earliest manifestations was in the edict of the aedile, where the vendor who insisted on it from persons selling slaves, probably because the dealers were for the most part foreigners, and therefore unable to complete their sales *per aes et libram*. Judging from Varro, it was a form of stipulation against eviction that in his time was used only in sales of slaves, although he adds that by agreement of parties it might be limited to a *simpulum*.

There were also stipulations against vices in the object sold. We learn from Varro—that is also indicated in various passages of Plautus—that the vendor at the same time, and in the body of the same *stipulatio duplae* guarantee, that the sheep or cattle he was selling were healthy and of a healthy stock and free from faults,

and that the latter had not done any mischief for which their owner could be held liable in a noxal action; and similarly that a slave sold was healthy and not chargeable for any theft or other offence for which the purchaser might have to answer. If any of these guarantees turned out fallacious, the purchaser and an *actio ex stipulatu* against the vendor. Where the plaintiff was the defendant a stipulation that certain sheep be bought from him were healthy, &c. (repeating the words of guarantee), and that he, the plaintiff, should be free to hold them (*habere licere*), whatever it shall appear that the defendant ought in respect thereof to give or do for the plaintiff, in the value thereof, judge, condemn him; otherwise, acquit him." It is an observation of Bekker's⁴ that the *actio empti* in its original shape was just a simplification of the *actio ex stipulatu* on a vendor's guarantees; the *actio empti* was substituted in its place, because such unfulfilling accompaniments of a sale as to be matters of legal presumption, the result being that the words "whereas this plaintiff bought from the defendant the sheep about which the action has arisen" were substituted in the *demonstratio* (as the introductory clause of the formula was called) for the detailed recital of what had been stipulated. Bekker justifies this by reference to the language of Varro, who seems to include under the words *emptio, venditio* not merely the agreement to buy and sell but also the stipulatory contract generally supposed to be a mode of carrying the property of some other machinery had to be resorted to than that of the copper and the scales for imposing upon the vendor an obligation of warranty against eviction, defects and so forth. What it was is a question much controverted among modern writers. It may be that, until trade began to assume considerable proportions, and when a transaction was between citizens, a purchaser was content to rely partly on the honesty of his vendor, partly on the latter's knowledge that he ran the risk of an action for theft if what he sold belonged to another; and partly on the maxim common in all ages and climes, *caveat emptor*. When it was one between a citizen and a peregrin, a different set of rules of course came into operation; for between them disputes were settled by actions *in factum* before recuperators, whose decisions were arrived at very much on considerations of natural equity. On the whole, while admitting it to be quite maintainable that the urban praetors, under the influence of *ius gentium*, granted *arbitria* for enforcing obligations of parties in sales *inter cives* even a good while prior to the *actio empti*, the *actio empti* was, in this sense, in favour of the venditor that it was the popularization of the stipulation that facilitated the development of sale into a *bonae fidei* contract.

The introduction of an *actio empti* in this shape, however, was far from the recognition of sale as a purely consensual contract. If the price was not paid at once, the purchaser gave his stipulatory promise for it, or got some one on whom the vendor placed more reliance to do so for him, or else the vendor made a book-debt of it; and, if it had to be sued for, it was in all these cases by a *condictio pecuniae* and not by an action on the sale. If the price was paid but the thing purchased not delivered, the only remedy open to the purchaser was to get back his money by the same conduction, unless, indeed, the guarantee *habere licere* was held to cover delivery, in which case the purchaser might obtain damages in an *actio ex stipulatu* under the name of *actio empti*. But this *actio empti*, whether raised on the ground of non-delivery, eviction or breach of some other warranty, was really an action on the verbal contracts that had accompanied the sale—a *strictum jus* action in which the judge could not travel beyond the letter of the engagements of the purchaser. In the latter case, the republic, and probably a little before the time of Q. Mucius Scaevola, it was a *bonae fidei* action. How had the change come about? A single case of hardship may have been sufficient to induce it, such as the defeat of a claim for damages for eviction on the ground that the stipulatory guarantee had been accidentally overlooked. Ulpian says: "As the *stipulatio duplae* is a thing of universal observance, action on the ground of eviction will lie *ex emptio* if perchance the vendor of a slave have failed to give his stipulatory guarantee, for everything that is of general custom and practice ought to be in view of the judge in a *bonae fidei* judgment."⁵

Very little was required to convert the *stricti juris actio empti*, really nothing more than an *actio ex stipulatu*, into a *bonae fidei* one—simply the addition by the praetor of the words "on considerations of good faith" (*ex fide bona*) to the "whatever the defendant ought to give to or do for the plaintiff." The effect, however, was immeasurable—not that it did away with the practice of stipulatory guarantees, for Varro wrote after the time of Q. Mucius who speaks of the action on sale as a *bonae fidei* one), and references to them are abundant in the pages of the classical jurists; but it rendered them in law unnecessary. It made sale a purely consensual contract in which, in virtue of the simple agreement to buy and sell, all the obligations on either side that usually attended it were held embodied without express formulation or (still less) stipulatory or literal engagement. And, in instructing the judges to decide in every case between buyer and seller *suing ex emptio* or *ex venditio* on principles of good faith, it really empowered them to go beyond the letter of the general custom and practice, and to take cognisance of everything that in fairness and equity would commonly seem ought to influence their judgment, so as to enable them freely to do justice between the parties in any and every question that might directly or indirectly arise out of their relation as seller and buyer.⁶

The history of the four nominate real contracts—*mutuum* (i.e. loan of money or other things returnable generically), *commodate* (i.e. loan of things that had to be returned specifically), *Real deposit* and *pledge*—is even more obscure than that of the consensual ones.⁷ Down to the time of the Pothian law books (morning corn, &c., was usually contracted *per aes et libram*; and it is probable that on the subsequent disuse of the *nexum* the

Origin of
actio empti.

¹ Cicero says (*De Off. iii.* 16, § 65) that, though by the XII. Tables it was enough if a vendor *per aes et libram* made good his positive assurances (*uti lingua nuncupasset, isto ius esto*), the jurists held him responsible for reticence about burdens or defects he ought to have revealed, and liable for a *poena dupli* exactly as if he had guaranteed their non-existence.

² *In rebus mobilibus . . . qui alienam rem vendidit et tradidit furtum committit* (Caj. l. 50).

³ See Lenel, *Edict. Perpet.* 2nd ed. p. 521.

⁴ Bekker, *Actiones* (1871), i. 156 seq. and 314 seq.

⁵ Ulp., "Lib. I. ad. aedil." in *Dig.* xxi. 1, fr. 31, § 20.

⁶ The above view is supported in the main by Girard, *Manuel*, 524 seq. For other views see Pernice, *Laube*, i. 456 seq.; Cuij, *Inst. Juris*, 2nd ed. vol. i. pp. 226 seq.

⁷ Demelius, in the *Zeitschr. f. Rechtsgesch.* (1863), ii. 217 seq.; Bekker, *Actiones*, 308 seq.; and in the *Zur Gesch. der antiken Realcontracte* (Marburg, 1876), p. 10. Huschke, *Lehre vom Darlehen* (Leipzig, 1882); Girard, *Manuel*, 4th ed. pp. 505 seq.

obligation on a borrower to repay the money or corn advanced to him was made actionable, under the Silian and Calpurnian laws respectively, by a stipulation contemporaneous with the loan. With the rise of *ius gentium* loan became actionable on its own merits—that is to say, the advance and receipt of money as a loan of itself laid the borrower under a *stricti juris* obligation to repay it, even though no stipulatory engagement had intervened; the *res*—in this case the giving and receiving *mutui causa*—completed the contract. The obligation that arose from it was purely unilateral, and enforceable with a sum of money, by the same action—*actio certae pecuniae creditae*—as stipulation and literal contract; and so strictly was it construed that interest on the loan was not claimable along with it, the *res* given and received being the full measure of the obligation of repayment. The other three—commodate, deposit and pledge—became independent real contracts much later than *mutuum*, possibly not all at the same time, and none of them apparently until very late in the Republic. All of them, of course, had been long known as transactions of daily life; the difficulty is to say when they first became actionable in the urban praetor's court (for in transactions with peregrins actions *in factum* would doubtless be granted), and under what guise.

It is impossible within the space at our command to criticize the various theories entertained of their vicissitudes, for they necessarily vary to some extent in regard to each. We must content ourselves, therefore, with the simple statement that eventually, and within the period with which we are now dealing, they came to be recognized as independent real contracts, the *res* by which they were completed being the delivery of a thing by one person to another for a particular purpose, on the understanding that it was to be returned when that purpose was served. And it is to be noted that, while *mutuum* transferred the property, it is not to be held that the borrower was bound to return not the identical coins but only an equal amount, in pledge it was only the possession that passes, while in commodate and deposit the lender or depositor retained both property and (legal) possession, the borrower or depositor having nothing more than the natural detention. In all but *mutuum*, therefore, there was trust; the holder was bound, to an extent varying according to circumstances, to care for what he held as if it were his own, and entitled to be reimbursed for outlay on its maintenance—bound to return it, yet excused if his failure to do so was due to a cause for which he was not to be held responsible. Consequently the actions on these three contracts, differing from that on *mutuum*, were all *bonae fidei*, the judge being vested with full discretion to determine what was fair and equitable in each individual case.

Praetorian Amendments on the Law of Succession.—The most important change in the law of succession during the latter half of the Republic was due to the praetors. They introduced, under

the technical name of *bonorum possessio*,¹ what was really beneficial enjoyment of the estate of a deceased person without the legal title of inheritance. There is much to be learned from the conclusion that the series of provisions in regard to it which we find in the Julian consolidation of the Edict were the work of a succession of praetors, some of them probably not under the Republic but under the Empire; but it will be convenient to give here a general view of the subject as a whole, disregarding the consideration that some of its features may not have been given to it within the period now under notice.

Justinian, speaking of the origin of *bonorum possessio*, observes that in promising it to a petitioner the praetors were not always actuated by the same motives; in some cases their object was to facilitate the application of the rules of the *ius civile*, in others to amend the application according to what they believed to be the spirit of the XII. Tables, in others, again, to set them aside as inequitable.² It is not unreasonable to assume that it was with the purpose of aiding the *ius civile* that the first step was taken in what gradually became a momentous reform; and it is probable that this first step was the announcement by some praetor that, where there was dispute as to an inheritance, and a testament was presented to him bearing not fewer seals than were required by law, he would give possession of the goods of the defunct to the heir named in it.³ In this as it stands there is nothing but a regulation of possession of the *bona* of the inheritance pending the

question of legal right. Just as between two parties contending about the ownership of a specific thing in a *rei vindicatio* the praetor first settled the question of interim possession, so did he promise to do here when a question was about to be tried about the right to an inheritance (*si de hereditate ambigiatur*). It was a provisional arrangement merely, and very necessary in view of the state of the law which permitted a third party, apart from any pretence of title, to step in and complete a *usuceptio pro herede* by a year's possession of the effects of the inheritance. Even at the time when the Edict was closed it was necessarily more than a provisional grant; for, if heirs-at-law of the deceased appeared and proved that, although the testament bore on the outside the requisite number of seals, yet in fact some solemnity of execution, such as the *familiae venditio* or *testamenti nuncupatio*, had been omitted, the grantee had to yield them up the possession that had been given him pending inquiry. It was only by a rescript of Antoninus Pius that it was declared that a plea by the heir-at-law of invalidity of a testament on the ground of defect of formalities of execution might be defeated by an *exceptio doli*, on the principle that it was contrary to good faith to set aside the wishes of a testator on a technical objection that was purely formal. Thus was the *bonorum possessio secundum tabulas*, i.e. in accordance with a testament, from being originally one in aid of the *ius civile*, in course of time converted into one in contradiction of it. That the motives and purposes of the series of praetors who built up the law of *bonorum possessio* must have varied in progress of years is obvious; and, once the machinery had been invented, nothing was easier than to apply it to new ideas. The praetor could not make a man heir—that he always disclaimed; but he could give a man, whether heir or not, the substantial advantages of inheritance, and protect him in his enjoyment by praetorian remedies. By giving him possession of the goods of the deceased with summary remedies for gathering them, which, once in his hands, would become his in quiritarian right on the expiry of the period of usucaption; and subsequently, by interpolation into the formula of a fiction of heirship, he gave him effectual personal actions against debtors of the deceased, rendering him liable in the same way to the deceased's creditors.

Another variety of the *bonorum possessio* was that *contra tabulas*—in opposition to the terms of a testament. If a testator had neither instituted nor expressly disinherited a son who was one of his *sui heredes*, then his testament was a nullity, and the child passed over his own goods to the deceased's heirs. When *sui heredes* other than sons were passed over by the *ius civile* upheld the will but allowed them to participate with the instituted heirs by a sort of accrual. But the Edict went further; for, if the institute was a stranger, i.e. was not a person in the *potestas* of the testator with the child passed over, then, on the petition of the latter, the praetor gave him and any other *sui* concurring with him possession of the whole estate of the deceased as on intestacy, the institute being left with nothing more than the empty name of heir. Another application of the *bonorum possessio contra tabulas* was to the case of emancipated children of the testator. By the *ius civile* he was not required to institute or disinherit them; for by their emancipation they had ceased to be *sui heredes*, and had lost that interest in the family estate which was the reason why they had to be mentioned in the testament of their *paterfamilias*. The praetors—although probably not until the empire, and when the doctrines of the *ius naturale* were being more freely recognized—put them on the same footing as unemancipated children, requiring that they also should be either instituted or disinherited, and giving them *bonorum possessio* if they were not. It was *contra tabulas* in the sense that it displaced the instituted heirs either wholly or partially—wholly when the institute was a stranger, partially when they were. In the latter case, at least when said or affected by it, the grant of *bonorum possessio* was under the equitable condition that the grantees should collate or bring into partition all their own acquisitions since their emancipation.

The third variety of *bonorum possessio* was that granted *ab intestato*. The rules of the *ius civile* in reference to succession on intestacy were, as we have seen, extremely strict and artificial. They admitted neither emancipated children *Ab intestato*, nor agnates who had undergone *capitis deminutio*; they admitted no female agnate more remote than a sister; if the nearest agnate was agnate of a kindred, the right died to those of the next degree, were cognates, kinsmen of the deceased who were not agnates, e.g. grandchildren or others related to him through females and agnates *capite minuti*, were not admitted at all; while a wife had no share unless she had been in *manu* of the deceased and therefore *filiae loco*. All these rules the praetors amended, and so far paved the way for the revolution in the law of intestate succession which was accomplished by Justinian.

They established four orders or classes of heirs. (1) Displacing the *sui heredes* of the *ius civile*, they gave the first place to descendants (*liberi*), including in this term all those who the deceased would have been bound either by the *ius civile* or the Edict to institute or disinherit had he made a will, i.e. his wife in *manu*, sons and daughters of his body whether in *potestate* at his death or emancipated, the representatives of sons who had predeceased him, and adopted children in his *potestas* when he died. (2) On failure

¹ For a résumé of the principal theories (down to 1870) about the origin of *bonorum possessio*, see Danz, *Geschichte d. röm. Rechts*, vol. ii. § 176. Of the later literature it is enough to mention Leist, in the first 4 vols. of his continuation of Glück's *Pandecten-Commentar* (Erlangen, 1870-1879); Sohm, in *Z. d. r. R.* (Eng. trans., 2nd ed.), pp. 580 seq.; A. Schmidt, in *Z. d. Sav. Stif.* xvii. 324 seq. ² Inst. iii. 9 pr. and § 1.

³ Cic., *In Ver.* II. i. 45, § 117. He says (writing in 70 B.C.) that an edict to that effect was already *traditum*, i.e. had been adopted year after year by a series of praetors. Gaius (ii. 110) speaks of seven at least as the requisite number of seals, i.e. probably those of the *libripens* and the five citizen witnesses, and that of the *entestatus*, whose functions are not well understood, but whose official designation appended to his seal recurs so regularly in inscriptions as to leave no doubt that his was originally the seventh.

of *liberi* the right to petition for *bonorum possessio* opened to the nearest collateral agnates of the intestate, under their old name of *legitimi heredes*. (3) Under the *jus civile*, on failure of agnates (and of the *gens* where there was one), the succession was vacant and fell to the *res*, unless perchance it was usurped by a stranger possessing *pro herede*. The frequency of such vacancies was much diminished by the recognition by the praetors of the right of cognates to claim *bonorum possessio* in the third place. Who they had primarily in view under the name of "cognates" it is impossible to say. The epithet is most frequently applied by modern writers to kinsmen related through females; but in its widest sense it included all kinsmen without exception, and in a more limited sense all kinsmen not entitled to claim as agnates. There were included amongst them therefore—although it is very probable that the list was not made up at once, but from time to time by the action of a series of praetors—not merely kinsmen related through females (who were not agnates), but also agnates of a remoter degree who were excluded as such because the nearest agnates in existence had declined, persons who had been agnates but by reason of *capitis minutio* had lost that character, female agnates more distantly related than sisters, and children of the intestate who at the time of his death were in an adoptive family. All these took according to proximity, but not beyond the sixth degree and the children of a second cousin in the seventh. (4) Finally, the claim passed to the survivor of husband and wife, assuming always that their marriage had not involved *manus*. This list constituted the praetorian order of succession on intestacy among freeborn citizens. The praetorian order of succession to freedmen and *emancipati* was necessarily different, the patron or quasi-patron taking the place of agnates; but it is too detailed and complex to be gone into here.

All these *bonorum possessiones* had to be formally petitioned for. In that *ab intestato* descendants were allowed a year for doing so, while other persons were limited to 100 days, the period for those entitled in the second place beginning when that of those entitled in the first had expired, and so on. The grant was always made at the risk of the petitioner; nothing was assured him by it; it might turn out real and substantial (*cum re*) or merely nominal (*sine re*), according as the grantee could or could not maintain it against the heir of the *jus civile*. For the latter was entitled to stand on his statutory or testamentary right, without applying to *bonorum possessio*, although in fact he often did so for the sake of the summary procedure it supplied him for ingathering the effects of the deceased.

The Law of Procedure.—The use of the formular system of procedure as alternative to that by the "actions of the law" commenced long before the end of the period now under consideration; and we have had occasion more than once to observe how greatly it facilitated the development of the institutions of property and contractual obligation. But as the change was only completed in the early Empire it will be more convenient to defer explanation of the nature of the new procedure in the meantime.

IV. THE JUS NATURALE AND MATURITY OF ROMAN JURISPRUDENCE

(The Empire until the time of Diocletian.)

i. Characteristics and Formative Agencies of the Law during the Period.

Characteristics generally and Recognition of a Jus Naturale in Practice.—The first three centuries of the Empire witnessed the perfection of Roman jurisprudence and the commencement of its decline. During that time the history of the law presents no such great landmarks as the enactment of the XII. Tables, the commencement of a praetor's edict, the recognition of simple consent as creative of a contractual bond, or the introduction of a new system of judicial procedure; the establishment of a class of patented jurists speaking as in a sense the mouthpieces of the prince, and the admission of all the free subjects of the Empire to the privileges of citizenship, are about the only isolated events to which one can point as productive of great and lasting results. There were, indeed, some radical changes in particular institutions, such as the caducary legislation of Augustus, intended to raise the tone of domestic morality and increase fruitful marriages, and the legislation of the same emperor and his immediate successor for regulation of the status of enfranchised slaves; but these, although of vast importance in themselves, and the first of them influencing the current of the law for centuries, yet left upon it no permanent impression. It was by much less imposing efforts—that it attained the perfection

to which it reached under the sovereigns of the Severan house—a steady advance on the lines already marked out in the latter years of the Republic. The sphere of the *jus Quiritium* became more and more circumscribed, and one after another of the formalities of the strict *jus civile* was abandoned. The *manus* of the husband practically disappeared; the *patria potestas* of the father lost much of its significance by the recognition, notwithstanding it, of the possibility of a separate and independent estate in the child (*peculium castrense*); slaves might be enfranchised to a certain extent by informal manumission; *res mancipi* constantly passed by simple tradition, the right of the transferee being secured by the Publician action; servitudes and other real rights informally constituted were maintained as effectual *in iustione praetoris*; an heir's acceptance of a succession could be accomplished by any indication of his intention, without observance of the formal *cretio* of the earlier law; and many of the incidental bargains incident to consensual contract, but varying their natural import, that used to be embodied in words of stipulation, came to be enforceable on the strength of formless contemporaneous agreements.

The preference accorded by the magistrates and jurists and judges to the *jus gentium* over the *jus civile* is insufficient to account for these and many other changes in the *Idea of same direction*, as well as for the ever-increasing *Idea of a tendency evinced to subordinate word and deed to the voluntas* from which they arose. They are rather to be attributed to the striving on the part of many after a higher ideal, to which has been given the name of *jus naturale*.¹ It is sometimes said that the notion of a *jus naturale* as distinct from the *jus gentium* was peculiar to Ulpian, and that it found no acceptance with the Roman jurists generally. But this is inaccurate. Justinian, indeed, has excerpted in the *Digest* and put in the forefront of his *Institutes* a passage from an elementary work of Ulpian's, in which he speaks of a *jus naturale* that is common to man and the lower animals, and which is substantially instinct. This is a law of nature of which it is quite true that we find no other jurist taking account, and it may be attributed to a habit, specially noticeable in Ulpian's writings, of making tripartite classifications. But though the classical jurists are undoubtedly indistinct in their conceptions about the matter, many of them refer again and again to *jus naturale* in the sense of law based on natural reason; and Gaius is the only one (Justinian following him) who definitely, though not consistently, makes it synonymous with *jus gentium*. There can be no question that the latter was much more largely imbued with precepts of natural law than was the *jus civile*, but it seems incorrect to say that natural law and *jus gentium* were identical; it is enough to cite but one illustration, pointed out again and again in the texts: while the one admitted the legality of slavery, the other denied it. While the *jus civile* studied the interests only of citizens, and the *jus gentium* those of freemen irrespective of nationality, the law of nature had theoretically a wider range and took all mankind within its purview. The doctrine of the *jus gentium* agreed in this respect with that of the *jus civile*—that a slave was nothing but a chattel; yet we find the latter, when tinted with the *jus naturale*, recognizing many rights as competent to a slave, and even conceding that he might be debtor or creditor in a contract, although his obligation or claim could be given effect to only indirectly, since he could neither sue nor be sued.²

Voigt thus summarizes the characteristics of this speculative Roman *jus naturale*:—(1) its potential universal applicability to all men, (2) among all peoples, (3) at all times, and (4) its correspondence with the innate conviction of right (*innere Rechtsüberzeugung*).³ Its propositions, as gathered from the pages of the jurists of the period, he formulates thus:—(1) recognition of the claims of blood (*sanguinis vel cognationis ratio*); (2) duty of faithfulness to engagements—is

¹ See Voigt, *Das Jus naturale*. . . der Römer, particularly vol. i. §§ 52-64, 89-96; Maine, *Ancient Law*, chap. iii.

² Ulp. in *Dig.* xlv. 7 fr. 14.

³ Voigt, *l.c.* p. 304.

of *legis actiones*. The one regulating procedure in private suits at Rome must have been a somewhat comprehensive statute, as a passage in the *Vatican Fragments* refers to a provision of its 27th section; and our ignorance of its contents therefore, beyond one or two trifling details, is the more to be regretted. The opinion of Wlassak, already referred to, is that the Aebutian laws made procedure by formulae compulsory, while the Aebutian law had left it optional. In all cases omitted to a *ius iudicis* or such private judge as a formula was to be henceforth compulsory; a *legis actio* could no longer be tried before private judges but only exceptionally by the centumviral court.¹

From the time of Tiberius onwards it was the senate that did the work of legislation, for the simple reason that the *comitia* were no longer fit for it. And very active it seems to have been. This may have been due to some extent to the fact that so many professional jurists, aware from their practice of the points in which the law required amendment, possessed seats in the imperial council, where the results of the senatus-consulta were prepared. It was the senatus-consulta that were the principal statutory factors of what was called by both emperors and jurists the *ius novum*—law that departed often very widely from the principles of the old *ius civile*, that was much more in accordance with those of the Edict, and that to a great extent might have been introduced through its means had not the authority of the praetors been overshadowed by that of the prince. In the end of the 2nd and the beginning of the 3rd century the supremacy of the latter in the senate became rather too pronounced, men quoting the *oratio* in which he had submitted to it a project of law instead of the reason why he gave it the *legis auctoritas*. No opinion of such projects must have been carefully considered beforehand in the imperial council, and rarely stood in need of further discussion; but the ignoring of the formal act that followed it tended unduly to emphasize the share borne in it by the sovereign, and made it all the easier for the emperors after Severus Alexander to dispense altogether with the time-honoured practice.

The Consolidated Edictum Perpetuum.—The edicts of the praetors, which had attained very considerable proportions before the fall of the Republic, certainly received some additions in the early Empire. But those magistrates did not long enjoy the same independence of action. The emperor was the master rather than the slave in the state, before which they hesitated to lay hands on the law with the boldness of their predecessors. They continued as before to publish annually at entry on office the edicts that had been handed down to them through generations; but their own additions were soon almost limited to mere amendments rendered necessary by the provisions of some senatusconsult that affected the *ius honorarium*. They ceased to be that *viva vox iuris civilis* which they had been in the time of Cicero; the emperor, if any one, was now entitled to the epistle; the annual edict had lost the *ratione dicitur*. Hadrian especially was so opinionated that the time he had come for writing it "explicit," and giving it another and more enduring and authoritative shape, binding on all future magistrates. He accordingly, it is said, commissioned Salvius Julianus to revise it—or Julian, when urban praetor, may have done so at his own hand with the emperor's approval—and the senate gave it binding force. It did not, however, become statute law; the distinction between *ius civile* and *ius praetorium* still continued.

The revised Edict unfortunately, like the XII. Tables, is no longer extant. It is only a very slight account we have of the revision—a line or two in Eutropius and Aurelius Victor, and a few lines in two of Justinian's prefaces to the Digest. We may assume from what is said there that both abridgment and rearrangement of the edicts of the urban praetor took place, but the question remains how far Julian consolidated with them those of the peregrin praetor and other officials who had contributed to the *ius honorarium*. Those of the curule aediles, we are told, were included; Justinian says that they formed the last part of Julian's work; they formed, in fact, a sort of addendum to it. There is reason to believe that so much of the edicts of the provincial governors as differed from those of the praetors were also incorporated in it, and that the edicts of the peregrin praetors, in so far as they contained available matter not embodied in those of their urban colleagues or the provincial governors, were dealt with in the same way.² The consolidation got the name of *Edictum Perpetuum* in a sense somewhat different from that formerly imputed to *edicta perpetua* as distinguished from *edicta repentina*; it became perpetual in the English sense of the word. Sanctioned by senatusconsult and by the emperor, it became a closed chapter so far as the praetors were concerned; for, though it continued for a time to hold its place on their album with its formularies of actions, they had no longer any power to alter

or even perhaps make additions to it. Having ceased to be a mere efflux of their *imperium* and become a type prescribed by statute, its interpretation and amendment were no longer in their hands but in the hands of the emperor.

The Julian Edict was not divided into parts or books like Justinian's Digest but only into titles, which were perhaps numbered and certainly were rubricated. Since the publication of Lenel's great work, noted below, modern Romanists are agreed that the formularies of actions it contained were distributed in their appropriate places throughout the work and not collected together in one place as used to be supposed. Thus a formula based on the civil law (e.g. the *rei vindicatio*) appeared by itself (*i.e.* without any edict) as a separate head or subdivision of the title appropriate to it; while formulae based on the praetor's *imperium* (e.g. that of the praetorian action *de dolo*) were placed under their respective edicts. The general arrangement of the subject-matter is not difficult to discover, as we have documentary evidence to a certain extent in writings which we come down to us. These are principally (1) the Digest of Justinian in the prefaces to which we are told expressly that it followed the order of the Edict except in certain places specially noticed; (2) the Code of Justinian; (3) the extracts from divers commentaries on the Edict by the classical jurists principally preserved in the Digest. As the inscriptions of these extracts contain the name of the author, the work and the particular book from which they are taken, they have proved of great help towards understanding the arrangement—especially the commentaries of Ulpian and Paul on the urban edict and the commentary of Gaius on the provincial edict. Lenel has shown that Justinian's *Digest* was another logical and orderly system, but adhered in great measure to the old order (tralatitious) of the urban praetors. The following fourfold division of the subject-matter is, according to Lenel (partially following Rudorff), clearly ascertainable: first, a series of titles dealing with the preliminary steps in all actions such as jurisdiction, summons, intervention of procurators and the like; second, titles dealing mainly with matters of ordinary procedure or rather with actions granted principally in accordance with statute (*iudicia legitima* as *pebatio hereditatis*, *rei vindicatio*, &c.); third, titles dealing with actions resting principally on the magistrate's *imperium* (*iudicia imperii* or *consentia*); fourth, execution judgments, including bankruptcy, &c. These four parts were followed by a kind of appendix containing in three titles the separate styles of interdicts, exceptions and praetorian stipulations. Finally, the edicts of the curule aediles, with their formulae also consolidated, were added at the end of the work. From the fragments of the jurists preserved by Justinian (principally from the three above-mentioned commentaries, but also to an important extent from Julian himself in his *Digesta*) repeated attempts have been made in modern times to reproduce the Edict in its entirety. Most of these are mere transcripts with attempted reconstructions of the passages in Justinian's Digest which are of value; but the really scientific and worthy critical efforts are those of Rudorff in 1869 and, above all, of Lenel in 1883.³

The Responses of Patented Counsel.—The right of responding under imperial authority (*ius respondendi ex auctoritate principis*), first granted by Augustus and continued by his successors down to about the time of Severus Alexander, did not imply any curtailment of the right of unlicensed jurists to give advice to any one who chose to consult them. What it did was to give an authoritative character to a response given by the jurist who had asked for it and to whom it was presented—for the judges were but private citizens, most of them unlearned in the law—was practically bound to adopt it as if it had emanated from the emperor himself. It may be that Augustus was actuated by a political motive—that he was desirous by this concession to attach lawyers of eminence to the new régime, and prevent the recurrence of the evils experienced during the Republic from the too great influence of patrons. But, whatever may have prompted his action in the matter, its beneficial consequences for the law can hardly be overrated. For the powers with which they were invested enabled the patented counsellors to influence curule doctrine, not speculatively merely but positively (*iura condere*), and so to leave their interpretations of the *ius civile* and *ius honorarium* with the principles of natural law as to give a new complexion to the system.

Instead of giving his opinion like the unlicensed jurist by word of mouth, either at the request of the judge or at the instance of one of the parties, the patented counsel, who did not require to

Responses
of
Patented
Counsel
(*Juris
consulti*).

³ Rudorff, *De iurisdictione edictum: edicti perpetui quae reliqua sunt* (Leipzig, 1869), and rev. by Brinz in the *Krit. Vierteljahrsschrift* (1870), xi. 471 sqq.; Lenel, *Das Edictum Perpetuum: ein Versuch aus dessen Wiederherstellung* (Leipzig, 1883), 2nd ed., 1907 (French ed. translation by Peltier, 2 vols., 1901-3). The last gained the "Savigny Foundation Prize" offered by the Munich Academy in 1882 for the best restitution of the formulae of Julian's Edict, but goes far beyond the limited subject prescribed; see Brinz's *see* Lenel's *op. cit.* p. 118. See also Siffrid, *op. cit.* Siffrid, (188), vol. iv. *Röm. Abh.*, 164 sqq. See Karlowa, *Röm. Rechtsgesch.*, i. 628-81; Krüger, *Gesch. d. Quellen*, 84 sqq.

¹ Wlassak, *Processgesetz*, i. 191 sqq., and ii. 221 sqq.

² It may be, however, that the edicts of the peregrin praetors and provincial governors were independently codified. See Girard, *Manuel élémentaire*, 4th ed. 53-4. An attempt recently made by von Velsen, *Z. d. Sar.*, 51. xxxi. (1909), 73 sqq., to identify the *edictum provinciale* with that of the peregrin praetor prior to the time of Augustus is far from convincing and has received no support from other writers. See Kipp, *Gesch. d. Quellen*, p. 123 n¹.

give his reasons, reduced it to writing and sent it to the court under seal. Augustus does not seem to have contemplated the possibility of conflicting responses being tendered from two or more jurists equally privileged. It was an awkward predicament for a judge to be placed in. Hadrian solved the difficulty by declaring that in such a case the judge should be entitled to use his own discretion.¹ That on receiving a response with which he was dissatisfied he could go on calling for others until he got one to his mind, and then pronounce judgment in accordance with it on the ground that there was difference of opinion, is extremely unlikely. The more probable explanation of Hadrian's rescript is, that the number of patented responding counsel was very limited; that a judge, if he desired their assistance, was required by this rescript to consult them all (*quorum omnium si, &c.*); that, if they were unanimous, but only then, their opinion had force of statute (*legis habetur*); and that when they differed the judge must decide for himself.

*Constitutions of the Emperors.*²—Gaius and Ulpian concur in holding that every imperial constitution, whether in the shape of rescript, decree or edict, had the force of statute. It may be that by the time of Ulpian that was the prevailing opinion; but modern criticism is disposed to regard the dictum of Gaius, written in the time of Antoninus Pius, as coloured by his Asiatic notions, and not quite accurate so far as the force of the rescript is concerned. As for the *leges datee* (*leges datee*), the early imperial edicts were theoretically rather part of the *jus honorarium*. As supreme magistrate the emperor had the same *jus edicendi* that consuls and praetors had had before him, and used it as they did to indicate some course of action he meant to adopt and follow or some relief he proposed to grant. His edicts were as a rule drawn up in writing in the imperial council and publicly notified in all parts of the Empire. His range, of course in respect of his *imperium*, was much greater than that of the praetors had been for his authority endured for life, and extended over the whole Empire and every department of government. But in principle, it is thought, his successor on the throne was no more bound to adopt any of his edicts than a praetor was to adopt those of his predecessors. That it was not unusual for an edict to be renewed, and that it occasionally happened that the renewal was not by the immediate successor of its original author, are manifest from various passages in the texts. Sometimes, when its utility had stood the test of years, it was transmuted into a *senatusconsultum*; this fact proves of itself that an edict *per se* had not the effect of statute. But their adoption by a succession of two or three sovereigns, whose reigns were of average duration, may have been held sufficient to give them the character of consuetudinary law; and, by a not unnatural process, unreflecting public opinion may have come to impute force of statute to the edict itself rather than to the *longa consuetudo* that followed on it, thus paving the way for the assertion by the sovereigns of the later Empire of an absolute right of legislation, and for the recognition of the *lex edictalis* as the only form of statute.

The imperial rescripts and decrees (*rescripta, decreta*) apparently acquired force of law (*legis vicem obtinent*) pretty early in the Empire, and their operation was not theoretically limited to the lifetime of the prince from whom they had proceeded. But they were not directly acts of legislation. In both the emperor theoretically did no more than authoritatively interpret existing law, although the boundary between interpretation and new law, sometimes difficult to define, was not always closely adhered to. Thus Decretum *Marci*, penalizing procedure by self-help, and the *epistula Hadriani*, introducing the *beneficium divisionis* among co-sureties, are notable instances of authoritative interpretation. The rescript was strictly a written answer by the emperor to a petition, either by an official or a private party, for an instruction as to how the law was to be applied in any particular case to the facts set forth: when the answer was in a separate writing it was usually spoken of as an *epistula*; when noted at the foot of the application its technical force was *subscriptum*. By some ancient orders of the emperors addressed to some official and intended for a province or particular community were classed under the head of rescripts. The decree was the emperor's ruling, orally announced, in a case submitted to him judicially; it might be when it had been brought before him in the first instance *extra ordinem*, or when it had been removed by *supplicatio* from an inferior court in its earliest stage, or when it came before him by appeal. Such decrees were duly

recorded and kept *apud acta*. It was theoretically as a judge that the emperor pronounced his decree, though in practice he sometimes went beyond the case in hand, evolving new doctrines. Proceeding as it did from the fountain of authoritative interpretation, the decree had a value far beyond that of the sentence of an inferior court (which was law only as between the parties), and formed a precedent which governed all future cases involving the same question. Those rescripts and decrees constituted one of the most important sources of the law during the first three centuries of the Empire, and were elaborated with the assistance of the most eminent jurists of the day, the rescripts being the special charge of the *magister libellorum*. From the time of the Gordians to that of the abdication of Diocletian they were almost the only channel of the *jus scriptum* that remained.

A fourth class of imperial constitutions were the so-called *mandata*. These, however, were mainly of the nature of instructions by the emperors to individual imperial officials, similar to edicts, and dealt with public law for the most part.

Professional Jurisprudence.—The present period of legal history is by modern writers sometimes called "the classical age of jurisprudence," though that term is more usually and correctly restricted to the years between Hadrian and the close of Severus Alexander's reign. It has been called "classical," on the analogy of the Augustan age of literature, from the celebrity of the jurists who flourished during it, and the scientific pre-eminence of their works. For accounts of the great jurists, see articles GAIVS, &c., and also H. J. Roby's *Introduction to the Study of Justinian's Digest* and Professor Karlowa's *Rechtsgeschichte*.⁴ For an account of the extant remains of their writings, such as the Institutes of Gaius, the Rules of Ulpian, the Sentences of Paul and a variety of other works, reference may be made to Muirhead's *Historical Introduction to the Private Law of Rome*, where a brief account of the jurists is also given.⁵

ii. Substantive Changes in the Law.

Concession of Peculiar Privileges to Soldiers.—While the period with which we are dealing saw the substantial disappearance of the distinction between citizen and peregrin, it witnessed the expansion of another—that between soldiers and civilians (*militis, pagani*). The most remarkable effluxes of the *jus militare* (as it is sometimes called) were the military testament and the *castrensium peculium*. The first was practically exempted from all the rules of the *jus civile* and the praetors' edict alike as to the form and substance of last wills. It might be in writing, by word of mouth, by the unspoken signs perhaps of a dying man; all that was required was the *voluntas* so manifested as not to be mistaken. More extraordinary still—it was sustained even though its provisions ran counter to the most cherished rules of the common law. Contrary to the maxim that no man could dispense with the institution of an heir or die partly testate and partly intestate, a soldier might dispose of part of his estate by testament with or without nomination of an heir, and leave the rest to descend to his heirs *ab intestato*. Contrary also to the maxim *semel heres semper heres*, he might give his estate to A for life or for a term of years, or until the occurrence of some event, with remainder to B. Contrary to the general rule, a Latin or peregrin, or an unmarried or married but childless person, might take an inheritance or a bequest from a soldier as freely as could a citizen with children. His testament, in so far as it disposed only of *bona castrensia*, was not affected by *capitis deminutio minima*. It was not invalidated by praeiteration of *sui heredes*, nor could they challenge it because they had less under it than their "legitim"; nor could the instituted heir claim a Falcidian fourth, even though nine-tenths of the succession had been assigned to legatees. Finally, a later testament did not nullify an earlier one, if it appeared to be the intention of the soldier testator that they should be read together.

¹ Cambridge, 1884, chaps. ix.—xv.

² Gaius, i. 7; Justinian, *Inst.* i. 2, § 8. The passages from Pomponius in *Dig.* i. 2, 2, §§ 48, 49 are of doubtful meaning, and different interpretations of them have been given. Cf. Sohm, *Institutionen* (translation by Ledlie, 2d ed.), p. 97; Girard, *Manuel*, p. 10; Kipp, *Geschichte d. R.*, § 99.

³ Gaius, i. Ulp., in *Dig.* i. 4, fr. 1, § 1; Mommsen, *Röm. Staatsrecht*, ii. 843 seq.; Wlassak, *Krit. Studien zur Theorie der Rechtsquellen im Zeitalter d. klass. Juristen* (Graz, 1884); A. Pernice (*crit.* Wlassak), in *Zeitschr. d. Sav. Stift.* (1885), vi. *Röm. Aethel.* 293 seq.; I. Karlowa, *Röm. Rechtsgesch.* i. § 85; Kipp, *Quellen*, 59 seq.

⁴ Leipzig, 1885, i. §§ 87–92. See also Krüger, *Geschichte d. Quellen*, §§ 18–27, and, for the period from Augustus to Hadrian, Bremer, *Jurisprudenz Antehadriana*, ii. l. Edited by Goudy, 1889, § 85. See also Krüger, *Geschichte d. Quellen*, §§ 18–27, level. *Palingenesia Juris Civitatis* (2 vols., Leipzig, 1888–9), a work which contains all the texts of the ante-Justinian jurists, as contained in the Digest and other sources, arranged systematically, with valuable critical and explanatory notes, but excluding the Institutes of Gaius, Paul's Sentences and Ulpian's Rules.

All this is remarkable, manifesting a spirit very different from that which animated the common law of testaments. True, it was a principle with the jurists of the classical period that the *voluntatis ratio* was to be given effect to in the interpretation of testamentary writings; but that was on the condition that the requirements of law as to form and substance had been scrupulously observed. But in the military testament positive rules were made to yield to the *voluntas* in all respects: the will was almost absolutely unfettered. Roman law in this matter gave place to natural law. One would have expected the influence of so great a change to have manifested itself by degrees in the ordinary law of testaments; yet it is barely visible. In a few points the legislation of Constantine, Theodosius II. and Justinian relaxed the strictness of the old rules; but there was never any approach to the recognition of the complete supremacy of the *voluntas*. In the *Corpus Juris* the contrast between the *testamentum pignus* and the *testamentum militare* was almost as marked as the days of Trajan. The latter was still a privileged deed, whose use was confined to a soldier actually on service, and if he received an honourable discharge, for twelve months after his retirement.

The *peculium castrense* had a wider influence; for it was the first of a series of amendments that vastly diminished the importance of the *pecunia* of the *patria potestas* on its patrimonial side. It had *Peculium* its origin in a constitution of Augustus granting to soldiers the *pecunia* *filii* in the active exercise of their profession (*quod in castris adquisierant*).¹ But it soon went much further. Confined at first to *filii* actually on actual service, the privilege was extended by Hadrian to those who had obtained honourable discharge. The same emperor allowed them not merely to test on their *peculium castrense*, but to manumit *inter vivos* slaves that formed part of it; and by a little step further the classical jurists recognized their right to dispose of it onerously or gratuitously *inter vivos*. In the 3rd century the range of it was extended so as to include not only the soldier's pay and prize, but all that had come to him, directly or indirectly, in connexion with his profession—his outfit, gifts made to him during his service, legacies from comrades and so on. All this was in a high degree subversive of the doctrines of the common law. It may almost be called revolutionary; for it involved in the first place the recognition of the right of a person *alieni juris* to make a testament as if he were *sui juris*, and in the second place the recognition of a separate estate in a *filiusfamilias* which he might hold independently of his *paterfamilias*, which could not be touched by the creditor's creditors and which he was not even bound to collate (or bring into hotch-pot) on claiming a share of his father's succession. The radical right of the parent, however, was rather suspended than extinguished; for, if the soldier son died intestate, the right of the *paterfamilias* revived: he took his son's belongings, not as his heir appropriating an inheritance, but as his *paterfamilias* reclaiming a *peculium*.²

The Family.—The legislative efforts of Augustus to encourage marriage, by which persons of position showed a remarkable distaste, have already been mentioned. The relation of husband and wife still in law required no more for its creation than deliberate interchange of nuptial consent, although in certain cases some act indicative of change of life, such as the bride's home-coming to her husband's house, was regarded as the criterion of completed marriage.³ But it was rarely accompanied with *manus*. So repugnant was such subjection to patrician ladies that they declined to submit to *confarreatio* nuptials; and so great consequently became the difficulty of finding persons qualified by *confarreatio* bride to fill the higher priesthoods that early in the Empire it had to be decreed that *confarreatio* should in future be productive of *manus* only *quoad sacra*, and should not make the wife a member of her husband's family. *Manus* by a year's uninterrupted cohabitation was long out of date in the time of Gaius; and, although that by coemption was still in use in his time, it was almost unknown by the end of the period. Husband and wife therefore had their separate estates, the common establishment being maintained by the husband, with the assistance of the revenue of the wife's dowry (*dos*)—an institution which received much attention at the hands of the jurists, and was to some extent regulated by statute. Divorce (either of common consent or by *repudium* by either spouse) was unfortunately very common; it was lawful even without any assignable cause; when blame attached to either spouse, he or she suffered deprivation to some extent of the nuptial provisions, but there were no other penal consequences.

Not only in the case of a *filiusfamilias* who had adopted a military career, but in all directions, there was manifested a strong tendency to give effect to the *voluntas* of the testator. This was due in a great degree to the hold that the principles of natural law were gaining within the Roman system. The heirs due

to the fact that the emperors, having succeeded to the censorial *regimen morum*, allowed these principles freely to influence their edicts and rescripts. Exposure of an infant was still apparently allowed; but a parent was no longer permitted, even in the character of household judge, to put his son to death or cruelly ill-treat him; in fact his prerogative was limited to moderate chastisement, the law requiring in the case of a grave offence that mortel severer punishment, that he should bring his child before the competent magistrate. His right of sale, in like manner, was permitted only when he was in great poverty and unable to maintain them, while their impignoration by him was prohibited under pain of banishment.

Except in the solitary case of a son who was a soldier, a *paterfamilias* was still recognized as in law the owner of all the earnings and other acquisitions of his children in *potestate*; but the old rule still remained that their civil debts he was not liable beyond the amount of the fund he had advanced to deal with as *de facto* their own (*peculium profectitium*), except when he had derived advantage from their contract or had expressly or by implication authorized them to enter into it as his agents. To the party with whom he had contracted a *filiusfamilias* was himself liable as fully as if he had been a *paterfamilias*, with one exception, namely, when his debt was for borrowed money; in that case, with some very reasonable qualifications, it was declared by the well-known Macedonian *senatusconsultum* (of the time of Vespasian) that the lender should not be allowed to recover his debt after the father had become *sui juris* by his father's death. Between a father and his emancipated son there was, and always had been, perfect freedom of contract; but so was there now between a father and his soldier son in any matter relating to the *peculium castrense*, even though the son was in *potestate*. What is still more remarkable is that the new sentiment which was operating on the *jus civile* admitted the possibility of natural obligation between *paterfamilias* and *filiusfamilias* even in reference to the *peculium profectitium*, which, though incapable of direct enforcement by action, was yet to some extent recognized and given effect to indirectly.

In the matter of guardianship, while the tutory of pupils was carefully maintained and the law in regard to it materially amended during the period under review (particularly by a *senatusconsultum* generally referred to as the *Oratio divi Severi*, prohibiting alienation of the ward's property without judicial authority), that of women above the age of pupillarity gradually disappeared.⁴ The guardianship or curatory (*cura*) of minors above pupillarity owed its establishment to a general *senatusconsultum* of Marcus Aurelius. The *Platorian law*⁵ of the middle of the 6th century of the Empire had indeed imposed penalties on those taking undue advantage of the inexperience of minors, i.e. persons *sui juris* under the age of twenty-five; and from that time the praetors were in the habit of granting *restitutio in integrum* in cases of lesion and appointing curators to act with such persons for the protection of their interests in particular affairs. But it was Marcus Aurelius that first made curatory a general permanent office, to endure in the ordinary case until the ward attained majority. The powers, duties and responsibilities of such curators became a matter for careful and elaborate definition and regulation by the jurists, whose exposition indeed of the law of guardianship generally, whether by tutors or curators, has found wide acceptance in modern systems of jurisprudence.

The Law of Succession and particularly Testamentary Trusts.—There were far more positive changes in the law of succession than in either that of property or that of obligation. The rise and progress of the military testament has already been explained. The testament of the common law was still ostensibly that *per aes et libram*; but the practice of granting *bonorum possessio secundum tabulas* to the persons named as heirs in any testamentary instrument that bore outside the requisite number of seals led, from the time of Antoninus Pius, to the frequent neglect of the time-honoured formalities of the *familiae mancipatio* and *nuncupatio testamenti*. It was his rescript, formerly mentioned, declaring that an heir-at-law should no longer be entitled to dispute the last wishes of a testator on the technical ground of non-compliance with the purely formal requirements of the law, that practically established what Justinian calls the praetorian testament.

One of the commonest provisions in the testaments of the period was the *fideicommissum*,—a request by the testator to his heir to enter on the inheritance and thereafter denude wholly or partially in favour of a third party. It was introduced in the time of Augustus by (it is said by Theophilus) a testator who had married a peregrin wife, and desired thus indirectly to give to his peregrin children the successions which, as not being citizens, they could neither take *per aes et libram* nor as direct testamentary heirs.⁶ It probably soon found imitators, and their number must have rapidly multiplied once the emperor, shocked at the perfidy of a trustee

¹ Inst. ii. 12 pr.

² This was altered by Justinian's 118th Novel, under which a *paterfamilias* taking any part of a deceased son's estate did so as his heir; see *infra*, p. 573.

³ Some writers take the view that such act was always essential. See Girard, *Manuel*, 4th ed. p. 151.

⁴ Dig. xxvii. 9 fr. 1, § 2.

⁵ Also sometimes called *lex Laetoria*. See, e.g. reference to a recently discovered papyrus in *Z. d. Sav. Stift.* xxii. 170.

⁶ *Fideicommissa*, as informal requests to heirs or legatees to hand over what they received to third parties, were known earlier than Augustus, but had no legal force.

who had failed to comply with the request of his testator, indicated his approval of the new institution by remitting the matter to the consuls of the day, with instructions to do in the circumstances what they thought just. So quickly did it establish itself in public favour, and so numerous did the questions become as to the construction and fulfilment of testamentary trusts, that under Claudius it was found necessary to institute a court specially charged with their adjudication—that of the *praetor fideicommissarius*.

The employment of a trust as a means of benefiting those who were under disqualifications as heirs or legatees, as, for example, persons who had no *testamentum factio*, women incapacitated by the *Vocianum* law, unmarried and married but childless persons, incapacitated by the Julian and Papia-Poppaean law, and so on, was in time prohibited by statute; but that did not affect its general popularity. For, whether what was contemplated was a transfer of the universal *hereditas* or an aliquot part of it to the beneficiary (*fideicommissum hereditatis*), or only of some particular thing (*fideicommissum rei singularis*), a testamentary trust had various advantages over either a direct institution or a direct bequest (*legatum*). Still the imposition upon the heir of a trust in favour of a beneficiary, whether it required him to denude of the whole or only a part of the inheritance, did not in theory deprive him of his character of heir or relieve him of the responsibilities of the position; and as common law therefore he was entitled to decline the succession, often to the great prejudice of the beneficiary. In order to avoid such a mischance, and at the same time to regulate their relations *inter se* and towards debtors and creditors of the testator, it became the practice for the parties to enter into stipulatory arrangements about the matter; but these were to some extent rendered superfluous by two *senatusconsults*, the *Trebellian* in the time of Nero and the *Pegasian* in that of Vespasian, which not only secured the beneficiary against the trustee's (*i.e.* the heir's) repudiation of the inheritance, but also protected the latter from all risk of loss where he was trustee and nothing more, and enabled the former to treat directly with debtors and creditors of the testator and himself in regard to the corporate items of the inheritance.

It was one of the advantages of a trust-bequest, whether universal or singular, that it might be conferred in a codicil, even though unconfirmed by any relative testament. The codicil (*codicilli*), also an invention of the time of Augustus, was a deed of a very simple nature. Though in the later Empire it required to be formally attested by at least five witnesses, it was at first quite informal. It was inappropriate either for disherison of *sui* or institution of an heir; but if confirmed by testament, either prior or posterior to its date, it might contain direct bequests, manumissions, nominations of tutors, and the like, and whether confirmed or unconfirmed might, as stated, be utilized as a vehicle for trust-gifts. Latterly it was held operative, even in the absence of a testament, the trusts contained in it being regarded as burdens on the heir-at-law.

The most important changes in the law of intestate succession during the period were those accomplished by the *Tertullian* and *Orphidian* *senatusconsults*, fruits of that respect for the precepts of natural law which in so many directions was modifying the doctrines of the *ius civile*. The first was passed in the reign of Hadrian, the second in the year 178, under Marcus Aurelius. Down to the time of the *Tertullian* *senatusconsult* a mother and her child by a marriage that was unaccompanied with *manus* stood related to each other only as cognates, being in law members of different families; consequently their chances of succession to each other was remote, being postponed to that of their respective agnates. The purpose of the *senatusconsult* was to prefer a mother to all agnates of her deceased child except father and brother and sister; father and brother excluded her; but with a sister of the deceased, and in the absence of father or brother, she shared equally. While there can be little doubt that it was considerations of natural law that dictated this amendment, yet its authors were too timid to justify it on the abstract principle of common humanity, and so they confined its application to women who had the *ius liberorum*, *i.e.* to women of free birth who were mothers of three children and freedwomen who were mothers of four, thus making it ostensibly a reward of fertility. The *Orphidian* *senatusconsult* was the counterpart of the *Tertullian*. It gave children, whether legitimate or illegitimate, a right of succession to their mother in preference to all her agnates; and subsequent constitutions extended the principle, admitting lawful children to the inheritance not only of their maternal grandparents but also to that of their paternal grandmother.

iii. Judicial Procedure.

The Formular System.—The ordinary procedure during the greater part of the first three centuries of the Empire was the *formular* two-staged; it commenced before the praetor (*in iure*)

Formular System. and was concluded before a judge or judges (*in iudicio*). But the *legis actiones* had with a few exceptions given place to praetorian formulae. Under the sacramental system parties,

and particularly the plaintiff, had themselves to formulate in statutory or traditional words of style the matter in controversy between them; and as they formulated, so did it go for trial to centumviral court or *iudex*, with the not infrequent result that it was then all too late discovered that the real point in the case had been missed. Under the formular system parties were free to represent their plaint and defence to the praetor in any words they pleased, the plaintiff asking for a formula and usually indicating the style on the *album* that he thought would suit his purpose, and the defendant demanding when necessary an exception, *i.e.* a plea in defence, either praetorian or statutory, that, without traversing the facts or law of the plaintiff's case, avoided his demand on grounds of equity or public policy or the like. It was for the praetor to consider and determine whether the action or exception should or should not be granted, and, if granted, whether it should be according to the style exhibited on the *album* or according to a modification of it. The result he embodied in a written and signed appointment of a judge, whom he instructed what he had to try, and empowered to pronounce a finding either condemning or acquitting the defendant. This writing was the formula.

Although it was not until the early Empire that this system of civil procedure attained its full development, yet it had begun between one and two centuries before the fall of the Republic. Gaius ascribes its introduction to a definitive establishment of the *lex Aebutiana* and two judiciary laws of the time of Augustus, formerly mentioned (*supra*, pp. 98, 124). The Aebutian law, of which unfortunately we know very little, is generally supposed to have empowered the praetors (1) to devise a simpler form of procedure for causes already cognizable *per legis actionem*, (2) to devise forms of action to meet cases not cognizable under the older system, and (3) themselves to formulate the issue and reduce it to writing. It was by no means so radical a change as is sometimes supposed. There were formulae employed by the peregrin praetor before it and also perhaps something analogous thereto by the urban praetor. There were also formulae of a kind employed both in the procedure *per iudicis postulationem*, and in that *per condemnationem*. The difference between the latter and the formulae of the Aebutian system was that they were in part mere echoes of the statutory words of style uttered by the plaintiff, and that they were not written but spoken in the hearing of witnesses.

A large proportion of the personal actions of the formular system were evolved out of the *legis actio per condemnationem*. The sequence of operations may have been something like this. Taking the simplest form of it, the action for *certa pecunia* under the *Silian* law, the first step was to drop the formal *condictio* from which it derived its character of *legis actio*, thus leaving a day of thirty days; the plaintiff stated his demand in informal words, and if the defendant denied indebtedness, the praetor straightway formulated a written appointment of and instruction to a judge, embodying in it the issue in terms substantially the same as those he would have employed under the earlier procedure:—"Titius be judge. Should it appear that N. N. ought to pay (*dare oportere*) 50,000 sesterces to A. A., in that sum condemn N. N. to A. A.;"² should it so not appear, acquit him." This was no longer the *legis actio per condemnationem*, because what had made it *legis actio* was gone, but the *condictio certae pecuniae* of the formular system. The *condictio triticaria* of the same system ran on the same lines:—"Titius be judge. Should it appear that N. N. ought to give to A. A. the slave Stichus, then, whatever be the value of the slave, in that condemn N. N. to A. A.," and so on. In each of these examples the formula included only two of the four principal clauses that might find place in it—an "intention" and a "condemnation." The matter of claim in both cases was certain,—so much money in one, a slave in the other; but, while in the first the condemnation also was certain, in the second it was uncertain. What if the claim also was uncertain,—say a share of the profits of a joint adventure assured by stipulation? It was perhaps competent for the plaintiff to specify a definite sum, and claim that as due to him; but it was very hazardous, for unless he was able to prove the debt to the last sesterce he lost his case. To obviate the risk of such failure the praetors devised the *actio ex stipulato*, whose formula commenced with a "demonstration" or indication of the cause of action, and whose "intention" referred to it and was conceived indefinitely:—"Titius be judge. Whereas A. A. stipulated with N. N. for a share of the profits of a joint adventure, whatever in respect thereof N. N. ought to give to or do for (*dare facere oportet*) A. A., in the money amount

² In the typical Roman styles of actions the plaintiff was usually called Aulus Agerius and the defendant Numerius Negidius.

³ Gaius enumerates them as *demonstratio, intentio, adjudicatio* and *condemnatio*, and describes their several functions in *iv.* §§ 39-43. The *intentio* and *condemnatio* were much the most important, the others being employed only in certain kinds of actions. Besides these a *formula* might be preceded by a *praescriptio* (*Gai.* *iv.* §§ 130-137), and have incorporated in it fictions (§§ 32-38), exceptions (§§ 115-125), and replications, duplications, &c. (§§ 126-129).

¹ See Keller (as on p. 547, n.), §§ 23-43; Bethmann-Hollweg (as in same note), vol. ii. §§ 81-87; Bekker (as in same note), vol. i. chaps. 4-7, vol. ii. chaps. 15, 19, 20; Baron, *Gesch. d. röm. Rechts* (Berlin, 1884), vol. i. §§ 202-215.

Its application to Personal Actions.

thereof condemn N. N.," and so on.¹ Once this point was attained further progress was comparatively easy, the way being open for the construction of formulæ upon illiquid claims arising from transactions in which the practice of stipulation gradually dropped out of use, till at last the *bonæ fidei iudicia* were reached, marked by the presence in the "intention" of words *ex fide bona*— "whatever in respect thereof N. N. ought in good faith to give to or do for A. A."

In the case of real actions the transition from the *legis actiones* to the formulæ followed a different course. The Aebutian law, while sanctioning the competency of formulæ, did not interfere with the procedure *per sacramentum* when reference was to be to the centumviral court on a question of quiritarian right. In the time of Cicero that court was apparently still in full activity (*supra*), but by that of Gaius, owing, it is supposed, to the Julian laws having made formulæ in most cases compulsory, it was rarely resorted to except for trial of questions of inheritance. In his time questions of property were raised either *per sponsonem* or *per formulam petitoriam*. The procedure by sponsonem may be regarded as a sort of bridge between the sacramental process and the petitory *vindictio*. In it the question of real right was determined only indirectly. The plaintiff required the defendant to give him his stipulatory promise to pay a nominal sum of twenty-five sesterces in the event of the thing in dispute being found to belong to the former; and at the same time the defendant gave sureties for its transfer to the plaintiff and all fruits and profits, in the same event. The formula that was adjusted and remitted to a judge raised *ex facie* only the simple question whether the twenty-five sesterces were due or not; the action was in form a personal, not a real one, and was therefore appropriately remitted to a single *iudex* instead of to the centumviral tribunal. But judgment on it could be reached only through means of a finding (*sententia*) on the question of real right; if it was for the plaintiff, he did not claim the amount of the sponsonem, but the thing which had been found to be his; and, if the defendant delayed to deliver it, with its fruits and profits, the plaintiff had recourse against the latter's sureties. The petitory formula was undoubtedly of later introduction and much more straightforward. Like the *condictio certæ pecuniæ*, it contained only "intention" and "condemnation." It ran thus: "Titius be judge. Should it appear that the slave Stichus, about whom this action has been raised, belongs to A. A. in quiritary right, then, unless the slave be restored, whatever be his value, in that you will condemn N. N. to A. A.; should it not so appear, you will acquit him."

The formulæ stated above, whether applicable to real or personal actions, are so many illustrations of the class known as *formulæ actiones*, *ius civilis* or *in jus conceptæ*. The characteristic of such a formula was that it contained in the "intention" such phrases as the following—*ius esse ex jure Quiritium, præstare oportere, dare oportere, dare facere oportere, or damnum decedere oportere*.² Such words were employed where the right to be vindicated or the obligation to be enforced had its sanction directly in the *ius civile* whether in the shape of statute, consuetude or interpretation. Where, on the other hand, the right or obligation had its sanction solely from the praetor's edict, special formulæ had to be framed. The actions employed in such cases were *actiones juris honorarii*, and these either *actiones utiles* or *actiones in factum*. The first were adaptations of actions of the *ius civile* to cases that did not properly fall within them; the second were actions entirely of praetorian devising, for the protection of rights or redress of wrongs unknown to the *ius civile*.³

¹ This *actio ex stipulatu* used to be regarded as nothing more than a variety of the *condictio incerti*. It is doubtful, however, whether in the *condictiones incerti* (e.g. the *condictio furtiva*) there was any *demonstratio*. See Girard, *Manuel*, p. 614 n. 2 and 3 and authorities there cited.

² Employed in the disjunctive actions, i.e. for dividing common property, partitioning an inheritance, or settling boundaries; the demand was that the judge should adjudicate (or assign) to each of the parties such a share as he thought just. See Lenel, *Edict. Perpet.* 2nd ed. pp. 202, 205.

³ Employed in certain actions upon delict, where the old penalties of death, slavery or talion had in practice, or by the praetor's authority, been transmuted into money payments, and the defendant consequently called upon to pay penal damages. According to Lenel, *Edict. Perpet.* 2nd ed. p. 207, the *edictum dare facere præstare oportere* was probably used in *actio pro socio*.

⁴ These latter have an analogy to the English "action on the case." In a few instances there was both civil and praetorian remedy for the same wrong; for Gaius observes (iv. 47) that in commodate and deposit failure of the borrower or depositary to return the thing lent to or deposited with him gave rise to actions that might be formulated either *in jus* or *in factum*. In the same section he gives the styles of *actiones depositi in jus* and *in factum conceptæ*; these, by comparison is instructive. The formula in factum must almost certainly have been the earlier and shows, it is thought,

Utilis actio may be translated as analogous or adapted action, i.e. analogous to a direct action. Where a direct action was inapplicable to particular cases or persons, according to the terms of a *lex*, edict, &c., the praetor frequently adapted the statute, &c., to such cases and persons by granting an *actio utilis*. He did so where he thought them to be within the spirit though not the letter of the law. He effected his object commonly by modification of the regular formula either objectively, as by adding, or omitting, or altering words, or subjectively by transposing names of parties. But sometimes also the adaptation was made by the introduction of a legal fiction into the regular formula, and in this case the action was called *utilis fictitia* or simply *fictitia*. The *actiones utiles* might, therefore, be of two kinds, ordinary and fictitious. Those of common occurrence early became stereotyped in the Edict and even got special names.

As illustrations of an ordinary *actio utilis*, in which the formula was objectively modified, reference may be made to the numerous actions for wrongful damage to property under the *lex Ordinaria Aquilia*. Thus this statute in its first chapter used the term *occidere*, which means killing by a physical act of violence (*corpore corpori*), but to meet cases of killing without violence (e.g. by poison) the praetors simply substituted the words *mortis causam præstare for occidere* in the formula. As illustrations of an ordinary *actio utilis* with subjective transposition of names, we may mention the *actio Rutiliana* applicable to a purchaser of the bankrupt estate of a living debtor, the action by an assignee of a bankrupt creditor against the debtor and the action by a creditor for his principal. In these the names of the bankrupt, cedent and principal respectively appeared in the *intentio*, while the plaintiff's name was inserted in the *condemnatio*.

Resort to a fiction is sometimes said to be a confession of weakness, and adversely criticized accordingly. But every amendment on the law is an admission of defect in what is being amended; and it was in sympathy with the spirit of Roman jurisprudence, when it found an action too narrow in its definition, to include some new case that ought to fall within it, rather by feigning that the new case was the same as the old, to bring it within the scope of the existing and familiar action, than to cause disturbance by either altering the definition of the latter or introducing an entirely new remedy. A *bonorum possessor* held a position unknown to the *ius civile*; he was not an heir, and therefore not entitled offhand to employ the actions competent to an heir, either for recovering the property of the defunct or proceeding against his debtors. The praetor could have had no difficulty in devising new actions to meet his case; but he preferred the simpler expedient of adapting the action to the new case by introducing into the formula a fiction of civil heirship; so he did with the *bonorum emptor* or purchaser of a deceased bankrupt's estate at the sale of it in mass by his creditors. A peregrin could not sue or be sued for the penalties imposed for theft or culpable damage to property, for the XII. Tables and the Aquilian law applied only to citizens; but he could both sue and be sued under cover of a fiction of citizenship. A man who had acquired a *res mancipi* on a good title, but without taking a conveyance by mancipation or *manu capere*, if he was dispossessed before he had completed his usucapion, could not sue a *rei vindictio* for its recovery, for he was not in a position to affirm that he was quiritarian owner; neither, for the same reason, could a man who in good faith and on a sufficient title had acquired a thing from one who was not in a position to alienate it. But in both cases the praetor granted him what was in effect a *rei vindictio* proceeding on a fiction of completed usucapion—the Publician action referred to on p. 556. These are examples of *actiones fictitiae*—actions of the *ius civile* adapted by this very simple expedient to cases to which otherwise they would have been inapplicable, and forming one of the most important varieties of the *actiones utiles*.

Quite different was the course of procedure in the *actiones in factum*, whose number and varieties were practically unlimited, although for the most part granted in pursuance of the praetor's promise in the edict that under such and such circumstances he would make a remit to a *iudex* (*iudicium dabo*),⁴ and formulated in accordance with the relative skeleton styles also published on the albulæ. A great number of them came to be known by special names, as, for example, the *actio de pecunia constituta*, *actio de stipulatu hypothecaria*, *actio de pecunia constituta*, *actio in bonorum raptorum*, *actio de superficie*, &c.—the generic name *actio in factum* being usually confined to the in nominate ones. Their formulæ, unlike those *in jus conceptæ*, submitted no question of legal right for the

that deposit and commodate were enforced (perhaps first by the peregrin praetor) by means of edicts before being admitted into the *ius civile*.

⁴ Examples: "Si quis negotia alterius . . . gesserit, iudicium eo nomine dabo" (*Dig.* iii. 5, 3, pr.); "Quae dolo malo facta esse dicentur, si de his rebus alia actio non erit et iusta causa esse videbitur, iudicium dabo" (*Dig.* iv. 3, 1, § 1); "Nautae cauponæ stabularii quod cuiusque saluum fore receperint, nisi restituerint, in eos eodictum dabo" (*Dig.* iv. 9, 1, pr.); "Quod quis commodasse dicetur, de eo iudicium dabo" (*Dig.* xiii. 6, 1, pr.).

consideration of the judge, but only a question of fact, proof of which was to be followed by a condemnation. That of the *actio de dolo*, for example, ran thus: "Titus be judge. Should it appear that, through the fraud of N. N., A. A. was induced to convey and cede possession to him of his farm (describing it), then, unless on your order N. N. restores it, you will condemn him in damages to A. A.; if it shall not so appear, you will acquit him." Actions *in factis* might, be *actioe*, with *actio*; e.g. *actio quasi-Serviana* or *hypothecaria* was *utilis*, being based on analogy to the *actio Serviana*.

Our limits do not admit of any explanation of the purpose, form, or effect of the prescriptions, exceptions, replications, &c., that were engrained on a *formula* when required; or of the ways in which the "condemnation" was occasionally "taxed" by the praetor, so as to prevent the award of extravagant damages; or of the consequences of defects in the formula; or of the procedure *in jure* before it was adjusted, or *in judicio* afterwards; or of appeal for review of the judgment by a higher tribunal; or of execution (which was against the estate of the judgment-debtor, and took the form of incarceration only when his goods could not be attached). Our main object has been to show how elastic was this procedure, and how the praetorian *formulae*, in conjunction with the relative announcements in the edict, supplied the vehicle for the introduction into the law of an immense amount of new doctrine. The system was fully developed before Julian's consolidation of the Edict; and the statutory recognition which the latter then obtained, though it stopped the praetor's power of amending the law, did nothing to impair the efficiency of the existing procedure.

Procedure extra Ordinem. The two-staged procedure, first *in jure* and then *in judicio*, constituted the *ordo iudiciorum privatorum*. Early in the Empire, however, it became the practice in certain cases to abstain from adjusting a *formula* and making a remit to a *judex*, and to leave the cause in the hands of the magistrate from beginning to end.

In these cases, speaking generally, the magistrate acted as an administrative official. Such cases did not necessarily come before the ordinary judicial praetor; on the contrary, they were committed to a role to special officials (*consules*), who were appointed to decide by the emperors. This kind of procedure was adopted sometimes because the claim that was being made rested rather on moral than on legal right, and sometimes in order to avoid unnecessary disclosure of family misunderstandings. Thus, the earliest questions that were raised about testamentary trusts were, sent for consideration and disposal to the consuls, apparently because, in the existing state of jurisprudence, it was thought incompetent for a beneficiary to maintain in reference to a trust (who had not been selected to comply with the testator's wishes) that he was bound in law to pay him (*dare*) against his bequest. Had the difficulty arisen at an earlier period, and in the heyday of the constructive energy of the praetors, they would probably have solved it with an *actio in factum*. As it was, it fell to the emperors to deal with it, and they adopted the method of *extraordinaria cognitio*, the jurisdiction which they in the first instance conferred on the consuls being before long confided to a magistrate specially designated for it,—the praetor *fidei commissarius*. Questions between tutors and their pupil wards in like manner began to be dealt with *extra ordinem*, the cognition being entrusted by Marcus Aurelius to praetor *tutelaris*; while false questions in which a private party was interested went to a praetor *fisci*, whose creation was due to Nerva. Claims for aliment between parent and child or patron and freedman rested on natural duty rather than on legal right; they could not therefore well be made the subject-matter of a *judicium*, and consequently went for disposal to the consuls or the city prefect, and in the provinces to the governor. Questions of status, especially of freedom or slavery, at least from the time of Marcus Aurelius, were also disposed of *extra ordinem*; so were cases by physicians, magistrates and public teachers for their honoraria, and by officials for their salaries, the Romans refusing to admit that these could be recovered by an ordinary action of location. In all those extraordinary cognitions the procedure began with a complaint addressed to the magistrate, instead of an *in jus vocatio* of the party complained against; it was for the magistrate to require the attendance of the latter (*evocatio*) if he thought the complaint relevant. The decision was a *judicatum* or *decretum* according to circumstances.

Jural Remedies flowing Directly from the Magistrate's Imperium.—Great as were the results for the law of the multiplication and simplification of *judicia* through the formular system, it may be questioned whether it did not benefit quite as much from the direct intervention of the praetors and other magistrates in certain cases in virtue of the *imperium* with which they were invested. This manifested itself principally in the form of (1) interdicts; (2) praetorian stipulations;

Direct
magis-
terial
inter-
vention.

¹ See Keller-Wach, *Civilprocess*, § 81; Bethmann-Hollweg, *Röm. Civilprocess*, vol. ii. § 122; Bekker, *Actiōnes*, vol. ii. chap. 23; Baron, *Gesch. d. röm. Rechts*, vol. i. § 220.

² Keller-Wach, *Röm. Civilprocess*, §§ 74-80; Bethmann-Hollweg, *Röm. Civilprocess*, vol. ii. §§ 98, 119-121; Bekker, *Act. vol. ii.*

(3) *missio in possessionem*; and (4) *in integrum restitutio*. All these had been in common use during the Republic.

1. The interdicts¹ have already been referred to as in use under the régime of the *jus civile*; but their number and scope were vastly increased under that of the *jus praetorium*. The characteristic of the developed procedure by interdict was this,—that in it the praetor reversed the ordinary course of the trial, and, instead of waiting for an inquiry into the facts alleged by the complainant, provisionally assumed them to be true and pronounced an order upon the respondent, which he was bound either to obey or show to be unjustified. The order pronounced might be either restitutory, exhibitory (in both cases usually spoken of in the texts as a *decretum*), or prohibitory;—restitutory, when, for example, the respondent was ordained to restore something he was alleged to have taken possession of by violent means, to remove impediments he had placed in the channel of a river, and the like; exhibitory, when he was ordained to produce something he was unwarrantably detaining, e.g. the body of a freeman he was holding as his slave, or a will in which the complainant alleged that he had an interest; prohibitory, as, for example, that he should not disturb the *status quo* of possession as between the complainant and himself, that he should not interfere with a highway, a watercourse, the access to a sepulchre, and so forth. If the respondent obeyed the order pronounced in a restitutory or exhibitory decree, there was an end of the matter. But frequently, and perhaps more often than not, the interdict was only the commencement of a litigation, facilitated by sponsions and restitutions, in which the questions had to be tried, (1) whether the interdict or injunction was justified, (2) whether there had been breach of it, and, (3) if so, what damages were due in consequence. The procedure therefore was often anything but summary.

In the possessory interdicts *sui possidetis* and *utrobi* in particular it was extremely involved, due to some extent to the fact that they were double interdicts (*interdicta duplicata*), i.e. addressed indifferently to both parties. Gaius says, but, as most modern writers think, erroneously, that they had been devised as ancillary to a litigation about ownership, and as a purpose of deciding which of the parties, as possessor, was to have the advantage of standing on the defensive in the *rei vindicatio*.² That they were so used in his time, as in that of Justinian, cannot be doubted. But it is amazing that they should have been, for they were much more cumbersome than the *vindicatio* to which they led up. Take the interdict *sui possidetis*, which applied to immovables, as *utrobi* did to movables. Both parties being present, the praetor addressed them to this effect: "I forbid that one of you two who does not possess the house in question to use force in order to prevent the other of you from being admitted to it, nor in any way to claim the house or violent exclusion of the first, nor in virtue of a grant from him during pleasure, from continuing to possess as at present." It is manifest that this decided nothing; it was no more than a prohibition of disturbance of the *status quo*; it left the question entirely open which of the parties it was that was in possession, and which that was forbidden to interfere. The manner of its explication was somewhat singular. Each of the parties was bound at once to commit what in the case of one of them must have been a breach of the interdict, by a pretence of violence offered to the other (*vis ex conventu*)³ each of them was thus in a position to say to the other: "We have both used force; but it was you alone that did it in defiance of the interdict, for it is I that am in possession." The interim enjoyment of the house was then awarded to the highest bidder, who gave his stipulatory promise to pay rent to his adversary in the event of the latter being successful in the long-run; penal sponsions and restitutions were exchanged upon the question which of them had committed a breach of the interdict; and on these, four in number, *formulae* were adjusted and sent to a *judex* for trial. If the procedure could not thus be explicated, because either of the parties declined to take part in the *vis ex conventu* or the bidding, or the sponsions and restitutions, he was assumed to be in the wrong, and, by what was called a secondary interdict, required to yield up his possession or detention and to abstain from disturbing the other "in all time coming." Whatever we may think of the action system of the Romans in the period of the classical jurisprudence, one cannot help wondering at a

chaps. 16-18; Baron, vol. i. §§ 216-219. Procedure in these cases is also sometimes included under the term *cognitio extraordinaria*.

¹ In addition to the authorities in last note, see K. A. Schmidt, *Das Interdictenverfahren d. Röm. in geschichtl. Entwicklung* (Leipzig, 1853); Machlard, *Théorie des interdits en droit romain* (Paris, 1864); *Rechtsgesch. d. R. G.* ii. pp. 315 seq. See also the *vis ex conventu* and the bidding, or the sponsions and restitutions, he was assumed to be in the wrong, and, by what was called a secondary interdict, required to yield up his possession or detention and to abstain from disturbing the other "in all time coming." Whatever we may think of the action system of the Romans in the period of the classical jurisprudence, one cannot help wondering at a

² Gaius calls it; it was probably the same thing, as the *vis moribus facta* referred to by Cicero, *Pro Caec.* i. § 2, 8, § 22.

procedure so cumbersome and complex as that of their possessory interdicts.

2. A praetorian stipulation¹ was a stipulatory engagement imposed upon a man by a magistrate or judge, in order to secure a third party from the chance of loss or prejudice through some act or omission of the first, from whom the engagement was exacted or of some other person for whom he was responsible. Although called praetorian, because the cases in which such stipulations were exigible were set forth in the Edict, there can be no question that they originated in the *ius civile*; in fact, they were just a means of assuring to a man in advance the benefit of an action of the *ius civile* whereby he might obtain reparation for any injury suffered by him through the occurrence of the act or omission contemplated as possible. They were enforced much as always in granting or refusing an action *in ius* by *missio in possessionem*. Ulpian classifies them (rather illogically) as cautionary (*cautionales*), judicial and common. The first were purely precautionary, and quite independent of any action already in dependence between the party moving the magistrate to exact the stipulation and him on whom it was desired to impose it. There were many varieties of them, connected with all branches of the law—for example, the *cautio damni infecti*, security against damage to a man's property in consequence, say, of the ruinous condition of his neighbour's house, the *cautio usufructuaria* that property usufructed should revert unimpaired to the owner on the expiry of the usufructuary's life interest, the aedilian stipulation against faults in a thing sold, and so forth. In all these cases the stipulation or *cautio* was a guarantee against future loss or injury, usually corroborated by sureties, and made effectual by an action on the stipulation in the event of loss or injury resulting. Judicial stipulations, according to Ulpian's classification, were those imposed by a judge in the course of and with reference to an action in dependence before him, as, for example, the *cautio iudicatum solvi* (that the defendant would satisfy the judgment), the *cautio de dolo* (that a thing claimed in the action would not be fraudulently impaired in the meantime) and many others. Common were such as might either be imposed by a magistrate apart from any depending action or by a judge in the course of one, such as that taken from a tutor or curator for the faithful administration of his office, or from a procurator that his principal would ratify what he did.

Missio in possessionem was the putting of a person in possession provisionally in the first instance, either of the whole estate of another (*missio in bona*) or of some particular thing belonging to him (*missio in rem*). The former was by far the more important. It was resorted to as a means of execution not only against a judgment-debtor but also against a man who fraudulently kept out of the way and thus avoided summons in an action, or who, having been duly summoned, would not do what was expected on the part of the defendant; against the estate of a person deceased to which no heir would enter, thus leaving creditors without a debtor from whom they could enforce payment of their claims; and also against the estate that had belonged to a person who had undergone *capitis deminutio*, if the family head to whom he had subjected himself refused to be responsible for his debts. *Missio in rem* was granted where, for example, a man refused to give *cautio damni infecti*; the applicant was then put in possession of the ruinous property for his own protection.

3. *In integrum restitutio*,² reinstatement of an individual, on grounds of equity, in the position he had occupied before some occurrence which had resulted to his prejudice and for which no other legal remedy existed was one of the most remarkable manifestations of the exercise of magisterial *imperium*. It was not that the individual in question, either directly by act or indirectly by exception, obtained a judgment which either rendered what had happened comparatively harmless, or gave him compensation in damages for the loss he had sustained from it, but that the magistrate—and it could only be the praetor, the urban or praetorian prefect, a provincial governor or the emperor himself—at his own hand pronounced a decree that as far as possible restored the *status quo ante*. It was not enough, however, to entitle a man to this extraordinary relief, that he was able to show that he had been taken advantage of to his hurt, and that no other adequate means of redress was available to him, but that the discretion of the magistrate found on some subjective ground of restitution, such as minority, or, if he was of full age, intimidation which could not be resisted, mistake of fact, fraud, absence or the like. It required also to be applied for within a limited period—originally an *annus utilis*, but under Justinian a *quadriennium*—counting from the time the party was in a position to make the application. What should be held to amount to a sufficient ground of restitution, either objective or subjective, was at first left much to the discretion of the magistrate; but even here practice and jurisprudence in time

fixed the lines within which he ought to confine himself, and made the principles of *in integrum restitutio* as well settled almost as those of the *actio quod metus causa* or the *actio de dolo*.

V. THE PERIOD OF CODIFICATION

(Diocletian to Justinian.)

i. Historical Events that Influenced the Law.

Supremacy of the Emperors as Sole Legislators.—From the time of Diocletian onwards the making of the law was exclusively in the hands of the emperors. The senate still existed, but shorn of all its old functions alike of government and legislation.³ The responses of patented jurists were a thing of the past. It was to the imperial consistory alone that men looked for interpretation of old law or promulgation of new.

In the reign of Diocletian rescripts were still abundant; but the constitutions in the Theodosian and Justinian Codes from the time of Constantine downwards are mostly of a wider scope, and of the class known as general or edictal laws (*leges generales edictales*). It would be wrong, however, to infer that rescripts had ceased; for Justinian's Code contains various regulations as to their form, and the matter is dealt with again in one of his Novels. The reason why so few are preserved is that they were no longer authoritative except for the parties to whom they were addressed. This was expressly declared by the emperors Arcadius and Honorius in 398 in reference to those they issued in answer to applications for advice from officials; and it is not unreasonable to assume that a limitation of the same sort had been put at an earlier date on the authority of those addressed to private parties. Puchta is of opinion that the enactment of Honorius and Arcadius applied equally to *decreta*, for the reason that during this period matters of litigation did not come under the cognisance of the emperors except on appeal, and that under the new arrangements of Constantine the judgment of affirmation or reversal was embodied in a rescript addressed to the magistrate from whom the appeal had been taken. The rule of Arcadius and Honorius was renewed in 425 by Theodosius and Valentinian, who qualified it, however, to this extent—that, if it contained any distinct indication that the doctrine it laid down was meant to be of general application, then it was to be received as an edict or *lex generalis*. To this Justinian adhered in so far as rescripts in the old sense of the word were concerned; but he declared that his judgments (*decreta*) should be received everywhere as laws of general application, and so should any interpretation given by him of a *lex generalis*, even though elicited by the petition of a private party. The imperial edicts, adjusted in the consistory, were usually addressed to the people, the senate or some official, civil, military or ecclesiastical, according to the nature of their subject-matter.

Influence of Christianity.—A disposition has sometimes been manifested to credit nascent Christianity with the humaner spirit which began to operate on some of the institutions of the law in the first century of the Empire, but which in a previous section we have ascribed to the infiltration into the *ius civile* of doctrines of the *ius naturale*, the product of the philosophy of the Stoics. The teaching of Seneca did quite as much—nay, far more—to influence it, than the lessons that were taught in the little assemblies of the early converts. It would be a bold thing to say that, had Christianity never gained its preponderance, that spirit of natural right would not have continued to animate the course of legislation, and to evoke, as years progressed, most of those amendments in the law of the family and the law of succession that were amongst the most valuable contributions of the imperial constitutions to the private law. It may well be that that spirit was intensified and rendered more active with the growth of Christian belief; but not until the latter had been publicly sanctioned by Constantine, and more especially after Theodosius declared it to be the religion of the state, do we meet with incontestable records of its influence. We find them in enactments in favour of the church and its property, and of its privileges as a legatee; in those conferring or imposing on the bishops a supervision of charities and charitable institutions, and a power of interfering in matters of guardianship, in the legitimization *per subsequens matrimonium* of children born of concubines; in the introduction of a mode of manumitting slaves *in facie ecclesiae*;

¹ There was a senate both at Constantinople and at Rome during the latter Empire. In his History, Zosimus, lib. 11, says: 'Ἰουλιανὸς θέσεν μὴν τῆ πόλεως [Κωνσταντινουπόλεως] ἡγεμονίαν ἕως ὅσπερ τῆ Ρώμης. Both senates were addressed by the emperors on matters of legislation. See Cod. Theod., vi. 2.

² See Troplong, *De l'influence du Christianisme sur le droit civil des Romains* (Paris, 1843, and subsequently); Merivale, *The Conversion of the Romans to Christianity* (Boyle Lectures for 1864) (London, 1864), particularly lect. iv.; Allard, *Le Christianisme et l'empire romain* (2nd ed., Paris, 1897).

¹ Schirmer, *Ueber die prätorischen Judicial-Stipulationen* (Greifswald, 1853); Keller-Wach, *Civilprozess*, § 77; Bekker, *Aktionen*, ii. ch. 16.

² Savigny, *Komm. d. röm. Rechts*, vol. vii. §§ 315-343; Karlowa, *Rom. R. G.*, ii. pp. 1064-1104; Keller-Wach, *op. cit.* § 79; Bekker, *Aktionen*, ii. chap. 18.

Christi-
tinity—
its in-
fluence.

in the recognition of the efficacy of certain acts done in presence of two or three of the clergy and thereafter recorded in the church registers; in the disabilities as to marriage and succession with which heretics and apostates were visited, and in a variety of minor matters. Of greater importance were three features for which it was directly responsible—the repeal of the caducary provisions of the Papia-Poppæan law, the penalties imposed upon divorce, and the institution of the *episcopalis audientia*.

The purpose of the caducary law was to discourage celibacy and encourage fruitful marriages; but legislation in such a spirit could not possibly be maintained when celibacy had come to be inculcated as a virtue, and as the peculiar characteristic of a holy life. The penalties alike of *orbis* and *coelibatus* were abolished by Constantine in the year 320. The legislation about divorce, from the first of Constantine's enactments on the subject down to those of Justinian, forms a miserable chapter in the history of the law. Not one of the emperors who busied himself with the matter, undoing the ill-winded work of his predecessors and substituting legislation of his own quite as complicated and futile, thought of interfering with the old principle that divorce ought to be as free as marriage and independent of the sanction or decree of a judicial tribunal. Justinian was the first who, by one of his Novels, imposed a condition on parties to a divorce of common accord (*communis consensus*), namely, that they should both enter a convent, otherwise it should be null; but, so distasteful was this to popular feeling, and so little conducive to improvement of the tone of morals within the conventual precincts, that it was repealed by his successor. The legislation of Justinian's predecessors and the bulk of his own were levelled at one-sided repudiations, imposing the penalties of original and patrimonial (1.) upon the author of a repudiation on some ground the law did not recognize as sufficient—and the lawful grounds varied almost from reign to reign—and (2.) upon the party whose misconduct gave rise to a repudiation that was justifiable. The bishop's court (*episcopale iudicium, episcopalis audientia*) had its origin in the practice of the primitive Christians, in accordance with the apostolic precept, of submitting their differences to one or two of their brethren in the faith, usually a presbyter or bishop, who acted as arbiter. On the state recognition of Christianity the practice obtained legislative sanction. Constantine giving the bishop's court concurrent jurisdiction with the ordinary civil courts where both parties preferred the former, and by a later enactment (whose authenticity, however, is open to some doubt) going so far as to empower one of the parties to a suit to remove it to the ecclesiastical tribunal against the will of the other. He also declared that the judgments were to be enforced by the civil courts.¹ For various reasons, advantage was taken of this power of resorting to the bishop to an extent which seriously interfered with the proper discharge of his spiritual functions, so that in 398 a gradus in the Eastern Empire judged in accordance with the bishop's original rule, and, henceforth, as regarded laymen, to limit the right of resort to the episcopal judicatory to cases in which both parties consented. The same thing was done by Valentinian in the Western Empire in 452. It is impossible to say with any approach to exactitude what effect this intervention of the clergy as judges in ordinary civil causes—for they had no proper criminal jurisdiction—had on the development of the law. But it can hardly have been without some influence in still further promoting the tendency to subordinate act and word to will and intention, to deal leniently with technicalities, and to temper the rules of the *ius civile* with equity and considerations of natural right.

Abandonment of the Formular System of Procedure.—The formular system, with its remit from the praetor to a sworn *iudex* who was to try the cause, was of infinite advantage to the law; for the judgment was as a rule that of a free and independent citizen, untrammelled by officialism, fresh from some centre of business, chosen by, and in full sympathy with, the parties between whom he had to decide. Such a system was incompatible with the autocratic government of Diocletian and Constantine; and it is with no surprise that we find the former of these sovereigns instructing the provincial governors that in future, unless when prevented by pressure of business (or, according to a later constitution of Julian's, when the matter was of trifling importance), they were not to remit them but were themselves to hear the causes brought before them from first to last, as had previously been the practice in the *extraordinariae cognitiones*. The remit in the excepted cases was not, as formerly, to a private citizen, but to what was called a *iudex pedaneus*, who acted as an inferior substitute of the magistrate and was probably a matriculated member of the local bar; and for a time his delegated authority was embodied

in a *formula* after the old fashion. But even this exceptional use of it did not long survive, for an enactment by the two sons of Constantine, conceived in terms the most comprehensive, declared fixed styles to be but traps for the unwary, and forbade their use in any legal act whatever, whether contentious or voluntary. The result was, not only the formal disappearance of the distinction between the proceedings *in iure* and *in iudicio* (*iudicium* receiving a more extensive meaning), but the practical (though not formal) disappearance also of the distinctions between actions *in ius* and *in factum*, and between *actiones directae* and *actiones utiles*, the conversion of the interdiction into an *actio ex interdicto*, admission of the power of amendment of the pleadings, condemnation in the specific thing claimed, if in existence, instead of its pecuniary equivalent, and execution accordingly by the aid of officers of the law.

Under the new system a process was full from first to last of intervention by officials. The *in ius vocatio* of the XII. Tables—the procedure by which a plaintiff himself brought his adversary into court—became a thing of the past. So also did the *vadimonium*. In its earlier part of the period the proceedings commenced with the *litis denuntiatio* introduced in the time of Marcus Aurelius and remodelled by Constantine; but under Justinian (though probably begun before his reign) the initial step was what was called the *libellus conventivus*. This was a short and precise written statement addressed by the plaintiff to the court, explaining (but without detail) the nature of the action he proposed to raise and the claim he was making, which was accompanied by a formal undertaking to proceed with the cause and follow it out to judgment, under penalty of having to pay double costs to the defendant. If the court was satisfied of the relevancy of the issue, he pronounced an interlocutor (*interlocutio*) ordaining its libel on the respondent; this was done by an officer of the court, who cited him to appear on a day named, usually at a distance of one or two months. The defendant, through the officer, had to put in an answer (*libellus contradictivus*), at the same time giving security for the proper maintenance of the defence and eventual satisfaction of the judgment. If defendant did not appear after three summonses the case was heard and decree given in his absence. On the first day appointed the parties or their procurators were first heard on any state of plea or defence, jurisdiction of the court, if none offered, or those stated repelled, they then proceeded to expound their respective grounds of action and defence, each finally making oath of his good faith in the matter (*iuramentum columbae*), and their counsel doing the same.

From this point, which marked the *litis contestatio* or joinder of issue, the procedure was much the same as that in *iudicio* under the formular system. Evidence was taken and judgment given. But in all cases in which the demand was that a particular thing should be given or restored, and the plaintiff desired to have the thing itself, the court, after a declaration of its jurisdiction, if none offered, or those stated repelled, they then proceeded to expound their respective grounds of action and defence, each finally making oath of his good faith in the matter (*iuramentum columbae*), and their counsel doing the same.

From this point, which marked the *litis contestatio* or joinder of issue, the procedure was much the same as that in *iudicio* under the formular system. Evidence was taken and judgment given. But in all cases in which the demand was that a particular thing should be given or restored, and the plaintiff desired to have the thing itself, the court, after a declaration of its jurisdiction, if none offered, or those stated repelled, they then proceeded to expound their respective grounds of action and defence, each finally making oath of his good faith in the matter (*iuramentum columbae*), and their counsel doing the same.

The *Valentinian Law of Citations*.² This famous enactment, the production of Theodosius (428), and of his nephew Valentinian III., was issued from Ravenna in the year 428, and was addressed to the Roman senate. It ran thus:—
"We accord our approval of all the writings of Papinian, Paul, Gaius, Ulpian and Modestine, conceding to Gaius the same authority that is enjoyed by Paul, Ulpian and the rest, and sanctioning the citation of all his works. We ratify also the jurisprudence (*scientia*) of those earlier writers whose treatises and statements of the law the aforesaid five have imported into their own works.—Scaevola, for example, and Sabinius, and Julian and Marcellus, except of all others whom they have been in the habit of quoting as authorities (*omniumque ius tunc celebrantur*), provided always, as their antiquity makes them uncertain, that the texts of those earlier jurists are verified by collation of manuscripts.³ If divergent *dicta* be adduced, that party shall prevail who has the greatest number of authorities on his side; if the number on each side be the same, that one shall prevail which has the support of Papinian; but, whilst he, most excellent of them all, is to be preferred to any other single authority, he must yield to any two. [Paul's and Ulpian's notes on his writings, however, as already enacted, are to be disregarded.] Where opinions are equal and none entitled to preference, we leave it to the discretion of the judge which he shall adopt."

¹ The truth of this as well as the previous rule depends on the authenticity of a Sirmiondan constitution. See Cug, *Inst. Jurid.* ii. p. 868 n.

² Wieding, *Der Justinianische Libellus procedendi* (Vienna, 1865); Bethmann-Hollweg (*Gesch. d. C. P.*), vol. iii. (1866); Muther (rev. Wieding), in the *Krit. Vierteljahrsschrift*, vol. ix. (1867), pp. 161 seq., 329 seq.; Wieding, in same journal, vol. xii. (1870), pp. 228 seq.; Bekker, *Actiones*, vol. ii. chaps. 23, 24; Cug, *Inst. Jurid.* 2nd ed. ii. pp. 875 seq.

³ *Theod. Cod.* i. 4. 3; Puchta, in the *Rhein. Museum f. Jurisprud.* vol. v. (1832), pp. 141 seq., and *Verm. Schriften* (Leipzig, 1851), pp. 284 seq.; Karlowa, *Röm. Rechtsgesch.* vol. i. p. 933 seq.; Sohm, *Inst.* § 21, nn. 1 and 2, and authorities there cited.

⁴ There is, however, a good deal of doubt as to what is meant by the words *collatione codicum* in this Edict. See Sohm as in preceding note, and authorities cited by him.

This constitution has always been regarded as a signal proof of the lamentable condition into which jurisprudence had sunk in the beginning of the 5th century. Constantine, a hundred years earlier, had condemned the notes of Ulpian and Paul upon Papinian. There were no longer any living jurists to lay down the law (*ius condere*); and, if it was to be gathered from the writings of those who were dead, it was perhaps as well that the use of them should be regulated. The Valentinian law proceeded so far in the same direction. It made a selection of the juriscitons of the past whose works alone were to be allowed to be cited.—Papinian, Paul, Ulpian and Modestine, the four latest patented counsel of any distinction; Gaius, of authority previously only in the schools, but whose writings were now approved universally, notwithstanding that he had never possessed the *ius respondendi*; and all the earlier jurists whose dicta these five had collected. It was a step further for it declared all persons, with the sole exception of Papinian, to be of the same authority, and degraded the function of the judge in most cases—so far at least as a question of law was concerned—to the purely arithmetical task of counting up the names which the industry of the advocates on either side had succeeded in adducing in support of these respective contentions. It is probable that, from the days of Hadrian down to Severus Alexander, when the emperor in his council had to frame a rescript or a decree, its tenor was to be determined by the majority; and that the same argument and counter-argument, which must in many cases have modified first impressions. Taking the votes of dead men, who had not heard each other's reasons for their opinions, was a very different process. It may have been necessary; but it can have been so only because a living jurisprudence had no existence,—because the constructive talent of the earlier Empire had entirely disappeared.

ii. Ante-Justinian Collections of Statutes and Jurisprudence.

Of cardinal importance for this period were the collections of imperial constitutions made prior to Justinian. There were three of these, viz. the Gregorian, the Hermogenian and the Theodosian Codes;¹ the first two being the work of private hands, though they afterwards received statutory sanction from Theodosius II., the third being due to that emperor himself.

Codez Gregorianus.—This was a collection of imperial constitutions from Hadrian to Diocletian, made by a certain Gregorius about the end of the 3rd century (a. 255), who, in Mommsen's opinion² was at that time a professor at the law school of Beirut.

Only fragments of it have come down to us, obtained chiefly from Alaric's Breviary, the *Lex Romana Burgundionum*, the *Consultatio*, the *Collatio* and the Vatican Fragments mentioned below; but it was a work of considerable size, divided into books and titles.

Codez Hermogenianus.³—This, like the Gregorian, was compiled in the Eastern Empire, apparently at the end of the 3rd century, but its exact date is uncertain. It contains a constitution of the year 365 there must have been subsequent additions to it. Only fragmentary remains of it are extant, obtained from the same sources as the Gregorian.

Codez Theodosianus.—In the year 429 the emperor Theodosius nominated a commission of nine persons to collect the constitutions issued by the emperors from Constantine to his own reign. From the terms of the edict appointing them he seems to have intended to initiate the preparation of a body of law which, if his scheme had been carried into execution, would have rendered that of Justinian unnecessary. In a constitution about ten years later he explains the motives that had actuated him: that he saw with concern the poverty-stricken state of jurisprudence and how few men there were who, notwithstanding the prices that awaited them, were able to make themselves familiar with the whole range of law; and that he attributed it very much to the multitude of books and

the large mass of statutes through which the law was dispersed, and which it was next to impossible for any ordinary mortal to master. His scheme was eventually to compile one single code from materials derived alike from the writings of the jurists, the Gregorian and Hermogenian collections of rescripts, and the constitutions from the time of Constantine downwards. His language leaves little doubt that it was his intention to have this general code carefully prepared, so as to make it a complete exponent of the existing law, which should take the place of everything, statutory or jurisprudential, of an earlier date. The collection of constitutions which he directed his commissioners meantime to prepare, and which was to contain even those that were merely of historical interest (provided only it was made clear how later enactments had affected them), was to be the first step in the execution of his project. For some time after Constantine's death nothing followed on this enactment, and in 435 a new commission of sixteen persons was nominated to collect the constitutions, but nothing was said in their instructions about anything ulterior. They were directed, however, to deal with their material in a systematic way, as by arranging the constitutions chronologically under definite titles, separating, where necessary, any constitutions dealing with more than one matter into parts, so as to bring each matter under its proper title, and with power otherwise to make such omissions, additions and alterations as seemed to improve the system. The work was completed in less than three years and published at Constantinople early in the year 438, with the declaration that it should take effect from the 1st of January following, and a copy was sent to Valentinian, who notified it to the senate at Rome and ordained that it should come into force in the West from the 12th of January 439. The arrangement is in sixteen books, subdivided into titles with rubrics in which the constitutions are as a rule (though not consistently) placed in chronological order. They cover the whole field of law, private and public, civil and criminal, fiscal and administrative, military and ecclesiastical. The private law is contained in the first five books. This code was usually called in later documents "Theodosianus," without *codex* adjoined. All constitutions since Constantine not contained in it were abrogated. The manuscripts in which it has come down to us are very defective, but many lacunae have been filled up from other sources, especially from Alaric's Breviary. Unfortunately the lacunae are principally in the books relating to the private law.⁴

Novellae Post-Theodosianae.—The imperial constitutions subsequent to the publication of the *Theodosianus* got the name of Novels (*novellae leges*). There were three collections of these, all made in the Western Empire, and they are generally known as post-Theodosian Novels. The first collection containing edicts of Theodosius himself, sent by him to Valentinian III. in 447, was published by the latter emperor in the following year. The second collection contained in addition to edicts of Theodosius some edicts of Marcian and other emperors of the East, and also some of Valentinian, Majorian and other emperors of the West. The third collection was published in abridged form in Alaric's Breviary. These collections are not extant, but from Alaric's Breviary, with additions from manuscript sources, modern editions of the Novels have been prepared.⁵ There was also a collection of constitutions, issued between the years 331 and 425, nearly all relating to church matters, first published by T. Sirmundus in 1631, and now known as the Sirmundian Constitutions.

Besides the collections of statutes just mentioned there were a number of juristic works of this period, containing both statute law (*leges*) and common law (*ius*) in combination, made by private individuals. Of these the following, which have come down to us in a more or less imperfect condition, are the most important:—

The Collatio Legum Mosaicarum et Romanarum⁶—or, as its title bears, *Lex Dei quae praecipitur Dominus ad Moysen*—is a parallel of divine and human law, especially in the matter of delicts and punishments, the former drawn from the Pentateuch, and the latter from the works of Gaius, Papinian, Paul, Ulpian, and

¹ There have been several editions of the Theodosian Code. That of J. Gothofredus, published after his death in 1652 (ed. with additions by Ritter in 7 vols., Leipzig, 1736-41), is a work of monumental learning and still indispensable on account of its commentary. But the latest and best edition is that of Mommsen, being the last work from the pen of that great master. It has been published at Berlin in 1905 under the title, *Theodosianus libri xvi. cum constitutionibus Sirmundianis et legibus novellis ad Theodosianum et Marcianum et Theodosianis M. J. et Novellae Post-Theodosianis libri xvii. cum constitutionibus Sirmundianis edidit, adsumpto apparatu P. Krügeri, Th. Mommsen* (1905).

² These Novels, so far as preserved, have been published as a second part of Mommsen's edition of the Theodosian Code. *II. Leges ad Theodosianum pertinentes edidit adjectore Th. Mommseno Paulus M. Meyer* (1905).

³ These are contained in the Mommsen-Meyer edition of the *Theodosianus*.

⁴ *Collectio Juris AntJustiniani*, by Krüger and Mommsen, iii. pp. 107 seq.; Girard, *Textes*, pp. 543 seq.; Krüger, *Quellen*, pp. 302 seq.

¹ Mommsen suggests (*Z. d. Sav. Stift.*, 1889, x. pp. 345 seq.) that the name *codex* (meaning a volume) was given to them because, instead of being written on papyrus rolls, they were originally written in the form of *tabulae publicae* and bound together as a parchment volume. Private collections of Constitutions had been made even earlier than Gregorian (e.g. by Papirius Justus).

² *Z. d. Sav. Stift.* xxii. pp. 139 seq.

³ Mommsen, *Z. d. Sav. Stift.* (1889), x. pp. 347 seq.; Kipp, *Gesch. d. Quellen*, pp. 75-80. The fragments of both this and the Gregorian Code, edited by Krüger, are given in the *Collectio Juris Antiquae*, by K. M. and S., vol. iii. pp. 236-245.

Collec-
tions of
statutes.
Codifica-
tion.

Gregorian
Code.

Hermogenian
Code.

Theodosian
Code.

Juristru-
dental
collec-
tions.

Collatio.

Modestine, rescripts from the Gregorian and Hermogenian Codes, and one later general enactment. Its date is probably soon after the year 390, but its authorship is unknown.¹

Fragmenta Vaticana.²—These fragments, discovered by Cardinal Angelo Mai in a palimpsest in the Vatican in 1821, seem to have formed part of a book of practice, compiled in the Western Empire and of considerable dimensions. The extant fragments of the *Titules* into which it was divided deal with sale, usufruct, dowries, donations, tutors and professional agents, and have been extracted from the writings of Papinian, Paul the Ulpian, an unknown work on interdicts, and the imperial constitutions prior to Theodosius, the latest of which is of the year 372. Its antiquity is therefore probably about the same as that of the *Collatio*.³

The Consultatio.⁴—The so-called *Veteris cujusdam Jurisconsulti Consultatio* was first published in 1577 by Cujas, from whom it got its name. It is a collection of answers by an advocate, supported by citations of texts (*consultationes*) upon questions of law submitted for his opinion by a solicitor, and is of value for the extracts it contains from Paul's Sentences and the three above-mentioned codes. It is thought to have been written in Gaul in the end of the 5th or beginning of the 6th century.

Syro-Roman Law-Book.⁵—This was a sort of manual of Roman law drawn up in the East, apparently in the Greek language, at an uncertain date, but some time between Theodosius and Justinian. Translations of it into Syriac, Arabic and Armenian have come down to us, and it would seem that the work in these translations was greatly made use of as legal practice in the East (especially in the ecclesiastical Courts) for several centuries, having in some places more authority attached to it than had the Digest and Code of Justinian. As a repository of Roman law it is of little value, as it misunderstands or varies from that law in many respects, but it is of importance as showing how firmly Hellenic law and customs maintained themselves in the East during the decay of the Empire.⁶

Light has also been thrown upon the ante-Justinian law by the numerous papyri documents, mostly in Greek, that have been in recent years recovered in Egypt (especially by Grenfell and Hunt) and elsewhere. Mitrteis, Graetz and others have done much to elucidate these, by numerous publications.⁷ But to give anything like a consecutive account of them would occupy much space and cannot be attempted here.⁸

Romano-Barbarian Codes (Leges Romanae).⁹—Besides the collections of statutes and juristic law mentioned in this section, there were several official collections made prior to Justinian in Western Europe, after it had fallen under the dominion of Gothic and other kings. There are three of these which require special notice—each of them compiled from

documentary sources of ante-Justinian law. Though of considerable use in explicating difficulties and throwing up acumens in the earlier law sources, they must be used with caution for that purpose, as they contain not a few corruptions of the original texts. They are:

i. **Edictum Theoderici.**¹⁰—This was compiled at the instance of Theoderic, king of the Ostrogoths, not long after the year 500 (not later than 515). Theoderic after he had conquered Italy desired to be representative of the emperor and always acknowledged his suzerainty. He did not aim at being an independent legislator, and his Edict is therefore of limited scope and in no proper sense a code. Its materials were

mainly drawn, without however indication given, from the writings of Paul, the Gregorian, Hermogenian and Theodosian Codes, and the post-Theodosian Novels. Divided into 155 chapters, with no systematic arrangement, it touches upon all branches of the law, public and private, but especially criminal law and procedure. Though it contains a certain infusion of Gothic law and was expressly intended to apply to all Theoderic's subjects, both Gothic and Romans, it seems to have never been generally admitted that the law cannot have been fully realized, and that in some matters with which it deals, e.g. the law of the family, Gothic customs must still have continued to prevail for Gothic subjects.

2. **The Lex Romana Visigothorum or Breviarium Alarici or Alaricianum**¹¹ (both of these titles are modern) was a much more ambitious and important collection than the one last mentioned. It was compiled by a commission of lawyers appointed by Alaric II., king of the Western Goths, with approval of the bishops and nobles, and published at

Aix in Gascony in the year 506. The compilers selected their material partly from the *leges* (imperial constitutions after Diocletian) and partly from the *vetus jus* (juristic law), taking what they considered appropriate, without materially altering the text of their authorities except in the way of excision of passages that were obsolete or superseded. For the *leges* they utilized some 400 of the 3400 enactments (according to Haenel's estimate) of the Theodosian Code and about 30 of the Post-Theodosian Novels; for the *vetus jus* they made use of Paul's Sentences, Gaius's Institutes (in a corrupt and greatly abridged form in two books dating probably from, and adapted to the law of, the 5th century), the first book of Papinian's Responses (a single *responsio*), the *vetus Gregoriana* and Hermogenian Collection (which were treated as *jus*). All of these, except Gaius (for the reason mentioned), were accompanied by *interpretationes* (i.e. for the most part explanatory adaptations of the passages to the existing practice) which were largely borrowed from books in current use for purposes of instruction, and which resemble the interpretation of the XII. Tables in that they are often not so much explanatory of the text as qualificative or corrective. The Breviary exercised great influence in western Europe; and there is no question that, until the rise of the Bologna school in the end of the 11th century, it was from it more than from the books of Justinian that western Europe, other than Italy, acquired its scanty knowledge of Roman law.

3. **The Lex Romana Burgundorum**¹²—to which erroneously, about the 9th century, owing to a mistake of a MS. transcriber, the name *Papinianus* (a contraction of *Papinianus*) was given. It is a collection which King Gundobad, when publishing his code of native law (*Lex Gundobada*) for his native subjects, had promised should be prepared for the use of his Roman subjects. It was published probably before his death in 516. It deals with private law, criminal law and procedure, as suited to about forty-seven titles, and is arranged much in the same order as the *Gundobada*, from which it has a few extracts. Its statutory Roman sources are the same as those of the Breviary; its juristic sources are Paul's Sentences and a work of Gaius of which we cannot say with certainty that it is his Institutes. It also contains some *interpretationes* of the same character as those in the Breviary, but whether taken directly from the latter or not is disputed. After the conquest of the Burgundian kingdom by the Franks this code ceased to have any direct authority, but was used in the courts as a sort of supplement to the Breviary, being often bound in the same volume with the latter.

iii. Justinian's Legislation.

Justinian's Collections and his own Legislation.—The history of Justinian outside his legislative achievements, and his collections in detail, are dealt with in the article JUSTINIAN I. Ambitious to carry out a reform more complete even than that which Theodosius had planned but failed to execute, he took the first step towards it little more than six months after the death of his uncle Justin, in the appointment of a commission to prepare a collection of statute law (*leges*), among which he included the rescripts of the Gregorian and Hermogenian Codes, which were commonly at this period described as *vetus jus*. It was published in April 529; and in rapid succession there followed his Fifty Decisions

¹ Ed. Haenel (Leipzig, 1849); Conrat (Cohn), *Brev. Alaricianum* (1903). This work of Cohn is a systematic arrangement of the Breviary, with the Latin text as given by Haenel, and a translation into German of the *interpretatio* (or, where there is none, of the text itself), and some explanatory notes. See Karlowa, *Röm. R.G.* i. pp. 976 seq.; Krüger, *Quellen*, § 40.

² Ed. Bluhme in Pertz's *Monumenta Germaniae. Hist. Leges*, iii. pp. 505 seq. (Hanover, 1863); de Salis, *Monum. Germ. Leg.* sec. i. art. ii. p. 1 (Hanover, 1892). See Karlowa, *Röm. R.G.* i. pp. 983-985.

¹ For opinions as to its author, see Girard, *l.c.* p. 543. He must have been an ecclesiastic.

² *Collectio Jur. Antej.* iii. pp. 1 seq. (ed. Mommsen); Karlowa, *Röm. R.G.* i. pp. 969 seq.; Krüger, *Quellen*, pp. 298-302.

³ Mommsen, however (*Collectio*, iii. p. 11), thinks it was compiled about the time of Constantine.

⁴ *Collect. Jur. Antej.* iii. pp. 203-20; Girard, *Textes*, pp. 590 seq. See Krüger, *Quellen*, pp. 305-7.

⁵ Ed. by Bruns and Sachau under the name *Syrisch-Römisches Rechtsbuch aus dem fünften Jahrhundert* (Leipzig, 1880). See Esméin, *Mélanges*, pp. 403 seq.; Ferrini, *Z. d. Sav. Stift.* (1902), xxiii. pp. 101 seq.; Krüger, *Quellen*, pp. 320 seq.

⁶ The first volume of a complete collection of the versions of the Syrian Law-Book, with a translation into German by Sachau, was published at Berlin in 1907.

⁷ E.g. the *Ambrosii Papyri*, by Grenfell and Hunt. See *Archiv für Papyrologie* (since 1900).

⁸ For an account of the papyri found at Sinai, containing parts of a commentary on Ulpian, ad *Sabinum*, supposed to have been written after A.D. 438, see Muirhead, *Hist. introd.* p. 374; and Girard, *Textes*, p. 578. For other papyri, see Girard, *op. cit.* pp. 838-44.

⁹ See Krüger, *Gesch. d. Quellen*, § 41; Brunner, *Deutsche Rechtsgesch.* (1887), i. §§ 49, 50.

¹⁰ Ed. Bluhme in Pertz's *Monumenta Germaniae. Leges*, v. pp. 145 seq. (Hanover, 1875); see Savigny, *Gesch. d. r. R.* ii. pp. 172 seq.; Gaudenzi in *Z. d. Sav. Stift.* (*Ger. Abtheil.*), 1886, vii. pp. 29 seq.

West Gothic Code.

The Burgundian Code.

Justinian's codification.

(529-531), his Institutes¹ (November 21, 533), his Digest of excerpts from the writings of the jurists (December 16, 533),² and the revised edition of his Code, in which he incorporated his own legislation down to date (November 16, 534).³ From that time down to his death in 565 there followed a series of Novels (*novellae constitutiones*), mostly in Greek, which were never officially collected, and of which probably some have been lost.⁴

Taking his enactments in the Code and his Novels together, we have of Justinian's own legislation not far short of 600 constitutions. Diocletian's contributions to the Code are more than twice as numerous; but most of them professed to be nothing more than short declaratory statements of pre-existing law, whereas Justinian's, apart from his Fifty Decisions, were mostly reformatory enactments, many of those in the Novels as long as an average act of parliament, and often dealing with diverse matters under the same rubric. They cover the whole field of law, public and private, civil and criminal, secular and ecclesiastical. It cannot be said that they afford pleasant reading: they are so disfigured by redundancy of language, involved periods and nauseous self-glorification. But it cannot be denied that many of those which deal with the private law embody reforms of great moment and of most salutary tendency. The emperor sometimes loved to pose as the champion of the simplicity and even-handedness of the early law, at others to denounce it for its subtleties; sometimes he allowed himself to be influenced by his own extreme asceticism, and now and again we detect traces of subservience to the imperious will of his consort; but in the main his legislation was dictated by what he was pleased to call *humanitas* so far as the law of persons was concerned, and by *naturalis ratio* and public utility so far as concerned that of things. The result was the eradication of almost every trace of the old *jus Quiritium*, and the substitution for it, under the name of *jus Romanum*, of that cosmopolitan body of law which has contributed so largely to almost every modern system.

Changes in the Law of the Family.—With the Christian emperors, from Constantine downwards, almost the last traces disappeared of the old conception of the *familia* as an aggregate of persons and estate subject absolutely to the power and dominion of its head. *Manus*, the power in a husband over his wife and her belongings, was a thing of the past; both stood now on a footing of equality before the law; perhaps it might be more accurate to say, at least with reference to the Justinianian legislation, that the wife was the more privileged of the two in respect both of the protection and the indulgence the law accorded her. With *manus* the old confarreatio and coemption had ceased, marriage needing nothing more than simple interchange of consent, except as between persons of rank (*illustres*) or when the intention was to legitimate previous issue; in the latter case a written marriage settlement (*instrumentum dotale*) was required, and in the former both such a settlement and a marriage in church before the bishop and at least three clerical witnesses, who granted and signed a certificate of the completed union. The legislation of the Christian emperors on the subject of divorce, largely contributed to by Justinian in his Novels, has already been referred to. In regard to the *dos*, many new provisions were introduced, principally for curtailing the husband's power of dealing with it while the marriage lasted, enlarging the right of the wife and her heirs in respect of it, and simplifying the means of recovering it from the husband or his

heirs when the marriage was dissolved. Between the time of Constantine and that of Theodosius and Valentinian a new form of matrimonial settlement became established. It became apparently a legally sanctioned practice for a man to make (apart from ordinary marriage presents) a settlement on his intended wife either by actual transfer or by promise of a provision which was to remain his property (though without the power of alienation) during the marriage, but to pass to her on his predecease or on divorce by his fault. This got the name of *donatio ante nuptias*, or sometimes, as being a sort of counterpart for the *dos*, *anipherna*. There was some important legislation about it by the two last-mentioned emperors; Leo and Justin followed suit; and Justinian, in his Code and Novels, published five or six enactments for its regulation. The general result was that, wherever a *dos* was given or promised on the part of the wife, there a *donatio* of equal amount was to be constituted on the part of the husband; that, if one was increased during the marriage, a corresponding increase was to be made to the other; that it might be constituted or increased after the marriage without infringing the rule prohibiting donations between husband and wife, which caused Justinian to change its name to *donatio propter nuptias*; that the wife might demand its transfer to her, to the same extent as she could that of the *dos*, on her husband's insolvency, but under obligation to apply its income to the maintenance of the family; and that on the dissolution of the marriage by her husband's death or by a divorce for which he was in fault, she had an hypothec and other ample remedies for reducing it into possession.⁵

The change in the complexion of the relations between husband and wife under the Christian emperors, however, was insignificant when compared with that which had overtaken the relation between parent and child. Justinian in his Institutes reproduces the boast of Gaius that nowhere else had a father such power over his children as was exercised by a Roman *paterfamilias*. True it is that the *patria potestas* in name still held a prominent place in the Justinianian collections; but it had been shorn of most of the prerogatives that had characterized it in earlier periods. To expose a newborn child was forbidden under penalties. To take the life of a grown-up one—unless it was a daughter slain with her paramour in the act of adultery—was murder; for the domestic tribunal, with the judicial power of life and death in the *paterfamilias* as its head, had long disappeared.

Further, a parent could no longer sell his child save only when the child was an infant and he in such extreme poverty as to be unable to support it. Even the right to make a noxal surrender of his son to a party who had suffered from his delinquency had silently become obsolete; so greatly had altered sentiment, in sympathy with legislation, curtailed the power of the *paterfamilias* over those in his *potestas*. This *noxae deditio* was formally abolished by Justinian. All that remained of the *patria potestas*, in short, in the Justinianian law was little more than would be sanctioned in most modern systems as natural emanations of the paternal relationship.

Thus he had right of moderate chastisement for offences (for the infliction of graver punishments he had to apply to the magistrate), of testamentary nomination of guardians, of pupillary substitution (enlarged by Justinian), and of withholding consent from the marriage of a child, but subject in this last case to magisterial intervention if used unreasonably.

How the right of the *paterfamilias* over the earnings and acquisitions of his children was modified by the recognition of the *peculium castrense* has been shown in a previous page. But the modification was carried to such an extent by the Christian emperors as finally to negative the father's ownership altogether, except as regarded acquisitions that were the outcome of funds advanced by him to his child for his separate use (*peculium profectitium*). Of some of the child's acquisitions (*bona adventicia*) his father had, down to the time of Justinian, the life interest and right of administration; but by his legislation even these might be excluded at the pleasure of the parties from whom the acquisitions had been derived or by maladministration of the father.

By the classical law the father's radical right in his son's *peculium castrense* revived on the latter's death; for if he died intestate the former appropriated it not as his son's heir, but as an owner whose powers as such had been merely temporarily suspended. But by one of the chapters in the famous 118th Novel on the law of intestate succession even this prerogative of the *paterfamilias* was abolished, and all a child's belongings except his *peculium profectitium* were recognized as his own in death as well as in life, so that if any of them should pass to his parent on his intestacy it should only be by title of inheritance and in the absence of descendants.

In every other branch of the law of the family the same reforming spirit was manifested. Adoption of *filifamilias* was no longer followed in all cases by a change of family for the adoptee, but only when either the adopter was in fact one of his ancestors in whose

¹ The best edition is that of Krüger, which is prefixed to the stereotyped edition of the *Corpus Juris* by Mommsen, Krüger and Schoell, vol. i., and also published separately.

² The best edition is that of Mommsen, *Digesta Justiniani* (2 vols., Berlin, 1866-70), and also vol. i. of the stereotyped edition of the *Corpus Juris* mentioned in preceding note. A new and handy edition, however, based on that of Mommsen, by Bonfante and several other Italian professors, is now in course of publication. Books I.-XXVIII, were published up to 1908 (Milan). A collypey facsimile of the Florentine MS. of the Digest is also in course of publication in Italy. Fasciculi I.-VI, have already (1908) appeared (Rome, 1902-7).

³ The best edition is that of Krüger, forming vol. ii. of the *Corpus Juris* last mentioned.

⁴ The best edition is that of Schoell, completed by Kroll in 1895, and forming vol. iii. of the *Corpus Juris* last mentioned. It contains the Greek texts, Latin Vulgate and a Latin translation more correct than the Vulgate.

⁵ See Esemien, *Mélanges*, pp. 58-70; Mittelst, *Reichsrecht und Volksrecht in d. Ostl. Provinz*, deals with its history; pp. 256-262. Though beneficial on the whole, the regulations of Justinian on this matter seem rather too great an interference with the freedom of marriage settlements.

potestas he had never been, such as a paternal or maternal grandfather, when there was a natural *potestas* to underlie and justify the civil one—or when an ancestor gave in adoption a grandchild who was in his *potestas* but would not become *sui juris* by his death. The mode of strict adoption also was simplified, the old procedure by sales and manumissions, which degraded the child too much to the level of a slave, was abolished. The modes of legitimation of children born of a concubine, especially that by subsequent marriage of the parents, first introduced by Constantine, were regulated, and the extent of the rights of the legitimated issue carefully defined. Emancipation was simplified in a similar way to that of strict adoption. Tutory at law was opened to the pupil's nearest kinsman, whether on the father's side or the mother's; and the mother herself, or the child's grandmother, might be allowed, under certain conditions, to act as its guardian. Slavery was often converted into the milder condition of colonate; but, even where this did not happen, the rights of owners were not allowed to be abused; for slaves were permitted to claim the protection of the magistrate, and cruelty by a master might result in his being deprived of his human property. Kinship that had arisen between two persons when one or both were slaves (*seruilis cognatio*) was recognized as creative not only of disabilities but of rights. The modes of manumission were multiplied, and the restriction on the legatee in the early empire abolished; and a freedman invariably became a citizen, Junian Latinity and dedicatory being no longer recognized.

Amendments on the Law of Property and Obligation.—In the law of property the principal changes of the Christian Empire were the simplification of the forms of conveyance, the extension of the colonate, the introduction and regulation of emphyteusis and the remodelling of the law of prescription. Simplification of the forms of conveyance was necessary only in the case of *res mancipi*, for *res nec mancipi* had always passed by delivery. From the Theodosian Code it is apparent that movable *res mancipi* usually passed in the same way from very early in the period, and that in the mancipation of lands and houses—*res in jure cæcio* had disappeared with the formulæ system—*solennis traditio*, i. e. a written instrument and delivery following thereon, and both before witnesses, had been gradually substituted. Of this there is no trace in the Justinian Code. For Justinian abolished all remains of the distinction between *res mancipi* and *res nec mancipi*, between full ownership, bonitarian ownership and *nudum jus Quiritium*, placing movables and immovables on a footing of perfect equality so far as their direct conveyance was concerned. But, as regarded the possession required of an acquirer to cure any defect in the conveyance, he made a marked difference between immovables and movables. For, amalgamating the old positive usucaption of the *jus civile* with the negative prolonged possession—*longi temporis possessio*—that had been first introduced for immovables in the provinces (probably by the provincial edict), and afterwards by rescripts of Caracalla for movables,¹ he declared that possession on a sufficient title and in good faith should in future make the possessor legal owner of the thing possessed by him, provided that the possession of himself and his author had endured uninterruptedly for three years in the case of a movable, and in the case of an immovable for ten years if the party against whom he possessed was resident in the same province, or for twenty if he resided in another one.

The same causes that led to the colonate induced the introduction of emphyteusis,—an institution which had already existed in some of the Eastern provinces when independent, and which was first came to be utilized first by the emperors, then by the church, and afterwards by municipalities and private landowners, for bringing into cultivation the large tracts of provincial land belonging to them which were unproductive and unprofitable through want of supervision on the spot. Its nature and conditions (which bore a certain similarity to the earlier *jus in agro vectigali* of the Western Empire, with which it was ultimately fused), and to hereditary leases sometimes granted in the early Empire) were carefully defined by Zeno and amended by Justinian. The *emphyteuta*, as the grantee of the right was ultimately called, did not become owner; the grantor still remained *dominus*, all that the grantee enjoyed being a *jus in re aliena*, so extensive as hardly to be distinguishable from ownership. It conferred upon him and his heirs a perpetual right in the lands included in the grant, in consideration of a fixed annual payment to the lord (*canon*) and due observance of conventional and statutory conditions; but he was not entitled to abandon it, nor able to free himself of the obligations he had undertaken, without the lord's consent. The latter was entitled to hold the grant forfeited if the *canon* fell into arrear for three years (in church lands for two), or if the land-tax was in arrear for the same period, or if the *emphyteuta* allowed the lands to deteriorate, or if he attempted to alienate them (*alienare meliora-*

iones as the text says) without observance of statutory requirements. These were that he should intimate an intended alienation and the name of the intended alienee to the lord, so that the latter, before giving his assent, might satisfy himself that he would not be a loser by the transaction; and, if the alienation was to be by sale, he had to state the price fixed, so as to give the lord the opportunity of exercising his statutory right of pre-emption at the same figure. If those requirements were complied with, and the lord (himself declining to purchase) stated no reasonable objection to the proposed alienee, he was not entitled to resist the alienation, provided a payment (*laesum*) was made to him of 2% of the sale price or of the value of the lands in consideration of his enforced consent.

The changes in the law of obligation were more superficial than those in the law of property, and consisted principally in the simplification of formalities and in some cases **Obligations.** in their entire abolition. To describe them, however, would carry us into details which would here be out of place.

Changes in the Law of Succession.—The changes made in the law of succession by Justinian's Christian predecessors, especially Theodosius II. and Anastasius, were far from insignificant; but his own were in some directions positively revolutionary.

His testamentary *res æque et liberum* of the *jus civile* probably never obtained any firm footing in the East; for it was only by Caracalla's constitution conferring citizenship on all his free subjects that provincials generally acquired *testamenti factio*; and by that time a testament bearing externally the requisite number of seals had been recognized as sufficient for a grant of *honorum possessio* unchallengeable by the heirs-at-law, even though they were able to prove that neither *familiæ mancipatio* nor *testamenti mancipatio* had intervened. Hence the universal adoption of what Justinian calls the praetorian testament, which, however, underwent considerable reform at the hands of the emperors, notably Theodosius II. and Valentinian III., in the requirement (in the ordinary case) of signature by the testator and subscription by the witnesses, thereby becoming what Justinian calls the tripartite testament. There was much hesitating legislation on this subject before the law was finally established as it stands in the Justinian books; and even at the last we find it encumbered with many exceptions and reservations in favour of testaments that were merely deeds of division by a parent among his children, testaments made in time of plague, testaments made before a magistrate and recorded in books of court, testaments entrusted to the safe keeping of the emperor, and so forth. Codicils had become deeds of such importance as, in the absence of a testament, to be dealt with as imposing a trust on the heir-at-law; it was therefore thought expedient to deny effect to them unless attested by at least five witnesses. And a most important step in advance was taken by Justinian in the recognition of the validity of an oral *mortis causa* trust; for he declared that, if it should be represented to a competent judge that a person on his death-bed had by word of mouth directed his heir to give something to the complainant, the heir should be required either on his oath to deny the averment or to give or pay what was claimed.²

In the matter of intestacy there had been long a halting between two opinions—a desire still further to amend the law in the direction taken by the praetors and by the legislature in the Tertullian and Orphitican senatusconsults, and yet a hesitancy about breaking altogether from the time-hallowed principle of agnation. Justinian in his Code went far beyond his predecessors in making a mother's right of succession independent altogether of the *jus liberorum*; extending that of a daughter or sister to her descendants, without any deduction in favour of their descendants as freely as if there had been no *capitis deminutio minima*; applying to agnates the same *successio graduum* that the praetors had allowed to cognates, and so forth. But it was by his Novels, especially the 118th and 127th, that he revolutionized the system, by eradicating agnation altogether (except as regards adopted children) and settling the canons of descent—which were the same for real and personal estate—solely on the basis of blood kinship, whether through male or females, and whether crossed or not by a *capitis deminutio*. First came descendants of the intestate, male and female alike, taking *per capita* if all were of the same degree, *per stirpes* if of different degrees. Failing descendants, the succession passed to the nearest ascendants, and, concurrently with them, to brothers and sisters of full blood (*germani*) and (by Nov. 127) the children of any that had predeceased. Where there were ascendants alone, one-half of the succession went to the paternal line and one-half to the maternal; where there were ascendants and brothers and sisters, or only brothers and sisters, the division was made equally *per capita*; when children of a deceased brother or sister participated it was *per stirpes*. In the third class came brothers and sisters of half blood and their children, and grandchildren of brothers and sisters *germani*; the division was made on the same principle as in the second class. The fourth class included all other collateral relatives according to propinquity, apparently to the remotest degree, and without distinction between full and half blood;

The 118th Novel.

¹ Dig. xlv. 3. 9.

² See *Elia Lattas, Studi storici sopra il Contratto d'Emfiteusi nelle sue relazioni col Colonato* (Turin, 1868), chaps. 1 and 3; and François, *De l'Emphyteuse* (Paris, 1883); Beudouin in *Novæ rev. hist.* (1896), pp. 545 seq.; Karlowa, *Röm. R. G.* ii. pp. 1268 seq. The name comes from the obligation imposed upon the grantees to make plantations (*quærentibus*).

³ Inst. ii. 23, § 12.

but among those the nearest in degree excluded the more remote, and when all were of the same degree they took *per capita*.

A reform effected by Justinian by his 115th Novel ought not to pass unnoticed; for it rendered superfluous all the old rules about disinheritance and praeterition of a testator's children, practically abolished *bonorum possessio contra tabulas* as regards freeborn persons and established the principle that a child had, as a general rule, an inherent and indefeasible right to be one of his father's heirs in a certain share at all events of his succession, and that a parent had the same right in the succession of his child if the latter had died without issue. The enactment enumerated certain grounds upon which alone it should be lawful for a parent to disinherit his child or a child his parent, declaring that in every case of disinheritance the reason of it should be stated in the testament, but giving leave to the person disinherited to dispute and disprove the facts when the testament was opened. If a child who had not been disinherited—and one improperly disinherited was eventually in the same position—was not instituted to some share, however small, of his parent's *hereditas*, he was entitled to have the testament declared null in so far as the institutions in it were concerned, thus opening the succession to himself and the other heirs-at-law, without affecting additional provisions, such as bequests, nominations of tutors, &c.; and if the share to which he was instituted was less than his legitimum (*legitima* or *debita portio*) he was entitled to an action in supplement. The legitimum, which under the practice of the centumviral court had been one-fourth of the share to which the child would have been entitled *ab intestato*, had been raised by Justinian (by Novel 18) to one-third at least, and one-half where there were five or more entitled to participate. He did not allow challenge of the will to be excluded, as in the earlier *querela inofficiosi testamenti*, because the testator had made advances to his child during his life or left him a legacy which quantitatively equalled the legitimum; his idea was that a child was entitled to recognition by his parent as *one of his heirs*, and that to deny him that recognition without statutory grounds was to put upon him an indignity which the law would not permit.

Amongst the other beneficial changes effected by Justinian may be mentioned the assimilation so far as possible of *hereditas* and *bonorum possessio*, so that the latter might be taken like the former without formal petition for a grant of it; the equiparation of legacies and singular trust-gifts; and the application of some of their rules to *mortis causa donations*; the extension of the principle of "transmission" to every heir without exception, so that, if he died within the time allowed him for considering whether or not he would accept (*tempus deliberandi*), his power of acceptance passed to his heirs, and that the same respect by them within what remained of the period of introduction of entry under inventory (*cum beneficio inventarii*), which limited the heir's responsibilities and rendered unnecessary the nine or twelve months of deliberation; and the application of the principle of collation to descendants generally, so that they were bound to throw into the mass of the succession before its partition every advance they had received from their parent in anticipation of their shares.

iv. The Justinianian Law-Books.

Their Use in the Courts and in the Schools.—Although the Institutes were primarily intended to serve as a text-book in the schools, it was expressly declared that it and the Digest and the Code should be regarded as just so many parts of one great piece of legislation and all of equal authority; and that, although Digest and Code were but collections of common law and legislation that had proceeded originally from many different hands, yet they were treated as the same respect as if they had been the work of Justinian himself. But, while everything within them was to be held as law, nothing outside them was to be looked at, not even the volumes from which they had been collected; and so far did this go that, after the publication in 529 of the revised Code, neither the first edition of it nor the Fifty Decisions were allowed to be referred to. If a case arose for which no precedent was to be found, the emperor was to be resorted to for his decision, as being outside his collections the only fountain of the law. To preserve the purity of the texts Justinian forbade the use of conventional abbreviations (*sigla*) in making transcripts, visiting an offender with the penalties of falsification (*crimen falsi*). Literal translations into Greek were authorized, and indeed were necessary for many of his subjects; so were indexes and *paraphrases*, i.e. summaries of parallel passages, texts or individual titles. Commentaries and general summaries were forbidden under heavy penalties, as an interference with the imperial prerogative of interpretation.¹ But these prohibitions do not seem to have been enforced, as we have accounts and remains not only of translations but of commentaries, notes, abridgments, excerpts and general summaries even in Justinian's lifetime. These, it is true, were mostly by professors (*antecessores*), and their productions may have been intended primarily for educational purposes; but they soon passed into the hands of the practitioners and were used without scruple in the courts. A Greek *Paraphrase of the Institutes*, usually

attributed to Theophilus, a professor in Constantinople and one of Justinian's commissioners, has been supposed to have been used by him in his prelections. It embodies much more historical matter than is to be found in the Institutes; but it contains a good many inaccuracies and its value has been very differently rated by different critics. Its latest editor, Ferrini, who puts a high estimate on it, is of opinion that the original of it was a reproduction in Greek of Gaius, drawn up at Beirut, which was remodelled after the plan of Justinian's Institutes, and had the new matter of this latter work subsequently incorporated in order to adapt it to the altered conditions; but he denies that there is any sufficient authority for ascribing it to Theophilus. If he be right in assuming that it was really based on a redaction of Gaius, its historical explanations will be received with all the more confidence.²

Fate of the Justinianian Books in the East.—The literary work indicated in the preceding section was continued throughout the 6th century. But the next three were comparatively barren, the only thing worth noting being the *Ἐκλογὴ τῶν νόμων* or *σύντομος γερουσία* of Leo the Isaurian in 740, professedly an abstract of the whole Justinianian law amended and rearranged; but it was repealed by Basil the Macedonian on account of its imperfections, and the emperor proceeded from the law as it pretended to summarize. The last-named emperor, followed by his son Leo the Philosopher, set themselves in the end of the 9th and beginning of the 10th centuries to the production of an authoritative Greek version of the whole of the Justinianian collections and legislation, omitting what had since become obsolete, excising redundancies, and introducing such of the post-Justinianian legislation as they thought merited preservation. The result was the *Basiliica* (Τὰ Βασιλικὰ, sc. νόμοι), which was completed and published in the reign of Leo, though begun in the reign of Basil, who also published a sort of institutional work, entitled *Πρόλογος*, which was revised and republished by Leo under the name of *Ἐπιτομὴ τῶν νόμων*. The *Basiliica* consists of sixty books, subdivided into titles, following generally the plan of the Justinianian Code, but with the whole law on any particular subject arranged consecutively, whether from Institutes, Digest, Code or Novels (see article *BASILICA*). Leo's son, Constantinus Porphyrogenitus, made an addition to it in the shape of an official commentary collected from the writings of the 6th-century jurists, the so-called *Παραγραφαὶ τῶν παλαιῶν*, which is now spoken of as the *scholia* to the *Basiliica*, and has done good exegetical service for modern civilians. Later annotations by jurists of the 10th to the 12th century are also called *scholia* but are of less value. The *Basiliica* retained its statutory authority until the fall of the Byzantine Empire in 1453. But long before that it had fallen into neglect in practice; and though nearly the whole of it and a great part of its *scholia* have come to us, yet not a single complete copy of it exists. Its place was taken by epitomes and compendia, the last being the *Ἐξήμβιβος* of Constantinus Harmenopoulos about 1345, "a miserable epitome of the epitomes of epitomes," as Bruns calls it, which survived the vicissitudes of the centuries, and finally received statutory authority in the modern kingdom of Greece in the year 1835, in place of the *Basiliica*, which had been sanctioned thirteen years before, in 1822.³

Their Fate in the West.—Before the rise of the Bologna school it was to a much greater extent from the Romano-Barbarian codes than from the books of Justinian that central and western Europe, apart from Italy, derived their acquaintance with Roman law. Theoderic's Edict can have had little influence after Justinian's recovery of Italy, and the Romano-Burgundian law was no doubt gradually displaced by Alaric's Breviary after Burgundy had fallen into the hands of the Franks; but the Breviary itself found its way in all directions in France and Germany, penetrating even into England, mainly through the agency of the church. There must, however, have been other repertoires of Roman law in circulation (and among others probably either Gaius's Commentaries or Ulpian's Rules), as witness a testament made in Paris in the end of the 7th century, mentioned by Savigny as preserved by Mabillon, in which the testator uses the old formula of the *ius civile*,—"in *ius lego. His testator, ut nos Ostrivus testamentum mihi perhibebat*," words that are not to be found either in the Visigothic or the Justinianian collections. We know that in his pragmatic sanction of the year 554, Justinian anew accorded his imperial sanction to the *jura* and *leges*, i.e. the Digest and Code, which he says he had long before transmitted to Italy, at the same time declaring that his Novels were to be of the same authority there as in the East. "Two years after this came Julian's Latin epitome of the Novels (a private work by a Constantinopolitan professor), not improbably prepared by command of the emperor himself. That Justinian's works soon came

¹ Editions by Reitz, 1751, and Ferrini, 1884-97.

² Ed. Heimbach, 6 vols. with Latin translation (and in 1846 a supplement by Zachariae a Lingenthal), Leipzig, 1833-70. A new supplement forming vol. 7, by Ferrini and Mercati, was published in 1897.

³ For the history of Byzantine law subsequent to Justinian, see Zachariae, *Geschichte des Griechisch-Röm. Rechts* (3rd ed., 1892), and *Historia juris Graeco-Romani* (1839); Mortreuil, *Histoire du droit byzantin* (3 vols., 1843-46).

¹ *Const. Deo Auctore*, § 12; *Tanla*, § 21.

to some extent into use in Italy is beyond question; for there is preserved in Marini's collection the testament of one Mannanes, executed at Ravenna in the reign of Justinian's immediate successor Justin II., in which the requirements of both Code and Novels are scrupulously observed. Of other monuments of the same period that prove their currency in Italy several are referred to by Savigny in the second volume of his *History of the Roman Law in the Middle Ages*, among which may be mentioned the Turin gloss of the Institutes, which Fitting ascribes to about the year 545,¹ and two little pieces known as the *Dicatum de consiliariis* and the *Collectio de tutoribus*.² The invasion of the Lombards, the disturbance they caused in Italy for two centuries, and the barrier they formed between it and the rest of Europe militated against the spread of the Justinianian law northwards; but it was taught (from the 6th to the 11th century) without much interruption at law schools in Rome, and also at Ravenna, the seat of the exarchs, to which (but this is doubtful) the school (*studium*) of Rome, revived by Justinian, is said to have been transferred in the 11th century. By the Lombards, as their savagery toned down, the Roman law was so far recognized that they allowed it to be applied to the Romans living within their territory, and it is said even to have been taught in Pavia, which they had established as their capital. Their overthrow by Charlemagne opened an outlet for it beyond Italy; and there is evidence that in the 9th century Justinian's works, or some of them, were already circulating in the hands of the clergy in various parts of Europe. Yet there are few remains of any literature of this period indicating much acquaintance with them. The only writings worth mentioning are the so-called *Summa Perusina*, an abridgment of the first eight books of the Code ascribed to the 7th century; the Lombardic *Quaestiones ad Monia* containing observations on the Germanic and Roman laws with texts drawn from the Institutes, the Digest, the Code and Julian's Epitome, and supposed to have been written early in the 11th century; the so-called *Brachylogus*,³ in large part a sort of abbreviated revision of Justinian's Institutes, but with references also to his other books, which Fitting and others hold to have been written in France (perhaps Orleans), possibly by a pupil of Irenaeus, about the very beginning of the 12th century; and the *Petri Exceptiones legum Romanorum*, a similar systematic composition of the Institutes, which Fitting ascribes to the 11th century earlier than Irenaeus's *Summa*. Both the *Brachylogus* and the *Petrus* were mainly compiled from pure Justinianian sources.

Apart from these remains a word may here be said about the work of the glossarists.⁴ It was at the very end of the 11th century that at the law school of Bologna, then under the guidance of the celebrated Irenaeus, the study of Roman law began somewhat suddenly to attract students from all parts of

Europe. Partly through ignorance and partly through the action of the clergy, the parts of the Justinianian legislation that had hitherto been ordinary use were the Institutes, the Code and the Novels. The first, from its elementary character, had naturally commended itself; the Code and the Novels, with their abundant legislation on matters ecclesiastical, were in many respects charters of the church's privileges, and were prized accordingly; but the Digest, as being the work of pagan jurists, had been looked on askance and practically little used. The Code and the Novels, however, with their modicum of wheat concealed in a great quantity of chaff, offered little attraction to laymen of intelligence; and, when under the guidance of Irenaeus their attention was first concentrated on the Digest, it must have come to them as a sort of revelation. Dogmatic and exoteric teaching of the *Corpus Juris* in all its parts was actively begun, and a new school arose called the glossarists (*glossatores*), of whom Irenaeus has always been rightly regarded as the founder. This great man, who is said to have been trained both in logic and rhetoric and to have afterwards studied and taught law at Rome before coming to Bologna, was more than a glossator. He was also the first of the medievalists to treat the law in a scientific way. In his *Summa Codicis* (a work attributed to him by Fitting on evidence which seems almost conclusive) he produced for his contemporaries and successors an independently planned and so far systematic manual of the subject-matter of the Code, omitting the last three books.⁵ The subject was treated in full relation to the other parts of the *Corpus Juris*, but follows in general the titles of the Code. The glossators got their name from the *glossae*, i.e. marginal and interlinear annotations (both grammatical and doctrinal) with which they furnished the texts of the

Corpus Juris which were in their hands. They also wrote *summae*, *casus*, *brocarda*, &c., for use both in the courts and the schools, and occasionally special treatises. They confined their work entirely to the *Corpus Juris*, being almost wholly ignorant of the history of the law. Beginning with Irenaeus, the school lasted for about a century and a half, and ended with Franciscus Accursius, who died in 1260 after having made a systematic but summarized collection of the glosses of his predecessors, which was afterwards known as the *Glossa Ordinaria* or "The Great Gloss." Among the more famous representatives of the school (other than Irenaeus) were, in the 12th century, Bulgarus, Martinus, Jacobus and Hugo, known as the *quatuor doctores*, and Accursius himself. To these may be added Placentinus and Vacarius of the 12th and Azo and Odofredus of the 13th century. The Digest, as used by the glossarists, was divided into three parts, known as *Digestum Vetus* (books 1-24, tit. 2), *Infirmitatum* (books 24, tit. 3-38), and *Digestum Novum* (books 39 to the end). The manuscripts of these, as used by the glossarists, are called the *Vulgatae (lectio Vulgatae)*, to distinguish them from the Florentine Manuscript (*lectio Pisana*), on which, indeed (or on the same original source as it), they were probably all primarily based, but from which, as far as at least as book 33, they varied in numerous readings. The historical explanation of the cause of this just-mentioned threefold division is given by Mommsen in the preface to his larger edition of the Digest, to which it will be sufficient to refer.⁶ The whole *Corpus Juris* was by the glossarists distributed into five volumes, viz. the three just named; a fourth, containing the first nine books of the Code, and the fifth, containing the Institutes; the last two containing the Novels in Latin (known as the *Authenticum*?), and the last three books of the Code.

The success of the Accursian gloss was rather detrimental to scientific development of the law. It became a sort of code in itself which both in the schools and the courts tended to supersede the texts of Justinian. The intelligent study of the Sources was neglected while lawyers devoted themselves to subtle distinctions and useless divisions of subject-matter. It led to the application during the 14th and 15th centuries of the methods of *scholasticism* to the Roman law. The authors of this scholastic jurisprudence, which prevailed during the greater part of these centuries, have been called post-glossators and *scribentes* or commentators. Their most noted representative was Bartolus (1314-1357), after whom they were often called Bartolists. This school, however (mainly Italian), did much towards developing a definite system of common law in Italy based on the Roman, and thereby facilitated the reception of Roman law in Germany and other countries.⁷

In the 16th century a new start, or, so to say, second renaissance was given to the Roman law. The study of classical antiquities, so active on the side of literature, extended to jurisprudence also. The juridical writings which had been handed down from the Romans ceased to be regarded purely as positive law, binding according to the letter, but as a part of ancient tradition whose spirit as well as form must be examined by the light of the past. Among the pioneers in this new method, to whom the name of Humanists has been given, must be specially mentioned Alciatus (1492-1540), Cujacius (1522-1590) and Donellus (1527-1591). Medievalism has passed away, and with these jurists began what has been called the modern Roman law, to describe which, however, is entirely beyond the province of this article. (H. Go.)

ROMANOS, called ὁ μελωδός, Greek hymn-writer, "the Pindar of rhythmic poetry," was born at Emesa (Homs) in Syria. From the scanty notices of his life we learn that he resided in Constantinople during the reign of the emperor Anastasius.⁸ Having officiated as a deacon in the church of the Resurrection at Berytus, he removed to Constantinople, where he was attached to the churches of Blachernae and Cyrus. According to the legend, when he was asleep in the last-named church, the Virgin appeared to him and commanded him to eat a scroll. On awaking (it was Christmas Day), he immediately mounted the pulpit, and gave forth his famous hymn on the Nativity. Romanos is said to have composed more than 1000 similar hymns or *kontakia* (Gr. *κοντάκιον*, "scroll") celebrating the festivals of the ecclesiastical year, the lives of the saints and other sacred subjects—on the death of a monk (extremely impressive); the last judgment; the treachery of Judas; the martyrdom of St. Stephen; Simeon

¹ Fitting, *Über die sogenannte Turiner Institutionen-glosse* (Halle, 1870); cf. Conrat, *Gesch. d. Quellen u. Lit. d. röm. R. im früheren Mittelalter*, vol. 1, p. 180 seq., Leipzig, 1891.

² Conrat at *ibid.*, p. 137.

³ *Brachylogus Iulius Juris civilis* is a fuller title given to it. It has also been called *Corpus legum*. It first got the name *Brachylogus* in the 16th century.

⁴ Savigny, *Geschichte d. r. R.* vols. 3-5.

⁵ See *Summa Codicis* of Irenaeus by Fitting (Berlin, 1894). Two other works attributed to Irenaeus, called respectively *Quaestiones de Substantialibus Juris* and a treatise *De Aequitate*, have been edited by the same author. See also Fitting, *Z. d. Sav. Stifft.* xvi, pp. 1 seq.

⁶ *Digesta Justiniani Augusti*, recognovit Th. Mommsen (Berlin, 1870).

⁷ *Ueber authentificorum*. So called because it contained a more complete collection and correcter translation of the Greek Novels than the Epitome of Julian. It was the one used in the law courts in the middle ages.

⁸ See Sohm, *Institutionen*, § 27, and authorities there cited.

⁹ On the question whether Anastasius I. (491-518) or II. (713-716) is meant, see Krumbacher, who is in favour of the earlier date.

Stylites; paschal and pentecostal hymns. The MS. of the hymns, written by his own hand, was said to have been preserved in the church of Cyrus, in which he was buried and celebrated as a saint on the 1st of October. Prof. C. Krumbacher, who has edited the works of Romanos from the best (the Patmos) MSS., regards him as the greatest poet of the Byzantine age, and perhaps the greatest ecclesiastical poet of any age.

Editions: J. B. Pitra, *Analecta Sacra*, i. (1876), containing 29 poems, and *Sanctus Romanus Veterum Melodorum Princeps* (1888), with three additional hymns from the monastery of St John in Patmos. See also Pitra's *Hymnographie de l'Église grecque* (1867); C. Krumbacher, *Geschichte der byzantinischen Litteratur* (1897); and *Hymns*.

ROMANOV, the name of the Russian imperial dynasty, reigning in the male line from 1613 to 1730, and thenceforward in the female line. The Romanovs descended from Andrei, surnamed Kobyla, who is said to have come to Moscow from Prussia about 1341 to enter the service of the grand-duke Semen (d. 1355). His son Feodor, surnamed Koschka, was the ancestor of the families of Suchovo-Kobylin, Kalystschev and Scheremetjev, as well as of the Romanovs. Feodor's grandson, Sakhariya Ivanovich, was a boyar of Vasili V., grand-duke of Moscow at intervals between 1425 and 1462, and the family took its name from his grandson Roman, whose daughter Anastasia Romanovna married the tsar Ivan the Terrible. Her brother Nikita Romanovich married the princess Eudoxia Alexandrovna, a descendant of Andrei Jaroslavovich, grand-duke of Susdal-Vladimir (d. 1264), and in this way the Romanovs were linked up with the ancient royal house of Rurik. The Romanovs suffered heavily in the disorders following on the death of Ivan. Some were executed and others exiled. Nikita's son Feodor (the archimandrite Philaret) was banished, but was recalled by the false Demetrius. In 1610 he was imprisoned by the king of Poland, but his piety and virtues led to the election of his son, Mikhail Feodorovich Romanov, to the throne of the tsars in 1613. Philaret became patriarch of Moscow in 1619, and supported his son's government until his death in 1634. Mikhail was seventeen when he began his reign, and died in 1645. He was succeeded by his son Alexis, whose three sons, Feodor III., Ivan II. and Peter I. (the Great), inherited the throne. After the two years' reign of Peter's widow, Ekaterina Aleksievna Skavronska (Catherine I.), his grandson, Peter Aleksievich (Peter II.), succeeded. He died in 1730, and the succession devolved on the family of Ivan II., on his daughter Anna (1730-40) and his great-grandson Ivan III., and in 1741 on Elizabeth, daughter of Peter the Great. Peter's elder daughter, Anna, had married Charles Frederick of Holstein-Gottorp, and with the accession of her son, Peter III., in 1762 begins the present reigning dynasty of Holstein-Gottorp or Oldenburg-Romanov.

See R. Nisbet Bain, *The First Romanovs* (1905); P. V. Dolgorukov, *Notice sur les principales familles de la Russie* (2nd ed., Berlin, 1858).

ROMAN RELIGION. In tracing the history of the religion of the Roman people we are not, as in the case of Greece, dealing with separate, though interacting, developments in a number of independent communities, but with a single community which won its way to the headship first of Latium, then of Italy and finally of a European empire. But this very fact of its ever-extending influence, coupled with an absence of dogmatism in belief, which made it at all times ready and even anxious to adopt foreign customs and ideas, gave its religion a constantly shifting and broadening character, so that it is difficult to determine the original essentials. By the time when Latin literature begins, the genuine Roman religion had already been overlaid by foreign cults and modes of thought, by the classical period it was—except in formal observance—practically buried and to a large extent fossilized. But the comparative study of religions has suggested the lines of reconstitution and the careful analysis of survivals embedded in literature and the evidence of monumental remains, and in particular

of the old calendars, has enabled modern scholars to make good progress in the task of separating the elements due to different periods and influences.

The Roman people were of Aryan stock, a section of a host of invaders from the north, who overran and settled in the Italian peninsula. They preserved traces of their original nationality not merely in the general cast of their religious thought, but in certain common features such as the worship of the hearth (Vesta) and of the sky-divinity (Jupiter) (see GREEK RELIGION). But the development of their religion was arrested at an earlier stage than that of the Greeks: with them—at any rate in the genuine Roman period—Animism never passed into Anthropomorphism; they stopped at the conception of the "spirit" without reaching that of the "god." Their belief might be described as a polydemonism rather than a polytheism, or more correctly, to avoid altogether the intrusion of foreign notions, as a "multinuminism."

In the cult and ritual of Rome there are enshrined many survivals from a very early form of religious thought prior to the development of the characteristic Roman attitude of mind. Fetichism—the belief in the magic or divine power of inanimate objects—is seen in the cult of stones, such as the *silex* of Jupiter (Iuppiter), which plays a prominent part in the ceremonial of treaty-making, and the *lapis* used in the ritual of the *aqueclitium*, a process, probably magic in origin, designed to produce rain after a long drought. The boundary-stones between properties (*termini*) were also the objects of cult at the annual festival of the Terminalia, and the "god Terminus," the symbolic boundary-stone, shares with Jupiter the great temple on the Capitol. Tree-worship (*q.v.*) again is a constantly recurring feature, seen, for instance, in the permanently sacred character of the *ficus Ruminalis* and the *caprificus* of the Campus Martius, and above all in the oak of Iuppiter *Feretrius*, on which the *spolia opima* were hung after a victory. Nor did Roman fetichism stop short at natural objects. The household was always the centre of religious cult, and certain objects in the house—the door, the hearth, the store-cupboard (*penus*)—seem always to have had a sacred significance, and so became the objects and later the sites of the domestic worship. Of the cult of animals there is just sufficient trace to show that it must formerly have had its place in religious rite; the animals, once the objects of worship, appear in later times as the attributes of divinities, for instance, the sacred wolf and woodpecker of Mars.

But Fetichism must very early have developed into Animism, the feeling of the sacredness of the object into the sense of an indwelling spirit. In the animistic attitude we have indeed the true background of the genuine Roman religion; but its characteristic and peculiar development is a kind of "higher Animism," which can associate the "spirit" not merely with visible and tangible objects, but with states and actions in the life of the individual and the community. No doubt the later *indigumenta* ("bidding-prayers") which give us detailed lists of the spirits which preside over the various actions of the infant, or the stages in the marriage ceremony, or the agricultural operations of the farmer, are due in a large measure to deliberate pontifical elaboration, but they are a true indication of the Roman attitude of mind, which reveals itself continually in the analysis of the cults of the household or the festivals of the agricultural year.

The "powers" (*numina*, not *dei*), which thus become the objects of worship, are spirits specialized in function and limited in sphere. They are not conceived of in any anthropomorphic form, their sex even may often be indeterminate ("sive mas, sive femina" is the constantly recurring formula of prayer), but the sphere of action of each is clearly marked and an appeal to a spirit outside his own special sphere would never even be thought of. Locality thus becomes an important point in the conception of the *numen*: the household spirits must be worshipped at the door, the hearth, the store-cupboard, and the external spirits of the fields and countryside have their sacred hill-tops or groves. But the *numen* has no form of sensuous representation, nor does he need a house to dwell in; statue and temple are alien to the spirit of Roman religion. Nor are the *numina*, not being anthropomorphic, capable of relation

Fetichism.

Animism.

to one another: hence there is no Roman mythology. Yet, all-powerful in their individual spheres of action, they can influence the fortunes of men and can enter into relations with them. The primary attitude of man to the *numina* seems clearly to be one of fear, which survives prominently in the "impish" character of certain of the spirits of the countryside, such as Faunus and Iunus, and is always seen in the underlying conception of *religio*, a sense of awe in the presence of a superhuman power. But the practical mind of the Roman gives this relation a legal turn: the *ius sacrum*, which regulates the dealings of men with the divine powers, is an inseparable part of *ius publicum*, the body of civil law, and the various acts of worship, prayer and thanksgiving are conceived of under the legal aspect of a contract. The base-notion is that the spirits, if they are given their due, will make a return to man: the object of the recurring annual festivals is to propitiate them and forestall any hostile intention by putting them, as it were, in debt to man—more rarely to express gratitude for benefits received.

In such a religion exactness of ritual must play a large part—so large, indeed, that many modern critics have been misled into regarding the Roman religion as a mere network of formalities without any background of genuine religious feeling. This formalism shows itself in many ways. It is necessary in the first place to make quite certain that the right deity is being addressed: hence it is well to invoke all the spirits who might be concerned, and even to add a general formula to cover omissions: here we have the ritual significance of the *indigitamenta*. Place, again, as we have seen, was an essential element even in the conception of the *numen*, and is therefore all-important in ritual. So, too, is the character of the offering: male victims must be sacrificed to male deities; female victims to goddesses: white animals are the due of the *di superi*, the gods of the upper world, black animals of the gods below. Special deities, moreover, will demand special victims, while the more rustic *numina*, such as Pales (*q.v.*), should be given milk and millet cakes rather than a blood-offering. All-important, too, is the order of ceremonial and the formula of prayer: a mistake or omission or an unpropitious interruption may vitiate the whole ritual, and though such misfortunes may occasionally be expiated by the additional offering of a *piaculum*, in more serious cases the whole ceremony must be recommenced *ab initio*. Herein lies the importance of the priesthood: the priest is not, as in other religions, the mediator between god and man, but on the one hand for the purpose of state-worship the chosen representative of the whole people, on the other the repository of tradition and ritual lore.

This conception of the nature of the *numina* and man's relation to them is the root notion of the old Roman religion, and the fully-formed state cult of the *di indigetes* even at the earliest historical period, must have been the result of long and gradual development, of which we can to a certain extent trace the stages. The original settlement on the Palatine, like its neighbour on the Quirinal, was an agricultural community, whose unit both from the legal and religious point of view was not the individual but the household. The household is thus at once the logical starting-point of religious cult, and throughout Roman history the centre of its most real and vital activity. The head of the house (*paterfamilias*) is the natural priest and has control of the domestic worship: he is assisted by his sons as acolytes (*camilli*) and deutes certain portions of the ritual to his wife and daughters and even to his bailiff (*vilicus*) and his bailiff's wife. The worship centres round certain *numina*, the spirits indwelling in the sacred places of the original round but in which the family lived. Janus, the god of the door, comes undoubtedly first, though unfortunately we know but little of his worship in the household, except that it was the concern of the men. To the women is committed the worship of the "blazing hearth," Vesta, the natural centre of the family life, and it is noticeable that even to Ovid (*Fast.* vi. 291-92) the conception of Vesta was still material and not anthropomorphic. The Penates (*q.v.*) were the *numina* of the store-cupboard, at first vague and animistic, but later on, as the definite *deus*-notion was developed, identified with certain of the other divinities of household or state religion.

To these *numina* of the sacred places must be added two other important conceptions, that of the *Lar familiaris* and the *Genius*. The *Lar familiaris* has been regarded¹ as the embodiment of all the family dead and his cult as a consummation of ancestor-worship, but a more probable explanation regards him as one of the Lares (*q.v.*); *numina* of the fields worshipped at the *compita*, the places where properties marched) who had special charge of the house or possibly of the household servants (*familia*); for it is significant that his worship was committed to the charge of the *vilica*. The *Genius* is originally the "spirit of developed manhood," the *numen* which is attached to every man and represents the sum total of his powers and faculties as the *Juno* does of the woman: each individual worships his own *Genius* on his birthday, but the household-cult is concerned with the *Genius* of the *paterfamilias*. The established worship of the household then represents the various members of the family and the central points of the domestic activity; but we find also in the ordinary religious life of the family a more direct connexion with morality and a greater religious sense than in any other part of the Roman cult. The family meal is sanctified by the offering of a portion of the food to the household *numina*; the chief events in the individual life, birth, infancy, puberty, marriage, are all marked by religious ceremonial, in some cases of a distinctively primitive character. The dead, too, though it is doubtful whether in early times they were actually worshipped, at any rate have a religious commemoration as in some sense still members of the family.

The next stage in the logical development of the state religion should naturally be found in the worship of the *gens*, the aggregate of households belonging to one clan, but our information about the gentile worship is so scanty and uncertain² that we cannot make practical use of it. It is more profitable to turn from the life of the household to the outdoor occupations of the fields, where the early Roman settler met with his neighbours to celebrate the various stages of the agricultural year in religious ceremonies which afterwards became the festivals of the state calendar. Here we have a series of celebrations representing the occupations of the successive seasons, addressed sometimes to *numina* who developed later on into the great gods of the state, such as Jupiter, Mars or Ceres, sometimes to vaguer divinities who remained always indefinite and rustic in character, such as Pales and Consus. Sometimes again, as in the case of the Lupercalia (*q.v.*), the attribution is so indefinite that it is hard to discover who was the special deity concerned; in other cases, such as those of the Robigalia and the Meditrinalia, the festival seems at first to have been addressed generally to any interested *numina* and only later to have developed an eponymous deity of its own. Roughly we may distinguish three main divisions of the calendar year, the festivals of Spring, of the Harvest and of Winter, preserving on the whole their peculiar characteristics. (1) In the Spring (it must be remembered that the old Roman calendar began the year with March) we have ceremonies of anticipation and prayer for the crops to come: prominent among them are the *Fordicidia*, with its symbolic slaughter of pregnant cows, addressed to Tellus, the *Cerealia*, a prayer-service to Ceres for the corn-crop, and the most important of the rustic celebrations of lustration and propitiation, the *Parilia*, the festival of Pales. To these must be added the *Ambarvalia* (*q.v.*), the lustration of the fields, a movable feast (and therefore not found in the calendars) addressed at first to Mars in his original agricultural character (see MARS). (2) Of the Harvest festivals the most significant are the twin celebrations on August 21st and 25th to the divinity-pair Consus and Ops, who are both concerned with the storing of the year's produce, and two mysterious vintage festivals, the *Vinalia Rustica* and the *Meditrinalia*, connected originally with Jupiter. (3) The Winter festivals are less homogeneous in character, but we may distinguish among them certain undoubtedly agricultural celebrations, the *Saturnalia* (at first connected with the sowing of the next year's crop, but afterwards overlaid with Greek ceremonial), and a curious repetition of the harvest festivals to Consus and Ops.

¹ *q.v.*, by De Marchi.

² See, however, De Marchi, *Il Culto Privato di Roma Antica*, vol. ii.

In passing to the religion of the state we are clearly entering on a later period and a more developed form of society. The loose aggregation of agricultural households gives place to the organized community with new needs and new ideals, and at the same time in religious thought the old vague notion of the *numen* is almost universally superseded by the more definite conception of the *deus*—not even now quite anthropomorphic, but with a much more clearly realized personality. We find then two prominent notes of the state influence, firstly, the adaptation of the old ideas of the household and agricultural cults to the broader needs of the community, especially to the new necessities of internal justice between citizens and war against external enemies, and secondly the organization of more or less casual worship into something like a consistent system. Adaptation proceeds at first naturally enough on the lines of analogy. As Janus is in the household the *numen* of the door, so in the state he is the god associated with the great gate near the corner of the forum: the Penates have their analogy in the *Di Penates populi Romani Quirinus* by whom the magistrates take their oath on entering office, the *Lar familiaris* in the *Lares Praestites* of the community, and the *Genius* in the new notion of the *Genius populi Romani* or *Genius urbis Romae*. But the closest and most curious analogy is seen in the case of Vesta. The Vesta of the state is in fact the king's hearth, standing in close proximity to the *Regia*, the king's palace; the Vestal Virgins, who have charge of the sacred fire, are the "king's daughters," and as such even in republican times were in the *manus* of the *pontifex maximus*, who was the successor of the king on the legal side of his religious duties, as the *rex sacrorum* was on the sacrificial side. But adaptation meant also reflection and the widening of old conceptions under the influence of thought and even of abstract ideas. Thus, the simple reflection that the door is used for the double purpose of entrance and exit leads to the notion of the Janus of the state as *bifrons* ("two-faced"): the thought of the door as the first part of the way to which one comes, produces the more abstract idea of Janus as the "god of beginning," in which character he has special charge of the first beginnings of human life (*Consuetus*), the first hour of the day, the Calends of the month and the first month of the year in the later calendar: for the same reason his name takes the first place in the *indigitamenta*. But development proceeds also on broader and more important lines. Jupiter in the rustic-cult was a sky-god concerned mainly with the wine festivals and associated with the sacred oak on the Capitol. Now he develops a twofold character: as the receiver of the *spolia opima* he becomes associated with war, especially in the double character of the slayer of rout (*Stator*) and the giver of victory (*Victor*), in which last capacity he later gives birth to an offshoot in the abstract conception of the goddess Victoria. As the sky-god again he is appealed to as the witness of oaths in the special capacity of the *Dius Fidius*, producing once more an abstract offshoot in the goddess Fides. In these two conceptions, justice and war, lie the germs of the later idea of Jupiter as the embodiment of the life of the Roman people both in their internal organization and in their external relations. In much the same manner Mars takes on in addition to his agricultural character the functions of war-god, which in time completely superseded the earlier idea. Finally, we must notice, as the sign of the syncretism of the two settlements, the inclusion of the Colline deity, Quirinus, apparently the Mars of the originally rival community. In these three deities, Jupiter, Mars, Quirinus, we have the great triad of the earliest stage of the state religion.

Organization showed itself in the fixing of the annual calendar and the development of the character and functions of the priesthood, and as we should expect, in a new conception of the legal relation of the gods to the state. In the earlier stage—whose notions of course still persist alongside of the state religion—each household has its own relations to its *numina*: now the state approaches the gods through its duly appointed representatives, the magistrates and priests. Their presence is typical of that of the whole people, and the private citizen is

required to do no more on festival days than a ceremonial abstinence from work. It is obvious that the state religion has a less direct connexion with morality and the religious sense than the worship of the household, but it has its ethical value in a sense of discipline and a consecration of the spirit of patriotism.

The later stages represent not the spontaneous development of the genuine Roman religion, but its alteration and supersession by new cults and ideas introduced from foreign sources. Authorities are generally agreed in recognizing three periods:—(1) from the end of the Regal epoch to the second Punic War, when Rome was influenced by other peoples in Italy, with whom she was brought into contact by commerce or war; (2) from the second Punic War to the end of the Republic, when contact with Greek and oriental sources and the growth of literature revolutionized religious notions and led to a philosophic scepticism; (3) the Imperial epoch, opening with a revival of old religious notions and later marked by the official worship of the deified emperors and the wide influence of oriental cults.

(1) By the end of the regal period Rome had ceased to be a mere agricultural community and had developed into a city-state. There had consequently grown up within the state a large patrician class, excluded from the old patrician *gentes* and therefore from the state cult: at the same time the beginnings of commerce had opened relations with neighbouring peoples. The consequence was the introduction of certain new deities, the *di novensides*, from external sources, and the birth of new conceptions of the gods and their worship. We may distinguish three main influences, to a certain extent historically successive. (a) Tradition always assigned to the last three kings of Rome a connexion with the mysterious people of Etruria, and their influence at this period though not very definite was certainly extensive. To them, possibly through the mediation of Falerii, a Latin town, possibly an Etruscan border, was due the introduction of Minerva, who, as the goddess of handicraft and protectress of the artisan guilds, was established in a temple on the Aventine. Soon, however, she found her way on to the Capitol, and there a new Etruscan triad, Jupiter, Juno and Minerva, possibly going back from Etruria to Greece, was enshrined in a magnificent new temple built by Etruscan workmen and decorated in the Etruscan manner. In this temple the deities were represented by images, and on its dedication day, September 13th, at the novel festival of the *epulum Jovis*, the images were borne and set on their pedestals. To them, possibly through foreign to the native Roman religion (cf. further ETRURIA, § Religion). (b) Secondly, in war and peace Rome formed relations with her neighbours of Latium, and, as a sign of the Latin league which resulted, the cult of Diana was brought from Aricia and established on the Aventine in the "commune Latinorum Dianae templum" (Varro, *Ling. Lat.* v. 43): about the same time was built the temple of Jupiter Latiaris on the Alban mount, its resemblance in style to the new Capitoline temple pointing to Rome's hegemony. So great was Rome's sense of kinship to the Latins that in two cases Latin cults were introduced inside the *pomerium*: the worship of Heracles was brought from Tibur in connexion with commerce, was established at the *ara maxima* in the forum boarium, and the Tusculan cult of Castor as the patron of cavalry found a home close to the forum Romanum: it is a strange irony that both these deities should in reality have been in their origin Greek. Other Italian cults introduced at this period were those of Juno Sospes and Juno Regina, Venus and Fortuna Primenia, a goddess of childbirth who came from Praeneste. (c) Later on in the same period contact with the cities of Magna Graecia brought about the wide-reaching introduction of the Sibylline books. Whatever may be their origin and they came from Cumae—they were placed in the Capitoline temple under the care of a special commission of two (*duoviri sacris faciendis*, later *Magna Graecia*, *decemviri* and *quindecimviri*), and their "oracles," which were referred to in times of great national stress, recommended the introduction of foreign cults. In 493 B.C., at a time of serious famine, they ordered the building of a temple to the Greek triad Demeter, Dionysus and Persephone, who were identified with the old Roman divinities Ceres, Liber and Libera: Apollo must have come with or before the books themselves, though his temple was not built till 433 B.C.: Mercury followed, the representative of *Ἐρμῆς Ἐρμῆς*, Asclepius was brought from Epidaurus to the Tiber island in 493 B.C., and Dis and Proserpina, with their strange chthonic associations and night ritual, probably from Tarentum in 249 B.C. With new deities came new modes of worship: the *gracculus ritus*, in which, contrary to Roman usage, the worshipper's head was unveiled, and the *lectisternium* (q.v.), an elaborate form of the "banquet of the gods." In this period, then, we find first a legitimate extension of cults corresponding to the needs of the growing community, and secondly a religious restlessness and a consequent tendency to more dramatic forms of worship.

(2) The two chief notes of the next period are superstition and scepticism: both the populace and the educated classes lose faith in the old religion, but they supply its place in different ways. The disasters of the early part of the second Punic War revealed an unparalleled religious nervousness: portents and prodigies were announced from all quarters, it was felt that the divine anger was on the state, yet there was no belief in the efficacy of the old methods for restoring the *pax deum*. Accordingly recourse is had, under the direction of the Sibylline books, to new forms of appeal for the divine help, the general weaving of the *res sacras* and the elaborate Greek *lectisternium* after a rasmene in 217 B.C., and the human sacrifice in the forum after Cannae in the following year. The same spirit continues to show itself in the almost reckless introduction of Greek deities even within the walls of the *pomoerium* and their ready identification with gods of the old religion, whose cult they in reality superseded. Thus we hear of temples dedicated to Juventas = Hebe (191 B.C.), Diana = Artemis (179 B.C.), Mars = Ares (138 B.C.), and find even such unexpected identifications as that of the Bona Dea (*g.v.*)—a cult title of the ancient Fauna, the female counterpart of the countryside *nomen Penius*—with a Greek goddess of women, Demeter. At the same time the new acquaintance with Greek art introduces the making of cult statues, in which the identified Greek type is usually adopted without change, with such curious results as the representation of the *Penates* under the form of the Dioscuri. But more significant still was the order of the Sibylline books in 206 B.C. for the introduction of the worship of the *Magna Mater* (see GREAT MOTHER OF THE GODS) from Pessinus and her ultimate installation on the Palatine in 191 B.C.: the door was thus opened to the wilder and more orgiastic cults of Greece and the Orient, which at once laid hold on the popular mind. In the train of the *Magna Mater* came the secret cult of Bacchus, which grew to such proportions in private worship that it had to be suppressed by decree of the Senate in 186 B.C., and later on were established the cults of Ma of Phrygia, introduced by Sulla and identified with Bellona, the Egyptian Isis, and, after Pompey's war with the pirates, even the Persian Mithras (*g.v.*). In all these more emotional rituals, the populace sought expression for the religious emotions which were not satisfied by the cold worship of the older deities.

Meanwhile a corresponding change was taking place in the attitude of the educated classes owing to the spread of Greek literature. The knowledge of Greek mythology, to which they were first introduced by poets and antiquarians at work in a field wholly foreign to the Roman religious spirit, the generalizing of Roman anthropomorphic mythology. This they accomplished partly by the popular process of adoption and identification, partly by imitative creation. In this way grew up the "religion of the poets," whose falseness and shallowness was patent even to contemporary thinkers. But more important was the influence of philosophy, which led soon enough to a general scepticism among the upper classes. Its first note is struck by Ennius in his translation of the

Scepticism. Sicilian rationalist Euhemerus, who explained the genesis of the gods as apotheosized mortals. In the last century of the Republic the two latter Greek schools of Epicureanism and Stoicism laid hold on Roman society. The influence of Epicureanism was wholly destructive to religion, but not perhaps very widespread: Stoicism became the creed of the educated classes and produced several attempts, notably those of Scaevola and Varro, at a reconciliation of philosophy and popular religion, in which it was maintained that the latter was in itself untrue, but a presentation of a higher truth suited to the capacity of the popular mind. Such a theory was bound to be fatal, as it makes religion at once a mere instrument of statecraft.

The result on the old religion was twofold. On the one hand, worship passed to the formalism of formalism into disuse. Some of the old cults passed away altogether, others survived in name and form, but were so wholly devoid of inner meaning that even the learning of a Varro could not tell their intention or the character of the deity with whom they were concerned. The old priesthood, and in particular the *flamines*, came to be regarded as tiresome restrictions on political life and were neglected: from 87 to 11 B.C. the office of *flamen Dialis* was vacant. On the other hand, as the result in part of the theory of Stoicism, religion passed into the hands of the politicians: cults were encouraged or suppressed from political motives, the membership of the colleges of pontifices and augurs, now conferred on popular note, was sought for its social and political advantages, and augury was debased till it became the meanest tool of the politician. In the general wreck of the old religion, little survived but the household cult, protected by its own genuineness and vitality.

(3) The revival of Augustus, which marks the opening of the last stage, was perhaps the most remarkable phenomenon in the whole story. It was no doubt very largely political, a part of his plan for the general renaissance of Roman life, which was to centre no longer round the abstract notion of the state, but round the persons of an imperial house. But it was genuinely religious, in that he saw that no revival could be effective which did not appeal to the deeper sentiment of the populace. It was thus his business to revitalize the old forms with a new and

more vigorous content. His new palace on the Palatine he intended to be primarily the seat of the Julian family and the cults associated with it, and secondarily the centre of the new popular religion. With this object he consecrated there his new temple of Apollo (28 B.C.), associated for long with the Julian house, and adopted by Augustus as his special patron at Actium, and transferred to its keeping the Sibylline books, thus marking the new headquarters of the *Imperio-Roman* religion. Similar in purpose was his institution of the *ludi saeculares* in 17 B.C., in which a day celebration was added to the old *ludi maximi* and Apollo and Diana deliberately set up as a counterpart to the Capitoline Jupiter and Juno; Horace's hymn written for the festival is a good epitome of Augustus's religious intentions. In the same spirit he established a new shrine of Vesta Augusta within the palace, a private cult at first, but destined to be a serious rival of the ancient worship in the forum. A still more marked action was the building of a great temple at the end of his own new forum to Mars Ultor—Mars, the ancestor of the Julian gens, as of the Roman people itself, and now to be worshipped as the avenger of Caesar's murderers. Nor did he hesitate to avail himself of the popular outburst, which immediately after the murder had consecrated the site of Caesar's cremation with a *burntum*, to erect on the spot a permanent temple to his adopted father, under the definitely religious title of *divus Iulius*. No doubt he also did much generally to revive the ancient cults: he rebuilt, as he tells us himself, eighty-two temples which had fallen into disrepair, he re-established the old priesthoods, filling once more the office of *flamen Dialis* and reviving such bodies as the *Sodales Titii* (see TITUS TATIUS) and the Arval Brothers (*g.v.*); but the new revival attached itself primarily to these four cults, and their tendency was unmistakable. Originally, no doubt, Augustus designed to attract religious feeling generally to the reigning house, but it was inevitable that his more personal note should be given to it. The deification of Julius Caesar was one important step; another was the natural prominence in the palace of the cult of the *Genius* of the emperor himself. As the palace cults became national, the worship of the *Genius* was bound to spread, and ultimately Augustus sanctioned its celebration at the *comitia* together with the worship of the old Lares. But here he and the wisest of his successors drew the line, and though under oriental influence divine honours were paid to the living emperor outside Italy, they were never permitted officially in Rome. In the succeeding centuries Augustus's intentions were realized with a fullness which he would hardly have wished, and the cult of the imperial house practically superseded the state religion as the official form of worship.

With this last period the story of Roman religion really draws to a close. For, though the form of the old cults was long preserved and even Antoninus Pius was honoured in an inscription for his care of the ancient rites of religion, the vital spirit was almost gone. In the popular mind the hosts of exciting oriental cults, which in the 3rd and 4th centuries of the Empire filled Rome with the rites of mysticism and initiation, held undisputed sway; and with the more educated a revived philosophy, less accurate perhaps in thought, but more satisfying to the religious conscience, gave men a clearer monotheistic conception, and a notion of individual relations with the divine in prayer and even of consecration. It was with these elements—fiercely antagonistic because so closely allied in character—that the battle of Christianity was really fought, and though, after its official adoption, the old religion lingered on as "paganism" and died hard at the end, it was really doomed from the moment when the Augustan revival had taken its irrecoverable bias in the direction of the emperor-worship.

BIBLIOGRAPHY.—(a) General.—Preller, *Römische Mythologie*, edited by Jordan; J. Marquardt, *Römische Staatsverwaltung*, vol. III, edited by Wissowa; Th. Mommsen, *History of Rome*; E. Aubert, *Religion des Römer*; G. Wissowa, *Religion und Kultus der Römer* and *Gammelle Landeskunde zur römischen Religions- und Stadtgeschichte*; W. Warde Fowler, *The Roman Festivals*; J. B. Carter, *The Religion of Numa*; W. H. Roscher, *Lexicon der griechischen und römischen Mythologie*; Pauly-Wissowa, *Realencyclopädie der klassischen Altertumswissenschaft*; *Corpus Inscriptionum Latinarum*. See further, GREEK RELIGION; MITHRAS; ETRURIA, RELIGION; and articles on the deities, festivals and colleges.

(b) Special.—For the Imperial Period, G. Boissier, *La Religion romaine d'Auguste aux Antonins: La fin du Paganisme*; Henzen, *Acta Fratrum Arvalium*; for the private and gentile cults, A. de Marchi, *Il culto privato di Roma Antica*. (C. BA.)

ROMANS, a town of south-eastern France, in the department of Drôme, 12½ m. N.E. of Valence on the railway to Grenoble. Pop. (1906) town, 13,304; commune, 17,622. Romans stands on an eminence on the right bank of the Isère, a fine stone

bridge uniting it with Bourg-de-Peage (pop. 4668) on the other side of the river. Both towns owe their prosperity to their situation in the most fertile part of the valley of the Isère. The present parish church belonged to an abbey founded in 837 by St. Bernard, bishop of Vienne. The principal portal is a fine specimen of 12th-century Romanesque, and the lower part of the nave is of the same period; the choir and the transept are striking examples of the style of the 13th century.

Romans has a tribunal of commerce and a communal college. Its industries include tanning, leather-dressing and shoe-making, silk-spinning, hat-making, absinthe-distilling and oil-refining. There is trade in walnuts, walnut-oil, silk, cattle, &c.

ROMANS, EPISTLE TO THE. In this book of the New Testament, the apostle Paul begins, after a brief pregnant introduction (i. 1-7), by explaining that he had hitherto been prevented from carrying out his cherished project of visiting the church of Rome, whose faith was world-wide (i. 8 f.). Meanwhile, he outlines the gospel which he preached as an exhibition of God's righteousness, *καὶ πιστώσει εἰς πίστιν*. This forms the leading theme of the epistle.

Both Gentile (i. 18-32) and Jew (ii. 1, 3-20)¹ alike have missed this righteousness up till now, but the revelation of God in Jesus Christ (iii. 21-31) had brought the divine boon within reach of all. The condition of its reception was not nationality but faith. Hence, Paul steps for a moment to a Jew (iv. 1-25), the Jew that cannot claim any preference: Abraham himself, before circumcision and the law came into force, was a man of faith, and consequently all believers (not all legal Jews, iv. 16) are true descendants of Abraham.² Returning to the blissful results of this *δικαιοσύνη* revealed in Jesus Christ (v. 1-11), Paul proceeds to contrast these with the sombre effects produced in humanity by the fall of Adam. Life had now triumphed over death, grace over sin (v. 12 f.). But the supersession of the law, which was bound up with the régime of sin and death, does not mean the abolition of the moral bond. On the contrary (vi. 1 f.), the reception of God's grace and spirit implies the death of the believing man to sin. The struggle of the soul³ between the thwarting power of sin and the ethical demands of the law (vii. 1 f.) cannot be ended happily save by the interposition of Jesus Christ, whose Spirit guarantees a sound life in this world and life eternal in the world to come (viii. 12 f.).

The splendid and unfettered⁴ prospects of faith, which thus break on the apostle's vision, only serve to deepen his distress in one direction.⁵ As a theologian and as a patriot, he is confronted with the problem of Israel's collective repudiation of a boon to which their own history, as he read it, clearly pointed. Reverting to the thought of ii. 17 f. and iv. 1, Paul now essays, in ix.-xi., to show how this unbelief of Israel is to be reconciled with the justice and the promises of God. He begins by showing, as in Gal. iv. 7 f. (cf. Rom. ii. 28-29), that mere physical descent could not entitle a Jew to the promises. Besides (ix. 14-29), no Jew has the right to challenge God's sovereign freedom. If God determines to extend the promise of faith to the Gentiles, who shall accuse Him of injustice? The rejection of the Jews is their own fault, due to their obstinacy and legalism (ix. 30-x. 21). Finally, Paul tries to see this fact of Israel's unbelief in the light of a wide religious philosophy of history; it (xi. 1-10) cannot be anything but a temporary and partial (xi. 11-24)⁶ phase; the future will clear up the present; the final

result will be the inclusion of all Israel in the heritage of the messianic kingdom of Christ. The prospect of this consummation stirs him to an outburst of adoration, with which the whole section ends (xi. 33-36).⁷

Applying the thought of God's mercy to the obligations of believing men (xii. 1-2), Paul proceeds now to sketch the ethical duties of Christians in the church (xii. 3-21), in society, and in the state (xiii. 1-7): love is the supreme law (xiii. 8-10); and the nearness of the end the supreme motive to morality (xiii. 11-14). These considerations are still before Paul's mind as he descends from general counsels to a special problem of practical ethics, raised by the varying attitude of Christians at Rome towards food offered to idols (xiv. 1 f.). After laying down the principle of individual responsibility, he appeals for charity and mutual consideration (xv. 1-3-xv. 6), and for Christian forbearance.⁸ Finally, he exhorts all Gentiles and Jewish Christians alike (xv. 8-13), to unite in thanksgiving for God's mercy to them in Christ.

In a brief epilogue, the apostle justifies himself for having thus addressed the Roman Christians. He alleges (xv. 14 f.) his apostolic vocation and informs them of his future movements. With an appeal for their prayers and a brief benediction, the epistle then closes (xv. 30-33). It ends as it began (i. 8 f.) with the apostle's hope and plan of visiting Rome on a subsequent missionary tour.⁹

Rom. xvi. contains a separate note (1-23), together with a doxology (25-27). The former came from Paul's pen, but it did not belong originally to this epistle.¹⁰ In all likelihood it is a letter of commendation for Phoebe¹¹ which includes vers. 1-23 (so e.g. Weizsäcker, McGiffert and Jülicher), though most break it off at ver. 20 (so Eichhorn, Ewald, Schulz, Renan, Weiss, Lipsius, von Soden, &c.), while others do not begin it until ver. 3 (so e.g. Ewald, Schürer, Reuss and Mangold: *Der Römerbrief*, pp. 136 f.). Vers. 21-23 might indeed follow xv. 33, but it is not Paul's way to add salutations after a final Amen, and the passage connects as well with xvi. 20, though it may have lain originally (Jülicher) between 16 and 17. The main reasons¹² for conjecturing that this section was addressed separately, not to Rome but to a city like Ephesus, lie in its contents. Paul was as yet a stranger to Rome, and it is extremely difficult to suppose that he already knew so many individuals there. The earlier tone of Romans shows that he was writing as a comparative stranger to strangers. Any touches of familiarity with the local circumstances (as in xiv.-xv.) are no more than might have percolated to him through hearing and

botanically in his allegory. For a defence of his accuracy, see W. M. Ramsay's *Pauline and other Studies* (1907), 219 f.

² On the method of dialectic in this section, see Bishop Gore's paper in *Studia Biblica* (vol. iii.). The literature up to 1907 is summarized in H. J. Holtzmann's *Neutest. Theologie*, ii. pp. 171 f., one of the most significant essays being that of Beyschlag on *Die paulin. Theodicee* (1868). Wernle (*Beginnings of Christianity*, i. p. 337) sums up his discussion by pointing out that "the Jewish history is simply nonexistent for St. Paul when he treats apologetic problems of this nature. No mention whatever is made of him in the three chapters of Romans which treat of Israel's fate. The literal text of the Septuagint seems to be the only decisive authority, and that is so sacred and almighty, that, whenever it comes into collision with the human conscience, the latter is silenced when the voice of revelation speaks."

³ The weaker minority probably were a Jewish-Christian circle (cf. Riggsbach in *Studien und Kritiken*, 1893, pp. 649-678). For the rigorous aspect of vegetarianism in those of other circles, see von Dobschütz's *Christian Life in the Primitive Church* (1904), pp. 125 f., 396 f.

⁴ "It was a sufficient reason for writing to the Romans that Paul was expecting to visit them, but was obliged once more to postpone an event to which he had long looked forward. There was nothing in the circumstances of the church that required his intervention, and, as he was therefore free to choose his subject, he wrote out of the fullness of his heart that grand defence of the gospel which, though shaped by the conditions of the times, is animated by the timeless Spirit, and has proved to be a possession for ever" (Drummond, p. 246).

⁵ For the literature, cf. the present writer's *Historical New Testament* (1901), pp. 209-213. The hypothesis has won very wide acceptance, but several editors and critics (including Harnack, Zahn, and Clemen) remain unconvinced. Cf. also Wabnitz in *Revue de théologie et des quest. religieuses* (1900), 461-469.

⁶ On her functions, see Zscharnack's *Der Dienst der Frau in den ersten christlichen Jahrhunderten* (1902), pp. 45 f.

⁷ Cf. Lucht (*Über die beiden letzten Kapitel des Römerbriefes*, 1871, p. 126 f.) with Weizsäcker's brilliant passage in his *Apostolic Age*, i. p. 379 f.).

¹ On iii. cf. G. W. Matthias's *Exegetischer Versuch* (Cassel, 1857).
² "Paul here unconsciously changes the conception of law. By introducing the example of Abraham he shows that the book of the law contains the doctrine of justification by faith, and through the latter, therefore, is not made of none effect. This proof rests, objectively regarded, on a fallacy: for the law, of which the validity is threatened by the doctrine of justification, is that part of the book of the law which demands the observance of all commands, not that which relates anything about Abraham. But this error of thought would be easily concealed from a mind with the rabbinical training of Paul's" (Schmiedel, in *Hibbert Journal*, 1902, pp. 548-549).

³ Cf. Engel's exhaustive monograph, *Der Kampf um Römer vii.* (1902), and, for the ideas of i.-viii., Du Bose's *The Gospel according to St. Paul* (1907), and Titius, *Der Paulinismus* (1900), pp. 159 ff.

⁴ The word *al*, as Matthew Arnold observes (*St Paul and Protestantism*, ch. 1.), is "in some sense the governing word of the Epistle to the Romans."

⁵ As arranged in the canonical edition, ix.-xi. are closely interwoven with i.-viii., and xi. 32-36 concludes not simply ix.-xi. but i.-xi. (cf. Bühl in *Studien und Kritiken*, 1887, 295-320). Certainly what Paul has in mind throughout the epistle is not a Judaizing tendency among the Jews of Christian Rome, but the general and perplexing question of Judaism in relation to the new faith. Cf. Hoenicke's *Das Judentum* (1908), pp. 160 f.

⁶ In this passage Paul has generally been held to have erred

report; they do not imply the presence of friends upon the spot who kept him supplied with information. On the other hand, the circle of people addressed in xvi. 1-23, with its wealth of individual colour and personal detail, presupposes a sphere where Paul had worked for long. He can appeal to these Christians. He can speak sharply with authority to them. Now, as he wrote from Corinth, the only other city which answers to this description is Ephesus, the centre of Paul's long Asiatic mission. With that city and district several of the names in xvi. 1-23 are more or less directly connected, e.g. Epänetus (5), Aquila and Priscilla (3), who were at Ephesus immediately before Romans was written (Acts xv. 18, 26; cf. 1 Cor. xvi. 19), and apparently were there (cf. 2 Tim. iv. 19) not long afterwards. These are the first people mentioned in the note, nor is there any likelihood that they or the rest of Paul's friends¹ had made a sudden migration to the capital. Doubtless, there was fairly constant communication between Rome and the provinces, and in the course of time these friends may have gradually followed the apostle thither. Hence it is not remarkable that almost all the names mentioned in this note have been found by archaeologists (cf. Lightfoot's *Philippians*, pp. 171 f.) within the Roman *Corpus Inscriptionum*. Most of them, anyhow, are fairly common throughout the Roman world (cf. Lietzmann, p. 73), whilst half are to be found in the Greek *Corpus Inscriptionum* for Asia Minor (e.g. Epänetus, Hermes, Hermas).² Furthermore, the sharp warning against errorists and heretics (xvi. 17-20) suits Rome at this period much less aptly than Ephesus (cf. 1 Cor. xvi. 8-9; Acts xv. 29 f.; Rev. ii. 2 f.), where trouble of this kind was in the air. Controversy against false teachers is conspicuously absent from Romans. Nor is it possible to regard (with Zahn) such counsels as merely prophylactic; they are too definite and pointed. They imply the existence of a community with which Paul was personally acquainted, and to which he felt himself bound and free to address keen, authoritative reproaches.

The textual phenomena of the doxology (xvi. 25-27), which occurs in some MSS. after xiv. 23, are sufficiently strange; they suggest that the epistle must have passed through a certain process of editing, during the 2nd century, previous to its final incorporation in the canon of the epistles.³ It may further be conjectured that the epistle does not lie before the modern reader in the precise shape in which it left Paul and his amanuensis at Corinth. Opinions, indeed, vary on the doxology. Either it is authentic but irrelevant, added by Paul as a postscript, or it is unauthentic,⁴ due to some copyist who added it as

¹ Erbes (*Zeitschrift für Kirchengeschichte*, 1901, 224-231) makes xvi. 1-16a a note forwarded by Paul to Rome during his last voyage thither, in order to advise some of the local Christians of his arrival (Acts xxviii. 15), but this theory is no improvement upon that of Semler, who regarded xvi. 3-16 as designed for Paul's friends outside Rome, to introduce the bearers of the larger epistle. The point of such hypotheses is to explain how the note came to be attached to Romans, but this can be shown otherwise (cf. Deissmann's *Licht vom Osten*, 1908, pp. 164, 165). Eichhorn (*Einleitung in das N.T.* iii. 243 f.) regarded xvi. 1-20 as addressed to Corinth, while Schenkel viewed it as designed for all the churches which Phoebe was to visit.

² In the Ephesian *Acta Johannis* (c. A.D. 160) the house of Andronicus (Rom. xvi. 7?) is one centre of Christian activity. E. H. Gifford (pp. 27-30) evades the difficulty by taking xvi. 3-20 as part of a second letter written by Paul after, not before, his release from imprisonment.

³ The most recent and radical analyses are those of Spitta (*Urchristentum*, iii. 1902) and Völter (*Päulus u. seine Briefe*, 1905). The former detects a short letter written (xvi. 1-23) after Acts xviii. 30, during a tour of the Gentile churches (A.D. 63-64), and another (i.-xi. 10, xiv. 14-33) written to believing Jews in order to justify the Gentile mission and afterwards edited for Gentile readers with the addition of xi. 11, f. 8-13, &c. Völter (pp. 135 f.) distinguishes an original letter (in i. 1, 5b-7, 8-17, v. 1-12, 15-19, 21, vi. 1-13, 16-23, xii.-xv. 6, v. 14-17, 23b-33, xvi. 21-24) from editorial additions, and also from still later accretions in ii. 14-15, iii. 23-26, vi. 25b, xi. 11, f. 7, x. 13, 17-23a, xvi. 17, f. 25. Spitta's views are properly set aside by Feine and Bahnsen (*Protest. Monatshefte*, 1902, 331 f.) amongst others.

⁴ It suggests a serotype, 20 f. (cf. Mangold, *Der Römerbrief*, 44-81, and Holtzmann, *Ephes. Col.*, 307-310). "In spite of the vindication of the style word by word, the impression it bears upon the mind is hardly Pauline. It seems artificial rather than

a suitable finale at the close. In the Pauline canon Romans originally occupied the last place. It would therefore be natural that a note like that of xvi. 1-23 should be put in here, especially if this canon was drawn up at Rome, whither Phoebe probably travelled eventually. The doxology would then be shifted from after xiv. 23 or inserted for the first time for ecclesiastical purposes. The material conditions of such a process are lucidly stated by Dr C. R. Gregory in his *Canon and Text of the New Testament* (1907), pp. 319 f.

The problems presented by the structure of these chapters⁵ cannot be solved adequately by the mere hypothesis, worked out variously by critics like Paulus, Griesbach (*Curarum in historiam textus Graeci epistolarum Pauli spec.* i. pp. 45 f.), Eichhorn and Flatt, that they are a series of postscripts or afterthoughts, much less by the conjecture that, in whole or in part, they are unauthentic (Baur, Volkmar, &c.). The only tenable line of argument, in the present state of criticism, is to regard their phenomena as due to compilation, at the time when the canon (perhaps of Paul's epistles) was first formed. If the hypothesis already outlined is set aside, it is open to the critic to regard large portions of the canonical Romans as having originally occupied a separate setting,⁶ or to ascribe the textual variations to the exigencies of church reading after the formation of the canon (which might explain the absence of *ἐν Πάρι* in i. 7, 15, and the duplicate position of the doxology).⁷

The uncertainty as to the literary structure of the epistle naturally renders it hazardous to infer the character of the Christians who are addressed, but it may be said that the results of the long debate on this point are converging upon the belief that the predominant class in the local church or churches were Gentile Christians, while proselytes must have swelled the ranks to no inconsiderable degree. Since Weizsäcker wrote, the older view of Baur (cf. his *Paul*, Eng. tr. i. pp. 321 f.) has steadily lost ground. Zahn is now its main supporter, and his contentions are not convincing. Even were ix.-xi. taken as the kernel of the epistle, its obvious motive is to be found in the need of explaining to Gentile Christians the reasons for Israel's apparent rejection, and passages like i. 5, f. 13, xi. 13, xv. 15, f. 8, are, if not decisive, at any rate superior to any references which can be urged fairly on the opposite side. To a church of this kind, in the capital of the Empire, Paul writes out his gospel more fully than in any other of his extant epistles. It is the essence of the gospel that he treats, and that is the revelation of God's righteousness to man by faith in Jesus Christ. Neither sacraments nor organization come within his purview. Even eschatology lies quite in the background. Paul writes of the inspired" (Denney, p. 582). Proofs of its Pauline authorship are led fully by Zahn (*Einleitung in das N.T.* § 21 f.) and Jacquier (*Histoire des livres du N.T.*, 1903, pp. 271 f.); cf. also Bacon in *Journal of Biblical Literature* (1899), pp. 184 f. The entire data of ix.-xvi. are discussed fully by Lightfoot and Hort in the former's *Biblical Essays* (pp. 287 f.) and in the latter's admirable volume (*Romans and Ephesians*), as well as in Sanday and Headlam's edition (pp. lxxxv. f.).

⁵ Ryder (*Journal of Biblical Literature*, 1898, pp. 184 f.) suggests that xv.-xvi. 24 form a letter or part of a letter written not by Paul but by his amanuensis, Tertius, to his friends at Rome, c. A.D. 64, previous to the Neronic persecution.

⁶ So J. Weiss (in *Theologische Studien*, 1897, pp. 182 f.), as well as those who, like Renan (*S. Paul*, lxiii-lxxv), find different editions in the canonical epistle, one meant for Thessalonica (i.-xiv. 33, xv. 25-27), one for Ephesus (i.-xiv. xvi. 1-20) and one for Rome (i.-xi., xv.), or who, like Lightfoot (*Biblical Essays*), see a double recension, the original draft having been meant for Rome (i.-xvi. 23), the later being, like Ephesians, a circular epistle.

⁷ The epistle was so systematic in treatment and wide in scope that it lent itself readily to this "catholicizing" manipulation; thus the fact that xv.-xvi. are very rarely quoted in primitive tradition may be due to their fullness of local detail, which would have less interest for the later church. But the question of course arises, May not the epistle, in whole or in part, have originated in more of an easte in epistolary form than at first sight appears? For various suggestions as to the problem of i. 7 see Harnack in *Zeitschrift für die neuest. Wissenschaft* (1902), 83-86; R. Steinmetz (*ibid.*, 1908, 177 f.) and Schmiedel in *Hibbert Journal* (1903), pp. 537 f.

heart of the gospel with all his heart, and while a certain controversial element inevitably enters into his exposition—since he is writing with his eye on the Roman Church—any such considerations are quite subordinate to his dominating aim.

The epistle dates itself. Paul is on his way to Jerusalem with the moneys collected from the Macedonian and Achaian churches (xv. 19-32), and, after his visit to the Jewish capital, he proposes to visit the church of Rome *en route* for a mission in Spain. The situation corresponds to that outlined in Acts xx. 2-3. Paul probably despatched the epistle from Corinth. This conclusion would be put almost beyond doubt were Rom. xvi. regarded as an integral part of the original epistle, since in that case Timothy and Sosipater (xvi. 21) would be with Paul as in Acts xx. 4, like Gaius (xvi. 23) and Erastus, both of whom were Corinthians (1 Cor. i. 14; 2 Tim. iv. 20). Phoebe of Cenchreae, the seaport of Corinth, would also be the bearer of the epistle (xvi. 1). But even apart from the evidence of ch. xvi., the tone of the epistle (especially of xv. 19 f.) indicates that Paul regards his work in the eastern provinces as done, and now turns to the West. It is just possible, of course, that the epistle was written from some other town, perhaps in Illyricum (so H. E. G. Paulus), but the facilities of communication point to Corinth.²

LITERATURE.—The ablest recent editions of the Greek text have been those of B. Weiss (in Meyer's commentary, 9th ed. 1899, thorough and all-round), R. A. Lipsius (*Hand-Commentar*, 2nd ed. 1892), H. Oltramare (Paris, 1881-82), Sanday and Headlam (*Internat. Crit. Comm.* 5th ed. 1905, strong in philology and external criticism), and Denney (*Expositor's Greek Testament*, 1901, a masterpiece of theological exposition), to which the Roman Catholic commentaries of A. Schäfer (Münster, 1891) and Cornely (Paris, 1896) may be added. The patristic and mediaeval literature is summarized by Sanday and Headlam (*op. cit.*, pp. xxviii. f.), and a conspectus of the vast later work may be found in W. P. Dickson's translation of Meyer (Edinburgh, 1873-74). The editions of Tholuck (1842), Moses Stuart (3rd ed. 1876), Godet (1879-80, Eng. trans. 1888), E. H. Gifford (*Speaker's Commentary*, 1881) and Philippi (4th ed. Frankfurt, 1896) are of special theological value. Godet's for its delicate exegesis and Gifford's for its adequacy of treatment; so, from its own point of view, is F. Delitzsch's *Brief an die Römer aus dem griech. Urtext in das Hebräische überetzt, mit dem Talmud verglichen* (1870); with which may be classed the earlier works of Reiche (*Versuch einer ausführl. Erklärung*, &c. 1833-34) and C. F. A. Fritzsche (1836-43). Since Dean Alford (1852), the freshest English editors have been Dr David Brown (Glasgow, 1860), Moule (*Cambridge Bible*, 1879), C. J. Vaughan (7th ed. 1890), B. Jowett (3rd ed. 1894), J. Agar Beet (9th ed. 1901) and Garvie (*Century Bible*, 1901). Jülicher's notes in *Die Schriften des N. T.* (1907), though written from a different standpoint, resemble Denney's in their conscientious and penetrating. Lietzmann's edition, again, is slight and philological (*Handbuch zum Neuen Testament*, 1907). Lightfoot's posthumous fragment (*Notes on Epistles of St Paul*, 1895, pp. 237-305) unfortunately breaks off at vii. 25. In addition to the special monographs already noted in the course of this article, the essays of H. E. G. Paulus (*De origibus Pauli epist. ad Rom.*, Jena, 1801), Lorenz (*Der Römerbrief*, 1844), Grate (*Über Veranlassung und Zweck des B.*, 1881), G. B. Stevens (*The Pauline Theology*, 1894), Feine (*Der Römerbrief*, 1903) and A. Robertson (Hastings' *Dict. of Bible*, iv. 295-306) may be specially mentioned out of a large crowd, together with G. Semeria's monograph, *Il pensiero di S. Paolo nella lettera ai Romani* (Rome, 1903). Holsten's position is stated in a series of articles in the *Jahrbuch für protest. Theologie* (1879), pp. 95 f., 314 f., 680 f., Pfeiderer's in *Das Urchristentum* (2nd ed. i. 149 f., Eng. tr. *Primitive Christianity*, i. pp. 211 f.) and Hilgenfeld's in his own *Zeitschrift für die Geschichte und Theologie* (1892), pp. 296-347. The recent literary and historical discussions are chronicled in C. Clemens' *Paulus*, i. 85 f., ii. 238 f., with which the English reader may compare R. J. Knowling's *The Testimony of St Paul to Christ* (1905), pp. 60 f.

311 f., 465 f. On Marcion's text of the epistle cf. Zahn's *Geschichte des N. T. Kanons*, ii. pp. 515-521; on the early reception of the epistle in the church, Gregory's *Canon and Text of the N. T.* (1907), pp. 192 f., and Leipoldt's *Geschichte des neut. Kanons* (1907), i. pp. 77 f., 188 f., 192 f., 209 f. (J. M. T.)

ROMANSHORN, an important commercial town in the Swiss canton of Thurgau. It is situated on the west shore of the lake of Constance, and by rail is 5½ m. N.E. of Zürich, 12½ m. S.E. of Constance, and 10 m. N.W. of Rorschach. In 1900 its population was 4577, mostly German-speaking, while there were 3903 Protestants to 1478 Romanists. Originally a small fishing village, it belonged to the abbot of St Gall from 1432 to 1798, when it became part of the canton of Thurgau. In 1856 the railway from Romanshorn to Zürich was opened, and this vastly increased the commercial importance of Romanshorn. Nowadays it is the centre of a great transit trade, as it communicates, by means of the lake, with the principal towns on its shores. The corn trade and that in timber are among the most important, while there are many industrial establishments. It is essentially a modern commercial centre.

ROMANUS, the name of four East Roman emperors.

ROMANUS I. (Lecapenus), who shared the imperial throne with Constantine VII. (q.v.) and exercised all the real power from 919 to 944, was admiral of the Byzantine fleet on the Danube when, hearing of the defeat of the army at Achelous (917), he resolved to sail for Constantinople. After the marriage of his daughter Helena to Constantine he was first proclaimed "basileopater" in 919 and soon after crowned colleague of his son-in-law. His reign, which was uneventful, except for an attempt to check the accumulation of landed property, was terminated by his own sons, Stephen and Constantine, who in 944 carried him off to the island of Prote and compelled him to become a monk. He died in 948.

ROMANUS II. succeeded his father Constantine VII. in 959 at the age of twenty-one, and died—poisoned, it was believed, by his wife, Theophano—in 963. He was a pleasure-loving sovereign, but showed judgment in the selection of his ministers. The great event of his reign was the conquest of Crete by Nicephorus Phocas.

ROMANUS III. (Argyros), emperor 1028-1034, was an undistinguished Byzantine patrician, who was compelled by the dying emperor Constantine IX. to marry his daughter Zoe and to become his successor. He showed great eagerness to make his mark as a ruler, but was mostly unfortunate in his enterprises. He spent large sums upon new buildings and in endowing the monks, and in his endeavour to relieve the pressure of taxation disorganized the finances of the state. In 1030 he resolved to retaliate upon the incursions of the Moslems on the eastern frontier by leading a large army in person against Aleppo, but by allowing himself to be surprised on the march sustained a serious defeat at Azaz near Antioch. Though this disaster was retrieved by the successful defence of Edessa by George Maniakes and by the defeat of a Saracen fleet in the Adriatic, Romanus never recovered his popularity. His early death was supposed to have been due to poison administered by his wife.

See J. B. Bury in the *English Historical Review* (1889), pp. 53-57; G. Schlumberger, *L'Épopée byzantine* (Paris, 1905), iii. pp. 56-158.

ROMANUS IV. (Diogenes), emperor 1068-1071, was a member of a distinguished Cappadocian family, and had risen to distinction in the army, when he was convicted of treason against the sons of Constantine X. While waiting execution he was summoned into the presence of the empress regent, Eudocia Macrembolitissa, whom he so fascinated that she granted him a free pardon and shortly afterwards married him. After his coronation he carried on three successful campaigns against the Saracens and Seljuk Turks, whom he drove beyond the Euphrates; in a fourth he was disastrously defeated by Alp Arslan on the banks of the Araxes and taken prisoner. After releasing himself by the promise of a large ransom and the conclusion of a peace, he turned his arms against the

¹ Not, however, in the sections bearing on the Law. "It has been customary to explain this feature of the epistle by the fact of its having been written to a church with which Paul had no personal relations, and this may count for something. But there is a deeper and a worthier reason for the contrast in tone between this epistle and those written to the Galatian and Corinthian churches. The whole situation is changed. The Paul who is fighting for existence with his back to the wall; now he writes as one conscious that the cause of Gentile Christianity is safe" (A. B. Bruce, *St Paul's Conception of Christianity*, 1894, p. 96).

² This is carefully worked out by Paley in his *Horae Paulinae* (ed. Birks, 1825), p. 8 f.

pretender Michael VII., but was compelled after a defeat to resign the empire and retire to the island of Prote, where he soon died in great misery. It was during this reign that, by the surrender of Bari (1071), the Byzantine empire lost its last hold upon Italy.

See J. G. C. Anderson in the *Journal of Hellenic Studies* (1897), pp. 36-39. On all the above see also J. B. Bury's edition of Gibbon's *Decline and Fall*. (M. O. B. C.)

ROME (Roma), the capital of the modern kingdom of Italy, in the province of Rome, on the river Tiber, 17 miles N.E. from its mouth on the Mediterranean. As formerly the centre of the ancient Roman republic and of the Roman empire, and the headquarters of the Christian Church, Rome is unique among historical cities, and its antiquarian interest far surpasses that of any other locality in the world. In the following account the general subject of Rome is treated broadly under two aspects, themselves subdivided. These are:—(1) the topography and growth of the city of Rome, the evolution of which is traced from the earliest times to the present, and (2) Roman history, i.e. the political and social history of the Roman republic, empire and medieval commune.

The nine or ten hills and ridges on which the city stands are formed of masses of tufa or conglomerated sand and ashes thrown out by neighbouring volcanoes now extinct, but active down to a very recent period. One group of these volcanoes is that around Lago Bracciano, while another, still nearer to Rome, composes the Alban Hills. That some at least of these craters have been in a state of activity at no very distant period has been shown by the discovery at many places of broken pottery and bronze implements below the strata of tufa or other volcanic deposits. Traces of human life have even been found below that great flood of lava which, issuing from the Alban Hills, flowed towards the site of Rome, only stopping about 3 miles short, by the tomb of Cecilia Metella.

The superficial strata on which Rome is built are of three main kinds: (1) the plains and valleys on the left bank of the Tiber are covered, as it were, by a sea of alluvial deposits, in the midst of which (2) the hills of volcanic origin rise like so many islands; and (3) on the right bank of the Tiber, around the Janiculum and Vatican Hills, are extensive remains of an ancient sea-beach, conspicuous in parts by its fine golden sand and its deposits of greyish white potter's clay. From its yellow sand the Janiculum has been sometimes known as the Golden Hill, a name which survives in the church on its summit called S. Pietro in Montorio (Monte d'Oro). In addition to these three chief deposits, at a few places, especially in the Aventine and Pincian Hills, under-strata of travertine crop out—a hard limestone rock, once in solution in running water, and deposited gradually as the water lost its carbonic-acid solvent, a process still rapidly going on at Terni, Tivoli and other places in the neighbourhood. The conditions under which the tufa hills were formed have been very various, as is clearly seen by an examination of the rock at different places. The volcanic ashes and sand of which the tufa is composed appear in parts to lie just as they were showered down from the crater; in that case it shows but little sign of stratification, and consists wholly of igneous products. In parts time and pressure have bound together these scoriae into a soft and friable rock; in other places they still lie in loose sandy beds and can be dug out with the spade. Other masses of tufa again show signs either of having been deposited in water, or else washed away from their first resting-place and redeposited with visible stratifications; this is shown by the water-worn pebbles and chips of limestone rock, which form a conglomerate bound together by the volcanic ashes into a sort of natural cement. A third variety is that which exists on the Palatine Hill. Here the shower of red-hot ashes has evidently fallen on a thickly growing forest, and the burning wood, partly smothered by the ashes, has been converted into charcoal, large masses of which are embedded in the tufa rock. In some places charred branches of trees, their form well preserved, can be easily distinguished. The so-called "wall of Romulus" is built of this conglomerate of tufa and charred wood; a very

perfect section of the branch of a tree is visible on one of the blocks by the Scalae Caci.

So great have been the physical changes in the site of Rome since the first dawn of the historic period that it is difficult now to realize what its aspect once was. The Forum Romanum, the Velabrum, the great Campus Martius (now the most crowded part of modern Rome), and other valleys were once almost impassable marshes or pools of water (*Ov. Fasti*, vi. 401; *Dionys. ii.* 50). The draining of these valleys was effected by means of the great cloacae, which were among the earliest important architectural works of Rome (*Varro, Ling. Lat.* iv. 149). Again, the various hills and ridges were once more numerous and very much more abrupt than they are now. At an early period, when each hill was crowned by a separate village fort, the great object of the inhabitants was to increase the steepness of its cliffs and render access difficult. At a later time, when Rome was united under one government, the very physical peculiarities which had originally made its hills so populous, through their natural adaptability for defence, became extremely inconvenient in a united city, where architectural symmetry and splendour were above all things aimed at. Hence the most gigantic engineering works were undertaken: tops of hills were levelled, whole ridges cut away, and gentle slopes formed in the place of abrupt cliffs. The levelling of the Velia and the excavation of the site for Trajan's forum are instances of this. The same works were continued in the middle ages, as when in the 14th century an access was made to the Capitoline Arx¹ from the side of the Campus Martius; up to that time a steep cliff had prevented all approach except from the side of the Forum.

Finally, after Rome had become the capital of united Italy, in the last quarter of the 19th century, an extensive government plan (*piano regolatore*) was gradually carried out, with the object of reducing hills and valley to a uniform level and constructing wide boulevards on the chessboard method of a modern American city. The constant fires which have at times devastated Rome have been a powerful agent in obliterating the natural contour of the ground; and the accumulated rubbish from this and other causes has in some places overlaid the ground to a depth of 40 ft., notably in the valleys.

THE ANCIENT CITY

The chief building materials used in ancient Rome may be enumerated as follows: (1) *Tufa*, the "ruber et niger lophus" of Vitruvius (ii. 7), varying in colour from warm brown to yellow or greyish green (called *capelluccio*). The Aventine, Palatine and Capitoline Hills contained quarries of the tufa, much worked at an early period (see *Liv. xxvi.* 27, *xxxix.* 44, and *Varro, L.L.* iv. 151). It is a very bad "weather-stone," but stands well if protected with stucco (*Plin. H.N.* xxxvi. 166). (2) *Lapis Albanus*, from Alba Longa, of volcanic origin, a conglomerate of ashes, gravel and fragments of stone; its quarries are still worked at Albano and Marino. This is now called *peperino*, from the black scoriae, like peppercorns, with which the brown conglomerate mass is studded. (3) *Lapis Gabinus*, from Gabii, very similar to the last, but harder and a better weather-stone; it contains large lumps of broken lava, products of an earlier eruption, and small pieces of limestone. According to Tacitus (*Ann.* xv. 43), it is fire-proof, and this is also the case with the Alban stone. *Lapis Gabinus* is now called *sperone*. (4) *Silex* (mod. *selce*), a lava from the now extinct volcanoes in the Alban Hills, used for paving roads; when broken into small pieces and mixed with lime and pozzolana it formed an immensely durable concrete. It is dark grey, very hard and breaks with a slightly conchoidal fracture (*Plin. H.N.* xxxvi. 135; *Vitr.* ii. 7), but does not resemble what is now called *silex* or flint. (5) *Lapis Tiburtinus* (travertine), the chief quarries of which are at Tibur (Tivoli) and other places along the river Anio; a hard pure carbonate of lime, of a creamy white colour, deposited from running or dripping water in a highly

¹ By the great flight of marble steps up to S. Maria in Ara Coeli.

stratified form, with frequent cavities and fissures lined with crystals. As Vitruvius (ii. 5) says, it is a good weather-stone, but is soon calcined by fire. If laid horizontally it is very strong, but if set on end its crystalline structure is a great source of weakness, and it splits from end to end. Neglect on the part of Roman builders of this important precaution in many cases caused a complete failure in the structure. This was notably the case in the rostra. (6) *Pulvis Puteolanus* (pozzolana), so called from extensive beds of it at Puteoli—a volcanic product, which looks like red sandy earth, and lies in enormous beds under and round the city of Rome. When mixed with lime it forms a very strong hydraulic cement, of equal use in concrete, mortar or undercoats of stucco. It is to this material that the concrete walls of Rome owe their enormous strength and durability, in many cases far exceeding those of the most massive stone masonry. Vitruvius devotes a chapter (bk. ii. ch. 6) to this very important material.

Bricks were either sun-dried (*lateres crudi*) or kiln-baked (*lateres cotti, testae*). The marks of Vitruvius (ii. 3) seem to refer wholly to sun-dried bricks, of which no examples now exist in Rome. It is important to recognize the fact that among the existing ancient buildings of Rome there is no such thing as a brick wall or a brick arch in the true sense of the word; bricks were merely used as a facing to concrete walls and arches and have no constructional importance.¹ Concrete (*opus caementicium*, Vitr. ii. 4, 6, 8), the most important of all the materials used, is made of rough pieces of stone, or of fragments of marble, brick, &c., averaging from about the size of a man's fist and embedded in cement made of lime and pozzolana—forming one solid mass of enormous strength and coherence. Stucco, cement and mortar (*tectorium, opus albarium* and other names) are of many kinds; the ancient Romans especially excelled in their manufacture. The cement used for lining the channels of aqueducts (*opus signinum*) was made of lime mixed with pounded brick or potsherds and pozzolana; the same mixture was used for floors under the "nucleus" or finer cement on which the mosaic or marble paving-slabs were bedded, and was called *caementum ex testis tunsis*. For walls, three or four coats of stucco were used, often as much as 5 in. thick altogether; the lower coats were of lime and pozzolana, the finishing coats of powdered white marble (*opus albarium*) suitable to receive painting. Even marble buildings were usually coated with a thin layer of this fine white stucco, nearly as hard and durable as the marble itself—a practice also employed in the finest buildings of the Greeks—probably because it formed a more absorbent ground for coloured decoration; stone columns coated in this way were called "*columnae dealbatæ*" (Cic. *In Verr.* ii. 1, 52 seq.). For the kinds of sand used in mortar and stucco, Vitruvius (ii. 4) mentions sea, pit and river sand, saying that pit sand is to be preferred.

Marble appears to have come into use about the beginning of the 1st century B.C. Its introduction was at first viewed with great jealousy, as savouring of Greek luxury. The orator Crassus was the first to use it in his house on the Palatine, built about 92 B.C.; and, though he had only six small columns of Hymettian marble, he was for this luxury nicknamed the "Palatine Venus" by the stern republican M. Brutus (Plin. *H.N.* xxxvi. 7). The temporary wooden theatre of the ædile M. Aemilius Scaurus, built in 58 B.C., appears to have been the first building in which marble was more largely used; its 360 columns and the lower order of its scene were of Greek marble (see Plin. *H.N.* xxxvi. 5, 50). In a very few years, under the rule of Augustus, marble became very common.²

Of white statuary marble four principal varieties were used. (1) *Marmor Lunense*, from Luna, near the modern Carrara (Strabo, v. p. 222), is of many qualities, from the purest creamy white and the finest grain to the coarser sorts disfigured with bluish grey streaks.

(Ex., the eleven Corinthian columns in the Borsa.) (2) *Marmor Hymettium*, from Mount Hymettus, near Athens, is coarser in grain than the best Luna marble and is usually marked with grey or blue striations (Strabo ix. p. 399). (Ex., the forty-two columns in the nave of S. Maria Maggiore and the columns in S. Pietro in Vinculi.) (3) *Marmor Pentelicum*, from Mount Pentelicus, also near Athens, is very fine in grain and of a pure white; it was more used for architectural purposes than for statues, though some sculptors preferred it above all others, especially Pheidias and Praxiteles. (Ex., the bust of the young Augustus in the Vatican.) (4) *Marmor Parium*, from the Isle of Paros, is very beautiful, though coarse in texture, having a very crystalline structure. (Ex., the nineteen columns of the round temple in the Forum Boarium.)

Nine chief varieties of coloured marbles were used in Rome. (1) *Marmor Numidicum* (mod. *giallo antico*; Plin. *H.N.* v. p. 22), from Numidia and Libya, hence also called *Libycum*. Coloured marbles. It is of a rich yellow, deepening to orange and even pink. Enormous quantities of it were used, especially for columns,

wall-slings and pavements. (Ex., seven columns on the arch of Constantine, taken from the arch of Trajan; the eighth column is in the Lateran basilica.) (2) *Marmor Carystium* (mod. *cipollino*), from Carystus in Euboea (Strabo x. p. 446), has alternate wavy strata of white and pale green—the "undosa Carystos" of Statius (*Silv.* i. 5, 34). From its well-defined layers like an onion (*cipolla*) is derived its modern name. (Ex., columns of temple of Antonius and Faustina.) (3) *Marmor Phrygium* or *Synnadicum* (mod. *paonazuello*), from Synnada in Phrygia (Strabo xii. p. 577; Juv. xiv. 307; Tibull. iii. 3, 13), is a slightly translucent marble, with rich purple markings, violet verging on red. It was fabled to be marked with blood of Atys (Stat. *Silv.* i. 5, 37). (Ex., twelve fluted columns in S. Lorenzo facing the five vaulted columns of the apse of S. Paolo fuori, saved from the ancient nave of the basilica, burnt in 1823.) (4) *Marmor Iasiuum* (probably the modern *piva sarta*), from Iasus, is mottled with large patches of dull red, olive green and white. The "holy doors" of the four great basilicas are framed with it, hence its modern name. (Ex., the slabs in front of the hemicycle of the Rostra and four columns in S. Agnese fuori le Mura.) (5) *Marmor Chium* (probably the modern *Africano*), from Chios, is similar in the variety of its markings to the *portasanta* and *bulino* of the same kind. (Ex., a great part of the paving of the Basilica Julia and two large columns in the centre of the facade of St Peter's.) (6) *Marmor Tænarium* (mod. *rosso antico*), from Tænarum in Laconia (Strabo viii. p. 367; Plin. *H.N.* xxvi. 158), is a very close-grained marble, of a rich deep red, like blood. As a rule it does not occur in large pieces, but was much used for small cornices and other mouldings in interiors of buildings. Its quarries in Greece are still worked. (The largest pieces known are the fourteen steps to the high altar of S. Prassede and two columns nearly 12 ft. high in the Rospigliosi Casino dell' Aurora.) (7) The name *Marmor Tænarium* is also applied by the ancients to a black marble which now no longer quarried. It is mentioned by Tibullus (iii. 3, 14) in conjunction with Phrygian and Phrygian marbles; see also Prop. iii. 2, 9, and Plin. *H.N.* xxxv. 135. (Ex., two columns in the choir of S. Giovanni in Laterano.) (8) *Lapis Atracius* (*verde antico*), found at Atrax in Thessaly, was one of the favourite materials for decorative architecture; it is not strictly a marble (i.e. a calcareous stone) but a variety of "precious serpentine," with patches of white and brown on a brilliant green ground. It seldom occurs in large masses. (The finest known specimens are the twenty-four columns beside the niches in the nave of the Lateran basilica.) (9) The hard oriental alabaster, the "onyx" or "alabas-trites" of Pliny (*H.N.* xxxvi. 89, xxxvii. 109), the chief quantities were on the Nile near Thebes,³ in Arabia and near Damascus. In Pliny's age it was a great rarity; but in later times it was introduced in large quantities, and fragments of a great many columns have been found on the Palatine, in the baths of Caracalla and elsewhere. It is semi-transparent and beautifully marked with concentric nodules and wavy strata. An immense number of other less common marbles have been found, including many varieties of breccia, whose ancient names are unknown.⁴

From the latter part of the 1st century B.C. hard stones—granites and basalts—were introduced in great quantities. The basalts—can basanites" of Pliny (xxxvi. 58)—are very refractory, and can only be worked by the help of emery or diamond dust. The former was obtained largely at Naxos; diamond-dust drills are mentioned by Pliny (*H.N.* xxxvii. 200). The basalts are black, green and brown, and are usually free from spots or markings; examples of all three exist, but are comparatively rare. The red variety called "porphyry" was used in enormous quantities. It is the "porphyrites" of Pliny (*H.N.*

¹ In less solid constructions than those which have survived until modern times bricks were doubtless used by themselves.

² The oft-quoted boast of Augustus (Suet. *Aug.* 29) that he "found the ædile M. Aemilius and left it of marble" has probably more truth in it, if for "brick" we read "peperino and tufa." In the time of Augustus burnt brick was very little used, the usual wall-facings being *opus quadratum* of tufa or peperino, and *opus reticulatum* of tufa only.

³ These Nile quarries were worked during the 19th century, and many blocks were imported into Rome for the rebuilding of S. Paolo fuori le Mura.

⁴ On the subject of Roman marbles, see Corsi, *Delle pietre antiche* (ed. 3, 1845), and Pullen, *Handbook of Roman Marbles* (London, 1894); also Brindley in *Transactions of the Royal Institute of British Architects* (1887). A collection of 1000 specimens, originally formed by Corsi, is preserved in the museum at Oxford.

xxxvi. 57), and was brought from Egypt. It has a rich red ground, covered with small specks of white felspar; hence it was also called "leptosephos." A large number of columns of it exist, and it was much used for pavements of *opus Alexandrinum*. A rich green porphyry or basalt was also largely used, but not in such great masses as the red porphyry. It has a brilliant green ground covered with rectangular light green crystals of felspar. This is the *lapis Incaedaeonius* (wrongly called by the modern Romans "serpentine"), so named from its quarries in Mount Taqetius in Lacedaemonia (Paus. iii. 21, 4; Plin. H.N. xxxvi. 55; Juv. xi. 175). It appears to have been mostly used for pavements and panels of wall linings. The granites used in Rome came mostly from near Philae on the Nile (Plin. H.N. xxxvi. 63). The red sort was called *lapis pyrrhoeicus* and the grey *lapis psaronius*. The columns in the Basilica Ulpia are a fine example of the latter; both sorts are used for the columns of the Pantheon and those of the temple of Saturn in the Forum. Gigantic ships were specially made to carry the obelisks and other great monoliths (Plin. H.N. xxxvi. 2, 67).

The style of architecture employed in ancient Rome (see ARCHITECTURE, section *Roman*, and ROMAN ART) may be said to have passed through three stages—the *Architectural styles*. Etruscan, the Greek and the Roman. During the first few centuries of the existence of the city, both the methods of construction and the designs employed appear to have been purely Etruscan. The earliest temples were either simple cellae without columns, or else, in the case of the grander temples, such as that of Capitoline Jupiter, the columns were very widely spaced (araeostyle), and consequently had entablatures of wooden beams. The architectural decorations were more generally in gilt bronze or painted terra-cotta than in stone, and the paintings or statues which decorated the buildings were usually the work of Etruscan artists.¹ The Greek influence is more obvious; it is found in the period following the Second Punic or Hannibalic War, and almost all the temples of the earlier imperial age are Greek, with certain modifications, not only in general design but in details and ornaments. Greek architects were largely employed, such as Apollodorus of Damascus, who designed Trajan's forum and other buildings; on the other hand, a Roman, Cosutius, was employed on the building of the Olympieum at Athens, in the 2nd century B.C. Roman architects such as Vitruvius and C. Mucius in the 1st century B.C., Severus and Celer under Nero, and Rabirius under Domitian, were Greek by education, and probably studied at Athens (see *Vitr. vii. Praef.*; Hirt, *Gesch. d. Baukunst*, ii. p. 257).² The Romans, however, though far below the Greeks in artistic originality, were very able engineers, and this led to the development of a new and more purely Roman style, in which the restrictions imposed by the use of the stone lintel were put aside and large spaces were covered with vaults and domes cast in semi-fluid concrete, a method which had the enormous advantage of giving the arched form without the constant thrust at the springing which makes true arches or vaults of wide span so difficult to deal with. The enormous vaults of the great thermae, the basilica of Constantine, and the like, cover their spaces with one solid mass like a metal lid, giving the form but not the principle of the arch, and thus allowing the vault to be set on walls which would at once have been thrust apart had they been subjected to the immense leverage which a true arched vault constantly exerts on its impost.³ This is a very important point, and one which is usually overlooked, mainly owing to the Roman practice of facing their concrete with bricks, which (from an examination

of the surface only) appear to be a principal item in the construction. The walls of the Pantheon, for example, are covered with tiers of brick arches, and many theories have been invented as to their use in distributing the weight of the walls. But a recognition of the fact that these walls are of concrete about 20 ft. thick, while the brick facing averages scarcely 6 in. in thickness, clearly shows that these "relieving arches" have no more constructional use as far as concerns the pressure than if they were painted on the surface of the walls. The same applies to the superficial use of brick in all arches and vaults. Although, however, the setting of the concrete rendered the brick facing superfluous, it played its part in sustaining the fluid mass on its centring during the process of solidification.

At first tufa only was used in *opus quadratum*, as we see in the so-called wall of Romulus. Next the harder peperino began to be worked: it is used, though sparingly, in the "Servian" wall, and during the later Republic appears to have been largely employed for exterior walls or points where there was heavy pressure, while other parts were built of tufa. Thirdly, travertine appears to have been introduced about the 2nd century B.C., but was used at first for merely ornamental purposes, very much as marble was under the Empire; after about the middle of the 1st century A.D. travertine began to be largely used for the solid mass of walls, as in the temple of Vespasian and the Colosseum. The tufa or peperino blocks were roughly 2 (Roman) ft. thick in regular courses (the "isodorum" of Vitruvius) by 2 ft. across the end, and under the Republic often exactly 4 ft. long, so that two

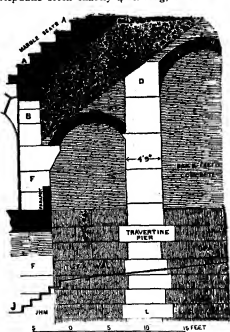

FIG. 1.—Example of Construction in which many materials are used; upper part of one of the inner radiating walls under the cunei of the Colosseum. A, A. Marble seats on brick and concrete core, supported on vault made of pumice-stone concrete (C). B, Travertine arch at end of raking vault (C). D, One of the travertine piers built in flush with the tufa wall to give it extra strength. E, E. Wall of tufa concrete faced with triangular bricks, carrying the vaults of pumice concrete which support the marble seats. F, Travertine pier at end of radiating wall. G, Brick-faced arch of concrete to carry floor of passage. H, H. Tufa wall, *opus quadratum*. J, J. Line of steps in next bay. K, K. Surface arches of brick, too shallow to be of any constructional use, and not meant for ornament, as the whole was stuccoed; they only face the wall (which is about 4 ft. thick) to the average depth of 4 in.

is interesting to note the manner in which the Roman builders mixed their different materials according to the weight they had to carry. While tufa was frequently used for the main walls, peperino (e.g. in the "Servian" wall on the Aventine) or travertine (e.g. in the forum of Augustus and the temple of Fortuna Virilis, so called) was inserted at points of special pressure, such as piers or arches (see fig.). The Colosseum is a particularly elaborate example of this mixed construction with three degrees of pressure supported by three different materials.

It is interesting to note the manner in which the Roman builders mixed their different materials according to the weight they had to carry. While tufa was frequently used for the main walls, peperino (e.g. in the "Servian" wall on the Aventine) or travertine (e.g. in the forum of Augustus and the temple of Fortuna Virilis, so called) was inserted at points of special pressure, such as piers or arches (see fig.). The Colosseum is a particularly elaborate example of this mixed construction with three degrees of pressure supported by three different materials.

¹ Pliny (H.N. xxxv. 154), quoting Varro, says that the decorations in painting and sculpture of the temple of Ceres near the Circus Maximus were the work of the first Greek artists employed in Rome, and that before that (c. 493 B.C.) "all things in temples were Etruscan." Vitruvius (iii. 3) says, "Ornataque signis fœcilibus aut aereis inauratis eorum fastigia Tuscanico more, uti est ad Circum Maximum Ceresis, et Herculis Pompeiani, item Capitolii" (cf. iv. 7, vi. 3).

² The frequent use of engaged columns is a peculiarity of Roman architecture, but it is not without precedent in Greek buildings of the best period, e.g. in the temple of Zeus at Agriguntum. Surface enrichments over the mouldings were used far more largely by the Romans than by the Greeks.

³ In the beautiful drawings of Choisy (*L'Art de bâtir chez les Romains*, Paris, 1873) the structural importance of the brick used in vaults and arches is very much exaggerated.

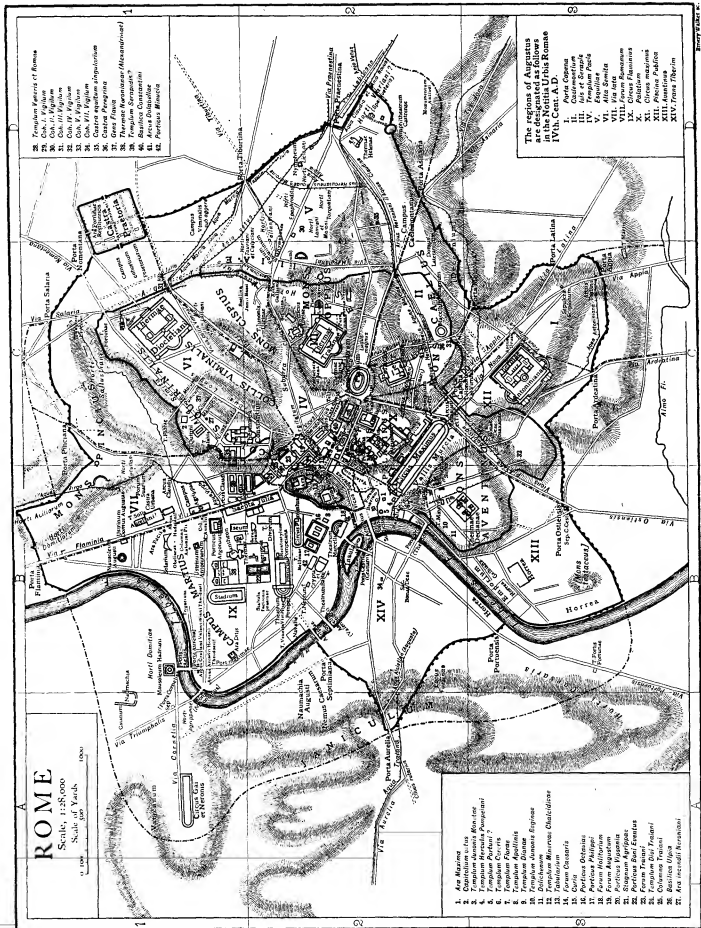

FIG. 7.—PLAN OF ANCIENT ROME.

The use of mortar with *opus quadratum* is a sign of a comparatively early date. It occurs, e.g. in the "Servian" wall on the Aventine

and in the Tabularium. Under the Empire massive blocks, whether of tufa, travertine or marble, are set without any mortar. It must, however, be observed that in these early instances the "mortar" is but a thin stratum of lime, little thicker than stout paper, used not as a cement to bind the blocks together, but simply to give the joints a smoothly fitting surface. The actual binding together was done by clamps and dowels, as well as by the mass and weight of the great blocks used. Except in the earliest masonry, each block was very carefully fastened, not only to the next blocks on the same course, which was done with double dove-tailed dovels of wood, but also to those above and below with stout iron clamps, run with lead (Vitr. ii. 8).¹ In more ornamental marble work bronze clamps were often used. Concrete is rarely found in connexion with *opus quadratum*; part of the "Servian" wall on the Aventine received a backing of concrete at a relatively late period. Up to the 1st century B.C. it was faced with *opus incertum*—small irregularly shaped blocks of tufa, 3 to 6 in. across, with pointed ends driven into the concrete while it was soft, and worked smooth on the face only (see fig. 2). From the beginning of the 1st century B.C. *opus reticulatum*,² formed of rectangular tufa prisms laid in a regula, pattern like a net (whence the name), is found. It is very neat in appearance, and is often fitted with great care, though it was generally covered with stucco. The so-called "house of Livia" on the Palatine is a good example of the earlier sort, when the quoins

were made of small rectangular blocks of tufa. Under the Empire brick quoins came into use (as may be seen, e.g. in the so-called palace of Caligula). Though in Rome *opus reticulatum* was almost always made of tufa, in the neighbourhood of the city it was sometimes of peperino or even lava, where these materials were found on the spot.

Opus reticulatum.

FIG. 2.—Concrete Wall faced with (A) *Opus Incertum* and (B) *Opus Reticulatum*. C shows the section, similar in both.

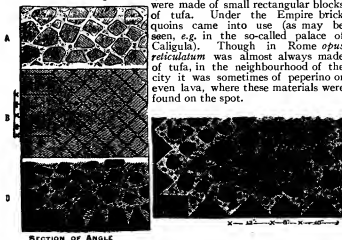

FIG. 3.—Section of Concrete Wall, showing the use of bricks merely as a facing.

Of concrete walls faced with burnt bricks no dated example earlier than the middle of the 1st century B.C. is known. The facing consisted at first of triangular fragments of tiles (*tegulae*), broken for the purpose and more or less irregular in shape and size, but from the latter part of the 1st century A.D. onwards triangular bricks were specially manufactured for wall-facings. This shape was adopted in order to present a large surface on the face with little expenditure of brick, and also to improve the bond with the concrete behind (see fig. 4). Even party walls of small rooms are not built solid, but have a concrete core faced with brick triangles about 3 in. long. In order to support the facing until the concrete was set, the Roman builders used a wooden framing covered with planks on the inside. Sometimes the planks were nailed outside the wooden uprights, as was done with unfaced concrete walls, and then a series of grooves appear in the face of the brickwork. Walls faced with *opus reticulatum* must have been supported temporarily in the same way.

The character of the brick facing is a great help towards determining the date of Roman buildings. In early work the bricks are thick and the joints thin, while in later times the reverse is the case, so that brickwork of the time of Severus and later has more bricks to the foot than that of the Flavian period.

The length of the bricks as it appears on the face is no guide to the date, since one or more of the sharp points of the brick triangles were frequently broken off before they were used. Moreover,

varieties both in quality of workmanship and size of the bricks often occur in work of the same date. In the remains of Nero's Golden House great varieties appear, and some of the walls in the inferior rooms are faced with very irregular and careless brickwork.³ Special care and neatness were employed in the rare cases when the wall was not to be covered with stucco, which in the absence of marble was usually spread over both inside and outside walls. All these circumstances make great caution necessary in judging of dates; fortunately after the 1st century A.D., and in some cases even earlier, stamps impressed on bricks, and especially on the large tiles used for arches, give clearer indications. The reason of the almost universal use of smooth facings either of *opus reticulatum* or of brick over concrete walls is a very puzzling question; for concrete itself forms an excellent ground for the stucco coating or backing to the marble slabs, while the stucco adheres with difficulty to a smooth facing, and is very liable to fall away. The modern practice of raking out the joints to form a key was not employed by the Romans, but before the mortar was laid they studded the face of the wall with marble plugs and iron or bronze nails driven into the joints, so as to give a hold for the stucco—a great waste both of labour and material.⁴ The quality of the mortar varies according to its date: during the 1st and 2nd centuries it is of remarkable hardness—made of lime with a mixture of coarse pozzolana of a bright red colour; in the 3rd century it began to be inferior in quality; and the pozzolana used under the later Empire is brown instead of red.

Concrete was at first always made of lumps of tufa; then travertine, lava, broken bricks and even marble were used; in fact all the chips and fragments of the mason's yard. Under the Empire the concrete used was made with travertine or lava for foundations, with tufa or broken bricks for walls, and with tufa or pumice-stone (for the sake of lightness) for vaults. Massive walls were cast in a mould; upright timbers, about 6 by 7 in. thick and 10 to 14 ft. long, were set in

rows on each face of the future wall; planks 9 to 10 in. wide were nailed to them, so as to form a case, into which the semi-fluid mass of stones, lime and pozzolana was poured. When this was set the timbers were removed and refixed on the top of the concrete wall; then fresh concrete was poured in; and this process was repeated till the wall was raised to the required height. Usually such cast-work was only used for foundations and cella walls, the upper parts being faced with brick; but in some cases the whole wall to the top was cast in this way and the brick facing omitted. In strength and durability masonry, however hard the stones or large the blocks, could ever equal these walls of concrete when made with hard lava or travertine, for each wall was one perfectly coherent mass, and could only be destroyed by a laborious process like that of quarrying hard stone from its native bed. Owing to this method of building the progress of the work from day to day can often be traced by a change in the look of the concrete. About 3 ft. appears to have been the average amount of wall raised in a day.

Marble linings were fixed very firmly to the walls with long clamps of metal, hooked at the end so as to hold in a hole made in the marble slab. Fig. 4 gives an example, of the time of Augustus, fixed against a stone wall. The blocks were usually marked in the quarry with a number, and often with the names of the reigning emperor and the overseer of the quarry. These quarry-marks are often of great value as indications of the date of a building or statue.⁵ Metropolitan

FIG. 4.—Example of Marble Lining, from the Cella of the Temple of Concord. A. Slabs of Phrygian marble. B. Plinth moulding of Numidian "giallo." C. Slab of apollino (Carystian marble). D. Paving of porta santa. E and F. "nucleus" and "rudus" of concrete bedding. G, G. Iron clamps run with lead to fix marble lining. H. Bronze clamp. J. Cement backing.

¹ Some of the bricks are as much as 2½ in. thick, while 1½ in. is the usual maximum for Roman bricks.

² The Roman method of applying stucco to walls with a wooden "floor" exactly as it is done now, is shown in a painting from Pompeii (see *Ann. Inst.*, 1881, p. H.).

³ See Bruzza, in *Ann. Inst.* (1870), pp. 106-204; Hirschfeld, *Die kaiserlichen Verwaltungsbeamten* (1905), pp. 162 ff.

building acts, not unlike those of modern London, were enacted by several of the emperors. These fixed the materials to be used, thickness of walls, minimum width of streets, maximum height allowed for houses, &c. After the great fire in Nero's reign, A.D. 64, an act was passed requiring the lower storeys of houses to be built with fire-proof materials, such as peperino or burnt brick.

Enormous accumulations of statues and pictures enriched Rome during its period of greatest splendour. In the first place, the numerous statues of the republican and even of the royal period were religiously preserved at a time when, from their archaic character, they must have been regarded rather as objects of sacred or archaeological interest than as works of art (Plin. *H.N.* xxvii. 15 ff., xxxv. 19 ff.). Secondly came the large Graeco-Roman class, mostly copies of earlier Greek works, executed in Rome by Greek artists. To this class belongs most of the finest existing sculpture preserved in the Vatican and other museums. Thirdly, countless statues and pictures were stolen from almost every important city in Greece, Magna Graecia, Sicily and western Asia Minor. These robberies began early, and were carried on for many centuries. The importations included works of art by all the chief artists from the 5th century downwards. Long lists are given by Pliny (*H.N.* xxxiii.-xxxvi.), and pedestals exist with the names of Praxiteles, Timarchus, Polyclitus, Bryaxis and others. These accumulated works of sculpture were of all materials—gold and ivory (Suet. *Tib.* 2), of which seventy-four are mentioned in the catalogue of the Breviarium, many hundreds or even thousands of silver! (Plin. *H.N.* xxxiii. 151 l.), while those of gilt bronze and marble must have existed in almost untold numbers (Paus. viii. 46). Nor were the accumulated stores of Greek paintings much inferior in number; not only were easel pictures by Zeuxis, Apelles, Timanthes and other Greek artists taken, but even mural paintings were carefully cut off their walls and brought to Rome secured in wooden frames (Plin. *H.N.* xxxv. 173, and compare *ibid.* 154).

The roads were made of polygonal blocks of lava (*silex*), neatly fitted together and laid on a carefully prepared bed, similar to that used for mosaic paving (see *Mosaic Roads* and *ROADS*). Roads thus made were called *viae stratae*. A good specimen of Roman road-making, in which the blocks were fitted together with the utmost accuracy, is to

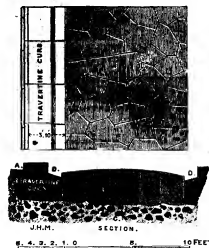

FIG. 5.—Example of Early Basalt Road by the Temple of Saturn on the Clivus Capitolinus. A. Travertine paving. B. Polygonal basalt blocks. C. Concrete bedding. D. Rain-water gutter. The curb shown is taken from another part of the road.

The following is a list of the chief roads which radiated from Rome:—(1) Via Appia issued from the Servian Porta Capena and the Aurelian P. Appia; from it diverged (2) Via Latina, which issued from the Aurelian P. Latina; (3) Via Labicana and (4) Via Tiburtina issued from the Servian P. Esquilina; from (3) diverged (5) Via Praenestina at the double arch of the Claudian aqueduct, now P. Maggiore, while (4) passed through the Aurelian P. Tiburtina; (6) Via Nomentana and (7) Via Salaria issued from the Servian P. Collina and passed respectively through the Aurelian P. Nomentana and P. Salaria; (8) Via Flaminia issued from the Servian P. Fontinalis, and was called Via Latina for the first half-mile or more,

then passed through the Aurelian P. Flaminia; (9) Via Aurelia, from the Transiberine P. Aurelia; (10) Via Portuensis, from the Transiberine P. Portuensis; (11) Via Ostiensis, from the Servian P. Trigemina and the Aurelian P. Ostiensis; (12) Via Ardeatina, from the Servian P. Naevia and the Aurelian P. Ardeatina.

Remains of Prehistoric Rome.

It is evident from recent discoveries that the site of Rome was inhabited at a very early period.² Flint implements and remains of the Bronze Age have been found on the Aventine and elsewhere; and from the Early Iron Age onwards we have a continuous archaeological record, owing to the discovery of ancient burial-places. In 1902 a very early necropolis was brought to light at the S.E. corner of the temple of Antoninus and Faustina, some 17 ft. below the level of the Forum. The graves contain either the ashes of cremated bodies placed in a large vessel (*dolio*), or skeletons buried either in a simple trench (*fossa*), a tufa sarcophagus or a tree-trunk. The cremation graves are the earlier, and none are later than the 6th century, while the oldest may be of the 9th; the pottery and other objects placed in the graves belong to the Early Iron Age. It is clear that this cemetery is earlier than the union of the Palatine and Quirinal settlements in one city (see below, p. 759). Other early cemeteries have been discovered on the Quirinal and Esquiline, which were in use from the beginning of the Iron Age down to the beginning of the historic period. The large necropolis on the Esquiline is cut in two by the "Servian" wall, which is evidently of later date. The later tombs contain objects of Etruscan, Phoenician and Greek manufacture.

There is no doubt that the earliest settlement bearing the name of Rome was on the Palatine hill,³ which was both easy of defence and possessed the means of communication with its neighbours in the proximity of the *The Palatine Tiber*. The name *Roma* is said to mean "river," but this is uncertain. The Palatine is roughly square in outline, and the Roman antiquarians sometimes applied the name *Roma Quadrata* to the earliest settlement; but the term seems more properly to have applied to a sanctuary connected with the foundation of the city. The ideal boundary of the city was formed by the Pomerium (see Varro, *L.L.* v. 143; Liv. i. 44; Dionys. i. 88), whose original course is traced by Tacitus (*Ann.* xii. 24). It passed along the foot of the hill (*per ima montis Palatini*), the angle-points being given by the Ara Maxima in the Forum Boarium, the Ara Consivi in the Circus Maximus, the Curiae Veteres (near the arch of Constantine) and the Sacellum Larum (at the N. angle). But this was of course not a defensible site, and the extent of the fortified city can only be determined by the traces of its early walls. These enable us to fix its line along the whole valley of the Velabrum, on the west of the hill, and along the valley of the Circus Maximus as far as the so-called Paedagogium, about half-way on the south side.

Considerable remains of this fortification exist near the west angle of the hill. These show that the natural strength given by the cliff was increased by artificial means. The wall was set neither at the top nor at the foot of the hill, but more than half-way up, a level terrace or shelf all round being cut in the rock on which the base of the wall stood. Above cut the hill was cut away into a cliff, not quite perpendicular but slightly "battering" inwards, to give greater stability to the wall, which was built up against it, like a retaining wall, reaching to the top of the cliff, and probably a few feet higher. The stones used in this wall are soft tufa, a warm brown in colour, and full of masses of charred wood. The cutting to form the steep cliff probably supplied part of the material for the wall; and ancient quarries, afterwards used as reservoirs for water, exist in the mass of rock on which the so-called temple of Jupiter Victor stands. It has been asserted that these tufa blocks are not cut but split with wedges; this, however, is not the case. Tufa does not split into rectangular masses, but

² On the prehistoric remains of Rome and Latium, see Pinza in *Monumenti antichi pubblicati per cura della reale Accademia dei Lincei*, vol. xv., 1905; also Comm. Boni's reports on the necropolis adjoining the Forum in the *Notizie degli scavi*, and Molestor, *Introduction à l'histoire romaine* (Paris, 1907).

³ The "primacy of the Palatine" has been disputed by Carter (*Amer. Jour. Arch.*, 1908, p. 181), who thinks that the first city was that of the Four Regions (see below) formed by the Etruscan kings.

¹ Eight silver statues of Augustus, some equestrian and some in quadrigae, are mentioned in the *Mon. Anc.* 4, 51.

would be shattered to pieces by a wedge; moreover, distinct tool-marks can be seen on all the blocks whose surface is well preserved and in the quarries themselves. Chisels from one-fourth to three-fourths of an inch in width were used, and also a sharp-pointed pick or hammer. The wall is about 10 ft. thick at the bottom, and increases in thickness above as the scarped cliff against which it is built recedes. It is built of blocks laid in alternate courses of headers and stretchers, varying in thickness from 22 to 24 in., in length from 3 to 5 ft. and in width from 19 to 22 in. These blocks are carefully worked on their beds, but the face is left rough, and the vertical joints are in some cases open, spaces of nearly 2 in. being left between block and block; in other cases the vertical joints are worked true and close like the beds. No mortar was used. At two points on the side of the Velabrum winding passages are excavated in the tufa cliff, the entrance to which was once closed by the ancient wall. One of these in early times (before water in abundance was brought to the Palatine on aqueducts) was used as a reservoir to collect surface water, probably for use in case of siege; circular shafts for buckets are cut downwards through the rock from the top of the hill. A similar rock-cut cistern with vertical shafts, of very early date, exists at Alba Longa. Opposite the church of S. Eudoro are the remains of a wall, belonging to the wall of the city, partly concealed by a long line of buildings of the later years of the Republic and the early Empire, to make room for which the greater part of the then useless wall was pulled down, and only fragments left here and there, where they could be worked into the walls of the later houses.

The age of the walls here described cannot be determined with certainty, but their resemblance to the remains of the "Servian" wall, especially in the system of "headers and stretchers" and the dimensions of the blocks, makes it certain that they do not differ greatly in date from that work. The chief technical difference lies in the open vertical joints found in some cases; but too much stress should not be laid on this feature. There are, however, at the western angle of the hill some remains of an earlier fortification, constructed with blocks of grey-green tufa, smaller in size than those of the main wall. A few courses have been preserved, owing to the fact that at the angle of the hill this wall was encased first of all by that described above and afterwards by concrete substructures of imperial date. The technique is primitive, as the blocks are of irregular size and are not laid in courses of "headers and stretchers"; the nearest parallel is supplied by the foundations of the temple of Jupiter Capitolinus. These remains are shown by Delbrück, *Der Apollotempel auf dem Marsfelde*, pl. iii., cf. p. 13 f.

Pliny (*H. N.* vi. 12) thus describes the wall of Romulus that three gates (i. e. Serv. *Ad. Aen.* vi. 22); and three approaches to the gates of the Palatine city can be traced. One is the so-called *Scalae Caci*, a long sloping ascent cut through the rock (see fig. 17) from the side of the Circus Maximus; some remains of the early wall still exist along the sides of this steep ascent or staircase. The upper part of this has remains of a basalt pavement, added in later times, probably covering the more ancient rock-cut steps. The name of the gate which led at this point into the Palatine city is unknown. The only two gates whose name and position can be (with any degree of probability) identified are the *Porta Romanula* and the *Porta Mugonia*. The former of these is called the *Porta Victoria* (ed. Müller, p. 76), and it is stated that it was at the foot of the Clivus Victoriae (see fig. 17) and was so called by the Sabines of the Capitol because by their natural entrance to Roma Quadrata (see also Varro, *L.L.* v. 164 (who only mentions the two gates named above), vi. 24). It would thus have been at the foot of the hill in the Velabrum (see below, p. 600); but Varro says that it was approached by steps from the *Nova Via*,¹ which would place it at the N. angle of the Palatine. The stairs connecting the *Nova Via* with the Clivus Victoriae still exist. Doubtful traces of the *Porta Mugonia* (see Sol. i. 24) have been discovered where a basalt paved road leads up into the Palatine from the *Summa Sacra Via* and the *Summa Nova Via*, which join near the arch of Titus; whether this was the wall now destroyed of tufa blocks of which this gate was built. This is probably the "vetus porta Palatii" of Livy (i. 12), through which the Romans fled when defeated by the Sabines.

The Palatine settlement was the nucleus around which, by a series of expansions, the historical city of Rome grew up. The first step was the amalgamation of Roma Quadrata with the villages on the neighbouring spurs of the Esquiline and Caelian. This gave birth to the community of the Seven Hills, whose existence is proved by the survival of the festival known as the Septimontium, celebrated on the 11th of December (Fest. 340; Macrob. i. 16, 6). The seven hills were not those familiar in later nomenclature, but the following:—(1) Palatine and the Cermalus, the two summits of the Palatine; (2) Velia, the saddle between the Palatine and Esquiline; (3) Oppius and (4) Cispius, the two westernmost spurs of the Esquiline, together with (6) Fagatal, the extreme crest of the Oppius; (7) Susca (confused by later writers with Subura), the eastern spur of the Caelian. Varro (*L.L.* v. 48) mentions the *murus terreus Carinarum*, which may have belonged

to the defences of this community, since the N.W. slope of the Oppius bore the name *Carinae*; but there is no proof that the Septimontium was a walled city.

The next stage in the development of Rome was marked by the division of the city into four regions, ascribed by tradition to Servius Tullius,² who was said to have submered the four city tribes, corresponding with the regions: (1) Suburana, including the Caelian and the valley between that hill and the Esquiline; (2) Esquilina; (3) Oppius and Cispius; (4) Collina, the Quirinal and Viminal; (4) Palatina, including the Palatine and Velia. The third region was an addition to the City of the Seven Hills; the new city was, in fact, formed by the union of the old Latin settlement with a Sabine community on the Quirinal. The Capitol was the citadel, but was not included in the city (hence the phrase *urbis et Capitolium*).

Tradition likewise assigned to Servius Tullius³ the construction of the great wall which embraced not merely the four regions but a considerably extended area, including the Aventine. Excavations have done much to determine the line of the Servian wall, especially the great works undertaken in laying out a new quarter of the city on the Quirinal, Esquiline and Viminal, which have laid bare and then more fully destroyed long lines of wall, especially along the *agger*. Beginning from the Tiber, which the Servian wall touched at a point near the present Ponte Rotto, and separating the Forum Holitorium (outside) from the Forum Boarium (inside), it ran in a straight line to the Capitoline hill, the two crests of which, the Capitolium and the Arx, with the intermediate valley the Asylum, were surrounded by an earlier fortification, set (Dionys. ix. 68) *ἐπὶ λόφοις . . . καὶ τείχεος ἀποτότοις*. In this space there were two gates, the *Porta Flumentana*, next the river (see Cic. *Ad Alt.* vii. 3; Liv. xxv. 19, 21); and the *Porta Carmentalis* close to the Capitol. From the Capitoline hill the wall passed to the Quirinal along a spur of elevated ground, afterwards completely cut away by Trajan. Close to the Capitol was the *Porta Fontinalis*, whence issued the *Via Lata*. Remains of the wall and foundations of the gate exist in *Via di Marforio*. After passing Trajan's forum, we find remains of the walls on the slope of the Quirinal. A piece of the wall has been exposed in the new *Via Nazionale*, and also an archway under the Palazzo Antonelli, which may represent the *Porta Sanquales* (see Festus, ed. Müller, p. 343). The *Porta Salutaris* (Festus, pp. 326-327) was also on the Quirinal, probably on the slope between the Trevi fountain and the royal palace. Its position is indicated by the existence of some tombs which give the line of the road. On the north-west of the Quirinal was the *Porta Quirinalis* (Festus, p. 254), probably near the "Quattro Fontane" in the Barberini and the gardens, and especially in those of the *Villa Barberini* (Horti Sallustiani); extensive remains of the wall have been recently exposed and destroyed, which was also the fate of that fine piece of wall that passed under the new office of finance, with the *Porta Collina*, which was not on the line of the present road, but about 50 yds. to the south (see Dionys. ix. 68; Strabo iv. p. 234). Thus far in its course from the Capitol the wall skirted the slopes of hills, which were once much more abrupt than they are now; but from the *Porta Collina* to the *Porta Esquilina* it crossed a large tract of level ground; and here its place was taken by the great *agger* described below. About the middle of it the *Porta Viminalis* was found in 1872; it stood as the *Strada* on the northern height, P. Raudusculana in the central depression, and P. Lavernalis on the northern summit. Under the Aventine it appears to have touched the river near the existing foundations supposed to be those of the Pons Sublicius. The *Porta Trigemina* was close by the bank. Hence to our starting-point the river formed the defence of the city, with its massive quay wall.

The wall is built of blocks of tufa, usually the softer kinds, but varying according to its position, as in most cases the stone used was that quarried on the spot. In restorations a good deal of peperino is used. The blocks average from 23 to 24 in. in thickness—roughly 2 Roman feet—and are laid in alternate courses of headers and stretchers. The method of construction varied according to the nature of the ground

¹ Varro, *L.L.* v. 46-54.

² Livy, i. 44; Dion. Hal. iv. 13. The wall is, however, said to have been planned and partly executed by Tarquinius Priscus (Liv. i. 36, 38; Dion. Hal. iii. 37); and the fortification of the Aventine is ascribed to Ancus Marcius (Dion. Hal. iii. 43).

³ See Sol. i. 13; Liv. ii. 49, xxiv. 47, xxv. 7, xxvii. 37; Ascon. *Ad. Cic. in Toga*, p. 81.

¹ "Novalia," MSS. "Navalia" has been conjectured.

traversed by the fortification. Where the wall followed the face of the cliffs, as for instance on the Capitol and Quirinal, it was raised on an artificial shelf after the fashion employed on the Palatine (*vide supra*). In other places, where the slope was gentler, the wall was formed of rubble with revetments of opus quadratum, e.g. on the Aventine; finally, where the ground was flat, as on the plateau of the Esquiline, a ditch was dug and an embankment formed by the upcast; this agger, as it was called, was then faced with retaining walls of opus quadratum. The length of the agger on the Esquiline is put by Dionysius (ix. 68) at 7 stadia, which agrees, roughly speaking, with the discoveries made in 1876-1879, when the railway station was built and the new quarters laid out. The total length was about 4225 ft., the thickness of wall and agger about 50 ft., while the ditch was 100 Roman ft. in width and 30 in depth. There is, however, a difference in technique between the inner and outer tufa retaining walls of the agger. The inner wall is built of greenish tufa in blocks of irregular size, while in the outer brown tufa is employed and the blocks are of standard size, two headers ranging along. Between the railway station and the Dogana a fine lofty piece of the front wall remains, with traces of the Porta Viminalis and of the lower back wall. Unfortunately the whole of the bank or agger proper has been removed, and the rough back of the great retaining wall exposed. Both tufa and peperino are used, the latter in restored parts; the blocks vary in length, but average in depth the usual 2 Roman ft. The railway cutting, which has destroyed a great part of the agger, showed clearly the section of the whole work: the strata of different kinds of soil which appeared on the sides of the foss appeared again in the agger, and reversed as they naturally would be in the process of digging out and retaining up. Dionysius (ix. 68) states the length of the agger to have been 7 stadia—that is, about 1400 yds.—which agrees (roughly speaking) with the actual discoveries. Originally one road ran along the bottom of the foss and another along its edge; the latter existed in imperial times. But the whole foss appears to have been filled up, probably in the time of Augustus, and afterwards built upon; the houses of mixed brick and opus reticulatum still exist against the outside of the great wall, which was itself used as the back wall of these houses, so that we now see painted on the wall the time of Hadrian covering parts of the wall of the kings. Another row of houses seems to have faced the road mentioned above as running along the upper edge of the foss, thus forming a long street. As early as the time of Augustus a very large part of the wall of the kings had been pulled down and built over, so that even then its circuit was difficult to trace (Dionys. iv. 13). A very curious series

of masons' marks exist on stones of the agger wall (as *Masons' marks* well as on those of some other early buildings). They are deeply incised, usually in groups on the ends of the blocks, and average from 10 to 14 in. in length: some are single letters or monograms; others are numbers, e.g. 1, 2, 3, 4, 5, 6, 7, 8, 9, 10, 11, 12, 13, 14, 15, 16, 17, 18, 19, 20, 21, 22, 23, 24, 25, 26, 27, 28, 29, 30, 31, 32, 33, 34, 35, 36, 37, 38, 39, 40, 41, 42, 43, 44, 45, 46, 47, 48, 49, 50. Fig. 6 shows the chief forms from the Palatine and Esquiline.¹

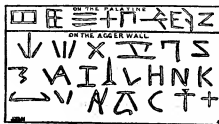

There are also extensive remains of the "Servian" wall on the Aventine, in the Via di Porta S. Paolo. Here the wall has a concrete core and the upper portion is built with blocks of peperino, set in mortar and bevelled at the edges. These are unmistakable signs that the wall has undergone restoration. This portion is pierced by an arch about 9 ft. high, which probably served as an embrasure for a military engine. Finally, where the wall skirts the bank of the Tiber it is built in two sections—a foundation about 2 metres in height and 3 in width, which forms a landing-stage, and an upper wall, 6 metres high, which retains the bank. It is built of peperino, and is probably later than the rest of the fortification.

The age of this wall is uncertain, but it has been rendered exceedingly probable that it belongs to the 4th century B.C. The evidence for this is derived from the comparison of other fortifications in central Italy, from the measurements of the blocks employed, which presuppose the later Roman foot of 296 millimetres, and from the character of the alphabet from which the masons' marks are taken.² Livy (vi. 32) speaks of a contract entered into by the censors of 378 B.C. for the construction of a wall of opus quadratum, and this probably refers to the older portions of the existing wall, which was built owing to the fear of a second Gallic invasion.³

The Servian city did not include what is now the most crowded part of Rome, and which under the Empire was the most architecturally magnificent, namely, the Campus Martius, which was probably to a great extent a marsh. It was once called Ager Tarquiniorum, but after the expulsion of the Tarquins was named Campus Martius from an altar to Mars, dating from prehistoric times (Liv. ii. 5).

Of that wonderful system of massive arched sewers⁴ by which, as Dionysius (iii. 68) says, every street of Rome was drained into the Tiber, considerable remains exist, especially of the Cloacae, under the Forum along the Velabrum, and so into the Tiber by the round temple in the Forum Boarium; it is still in use, and well preserved at most places. Its mouth, an archway in the great quay wall nearly 11 ft. wide by 12 high, consists of three rings of peperino "voussoirs," most neatly fitted. The rest of the vault and walls is built of mixed tufa and peperino.⁵ Pliny (H.N. xxvii. 104) gives an interesting account of what is probably this great sewer, big enough (he says) for a loaded hay-cart to pass along. The mouths of two other similar but smaller cloacae are still visible in the great quay wall near the Cloaca Maxima, and a whole network of sewers exists under a great part of the Servian city. Some of these are not built with arched vaults, but have triangular tops formed of courses of stone on level beds, each projecting over the one below—a primitive method of construction, employed in the Tullianum. The great quay wall of tufa and peperino which lined the Tiber at the mouth of the Cloaca Maxima is also of early date. In later times this massive wall was extended, as the city grew, all along the bank of the Campus Martius, and, having lost its importance as a line of defence, had frequent flights of stairs built against it, descending to the river. Some of these are shown in one of the fragments of the marble plan (see Jordan, *op. cit.*, p. 166). In 1879 a travertine block was dredged up inscribed P. BARRONIVS. BARBA. AED. CVR. GRADOS. REFECIT, dating from the first century A.C. This records the repair of one of these river stairs.⁶

The Tullianum is the earliest of the existing buildings of Rome. Imprisonment as a punishment was unknown to Roman law, and hence the Carcer, where criminals were detained pending trial, was of small dimensions. Its remains are preserved beneath the church of S. Giuseppe dei Falegnami, and below them is the Tullianum, an ancient work of executions took place. It is partly cut in the tufa rock of the Capitoline hill and partly built of 2-ft. blocks of tufa, set with thin beds of pure lime mortar, in courses projecting one over the other. Its name is derived, not from Servius Tullius, as Varro (v. 151) asserts, but from an early Latin word, *tullus*, a spring of water; its original use was probably that of a cistern or well. It was closed by a conical vault, arched in shape, but not constructionally an arch—very like the so-called "treasury of Atræus" at Mycenae, and many early Etruscan tombs. When the upper room with its arched vault, also of tufa, was built the upper part of the cone seems to have been removed, and a flat stone floor (a flat arch in construction) substituted.⁷ That its use as a cistern was abandoned is shown by the cloaca which leads from it, through the rock, to a branch of the Cloaca Maxima. This horrible place was used as a dungeon, prisoners being lowered through a hole in the stone floor—the only access. The present stairs are modern. The two chambers are vividly described by Sallust (*Cat.* 55). The entrance to the upper prison was on the left of the stairs leading up from the Forum to the Clivus Argentarius, the road to the Porta Fontinalis (see fig. 7, General Plan of Ancient Rome). The entrance to the lower prison, as well as Jugurtha, Verencingtorix and the Catiline conspirators, as well as Jugurtha, Verencingtorix and the Catiline conspirators, were killed or starved to death in this fearful dungeon, which is called τὸ βάρβαρον by Plutarch (*Marius*, xii.). According to a doubtful tradition of the Catholic Church, St. Peter was imprisoned in the Tullianum. The name Mamertine prison is of medieval origin. The front wall of the prison was restored in the reign of Tiberius A.D. 22, and bears this inscription on a projecting string-course: C. VIBIVS. C. P. F. RVFINVS. M. COCCIVS. I. M. F. NERVAIO. C. EX. S. C. The floor of the upper prison is about 16 ft. above the level of the Forum. The Capitol was approached from the Carcer by a flight of steps—*Scalae Gemoniae*—on which

Mura di Roma (1820); Piale, *Porte del Rincino di Servio* (1833); Becker, *De Romae Muris* (Leipzig, 1842); Lanciani, *Ann. Inst.*, (1871), p. 40; *Mon. Inst.*, ix. pl. xxvii.; Borsari, "Le mura e porte di Servio," *Bull. Mon. Arch.* (1888), p. 12 ff.

⁴ See Liv. i. 38, 50; Dionys. ii. 44.

⁵ In the upper part of its course the Cloaca Maxima was restored in some places, under the Empire, with a vault of brick-faced concrete; at the entrance to the Forum a large bend was made when the Basilica Aemilia was extended westwards in 34 B.C.

⁶ A great quay wall with arched cloaca, similar in style to those in Rome, exists at the mouth of the river Marta near Tarquinii, and similar constructions are found in other Etruscan cities.

⁷ Livy (3. 33) mentions the "carcer . . . media urbe imminens fori . . ." and also speaks (xxxiv. 44) of an "inferiore carcerem," and at xxix. 22 of a criminal being put in the Tullianum.

⁸ Consules suffecti for A.D. 22.

¹ See Bruzza, *Ann. Inst.* (1876), 72; Jordan, *Topographie*, i. 250; Richter, *Über antike Steinmetzzeichen* (1885).

² See Richter in the work quoted above, and *Beiträge zur römischen Topographie* (Berlin, 1903); also Delbrück, *Der Äpollontempel auf dem Marsfelde in Rom*, pp. 14 ff.

³ For earlier studies of the Servian wall consult Nibby and Gell, *Le*

the bodies of criminals were exposed;¹ Pliny (*H.N.* viii. 145) calls it the "stairs of sighs" (*gradus gemitorii*).

Forum Romanum and Adjacent Buildings.

The Forum Romanum or Magnum, as it was called in later times to distinguish it from the imperial fora, occupies a valley which extends from the foot of the Capitoline hill to the north-west part of the Palatine. Till the construction of the great cloacae it was, at least in wet seasons, marshy ground, in which were several pools of water. In early times it was bounded on two sides by rows of shops and houses, dating from the time of the first Tarquin (Liv. i. 35). The shops on the south-west side facing the Sacra Via, where the Basilica Julia afterwards was built, were occupied by the *Tabernae Veteres*.² The shops on the northern side, being occupied by silversmiths, were called *Tabernae Argentariae*, and in later times, when rebuilt after a fire, were called *Tabernae Novae* (see Liv. xxvi. 27, xl. 51).³ An altar to Saturn (Dionys. i. 34, vi. 1), traditionally set up by the companions of Hercules, and an altar to Vulcan, both at the end towards the Capitol, with the temple of Vesta and the Regia at the opposite end, were among the earliest monuments grouped around the Forum. The Lacus Curtius vanished, as Varro says (*L.L.* v. 148-49), probably with other stagnant pools, when the cloacae were constructed (Liv. i. 38, 50).⁴ Another pool, the Lacus Servilius, near the Basilica Julia, was preserved in some form or other till the imperial period. Under Sulla it was used as a place to expose the heads of many senators murdered in his proscriptions (Cic. *Rosc. Am.* 32, 80; Seneca, *De Prov.* 3, 7). The Volcanal was an open area, so called from the early altar to Vulcan, and was (like the Comitium) a place of public meeting, at least during the regal period.⁵ It was raised above the Comitium, and was a space levelled on the lower slope of the Capitoline hill behind the arch of Severus; the foundations of the altar were discovered in 1898. It was probably much encroached upon when the temple of Concord was enlarged in the reign of Augustus. Fig. 8 gives a carefully measured plan of the Forum, showing the most recent discoveries.

Unlike the fora of the emperors, each of which was surrounded by a lofty wall and built at one time from one design, the architectural form of the Forum Romanum was a slow growth. The marshy battlefield of the early inhabitants of the Capitol and Palatine became, when the ground was drained by the great cloacae, under a united rule the most convenient site for political meetings, for commercial transactions, and for the pageants of rich men's funerals, *Iudi scenicis*, and gladiatorial games.⁶ For these purposes a central space, though but a small one, was kept clear of buildings; but it was gradually occupied in a somewhat inconvenient manner by an ever-accumulating crowd of statues and other honorary monuments. On three sides the lines of this open space are marked by paved roads, faced by the stately buildings which gradually took the place of the simple wooden *tabernae* and porticus of early times. The Comitium⁷ was a level space in front of the Curia; the construction of both is ascribed to Tullus Hostilius. For the position of the Comitium and the Curia⁸ see plan of Forum (fig. 8). Varro (*L.L.* v. 155-56) gives the following account of the buildings which were grouped along the northern angle of the Forum:—

"Comitium ab eo quod corbant eo comitiis curiatis et litium causa. Curiae duorum generum, nam et ubi curarent sacerdotis res

divinas, ut Curiae Veteres, et ubi senatus humanae, ut Curia Hostilia, quod primum aedificavit Hostilius rex. Ante hanc Rostra; quoque loci id vocabulum, quod ex hostibus capta fixa sunt rostra. Sub dextra huius a Comitio locus substructus, ubi nationum subsistent legati qui ad senatum essent missi. Is Graecostasis appellatus a parte ut multa. Senaculum supra Graecostasis, ubi Aedis Concordiae et Basilica Opimia. Senaculum vocatum, ubi senatus, aut ubi senatus consistere solent."

The curia or senate-house passed through many vicissitudes.⁹ At first called Curia Hostilia, from its founder Tullus Hostilius (Liv. i. 30), it lasted till 52 B.C., when it was burnt at the funeral of Clodius, and was then rebuilt by Faustus Sulla, and from his gens called Curia Cornelia (Dio Cass. xl. 50). It was again rebuilt by Julius Caesar, and dedicated by Augustus (29 B.C.) under the name of the Curia Julia, as recorded in the inscription of Ancura (q.v.)—**CVRIAM, ET, CONTINENS, EI, CHALCIDICVM** ... **FECL**. Little is known about the adjoining buildings called the *Athenaeum* and *Chalcidicum*; Dion Cassius (li. 22) mentions the group. In the reign of Domitian the Curia Julia was restored (Prosop. Aquit. p. 571); and it was finally rebuilt by Diocletian. The existing church of S. Adriano is the Curia of Diocletian, though of course much altered, and with its floor raised about 20 ft. above the old level. The level of the entrance was raised in the middle ages, and again in 1654. Sixteenth-century drawings and engravings show the lower level. The ancient bronze doors now at the end of the nave of the Lateran basilica originally belonged to this building, and were removed thence by Alexander VII. The brick cornice and marble consoles, covered with enriched mouldings in stucco, and the sham marble facing, also of stucco, if compared with similar details in the baths of Diocletian, leave no doubt as to this being a work of his time, and not, as was at one time assumed, the work of Pope Honorius I. (A.D. 625-38) who consecrated it as the church of S. Adriano.

From the Curia a flight of steps led down to the Comitium (Liv. i. 36), a space consecrated as a *templum* according to the rules of augury (Cic. *De Or.* iii. 3) and used for the meetings of the *Comitia Curiate*, and for certain religious ceremonies performed, after the fall of the monarchy, by the *rex sacrificulus*. It contained ancient monuments, relics, such as the *figus ruminalis*, and the supposed tomb of Romulus, whose site was marked in later times by a "black stone" (*lapis niger*). Facing the Curia stood the platform from which speakers addressed the people, adorned in 238 B.C. with the beaks of the ships captured from the Latins at the naval victory of Antium and hence called the *rostra*. Caesar determined to remove the *rostra* from the Comitium to the Forum, and this plan was carried out after his murder. From the original *rostra* Cicero delivered his *Second and Third Catiline Orations*, and they were the scene of some of the most important political struggles of Rome, such as the enunciation of their laws by the Gracchi. Beside the Comitium another monument was erected, also adorned with beaks of ships, to commemorate the same victory at Antium. This was the *Columna Maeniana*, so called in honour of Maenius (Plin. *H.N.* xxvii. 20, vii. 21a). The *Columna Duilia* was a similar monument, erected in honour of the victor of C. Duilius over the Punic fleet in 260 B.C.; a fragment of it with inscription (restored in imperial times) is preserved in the Capitoline Museum.¹⁰ Columns such as these were called *columnae rostratae*.

In 1899-1900 the site of the Comitium—which was considerably reduced in extent by the building of the later Curia—was excavated by Commendatore Boni, in some parts as far as the virgin soil.¹¹ Remains of walls and pavements of various periods (some very early) were discovered; some of the walls, there is no doubt, supported the platform of the early *rostra*, which appears to have been at first rectangular and at later time square. Opposite to the Curia is a square paved with black marble slabs, which it is natural to identify with the *lapis niger* of tradition. Beneath this pavement was found a group of early monuments, which were at some time destroyed and afterwards covered over. We are told on the authority of Varro that Romulus was buried in front of (or behind) the *rostra*, and that two lions were sculptured as guardians of his tomb; and we find in fact a foundation (D. fig. 9) from which project two moulded bases of tufa (A, B) on which the lions may well have stood, on either side of a block (C) which might serve as an altar. Beside this tomb (if it be) stood the trunk of a tufa column (E) and a rectangular *stela* (F) which bears on all its faces an inscription written alternately upwards and downwards, so that only the ends of the lines can be read. That it is the earliest specimen of the Latin language is undoubted; and it certainly mentions the *rex*. But after the expulsion of the kings the *rex*

¹ See Tac. *Hist.* iii. 74, 85; Suet. *Vit.* 17.

² See Livy (dii. 16), who mentions a house of P. Africanus, "pone veteres ad Vortumnium, in quibus" which was bought by T. Sempronius to clear the site for the Basilica Semproniana in 169 B.C. This basilica was afterwards absorbed in the Basilica Julia.

³ Hence these two sides of the Forum are frequently referred to in classical writings as "sub veteribus" and "sub novis."

⁴ In later times it was an enclosed space containing an altar; it is described by Ovid (*Fast.* vi. 403); according to one tradition it marked the spot where Curtius's self-immolation filled up the chasm which had opened in the Forum (see Dionys. ii. 21). (See below.)

⁵ See Dionys. ii. 50, vi. 67; Plin. *H.N.* xvi. 436; Plut. *Quaes. Rom.* 47.

⁶ The first gladiatorial show in Rome was given in 264 B.C. in the Forum Boarium by D. Junius Brutus at his father's funeral (Liv. *Epit.* xvi.), the first in the Forum Romanum in 216 B.C. (Liv. xxiii. 30). See also Liv. xxxi. 50, xli. 28; and Suet. *Caes.* 39; *Aug.* 43; and *Tib.* 7.

⁷ On the Comitium see Detlefsen, *Ann. Inst.* (1860), pp. 128 ff., and the works mentioned below, note 11.

⁸ Livy (xlv. 24) indicates their relative positions by the phrase "comitium vestibulum Curiae."

⁹ On the Curia and its vicissitudes see Lanciani, *L'Aula e gli Uffici del Senato Romano* (1883).

¹⁰ The column itself is a copy made by Michelangelo; it is at the foot of the stairs of the Palazzo dei Conservatori.

¹¹ The discoveries of Comm. Boni have given rise to much discussion. Of the numerous articles, &c., which have appeared it will suffice to name Petersen, *Comitium, Rostra, Grab des Romulus* (1904), and Pinza, *Il Comizio romano nell'età repubblicana* (1905); see Huelsen, *The Roman Forum*, pp. 110 ff.

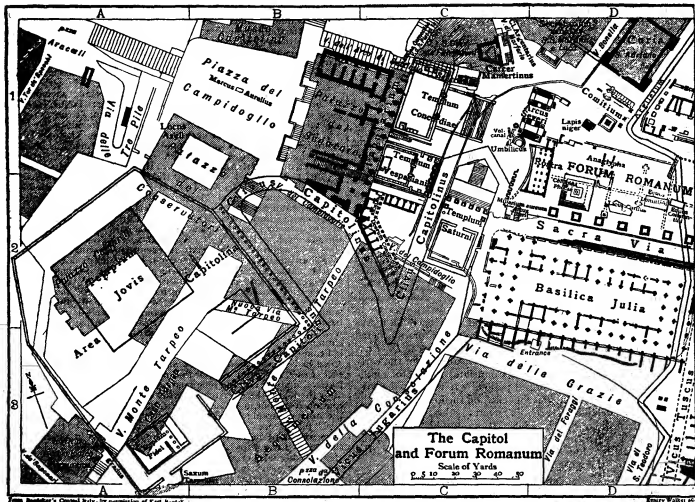

FIG. 8.—The Roman Forum

sacrificulus performed his functions in the Comitium, and the inscription may refer to him. This may be the stele to which Dionysius of Halicarnassus refers as marking the tomb of Hostus Hostilius (father of Tullus Hostilius) whose site (according to those who believed in the translation of Romulus to heaven) was marked by the *lapis niger*.

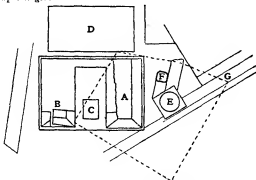

FIG. 9.—Early Monuments in the Comitium.

- A. B. Moulded tufa bases.
C. Base of altar (?).
D. Rectangular foundation.
E. Truncated column.
F. Stele with inscription.
G. Steps leading to platform of rostra.

The dotted line shows the position of the *lapis niger*.

The Senaculum appears to have been a place of preliminary meeting for the senate before entering the Curia (Liv. xli. 27; Val. Max. ii. 2, 6); it adjoined the temple of Concord, and when this was rebuilt on an enlarged scale in the reign of Augustus it appears probable that its large projecting portico became the Senaculum.

A great part of the north-east side of the Forum was occupied by two basilicae, which were more than once rebuilt under different names. The first of these appears to have been adjacent to the Curia, on its west side; it was called the Basilica Porcia, and was founded by the elder Cato in 185 B.C.

(see Liv. xxxix. 44, and Plut. *Cato Major*, 19); it was burnt with the Curia at Clodius's funeral. On the north side of the Forum another basilica, called Aemilia et Fulvia (Varro vi. 4), was built in 179 B.C. by the censors M. Fulvius and M. Aemilius Lepidus;¹ it stood, according to Livy (xl. 51), "post argentarias novas," the line of silversmiths' shops along the north-east side of the Forum. In 50 B.C. it was rebuilt by L. Aemilius Paulus with Caesar's money (Plut. *Caes.* 29; Appian, *Bell. Civ.* ii. 26), and was more than once restored within the few subsequent years by members of the same family. Its later name was the Basilica Pauli, and it was remarkable for its magnificent columns of Phrygian marble (Plin. *H.N.* xxxvi. 102) or pavonazzetto. Part of the western end was still standing in the 16th century, and was drawn by Giuliano da Sangallo (Huelsen, *The Roman Forum*, fig. 61). Recent excavations have shown that it was approached from the Forum by a flight of steps leading to a two-storied colonnade. Behind this was a row of tabernae in the middle of which was the entrance to the main hall, consisting in a nave and three aisles (two on the north side).

Near the middle of the north-east side of the Forum stood also the small bronze temple of Janus,² the doors of which were shut on those rare occasions when Rome was at peace.³ A first brass of Nero shows it as a small cella, with richly ornamented frieze and cornice. Another *medulla* near that of Janus was the shrine of Venus Cloacina (or the Purifier), on the line of the cloaca which runs under the Basilica Aemilia;

¹ The Forum Piscatorium or fish-market appears to have been at the back of this basilica (see Liv. xl. 51).

² The original temple was one of the prehistoric buildings attributed to Romulus and Tatius (Serv. *Ad Aen.* i. 291), or by Livy (i. 19) to Numa.

³ See *Mon. Anc.* 2, 42; Procop. *Bell. Goth.* i. 25; Liv. i. 19; Suet. *Aug.* 22.

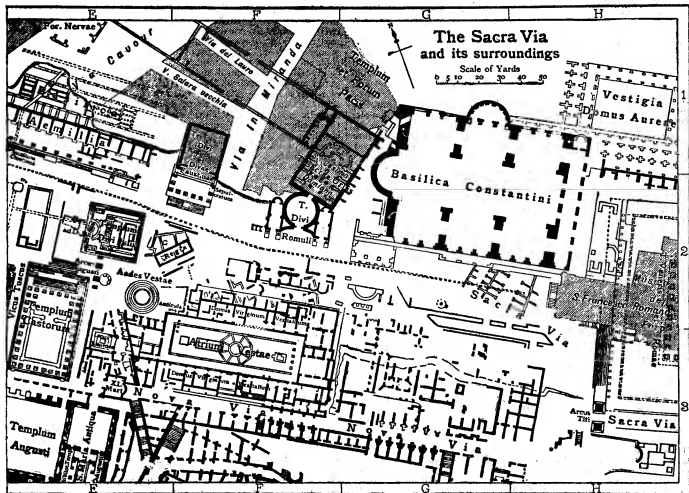

Arch. 234/2000. C. 10/10. By permission of the British Museum. and the Sacra Via.

its foundations and plinth were brought to light in 1899 (Liv. iii. 48; Plin. *H.N.* xv. 119).

Fig. 8 shows plan of the rostra as they existed under the Empire. We see an oblong platform about 78 ft. long and 11 ft. high above the level of the Forum; its ground floor, paved with herring-bone bricks, is 2 ft. 6 in. below the Forum paving.

Existing rostra. Its end and side walls are of tufa blocks, 2 ft. thick and 2 ft. wide, each carefully clamped to the next with wooden dovetail dowels. Its floor was supported by a series of travertine piers, carrying travertine lintels, on which the floor slabs rested. Outside it was completely lined with Greek marble and had a richly moulded plinth and cornice; the front wall was restored in 1904, and the fragments of the cornice replaced. A groove cut in the top of the cornice shows the place where marble cancelli were fixed; one of the cornice blocks is partly without this groove, showing that the screen did not extend along the whole front of the rostra. This agrees with a relief on the arch of Constantine, representing the emperor making an oration from the rostra, with other buildings at this end of the Forum shown behind. In this relief the screen is shown with a break in the middle, so that the orator, standing in the centre, was visible from head to foot. Two tiers of large holes to hold the bronze rostra are drilled right through the tufa wall, and even through the travertine pilasters where one happens to come in the way; these holes show that there were nineteen rostra in the lower tier, and twenty above set over the intermediate spaces of the lower row. The back wall of the rostra is of concrete faced with brick. The inside space, under the main floor of the rostra, is coated thickly with stucco—the brick wall being studded in the usual way with iron nails to form a key for the plaster.

Immediately behind the rostra is a curved platform approached by steps from the side facing the Capitol. It has been much disputed whether this platform is earlier or later than the rostra; but the evidence of the construction at the point of juncture seems to show that the hemicycle is the earlier. When the arch of Severus was built, part of the platform of the rostra was cut away and a court of irregular shape was thus formed, from which the rostra was approached by steps. The front wall of the hemicycle was now exposed in its eastern half; this was faced with slabs of porta santa marble, pilasters of africano, and a moulded

plinth of white marble, whose blocks bear the Greek characters T, Δ, E, Z, H, Θ, K; the omissions make it clear that the blocks were removed from some other building. A number of holes in the marble, some of which contain fragments of metal pins, show that bronze ornaments were at one time attached to the facing. The hemicycle has been identified (without sufficient reason) with the Graecostasis, a platform near the rostra reserved for foreign embassies (Varro, *L.L.* v. 155; Cic. *Q.F.* ii. 1), which continued to exist throughout the imperial period and was restored by Antoninus Pius (*Vita* 9, 2). It is, however, far more likely that it represents the original form of the rostra as removed to the Forum according to Caesar's design.¹ When the oblong platform was built (perhaps by Trajan) it was approached from the back by the hemicycle. The bronze rostra on the imperial structure were believed to be the original beaks from Antium, moved from the old rostra (Florus, i. 11). On its marble platform stood many statues,² e.g. of Sulla, Pompey, two of Julius Caesar, and others (Dio Cass. xlii. 18 and xlv. 4); these are represented on a bas-relief from the arch of Constantine. It is further commonly believed that the marble *putei* which now stand in the centre of the Forum once decorated the rostra. Owing probably to the weight of the many statues proving too much for the travertine piers, which are not set on their natural beds but endways, and therefore are very weak, the structure seems to have given way at more than one time, and the floor has been supported by piers and arches of brick-faced concrete,

¹ See Mau in *Röm. Mitt.* 1906, pp. 230 ff.

² The original rostra had specially honorary statues to those Roman ambassadors who had been killed while on foreign service (Liv. iv. 17); these were probably removed during Cicero's lifetime (Cic. *Phil.* ix. 2, 4; see also Dio Cass. xliii. 49, and Plin. *H.N.* xxiv. 23, 24). Ghastly ornaments fixed to these rostra in the year 43 B.C., shortly after they were built, were the head and hands of the murdered Cicero (Appian, *Bell. Civ.* iv. 20; Dio Cass. xlvii. 8; Liv. x. 120), as on the original rostra had been fixed many heads of the chief victims of the proscriptions of Marius and Sulla (see Appian, *Bell. Civ.* i. 71, 94; Florus iii. 21). The denarius of the gens Lollia with the legend **PALIKANVS** represents the rostra of the late republican period.

inserted either in place of or at the sides of the shattered piers. These later additions, apparently of the 3rd and 4th centuries, are omitted in fig. 8 for the sake of clearness. In or about A.D. 470 the façade of the rostra was prolonged northwards by an addition in very poor brickwork, apparently to celebrate a naval victory over the Vandals.

At the northern end of the curved platform there is a cylindrical structure of concrete faced with brick and lined with thin marble slabs; it is in three stages, each diminishing in size, and appears to be an addition of about the time of Severus. This is usually identified with the Umbilicus Romae, or central point of the city, mentioned in the *Notitia* and the Einsiedeln MS. (Jordan, *Topographie der Stadt Rom*, ii. 655).

Near the rostra, below the temple of Saturn, stood the *Milliarium Aureum*, a marble column sheathed in gilt bronze and inscribed with the names and distances of the chief towns on the roads which radiated from the thirty-seven gates of Rome (Plin. *H.N.* iii. 66). It was set up by Augustus in 20 B.C., and its position "sub aede Saturni" is indicated by Tacitus (*Hist.* i. 27; see schol. on Suet. *Obio*, 6, and Plut. *Galba*, 24). The *Milliarium* is mentioned in the *Notitia* (Reg. viii) as being near the *Vicus Jugarius*. Its precise position cannot be determined. Fragments of a marble cylinder and cornice with floriated reliefs, now lying in front of the temple of Saturn, probably belonged to this monument; they were found in 1835 near the supposed site.

The position of the temple of Saturn is indicated in *Mon. Anc.* (see below, n. 6) and shown on the marble plan, and is also identified by various passages in ancient writers. Varro (*L.L.* v. 42) speaks of it as being in *Janiculis Capitolii*; Servius (*Ad Aen.* ii. 115) says that it is in front of the *Clivus Capitolinus*, and near the temple of Concord (see Plate VIII.). It was built against a steep slope or outlying part of the *Capitolium Hill* (cf. Dionys. i. 34) on the site of the old city wall of Saturn, after whom the *Capitolium Hill* was originally called *Mons Saturni*. The public treasury was part of this temple (Serv. *Ad Aen.* ii. 116, and Macrobi. *Sat.* i. 8). The original temple is said by Varro (ap. Macrobi. i. 8) to have been begun by the last Tarquin, and dedicated by T. Larcius, the first dictator, 498 B.C.; but Dionysius (vi. 1) and Livy (ii. 21) attribute it to the consuls A. Sempronius and M. Minucius in 497 B.C. It was rebuilt on a larger scale by L. Munatius Plancus in 42 B.C. (Suet. *Aug.* 29). The only part remaining of this date is the very lofty podium of massive travertine blocks, and part of the lower course of Athenian marble, with which the whole was faced. In the 16th century a piece of the marble frieze was found, inscribed with PLANCVS L. F. COS IMPER. ITER. DE MANIB. (C.I.L. vi. 1316). The erection of the six granite columns in the front and two at the sides, with their clumsily patched entablature, bearing the inscription SENATVS . POPVLVSQVE . ROMANVS . INCENDIO . CONSVMTVM . RESTITVIT, belongs to the last rebuilding in the time of Diocletian. Some of these fine columns are evidently earlier than this rebuilding, but were refixed with rude caps and bases. One of the columns is set wrong way up, and the whole work is of the most careless sort. Part of the inscription, once inscribed with bronze, recording this latest rebuilding, still exists on the entablature. On the Forum side the temple is flanked by the *Vicus Jugarius*, while the steep *Clivus Capitolinus* winds round the front of the great flight of steps leading up to the cella, and then turns along the north-west side of the temple.²

The *Vicus Jugarius* (see fig. 8), part of the basal paving of which is now exposed, was so called (see Festus, ed. Müller, p. 104) from an altar to Juno Juges, the guardian of marriage. Starting from the Forum, it passed between the temple of Saturn and the *Basilica Julia*, then close under the cliff of the *Capitolium* (see *liv.* xxxv. 21) and on to the *Porta Carmentalis*. It was apparently at its commencement by a brick-faced arch lined with marble, the lower part of which exists, and is not earlier than the 3rd or 4th century.³ At this end of the Forum the arch of Tiberius was built beside the *Sacra Via*. It was erected in A.D. 17, to commemorate the recovery of the standards lost by Varus.⁴ The concrete foundation has recently been exposed.

The *Basilica Julia*⁵ occupies a great part of the south-west side of the Forum, along the line of the *Sacra Via*; its ends are bounded by the *Vicus Jugarius* and the *Vicus Tuscus*. It was begun by Julius Caesar, who dedicated it when still unfinished, on the 26th of September 46 B.C., completed

by Augustus, and again rebuilt by him after a fire, as is recorded in *Mon. Anc.* 4, 13,⁶ in an important passage which gives its complete early history. It consisted of a central hall with aisles, galleries and clerestory, surrounded on three sides by a colonnade in two storeys approached by steps; on the S.W. a row of rooms or tabernae took the place of the colonnade. The central nave was paved with richly coloured oriental marbles, namely pavonazetto, cipolino, giallo and africano. The covered aisles are paved with large slabs of white marble.⁷ Many *basilae horariae* or gambling boards, are scratched in this marble paving (cf. Cic. *Plur.* 73).⁸ Low marble cancelli, with moulded plinth, closed the otherwise open arches of the basilica; many fragments exist, and one piece of the subplinth is still *in situ*. This basilica held four law-courts, which in important cases held joint sessions. Trajan and other emperors held law-courts there (Dio Cass. lxxxviii. 10). An inscription found near it (C.I.L. vi. 1658) records its restoration by Septimius Severus in A.D. 199, after a fire; it was again burnt in 283 and restored by Diocletian. These fires had destroyed nearly all the fine marble arches of Augustus; and Diocletian rebuilt it mostly with brick or travertine piers, portions of which remain.⁹ A final restoration is recorded in inscriptions discovered at various times from the 16th century onwards, as being carried out by Gabinus Vettius Probianus, praefect of the city in 377; one of these is on a pedestal which now stands in the *Vicus Jugarius*. Suetonius (*Cal.* 37) mentions that it was one of Caligula's amusements to throw money to the people below from the roof of this basilica, which formed a link in the bridge by which this maniac connected the Palatine with the *Capitolium*.

The *Vicus Tuscus* passes from the *Sacra Via* between the *Basilica Julia* and the temple of Castor to the *Velabrum* and *Circus Maximus*; its basal paving has been exposed at many points along its whole line. A very early statue of Vortumnus (*Vicus Tuscus*).

is found in this street, a little to the south-west of the *Basilica Julia*, where part of its pedestal was found in 1549 inscribed VORTVMNVS TEMPORIBVS DIOCLETIANI ET. MAXIMIANI . . . (C.I.L. vi. 804);¹⁰ see also Pseudo-Ascon, *Ad Cic. Verr.* ii. 1, 59). The *Vicus Tuscus* was also called *Thurarius*, from shops of perfumersellers (see Schol. ad Hor. *Sat.* ii. 3, 228, and *Ep.* ii. 1, 269). It is the street along which processions passed, mentioned by Cicero (*Verr.* ii. 1, 59) as extending a *signo Vertumnus in Circum Maximum*.

The temple of Castor¹¹—or, more properly, of "the Castores," i.e. Castor and Pollux—on the south-east side of the *Vicus Tuscus* was founded to commemorate the apparition in the Forum of the *Temple of Castor*.

of the Dioscuri, announcing the victory of Aulus Postumius at Lake Regillus, 496 B.C., and was dedicated in 484 B.C., by the son of A. Postumius (Liv. ii. 20, 42; Dionys. vi. 13; *V. Fast.* i. 706). In 119 B.C. it was restored by the consul L. Caecilius Metellus Dalmaticus (Ascon. *In Cic. Pro Scaur.* 46), and finally rebuilt in the reign of Augustus by Tiberius and Drusus, A.D. 6 (Suet. *Tib.* 20; *V. Fast.* i. 705; Dio Cass. iv. 8, 27); the three existing Corinthian columns and piece of entablature, all very delicate and graceful in detail, and of the finest workmanship, in Pentic marble, belong to a still later restoration under Trajan or Hadrian. One point shows Roman timidity in the use of a lintel; the frieze is jointed so as to form a flat arch, quite needless, with the object of relieving the weight on the architrave. Its plan, hexastyle, with only eleven columns on the sides, is shown in fig. 8. It had a lofty podium, faced with marble and decorated with a heavy cornice and pilasters, one under each column. The podium is an interesting example of the enormous solidity of Roman buildings of the best period. Solid tufa walls, 8 ft. thick, are built under the whole of the cella and the front row of columns, while the columns of the sides rest on spurs of similar walling, projecting at right angles to that under the cella; the part immediately under the columns is of travertine, and the spurs are united and strengthened laterally by massive flat arches of travertine. Between the foundations of the columns were chambers used as offices, &c. With the exception of a small chamber under the steps, entered from the *Vicus Tuscus*, the entire podium is filled up by a solid mass of concrete, made of broken tufa, pozzolana and lime, the whole forming a lofty platform, about 22 ft. high, solid as a rock, on which the columns and upper structure are erected. The podium contains

"Forvm. Ivlivm. et basilicam. qvae. fvit. inter. aedem. Castoris. et. aedem. Saturni. coepta. profugataeque. opera. a. patre. meo. perfecti. et. eandem. basilicam. consvmpatm. incendio. ampliato. civis. solo. svb. titulo. nominis. filiorvm. inchoavi. et. si. vivvs. non. perfectissem. perfici. ab. haeredibus. [meis. ivssit]."¹² The *filii* here referred to are Augustus's grandsons, Gaius and Lucius, adopted by him in 17 B.C. (see Dio Cass. lvi. 27).

² Three medieval lime-kilns were found by Canina within this basilica, which accounts for the scantiness of the existing remains.

³ See *Notitia*, inscriptions, e.g. *Vices gaudes; pedes plangis*.

⁴ The whole building has unhappily been much falsified by needless restoration.

⁵ A drawing of this pedestal, which is now lost, with MS. note by Ligorio, exists in *Cod. Vat.* 3439, fol. 46.

⁶ The temple of Castor is shown on two fragments of the marble plan, and its position is also indicated by the passage in the *Mon. Anc.* quoted above (note 6).

⁷ See *Sac. Ann.* ii. 41, who says it was *propter aedem Saturni*.

⁸ See Suet. *Aug.* 29; Gerhard, *Bas. Giulia*, &c. (1823); and Visconti, *Escavazione della Bas. Giulia* (1872).

⁹ One side of this gate was built against one of the marble piers of the *Basilica Julia*, a perfect print of which still exists in the concrete of the gate, though the marble pier itself has disappeared.

¹⁰ The other side of the gate abutted against the marble-lined podium of the temple of Saturn.

¹¹ See *Sac. Ann.* ii. 41, who says it was *propter aedem Saturni*.

¹² See Suet. *Aug.* 29; Gerhard, *Bas. Giulia*, &c. (1823); and Visconti, *Escavazione della Bas. Giulia* (1872).

a few remains of the earliest temple, built of blocks of grey-green tufa. Two fragments of mosaic, with simple lozenge pattern in white marble and basalt, still exist in the cella of this temple. The level of the mosaic, which probably belongs to the rebuilding of Tiberius, lies considerably below that of the later floor, which seems to date from Hadrian's reign. It has all the characteristics of early mosaic—very small tesserae fitted with great accuracy, like the early mosaic in the Regia. The temple of Castor was often used as a meeting-place for the senate, and its lofty podium formed a tribunal for orations.¹ The Fons or Lacus Juturnae (see *Ov. Fast.* i. 705, and *Dionys.* vi. 13), at which the Dioscuri were fabled to have watered their horses, was beside their temple; the precinct was discovered in 1900-1. The Lacus itself, a basin 164 ft. square and 6½ ft. deep, is immediately opposite the three standing columns of the temple; in the centre is a base of *opus reticulatum*, which supported statues of the Dioscuri; an altar with reliefs, together with other sculptures, has been found close by, and a few yards off is a small chapel or *aedicula*, intended for a statue of Juturna, and in front of it a well-curio (*puteal*) of white marble, set up by the aedile M. Barbatius Pollio in the reign of Augustus.

Close to the temple of Castor, at the angle of the Forum, stood the arch of Augustus, set up in 20 B.C. to commemorate the recovery of the standards taken from Crassus by the Parthians. **Arch of Augustus.** Its foundations were discovered in 1888; it had three bays, and rested on the pavement of a street which before the time of Augustus bounded the Forum.

On the other side of the Sacra Via stand the remains of the temple of Divus Julius, erected by Augustus. Though little beyond its concrete core is left, its plan can be fairly well made out from the voids in the concrete, which show the position of the tufa foundations under the walls and columns (as in the temple of Castor). The temple itself, a hexastyle prostyle building, with close intercolumniation (*Vitr.* iii. 2), stood on a lofty podium with a curved recess in the front between two flights of stairs (see *Plate VIII.*). The base, which now fills up the recess, is a later addition. In 1898 the wall of a large altar was discovered in the niche, doubtless that mentioned by Appian (*Bell. Civ.* ii. 148). The podium, which projects in front of the temple itself, was adorned with beaks from the ships taken at Actium (*Dio Cass.* li. 19), and hence it was called the Rostra Julia, to distinguish it from the other rostra described above. Both were used for the funeral orations in honour of Augustus (*Suet. Aug.* 100; see also *Dio Cass.* liv. 35). Besides the concrete core and the curved tufa wall of the recess, little now exists except a small bit of the architrave of the cella floor, and some fragments of the cornice and pediment, of fine Greek marble. This temple is represented on coins of Augustus and Hadrian.

The temple of Vesta, founded according to tradition by Numā,² stands at the southern angle of the Forum on the ancient line of the Sacra Via (*Ov. Trist.* iii. 1, 28). No shrine in Rome was equal in sanctity to this little circular building, which contained the sacred fire and the relics on which the welfare and even the existence of Rome depended. The original building was destroyed in 390 B.C. by the Gauls; it was burnt again in 241 B.C., again in the great fire of Nero's reign, and then in the reign of Commodus; after this it was rebuilt by Severus, to whose age belong the fragments of columns, cornice and other architectural features now lying around the ruined podium. With the aid of coins³ and a relief preserved in the Uffizi at Florence⁴ it is possible to make a sufficiently accurate restoration of the temple.⁵ It consisted of a circular cella, surrounded by eighteen columns, with screens between them; the circular podium, about 10 ft. high, still exists, mainly of concrete with some foundations of tufa blocks, which may belong to the original structure. Recent excavations have disclosed a pit (*favissa*) in the middle of the podium, where the ashes of the sacred fire were temporarily stored. In the time of Pliny (*H.N.* xxiv. 7) the tholus or dome over the cella—symbolizing the canopy of heaven (*Ov. Fast.* vi. 276)—was covered with Syracusan bronze. Its position near the temple of Castor is mentioned by Martial (i. 71-73).⁶

The Regia, or office of the *pontifex maximus*, was on the Sacra Via, close by the temple of Vesta. It also was traditionally founded by Numā, and destroyed by the Gauls, and again burnt in 210 B.C. (*Liv.* xxvi. 27), when the temple of Vesta narrowly

escaped. Ovid (*Trist.* iii. 1, 28) describes this end of the Forum thus:—

“Haec est a sacris quae via nomen habet,
Hic locus est Vestae, qui Pallada servat et ignem,
Hic fuit antiqui Regia parva Numae.”

It was again damaged by fire in 148 B.C. and 36 B.C., after which it was rebuilt in marble by Cn. Domitius Calvus, and its outer walls inscribed with the lists of consuls and triumphs (*fasti consulares et triumphales*) of which many fragments have been recovered. Recent excavations have brought to light the tufa foundations of the republican building, including a round substructure, which may have supported the *sacrarium Maris*, in which were preserved the *ancilia* or sacred shields and spears (*Gell.* vi. 6), and an underground cistern, which has been brought into connexion with the shrine of Ops Consiva (*Varro. L.L.* vii. 21). The official residence of the *pontifex maximus* was not the Regia, but the *domus publica*; when Augustus succeeded to the office, he conveyed a part of his residence on the Palatine to the state in order to satisfy the claims of tradition, and presented the *domus publica* to the vestals.

The excavations of 1883-84 laid bare remains of this very interesting building, and showed that it was a large house extending close up to the Atrium Vestae; its orientation corresponded with that of the Regia. The existing remains are of several dates—first, walls of soft tufa, and partly of the earlier building; second, walls of hard tufa, of rather later date; and lastly, concrete walls faced with brick, decorated with painted stucco, and columns of travertine, also stuccoed and painted,⁷ with a large quantity of fine mosaic of that early sort which has very small tesserae put together with great accuracy. These valuable remains were preserved in spite of the erection of later buildings over them, because the levels of the later floors were higher than those of the Regia, and thus covered and protected the mosaics and lower parts of the walls and columns.

The Atrium Vestae, or house of the vestals, like the temple, was many times burnt and rebuilt; the existing building, which was excavated in 1883-84 and more completely in 1901, seems to have been built after the great fire of A.D. 64, and to **Atrium Vestae.** Flavian emperors, who added the colonnade; Hadrian, who built the tablinum and other rooms at the end; the Antonines, and Septimius Severus, who restored the whole after the fire of A.D. 192.⁸ It consists of a large atrium or quadrangle with columns of cipollino. At one end is the tablinum, with three small rooms on each side of it—two at the west end, and one at the east. The house, some offices, and some rooms lined with rich marble, extend along the south-west side. This extensive building is set against the side of the Palatine, which is cut away to admit the lower storey. Thus the level of the first upper floor is nearly the same as that of the Nova Via, on which it faces, about 23 ft. above the ground floor. The upper floor is in part well preserved; it contains a large suite of bath and other rooms, which were probably the sleeping apartments of the vestals. All the better rooms and the baths are lined with polished marbles, many of great beauty and rarity; the floors are mostly mosaic of tessellated work. The pavilion of the tablinum was a beautiful specimen of inlay in porphyry and marble. In many places alterations and clumsy patchings of the 4th and 5th centuries are apparent. A number of statues of the chief vestal, or *virgo vestalis maxima*, with inscribed pedestals, were found in the atrium, mostly of the 3rd century, though a few are earlier; these are of especial interest as illustrating the sacerdotal dress of the vestals.⁹ Nothing but the Nova Via separates the Atrium Vestae from the imperial palace (see *Plin. Ep.* vii. 19; *Aul. Gell.* i. 12), which extends over the site of the Lucus Vestae—“qui a Palatii radice in Novam Viam devexus est” (*Cic. De Div.* i. 45). A curious octagonal structure in the middle of the atrium looks very much like a border for flower-beds; and it is possible that this miniature garden was made by the vestals when the Lucus Vestae ceased to exist. By the main entrance from the Forum stood a small aedicula—a large pedestal, at the angles of which were columns supporting an entablature.¹⁰ It no doubt contained a statue of Vesta, there being none within the temple. It is of the time of Hadrian. Gratian confiscated the house and its ornaments of the vestals in A.D. 382, but the atrium continued to be partly inhabited for many centuries later by imperial or papal officials.¹¹ In September 1884 a road was

¹ On these see Delbrück, *Das Capitolium von Sigena* (1903), p. 22; *Der A. Palladius und dem Marsfelde* (1903), p. 14; van Buren in *Class. Rev.* xx. pp. 77 ff.

² The front of the podium was decorated with ships' beaks. One of the mad acts of Caligula was to make the temple of Castor into the vestibule of his palace by breaking a door through the back of the cella (*Suet. Cal.* 22).

³ Another legend attributes its founding to Romulus.

⁴ On the coins see Dressel, *Zeitschr. für Numismatik* (1899), 20 ff.

⁵ Lanciani, *L'Atro di Vesta* (1884), pl. xix.

⁶ See Huelsen, *The Roman Forum*, p. 109, fig. 108.

⁷ See Jordan, *Die Larae* (Berlin, 1865); and Auer in the *Denkschriften der Wiener Akademie* (1888), ii. 209 ff.

⁸ The columns were crimson, the travertine rain-water gutter bright blue, and the inner walls had simple designs in panels of leaf ornament and wreaths.

⁹ The account of the Atrium Vestae and its successive restorations is given in Miss E. B. Van Deman's *Atrium Vestae* (1909).

¹⁰ The most important of these have been removed to the Museo delle Terme.

¹¹ The front is inscribed SENATVS . POPVLVSQVE . ROMANVS . PECVNIA . PVBLICA . FACIENDAM . CVRANTI.

¹² In the excavations of December 1883 a pot was found in the north corner containing 830 silver pennies of English kings of the 9th and 10th centuries—Alfred the Great, Edward I., Athelstan, Edward I., and others. A list of these is given by Dr. Roscher in Lanciani's work, *L'Atro di Vesta* (Rome, 1884). None are later

discovered leading up past the tablinum end of the atrium from the Sacra Via to the Nova Via. In about the 4th century this road appears to have been blocked up at the Nova Via end by a building which adjoined the Atrium Vestae.

At the north-east corner of the Forum stood the arch of Q. Fabius Maximus, consul in 121 B.C., called Allobrogicus from his victory over the Allobroges (Schol. on Cic., *In Verr.*, *Actio* 1; *liv. Ep. lvi.*; *Plin. H.N.* vii. 166). It marked the extreme limit of the Forum in this direction (Cic. *Pro Plancio*, 7, 17), as the rostra did at the other end. Remains of this arch were dug up and most destroyed in 1546, near the temple of Faustina on one of the fragments then discovered was inscribed Q. FABIVS Q. F. MAXSVMS. AED. CVR. REST. (Dessau, *Inscr. Lat. Sel.* 430). About twenty-five other fragments were found in 1882.¹

The temple of Faustina the elder stands at the east angle of the Forum, facing the later line of the Sacra Via. It is prostyle hexastyle, and has monolithic columns of cipolino and a rich entablature of Greek marble, with graceful reliefs of griffins and candelabra on the frieze.² The walls are of massive peperino, once lined with marble. On the front is inscribed DIVO ANTONINO ET DVAE FAVSTINAE EX S. P. C. A. E. Temple built by Antoninus Pius in memory of his wife, who died in 141, was after his death dedicated [also to him, and the first line was then added (*Vita Ant. Pii*, 6). In the Middle Ages it was consecrated as the church of S. Lorenzo in Miranda, and a great part of its cella has been destroyed. The front is now excavated to the original level. This temple is shown on the reverse of several coins of Antoninus Pius; some have the legend DEDICATIO AEDIS.

The space between the north-west end of the Forum and the Tabularium is occupied by a range of important buildings (see *Temple of Plate VIII.*). The chief of these is the temple of Concord (see Festus, ed. Müller, p. 347) shown on a fragment of the marble plan, founded by Camillus in 308 B.C. (*Plut. Cam.* 42), and restored by Opimius after the death of C. Gracchus (121 B.C.). It was afterwards rebuilt by Tiberius out of the spoils gained in Germany; it was rededicated by Tiberius in A.D. 10 in his own name and that of his brother Drusus (who had died in B.C. 9) [*Suet. Tib.* 20; *Dio. Cass.* lv. 25]. It is shown with unusual minuteness on the reverse of a first brass of Tiberius. The existing remains³ are of the rebuilding by Tiberius, and show that it was unusual in plan, having a large cella much wider than its depth, and a very large projecting portico. Its construction is an interesting example of the combination of many different materials. The lower part of the walls was of massive tufa blocks, the upper part of the cella of travertine; and the inner low wall, which supported ranges of internal columns, was of mixed concrete, tufa and travertine. The whole was lined with marble, white outside, and rich oriental marbles inside (see fig. 4), which were also used for the pavement. The door-sill is made of enormous blocks of porta santa marble, in which a bronze caduceus (emblem of Mercury) was inlaid. Between the internal columns of the cella stood rows of statues; and the temple also contained a large collection of pictures, engraved gems, gold and silver plate, and other works of art, mostly the work of ancient Greek artists (see *Plin. H.N.* xxiv. 19, xxxv. 36, 40, xxxvi. 67, xxxvii. 2). On the apex of the pediment was a group of three figures embracing; the tympanum was filled with sculpture; and statues were set in the open porch. Though now only the podium and the lower part of the cella wall exist, with foundations of the great flight of steps, many rich fragments both of the Corinthian entablature and of the internal caps and bases are preserved in the Tabularium; and some of the marble lining is still *in situ*. The Einsiedeln MS. gives part of the inscription of the front—S. P. Q. R. AEDM. CONCORDIAE. VETVSTATE. COLLAPSAM. IN. MELIOREM. FACIEM. OPERE. ET. CVLTV. SPLENDIDIORE. RESTITVERVNT (*C.I.L.* vi. 89).⁴

than 946, and a bronze fibula inlaid with silver with the name of Pope Marcellus II. (942-46) makes it seem probable that this hoard was concealed during his pontificate.

¹ *Vat. degli Scavi* 1882, p. 275.

² This finely sculptured frieze is almost an exact copy of that on the temple of Apollo at Miletus.

³ The size of the earlier and smaller temple is indicated by the rough blocks on the face of the wall of the Tabularium, close against which the temple stands. When the Tabularium was built it was not thought worth while to dress to a smooth face that part of its wall which was concealed by the then existing temple of Concord.

⁴ Little is known of the Basilica Opimia, which probably adjoined the earlier temple of Concord, and the existing building appears also to have occupied the site of the Senaculum (see Festus, ed. Müller, p. 347), or various existing scenes which took place in the temple of Concord and on its steps, see Cic. *Phil.* vii. 8; Sallust, *Bell. Cat.* 49. Another temple of Concord, built in 216 B.C., stood on the Capitoline Arx (*Liv.* xxii. 33, xxiii. 21); and a bronze aedicular of Concord in the Area Vulcani, which must have been close by the great temple. This was dedicated by Cn. Flavius, 305 B.C. (see *Liv.* ix. 46); according to Pliny (*H.N.* xxxiii. 19) it stood "in

The temple of Vespasian stands close by that of Concord, abutting on the Tabularium in a similar way, and blocking up a doorway at the foot of a long flight of steps (see fig. 1). It consists of a nearly square cella with prostyle hexastyle portico of the Corinthian order; three of the columns are still standing, with their rich entablature, the frieze of which is sculptured with sacred instruments. The walls are of enormous blocks of travertine with strong iron clamps; the whole was lined with white Pentelic marble outside, and inside with coloured oriental marbles. There was an internal range of columns as in the temple of Concord. This temple was begun by Titus in A.D. 80, in honour of his father Vespasian, and finished by Domitian, who dedicated it to Vespasian and Titus. The inscription on the entablature, given in the Einsiedeln MS., records a restoration by Severus and Caracalla—DIVO VESPASIANO. AVGVSTO. S.P.Q.R. IMPP. CAESS. SEVERVS. ET. ANTONINVS. PIV. FELIC. AVGG. RESTITVERVNT; part of the last word only now exists.

In the narrow space between the temples of Concord and Vespasian (only about 7 ft. in width) a small brick and concrete edifice stands against the Tabularium. In it was found an inscribed base dedicated to Faustina the younger by one of the *viatores* (messengers) of the quaestor probably by the name of Giffius.

The next building is the Portico Deorum Consensium, a colonnade in two wings which join at the obtuse angle, with a row of small rooms or shrines partly cut into the tufa rock of the hill behind. This conjunction of twelve deities was of Etruscan origin; they were six of each sex and were called Senatus Deorum (Varro, *L.L.* viii. 70, and *De Re Rust.* i. 1).⁵ The columns are of cipolino with Corinthian caps; on the frieze is an inscription recording a restoration by Vettius Agorius Praetextatus, praefect of the city in A.D. 367. Under the marble platform is a row of seven small rooms, the brick facing of which is perhaps of the Flavian period.

The arch of Severus stands by the rostra, across the road on the north-east side of the Forum; the remains of the ancient travertine curb show that originally the road went along a rather different line, and was probably altered to make room for this great arch, which was accessible only by steps, and was not used for ordinary traffic. It was built in A.D. 203, after victories in Parthia, and was originally set up in honour of Severus and his two sons M. Aurelius Antoninus (Caracalla) and Geta. Caracalla, after murdering Geta, erased his name from all monuments to his honour in Rome. Representations of the arch on coins of Severus show that its attic was surmounted by a chariot of Victory, drawn by six horses, with a seated figure crowned by Victory; at the sides were statues of Caracalla and Geta, with an equestrian statue at each angle. The arch, except the base, which is of marble-lined travertine, is built of massive blocks of Pentelic marble, and has large crowded reliefs of victories in the East, showing much decadence from the best period of Roman art.

The central space of the Forum is paved with slabs of travertine, much patched at various dates; it appears to have been marked out into compartments with incised lines (see Plate VIII.), the use of which is not known. There are also square holes which probably held masts on which awnings could be spread. Numerous clasp-holes all over the paving show where statues and other ornaments once stood. The recorded number of these is very great, and they must once have thickly crowded a great part of the central area. Two short marble walls or plutei covered with reliefs, discovered in 1872, stand on the north side. The rough travertine plinth on which they have been set is evidently of late date. Each of these marble screens has (on the inside) reliefs of a fat bull, boar and ram, decked out with sacrificial wreaths and vittae—the *suovetaurilia*. On the outside are scenes in the life of Trajan; in both cases the emperor is speaking from the rostra.

On one we also see him seated on a *suggestus* instituting a charity for destitute children in A.D. 101, and seen similar to one shown on one of his first brasses with the legend ALIM[ENT]A ITALIAE;⁶ at the other end the emperor stands on the rostra, on which the two tiers of beaks are shown; he is addressing a crowd of citizens. In the background is shown the long line of arches of the Basilica Julia, with (on the left) what is probably the temple of Castor and the arch of Augustus. On the right are the statue of Marsyas and the sacred fig-tree.⁷ On the other slab a crowd of officials are bringing tablets and piling them in a heap to be burnt. This records the remission by Trajan of some arrears of debt due to the imperial treasury (Auson. *Grat. Act.* 32). The background here represents again the Basilica Julia, with (on the right) the Ionic temple of Saturn and the Corinthian temple of Vespasian. Between them is an arch, which may be that of Tiberius.⁸ On the left the

Græcostasi, quae tunc supra Comitium erat." Both these were probably only small shrines.

⁵ Twelve gift statues are mentioned by Varro.

⁶ Cohen, vol. ii. 393-5.

⁷ This is not the *figus ruminalis* in the Comitium, but another mentioned by Pliny (*H.N.* xv. 20) in the middle of the Forum.

⁸ As it seems to be on a higher level, it may indicate the Tabularium.

Temple of Vespasian.

Portico Deorum Consensium.

Arch of Severus.

Central space of Forum.

fig-tree and the statue of Marsyas are repeated. Other explanations of these reliefs have been given, but the above appears the most probable. Towards the other end of the Forum are remains of a large concrete pedestal. It may possibly have supported an equestrian statue of Constantine, which was still standing in the 8th century. A smaller foundation, laid bare by Comm. Boni's excavations in 1907, is thought by him to have supported the equestrian statue of Q. Marcus Tremulus, the conqueror of the Herculii, set up before the temple of Castor in B.C. 305 (Liv. ix. 43).

The seven cubical brick and concrete structures, once faced with marble, which line the Sacra Via are not earlier than the time of Diocletian. They are probably the pedestals of honorary columns such as those shown in the relief on Constantine's arch, mentioned above. The column erected in honour of the tyrant Phocas by Smaragdus in the eighth year of his reign (608) is still standing. It is a fine marble Corinthian column, stolen from some earlier building; it stands on rude steps of marble and tufa. The name of Phocas is erased from the inscription; and the date shows that this monument was to his honour. In the 4th century, or perhaps even later, a long brick and concrete building faced with marble was built along the whole south-east end of the Forum, probably a row of shops. They were destroyed by Comm. Rosa's order. Two columns—one of pavonazzetto, the other of grey granite—were set up on two of the shops. In 1902 a network of passages (*cuniculi*) was discovered about 3 ft. beneath the pavement of the Forum. These have tufa walls and concrete vaults; they are about 8 ft. high and 5 ft. broad. At the intersections of the passages are square chambers, in the centre of which are travertine blocks with sockets for windlasses. The construction of the passages seems to date from the time of Julius Caesar, and it is thought that they were used for scenic purposes when games were given in the Forum.

In 1903 a large concrete foundation was found, partly blocking the E. end of one of the *cuniculi*. There can be no doubt that this once supported the colossal equestrian statue of Domitian described by Statius (Silv. i. 1, 21 ff.) which was destroyed after his murder. Embedded in the concrete was a cist of massive travertine blocks which was found to contain five archaic vases similar to those from the early necropolis (above, as *mit.*). One held a nugget of quartz containing pure gold. It is uncertain whether these were buried here for ritual purposes or were the contents of an early tomb found in digging the foundations. Near this monument there were found in 1904 remains of an enclosure of irregular shape which once contained an altar. This must have been the altar which in imperial times represented the Lacus Curtius (Ov. *Fast.* vi. 403). Beside this were found some remains of a structure of imperial date which Comm. Boni identified with the Tribunal at which justice was administered by the emperors.¹

Palatine Hill or Palatium.

In addition to the early walls described above, only a few remains now exist earlier in date than the later years of the republic; these are mostly grouped near the Scalae Caci (see fig. 10, in Plan), and consist of small cellae and other structures of unknown use.² They are partly built of the soft tufa used in the "wall of Romulus," and partly of hard granulated tufa so called. Various names, such as the "hut of Faustulus" and the "Auguratorium," have been given to these very ancient remains, but with little reason. On thing is certain, that the buildings were respected and preserved even under the empire, and were probably regarded as sacred relics of the earliest times.

¹ Authorities on the Forum; For the earlier literature of the subject it will suffice to refer to Jordan, *Topographie der Stadt Rom*, i. 2, 195-429, and, in English, to Nichols, *The Roman Forum* (1877). By far the best account based on the recent discoveries of Comm. Boni is Huelsen, *The Roman Forum* (Eng. trans. from the 2nd German edition by E. Baster, 1906), in which full references are given. The official reports on excavations by Comm. Boni appear at intervals in the *Notizie degli Scavi*, and are largely concerned with the ancient necropolis. Huelsen publishes reports in the *Römische Mitteilungen* which are of great value.

² Our knowledge of these remains has been considerably increased by excavations in this region begun in 1907, which form the subject of a series of reports in the *Notizie degli Scavi*; their significance is discussed by Pinza in the *Annali della Società degli Ingegneri ed Architetti Italiani* for that year, at p. 23, and in *Classical Quarterly Review*, p. 145 ff. It is almost too much to hope that the difficult problems raised by these discoveries will ever be solved; meanwhile it may be noted (i) that abundant traces of a primitive settlement (pottery, foundations of huts, &c.) have come to light near the W. angle of the hill; (ii) that walls of various epochs have been found which may have belonged to a system of fortification, though this cannot be demonstrated; (iii) that beneath a piece of walling built with regularly laid tufa blocks was found an inhumation-grave containing pottery of the 4th century B.C.

Remains of more than one temple of the republican period exist near this west angle of the Palatine. The larger of these (see Plan) has been called conjecturally the temple of Jupiter Victor (Liv. x. 29; Ov. *Fast.* iv. 621).³ It stands on a levelled platform of tufa rock, the lower part of which is excavated into quarry chambers, used in later times as water reservoirs. Two ancient well-shafts lined with tufa communicate with these subterranean hollows. Extensive foundations of hard tufa exist in the valley afterwards covered by the Flavian palace (see Plan, "Foundations of the Domus Augustana"). The masonry is in parts of republican date, and was used to support the Flavian palace. Not far from the top of the Scalae Caci are the massive remains of a large cella, nothing of which now exists except the concrete core faced with *opus incertum* in alternate layers of tufa and peperino. It was probably once lined with marble. By it a noble colossal seated figure of a goddess was found, in a block of Greek marble, well modelled, a work of the 1st century A.D. The head and arms are missing, but the figure is probably rightly called a statue of Cybele; and inscriptions dedicated to Magna Mater have been found close to the temple. Augustus in the *Monumentum Ancyranum* (4, 8) records AEMER. MATRIS. MAGNAE. IN. PALATIO. FÆCI; and there can be little doubt that this is the temple in question. Some interesting early architectural fragments near this temple; they consist of drums and capitals of Corinthian columns, and the cornice of the pediment, cut in peperino, and thickly coated with hard white stucco to imitate marble. Between this and the temple of Jupiter Victor are extensive remains of a large porticus, with tufa walls and travertine piers, also republican in date. The use and name of this building are unknown.

Remains of extensive lines of buildings in early *opus reticulatum* exist on the upper slopes of the Palatine, all along the Velabrum side, and on the south-west side as far as the so-called Paedagogium. These buildings are constructed on the ruins of the wall of Romulus, a great part of which has been cut away to make room for them; their base is at the foot of the ancient wall, on the shelf cut midway in the side of the hill; their top reached originally above the upper level of the summit. They are of various dates, and cannot be identified with any known buildings. Part is apparently of the time of the emperor Tiberius, and no doubt belongs to the Domus Tiberiana mentioned by Suetonius (*Tib.* 5; Tac. *Hist.* iii. 31). This palace covered a great part of the west corner of the hill. Of about the same date is a very interesting and well-preserved private house built wholly of *opus reticulatum*, which formed part of the imperial property, and was respected when the later palaces were built. The discovery of lead-pipes bearing the inscription IULIAE. AVG. (C.I.L. xv. 7264) has led to the conjecture that the house was that bequeathed to Livia by her first husband, Tib. Claudius Nero. At the north-west end is a small atrium, out of which open three rooms commonly called the *tablinae*, as well as a *triclinium* all decorated with good paintings of mythological and domestic scenes, probably the work of Greek artists, as inscriptions in Greek occur, e.g. ΕΡΜΗC, under the figure of Hermes, in a picture representing his deliverance of Io from Argus.⁴ This suite of rooms was a later addition to the house. The south-east portion was three storeys high, and is divided into a great number of very small rooms, mostly bedrooms. The house is built in a sort of hole against the side of an elevation, so that the upper floor seems to level with an ancient paved road. The dampness caused by this is counteracted and kept off by the paintings by means of flange-tiles over the external walls, under the stucco, thus forming an air-cavity all over the surface. From the back of the house, at the upper level, a long subterranean passage leads towards the Flavian palace, and then, turning at right angles and passing by the foundations of the so-called temple of Jupiter Victor, issues in the ancient tufa building mentioned above. Another crypto-porticus starts near this house and communicates with the long semi-subterranean passage by which the palaces of Calpurnia and Domitian are connected. It is ornamented with very beautiful stucco reliefs of cupids, beasts and foliage, once painted and gilt. Some hold that the house was that of Germanicus, into which the soldiers who killed Calpurnia in the long crypto-porticus escaped, as described by Josephus (*Ant. Jud.* xix. 1; see also Suet. *Cal.* 58).

From the Summa Sacra Via a road led to the Area Palatina in the centre of the hill. Here was the sanctuary called *Roma quadrata*, containing the *mundus*, a pit in which the instruments used in the founding of the city were deposited. To the east was the Area Apollinis, the entrance of which led through lofty propylaea into a very extensive peristyle or porticus, with columns of Numidian giallo; the temple was of white Luna marble. In the centre of this enclosure stood the great octostyle peripheral temple of Apollo Palatinus. The splendour of its architecture and the countless works of art in gold,

³ It has recently been argued by Pinza that this is the temple of Apollo built by Augustus.

⁴ See *Mon. Inst.* xi. pler. xxii.; Mau, *Geschichte der Wandmalerei*, pl. xi. pler. Les Peintures du Palatin (Paris, 1870).

silver, ivory, bronze and marble, mostly the production of the best Greek artists, which adorned this magnificent group of buildings, must have made it the chief glory of this splendid city. This temple was begun by Augustus in 36 B.C.,¹ after his Sicilian victory over Sextus Pompeius, and dedicated on the 9th of October 28 B.C.² A glowing account of the splendours of these buildings is given by Propertius (ii. 2, iii. 31). Inside the cella were statues of Apollo between Latona and Diana by Scopas, Cephisodotus and Timotheus respectively (Plin. *H.N.* xxvii. 24, 25, 32); beneath the base of the group were preserved the Sibylline books. The pediment had sculpture by Bupalus and Archemorus of Chios (Plin. *H.N.* xxvii. 13), and on the apex was Apollo in a quadriga of gilt bronze.³ The double door was covered with ivory reliefs of the death of the Niobids and the defeat of the Gauls at Delphi. The Ancyran inscription records that Augustus melted down eighty silver statues of himself and of the money "donating" gifts "to this temple, dedicating them both in his own name and in the names of the original donors of the statues."⁴ The Sibylline books were preserved under the statue of Apollo (Suet. *Aug.* 31); and within the cella were vases, tripods and statues of gold and silver, with a collection of engraved gems dedicated by Marcellus (see Plin. *H.N.* xxvii. 11, xxviii. 14). In the porticus was a large library, with separate departments for Latin and Greek literature,⁵ and a large hall where the senate occasionally met (Tac. *Ann.* i. 37). Round the porticus, which still remains, are the marble columns and statues of the fifty Danaids, and opposite them their fifty bridegrooms on horseback (see Schol. on Pers. ii. 56). In the centre, before the steps of the temple, stood an altar surrounded by four oxen, the work of Myron (Prop. iii. 31, 5). In the centre of the Palatine stood the palace of Augustus, built in the years following 36 B.C., and renewed after a fire in A.D. 3. It contained a small temple of Vesta (*C.I.L.* i. p. 317), dedicated on the 28th of April 12 B.C., when Augustus was elected *pontifex maximus*. Augustus's building was completely transformed by later emperors, but the name *domus Augustiana* was retained in official use. The Area Apollinis and its group of buildings suffered in the fire of Nero, and were restored by Domitian. The whole was finally destroyed in the great fire of 363 (Ammian. xxiii. 3, 3), but the Sibylline books were saved.

To the north-west of the Area Palatina stood the *Domus Tiberiana*, a palace built by Tiberius on substructures of concrete which crown the north-western slope of the hill and form a platform now occupied by the Farnese gardens, overlooking the Clivus Victoriae. Caligula is said to have added to this palace on the side towards the Forum, making the temple of Castor into a vestibule, and to have connected it with the Capitol by a bridge whose piers were found by the temple of Augustus and the Basilica Julia; but this was destroyed after his death. At a later time the palace was extended so as to include the northern angle of the Palatine, which had once been covered with private houses. Among these were the dwelling of Q. Lutatius Catulus, Q. Hortensius Scaurus, Crassus (Plin. *H.N.* xxvii. 3, 24), whose house was afterwards bought by Cicero.⁶ Many other wealthy Romans had houses on this part of the Palatine. The part now existing is little more than the gigantic substructure built to raise the principal rooms to the level of the top of the hill. The lowest parts of these face the Nova Via, opposite the Atrium Vestae, and many storeys of small vaulted rooms in mixed brick and *opus reticulatum* rise one above the other to the top of the hill. The palace extends over the Clivus Victoriae supported on lofty arches so as to leave the road unblocked; many travertine or marble stairs lead to the upper rooms, some starting from the Nova Via, others from the Clivus Victoriae. A large proportion of these substructures consist of dark rooms, some with no means of lighting, others with scanty borrowed light. Many small rooms and stairs scarcely 2 ft. wide can only have been used by slaves. The ground floors on the Nova Via and the Clivus Victoriae appear to have been shops, judging from their wide openings, with travertine linings, grooves for the wooden floors with narrow doors, which Roman shops seem always to have had—very like those now used in the East. The upper and principal rooms were once richly decorated with marble linings, columns and mosaics; but little of these now remains. The upper part of the palace, that above the Clivus Victoriae, is faced wholly with brickwork, no *opus reticulatum* being used as in the lower portions by the Nova Via. This marks a difference of date, and this is confirmed by the occurrence of brick stamps of the 2nd century A.D.

¹ *TEMPLVM A.POLLINIS. IN. SOLO. MAGNAM. PARTEM. EMPTO. FECI* (*Mon. Anc.* 4, 1).

² See Dio Cass. xlix. 15, linc. 1, and *C.I.L.* i. p. 331.

³ See also Suet. *Aug.* 52 where Augustus is rather different.

⁴ Schol. to *Iuv.* i. 128 and Suet. *Aug.* 29.

⁵ *Cic. Pro Domo.* 43; Val. Max. vi. 3, 1; and see Becker, *Handb.* i. p. 423.

⁶ At this point the Palatine is cut away into four stages like gigantic steps; the lowest is the floor of the Atrium Vestae, the second the Nova Via, the third the Clivus Victoriae, and the top of the hill forms the fourth.

The next great addition to the buildings of the Palatine was the magnificent suite of state apartments built by Domitian, over a deep natural valley running across the hill (see Plan). The valley was filled up and the level of the new palace raised to a considerable height above the natural soil.

Remains of a house, decorated with painting and rich marbles, exist under Domitian's peristyle, partly destroyed by the operations of cast concrete which cut right through it. The floor of this house shows the original level, far below that of the Flavian palace. This building is connected with the palace of Caligula by a branch subterranean passage leading into the earlier crypto-porcius. It consists of a block of state-rooms, in the centre of which is a large open peristyle, with columns of oriental marble, at one end of which is the grand triclinium with magnificent paving of *opus sectile* in red and green basalt and coloured marbles, a piece of which still preserved; next to the triclinium, on to which opens with large windows, is a nymphaeum or room with marble-lined fountain and recesses for plants and statues. On the opposite side of the peristyle is a large throne-room, the walls of which were adorned with rows of pavonazetto and giallo columns and large marble niches, in which were colossal statues of porphyry and basalt; at one side of this is the basilica, with central nave and apse and narrow aisles, over which were galleries. The apse, in which was the emperor's throne, is paved with open marble, and is a part of which still remains. It is of great interest in showing the use of the Christian basilica (see BASILICA). On the other side of the throne-room is the lararium, with altar and pedestal for a statue; next to this is the grand staircase, which led to the upper rooms, now destroyed. The whole building, both floor and walls, was covered with the richest oriental marbles. Outside were colonnades or porticus,—on one side of cipollino, on the other of travertine, the latter successively and painted. The magnificence of the whole, covered with fine Greek sculpture and gilded with polished marbles of the most brilliant colours, is difficult now to realize; a glowing description is given by Statius (*Silv.* iv. 11, 13; see also Plut. *Poplic.* 15, and Mart. viii. 36). Doors were arranged in the throne-room and basilica so that the emperor could slip out unobserved and reach by a staircase (g on Plan) the crypto-porcius which communicates with Caligula's palace. The vault of this passage was covered with mosaic of mixed marble and glass, a few fragments of which still remain; its walls were lined with rich marble; it was lighted by a series of windows in the spring of the vault. This, as well as the Flavian palace, appears to have suffered more than once from fire, and in many places important restorations of the time of Severus, and some as late as the 4th century, are evident. In 1720-28 extensive excavations were made here for the Farnese duke of Parma, and an immense quantity of statues and marble architectural fragments were discovered, many of which are now at Naples and elsewhere. Among them were sixteen beautiful fluted columns of pavonazetto and giallo, and a large quantity of Pentelic marble, now used for the high altar of the Pantheon; these all came from the throne-room. The excavations were carried on by Bianchini, who published a book on the subject.⁷

In the middle of the slopes of the Palatine, towards the Circus Maximus, are considerable remains of buildings set against the early wall and covering one of its projecting spurs, consisting of a series of rooms with a long Corinthian colonnade. The rooms were partly marble-lined and partly decorated with painted stucco, on which are inscribed a number of interesting inscriptions and rude drawings. Here, in 1856, was found the celebrated caricature of the Crucified Christ, now in the Museo Kircheriano.⁸ The inscription *CORINTHVS. EXIT. DE. PEDAGOGIO* suggests that this building was at one time used as a school, perhaps for the imperial slaves.⁹ A number of soldiers' names also occur, e.g. *HILARVS. MI. V. D. N.* (*Hilarus miles vestitur domini nostri*); some are in mixed Latin and Greek characters. At one pair of names is inscribed *PEREG.*, showing that they belonged to the troops called *frumentarii* stationed in the Castra Peregrinorum on the Caelian. Most of these inscriptions appear to be as early as the 1st century A.D.¹⁰ These interesting graffiti have in great part perished during the last few years. Some inscriptions found in the larger rooms seem to indicate that the imperial wardrobe found a place in them.

To the south of the Flavian state-rooms, on the side of the hill overlooking the Circus, was a building with a central peristyle ("Palace of Domitian" on Plan), which was excavated in 1775 and

Domus Octaviae.

⁷ The brick stamps on the tiles laid under the marble paving of the basilica have *CN. DOMITI. AMANDI. VALEAT. QVI. FECTI*—the last three words a common augury of good luck stamped in (1798) or amphora.

⁸ *Pal. dei Cesari* (Verona, 1738); see Guattani, *Not. di Antich.* (1798).

⁹ See Kraus, *Das Spättrüchfeld vom Palatin* (Freiburg, 1872), and Becker, *Das Spättrüchfeld*, &c. (Breslau, 1866).

¹⁰ The *paedagogium* was, however, on the Caelian. Huelsen suggests that it is here used as a slang term for a prison.

¹¹ See Henzen, in the *Bull. Inst.*, 1863, p. 72, and 1867, p. 113.

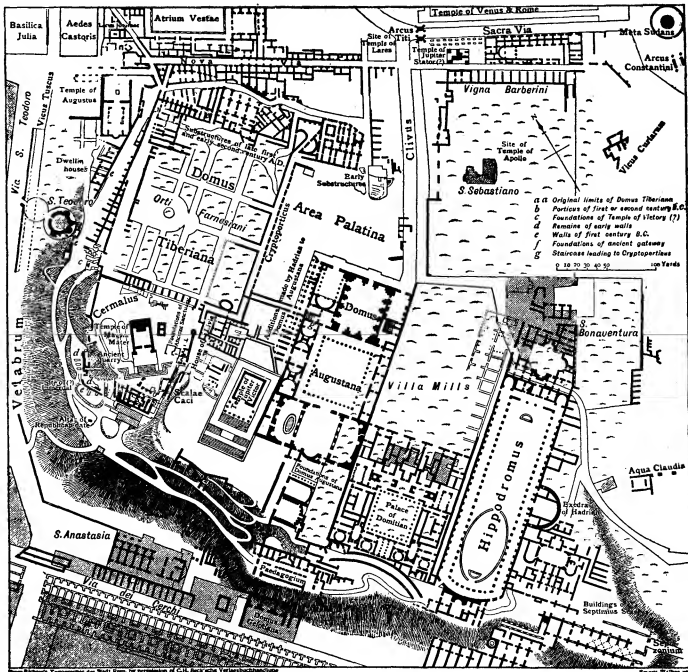

FIG. 10.—Plan of the Palatine.

again partly laid bare in 1869 and the following years. This has often, but wrongly, been called the palace of Augustus; we should rather see in it the dwelling-rooms of the Flavian palace. Adjoining it is the so-called stadium of the Palatine ("Hippodromus" on Plan), begun by Domitian, enlarged by Hadrian, and much altered or restored by Severus. The greater part of the outer walls and the large exedra or apse at the side, with upper floor for the emperor's seat, are of the time of Hadrian, as is shown by the brick stamps, and the character of the brick facing, which much resembles that of the Flavian time (bricks $\frac{1}{2}$ in. and joints $\frac{1}{2}$ in. thick).¹ The stadium is surrounded with a colonnade of engaged shafts, forming a sort of aisle with gallery over it. Except those at the curved end, which are of Hadrian's time, these piers are of the time of Severus, as are also all the flat piers along the outer wall,—one opposite each of those in the inner line. Severus restored the galleries after the great fire of A.D. 191. This building was the *hippodromus Palatii*; the word here means, not a racecourse, but a garden (Plin. *Epp.* 5, 6, 19). In addition to the stadium, Hadrian built a number of very

handsome rooms, forming a palace on the south-east side and at the south-west end of the stadium. These rooms were partly destroyed and partly hidden by the later palace of Severus, the foundations of which in many places cut through and render useless the highly decorated rooms of Hadrian. The finest of these which is now visible is a room with a large window opening into the stadium near the south angle; it has intersecting barrel vaults, with deep coffers, richly ornamented in stucco. The oval structure shown in the plan (fig. 10), with other still later additions, belongs to the 6th century; in its walls, of *opus mixtum*, are found brick stamps of the reign of Theodoric, c. 500.

The palace of Septimius Severus was very extensive and of enormous height; it extends not only all over the south angle of the Palatine but also a long way into the valley of the Circus Maximus and towards the Coelian. This part (like Calpurnia's palace) is carried on very lofty arched sub-structures, so as to form a level, uniform with the top of the hill, on which the grand apartments stood. The whole height from the base of the Palatine to several storeys above its summit must have been enormous. Little now remains of the highest storeys, except part of a grand staircase which led to them. Extensive baths, originally decorated with marble linings and mosaics in glass and

¹In parts of the outer wall brick stamps of the Flavian period appear, e.g. FLAVI. AVG. L. CLONI.—[A brick] of Flavius Clonus, freedman of Augustus' (C.I.L. xv. 1149).

marble, cover a great part of the top of the hill. These and other parts of the Palatine were supplied with water by an aqueduct built by Nero in continuation of the Claudian aqueduct, some arches of which still exist on the slope of the Palatine ("Aqua Claudia" on Plan) (see Spart. *Sept. Sev. 24*). One of the main roads up to the Palatine passes under the arched substructures of Severus, and near this, at the foot of the hill, at the south angle, Septimius Severus built an outlying part of his palace, a building of great splendour called the *Septizonium*,¹ or House of the Seven Planets. Part of the Septizonium existed as late as the reign of Sixtus V. (1585-90), who destroyed it in order to use its marble decorations and columns in the new basilica of St Peter; drawings of it are given by Du Pérac, *Vestigi di Roma* (1575), pl. 13, and in other works of that century.²

The name *Palatinum* seems to have originally denoted the southern height of the Palatine hill, while the summit overlooking the Velabrum was called *Cermalus*, and the saddle connecting the *Velia* and *Cermalus*, and the Equiline on which the temple of Venus was built, and Rome and the arch of Titus now stand bore the name *Velia*.³ It is evident that this was once higher than it is now; a great part of it was cut away when the level platform for the temple of Venus and Rome was formed. The foundations of part of Nero's palace along the road between this temple and the Equiline are exposed for about 20 to 30 ft. in height, showing a corresponding lowering of the level here, and the bare tufa rock, cut to a flat surface, is visible on the site of Hadrian's great temple; that the *Velia* and once a great deity is also indicated by the story of the removal of Valerius Publicola's dwelling.⁴

The arch of Titus, erected in memory of that emperor's subjugation of the Jews, but not completed until after his death, stands at the point where the *Sacra Via* crosses the *Velia*; it is possible that it once stood farther to the east and was removed to its present position when the temple of Venus and Rome was built. The well-known reliefs of the archway depict the Jewish triumph and the spoils of the Temple. In the middle ages the arch was converted into a fortress by the Frangipani; their additions were removed and the arch restored in its present shape in 1821.

On the *Velia* and the adjoining *Summa Sacra Via* were the temples of the Lares and Penates which Augustus rebuilt.⁵ The "*Aedes Larum*" is probably distinct from the "*Sacellum Larum*" mentioned by Tacitus (*Ann. xii. 24*) as one of the points in the line of the original pomerium. The temple of Jupiter Stator, traditionally vowed by Romulus during his repulse by the Sabines (Liv. i. 12), stood near the Porta Mugonia, and therefore on the slope leading up to the Palatine *Sacra Via*.⁶ To the south-east of the arch of Titus (see Plan) are the remains of a concrete podium which may have belonged to this temple in its latest form; and Comm. Boni discovered (in 1907) some early tufa walling close to the above-named arch in which he recognized the foundations of the early temple. Augustus rebuilt the temple of Victory, which gave its name to the *Clivus Victoriae*; this temple stood on the site of a prehistoric altar (Dionys. i. 32), and was more than once rebuilt,—e.g. by L. Postumius, 294 B.C. (Liv. x. 33). In 193 B.C. an aedicula to Victory was built near it by M. Porcius Cato (Liv. xxxv. 9). Remains of the temple and a dedicatory inscription were found in 1728⁷ not far from the church of S. Teodoro; the temple was of Parian marble, with Corinthian columns of Numidian giallo antico. The *Sacra Via* started at the *Sacellum Streniae*, an unknown point on the Equiline, probably in the valley of the Colosseum (Varro, *L.L. v. 47*), in the quarter called *Cerelia*. Thence it probably (in later times) passed round part of the Colosseum to the slope leading up to the temple of Titus on the *Velia*; this piece of its line is lined on one side by remains of private houses, and farther back, against the cliff of the Palatine, are the substructures of the *Area Apollinis*. From the arch of Titus or *Summa Sacra Via* the original line of the road has been altered, probably when the temple of Venus and Rome was built by Hadrian. Its later course passed at a sharp angle from the arch

of Titus to the front of Constantine's basilica, and on past the temple of Faustina. It is uncertain whether the continuation of this road to the arch of Severus was in later times called the *Sacra Via* or whether it rejoined its old line along the *Basilica Julia* by the cross-road in front of the *Aedes Julia*. Its original line past the temple of *Vesta* was completely built over in the 3rd and 4th centuries, and clumsily fitted pavements of marble and travertine occupy the place of the old basalt blocks.⁸ The course of the *Nova Via*⁹ (see Plan) along the north-east slope of the Palatine¹⁰ was exposed in 1882-84. According to Varro (*L.L. vi. 59*) it was a very old road. It led up from the *Velabrum*, probably winding along the slope of the Palatine, round the north angle above the church of S. Maria Antiqua. The rest of its course, gently ascending towards the arch of Titus, is now exposed, as are also the stairs which connected it with the *Clivus Victoriae* at the northern angle of the Palatine; a continuation of these stairs led down to the Forum.¹¹

The extent of the once marshy *Velabrum* (Gr. *ἕδος*) is not known, though part of its site is indicated by the *fidon* of S. Giorgio in Velabro; Varro (*L.L. vi. 24*) says, "extra urbem antiquam *Velabrum*, non longe a porta Romanula." It was a district full of tussocks (Plaut. *Capt. 489*; Hor. *Sat. ii. 3, 30*). The *Vicus Sospus* on its course from the Forum to the Circus skirted the *Velabrum* (Dionys. v. 26), from which the goldsmiths' arch was an entrance into the Forum Boarium.

From the S.W. end of the *Velabrum* the *Clivus Victoriae* rose in a gradual ascent along the slope of the Palatine and ultimately wound round the northern angle.

Capitoline Hill¹²

The Capitoline hill, once called *Mons Saturnius* (Varro, *L.L. v. 42*), consists of two peaks, the *Capitolium* and the *Arx*,¹³ with an intermediate valley (*Asylum*). The older name of the *Capitolium* was *Mons Tarpeius* (Varro, *L.L. v. 41*). Livy (i. 10) mentions the founding of a shrine to Jupiter Feretrius on the *Capitolium* by Romulus;¹⁴ this summit was afterwards occupied by the great triple temple dedicated to Jupiter, Juno and Minerva, a triad of deities worshipped under the *Capitolium* names of *Tinia*, *Thalna* and *Menerva* in every Etruscan city. This great temple was (Liv. i. 38, 53) founded by Tarquin I., built by his son Tarquin II., and dedicated by M. Horatius Pulvillus, consul suffectus in 509 B.C.¹⁵ It was built in the Etruscan style, of peperino stuccoed and painted (Vitruv. iii. 3), with wooden architraves, wide intercolumniations and painted terra-cotta statues.¹⁶ It was rebuilt many times; the original temple lasted till it was burnt in 83 B.C.; it was then refounded in marble by Sulla, with Corinthian columns stolen from the temple of Olympian Zeus in Athens (Plin. xxvi. 4, 5), and was completed and dedicated by Q. Lutatius Catulus, whose name appeared on the front. Augustus, although he restored it at great expense (*Mon. Anc. 4, 9*), did not introduce his name by the side of that of Catulus. It was again burnt by the Vitellian rioters in A.D. 70, and rebuilt by Vespasian in 71.¹⁷ Lastly, it was burnt in the three days' fire of Titus's reign¹⁸ and rebuilt with columns of Pentelic marble by Domitian; the gilding alone of this last rebuilding is said to have cost 2½ millions sterling (Plut. *Publ. 15*). Extensive substructures of tufa have been exposed on the eastern peak; in 1875 a fragment of a fluted column was found, of such great size that it could only have belonged to the temple of Jupiter; and a few other architectural fragments have been discovered at different times. The western limit of the temple was determined in 1865, its eastern limit in 1875, and the S.E. angle in 1896.

¹ See Jordan, *Topographie der Stadt Rom*, i. 2. 274-91.

² See Solinus (i. 24) and Varro (ap. Geil. xvi. 17), who mention its two ends, *summa* and *infima* (cf. Liv. v. 32).

³ See *Not. d. Scavi* (1882), p. 234. Original level laid bare, 1904.

⁴ See marble plan on Plate VII. and cf. *Var. Fast.* vi. 395.

⁵ See Rodocanachi, *Le Capitole romain* (1903; Eng. trans., 1906).

⁶ The first-named was the southern, the second the northern summit.

⁷ This is the earliest temple mentioned in Roman history. It was rebuilt by Augustus (*Mon. Anc. 4, 5*).

⁸ See Plut. *Publ. 14*; *C.I.L.* i. p. 487; Liv. ii. 8. Dionys. v. 35 wrongly gives 507 B.C.

⁹ Plin. xviii. 157; see *Cat. Hist.* iii. 72; *Val. Max.* v. 10.

¹⁰ Suet. *Vit.* 15; and *Vesp.* 8; cf. *Cat. Hist.* iv. 53, and Dio

¹¹ Suet. *Dom.* 5; Dio Cass. lxxvi. 24.

¹ The form *Septizonium* is also found.

² See Jordan, *Das Septizonium des Septimius Severus* (Berlin, 1886); Maass, *Die Tagesgötter in Rom und den Provinzen* (Berlin, 1902).

³ Huic (Palatio) Germalum et Velias conjunxerunt . . . Germalum a germanis Romulo et Neron, quod ad ficum Ruminalem hinc invenit (Varro, *L.L. v. 54*).

⁴ Liv. ii. 7; Cic. *Rep.* ii. 2; see Ascon. *Ad Cic.* in *Pis.* 52.

⁵ AEDM. LARVM. IN. SVMMA. SACRA. VIA. AEDM. DEVM. PENATVM. IN. VELIA. . . FECI (*Mon. Anc.*).

⁶ Dionys. ii. 50; see also Plut. *Cic.* 16; *Var. Fast.* vi. 793, and *Trist.* iii. i. 131. Near this temple, and also near the Porta Mugonia, was the house of Tarquinius Priscus (Liv. i. 41; Solin. i. 24). Owing to the strength of its position this temple was more than once selected during troubled times as a safe meeting-place for the Senate; it was here, as being a "locus munissimus," that Cicero delivered his *First Catilinian Oration* (see *Cic. In Cat.* i. 1).

⁷ See Bianchini, *Pal. dei Cesari* (1735), p. 236, pl. viii.

It appears that the figures given by Dionysius (iv. 61) for the area are slightly too large. The true measurements were 188 × 204 Roman ft.¹ The temple is represented on many coins, both republican and imperial; these show that the central cella was that of Jupiter, that of Minerva on his right and of Juno on his left. The door was covered with gold reliefs, which were stolen by Stilicho (c. 400; Zosim. v. 38), and the gilt bronze ties (cf. Plin. xxxiii. 57) on the roof were partly stripped off by Geiseric in 455 (Procop. *Bell. Vand.* i. 5), and the rest by Pope Honorius I. in 630 (Carliani, *Topogr.* i. 1).² Till 1348, when the steps up to Arco Marliani were built, there was no access to the Capitol from the back; hence the three ascents to it mentioned by Livy (iii. 7, v. 26-28) and Tacitus (*Hist.* iii. 71-72) were all from the inside of the Servian circuit. Even on this inner side it was defended by a wall, the gates in which are called "Capitolii fores" by Tacitus. Part of the outer wall at the top of the tufa rock, which is cut into a smooth cliff, is visible from the modern Vicolo della Rupe Tarpeia; this cliff is traditionally called the Tarpeian rock, but that must have been on the other side towards the Forum, from whence it was visible, as is clearly stated by Dionysius (vii. 35, viii. 78).³ Another piece of the ancient wall has been exposed, about half-way up the slope from the Forum to the Arx. It is built of soft yellow tufa blocks, five courses of which still remain in the existing fragment. The large temple of Juno Moneta ("the Adviser") on the Arx, built by Camillus in 384 B.C., was used as the mint; hence *moneta* = "money" (Livy. vi. 20).

A large number of other temples and smaller shrines stood on the Capitoline hill, a word used broadly to include both the Capitolium and the Arx.⁴ Among these were the temple of Honos and Virtus, built by Marius, and the temple of Fides, founded by Numa, and rebuilt during the First Punic war. Both these were large enough to hold meetings of the senate. The temples of Mars Ulor (*Mon. Anc.* 4, 5) and Jupiter Tonans (Suet. *Aug.* 29; *Mon. Anc.* 4, 3) were built by Augustus. Other shrines existed to Venus Victrix Ops, Jupiter Custos, and Concord—the last under the Arx (Livy. xxii. 33)—and many others, as well as a triumphal arch in honour of Nero, and a crowd of statues and other works of art (see Plin. *H.N.* xxxiii. 9, xxxiv. 38, 39, 40, 43, 44, 79, xxxv. 69, 100, 108, 157), so that the whole hill must have been a mass of architectural and artistic magnificence.

The so-called Tabularium⁵ occupies the central part of the side towards the Forum; it is set on the tufa rock, which is cut away to receive its lower storey. It derives its name from an inscription which remained *in situ* until the 15th century (*C.I.L.* vi. 1314); whilst all public departments had their *tabularia*, this was a central Record Office, where copies of laws, treaties, &c., were preserved. It was built by Catulus, who was also the dedicator of the great temple of Jupiter (Tac. *Hist.* iii. 72; Dio Cass. xliii. 14), consul in 78 B.C. Its outer walls are of sperone, its inner ones of tufa; the Doric arcade has capitals, impostas and entablature of travertine. Above the arcade was a gallery or porticus, faced with a Corinthian colonnade, of which a few architectural members have been found. The columns appear to have belonged to the 1st century A.D. A road paved with basalt passes through the building along this arcade, entered at one end from the Clivus Capitolinus, and at the other probably from the Gradus Montatis a flight of steps leading from the temple of Concord and the Forum up to the temple of Juno Moneta on the Arx. The entrance from the Clivus Capitolinus is by a wide flat arch of peperino beautifully jointed; the other end wall has been mostly destroyed. The back of this building overlooked the Asylum

or depression between the two peaks. From this higher level a long steep staircase of sixty-seven steps descends towards the Forum; the doorway at the foot of these stairs has a flat arch, with a circular relieving arch over it; it was blocked up by the temple of Vespasian. Great damage was done to this building by the additions of Boniface VIII. and Nicholas V., as well as by its being used as a salt store, by which the walls were much corroded.⁶

The Imperial Fora.

The Forum Julium (see fig. 11, Plan), with its central temple of Venus Genetrix, was begun, about 54 B.C., by Julius (who dedicated it in an unfinished state in 46 B.C.) and completed by Augustus.⁷ Being built on a crowded site, it was somewhat cramped, and the ground cost nearly a hundred million sesterces.⁸ Part of its circuit wall, with remains of five arches, exists in the Via delle Marmorelle; and behind is a row of small vaulted rooms, probably shops or offices. The arches are slightly cambered with travertine springers and keys; the rest, with the circular relieving arch over, is of tufa; it was once lined with slabs of marble, the holes for which exist. Foundations of the circuit wall exist under the houses towards S. Adriano, but the whole plan has not been made out. In the centre of the Forum stood the temple of Venus Genetrix, whose remains were seen and described by Palladio (*Arch.* iv. 31). This temple was vowed by Cato at the battle of Pharsalus.⁹

The forum of Augustus (see fig. 11) adjoined that of Julius on its north-east side; it contained the temple of Mars Ultor, built to commemorate the vengeance taken on Caesar's murderers at Philippi, 42 B.C. (*Ov. Fast.* v. 575 seq.).¹⁰ It was surrounded with a massive wall of peperino, over 100 ft. high, with travertine string-courses and cornice; a large piece of this wall still exists, and is one of the most imposing relics of ancient Rome. Against it are remains of the temple of Mars, three columns of which, with their entablature and marble ceiling of the peristyle, are still standing; it is Corinthian in style, very richly decorated, and built of fine Luna marble. The cella is of peperino, lined with marble; and the lower part of the lofty circuit wall seems also to have been lined with marble on the inside of the forum. The large archway by the temple (Arco dei Pantani) is of travertine. Palladio (*Arch.* iv.) and other writers of the 16th century give plans of the temple and circuit wall, showing much more than now exists. The temple, which was octastyle, with nine columns and a pilaster on the sides, occupied the centre, and on each side the circuit wall formed two large semicircular apses, decorated with tiers of niches for statues.¹¹

The Forum Paclii, built by Vespasian, was farther to the south-east; the only existing piece, a massive and lofty wall of mixed tufa and peperino, with a travertine archway, is opposite the end of the basilica of Constantine. The arch opened into the so-called Templum Sacrae Urbis, a rectangular building entered by a portico on its west side, whose north wall was decorated with a marble plan of the city of Rome (see below, p. 608). The original plan was probably burnt with the whole group of buildings in this forum in 191, in the reign of Commodus (Dio Cass. lxxii. 24); but a new plan was made, and the building restored in concrete and brick by Severus. The north end wall, with the clamps for fixing the marble plan, still exists, as does also the other (restored) end wall with its arched windows towards the forum; one hundred and sixty-seven fragments of this plan were found c. 1563 at the foot of the wall to which they were fixed, and are now preserved in the Capitoline Museum; drawings of seventy-four pieces now lost are preserved in the Vatican (*Cod. Vat.* 3439). The whole of these fragments were published by Jordan, *Forma Urbis Romae* (Berlin, 1874). The other fragments have since been brought to light, and the whole series was rearranged in the Palazzo dei Conservatori in 1903. The circular building at the end facing on the Sacra Via is an addition built by Maxentius in honour of his deified son Romulus; like the other buildings of Maxentius, it was rededicated and inscribed with the name of his conqueror

¹ See *Bull. Comm. Arch.* iii. (1875), p. 165; *Mon. Inst.* v. pl. xxxvi. x. pl. xxx; Jordan, *Topographie der Stadt Rom*, i. 2, 69; *Notizie degli Scavi*, 1896, p. 161, 1897, p. 30; Richter, "Der kapitolinische Jupitertempel und der italische Fuss," in *Hermes* (1887), p. 17.

² The pediment is shown on a relief now lost, but extant in the 16th century and reproduced in drawings of that date. It has been recently proved to have decorated the Forum of Trajan (Wace in *Papers of the B.S.R.* iv. p. 240, pl. xx.). The front of the temple is shown on one of the reliefs of Marcus Aurelius now in the Palazzo dei Conservatori (*Papers of the B.S.R.* iii. pl. xxvi.).

³ See Rodocanachi, *The Roman Capitol*, p. 50. A graceful account of the legend of Tarpeia is given by Propertius, *Eleg.* iv. 4.

⁴ A structure of great sanctity, dating from prehistoric Etruscan times, was the Auguraculum, an elevated platform upon the Arx, from which the signs in the heavens were observed by the augurs (see Festus, ed. Müller, p. 18).

⁵ On the Tabularium see Delbrück, *Hellenistische Bauten in Latium*, i. (1907), pp. 23-46.

⁶ The Porta Pandana ("ever-open gate") gave access from the Area Capitolina, upon which the temple of Jupiter stood, to the Tarpeian rock.

⁷ See *Mon. Anc.* (quoted above); Plin. *Hist.* Nat. xxxv. 156, xxxvi. 103.

⁸ *Cic. Ep. ad Att.* iv. 16; Suet. *Caes.* 26; Plin. *H.N.* xxxvii. 103.

⁹ See Dio Cass. xliii. 22; Appian, *Ell. Civ.* ii. 102; Vitr. iii. 5; Plut. *Caes.* 60.

¹⁰ The Ancyran inscription records—IN PRIVATO.SOLVO[EMPT]M. MARTIS.ULTORIS.TEMPLVM.FORVMQVE.AUGUSTVM.EX. [MAN]IBUS.FECL. See Suet. *Aug.* 29, 56; Dio Cass. lvi. 27; Plin. *H.N.* xxxvi. 102, xxxv. 94, xxxiv. 48, vii. 183, where many fine Greek works of art are mentioned as being in the forum of Augustus.

¹¹ Those of Roman leaders and generals, from Aeneas and Romulus to Augustus. See Borsari, *Foro d'Augusto*, &c. (1884).

¹² An interesting description of this discovery is given by Vacca, written in 1594 (see Schreiber in *Berichte der sächs. Gesellsch. der Wissenschaften*, 1881). The scale is roughly 1 to 250.

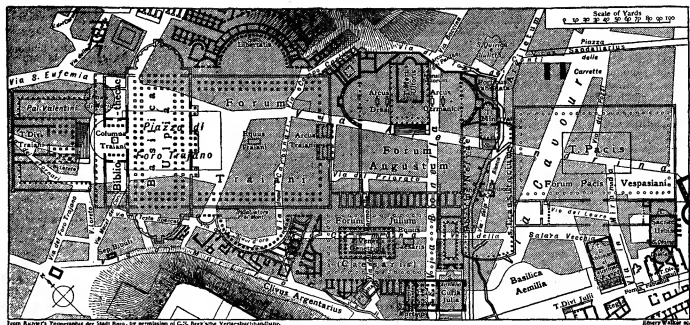

FIG. 11.—Imperial Fora.

Constantine.¹ The original building of Vespasian was probably an archive and record office; it was certainly not a temple. The fine bronze doors at the entrance to the temple of Romulus are much earlier than the building itself, as are also the porphyry columns and very rich entablature which ornament this doorway. Pope Felix IV. (526-30) made the double building into the church of SS. Cosmo e Damiano, using the circular domed temple of Romulus as a porch.² The chief building of Vespasian's forum was the Temple of Pacis,³ dedicated in 75, one of the most magnificent in Rome, which contained a very large collection of works of art.

The forum of Nerva (see fig. 11) occupied the narrow strip left between the fora of Augustus and Vespasian; being little more than a richly decorated street, it was called the Forum of Transitorium or Forum Palladium, from the temple to **Forum of Nerva.** Minerva which it contained. It was begun by Domitian, and dedicated by Nerva in 97 (see Suet. *Dom. 5*; Mart. i. 2, 8). Like the other imperial fora, it was surrounded by a peperino wall, not only lined with marble but also decorated with rows of Corinthian columns supporting a rich entablature with sculptured frieze. Two columns and part of this wall still exist; on the frieze are reliefs of weaving, fulling and various arts which were under the protection of Minerva. A great part of the temple existed till the time of Paul V., who in 1666 destroyed it to use the remains for the building of the Acqua Paola.⁴ In the reign of Severus Alexander a series of colossal bronze statues, some equestrian, were set round this forum; they represented all the previous emperors who had been deified, and by each was a bronze column inscribed with his *res gestae* (*Hist. Aug. Sev. Alex. 28*).

The forum of Trajan with its adjacent buildings was the last and, at least in size, the most magnificent of all; it was in progress from **Forum of** 113 to 117, at least. A great spur of hill, which connected **Trajan.** the Capitoline with the Quirinal, was cut away to make a level site for this enormous group of buildings. It consisted (see fig. 11) of a large dipertal peristyle, with curved projections, lined with shops on the side. That against the slope entrance was through a triumphal arch (Dio Cass. lxxviii. 29). Aurei of Trajan show this arch and other parts of his forum.⁵ The opposite side was occupied by the Basilica Ulpia (Jordan, *F.U.R.* iii. 25, 26), part of which, with the column of Trajan, is now visible; none of the columns, which are of grey granite, are *in situ*, and the whole restoration is misleading. Part of the rich paving in oriental marble is genuine. This basilica contained two large libraries (Dio Cass. lxxviii. 16; *Aul. Gell.* xi. 17).

The Columna Cochlis (so called from its spiral stairs) is, including capital and base, 97 ft. 9 in. high,⁶ i.e. 100 Roman ft.; its pedestal has reliefs of trophies of Dacian arms, and winged Victories.

On the shaft are reliefs arranged spirally in twenty-three tiers scenes of Trajan's victories, containing about 2500 figures. Trajan's ashes were buried in a gold urn under this column (Dio Cass. lxxviii. 16); and on the summit was a colossal gilt bronze statue of the emperor, now replaced by a poor figure of St Peter, set there by Sixtus V.⁷ Beyond the column stood the temple of Trajan completed by Hadrian; its foundations exist under the buildings at the north-east side of the modern piazza, and many of its granite columns have been found. This temple is shown on coins of Hadrian.⁸ The architect of this magnificent group of buildings was Apollodorus of Damascus (Dio Cass. lix. 4), who also designed many buildings in Rome during Hadrian's reign.⁹ In addition to the five imperial fora, and the Forum Magnum, Hortorium and Boarium, mentioned above, there were also smaller markets for pigs (Forum Suarium), bread (Forum Pistorium) and fish (Forum Piscarium), all of which, with some others, popularly but wrongly called fora, are given in the regionary catalogues.

Other Temples, &c.

Besides the temples mentioned in previous sections remains of many others still exist in Rome. The foremost by the Tiber, in the Forum Boarium (Plan, No. 5), formerly thought to be that of Vesta, is possibly that of Portunus, the god **Other** of the harbour (Varro, *L.L.* vi. 19). Its design is similar temples. to that of the temple of Vesta in the forum (fig. 8), and, except the entablature and upper part of the cella, which are gone, it is well

¹ Its pedestal is inscribed, "Senatus Populusque Romanus Imp. Caesaris Divi Nervae F. Nervae Trajano Aug. Germ. Dacico Pontif. Maximo Trib. Pot. XVIIII. [i.e. A.D. 113] Imp. VI. Cos. VI. P. P. ad declarandum quanta altitudinis mons et locus tantis operibus sit egestus." This would seem to indicate the height of the hill removed to form the site, and is so explained by Dion Cass. (lxxviii. 16). It is impossible that the saddle connecting the Quirinal with the Capitoline hill can have been 100 ft. in height (Brocchi, *Suolo di Roma*, p. 133), but it may be that the cliff of the Quirinal was cut back to a slope reaching to a point about 72 ft. high; thus the statement of the inscription is much exaggerated. Comm. Boni has found the remains of a road beneath the pavement of the Forum, near the column, and believes that the inscription refers to the height of the buildings. Comparetti refers *mons* to the mass of marble quarried to build the Forum; Sogliano to the mass of ruins and rubbish carted away; Mau to the Servian *agger* between the Capitol and Quirinal (see *Rom. Mith.*, 1907, 187 ff.).

² For the reliefs, see Cichorius, *Die Reliefs der Trajanssäule* (1896-1900); Petersen, *Trajan's dakische Kriege* (1899-1903); Stuart Jones, *Papers of the B. R. S.*, vol. v. From their lofty position they are now difficult to see, but originally must have been very fairly visible from the galleries on the colonnades which once surrounded the column.
³ See *Aul. Gell.* xi. 17, 1; *Hist. Aug. Hadr.* lvi. 10; and compare Pausanias (v. 12, 6; x. 5, 11), who mentions the gilt bronze roofs of Trajan's forum.
⁴ See Richter and Grifi, *Ristaurato del Foro Trajano* (1839).

¹ For accounts of this group of buildings, see De Rossi, *Bull. Arch. Crist.* (1867), pp. 66 ff.; and Lanciani, *Bull. Comm. Arch. Rom.* (1882), pp. 29 ff.

² Hic (Felix) fecit basilicam SS. Cosmae et Damiani . . . in Via Sacra, juxta Templum Urbis Romae" (*Lib. Pont., Vita S. Felicis IV.*). By the last words the basilica of Constantine is meant.

³ Statues by Pheidias and Lysippus existed in the Forum Pacis as late as the 6th century (Procop. *Bell. Goth.* iv. 21).

⁴ Drawings of it are given by Du Pérc and Palladio (*Arch.* iv. 8).

⁵ See *Aul. Gell.* xiii. 25, 2; and *Ann. Marc.* xvi. 10, 15.

preserved. It may date from the 2nd century B.C. The neighbouring Ionic temple, popularly called of Fortuna Virilis, is of special interest from its early date, probably the end of the 3rd century B.C. The complete absence of marble and the very sparing use of travertine, combined with the simple purity of its design, indicate an early date.¹ It has a prostyle tetrastyle portico of travertine, and a short cella of tufa with engaged columns; the bases of these and of the angle columns are of travertine. The frieze has reliefs of ox skulls and garlands. The whole was originally stuccoed and painted so that the different stones used would not show. Fig. 12 gives the plan, showing the hard travertine used at the points of greatest pressure, while the main walls with the half columns are of the weaker and softer tufa. The dedication of this temple is doubtful; but it is probably either that of Fortuna or that of Fortuna Matuta, both of which were destroyed by fire in 213 B.C. and restored in the following year. The church of S. Maria

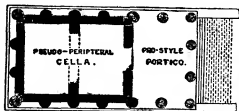

FIG. 12.—So-called Temple of Fortuna Virilis. The black shows tufa; the shading travertine.

in Cosmedin contains some remains of a temple (Plan, No. 4) which has been identified with that of Hercules built by Pompey *ad Circum Maximus* (Vitr. iii. 2. 5; Liv. xxvii. 57). The temple stands close to the carceres of the Circus Maximus, in the Forum Boarium. The columns built up in the church did not, however, belong to a temple, but to a porticus. Within the walls of S. Nicolò in Carcere in the Forum Holitorium (Plan, No. 18) are preserved remains of three small hexastyle peripheral temples, two Ionic and one Tuscan, set close side by side.² A fragment of the marble plan includes part of this group. The Tuscan temple is built of travertine, the others of tufa and peperino, with travertine at the points of greatest pressure. They are probably those of Janus *ad Castrum Martelli*, dedicated by C. Duilius in the First Punic War (Tac. Ann. ii. 49); of Spes, built by A. Atilius Calatinus, of about the same date (Tac. Ann. ii. 49); and of Juno Sospita, dedicated by C. Cornelius Cethegus in 197 B.C. (Liv. xxxiv. 53). Near the Forum Holitorium are extensive remains of the large group of buildings included in the Porticus Octaviae (Plan, No. 16), two of which, dedicated to Juno Regina and Jupiter Stator, with part of the enclosing porticus and the adjoining temple of Hercules Musarum, are shown on a fragment

of the marble plan. The Porticus Octaviae, a large rectangular space enclosed by a double line of columns, was built in honour of Octavia by her brother Augustus on the site of the Porticus Metelli, founded in 146 B.C. (Tac. Ann. iii. 49); must not be confounded with the neighbouring Porticus Octavia founded by Cn. Octavius, the conqueror of Perseus (Liv. xiv. 6, 42), in 168 B.C., and rebuilt under the same name by Augustus, as is recorded in the Ancyran inscription. The whole group was one of the most magnificent in Rome, and contained a large number of works of art by Phedias and other Greek sculptors. The existing portico, which was the main entrance into the porticus, is a restoration of the time of Severus in 203. The church of S. Angelo in Pescheria and the houses behind it conceal extensive remains of the porticus and its temples (see *Ann. Inst.*, 1861, p. 241, 1868, p. 108; and Contiglozzi, *I. Portici di Olaviva*, 1861).

Remains of a large peripheral Corinthian temple are built into the side of the Borsa (formerly the Custom House). Eleven marble columns and their rich entablature are still in the temple of Neptunae, with the corresponding part of the cella wall of peperino; in 1878 a piece of the end wall of the cella was discovered, and, under the houses near, part of a large peribolus wall, also of peperino, forming an enclosure with columns all round the temple nearly 330 ft. square (see *Bull. Comm. Arch. Rom.* vi. pl. iv., 1878). This temple has commonly been identified with that of Neptunae (Dio Cass. lxxv. 24); built by Agrina and surrounded by the Porticus Argonautarum (Dio Cass. liii. 27; Mart. iii. 20, 11); but it clearly dates, at least in its present form, from the 2nd century A.D., and is not improbably the temple of Hadrian, mentioned in the *Notitia* as being near this spot.

The temple of Venus and Rome on the Velia (see fig. 8) was the largest in Rome; it was pseudo-dipteral, with ten Corinthian columns of Greek marble at the ends, and probably twenty at the sides; it had an outer colonnade round the peribolus of about 180 columns of polished granite. Of these only a few fragments now exist; for several centuries

¹ Fiechter (*Röm. Mith.*, 1906, pp. 220 ff.) has endeavoured to show that the temple in its present form dates from the 1st century B.C. For drawings of them, see the list given by Huelsen in Jordan, *Topographie*, i. 3, 511, note 11.

² The remains of the Porticus Octaviae have been more completely exposed by the demolition of the Ghetto.

the whole area of this building was used as a quarry, while the residue of the marble was burnt into lime on the spot in kilns built of broken fragments of the porphyry columns. A considerable part of the two cellae with their apses, set back to back, still exists; in each apse was a colossal seated figure of the deity, and along the side walls of the cellae were rows of porphyry columns and statues in niches. The vault is deeply coffered with stucco enrichments once painted and gilt. The roof was covered with tiles of gilt bronze, which were taken by Pope Honorius I. (625-38) to cover the basilica of St Peter's. These were stolen by the Saracens during their sack of the Leonine city in 846. The emperor Hadrian himself designed this magnificent temple, which was partially completed in 135; the design was criticized severely by the architect Apollodorus (Dio Cass. lix. 4; *Vita Hadr.* 19). The temple was probably finished by Antoninus Pius; it was partly burned in the reign of Maxentius, who began its restoration, which was carried on by Constantine. The existing remains of the two cellae are mainly of Hadrian's time, but contain patches of the later restorations. Between the south angle of this temple and the arch of Constantine stand the remains of a fountain, usually known as the Meta Sudans. This was a tall conical structure in a large circular basin, all lined with marble. From its brick facing it appears to be a work of the Flavian period.

That part of the Caelian hill which is near the Colosseum is covered with very extensive remains—a great peribolus of brick-faced concrete, apparently of Flavian date, and part of a massive travertine arcade in two storeys, similar to that of the Colosseum; most of the latter has been removed for the sake of the stone, but a portion still exists under the monastery and campanile of SS. Giovanni e Paolo. There can be no reasonable doubt that these structures were carried the temple of Claudius, built by Vespasian (Suet. *Vesp.* 9).

The so-called temple of Minerva Medica ("Nymphaeum" on Plan) on the eastern slope of the Esquiline (so named from a statue found in it), a curiously planned building, with central decagonal domed hall, probably belonged to the palace of Gallienus (263-68). Some such similar ruins beside the neighbouring basilica of S. Croce formed part of the Sessorium, a palace on the Esquiline. The remains on the Quirinal, in the colonnades, of massive marble entablatures which have been formerly thought to belong to Aurelian's great temple of the Sun, but it now appears certain that they belong to the very extensive thermae of Constantine, part of the site of which is now occupied by the Quirinal palace and neighbouring buildings.⁴

The excavations of recent years have brought to light, and in many cases destroyed, a large number of domestic buildings; these discoveries are recorded in the *Notizie degli Scavi* and the *Bull. Comm. Arch. Rom.* The extensive cutting houses, away of the Tiber bank for the new embankment exposed some very ornate houses near the Villa Farnesina, richly decorated with marble, fine wall-paintings, and stucco reliefs of equal in beauty to any works of the kind that have ever been found. These are now exhibited in the Museo delle Terme, but the houses themselves have been destroyed. The laying out of the new Quirinal and Esquiline quarters has also exposed many fine buildings. Some remains on the Esquiline have been supposed (without much probability) to belong to the villa of Maecenas. A very remarkable vaulted room, decorated with paintings of plants and landscapes, has been shown to be a greenhouse;⁵ at one end is an apse with a series of step-like stages for flowers. This one room has been preserved, though the rest of the villa has been destroyed; it is on the road leading from S. Maria Maggiore to the Lateran. The walls are a very fine specimen of tufa *opus reticulatum*, unmixured with brick, evidently of the early imperial period. Among the numerous buildings discovered in the Horti Sallustiani near the Quirinal was a very fine house of the 1st century A.D., in concrete faced with brick and *opus reticulatum*. It had a central circular domed hall, with many rooms and staircases round it, rising four storeys high. This house was set in the valley against a cliff of the Quirinal, so that the third floor is level with the upper part of the hill. It is nearly on the line of the Servian wall, which stood here at a higher level on the edge of the cliff. The villa was built out by the hortator Sallustius, and remained in the possession of his family until the reign of Tiberius, when it became imperial property; it was used as a residence by Nero (Tac. Ann. xiii. 47) and other emperors till the 4th century.⁶ In 1884, near the Porta S. Lorenzo, a long line of houses was discovered during the making of a new road. Some of these were of *opus reticulatum* of the 1st century B.C.; others had the finest kind of

⁴ See Palladio (*Terme dei Romani*, London, 1732), who gives the plan of this enormous building, now wholly hidden or destroyed.

⁵ *Bull. Inst.* (1875), 89-96; see also *Bull. Comm. Arch.* (1874), 137 ff., pls. xi-xviii.

⁶ During excavations made here in 1876, lead pipes were found inscribed with the name of the estate, the imperial owner (Severus Alexander), and the plumber who made them—ORTORVS SALLVSTIANVS. IMP. SEVER. ALEXANDRI. AVG. NARVIVS. MANVS. PICTOR. (C.I.L. xv. 7249).

Buildings on the Caelian, Esquiline and Quirinal.

brick-facing, probably of the time of Nero; all had been richly decorated with marble linings and mosaics. The line of the street was parallel to that of the later Aurelian wall, which at this part was built against the back of this row of houses. At the same time, behind the line of houses were uncovered fine peperino and tufa firms of the aqueduct rebuilt by Augustus, one arch of which forms the Porta S. Lorenzo. These interesting remains have all been completely destroyed. A fine house of the end of the 1st century A.D., with richly decorated walls, was exposed in June 1882, against the slope of the Quirinal, near the Palazzo Colonna; it was immediately destroyed to make room for new buildings.

The praetorian camp was first made permanent and surrounded with a strong wall by the emperor Tiberius (Suet. *Tib.* 37). Owing to the camp being included in the line of the Aurelian wall, a great part of it still exists; it is a very interesting specimen of early imperial brick-facing. The wall is only 12 to 14 ft. high, and has thinly scattered battlements, at intervals of 20 ft. The north-east gate (*Porta Principalis Dextra*) is well preserved; it had a tower on each side, now greatly reduced in height, in which are small windows with arched heads moulded in one slab of terra-cotta. The brick-facing is very neat and regular,—the bricks being about 1 1/2 in. thick, with 1/4-in. joints. On the inside of the wall are rows of small rooms for the guards. Part of the Porta Praetoria also remains. This camp was dismantled by Constantine, who removed its inner walls; the outer ones were left because they formed part of the Aurelian circuit. The present wall is nearly three times the height of the original camp wall. The upper part was added when Aurelian included it in his general circuit wall-facing Rome. The superior neatness and beauty of Tiberius's brick-facing make it desirable to distinguish his work ends and that of the later emperors begin. Owing to the addition of the later wall it requires some care to trace the rows of battlements which belong to the camp.

The Pantheon is the most perfect among existing classical buildings in Rome. The inscription on the frieze of the portico (M. Pantheon. AGRIPPA. L. F. COS. TERTIVM. FECIT) refers to a building erected by Agrippa in 27 B.C., consecrated to the divinities of the Julian house (Mars, Venus, etc.) under the name Pantheon ('all-holy'; cf. Dio Cassius, *l.iii.* 27; *Plin. H.N.* xxxvi. 43). It was sometimes used as the meeting-place of the Senate. Agrippa died before they began to meet in the temple of Concord (*C.I.L.* v. 2041). Pliny mentions the sculpture by the Athenian Diogenes which adorned it, and its capitals and dome covering of Syracusean bronze (xxiv. 7). It was long supposed that the present rotunda was the Pantheon of Agrippa; but this was destroyed in the great fire of A.D. 80 (Oros. 7, 12; Hieron. *Abr.* 2127); and recent investigations have shown that the rotunda is a work of Hadrian's reign, bricks of that period having been found in all parts of the building. Excavations have made it probable that the site of the rotunda was previously occupied by an open piazza, whose pavement of coloured marbles has been discovered beneath the flooring, and that Agrippa's Pantheon covered the present piazza and face southward. The present portico has been reconstructed; it is probable that Agrippa's portico had ten columns in the front. The ceiling of the portico too was of bronze, supported by hollow bronze girders,¹ which remained till Urban VIII. melted them to make cannon for S. Angelo; the bronze weighed 450,000 lb. The bronze tiles of the dome were stolen long before by Constans II., in 663, but on their way to Constantinople they were seized by the Saracens. The portico has eight columns on the front and three on the sides, all granite monoliths except the restored ones on the east side,—sixteen in all. The capitals are Corinthian, of white marble; the tympanum (*derma*) of the pediment was filled with bronze reliefs of the battle of the gods and the giants.² The walls of the circular part, nearly 20 ft. thick, are of solid tufa concrete, thinly faced with brick. The enormous dome, 142 ft. 6 in. in span, is cast in concrete made of pumice-stone, puzzolana and lime; being one solid mass, it covers the building like a shell, free from any lateral thrust at the haunches. On the face of the concrete is a system of superimposed relieving arches in brick. These no longer possess any constructive value, but were designed to preserve the stability of the dome whilst the concrete became firmly set. Round the central opening or hypocaustum still remain a ring of enriched moldings in gilt bronze, the only bit left of the bronze which once covered the whole dome. The lower storey of the circular part and the walls of the projecting portico were covered with slabs of Greek marble; a great part of the latter still remains, enriched with Corinthian pilasters and bands of sculptured ornament. The two upper storeys of the drum were covered outside with hard stucco of pounded marble. Inside the whole was lined with a great variety of rich oriental marbles. This magnificent interior, divided into two orders by an entablature supported on columns and pilasters, has been much injured by

alteration.³ About 608 the Pantheon was given by Plocaas to Boniface IV., who consecrated it as the church of S. Maria ad Martyres. In 1881–82 the destruction of a row of houses behind the Pantheon exposed remains of a grand hall with richly sculptured entablature on Corinthian columns, part of the great thermæ of Agrippa, which extend beyond the Via della Ciambella. A great part of the thermæ appears from the brick stamps to belong to an extensive reconstruction in the reign of Hadrian (182 B.C.).

Close by the Pantheon is the church of S. Maria sopra Minerva, which stands (as its name records) on or near the site of a temple to Minerva Chalcidica (Plan, No. 12), probably founded by Pompey the Great, c. 60 B.C. (*Plin. H.N.* vii. 97), and restored by Domitian. Adjoining this were temples to Isis and Serapis, a cult which became very popular in Rome in the time of Hadrian; large quantities of sculpture, Egyptian-Roman in style, have been found on this site at many different times.⁴

Several of the barracks (*excubitoria*) of the various cohorts of the vigiles or firemen have been discovered in various parts of Rome. That of the first cohort (Plan, No. 29) is buried under the Palazzo Savorelli; that of the second (Plan, No. 30) was on the Esquiline, near the so-called temple of Minerva Medica; that of the third (Plan, No. 31) was near the baths of Diocletian. The most perfect is that of the seventh cohort (Plan, No. 34), near S. Crisogono in Trastevere, a handsome house of the 2nd century, decorated with mosaic floors, wall-paintings, &c.⁵

The excavations made in exposing the ancient church of S. Clemente brought to light interesting remains of different periods; drawings are given by Mullooly, *St. Clement and his Basilica* (1869), and De Rossi, *Bull. Arch. Crist.* (1863), 28.

Some remains exist of the Golden House of Nero, which, including its parks, lakes, &c., covered an incredibly large space of ground, extending from the Palatine, over the Velia and the site of the temple of Venus and Rome, to the Esquiline, filling the great valley between the Caelian and the Esquiline where the Colosseum stands, and reaching far over the Esquiline to the great reservoir now called the "Sette Sale." No other extravagances or cruelties of Nero appear to have offended the Roman people so much as the erection of this enormous palace, which must have blocked up many important roads and occupied the site of a whole populous quarter. It was partly to make room for the baths of Nero, which were begun by Vespasian and Titus destroyed the Golden House and built the Colosseum and Thermæ of Titus on part of its site. Adjoining the baths of Titus were those built on a much larger scale by Trajan. Under the substructions of these extensive remains of the Golden House still exist;⁶ and at one point, at a lower level still, pavements and foundations remain of one of the numerous houses destroyed by Nero to clear the site. The great bronze colossus of Nero, 120 ft. high (Suet. *Nero*, 31), which stood in one of the porticus of the Golden House, was moved by Vespasian, with head and attributes altered to those of Apollo (Helios), on to the Velia; and it was moved again by Hadrian, when the temple of Rome was built, on to the base which still exists near the Colosseum. Several coins show this colossus by the side of the Colosseum.

Under the Palazzo Doria, the church of S. Maria in Via Lata, and other neighbouring buildings extensive remains exist of a great porticus, with long rows of travertine piers; this building is designated on fragments of the marble plan with the words *SAEPTA . . . LIA*. This must be the *Saepta Julia*, begun by Julius Caesar, and completed by Agrippa in 27 B.C., as the voting place for the Comitia Centuriata, divided into compartments, one for each century. The building contained rostra, and was also used for gladiatorial shows. Under the later empire it became a bazaar and resort of slave-dealers. *Saepiani der Römer*, ed. 2, pp. 550 ff.; Rivora, *Rivista di Roma* (1910), p. 412.

That curiously planned building on the Esquiline, in the new Piazza Vit. Emanuele, where the so-called trophies of Marius once were placed (See Du Pérac, *Vestigi*, p. 27), is one of the numerous castella or reservoirs from which the water of the various aqueducts was distributed in the quarters they were meant to supply, and may perhaps be identified with the Nymphæum Alexandri built

¹ The bronze door is not in its present form antique, having been recast by order of Pius IV.

² The plan of the whole group, including the Pantheon, is given by Palladio (*op. cit.*). The recent discoveries are given by Lanciani, *Not. d. Scavi* (1882), p. 357, with a valuable plan. See also Geymüller, *Documenti inediti sulle Terme di Agrippa* (Lausanne, 1883); Beltrami and Armanini, *Il Pantheon* (1898); Rivora, *Saepiani der Römer*, ed. 2, pp. 550 ff.; Rivora, *Rivista di Roma* (1910), p. 412.

³ See Lanciani in *Bull. Comm. Arch. Rom.* (1883), and Marucchi, *ibid.* (1896); Fea, *Miscell.* cclv. 112. Part of the Serapeum is shown on fragments of the marble plan, which has been pieced together by Huelsen (Jordan, *Topographie der Stadt Rom*, i. 3, p. x.).

⁴ See Visconti, *La stazione della Coorte VII. de' Vigili* (1867).

⁵ See De Romanis, *Le antiche camere esquiline* (1822). It should be noted that the paintings said to have belonged to the baths of Titus really decorated the Golden House, over which the baths of Titus and Trajan were built.

⁶ A drawing of this interesting bronze work, by G. A. Dosio, is preserved in the Uffizi at Florence (No. 1021).

⁷ On the architrave is cut an inscription recording the restoration of the Pantheon by Severus in 202.

Thermæ of Agrippa.

Firemen's barracks.

Golden House of Nero.

Saepta Julia.

by Severus Alexander at the termination of his Alexandrine aqueduct, opened in 225 (see *Hist. Aug. Sev. Alex.* 25). But the marble trophies now set at the top of the Capitoline steps bear a quarry mark which shows them to be of the time of Domitian: it consists of the following inscription, now not visible, as it is cut on the under part—IMP. DOM. AVG. GERM. PER. CHREZ. LIB. ✱ CÆ I.

Places of Amusement.

The Circus Maximus (see CIRCUS) occupied the Vallis Murcia between the Palatine and the Aventine. Its first rows of seats, *Circuses*, which were of wood, are said to have been made under the Tarquins (Liv. i. 26; Dionys. iii. 68). Permanent carceres were set up in 329 B.C. and restored in 174 B.C. (Liv. viii. 20, xli. 27). In the reign of Julius Caesar it was rebuilt with (for the first time) lower seats of stone (Plin. *H.N.* xxxvi. 102), the upper being still of wood (Suet. *Caes.* 39); Dionysius (iii. 68) describes it as it was after this rebuilding. It was further ornamented with marble by Augustus, Claudius and other emperors. The wooden part was burnt in the great fire of Nero, and again under Domitian; it was considerably enlarged by Trajan, and lastly it was restored by Constantine. In its later state it had a marble façade with three external tiers of arches with engaged columns, and an (inside) sloping tiers of marble seats, supported on concrete raking vaults (*Liv. Paneg.* 51). A great part of these vaults existed in the 16th century, and is shown by Du Pérac. It is said by Pliny (*H.N.* xxxvi. 102)—if the text be not corrupt—to have held 250,000 spectators, while the *Reginary Catalogues* give the number of seats as 485,000; but Huelsen has shown (*Bull. Comm. Arch.*, 1894, 421 ff.) that the figures are much exaggerated and must, moreover, be interpreted, not of the number of spectators, but of the length of the tiers expressed in feet. The end with the carceres was near the church of S. Maria in Cosmedin.¹ Some of its substructures, and the remains of early structures on the Palatine side, still exist below the church of S. Anastasia (see Plan of Palatine). The obelisk now in the Piazza del Popolo was set on the spina by Augustus, and that now in the Lateran piazza by Constantine II. The Circus Flaminius in the Campus Martius was built in 221 B.C. by the C. Flaminius Nepos who was killed at the Trasimene Lake in 217 B.C.; remains of the structure existed until the 16th century, when they were destroyed to build the Palazzo Mattei. In the middle ages its long open space was used as a rope-walk, hence the name of the church called S. Caterina dei Funari, which occupies part of its site. The circus of Caligula and Nero was at the foot of the Vatican Hill (Plin. *H.N.* xxxv. 74). The modern scenery of St Peter's stands over part of its site. The obelisk on its spina remained standing *in situ* till it was moved by Fontana² for Sixtus V. to its present site in the centre of the piazza. The great stadium, foundations of which exist under most of the houses of the Piazza Navona (Agnonali), and especially below S. Agnese, is that built by Domitian and restored by Severus Alexander. That it was a stadium and not a circus is shown by the fact that its starting end is at right angles to the sides and not set diagonally, as was always the case with the carceres of a circus; nor is there any trace of foundations of spina. The best preserved circus is that of Maxentius in honour of his deified son Romulus, by the Via Appia, 2 m. outside the walls of Rome. It was attributed to Caracalla till 1825, when an inscription recording its true dedication was found.³

The first permanent naumachia was that constructed by Augustus between the foot of the Janiculum hill and the Tiber. The naumachia of Domitian was pulled down and the materials used to restore the Circus Maximus (Suet. *Dom.* 5); it was perhaps restored by Trajan, for the remains of a naumachia built of *opus reticulatum* mixed with brick have been discovered near the mausoleum of Hadrian.

The first stone theatre in Rome was that built by Pompey in 55-52 B.C. (see THEATRE: Roman); it contained a temple, called *Theatres*, *Victrix*, and in front of it was a great portico, *Venus Hecateostylum* from its hundred columns. This is shown on the marble plan.⁴ Considerable remains of the foundations exist between the Piazza dei Satrii, which occupies the site of the

scena, and the Via de' Giubbonari and Via del Paradiso. Adjoining this was the *porticus Pompeiana*, which contained the curia of Pompey, where Caesar was murdered, after which it was walled up. The colossal statue, popularly supposed to be that of Pompey, at the feet of which Caesar died,⁵ now in the Palazzo Spada, was found in 1553 near the theatre. This theatre was restored by Augustus (*Mon. Anc.* 4, 9); in the reign of Tiberius it was burnt, and its rebuilding was completed by Caligula. The scena was again burnt in A.D. 80 and restored by Titus. According to Pliny (*H.N.* xxxv. 115), it held 40,000 spectators; the *Reginary Catalogues* give the number 17,580. Huelsen estimates its capacity at 9000-10,000 spectators. In 1864 the colossal gilt bronze statue of Hercules, now in the Vatican, was found near the site of the theatre of Pompey, carefully concealed underground. The theatre of Marcellus is much more perfect; complete foundations of the cunei exist under the Palazzo Savelli, and part of the external arcade is well preserved. This is built of travertine in two orders, Tuscan and Ionic, with delicate details, very superior to those of the Colosseum; the arcade of which is very similar to this in general design. This theatre was begun by J. Caesar, and finished by Augustus in 13 B.C., who dedicated it in the name of his nephew Marcellus.⁶ It was restored by Vespasian (Suet. *Vesp.* 19). Foundations also of the theatre dedicated by Cornelius Balbus in 13 B.C. (Suet. *Aug.* 29; Dio Cass. liv. 25) exist under the Monte dei Cenci; and in the Via dei Calderari there is a small portion of the external arcade of a porticus (Plan. No. 42); the lower storey has travertine arches with engaged columns, and the upper has brick-faced pilasters. This has been supposed to be the *Crypta Balbi* mentioned in the *Reginary Catalogues*, but more probably the *Porticus Minucia*, built in 110 B.C. An interesting account of the temporary theatre of M. Aemilius Scaurus, erected in 58 B.C., is given by Pliny (*H.N.* xxxvi. 5, 113). The same writer mentions an almost incredible building, which consisted of two wooden theatres made to revolve on pivots, so that the two together made an amphitheatre; this was erected by C. Curio in 50 B.C. (*H.N.* xxxvi. 116).

The first stone amphitheatre in Rome was that built by Statilius Taurus in the reign of Augustus. (For the Colosseum and the Amphitheatrum Castrense, see AMPHITHEATRE; for the Baths, see that article.)

Archae, Columns, Tombs and Bridges.

The earliest triumphal arches were the two erected by L. Stertinius (196 B.C.) in the Forum Boarium and in the Circus Maximus, out of the city gates. In Spain, in the latter years of the Roman empire, there were nearly forty in Rome. The arch of Titus and Vespasian on the Summa Sacra Via was erected by Domitian to commemorate the conquest of Judaea by Titus in his father's reign. Reliefs inside the arch represent the triumphal procession—Titus in a chariot, and on the other side soldiers bearing the golden candlestick, trumpets and table of prothesis, taken from the Jewish temple. The central part only of this monument is original; the sides were restored in 1823.⁷ Another arch in honour of Titus had previously been built (A.D. 80) in the Circus Maximus; its inscription is given in the *Emisioden MS.* (*C.I.L.* vi. 944). A plain travertine arch near the supposed palace of Commodus on the Caelian is inscribed with the names of the Consul Publius Cornelius Dolabella (A.D. 10) and of the *flamen martialis*, C. Junius Silanus. It may have originally been used to carry the Aqua Marcia; in later times the Aqua Claudia passed over it. The so-called arch of Drusus by the Porta Appia also carries the spout of an aqueduct—that built by Caracalla to supply his great *thermae*. Its composite capitals show, however, that it is later than the time of Drusus, and it was very possibly the work of Trajan. Adjoining the church of S. Giorgio in Velabro in a richly decorated coarsely carved marble gateway with flat lintel still exist—but, as its inscription records, in honour of Severus and his sons by the argentarii (bankers and silversmiths) and other merchants of the Forum Boarium in 204. It formed an entrance from the Forum Boarium into the Velabrum. The figure of Geta in the reliefs and his name have been erased by Caracalla; the sculpture is poor both in design and execution (see *Bull. Inst.*, 1867, p. 217, and 1871, p. 233). Close by is a quadruple arch, set at the intersection of two roads, such as was called by the

¹ See Bruzza, in *Ann. Inst.* (1870), and Lenormant, *Trophées de Marius*, Blois (1842). This once magnificent building, with the marble trophies in their place, is shown with much minuteness on a bronze medallion of Severus Alexander (see Froehner, *Médailles de l'empire*, Paris, 1878, p. 169).

² So called from a prehistoric altar to the Dea Murcia (Venus); Varro, *L.L.* v. 154.

³ Part of it is shown on a fragment of the marble plan (see Jordan, *F.U.R.*); it is represented on a bronze medallion of Gordian III., with an obelisk on the spina and three metae at each end; in front are groups of wrestlers and boxers (see Grueber, *Rom. Med.* pl. xli., London, 1874).

⁴ The remains extant in the 16th century were described by Ligorio, *Libro delle Antichità* (1553), p. 17.

⁵ See his *Trasportazione dell' obelisco Vat.* (1590).

⁶ Nibby, *Circo di Marcella* (1825); Canina, *Edifizi di Roma*, iv. pls. 194-96.

⁷ *Plut.* *Pompeii*, 52; Dion Cass. xxxix. 38; Tac. *Ann.* xiv. 20.

⁸ See Fea, *Rom. Ant.* lxviii. 57, for an account of its discovery.

⁹ Suet. *Aug.*, 29. See *Mon. Anc.* 4, 22. "The theatre, ad aedem. Apollinis in, solo, magna, ex, parte, a, [privatis] impto, fecti, quod, svb, nomine, M. Marcelli, generi, [me]i, esset." The temple of Apollo here named was one of the most ancient and highly venerated in Rome; it was dedicated to the Delphic Apollo in 431 B.C. by Cn. Julius (Liv. iv. 25); meetings of the Senate were held in it; and it contained many fine works of art—an ancient cedar-wood statue of Apollo (Plin. *H.N.* xiii. 11) and the celebrated statue of the slaughter of the Niobids by Praxiteles or Scopas (Plin. *H.N.* xxxvi. 28), of which many ancient copies exist.

¹⁰ This arch is the earliest known example of the so-called Composite order, a modification of Corinthian in which the capitals combine Ionic volutes with Corinthian acanthus leaves; in other respects it follows the Corinthian order.

Romans an arch of Janus Quadrifrons. Though partly built of earlier fragments, it is late in style, and may be the Arcus Constantini mentioned in the XIth region. The finest existing arch is that by the Colosseum erected by Constantine. It owes, however, little of its beauty to that artistically degraded period. Not only most of its reliefs but its whole design and many of its architectural features were stolen from an earlier arch erected by Trajan as an entrance to his forum (see above). The arch of Claudius, built in 43 to commemorate his supposed victories in Britain, stood across the Via Lata (modern Corso) in the Piazza Sciarra. Its exact position is shown in *Bull. Comm. Arch. Rom.*, 1878, pl. iv. Its remains were removed in the middle of the 16th century,¹ and nothing now is left but half its inscription, preserved in the garden of the Barberini palace. It is shown on both aurei and denarii of Claudius, with an attic inscribed **DE BRITANNIS**, and surmounted by a quadriga and trophies. A little to the N. of the Piazza Colonna was an arch popularly called the Arco di Portogallo, destroyed in 1665, whose reliefs are now in the Palazzo dei Conservatori. They appear to date from the reign of Hadrian, but may have been used at a later time to decorate this arch. An arch also stood opposite S. Maria in Via Lata until 1498, which was probably erected by Diocletian in A.D. 303. The central part of the once triple arch of Gallienus still exists on the Esquiline; it took the place of the ancient Porta Esquilina of the Servian wall. It is built of travertine, is simple in design, with coarse details, and has an inscription on its attic. The two side arches and pediment over the centre existed in the 16th century, and are shown in the Mantuan oil-painting at Rome,² and in several antiquarian works of the 16th century. The inscription (*C.I.L.* vi. 1106) records that it was erected in honour of Gallienus and his wife Salodina by Aurelius Victor.

The column of Antoninus Pius was a month of granite, erected after his death by his adopted sons M. Aurelius and L. Verus. One fragment of it is preserved in the Vatican Museums with an interesting quarry inscription, recording that it was cut in the ninth year of Trajan's reign, under the supervision of Dioscurus and the architect Aristides. The rest of its fragments were used by Pius VI. to repair the obelisk of Monte Citorio, set up by Augustus in the Campus Martius as the gnomon of a sundial (*Plin. H.N.* xxvii. 72). The marble pedestal of the Antonine column is now in the Vatican; it has reliefs representing the apotheosis of Augustus and Antoninus Pius, and the *curia* on which it was formed part of the funeral ceremony. This and the column of M. Aurelius were both surmounted by colossal portrait statues of gilt bronze. The column of M. Aurelius is very similar in size and design to that of Trajan. Its spiral reliefs represent victories in Germany from 171-175, arranged in twenty tiers. Like the column of Trajan, it is exactly 100 Roman ft. high, without the pedestal. The pedestal was originally much higher than at present, but is now partly buried; it is shown by Gamucci, Du Pérac and other 16th-century writers. This column stood in front of a temple to M. Aurelius, and within a great peristyle, the remains of a forum similar to that of Trajan, though much smaller; the remains of this temple, amongst other buildings, probably form the elevation now called Monte Citorio.³

For the catacombs, see CATACOMBS; for obelisks, see OBELISK and EGYPT.

The prehistoric cemeteries of Rome are described above (*Prehistoric Rome*). Few tombs exist of the Roman period earlier than the 1st

Tombs. city beyond the Servian limits, which thus obliterated the earlier burial-places. The tomb of the Cornelli Scipiones is the most important of the date which still exists. It is excavated in the tuff rock at the side of the Via Appia, outside the Porta Capena. Interments of the Scipio family went on here for about 400 years, additional chambers and passages being excavated from time to time. The peperino sarcophagus of Lucius Cornelius Scipio Barbatus (*Liv. x. 12, 13*), consul in 298 B.C., is now in the Vatican; its inscription, in rude Saturnian verse, is one of the most important existing specimens of early Latin epigraphy. Many other inscribed slabs were found in the 17th century, covering the *loculi* in which lay the bodies of later members of the family. Those now existing in the tombs are modern copies. The burial place of Scipios is unlike those of other families, owing to the gens Cornelia keeping up the early custom of interment without burning; thus stone sarcophagi or *loculi* (rock-cut recesses) were required instead of mere pigeon-holes to hold the cinerary urns. The tomb of M. Bibulus, a few yards outside the Porta Fontinalis, and remains of two recently

discovered during the destruction of the Aurelian towers at the Porta Salara, date from about the middle of the 1st century B.C., as does also the curious tomb of the baker Eurysaces outside the Porta Maggiore. In 1863 an interesting tomb of the Sempronii gens⁴ was discovered on the Quirinal, below the royal palace, near the site of the Porta Salutaris. It is of travertine, with a rich entablature and frieze sculptured with the Greek honeysuckle ornament (see *Bull. Comm. Arch.*, 1876, 126, pl. xii.). This also is of the last years of the republic.

The mausoleum of Augustus, built 28 B.C., stood in the north part of the Campus Martius, between the Tiber and the Via Flaminia. It is a massive cylindrical structure of concrete, faced with *opus reticulatum*; according to Strabo, this was faced with *Mausolea*. "white stone," i.e. travertine; inside was a series of radiating chambers, in plan like a wheel. On the top was a great mound of earth, planted with trees and flowers (*Tac. Ann.* iii. 9). In the middle ages it was converted into a fortress by the Colonna, which was destroyed in 1167. In the 16th century the central portion was occupied by a garden.⁵ Only the bare core exists now, with its fine *opus reticulatum*, best seen in the court of the palazzo Valdarbini. The inside is concealed by modern seats, being now used as a concert-hall (Anfiteatro Chorea). The sepulchral inscription in honour of Augustus, engraved on two bronze columns at the entrance, is preserved to us by its copy at Ancyra (*g.v.*). It records an almost incredible amount of building; in addition to the long list of building mentioned by name Augustus says, **DVO. ET. OCTAGINTA. TEMPLA. DEVM. IN. VRBE. CONSVL. SEXTVM. REFECIT.** The first burial in the mausoleum of Augustus was that of M. Claudius Marcellus (died 23 B.C.), and it continued to be the imperial tomb till the death of Nerva, A.D. 98, after whose interment there was no more room.

The mausoleum of Hadrian, built by that emperor as a substitute for that built by Augustus, and dedicated in A.D. 138 by his successor, was a large circular building on a square podium; its walls, of enormous thickness, were of tufa faced with Parian marble and surrounded by a colonnade with rows of statues,—a work of the greatest magnificence. The splendour of its whole is described by Procopius (*Bell. Goth.* i. 22), who mentions its siege by the Goths, when the defenders hurled statues on to the heads of the enemy. In the 14th century the church of S. Andrea inter Nubes was built on its summit, and all through the middle ages it was the papal fortress. The interior chambers are still well preserved, but its outside has been so often wrecked and refaced that little of the original masonry is visible.⁶

Several of the grander sepulchral monuments of Rome were built in the form of pyramids. One of these still exists, included in the Aurelian wall, by the Porta Ostiensis. It is a pyramid of concrete, 118 feet high, faced with blocks of white marble, and contains a small chamber decorated with painted stucco. An inscription in large letters on the marble facing records that it was built as a tomb for C. Cestius, a praetor, tribune of the people, and septemvir of the *epulones* (officials who supervised banquets in honour of the gods). It was erected, according to Cestius's will, by his executors, in the space of 330 days. It dates from the time of Augustus⁷ (see Falconieri, in Nardini, *Roma Antica*, iv. p. 1, ed. 1818-20). Another similar pyramid, popularly known as the tomb of Romulus, stood between the mausoleum of Hadrian and the basilica of St. Peter. It was destroyed at the close of the 15th century, during the rebuilding of the long bridge which connects the former building with the Vatican.

The earliest bridge was a wooden draw-bridge, called the Pons Sublicius from the piles (*sublicae*) on which it was built. The river being an important part of the defence of Rome from the Aventine to the Porta Flumentana (see plan of Servian **Bridges**, wall, fig. 8), no permanent bridges were made till the Romans were strong enough not to fear attacks from without. The Pons Sublicius had a sacred character, and was always restored in wood, even in the imperial period.⁸ Its exact site is doubtful, but it must be placed some distance below the Ponte Rotto. The first stone bridge was begun in 179 B.C. and completed in 142 B.C., when the conquest of Etruria and the defeat of Hannibal had put an end to fears of invasion; it was called the Pons Aemilius after the pontifex maximus⁹ M. Aemilius Lepidus, its founder. It was also called Pons

¹ See Vacca, *op. Fea*, *Misc.*, p. 67.

² Reproduced by De Rossi, in his *Piante di Roma Anteriori* al *Sec. XVI.* (1879).

³ See Bellori, *Veles Arcus* (1690), showing some now destroyed; and Rossini, *Archit. Trionfali* (1832).

⁴ On the Antonine column see Petersen in Amelung's *Katalog der antiken Sculpturen*, I. p. 883; on that of M. Aurelius see *Die Marcussäule*, by Petersen, v. Domaszewski and Calderini (Munich, 1866).

⁵ The inscriptions are given in *C.I.L.* i. 29-39, v. 1284-94. On the earlier ones see Wodfflin, *Münchener Sitzungsberichte* (1892), 188 ff.

⁶ This is shown by an inscription (*C.I.L.* vi. 26152) found on the site in the 17th century.

⁷ See Du Pérac's *Vestigi*, pl. 36, which shows the garden on the top.

⁸ On the mausoleum of Hadrian, see Borgatti, *Castel S. Angelo* (1890).

⁹ Near the tomb of Cestius is that extraordinary mound of potsherds called Monte Testaccio. These are mostly fragments of large amphorae, not piled up at random, but carefully stacked, with apertures at intervals for ventilation. It has been shown by Dressel (*Ann. dell' Inst.*, 1878, 118 ff.; *C.I.L.* xv. p. 492) that damaged or imperfect vessels were thus disposed of.

¹⁰ See Varro, *Lib. v.* 83; *Op. Fast.* v. 622; *Tac. Hist.* i. 86; *Vita Antonini*, Pt. 8.

¹¹ The bridges were specially under the care of the pontifex maximus, at least till the later years of the republic (Varro, *J. L.* v. 83).

Lapidus, to distinguish it from the wooden Sublician bridge. The modern Ponte Rotto represents this bridge; but the existing arches are mainly mediaeval. An ancient basalt-paved road still exists, leading to the bridge from the Forum Boarium. The Pons Fabricius united the city and the island (Insula Tiberina).¹ The bridge derived its name from L. Fabricius, a curator viarum in 62 B.C.; its inscription, twice repeated, is L. FABRICIVS. C. F. CVR. VIAR. FACIENDVM. COEBAVIT. Like the other existing bridges, it is built of great blocks of peperino and tufa, with a massive facing of travertine on both sides. Corbels to support centering were built in near the springing of the arches, so that they could be repaired or even rebuilt without a scaffolding erected in the river-bed. The well-preserved Pons Cestius, probably named after L. Cestius, praefectus urbi in 46 B.C., unites the island and the Janiculum side; on the marble parapet is a long inscription recording its restoration in 370 by Gratian, Valentinian, and Valens.² The next bridge, Ponte Sisto, is probably on the site of an ancient bridge called in the *Notitia* Pons Aurelius. Marliano gives an inscription (now lost) which recorded its restoration in the time of Hadrian. About 100 yards above this bridge have been found the remains of sunken piers, which are proved by an inscription (C.I.L. vi. 31545) to have belonged to the Pons Agrippae, not otherwise known. The Pons Aelius was built in 134 by Hadrian, to connect his mausoleum with the Campus Martius; it is still well preserved, and is now called the Ponte S. Angelo (see Dante, *Inferno*, xviii. 28-33). It had eight arches, of which the three in the centre were higher than the rest, so that the road sloped on both sides. The material is peperino, with travertine facings. Its inscription, now lost, is given in the Einsiedeln MS.—IMP. CAESAR. DIVI. TRAIANI. P. OPTIMI. FILIVS. P. SEPTIMI. SEVERI. P. AEF. AVG. PONT. MAX. TRIB. POT. XVIII. COS. III. P. P. F. ECIT. The Pons Aelius is shown on coins of Hadrian. A little below it are the foundations of another bridge, probably the Pons Neronianus of the *Mirabilia*, called also Vaticanus, built probably by Nero as a way to his Vatican circus and the Horti Agrippinae. At the foot of the Aventine, near the Marmorata, are the remains of piers which seem to have belonged to the Pons Probi, mentioned in the *Notitia*. It is uncertain whether this bridge is to be identified with the Pons Theodosius, which was built in A.D. 381-387 (Symm. Ep. 4, 70, 2; S, 76, 3), and is mentioned in the *Mirabilia*.³

Regiones of Augustus.

In spite of the extensive growth of the city under the republic no addition was made to the four regiones of Servius till the

reign of Augustus, who divided the city and its suburbs into fourteen regiones. The lists in the *Notitia* and

Curiosum are the chief aids in determining the limits of each, which in many cases cannot be done with any exactness (see Preller, *Die Regionen der Stadt Rom* (1846) and Ulrich's *Codex Topographicus* (Würzburg, 1871)). Each regio was divided into vici or parishes, each of which formed a religious body, with its aedilicia larum, and had magistris vicorum. The smallest regio (No. II.) contained seven vici, the largest (No. XIV.) seventy-eight.

The list is as follows:—

- I. *Porta Capena*, a narrow strip traversed by the Appian Way; it extended beyond the walls of Aurelian to the brook Almo.
- II. *Caementonium*, the Caelian Hill.
- III. *Isis et Serapis*, included the valley of the Colosseum and the adjoining part of the Esquiline.
- IV. *Templum Pacis*, included the Velia, part of the Cispian, most of the Subura, the fora of Nerva and Vespasian, the Sacra Via, and also buildings along the north-east side of the Forum Magnum.
- V. *Esquilina*, north part of the Esquiline and the Viminal.
- VI. *Alta Semita*, the Quirinal as far as the praetorian camp.
- VII. *Via Lata*, the valley bounded on the west by the Via Lata, and by the neighbouring hills on the east.
- VIII. *Forum Romanum*, also included the imperial fora and the Capitoline hill.
- IX. *Circus Flaminius*, between the Tiber, the Capitol, and the Via Flamini.
- X. *Palatinum*, the Palatine hill.
- XI. *Circus Maximus*, the valley between the Palatine and the Aventine, with the Velabrum and Forum Boarium.
- XII. *Piscina Publica*, the eastern part of the Aventine, and the districts south of and beyond the Via Appia, including the site of Caracalla's thermae.

¹ Livy (ii. 5) gives the fable of the formation of this island from the Tarquins' corn, cut from the Campus Martius and thrown into the river.

² The two stone bridges connecting the island with the right and left banks took the place of earlier wooden structures.

³ See Mayerhöfer, *Die Brücken im alten Rom*, 1883.

XIII. *Aventinus*, the hill, and the bank of the Tiber below it.

XIV. *Trans Tiberim*, the whole district across the river and the Tiber Island.⁴

The walls of Aurelian (see fig. 7), more than 12 m. in circuit, enclosed almost the whole of the regiones of Augustus, the greater part of which were then thickly inhabited. This enormous wall work was begun in 271, to defend Rome against sudden *Aurelian* attacks of the Germans and other northern races when the great armies of Rome were fighting in distant countries.⁵ After the death of Aurelian the walls were completed by Probus in 280, and about a century later they were restored and strengthened by the addition of gate-towers under Arcadius and Honorius (A.D. 403), in place of the earlier gateways of Aurelian; this is recorded by existing inscriptions on three of the gates.⁶ At many periods these walls suffered much more from the attacks of the Goths (Procop. *Bell. Goth.* iii. 22, 24), and were restored successively by Theodoric (about 500), by Belisarius (about 560), and by various popes during the 8th and 9th centuries, and in fact all through the middle ages. A great part of the Aurelian wall still exists in a more or less perfect state; but it has wholly vanished where it skirted the river, and a great part of its trans-Tiberine course is gone. The best-preserved pieces are between Porta Pinciana and Porta Salaria (in which breaches have lately been made for streets), and between the Lateran and the Amphitheatrum Castrense. The wall, of concrete, has the usual brick-facing and is about 12 ft. thick, with a guard's passage formed in its thickness. Fig. 13 shows its plan: on the inside the

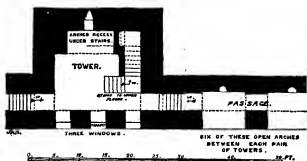

FIG. 13.—Aurelian's Wall; plan showing one of the towers and the passage in thickness of wall.

passage has tall open arches, which look like those of an aqueduct, and at regular intervals of about 45 ft. massive square towers are built, projecting on the outside of the wall, in three storeys, the top storey rising above the top of the wall. The height of the wall varies according to the contour of the ground; in parts it was about 60 ft. high outside and 40 inside. Necessary, supported on two travertine corbels, projected from the top of the wall on the outside beside most of the towers. The Einsiedeln MS. gives a description of the complete circuit, counting fourteen gates, as follows:—

Porta S. Petri (at the Pons Aelius, destroyed); P. Flaminia (replaced by P. del Popolo); P. Pinciana (in use); P. Salaria (now P. Salara); P. Nomentana (replaced by P. Pia); P. Tiburtina (now P. S. Lorenzo); P. Praenestina (now P. Maggiore); P. Asinaria (replaced by P. San Giovanni); P. Metrovia or Metroni (closed); P. Latina (closed); P. Appia (now P. S. Sebastiano); P. Ostiensis (now P. S. Paolo). On the Janiculum side, P. Portuensis (destroyed); P. Aurelia (now Porta San Pancrazio). Besides these there was a gate, now closed (Porta Chiusa), to the south of the Castra Fractoria; and in all probability a gate on the right bank of the Tiber, replaced by the modern Porta Settimiana.

These existing gates are mostly of the time of Honorius; each is flanked by a projecting tower, and some are double, with a second pair of towers inside. Several have grooves for a porticulus (*cata-racta*) in the outer arch. The handsomest gate is the P. Appia, with two massive outer towers, three stages high, the upper semicircular in plan. Many of the gates of Honorius have Christian symbols or inscriptions. The general design of all these gates is much the same—a central archway, with a row of windows over it and two flanking towers, some square, others semicircular in plan. In many of the gates older materials are used, blocks of tufa, travertine, or marble. The doors themselves swung on pivots, the bottom ones let into a hole in the threshold, the upper into projecting corbels.

At many points along the line of the Aurelian wall older buildings form part of the circuit—near the Porta Asinaria a large piece of

⁴ The text of the *Regionary Catalogues* is printed by Richter, *Topographie der Stadt Rom*,³ pp. 371 ff.

⁵ *Vita Aurel.* 21, 39; Zosimus, i. 37, 49; Eutrop. ix. 15.

⁶ The inscriptions run thus: S. P. Q. R. IMP. CAES. D. D. INVICTISSIMI. PRINCIPIBVS. ARCADIO. ET. HONORIO. VICTORIBVS. T. R. OPTIMO. MAXIMO. SEVERO. AVG. OB. INSTAVRATA. VRBIS. AETERNAE. MVROS. PORTAS. AC. TVRRIS. EGESTIS. IMMENSIS. RVDRIBVS—the rest refers to honorary statues erected to commemorate this work.

the Domus Lateranorum, a house of the 3rd century which gave its name to the Lateran basilica, and a little farther on, by S. Croce in Gerusalemme, the Amphitheatrum Castrense; the latter, of about the end of the 1st century A.D., has two tiers of arches and engaged columns of moulded brick on the outside. Between the P. Praenestina and the P. Tiburtina comes a large castellum of the Aqua Tepula. The Praetorian Camp forms a great projection near the P. Nomentana. Lastly, the area near the Porta Flaminia, at the foot of the Pincian Hill, is formed by remains of a lofty and remarkably massive building, faced with fine opus reticulatum of the 1st century B.C. Owing to the sinking of the foundation this is very much out of the perpendicular, and was known as the "murus tortus" at a very early time.¹ What this once important building was is uncertain. Two archways which form gates in the Aurelian wall are of much earlier date. The Porta Maggiore consists of a grand double arch of the aqueducts Anio Novus and Claudia built in travertine. The Porta S. Lorenzo carried a single travertine arch, built by Augustus where the aqueduct carrying the Aqua and the Tepula, and Julia crossed the Via Tiburtina. The main gateway, built of massive travertine blocks by Honorius, was pulled down by Pius IX., in 1868.²

Bibliography of Ancient Roman Topography.—Amongst ancient writers special mention is due to Varro (*De Lingua Latina*), Dionysius of Halicarnassus (*Antiquitates Romanae*), Ovid (*Fasti*), Vitruvius (*De Architectura*), Pliny the Elder (*Naturalis Historia*), Frontinus (*De Aquis*) and the remains of ancient commentaries on Virgil, Horace, &c. The inscriptions found in the city of Rome are contained in vol. VI. of the *Corpus Inscriptionum Latinarum*. Many of them are of the highest importance for Roman topography, e.g. the *Basis Capitolina*, preserved in the Palazzo dei Conservatori, a pedestal which once supported a statue of Hadrian, dedicated in A.D. 136 by the vicomagistri of five regions; on the sides are inscribed the names of the vici and their officials. Vol. XV. of the *C.I.L.* contains the inscriptions stamped on tiles and water-pipes, which are likewise of great importance. The *Monumentum Ancyranum* (*Res gestae divi Augusti*, ed.² Mommsen, 1883) reproduces the bronze tablets set up by Augustus on his mausoleum at Rome, and contains a list of the buildings which he erected or restored. The marble plan of Rome (*Forma Urbis*, ed. Jordan, 1884; the more numerous discovered fragments have only been published in periodicals) dates from the reign of Septimius Severus, who restored the building to which it belonged after the fire of 191 B.C. The plan which it replaced was executed by order of Vespasian. The scale was generally 1:250; it was oriented with S.E. at the top, N.W. at the bottom. Buildings are of course frequently represented on coins and works of art, and these may often be identified with existing remains.

In the reign of Constantine the Great there was compiled a catalogue of the principal buildings of Rome, arranged according to the regions of the city. This has been preserved in two recensions, one made in A.D. 334 and known as the *Notitia*, the second in or about A.D. 357, and known as the *Curiosum urbis Romae*. These are called the *Reginary Catalogues*, and contain, besides lists of buildings, statistics as to the number of vici, domus, insulae, &c., in each region, which are of great value. (See Preller, *Regionen der Stadt Rom*, Jena, 1846.)

In the middle ages, guide-books were written for the use of pilgrims visiting Rome. Besides giving the routes for the principal churches and cemeteries, they mention ancient buildings and give curious legends regarding them. The earliest is the *Itinerarium Einsiedeln*, a MS. of the 8th century preserved in the monastery of Einsiedeln in Switzerland (see C. Huelsen, *Itinerarium di Einsiedeln*, 1908). In the 12th century was compiled the *Mirabilia urbis Romae*, which became the foundation of later guide-books. The last recension is contained in a MS. of the early 15th century. These and other medieval documents are printed in Ulrichs' *Codex Topographicus urbis Romae* (1871). The *Ordo Benedicti Canonici* (see Jordan, *Topographie*, II. 1, 646, and Lanciani, *Monumenti Antichi*, I. 437), which gives the route of papal processions, belongs also to the 12th century, and was perhaps written by the author of the *Mirabilia*. The *Liber Pontificalis* (ed. Duchesne, Paris, 1886; ed. Mommsen, in *Monumenta Germaniae historica*, vol. i.), which gives the biographies of the early popes and was continued throughout the middle ages, is of value as illustrating the transition from pagan to Christian Rome.

Several early views and plans of Rome exist, beginning with the painting by Cimabue in the upper church of S. Francesco at Assisi (1275). A collection of these was published by De Rossi, *Piante scenografiche e prospettive di Roma anteriori al secolo XVI.* (1879). Many others have since come to light. (See Huelsen in *Bull. Comm. Arch.*, 1892, p. 38.)

In Italian and other libraries are preserved large numbers of

plans and drawings from ancient remains by the architects of the 15th and later centuries, e.g. Bramantino, Fra Giocondo, the members of the families of Sangallo and Peruzzi, Pirro, Ligorio, Palladio, &c. These are of immense value, since the monuments which they drew have to a large extent been destroyed. Unfortunately they are not always trustworthy, especially those of Ligorio. The drawings at Florence have been indexed by Ferri; amongst recent publications may be noted those of the *Codex Escorialensis* by Egger (Vienna, 1875), and a sketch-book, probably by A. Conone, in the Soane Museum, by Dr Ashby, in *Papers of the British School at Rome*, vol. ii. (1903). Amongst the printed works of the early Italian architects may be named Palladio, *Architettura* (Venice, 1542), and *Terme dei Romani* (London, 1732); Serlio, *Architettura* (Venice, 1545), and Labacco, *Architettura ed Antichità*, (Rome 1557). Engravings of ancient remains in Rome have been published in great numbers since the 16th century; the most important of the earlier collections are the *Speculum Romanae Magnificentiae*, a series extending over many years in the 16th century, and *Le Piazze e Vestigi di Roma* (1575). In the 18th century began the engravings of Piranesi; published in several volumes, and still reproduced from the copper-plates by the Calcografia.

The literature of Roman topography would in itself form a large library; the best bibliographical guide is Mau's *Katalog der Bibliothek des h. deutschen archäologischen Instituts in Rom* (1900). The earliest modern work which can be called scientific is Flavio Biondo's *Roma instaurata*, written under Eugenius IV. (1431-1447), first dated edition, 1479. Biondo's work was based on the study of ancient literary authorities; he was followed in his method and results by scholars of the 17th and early 18th centuries, e.g. Pozzo, Leo Battista Alberti, and Andrea Fulvio. In the 16th century a study of ancient remains took its place beside that of ancient literature. Marliani, who had followed Biondo in the first edition of his *Antiquae urbis Romae topographia* (1538), issued a second edition in 1544, which contained plans and illustrations. For more than a century his book formed the foundation upon which such writers as Fauno, G. Fabricius, Mauro, Panvinius, &c., raised their works. Unfortunately the *Reginary Catalogues* were largely interpolated during this period, and published in this form by Biondo in 1566. Famiano Nardini's *Roma antica* appeared, based upon the interpolated version of the *Reginary Catalogues*; this was productive of disastrous results, many of which remained uncorrected until our own time. Nardini was followed in the 18th century by such writers as Ficoroni and Venuti; the most important works of this period were those produced by excavators such as Bianchini (*Il palazzo dei Cesari*, 1738), or independent students of the monuments such as Raphael Fabretti (*De Columna Trajana*, 1683; *De Aquis et Aequeductibus*, 1680). In the 18th century Winckelmann revived interest in ancient, including Roman, art (especially by his *Geschichte der Kunst des Alterthums*, 1764), and the excavations of the Forum, under the direction of systematic and scientific excavation, especially in the Forum. In 1829 there was founded the international *Istituto di Corrispondenza Archeologica* (which in 1874 became the *Kaiserlich deutsches archäologisches Institut*); in 1830-42 was issued the *Beschreibung der Stadt Rom*, by Bunsen and others, in which the grosser errors which had passed current since Nardini's time were corrected. To the same period belong the magnificently illustrated works of Luigi Canina (*Indicazione di Roma antica*, 1830; *Esposizione topografica*, 1842; *Architettura antica*, 1834-44; *Foro Romano*, 1845; *Edifizi di Roma antica*, 1846), and C. Feilich, who distinguished himself by his accuracy and the imaginative character of the restorations.

The books on Roman topography written in the early 19th century, such as those of Antonio Nibby, still pursued the uncritical methods of Nardini; from 1830 onwards, however, we find a series of writers whose work shows the influence of the new criticism. Such were Becker (*Topographie der Stadt Rom*, 1843), Sir Wm. Gell (*Rome and its Vicinity*, 1824; rev. ed. E. H. Bunbury, 1826), Braun (*Ruinen und Museen Roms*, 1854), Reber (*Die Ruinen Roms*, 1862) and T. H. Dyer (*The City of Rome*, 1864).

Since 1861, when excavations were begun on the Palatine at the instance of Napoleon III., under the direction of P. Rosa, the discovery of ancient remains has made constant progress, and the results have been incorporated in a number of works, of which only the most important can be named here. These are: Jordan, *Topographie der Stadt Rom im Alterthum*, of which three vols. (I, II, and III.) appeared in 1871-85, and a third (IV) was written after Jordan's death by C. Huelsen and published in 1907; Gilbert, *Geschichte und Topographie der Stadt Rom im Alterthum* (3 vols., 1883-90); the works of Lanciani, especially *Ruins and Excavations in Ancient Rome* (1897) and *Storia di Scavi* (in progress); O. Richter, *Topographie der Stadt Rom* (2 vols., 1891); Middleton, *The Remains of Ancient Rome* (2 vols., 1892). A short handbook may be found in S. B. Platner's *Topography and Monuments of Ancient Rome* (Boston, 1904). For the study of recent discoveries (besides the special works referred to in the course of this article) the following periodicals are the most important:—*Notizie degli Scavi*, published by the Accademia dei Lincei since 1876; *Bullettino della Commissione Archeologica comunale di Roma* (from 1872); *Mittheilungen des h. deutschen archäologischen Instituts*

¹ Cf. Procop. *Bell. Goth.* i. 23.

² On the walls of Aurelian, see (in addition to the general works mentioned in the bibliography) Nibby and Gell, *Le Mura di Roma* (1820); Quarenghi, *Le Mura di Roma* (1880); and especially Homo, *Essai sur le régime de l'empereur Aurélien* (Paris, 1904), IV.^o partie, ch. ii., "L'Encinte de Rome."

(from 1886); *Papers of the British School at Rome* (from 1903). Brief reports of discoveries are published by Dr T. Ashby in the *Classical Review*.

All previous archaeological maps of Rome have been superseded by Lanciani's *Formae urbis Romae*, in 46 sheets (Milan, 1893-1902). The best recent maps are those in Kiepert's *Formae orbis antiqui*, sheets 21 and 22. Kiepert and Huelsen's *Formae urbis Romae antiquae* date from 1896; they are accompanied by a *Nomenclator topographicus*. Homo, *Lexique de topographie romaine* (1900), is also useful. (J. H. M.; H. S. J.)

CHRISTIAN ROME

From the 4th to the 12th Century

The era of church building in Rome may be said to begin with the reign of Constantine and the peace of the church. Before then Christian worship was conducted with various degrees of secrecy either in private houses or in the catacombs (*q.v.*), according as the reigning emperor viewed the sect with tolerance or dislike. The type of church which in the beginning of the 4th century was adopted with certain modifications from the pagan basilica, though varying much in size, had little or no variety in its general form and arrangement. One fixed model was strictly adhered to for many centuries, and, in spite of numberless alterations and additions, can be traced in nearly all the ancient churches of Rome. It is fully described and illustrated in the article *BASILICA*.

The walls of these early churches were mostly built of concrete, faced with brick, left structurally quite plain, and decorated only with painted stucco or glass mosaics—especially (internally) in the apse and on the face of its arch, and (externally)

Construction

on the east or entrance wall, the top of which was often built on an overhanging cornice to keep off the rain. The windows were plain, with semicircular arches, and were filled with pierced marble screens, or in some cases with slabs of translucent alabaster; the latter was the case at S. Lorenzo fuori le Mura, and examples of the former still exist in the very early church formed in the rooms of some *thermae* on the Esquiline (possibly those of Trajan), about the 6th-century church of S. Martino ai Monti. Almost the only bit of external architectural ornament was the eaves cornice, frequently (as at the last-named church) formed of marble cornices stolen from earlier classical buildings. Internally the nave columns, and their capitals and bases, were usually taken from some classical building, and some churches are perfect museums of fine sculptured capitals and rich marble shafts of every material and design.¹ At first the nave had no arches, the columns supporting a horizontal entablature, as in old St Peter's, S. Clemente, and S. Maria Maggiore, but afterwards, in order to widen the intercolumniation, simple round arches of narrow span were introduced, thus requiring fewer columns. The roof was of the simple tie-beam and kingpost construction, left open, but decorated with painting or metal plates. The floor was paved either with coarse mosaic of large tesserae (as at S. Pudenziana) or with slabs of marble stripped from ancient buildings. A later development of this plan added a small apse containing an altar at the end of each aisle, as in S. Maria in Cosmedin and S. Pietro in Vincoli.²

The type of church above described was used as a model for far the majority of early churches not only in Rome, but also in

England, France, Germany, and other Western countries. Another form was, however, occasionally used in Rome, which appears to have been derived from the round temple of pagan times. This is a circular building, usually domed and surrounded with one or more rings of pillared aisles. To this class belong the combined church and mausoleum of Costanza (see fig. 14) and that of SS. Marcellinus and Petrus, both built by Constantine, the former to hold the tomb of his daughters Constantia (or Constantina) and Helena, the latter that of his mother Helena. The latter is on the Via Labicana, about 2 m. outside Rome; it is a circular domed building, now known as the Torre Pignatelli, from the *pignatelli* or amphorae built into the concrete dome to lighten it. The mausoleum of S. Costanza, close by S. Agnese fuori, is also domed, with circular aisle, or rather ambulatory, the vault of the latter decorated with mosaic of classical style (see *MOSAIC*, vol. xviii. p. 885). The red porphyry sarcophagi, sculptured richly with reliefs, from these mausolea are now in the Vatican. On a much larger scale is the church of S. Stefano Rotondo on the Coelian, built by Pope Simplicius (468-482), with a double ring of pillared aisles the outer one of which was pulled down and a new enclosure wall built by Nicholas V. Other round churches are S. Teodoro (by the Vicus Tuscius), restored in the 8th century, and S. Bernardo, which

is one of the domed halls of Diocletian's *thermae*, consecrated as a church in 1598.

Space will not allow any individual description of the very numerous and important churches in Rome which are built on the basilican plan. The principal examples are these:—

S. Pudenziana, traditionally the oldest in Rome, restored in 398; S. Clemente, restored under Siricius (384-399), now forming the crypt of an upper church built in the 12th century; S. Sabina, 5th century; S. Vitale, 5th century, founded by Innocent I. (401-417); S. Martino ai Monti, c. 500; S. Balbina, 6th century; church of Ara Coeli, founded by Gregory the Great (590-604); as S. Maria in Capitolio; S. Giorgio in Velabro, rebuilt by Leo II. (682-683); S. Cesareo, 8th century; S. Maria in Via Lata, restored by Sergius I. (687-701); S. Crisogono, rebuilt in 731 by Gregory III.; S. Maria in Cosmedin; S. Pietro in Vincoli, and S. Giovanni ad Portam Latinam, rebuilt c. 772 by Adrian I.; S. Maria in Aradione, rebuilt by Paschal I. (817-824), who also rebuilt S. Cecilia in Trastevere and S. Prassede; S. Marco, rebuilt by Gregory IV. in 833; S. Maria Nuova, rebuilt by Nicholas I. (858-867), now called S. Francesca Romana; the church of the SS. Quattro Coronati, rebuilt by Paschal II. about 1113; and S. Maria in Trastevere, rebuilt by Innocent III. in 1130.

Though the apses and classical columns of the naves in these churches were built at the dates indicated, yet in many cases it is difficult to trace the existence of the ancient walls; the alterations and additions of many centuries have frequently almost wholly concealed the original structure. Except at S. Clemente, the early choir, placed as shown in fig. 26, has invariably been destroyed; the side walls have often been broken through by the addition of rows of chapels; and the whole church, both within and without, has been overlaid with the most inconspicuous architectural features in stucco and stone. The open roof is usually concealed either by a wooden panelled ceiling or by a stucco vault. The throne⁴ and marble benches in the apse have usually given place to more modern wooden fittings, to suit the later position of the choir, which has always been transferred from the nave to the apse. In many cases the mosaics of the apse and the columns of the nave are the only visible remains of the once simple and stately original church.⁵

From 1200 to 1450; and the Papal Palaces

The 10th and 11th centuries in Rome were extraordinarily barren in the production of all branches of the fine arts, even that of architecture; and it was not till the end of the 12th that any important revival began. The 13th century was, however, one of great artistic activity, when an immense number of beautiful works, especially in marble enriched with mosaic, were produced in Rome. This revival, though on different lines, was very similar to the rather later one which took place at Pisa (see *PISANO*), and, like that, was in great part due to the great artistic talents of one family,—the Cosmati,⁶ which, for four or five generations, produced skilful architects, sculptors and mosaicists.

Era of the Cosmati

¹ This list does not include the great basilicas of Rome, for which see *BASILICA*. On the churches of Rome see Armellini, *Le chiese di Roma* (2nd ed. 1891); Tucker and Malletson, *Handbook to Christian and Ecclesiastical Rome* (1900); Marucchi, *Basiliques et églises de Rome* (1902); Frothingham, *Monuments of Christian Rome* (1910).

² Some of these marble thrones which still exist are very interesting relics of Hellenic art, much resembling the existing seats in the theatre of Dionysius at Athens. Examples of these thrones exist at S. Pietro in Vincoli, S. Stefano Rotondo, and in the Lateran cloister.

³ The interior of S. Maria in Cosmedin has in recent years been restored according to primitive tradition.

⁴ On the Cosmati see Boito, *Architettura del Medio Evo* (Milan, 1880, pp. 117-182); Clausen, *Les Mosaïstes romains et le mobilier presbytéral* (Paris, 1897); Crowe and Cavalcaselle, *History of Painting in Italy* (ed. Douglas, 1903), ch. iii.

⁵ S. Lorenzo and S. Agnese fuori, S. Maria in Trastevere, Ara Coeli, and numberless other churches are very rich in this respect. ⁶ See Heinrich Holtzinger, *Die altchristliche Architektur* (Stuttgart, 1889-99); Dehio and von Bezold, *Die kirchliche Baukunst des Abendlandes* (Stuttgart, 1884-99).

The first member of the family of whom we have knowledge was Lorenzo, who, with his son Jacopo, made the ambones of S. Maria in Ara Coeli and an altar-canopy (ciborium) in SS. Apostoli. Jacopo decorated the door of S. Saba in 1205 and, together with his son Cosma (who gave his name to the family), that of S. Tommaso in Formis; the father and son worked together at Civita Castellana in 1210. Cosma made a ciborium for SS. Giovanni e Paolo in 1235, and worked with his sons Luca and Jacopo at Anagni and Subiaco during the first half of the 13th century. So far the inscriptions enable us to trace the relationships of the Cosmati with certainty; it is not so clear whether the Cosma above mentioned is to be identified with the master who decorated the chapel of the Sancta Sanctorum belonging to the old Lateran palace which was rebuilt by Nicholas III. (1277-1280). This Cosma was, however, almost certainly the father of Giovanni, the last of the family, who made the tombs of Cardinal Durand (died 1299) in S. Maria sopra Minerva, Cardinal Rodriguez in S. Maria Maggiore, and Stefano de' Surdi in S. Balbina. Another artist who seems to have belonged to this family, Deodato, made the ciboria of S. Maria in Cosmedin and (probably) of S. John Lateran; he is probably identical with the *Deodatus filius Cosmati* who, together with another Jacopo, executed a pavement at S. Jacopo alla Lungara. A large number of other works in the baldachin, but unfinished, exist in Rome. These are mainly altars and baldachini, choir-screens, paschal candlesticks, ambones, tombs, and the like, all enriched with sculpture and glass mosaic of great brilliance and decorative effect.

Besides the more mechanical sort of work, such as mosaic patterns and architectural decoration, they also produced mosaic pictures and sculpture of very high merit, especially the recumbent effigies, with angels standing at the head and foot, in the tombs of Ara Coeli, S. Maria Maggiore, and elsewhere. One of their finest works is in S. Cesareo; this is a marble altar richly decorated with mosaic in sculptured panels, and (below) two angels drawing back a curtain (all in marble) so as to expose the open grating of the confessional.

Besides the Cosmati, other artists, such as Paulus Romanus and his sons in the 12th century, and Petrus Vassallectus in the 13th, contributed to the revival of art. The beautiful cloister of S. Paolo fuori le Mura, begun by "Magister Petrus," and those of S. John Lateran, the work of Vassallectus, are the finest architectural works of this school. In the latter part of the 13th century we find the sculptor Arnolfo del Cambio at work in Rome. His altar-canopy at S. Paolo fuori le Mura (1285) seems to have been imitated by the Cosmati in their latest works; his tomb of Cardinal de Bray (d. 1282) at Orvieto also shows his intimate connexion with that school. Another artist of the same period, Petrus Oderisius, worked in England; the shrine of the Confessor at Westminster (1266) was made by him.

The earlier works of the Cosmati are Romanesque in style, but in the 13th century their art here produced, especially in the elaborate altar-canopies, with their geometrical tracery. In detail, however, they differ widely from the purer Gothic of northern countries. The richness of effect which the English or French architect obtained by elaborate and carefully worked mouldings was produced in Italy by the beauty of polished marbles and jewel-like mosaics,—the details being mostly rather coarse and often carelessly executed.

Chiefly to the 13th century belong the large number of beautiful campanili, which are the most conspicuous relics of the medieval period in Rome. The finest of these are attached to the churches of S. Francesca Romana, SS. Giovanni e Paolo, and S. Maria Maggiore. Others belong to the basilicas of S. Lorenzo fuori and S. Croce in Gerusalemme, and to S. Giorgio in Velabro, S. Maria in Cosmedin, S. Alessio, S. Giovanni ad Portam Latinam, S. Cecilia, S. Crisogono, and S. Pudentiana. They occupy various positions with regard to the church, being all later additions; that of SS. Giovanni e Paolo stands at some distance from it. In design they are very similar, consisting of many stages, divided by brick and marble cornices; in the upper storeys are from two to four windows on each side, with round arches supported on slender marble columns. They are decorated with brilliantly coloured *ciolele* or disks of earthenware, enamelled and painted in green or turquoise blue, among the earliest existing specimens of the so-called majolica (see CERAMICS). Sometimes disks or crosses made of red or green porphyry are inlaid in the walls. In most cases on one face of the top storey is a projecting canopied niche, which once contained a statue or mosaic picture. The walls are built of fine neat brickwork. The largest and once the handsomest of all, that of S. Maria Maggiore, has string-courses of enamelled and coloured terra-cotta. The slender columns of the windows

¹ This campanile was restored and enriched in 1376.

have often proved insufficient to support the weight, and so many of the arches are built up.²

Though but little used for churches, the Gothic style, in its modified Italian form, was almost universally employed for domestic architecture in Rome during the 13th and 14th centuries. Tufa³ or brick was used for the *Domestic architecture* main walls, the lowest storey being often supported on an arcade of pointed arches and marble columns. The windows were usually formed of large marble slabs with trefoil-shaped heads or cusped arches. As a rule the upper storeys projected slightly over the lower wall, and were supported on small ornamental machicolations. The top storey frequently had an open loggia, with rows of pointed arches. When vaulting was used it also was of the pointed form, usually in simple quadripartite bays, with slightly moulded groin-ribs. The finest existing specimen of this style is the palace built about 1300 by Boniface VIII. (Benedetto Gaetani), enclosing the tomb of Cecilia Metella on the Via Appia, with a graceful little chapel within the precincts of the castle. This building is well worthy of study; the remaining part is well preserved. Many houses of this period, though generally much injured by alterations, still exist in Rome. They are mostly in out-of-the-way alleys, and not being mentioned in any books, are seldom examined. The Ghetto (now destroyed) and the quarter near the Ponte Rotto contained many of these interesting buildings, as well as some of the most crowded parts of the Trastevere district, but most have disappeared owing to the wholesale destruction of old streets. Among those which may possibly escape for a while is the 13th-century house where Giulio Romano lived, near the Palazzo di Venezia, and the Albergo del Orso, at the end of the Via di Tordinona, of the same period, which was an inn in the 16th century and is one still; this has remains of a fine upper loggia, with rich cornices in moulded terra-cotta; the lowest storey has pointed vaulting resting on many pillars. Another graceful but less stately house exists, though sadly mutilated, opposite the entrance to the atrium of S. Cecilia in Trastevere.⁴ Few now remain of the once numerous lofty towers built by the turbulent Roman barons for purposes of defence. The finest, the Torre delle Milizie on the Viminal, was built in the 13th century by the sons of Petrus Alexius; of about the same date is the Torre dei Conti, near the forum of Augustus, built by Marchione of Arezzo; both these were once much higher than they are now; they are very simple and noble in design, with massive walls faced with neat brickwork.

Till the 14th century the Lateran was the usual residence of the pope; this was once a very extensive building, covering four times its present area. The original house is said to have belonged to the senator Plautius Lateranus in the reign of Nero; but the existing part on the line of the Aurelian wall is of the 3rd century. This house, which had become the property of the emperors, was given by Constantine as a residence for S. Sylvester; it was very much enlarged at many periods during the next ten centuries; in 1303 a great part was burnt, and in 1586 the ancient palace was completely destroyed by Sixtus V., and the present palace built by Domenico Fontana. The Cappella Sancta Sanctorum (see list of Cosmati works) is the only relic of the older palace.⁵

Lateran Palace.

² See De Montault, *Les Cloches de Rome* (Arras, 1874).

³ For many centuries wall-facing of small tufa stones was used, e.g. in the medieval part of the Capitol; this was called "opera saracinesca" from its supposed adoption from the Saracens; it is largely employed in the walls and towers of the Leonine city, built by Leo IV. (847-855) to defend the Vatican basilica and palace against the inroads of the Moslem invaders. The greater part of this wall is now destroyed and built over, but a long piece with massive circular towers well preserved exists in the gardens of the Vatican.

⁴ The house of Crescentius, popularly called the "house of Rienzi," near the Ponte Rotto, is perhaps the sole relic of the domestic architecture of an earlier period—the 12th century. Its architectural decorations are an extraordinary mixture of marble fragments of the most miscellaneous sort, all taken from classical buildings; it has an inscription over the doorway, from which we learn that it was the property of "Crescentius, son of Nicolaus."

⁵ See Rohault de Fleury, *Le Latran au moyen âge* (Paris, 1877).

The present palace has never been used as a papal residence; in the 18th century it was an orphan asylum, and is now a museum of classical sculpture and early Christian remains.

The Vatican palace originated in a residence built by Symmachus (498-514) adjoining the basilica of S. Peter. This was rebuilt by Innocent III. (c. 1200) and enlarged by Nicholas III. (1277-80). It did not, however, become the fixed residence of the popes till after the return from Avignon in 1377. In 1415 John XXIII. connected the Vatican and the castle of S. Angelo by a covered passage carried on arches. But little of the existing palace is older than the 15th century; Nicholas V. in 1447 began its reconstruction on a magnificent scale, and this was carried on by Sixtus IV. (Sixtine chapel), Alexander VI. (Torre Borgia), Julius II. and Leo X. (Bramante's cortile and Raphael's Loggie and Stanze), and Paul III. (Sala Regia and Cappella Paolina by Antonio da Sangallo). Sixtus V. and his successors built the lofty part of the palace on the east of Bramante's cortile. The Sala Regia was built by Bernini for Urban VIII. and Alexander VII., the Museo Pio-Clementino under Clement XIV. and Pius VI., the Braccio Nuovo under Pius VII., and lastly the grand stairs up to the cortile were added by Pius IX.¹

The Quirinal palace, now occupied by the king of Italy, is devoid of architectural merit. It stands on the highest part of the hill, near the site of the baths of Constantine.

The Quirinal. This palace was begun in 1574, under Gregory XIII., by Flaminio Ponzo, and was completed by Fontana and Maderna under subsequent popes.

The only important church in Rome which is wholly Gothic in style is S. Maria sopra Minerva, the chief church of the Dominican order. This was not the work of a Roman architect, but was designed by two Dominican friars from Florence—Fra Ristori and Fra Sisto—about 1289, who were also the architects of their own church of S. Maria Novella. It much resembles the contemporary churches of the same order in Florence, having wide-spanded pointed arches on clustered piers and simple quadripartite vaulting. Its details resemble the early French in character.² It contains a large number of fine tombs; among them that of Durandus, bishop of Mende (the author of the celebrated *Rationale divinarum officiorum*), by Giovanni Cosma, c. 1300, and the tomb of Fra Angelico, the great Dominican painter, who died in Rome, 1455. The most elaborate specimen of ecclesiastical Gothic in Rome is that part of S. Maria in Ara Coeli which was rebuilt about 1300, probably by one of the Cosmati, namely, the south aisle and transept. During the 14th century (chiefly owing to the absence of the popes at Avignon) the arts were neglected at Rome, and a period of decadence set in. The sculptured effigy and reredos of Cardinal Alençon (d. 1403) in S. Maria in Trastevere, executed by a certain Paulus Romanus, is a fair example of the works produced during this period; the effigy is a very clumsy and feeble copy of the fine recumbent figures of the Cosmati.

Florentine Period, c. 1450-1550.

The long period of almost complete artistic inactivity in Rome was broken in the 15th century by the introduction of a number of foreign artists, chiefly Florentines, who during this and the succeeding century enriched Rome with an immense number of magnificent works of art. The dawn of this brilliant epoch may be said to have begun with the arrival of Fra Angelico (see FIESOLE) in 1447, invited by Nicholas V. to paint the walls of his small private chapel in the Vatican dedicated to S. Lorenzo.

In the latter half of the 15th century a large number of sculptured tombs (as well as tabernacles, altar frontals, reredoses and the like) were made for Roman churches by sculptors from Tuscany and north Italy. The earliest of these tombs is that of Eugenius IV. (d. 1447) in S. Salvatore in Lauro, by Isaia da Pisa. It presents the typical form of a life-sized recumbent effigy resting on a richly ornamented sarcophagus over which is a canopy decorated with reliefs and statuettes. The type was brought to perfection by the Florentine Mino da Fiesole (see MINO DI GIOVANNI),

who worked in Rome under Pius II. and succeeding popes, being assisted in some cases by another artist of almost equal skill, Giovanni Dalmata. A Lombard sculptor, Andrea Bregno, came to Rome under Paul II. and worked there until the closing years of the century; his tomb is in S. Maria Sopra Minerva. The works of these artists and their followers are to be found in a great number of churches, notably S. Maria del Popolo.³

The architecture no less than the sculpture of the latter part of the 15th century was mainly the work of Florentines, especially of Baccio Pontelli, who is said by Vasari to have built S. Maria del Popolo, S. Agostino,⁴ and S. Cosimato in Trastevere. He also was the architect of S. Pietro in Montorio, erected in 1500 for Ferdinand and Isabella of Spain. Other buildings were carried out by another Florentine, Giuliano da Majano. The Palazzo di Venezia, begun for Cardinal Barbo, afterwards Paul II., about 1455, a very massive and stately building of medieval character, was built by Giuliano da Sangallo and Francesco di Borgo San Sepolcro.

During the latter part of the 15th and the first few years of the succeeding century Rome was enriched with a number of buildings by Bramante (q.v.), one of the greatest architects the world has ever seen. He combined the delicacy of detail and the graceful lightness of the Gothic style with the measured stateliness and rhythmical proportions of classic architecture. Though he invariably used the round arch and took his mouldings from antique sources, his beautiful cloisters and loggie are Gothic in their general conception. Moreover, he never committed the prevalent blunder of the 16th century, which was a fruitless attempt to obtain magnificence by mere size in a building, without multiplying its parts. His principal works in Rome are the Palazzo della Cancelleria, built for Cardinal Riario (1495-1505), with its stately church of S. Lorenzo in Damaso; the so-called Palazzo di Bramante in the Governo Vecchio, built in 1500; and the Palazzo Giraud, near St. Peter's, once the residence of Cardinal Wolsey, built in 1503. He also built the cortile of S. Damaso in the Vatican, the toy-like tempietto in the cloister of S. Pietro in Montorio (1502), and the cloisters of S. Maria della Pace (1504).⁵ In 1503 Bramante was appointed architect to St. Peter's, and made complete designs for it with a plan in the form of a Greek cross. The piers and arches of the central dome were the only parts completed at the time of his death in 1514, and subsequent architects did not carry out his design.⁶

Baldassare Peruzzi (q.v.) of Siena was one of the most talented architects of the first part of the 16th century; the Villa Farnesina and the Palazzo Massimo alle Colonne are from his designs. His later works bear traces of that decadence in taste which so soon began, owing mainly to the rapidly growing love for the dull magnificence of the pseudo-classic style. This falling off in architectural taste was due to Michelangelo (q.v.) more than to any other one man. His cortile of the Farnese palace, though a work of much stately beauty, was one of the first stages towards that lifeless scholasticism and blind following of antique forms which were the destruction of architecture as a real living art, and in the succeeding century produced so much that is almost brutal in its coarseness and neglect of all true canons of proportion and scale. During the earlier stage, however, of this decadence, and throughout the 16th century, a large number of fine palaces and churches were built in and near Rome by various able artists, such as the Villa Madama by Raphael, the Palazzo Farnese by Antonio da Sangallo the younger, S. Giovanni de' Fiorentini by J. Sansovino, and many others. (J. H. M.; H. S. J.)

LATER DEVELOPMENT

The transformation of Roman architecture after the 16th century was marked by the abandonment of classical models. The works of Michelangelo were too grand to be accused of exceeding the extreme limits of good taste, but his scholars and imitators exaggerated his manner, and the *barocco* (1890,

¹ On Mino da Fiesole, see Gnoli in *Archivio Storico dell'Arte* (1890-91); on Giovanni Dalmata, Fabriczy in *Jahrb. der preuss. Konsulatsmissionen* (1903); on Andrea Bregno, Stegmann in the same periodical, vol. xx.; many of the monuments are drawn in Tesi, *Raccolta di monumenti sacri e sepolcrali scolpiti a Roma* (1853).

² These two churches were the first in Rome built with domes after the classical period.

³ The upper storey of the latter is varied by having horizontal flutings instead of arches on the columns.

⁴ See Geymüller, *Projets primitifs pour le basilique de St Pierre à Rome* (Paris, 1875-85).

⁵ A valuable account of Raphael's architectural works is given by Geymüller, *Raffaello come Architetto* (Milan, 1882). Drawings of many of the finest palaces of Rome are given in the fine work by Letarouilly, *Édifices de Rome moderne* (Brussels, 1856-66).

¹ See Letarouilly, *Le Vatican et le basilique de St Pierre à Rome* (Paris, 1882).

² The absence of a triforium is one of the chief reasons why the large Gothic churches of Italy are so inferior in effect to the cathedrals of France and England.

which had its cradle in Rome, was soon adopted throughout Italy. Vignola (1563-1573) had done his best to bind the *part* of building to strictly classic rules, but in spite of his efforts the degeneration made progress during his own lifetime and under Carlo Maderna (1556-1630), and proceeded still more rapidly under Bernini (1598-1680). The characteristics of the *barocco* are the reckless abuse of curves and extravagantly broken lines, of contorted columns, twisted tympanums and highly exaggerated ornaments; yet we must confess that many monuments of this period of art exhibit such exuberant life, such contrasts of relief and shadow, and such a wonderful combination of variety and solidity as cannot fail to please the many, even now, by the magnificence of their general effect. In Rome, the numerous works of Bernini, Borromini, Maderna, Rainaldi, Salvi, Fuga, Longhi and others bear witness to the gifted activity of Italian architects during that period, if genius necessarily creates, those men showed more of it than their predecessors who adhered to the classic and revered the teachings of Vitruvius. Degeneration is tolerated and sometimes even pleases, under the name of transformation, but there is nothing to be said for the real decay which marks the 18th century. It was not universal at first, for it is by nature a slow process; such men as A. Gallei, Specchi, Peperelli, Marchionni, Morelli, Camporese and Piranesi left works not altogether without value; but the outrageous abuse of ornament increased with every year, and was made more and more evident by the clumsy heaviness of the pillars and pilasters that supported the whole. The refined purity of the Renaissance disappeared as completely as the delicate grace and exquisite ornamentation of the Cosmatesque period. Many works of the greatest beauty were destroyed outright, and many more were disfigured and often wholly hidden by horrible stucco constructions and decorations; or, on a larger scale, by the application of hideous stone façades to churches of which the simple good taste had delighted generations of mankind. The deformation of the noble old Lateran basilica is a conspicuous instance of such deeds; another is Santa Maria Maggiore, and the false fronts plastered upon San Marcello and Santa Maria in Via Lata, both in the Corso, give a very clear idea of what was generally done. The interiors of old churches suffered quite as much, and even the frescoes of early masters were not spared; those by Pinturicchio in the third chapel (south) of S. Maria del Popolo were covered with wretched stucco ornaments, only removed in 1850, and numberless works of art by Giotto and other early painters were wilfully destroyed.

The decline of architecture continued in the 19th century, notwithstanding the laudable efforts of Valadier and a few other painstaking imitators, who produced the so-called "academic neo-classic" reaction; among them may be noted the names of Canina, Poletti, Sarti and Azzurri. The futility of their works invited the feeble eclecticism which soon afterwards became so general that the architecture of the period is wholly without individuality, good or bad. The chief architectural work of the 19th century was the rebuilding of the great basilica of S. Paolo fuori le Mura, burnt in 1823, in a style of cold splendour which is anything but devotional in its general effect. The pillars are huge monoliths of grey granite from the Alps; the confesso and transepts are lined with rosso and verde antico from quarries then recently rediscovered in Greece, and with Egyptian alabaster and lapis lazuli and malachite adorn the bases of the columns round the high altar in lavish profusion. Thirty years were required for the rebuilding of the frigidly magnificent edifice, which was reconsecrated in 1854. The east façade displays a quantity of gaudy mosaics, and the projected quadriportico is wanting. The belfry is nothing but a steeple, and has an unfortunate resemblance to a lighthouse. In extenuation of the result it must be admitted that the original building had been totally destroyed by fire, but no such excuse can be found for the barbarous assault on Christian art which was perpetrated by Francesco Vespignani in the extension of the Lateran basilica.

This work was begun under Pius IX. and finished under Leo XIII.; it involved the destruction of the ancient tribune and its ambulatory, the only parts of the church which had so far escaped complete disfigurement, and the priceless mosaics (1290), among the most beautiful in Rome, were taken down and replaced in the new apse in a sadly mutilated and restored form. (For the interesting discoveries made in excavating for the new foundations, see *Ann. Ist.* 1877, p. 332.)

The Vatican contains the largest collection in the world of Greco-Roman and Roman sculpture, with a few specimens of true Hellenic art. It is also very rich in Greek vases and in objects from Etruscan tombs; this latter division is called the Museo Gregoriano. There is also an Egyptian museum which contains a few important curiosities. In the great library are preserved a number of early glass chalices and other rare objects from the catacombs, as well as many fine specimens of later Christian art—church plate and jewels. The picture gallery, though not as large as some of the private collections in Rome, contains few inferior pictures. The Lateran palace, still, like the Vatican, in the possession of the pope, contains a fine collection of classical sculpture, but is most remarkable as a museum of Christian antiquities. The two capitoline museums are very rich in classical sculpture, bronzes, coins, pottery and the contents of many Etruscan tombs; the latter division has been added, and is filled with sculptures found in Rome since 1870, of which the arrangement was completed on the occasion of King Edward VII.'s visit. The picture gallery contains a few masterpieces and a large number of inferior works. The new Museo delle Terme has been formed in the great cloister of S. Maria degli Angeli, to hold the numerous fine examples of classical painting and sculpture found along the Tiber during the excavations for the new embankment, and in other places in Rome. The university of Rome possesses fine collections of minerals, fossils and other geological specimens, and examples of ancient marbles used in the buildings of Rome. A Museo Artistico Industriale has been formed in a monastery in the Capo le Case, to contain medieval works of art. It is, however, a matter for regret that the few medieval works which Rome possesses should be scattered in three small collections, namely, the one last mentioned, the Capitol and the Castle of S. Angelo, where an attempt is being made to form a real medieval museum; many objects, too, are dispersed throughout the city, and will doubtless disappear unless they are better protected. The Museo Kircheriano contains an unrivalled collection of prehistoric objects of stone, bronze, iron and pottery, found in Italy and the Italian islands, and more particularly a number of ancient Latian urns, *capanne* and the like. The collection of *aes grave* is the finest yet made; and the museum also contains a large quantity of interesting classical antiquities of various kinds. Another branch is the Ethnological Museum. Unfortunately all these museums are badly adapted for purposes of study, being neither well arranged nor well catalogued. The Museo Barocco, presented to the city in 1905 by the senator of that name, contains some ancient sculptures of great value. The Museum of Etruscan and Faliscan antiquities in the Villa Giulia, near Porta del Popolo, is of considerable importance, as is also the Borgia Museum in the Propaganda palace, the latter for its ancient geographical curiosities. The museum of plaster casts in the Testaccio quarter contains reproductions of the principal ancient sculptures possessed by foreign museums.

Among the private collections of pictures the Borghese is unrivalled in Italy, and among the largest in the world. The Borghese, which, however, like most Italian collections, contains a large proportion of very inferior works. The Corsini picture gallery, bought by the government, is chiefly rich in the works of the Bolognese and other third-rate painters, but also possesses a fine collection of engravings and etchings. There are a few fine paintings in the Barberini palace, but the Sciarra gallery no longer exists. There are some good pictures by Raphael and Guido Reni in the Academy of St. Luke; the Galleria d'Arte Moderna is a collection of modern paintings acquired by the government.

The largest private collection of sculpture is that of the Villa Albani, which, among a large mass of inferior Roman sculpture, contains a few gems of Greek art. The original Albani collection was stolen and brought to Paris by Napoleon I., and was there dispersed; one relief, the celebrated Antinous, is the only piece of sculpture from the original collection which was sent back from Paris. This is in the collection of Prince Torlonia, which contains several very fine works, but unfortunately the greater number are much injured and falsified by restorations. The casino in the Borghese gardens possesses a great quantity of sculpture, mostly third-rate Roman works, the most important of which, however, are executed in precious marbles. The small collection which formerly existed in the Villa Ludovici has been bought by the government, and the Museo del Termese; it contained a few works of Greek sculpture of great value, the most important being the Pergamean group representing the suicide of a Gaulish chief, a Medusa's head in relief and a male terminal figure. The

Galleries and collections.

Private collections.

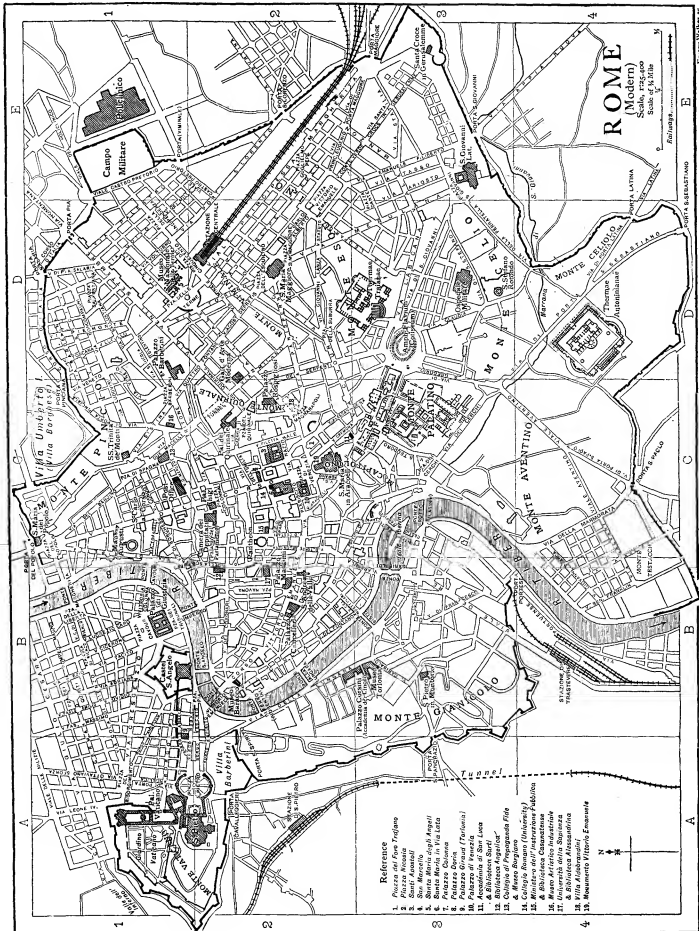

ROME
(Modern)
Scale, 1:125,000
Scale of 1/4 Mile

Reference

1. Piazza del Foro Traiano
2. Piazza Navona
3. Santi Apostoli
4. S. Maria degli Angeli
5. S. Maria della Vittoria
6. S. Maria della Pace
7. Palazzo Barberini
8. Palazzo Braschi
9. Palazzo di Venezia
10. Palazzo di Giustiniani
11. Palazzo di Farnesina
12. Biblioteca Angelica
13. Biblioteca Apostolica Vaticana
14. Collegio Romano (University)
15. Ministero dell'Interno
16. Biblioteca Capitolina
17. Università di Roma
18. Università di Scienze
19. Università di Lettere e Scienze
20. Università di Medicina
21. Università di Farmacia
22. Università di Veterinaria
23. Università di Scienze Politiche
24. Università di Scienze Matematiche e Fisiche
25. Università di Scienze Lettere e Filosofia
26. Università di Scienze Giuridiche
27. Università di Scienze Economiche e Commerciali
28. Università di Scienze Sociali
29. Università di Scienze Storiche e Lettere
30. Università di Scienze Religiose
31. Università di Scienze Filosofiche
32. Università di Scienze Lettere e Lettere Moderne
33. Università di Scienze Lettere e Lettere Moderne
34. Università di Scienze Lettere e Lettere Moderne
35. Università di Scienze Lettere e Lettere Moderne
36. Università di Scienze Lettere e Lettere Moderne
37. Università di Scienze Lettere e Lettere Moderne
38. Università di Scienze Lettere e Lettere Moderne
39. Università di Scienze Lettere e Lettere Moderne
40. Università di Scienze Lettere e Lettere Moderne
41. Università di Scienze Lettere e Lettere Moderne
42. Università di Scienze Lettere e Lettere Moderne
43. Università di Scienze Lettere e Lettere Moderne
44. Università di Scienze Lettere e Lettere Moderne
45. Università di Scienze Lettere e Lettere Moderne
46. Università di Scienze Lettere e Lettere Moderne
47. Università di Scienze Lettere e Lettere Moderne
48. Università di Scienze Lettere e Lettere Moderne
49. Università di Scienze Lettere e Lettere Moderne
50. Università di Scienze Lettere e Lettere Moderne



Giustiniani collection, which was considerable, is now dispersed, but many private residences, such as the Colonna palace, still contain collections of sculpture and painting of a secondary order.

The principal libraries in Rome are, for old and modern works, the Biblioteca Vittorio Emanuele and the library of the German *Libraries*. Archaeological Institute; for manuscripts and early and the Angelica, the Casanatense, the Alessandrina and the Chigi libraries; but none of them can be compared with that of the Vatican, which now contains also the former library of the Barberini. Mention must also be made of the Corsiniana, now belonging to the Accademia dei Lincei. The Biblioteca Sarti, beside the Academy of S. Luke, contains works on art.

THE MODERN CITY

Great changes in the municipal and social conditions of Rome followed the occupation of the city by the Italians (20th September 1870), and the rapid increase of population due to immigration from other parts of Italy. It is a mistake, however, to attribute all the works undertaken and executed since 1870 to the initiative of the new government. The first plan for modernizing and improving Rome was that of Pope Julius II., who aimed at the enlargement of the lower city on both sides of the Tiber. The modern Via Giulia shows in part what he meant to do. Following him, Sixtus V. did his best to develop the upper part of the city by laying out the Via Sistina, from the Trinità dei Monti to S. Maria Maggiore and Porta S. Giovanni. Almost in our own time a plan for the improvement of the city was made, under the direction of Mgr. de Merode, during the reign of Pius IX.; and although but a small portion of the projected changes were carried out under the pope, the general scheme was in most respects satisfactory, and proved a good foundation for further extensive developments. He was able to complete the construction of the beautiful ascent to S. Pietro in Montorio, as well as that which leads up to the Quirinal Palace; and the Via Nazionale, which was to have been called Via De Merode, was also begun. His plan did not include, however, the destruction of villas such as the Ludovisi, nor the wholesale removal of trees, which is so greatly to be deplored. These acts of barbarism were the consequences of the reckless speculations in land and buildings that accompanied and followed the active and excellent work done by the municipality, and might have been checked by vigorous and timely action of the government. As it was, a number of the most important Roman families were ruined. At the outset, and as soon as political circumstances admitted the consideration of such matters, the municipality set to work; and though a comprehensible love of the picturesque has caused many persons to regret the result, altogether or in part, it is not to be denied that the improvements carried out have been of the highest advantage to the city, and that the work is in many instances of creditable solidity.

Two principal problems presented themselves. The more important was the confinement of the Tiber in such a manner as to render impossible the serious floods which had from time to time inundated the city, often causing great damage to property and rendering the lower streets more or less impassable. There were floods which almost reached the level of the first storey near San Carlo in the Corso, and it was common to see the great Piazza Navona and the neighbourhood of the Pantheon full of water for days together during the winter. The interruption of traffic can be imagined, and the damage to property was serious. The other urgent matter was one of which the government of Pius IX. had been partially aware, namely, the necessity for opening better thoroughfares between different parts of the city. In the middle ages the population of Rome had dwindled to twenty or thirty thousand inhabitants, who lived huddled together about the strongholds of the barons, and the modern city had slowly grown again upon the exiguous foundation of a medieval town. The need for changing this condition of things, which had been felt under Pius IX., became overwhelmingly apparent as the population rapidly increased. That which under a continuance of the old government might have been done by degrees during a long period, had to be accomplished in the shortest possible time, with means which,

though considerable, were far from adequate, and in the face of opposition by many holders of real estate, the most important of whom were conservatively attached to the papal government, and resisted change for no other reason. In what was now done it is necessary to distinguish clearly between the work undertaken and carried out by the municipality, under considerable pressure of circumstances, and that which was done in the way of private speculation. The first was in the whole good, and has proved enduring; the second was in many cases bad, and resulted in great loss. As soon as the opening of such streets as the Via Nazionale and the Via Cavour, the widening and straightening of the Via dell' Angelo Custode, now the Via del Tritone Nuovo, and similar improvements, such as the construction of new bridges over the Tiber, had demonstrated that the value of property could be doubled and quadrupled in a short time, and as soon as the increase of population had caused a general rise in rents, owners of property awoke to the situation of affairs, and became as anxious as they had at first been disinclined to improve their estates by wholesale building.

The most important and expensive work executed by the government with the assistance of the municipality was the construction of the embankments along the Tiber. Though damaged by the great flood of December 1900, their truly Roman solidity saved the city from the disastrous consequences of a wide inundation. It is impossible not to admire them, and not to feel respect for a people able to carry out such a plan in such a manner and in so short a time, in the face of such great difficulties. But so far as the life of the city was concerned, the cutting of new streets and the widening of old ones produced a more apparent immediate result. The opening of such a thoroughfare as the Via Nazionale could not but prove to be of the greatest value. It begins at the Piazza delle Terme, in which the principal railway station is situated, and connects the upper part of the city by a broad straight road, and then, by easy gradients, with the Forum of Trajan, the Piazza dei Santi Apostoli and the Piazza di Venezia, whence, as the Corso Vittorio Emanuele, it runs through the heart of the old city, being designed to reach St Peter's by a new bridge of the same name, near the bridge of S. Angelo. It is true that, in order to accomplish this, the Villa Aldobrandini had to be partially destroyed, but this is almost the only point which lovers of beauty can regret, and in compensation it opened to full view the famous palace of the Massimo family, the imposing church of S. Andrea della Valle, and the noble pile of the Cancelleria, one of the best pieces of architecture in Rome. Another great artery is the Via Cavour, which was intended to connect the railway station with the south-western part of Rome, descending to the Forum, and thence turning northwards to reach the Piazza di Venezia on the east side of the monument to Victor Emanuel II. These are only examples of what was done, for it would be impossible to give a just idea of the transformation of the city. Rome is now divided clearly into two parts, the old and the new, of which the old is incomparably the more artistic and the more beautiful, as it will always remain the more interesting. Among the works carried out by the government and municipality the fine tunnel under the Quirinal Hill (completed in 1902) deserves mention; it forms a connecting channel for the traffic between the streets at the north end of the old city, the Corso, Babuino, &c., and the upper part of Rome, including the Via Nazionale and the Esquilina. Another difficult undertaking, successfully completed in April 1908, was the construction of the enormous causeway and bridge which now unite the Pincio with the Villa Borghese, or, as it is now called, the Villa Umberto Primo, to the immense advantage of the public. In the same year the building for the new law courts was finished; it stands near S. Angelo, and presents, on the whole, an imposing appearance, though overloaded with clumsy stone ornamentation.

It is unnecessary to mention a number of public buildings and government offices which have little architectural merit, but we cannot overlook such a magnificent group of buildings devoted to scientific purposes as the Policlinico, on the Macas, which is admittedly one of the finest hospitals in Europe, and the military

hospital on the Coelian. The rebuilding of the Palazzo del Parlamento is only second to the enormous monument of Victor Emanuel II. The majority of the buildings erected by individuals and corporations since 1870 present no original or characteristic features, and the best of them are copies or imitations of well-known models. The Cassa del Risparmio, in the Corso, reproduces a Florentine palace; the Palazzo Negroni, near the Piazza Nicotia, is modelled on the Cancelleria and the Palazzo Giraud; many of the large residences in the new quarters beyond the Tiber are fairly good copies of palaces in the Florentine style, though the magnificent carved stone of earlier centuries is disadvantageously replaced by stucco, a material which lasts tolerably well in the mild climate of Rome. Opposite the beautiful and severe Palazzo di Venezia, what might have been a faultless reproduction of it is marred by tasteless ornament. Finally, so far as the construction of new streets is concerned, which lovers of the picturesque so greatly deplore, it must be admitted that they have been rendered necessary by the great increase of traffic and population, and it should be remembered that after the 16th century the wisest of the popes did their best to open up the city by widening and straightening the thoroughfares.

Municipal Administration.—After the taking of Rome, those persons who remained loyal to Pius IX. took no part whatever in public affairs, and the municipal administration was entirely in the hands of the monarchists. The expression "né eletti né elettori," meaning that Catholics are to be neither voters nor candidates, which came to be regarded as a sort of rule of the party, was invented at that time by an epigrammatic journalist, and it seems at first to have been applied also to municipal matters, whereas it was later understood to refer only to parliamentary elections. Leo XIII. encouraged the formation of a Catholic party in the municipal administration, and the municipal government drifted largely into the hands of Catholics, though circumstances make it necessary that the Syndic (Mayor) should always be a royalist. Between 1870 and the end of the century the socialist party had no great influence in Rome, which can never be a city of manufacturing interests. For purposes of municipal government the division of the city into districts has been modified, but the old division into fourteen *rioni* is adhered to in principle, the new quarters of Castro Pretorio and the Esquilina having been included in the first *Rione*, which still bears the name of "Monti." The municipality consists of a mayor and eighty communal councillors, of whom a large proportion were for many years members of the aristocracy. Later, however, the three democratic parties, known as the monarchist, socialist and republican, united to form a popular coalition, and succeeded in completely excluding the conservative, aristocratic and Catholic elements.

Population.—The population in 1870 was 226,022, as against 462,743 in 1901 (communal population). It therefore more than doubled in thirty years. The increase, however, did not take place at a regular rate, owing to the changes in the rates of immigration and emigration. The largest increase was in 1870, reaching 22,186; the next most important in 1884, 1885, 1886, 1887, in which years it constantly remained near 20,000. The least increase in later years was 4417 in 1891. The garrison of Rome is about 10,000 men. Careful inquiry has placed it beyond doubt that there are in Rome about the same number of ecclesiastics of all orders, including about 1500 students in the theological seminaries. The average birth-rate is lower in Rome than in the majority of great cities. The number of births increased after 1870 very nearly in proportion with the increase of population.

Climate and Hygiene.—The climate of Rome is mild and sunny, but the variation in temperature between day and night is very great. December and February appear to be the coldest months, the thermometer then averaging 47° F.; the greatest heat, which averages 75°, is felt in July and August. The surrounding Campagna is still not all habitable during the summer, though the dangerous malaria has been checked by the planting of numerous eucalyptus trees. A remarkable instance of the

effect produced upon the marshy soil by these plantations may be studied at the Trappist monastery of the Tre Fontane, situated on the Via Ardeatina, about 4 m. from Rome. Whereas in former times it was almost always fatal to spend the whole summer there, the monks have so far dried the soil by means of the eucalyptus that they reside in the monastery throughout the year. The municipality has everywhere made strenuous efforts to reduce the mortality due to malaria; in 1890, 14% of all the deaths in Rome and the Campagna were attributed to this cause; in 1905 the proportion had dropped to 3%. Very large sums have been expended in a scientific system of drainage and sub-drainage on both sides of the Tiber, and the use of wire gauze mosquito nets for the doors and windows of the humblest habitations in the Campagna has contributed much to the present satisfactory result. The hygienic conditions of Rome itself have greatly improved, largely through the ceaseless efforts of Commendatore Bacelli, a distinguished man of science, who repeatedly held office in the Italian Ministry. The publication of exceedingly accurate graphic tables in February 1900 shows the following facts. Ninety per 1000 deaths occurred in 1871 from typhoid (the so-called "Roman fever"), and the average has now fallen to a low constant. Deaths from small-pox, formerly of alarming frequency, can be said not to occur at all, and their numbers diminished suddenly after the introduction of compulsory vaccination.

Charities and Education.—A great number of small charitable institutions for children and old people have been founded, which are organized on the most modern principles, and in many of these charitable persons of the upper classes give their individual assistance to the poor. There are also private hospitals for diseases of the eye, in which poor patients are lodged and treated without payment. There are two hospitals entirely maintained by private resources, where infants are treated whose mothers fear to send them to a public hospital, or in cases refused by the latter as not being serious enough for admission. Of course, the numbers of the poor greatly increased with the growth of population, especially after the failure of building speculations between 1888 and 1890, though great efforts were made by the municipality to send all persons then thrown out of employment back to their homes. One of the difficulties under which Rome labours is that while it attracts the population of the country, as other capitals do, it possesses no great mechanical industries in which the newcomers can be employed. Efforts to create small industries in the populous quarters of the poor met with little success. Before 1870 a society was formed, which has since greatly developed as an intelligent private enterprise, to provide the poor with sanitary tenements; but its success is much hampered by the absence of employment, which again is partly due to the heavy taxation of small industries. A number of trade schools are also maintained by private funds, such as the Istituto degli Artigianelli, managed by the Fratelli della Dottrina Cristiana, and the Ricovero per fanciulli abbandonati (home for friendless children), which is under lay management and has flourishing workshops. The character of official charities has certainly improved in principle, so far as their educational and moral scope are concerned; for whereas in former times the limited number of the poor made individual and almost paternal relief possible, that form of charity had a pauperizing influence. If anything, the present tendency is to go too far in the opposite direction, and to require too many formalities before any relief is granted, and while the union of the principal charities under a central management on advanced theories improved the methods of administration, it destroyed numerous small sources of immediate relief on which the poor had a traditional right to count, and was in that way productive of hardship. At the same time, however, mutual benefit societies (*società di mutuo soccorso*) have been organized in great numbers by the different crafts and professions, and are chiefly distinguishable by the political parties to which they belong. It is characteristic of the modern Roman people that the most widely different elements subsist without showing any signs of amalgamating, yet without attacking each other. Some of these societies have an exclusively clerical character, others are merely conservative, some consist of monarchists, and some of avowed republicans.

Popular education is principally in the hands of the municipality, but besides the public schools there are numerous religious institutions attended by the children of the lower classes; they follow the curriculum prescribed by the government, and are under the constant supervision of municipal inspectors, both as regards their teaching and their hygiene. The pope also expends large sums in the maintenance of the people's schools, managed entirely by laymen, and also under government inspection. For education of the higher grade, besides the regular lycées and gymnasiums, there are many private schools similarly designated from which pupils can present themselves for the regular government examinations,

the privilege of conferring certificates and degrees having been allowed only to very few private institutions.

Society.—After 1870 both the aristocracy and the middle classes were divided into hostile factions, each of which maintained a press of its own and rallied round representative individuals. So far as the middle classes were concerned, the common interest of commercial operations soon concentrated political differences. The aristocracy, however, kept rigidly aloof from all speculations for a time, and maintained its traditional attitude of contemptuous superiority, to which the middle class answered with its profound hatred. This state of things lasted about ten years, until the time of the great building speculations, in which a number of noble families were tempted, and in which they soon found themselves hopelessly involved, and brought into close contact with the middle class. The two classes thus became necessary to each other, and the result was a notable and salutary diminution of prejudice, soon leading to alliances by marriage, which would formerly have seemed impossible, but which the redistribution of wealth rendered mutually advantageous. The appearance at social gatherings of an official element, almost exclusively taken from the middle class, also tended to reduce inequalities of caste. Yet it must be admitted that the parties composing the Roman society were drawn together mechanically, rather than fused into anything really homogeneous. It is worth mentioning that the Jewish element, which is very strong in business, in journalism, and in the administrations, had made no attempt to enter Roman society. Rome and Genoa are practically the only Italian cities in which Israelites are rigidly excluded from social intimacy, and are only met on official occasions. (M. C.R.)

ANCIENT HISTORY

I. *The Beginnings of Rome and the Monarchy.*

Both the city and the state of Rome are represented in tradition as having been gradually formed by the fusion of separate communities. The original settlement of Romulus is said to have been limited to the Palatine Mount. With this were united before the end of his reign the Capitoline and the Quirinal; Tullus Hostilius added the Caelian, Ancus Martius the Aventine; and finally Servius Tullius included the Esquiline and Viminal, and enclosed the whole seven hills with a stone wall. The growth of the state closely followed that of the city. To the original Romans on the Palatine were added successively the Sabine followers of King Tatius, Albans transplanted by Tullus, Latins by Ancus, and lastly the Etruscan comrades of Caelus Vibenna. This tradition is supported by other and more positive evidence. The race of the Luperici on February 15 was in fact a purification of the boundaries of the "ancient Palatine town," the "square Rome" of Ennius;¹ and the course taken is that described by Tacitus as the "pomeroium" of the city founded by Romulus.² On the Esquiline, Varro mentions an "ancient city" and an "earthen rampart,"³ and the festival of the Septimontium is evidence of a union between this settlement and that on the Palatine.⁴ The fusion of these "Mounts" with a settlement on the Quirinal "Hill" is also attested by trustworthy evidence;⁵ and in particular the line taken by the procession of the Argei represents the enlarged boundaries of these united communities.⁶ Lastly, the Servian agger still remains as a witness to the final enclosure of the various settlements within a single ring-wall. The united community thus formed was largely of Latin descent. Indications of this are not wanting even in the traditions themselves: King Faunus, who rules the Aborigines on the Palatine, is Latin; "Latini" is the name ascribed to the united Aborigines and Trojans; the immediate progenitors of Rome are the Latin Lavinius and the Latin Alba. Much evidence in the language, the religion, the institutions and the civilization of early Rome points to the same conclusion. The speech of the Romans is from the first Latin,⁷ though showing many traces of contact

with the neighbouring dialects of the Sabines and Volscians and also of Etruscans; the oldest gods of Rome—Saturn, Jupiter, Juno, Diana—are all Latin; "rex," "praetor," "dictator," "curia," are Latin titles and institutions.⁸ The primitive settlements, with their earthen ramparts and wooden palisades planted upon them out of reach both of human foes and of the malaria of the swampy low grounds, are only typical of the mode of settlement which the conditions of life dictated throughout the Latian plain.⁹ But tradition insists on the admixture of at least two non-Latin elements, a Sabine and an Etruscan. The question as regards the latter will be more fully discussed hereafter; it is enough to say here that while the evidence of nomenclature (Schulze, *Geschichte der Lat. Eigennamen*, Leipzig, 1904, p. 579, with the modifications suggested in the *Classical Review*, December 1907) shows that many Etruscan gentes were settled within the bounds of the early city, there is no satisfactory evidence that there was any large Etruscan strain in the Roman blood.¹⁰ With the Sabines it is otherwise. The Sabine union of the Palatine and Quirinal settlements which constituted so decisive a stage in the growth of Rome is represented as having been in reality a union of the original Latins with a band of Sabine invaders who had seized and held not only the Quirinal Hill, but the northern and nearest peak of the Capitoline Mount. The tradition was evidently deeply rooted. The name of the god *Quirinus*, from which that of the Quirinal Hill itself presumably sprang, was popularly connected with the Sabine town of Cures.¹¹ The ancient worship connected with it were said to be Sabine.¹² One of the three old tribes, the *Tities*, was believed to represent the Sabine element;¹³ the second and the fourth kings are both of Sabine descent. By the great majority of modern writers the substance of the tradition, the fusion of a body of Sabine invaders with the original Latins, is accepted as historical; and even Mommsen allowed its possibility, though he threw back the time of its occurrence to an earlier period than that of the union of the two settlements.¹⁴ We cannot here enter into the question at length, but some fairly certain points may be mentioned. The probability of Sabine raids and a Sabine settlement, possibly on the Quirinal Hill, in very early times may be admitted. The incursions of the highland Apennine tribes into the lowlands fill a large place in early Italian history. The Latins were said to have originally descended from the mountain glens near Reate.¹⁵ The invasions of Campania and of Magna Graecia by Sabine (more correctly Sabinæ) tribes are matter of history (see *SAMNITES*), and the Sabines themselves are represented as a restless highland people, ever seeking new homes in richer lands.¹⁶ In very early days they appear on the borders of Latium, in close proximity to Rome, and Sabine forays are familiar and frequent occurrences in the old legends. But beyond these general considerations recent inquiry enables us to advance to some few definite conclusions. (1) It may now be regarded as established beyond question that the patrician class at Rome sprang from a race other than that of the plebeians.

¹ The title "rex" occurs on inscriptions at Lanuvium, Tusculum; Bovillae; Henzen, *Bullettino dell'Inst.* (1868), p. 159; Orelli, 2279; *Corp. I. Lat. vi.*, 2125. For "dictator" and "praetor," see Livy i. 23, viii. 3, cf. Marquardt, *Röm. Staatsverwaltung*, i. 475; for "curia," Serv. on *Aen.* i. 17; Marquardt i. 467.

² B. Modestov, *Introduction à l'histoire romaine* (translated from the Russian by M. Delines), Paris, 1907, surpasses other authorities such as Helbig, *Die Italiker in d. Poebene*; Pohlmann, *Anfänge Roms*, 40; Abeken, *Mittel-Italien*, 61 seq.

³ The existence of a Tuscan quarter (*Tuscan vicus*) in early Rome may point to nothing more than the presence in Rome of Etruscan artisans and craftsmen. But see ETRURIA, § Language.

⁴ Varro, *L.L.* v. 51.

⁵ Ibid. v. 74; Schwieger i. 248 seq. ⁶ Ibid. v. 55; Livy i. 13. ⁷ Mommsen, *R.G.* i. 43, 44, 45, 46, 47, 48; accepted the tradition of a Sabine settlement on the Quirinal, and considered that in the united state the Sabine element predominated. Volquardsen (*Rhein. Mus.* xxxiii. 5159) believed in a complete Sabine conquest; and so did Zöllner (*Latium u. Rom*, Leipzig, 1878), who, however, placed it after the expulsion of the Tarquins.

⁸ Cato ap. Dionys. ii. 48, 49.

⁹ Ibid. ii. 48, 49. For the institution of the "ver sacrum" see Schwieger, *Röm. Gesch.* i. 240; Nissen, *Templum* iv.

¹ Varro, *L.L.* vi. 34. ² Fest. 258; Varro ap. Solinus i. 17.

³ Tac. *Ann.* xiii. 24. For a full discussion of the exact limits of the Palatine city see Smith, *Dict. Geog.*, s.v. "Roma"; Jordan, *Topog. d. Stadt Rom*, i. caps. 2; Gilbert, *Topog. u. Gesch. d. Stadt Rom*, i. caps. 1, 2; and "Topography" below.

⁴ *L.L.* v. 48; cf. *ibid.* 50.

⁵ Festus 348; Jordan i. 199; Gilbert i. 161. The seven "montes" are the Palatine with the Velia and Germalus, the Subura, and the three points of the Esquiline (Fagatal, Oppius and Cispius).

⁶ See Mommsen, *R.G.* (7th ed.) i. 51.

⁷ Varro, *L.L.* v. 45, vii. 44; Jordan ii. 237.

⁸ See LATIN LANGUAGE.

This was long ago recognized by Schwegler (see his *Römische Geschichte*, passim) on the sufficient ground of the great religious cleavage between the two orders. Such jealousy of mutual contact in religious matters as is apparent all through the history of the city very rarely, if ever, springs from any other source than a real difference of race. This point was developed by Professor W. Ridgeway in his *Who were the Romans?* (London, 1908), where he points out (a) that the deities tended by the three greater or patrician flames, namely, Dialis, Martialis, Quirinalis, were all closely connected with the Sabines; (b) further, that the patrician form of marriage, the highly religious ceremony called *Confarreatio*, differed entirely from the other forms, *Usus* and *Coemptio*, which there is reason to attribute to a plebeian origin; (c) that the arms, especially the round shield, carried by the first class in the originally military constitution of Servius Tullius (see below), are characteristic of the warriors of Central Europe in the Early Iron and Bronze Age, whereas those of the remaining classes can be shown to have been in general use during the immediately preceding period in the Mediterranean lands.

For other archaeological evidence separating the patricians from the plebeians, and connecting the patricians closely with the Sabines the reader must be referred to Ridgeway's essay. It is, however, well to make special mention here of the tradition, which is given by Livy (ii. 16. 4), and is undated but not the less probable for a non-analytic tradition, preserved in the *gens* itself, of the prompt welcome given to the Sabine Appius Claudius, the founder of the haughtiest of all the Roman noble families, by the patricians of Rome and his immediate admission to all their political privileges. Ridgeway points out that this implies, at that early time, a substantial identity of race.

On the linguistic side of the question it is well to mention for clearness' sake that this Sabine or patrician class marked its ascendancy all over Central and Southern Italy, from the 6th century B.C. onwards, by its preference for forming ethnic names with the suffix *-no* which it frequently imposed also upon the communities whom it brought under its influence. *Sabini* (earlier *Safini*), *Romani*, *Latini*, *Sidicini*, *Aricini*, *Marrucini*, and the like are all names formed in this way (see further *SABINI*).

2. It may also now be regarded as certain that what we may call the Lower or Earlier Stratum (or Strata) of population in Rome, themselves spoke a language which was as truly Indo-European as the language of their Sabine conquerors. In the article *VOLSCI* will be found evidence for the conclusion that the language of what has been there entitled the Co-Folk was not less certainly Indo-European, and in some respects probably a less modified form of Indo-European, than that of the Sabines. A number of the names formed with the *-co* suffix and with the *-ati*-suffix (which is frequent in the same districts) contain unmistakably Indo-European words such as *Graviscae*, *Marica*, *dea Marica*, *Volsci*, *Casinates*, *Soracte*, *Interamnites*, *Assumates*. The fusion of this earlier population with the patricians is far easier to imagine when it is recognized that the two parties spoke kindred though by no means identical languages. It is the essentially Indo-European character of the early inhabitants of the Latin plain which has led many scholars to doubt that there was any racial distinction at all between patricians and plebeians, but the increase of knowledge of the dialects spoken in the different regions of Italy has now enabled us to judge this question with very much fuller evidence.

3. There arises, however, the important question or questions as to the origin, or at least the ethnic connexions of this earlier stratum. The task of the historic inquirer will not be completely performed until at least some further progress has been made in connecting this earlier population of the western coast of Italy, on the one hand, with one or more of the early races (see *SICULI*, *VENETI*, *LIGURIA*, *PELAGIANS*) whom tradition declares to have once inhabited the soil of Latium; and on the other, with the people or peoples whom archaeological research reveals to us as having left behind them different strata of remains, all earlier than the Iron or Roman Age, both in

Latium and in other parts of Italy. Professor Ridgeway has taken a short way with these problems which may prove to be the true one; he classes together as Ligurian all pre-Sabine inhabitants of Italy save such elements as, like the Etruscans, can be shown to have invaded it over sea (see *ETRURIA*, § *Language*). This is one of the most promising fields of investigation now open to scholars, but in view of the confused and mutilated shape in which the traditions current in ancient times have come down to us, it demands an exceedingly careful scrutiny of the archaeological and the linguistic evidence, and exceedingly cautious judgment in combining them. The point of outstanding importance is to determine whether the earlier Indo-European population is to be regarded as having been in Italy from the beginning of human habitation. Archaeologists generally like W. Helbig (*Die Italiker der Poebene*) and more recently B. Modestov (*Introduction à l'histoire romaine*, Paris, 1907) have been inclined to regard the Ligurians as the most primitive population of Italy, but to distinguish them sharply from the people who built the Lake Settlement and File Dwellings, which appear (with important variations of type):—(1) in the western half of the valley of the Po; (2) in the eastern half of the same; (3) in Picenum; (4) in Latium; and (5) as far south as Tarentum. One of the most important points in the identification is the question of the method of burial employed at different epochs by the different communities. (See the works already cited, with that of O. Montelius, *La Civilisation primitive en Italie*.)

The *populus Romanus* was, we are told, divided into three tribes, Ramnes, Tities and Luceres,¹ and into thirty curiae. The three names, as Schulze has shown (*Lat. Eigennamen*, p. 580), are neither more nor less than the names of three Etruscan *gentes* (whether or not derived from Sabine or Latin originals), and the tradition is a striking result of the Etruscan domination in the 6th century B.C.,² which we shall shortly consider.

Of far greater importance is the division into *curiae*. In Cicero's time there were still curies, curial festivals and curiate assemblies, and modern authors are unquestionably right in regarding the curia as the keystone of the primitive political system. It was a primitive association held together by participation in common *sacra*, and possessing common festivals, common priests and a common chapel, hall and hearth.³ As separate associations the curiae were probably older than the Roman state, but,⁴ however this may be, it is certain that of this state when formed they constituted the only effective political subdivisions. The members of the thirty curiae form the *populus Romanus*, and the earliest known condition of Roman citizenship is the *communio sacrorum*, partnership in the curial *sacra*. Below the curia there was no further political division, for there is no reason to believe that the curia was ever formally subdivided into a fixed number of *gentes* and families.⁴

At their head was the *rex*, the ruler of the united people. The Roman "king" is not simply either the hereditary and patriarchal chief of a clan, the priestly head of a community bound together by common *sacra*, but the elected magistrate of a state, but a mixture of all three.⁵ The king

¹ The tradition connecting the Ramnes with Romulus and the Tities with Tatius is as old as Ennius (Varro, *L.L.* v. 55). The best authorities on the question, earlier than Schulze's epoch-making treatise, are Schwegler i. 505, and Volquardsen, *Rhein. Mus.* xxxii. 538.

² They are traditionally connected only with the senate of 300 *patres*, with the primitive legion of 3000, with the vestal virgins, and with the augurs (Varro, *L.L.* v. 81, 89, 91; Livy x. 6; Festus 344; Mommsen i. 41, 74, 75; Genz, *Patricisch. Rom.* 90).

³ It is possible that the curiae were originally connected with separate localities; cf. such names as *Foriensis*, *Veliensis* (Fest. 174; Gilbert i. 213).

⁴ Niebuhr's supposition of ten *gentes* in each curia has nothing in its favour but the confused statement of Dionysius as to the purely military *tribades* (Dionys. ii. 7; cf. Müller, *Philologus*, xxiv. 96).

⁵ Rubino, Genz and Lange insisted on the hereditary patriarchal character of the kingship, line on its priestly side, Schwegler on its elective. Mommsen came nearest to the view taken in the text, but

later times, when no "patrician magistrates" were forthcoming to hold the elections for their successors, a procedure was adopted which was believed to represent the manner in which the early kings had been appointed.¹ In this procedure the ancient privileges of the old *gentes* and their elders, the importance of maintaining unbroken the continuity of the *sacra*, on the transmission and observance of which the welfare of the community depended, and thirdly the rights of the freemen, are all recognized. On the death of a king, the *auspicia*, and with them the supreme authority, revert to the council of elders, the *patres*, as representing the *gentes*. By the *patres* an *interrex* is appointed, who in turn nominates a second; by him, or even by a third or fourth *interrex*, a new king is selected in consultation with the *patres*. The king-designate is then proposed to the freemen assembled by their curiae for their acceptance, and finally their formal acceptance is ratified by the *patres*, as a security that the *sacra* of which they are the guardians have been respected.² Thus the king is in the first instance selected by the representatives of the old *gentes*, and they ratify his appointment. In form he is nominated directly by a predecessor from whose hands he receives the *auspicia*. But it is necessary also that the choice of the *patres* and the nomination of the *interrex* should be confirmed by a solemn vote of the community.

It is useless to attempt a precise definition of the prerogatives of the king when once installed in office. Tradition ascribes to him a position and powers closely resembling those of the heroic kings of Greece. He rules for life, and he is the sole ruler, unfettered by written statutes. He is the supreme judge, settling all disputes and punishing wrongdoers even with death. All other officials are appointed by him. He imposes taxes, distributes lands and erects buildings. Senate and assembly meet only when he convenes them, and meet for little else than to receive communications from him. In war he is absolute leader,³ and finally he is also the religious head of the community. It is his business to consult the gods on its behalf, to offer the solemn sacrifices and to announce the days of the public festivals. Hard by his house was the common hearth of the state, where the vestal virgins cherished the sacred fire.

By the side of the king stood the senate, or council of elders. In the descriptions left us of the primitive senate, as in those of the *rex*, we can discover traces of a transition from an earlier state of things when Rome was only an assemblage of clans or village communities, allied indeed, but each still ruled by its own chiefs and headmen, to one in which these groups have been fused into a single state under a common ruler. On the one hand the senate appears as a representative council of chiefs, with inalienable prerogatives of its own, and claiming to be the ultimate depository of the supreme authority and of the *sacra* connected with it. The senators are the *patres*; they are taken from the leading *gentes*; they hold their seats for life; to them the *auspicia* revert on the death of a king; they appoint the *interrex* from their own body, are consulted in the choice of the new king,⁴ and their sanction is necessary to ratify the vote of the assembled freemen. On the other hand, they are no longer supreme.

fallen to bring out the nature of the compromise on which the kingship rests.

¹ Cic. *De Legg.* iii. 3; Livy iv. 7.

² "Patres auctores facti," Livy i. 22; "patres fuere auctores," *ibid.* i. 32. In 336 b.c. (Livy viii. 12) the Publilian law directed that this sanction should be given beforehand, "ante initium suffragium," and thus reduced it to a meaningless form (Livy i. 11). It is wrongly identified by Schwieger with the "lex curiata de imperio," which in Cicero's day followed did not precede election. According to Cicero (*De Rep.* ii. 13, 21), the proceedings included, in addition to the "creation" by the *comitia curiata* and the sanction of the *patres*, the introduction by the king himself of a *lex curiata* conferring the *imperium* and *auspicia*; but this theory, though generally accepted, is probably an inference from the practice of a later time, when the *creatio* had been transferred to the *comitia centuriata*.

³ For the references, see Schwieger i. 646 seq.

⁴ If the analogy of the *rex sacrorum* is to be trusted, the "king" could only be chosen from the ranks of the *patricii*. Cic. *Pro Domo*, 14; Gaius i. 122.

They cannot appoint a king but with the consent of the community, and their relation to the king when appointed is one of subordination. Vacancies in their ranks are filled up by him, and they can but give him advice and counsel when he chooses to consult them.

The popular assembly of united Rome in its earliest days was that in which the freemen met and voted by their curiae (*comitia curiata*). The place of assembly was in the Comitium at the north-east end of the Forum,⁵ ^{The assembly.} at the summons and under the presidency of the king or, failing him, of the *interrex*. By the *rex* or the *interrex* the question was put, and the voting took place *curiatim*, the curiae being called up in turn. The vote of each curia was decided by the majority of individual votes, and a majority of the votes of the curiae determined the final result. But the occasions on which the assembly could exercise its power must have been few. Their right to elect magistrates was apparently limited to the acceptance or rejection of the king proposed by the *interrex*. Of the passing of laws, in the later sense of the term, there is no trace in the kingly period. Dionysius's statement⁷ that they voted on questions of war and peace is improbable in itself and unsupported by tradition. They are indeed represented, in one instance, as deciding a capital case, but it is by the express permission of the king and not of right.⁸ Assemblies of the people were also, and probably more frequently, convened for other purposes. Not only did they meet to hear from the king the announcement of the high days and holidays for each month, and to witness such solemn religious rites as the inauguration of a priest, but their presence (and sometimes their vote) was further required to authorize and attest certain acts, which in a later age assumed a more private character. The disposal of property by will⁹ and the solemn renunciation of family or gentile *sacra*¹⁰ could only take place in the presence of the assembled freemen, while for adoption¹¹ (*adrogatio*) not only their presence but their formal consent was necessary.

A history of this early Roman state is out of the question. The names, dates and achievements of the first four kings are all too unsubstantial to form the basis of a sober *Rome under the kings* narrative;¹² a few points only can be considered as fairly well established. If we except the long eventless reign ascribed to King Numa, tradition represents the first kings as incessantly at war with their immediate neighbours. The details of these wars are no doubt mythical; but the implied condition of continual struggle, and the narrow range within which the struggle is confined, may be accepted as true. The picture drawn is that of a small community, with a few square miles of territory, at deadly feud with its nearest neighbours, within a radius of some 12 m. round Rome. Nor, in spite of the repeated victories with which tradition credits Romulus, Ancus and Tullus, does there seem to have been any real extension of Roman territory except towards the sea. Fidenae remains Etruscan; the Sabines continue masters up to the Anio; Praeneste, Gabii and Tusculum are still untouched; and on this side it is doubtful if Roman territory, in spite of the possible destruction of Alba, extended to a greater distance than the sixth milestone from Rome.¹³ But along the course

⁵ Cic. *De Rep.* ii. 13; Dionys. ii. 14, 8c.

⁶ Varro, *L.L.* v. 155. For the position of the Comitium, see Smith, *Dial. Geog.* s.v. "Roma," and Jordan, *Topog. d. Stadt Rom.* (Peterson).

⁷ Dionys. i. 101.

⁸ Livy i. 26; Dionys. iii. 22.

⁹ Gaius i. 101.

¹⁰ Gell. xv. 27.

¹¹ Gell. v. 19, "Comitia praebentur, quae curiata appellantur."

Cf. Cic. *Pro Domo*, 13, 14; and see ROMAN LAW.

¹² By far the most complete criticism of the traditional accounts of the first four kings will be found in Schwieger's *Röm. Geschichte*, vol. i.; compare also Inne's *Early Rome* and Sir G. C. Lewis's *Credibility of Early Roman History*. More recently, E. Pais (*Storia d'Italia*) has subjected the early legends to learned and often suggestive criticism, but without attaining very solid results.

¹³ The *fossa Cluana*, 5 m. from Rome (Livy i. 39), is regarded by Schwieger (i. 585) and by Mommsen (i. 45) as marking the Roman frontier towards Latium. Cf. Ovid. *Fast.* ii. 681; Strabo 230, "μετὰ τὴν πύλιν καὶ τὸν ἑκτον λιθὸν . . . τὸρος φησὶν . . . ὅπου τῆς τῶν Ῥωμαίων ἡγῆς."

of the Tiber below the city there was a decided advance. The fortification of the Janiculum; the building of the *pons sublicius*, the foundation of Ostia and the acquisition of the salt-works near the sea may all be safely ascribed to this early period. Closely connected, too, with the control of the Tiber from Rome to the sea was the subjugation of the petty Latin communities lying south of the river; and the tradition of the conquest and destruction of Politorium, Tellenae and Ficana is confirmed by the absence in historical times of any Latin communities in this district.

With the reign of the fifth king Tarquinius Priscus a marked change takes place. The traditional accounts of the last three

kings not only wear a more historical air than those of the first four, but they describe something like a transformation of the Roman city and state. Under the rule of these latter kings the separate settlements are for the first time enclosed with a rampart of colossal size and extent.¹ The low grounds are drained, and a forum and circus elaborately laid out; on the Capitoline Mount a temple is erected, the massive foundations of which were an object of wonder even to Pliny.² To the same period are assigned the redivision of the city area into four new districts and the introduction of a new military system. The kings increase in power and surround themselves with new splendour. Abroad, too, Rome suddenly appears as a powerful state ruling far and wide over southern Etruria and Latium. These startling changes are, moreover, ascribed to kings of alien descent, who one and all ascend the throne in the teeth of established constitutional forms. Finally, with the expulsion of the last of them—the younger Tarquin—comes a sudden shrinkage of power. At the commencement of the Republic Rome is once more a comparatively small state, with hostile and independent neighbours at her very doors. It is impossible to doubt the conviction that the true explanation of this phenomenon is to be found in the supposition that Rome during this period passed under the rule of powerful Etruscan lords.³ In the 7th and 6th centuries B.C., and probably earlier still, the Etruscans appear as ruling widely outside the limits of Etruria proper. They were supreme in the valley of the Po until their power there was broken by the irruption of Celtic tribes from beyond the Alps, and while still masters of the plains of Lombardy they established themselves in the rich lowlands of Campania, where they held their ground until the capture of Capua by the Samnite highlanders in 423 B.C. It is on the face of it improbable that a power which had extended its sway from the Alps to the Tiber, and from the Liris to Surrentum, should have left untouched the intervening stretch of country between the Tiber and the Liris. And there is abundant evidence of Etruscan rule in Latium.⁴ According to Dionysius there was a time when the Latins were known to the Greeks as Tyrrhenians, and Rome as a Tyrrhenian city.⁵ When Aeneas landed in Italy the Latins were at feud with Turnus (Turrenus? Dionys. i.64) of Ardea, whose close ally was the ruthless Mezentius, prince of Caere, to whom the Latins had been forced to pay a tribute of wine.⁶ Cato declared the Volsci to have been once subject to Etruscan rule,⁷ and Etruscan remains found at Velitrae,⁸ as well as the second name of the Volscian Anxur, Tarracina (the city of Tarcon), confirm his statement. Nearer still to Rome is Tusculum, with its significant name, at Praeneste we have a great number of Etruscan inscriptions and bronzes, and at Alba we hear of a prince *Ταρχέριος*,⁹ lawless and cruel like Mezentius, who consults the "oracle of Tethys in Tyrrhenia."¹⁰ Thus we find the Etruscan power encircling Rome on all sides, and in Rome itself a tradition of the rule of princes of Etruscan

origin. The Tarquinius come from south Etruria; their name can hardly be anything else than the Latin equivalent of the Etruscan Tarcon, and is therefore possibly a title (= "lord" or "prince") rather than a proper name.¹¹ Even Servius Tullius was identified by Tuscan chroniclers with an Etruscan "Mastarna."¹² Again, what we are told of Etruscan conquests does not represent them as moving, like the Sabellian tribes, in large bodies and settling down *en masse* in the conquered districts. We hear rather of military raids led by ambitious chiefs who carve out principalities for themselves with their own good swords, and with their followers rule oppressively over alien and subject peoples.¹³ And so at Rome the story of the Tarquins implies not a wave of Etruscan immigration so much as a rule of Etruscan princes over conquered Latins.

The achievements ascribed to the Tarquins are not less characteristic. Their despotic rule and splendour contrast with the primitive simplicity of the native kings. Only Etruscan builders, under the direction of wealthy and powerful Etruscan lords, could have built the great cloaca, the Servian wall, or the Capitoline temple,—monuments which challenged comparison with those of the emperors themselves. Nor do the traces of Greek influence upon Rome during this period¹⁴ conflict with the theory of an Etruscan supremacy; on the contrary, it is at least possible that it was thanks to the extended rule and wide connexions of her Etruscan rulers that Rome was first brought into direct contact with the Greeks, who had long traded with the Etruscan ports and influenced Etruscan culture.¹⁵

The Etruscan princes are represented, not only as having raised Rome for the time to commanding position in Latium and lavished upon the city itself the resources of Etruscan civilization, *The Servian reforms*. They are represented also as favouring new men at the expense of the old patrician families, and as reorganizing the Roman army on a new footing, a policy natural enough in military princes of alien birth, and rendered possible by the additions which conquest had made to the original community. From among the leading families of the conquered Latin states a hundred new members were admitted to the senate, and these *gentes* thenceforth ranked as patrician, and became known as *gentes minores*.¹⁶ The changes in the army begun, it is said, by the elder Tarquin and completed by Servius Tullius were more important. The basis of the primitive military system had been three tribes, each of which furnished 1000 men to the legion and 100 to the cavalry.¹⁷ Tarquinius Priscus, we are told, contemplated the creation of three fresh tribes and three additional centuries of horsemen with new names,¹⁸ though in face of the opposition offered by the old families he contented himself with simply doubling the strength without altering the names of the old divisions.¹⁹ But the change attributed to Servius Tullius went far beyond this. His famous distribution of all freeholders (*assidui*) into tribes, classes and centuries,²⁰ though subsequently adopted with modifications as the basis of the

¹⁰ Müller-Deecke, i. 69, 70; Zöllner, *Latium u. Rom.*, 168; cf. Strabo, p. 219; Serv. on *Aen.* x. 179, 198. The existence of an independent "gens Tarquinia" of Roman extraction (Schwegler, i. 678) is unproven and unlikely. See now Schulze, *Lat. Eigennamen*, pp. 95 and 402 n. 6.

¹¹ See speech of Claudius, *Tab. Aed.* Astur. to Nipperdey's edition of the *Annals* of Tacitus. "Tuscis Mastarna ei nomen erat." For the painting in the François tomb at Vulci, see Gardthausen, *Mastarna*, 29 seq.; *Annali dell. Instit.* (Rome, 1850).

¹² Cf. the traditions of Mezentius, of Caelus Vibenna, Porsena, &c. Schwegler, *R.G.* i. 679 seq.

¹³ *Ibid.* i. 791, 792. He accepts as genuine, and as representing the extent of Roman rule and connexions under the Tarquins, the first treaty between Rome and Carthage mentioned by Polybius (iii. 22); see, for a discussion of the question, Vollmer, *Rhein. Mus.* xxxii. 614 seq.; Mommsen, *Röm. Chronologie*, 20; Dyer, *Journ. of Philol.* ii. 338.

¹⁴ Livy i. 35; Dionys. iii. 67; Cic. *De Rep.* ii. 20.

¹⁵ Varro, *L.L.* v. 80. ¹⁶ Livy i. 36; Dionys. iii. 71.

¹⁷ The six centuries of horsemen were thenceforward known as "primi secundique Rames" (Fest., 344; cf. Schwegler, i. 685 seq.). It is possible that the reforms of Tarquinius Priscus were limited to the cavalry.

¹⁸ Cic. *De Rep.* ii. 22; Livy i. 42; Dionys. iv. 16.

¹ Livy i. 36. ² *Ibid.* i. 38, 55; Plin. *N.H.* xxxvi. 15.

³ This was the view of O. Müller, and more recently of Deecke, Gardthausen and Zöllner.

⁴ W. Schulze, *Gesch. d. Lat. Eigennamen*, passim (esp. pp. 579 ff.); Zöllner, *Latium u. Rom.* 166, 189; Gardthausen, *Mastarna* (Leipzig, 1882).

⁵ Dionys. i. 29. ⁶ Livy i. 2; Dionys. i. 64, 65; Plut. *Q.R.* 18.

⁷ Cato ap. Serv. *Aen.* xi. 567. ⁸ Helbig, *Ann. d. Inst.* (1865).

⁹ Plut. *Rom.* 2. *ταρανοφάρος* καὶ *ἀνδράρος*; cf. Rutulian Tarquinius, Virg. *Aen.* x. 550.

political system, was at first exclusively military in its nature and objects.¹ It amounted, in fact, to the formation of a new and enlarged army on a new footing. In this force, excepting in the case of the centuries of the horsemen, no regard was paid either to the old clan divisions or to the semi-religious, semi-political curiae. In its ranks were included all freeholders within the Roman territory, whether members or not of any of the old divisions, and the organization of this new army of *assidui* was not less independent of the old system with its clanish and religious traditions and forms. The unit was the *centuria* or company of 100 men; the *centuriae* were grouped in "classes" and drawn up in the order of the phalanx.² The centuries in front were composed of the wealthier citizens, whose means enabled them to bear the cost of the complete equipments necessary for those who were to bear the brunt of the onset. These centuries formed the first class. Behind them stood the centuries of the second and third classes, less completely armed, but making up together with those of the first class the heavy-armed infantry.³ In the rear were the centuries of the fourth and fifth classes, recruited from the poorer freeholders, and serving only as light-armed troops. The entire available body of freeholders was divided into two equal portions, a reserve corps of *seniores* and a corps of *juniores* for active service. Each of these corps consisted of 85 centuries or 8,500 men, i. e. of two legions of about 4,200 men each, the normal strength of a consular legion under the early Republic.⁴ It is noticeable also that the heavy-armed centuries of the three first classes in each of these legions represented a total of 3,000 men, a number which agrees exactly with the number of heavy-armed troops in the legion as described by Polybius. Attached to the legions, but not included in them, were the companies of sappers and trumpeters. Lastly, to the six centuries of horsemen, which still retained the old tribal names, twelve more were added as a distinct body, and recruited from the wealthiest class of citizens.⁵ The four "tribes" also instituted by Servius were probably intended to serve as the bases for the levy of freeholders for the new army.⁶ As their names show, they corresponded with the natural local divisions of the city territory.⁷

The last of these Etruscan lords to rule in Rome was Tarquin the Proud. He is described as a splendid and despotic monarch. His sway extended over Latium as far south as Circeii. Aristodemus, tyrant of Cumae, was his ally, and his kinsmen of his own were princes at Collatia, at Gabii, and at Tusculum. The Volscian highlanders were chastised, and Signia with its massive walls was built to hold them in check. In Rome itself the Capitoline temple and the great cloaca bore witness to his power. But his rule pressed heavily upon the Romans, and at the last, on the news of the foul wrong done by his son Sextus to a noble Roman matron, Lucretia, the indignant people rose in revolt. Tarquin, who was away besieging Ardea, was deposed; sentence of exile was passed upon him and upon all his race; and the

¹ This is recognized by Mommsen, Genz and Sohtau, as against Niebuhr, Schwieger and Ihne. Even in the later *comitia centuriata* the traces of the originally military character of the organization are unmistakable.

² The century ceased to represent companies of one hundred when the whole organization ceased to be military and became exclusively political.

³ The property qualification for service in the first class is given at 100,000 asses (Liv. 1), for the second at 70,000, third 50,000, fourth 25,000, fifth 11,000. It was probably originally a certain number of cows, afterwards translated into terms of money; cf. W. Ridgway, *The Origin of Coinage and Metallic Currency* (Cambridge, 1892), p. 391. The same scholar, in his *Who were the Romans?* p. 17, has pointed out the ethical meaning of the varieties of armature in the early army.

⁴ Polyb. vi. 20; Mommsen, *Röm. Trib.* 132 seq.
⁵ Livy i. 43. Dionys. (iv. 18) and Cic. (*De Rep.* ii. 22) ascribe the whole equipment to Servius. But the six older centuries remained distinct, as the "sex suffragia" of the *comitia centuriata*; *Rep. De Rep.* ii. 22.

⁶ Dionys. iv. 14, εἰς τὰς καταγραφὰς τῶν στρατιωτῶν.

⁷ Livy i. 43. The four were Palatina, Suburana, Exquilina, Collina.

people swore that never again should a king rule in Rome. Freed from the tyrant, they chose for themselves two yearly magistrates who should exercise the supreme authority, and thus the Republic of Rome was founded. Three times the banished Tarquin strove desperately to recover the throne he had lost. First of all the men of Veii and Tarquinii marched to his aid, but were defeated in a pitched battle on the Roman frontier. A year later Lars Porsena, prince of Clusium, at the head of all the powers of Etruria, appeared before the gates of Rome, and closely besieged the city, until, moved by the valour of his foe, he granted honourable terms of peace and withdrew.⁸ Once again, by Lake Regillus, the Romans fought victoriously for their liberty against Tarquin's son-in-law Mamilius, prince of Tusculum, and chief of the Latin name. Mamilius was slain; Tarquin in despair found a refuge at Cumae, and there soon afterwards died.

So, in brief, ran the story of the flight of the kings, as it was told by the chroniclers whose story Livy reports, though with explicit and repeated notes of reserve. Its details are most of them fabulous; it is crowded with inconsistencies and improbabilities; there are no trustworthy dates; the names even of the chief actors are probably fictitious, and the hand of the improver, Greek or Roman, is traceable throughout.⁹ But there is no room for doubting the main facts of the emancipation of Rome from the rule of alien princes and the final abolition of the kingly office. (H. F. P.; R. S. C.)

II. The Republic.

PERIOD A: 509-265 B.C.¹⁰—(a) *The Struggle between the Orders.*—It is characteristic of Rome that the change from monarchy to republic¹¹ should have been made with the least possible disturbance of existing forms. The title of king 245-189
A.U.C. was retained, though only as that of a priestly officer (*rex sacrorum*) to whom some of the religious functions of the former kings were transferred. The two annually elected consuls, or *praetores*,¹² were regarded as joint heirs of the full kingly authority, and as holding the *imperium*, and the correlative right of taking the auspices, by direct transmission from the founder of the city. They were, it is true, elected or designated by a new assembly, by the army of landholders voting by their classes and centuries (*comitia centuriata*), and to this body was given also the right of passing laws; nevertheless it was still by a vote of the thirty curiae (*lex curiata*) that the supreme authority was formally conferred on the magistrates chosen by the centuries of landholders, and both the choice of magistrates and the passing of laws still required the sanction of the patrician senators (*patrum auctoritas*).¹³ Nor, lastly, were the legal prerogatives of the senate altered, although it is probable that before long plebeians were admitted to seats, if not to votes, and though its importance was gradually increased by the substitution of an annual magistracy for the lifelong rule of a single king. But the

⁸ Livy ii. 9-14. Pliny (*N.H.* 34, 14) and Tacitus (*Ann.* iii. 72) imply the existence of a tradition, possibly that of "Tuscan annalists," according to which Porsena actually made himself master of Rome. The whole story is fully criticized by Schwieger (ii. 181 seq.) and Zöller (*Latium us. Rom.*, p. 180).

⁹ See the exhaustive criticism in Schwieger (ii. pp. 66-203).

¹⁰ The traditional account of early republican history, given in annalistic form by Livy, has been subjected to severe criticism in recent times, notably by Pais in his *Storia di Roma*, vols. i. and ii. It is true that the dearth of contemporary documents, especially for the period before the sack of Rome by the Gauls (390 B.C.), must have led to the filling of gaps by episodes drawn mainly from popular traditions, and it is therefore impossible to guarantee the accuracy of the narrative in details. Nevertheless, the general truth of the story of Rome's early wars and constitutional growth cannot be seriously impugned.

¹¹ Schwieger (ii. 92) suggests that the dictatorship formed an intermediate step between the monarchy and the consulate; cf. Ihne, *Röm. Forsch.* 42.

¹² That the consuls were originally styled *praetores* is stated by Varro, *ap. Non.* p. 23, and Liv. iii. 55; cf. Cic. *Legg.* viii. 3, 8. When additional praetors were created, the two originally appointed were called *praetores maximi* and hence *στρατηγὸν δυνάτω* or simply *δυνάτω* in Greek.

¹³ The view of the *patrum auctoritas* here adopted is that taken by T. Mommsen (*Forsch.* i.).

abolition of the monarchy brought with it a change of the utmost importance in the actual working of the constitution. Though the distinction between patricians and plebeians was at least as old as the state itself, it is not until the establishment of the Republic that it plays any part in the history of Rome. No sooner, however, was the overshadowing authority of the king removed than a struggle commenced between the two orders which lasted for more than two centuries. It was in no sense a struggle between a conquering and a conquered class, or between an exclusive citizen body and an unfranchised mass outside its pale. Patricians and plebeians were equally citizens of Rome, sprung of the same race and speaking the same tongue (but see above).¹ The former were the members of those ancient *gentes* which had possibly been once the "chiefly" families in the small communities which preceded the united state, and which claimed by hereditary right a privileged position in the community. Only patricians could sit in the council of *patres*, and hence probably the name given to their order.² To their representatives the supreme authority reverted on the death of the king; the due transmission of the *auspicia* and the public worship of the state gods were their special care; and to them alone were known the traditional usages and forms which regulated the life of the people from day to day. To the *plebs* (the multitude, *πληθος*) belonged all who were not members of some patrician *gens*, whether independent freemen or attached as "clients"³ to one of the great houses. The plebeian was a citizen, with civil rights and a vote in the assembly of the curies, but he was excluded by ancient custom from all share in the higher honours of the state, and intermarriage with a patrician was not recognized as a properly legal union⁴ (see PATRICIANS).

The revolution which expelled the Tarquins gave the patricians, who had mainly assisted in bringing it about, an overwhelming ascendancy in the state. The *plebs* had indeed gained something. Not only is it probable that the strictness of the old tie of clientship had somewhat relaxed, and that the number of the *clientes* was smaller and their dependence on patrician patrons less complete, but the ranks of the *plebs* had, under the later kings, been swelled by the admission of conquered Latins, and the freeholders among these had with others been enrolled in the Servian tribes, classes and centuries. The establishment of the Republic invested this military levy of landholders with political rights as an assembly, for by their votes the consuls were chosen and laws passed, and it was the plebeian landholders who formed the main strength of the *plebs* in the struggle that followed. But these gains were greater in appearance than in reality. The plebeian landholders commanded only a minority of votes in the *comitia centuriata*. In their choice of magistrates they were limited to the patrician candidates nominated by patrician presiding magistrates, and their choice required confirmation not only by the older and smaller assembly of the curiae, in which the patricians and their clients predominated, but also by the patrician *patres*. They could only vote on laws proposed by patrician consuls, and here again the subsequent sanction of the *patres* was necessary. The whole procedure of the *comitia* was in short absolutely in the hands of their patrician presidents, and liable to every sort of interruption and suspension from patrician pontiffs and augurs (for details see further COMMITIA and SENATE).

But these political disabilities did not constitute the main grievance of the *plebs* in the early years of the Republic. What they fought for was protection for their lives and liberties, and the object of attack was the despotic authority of the

patrician magistrates. The consuls wielded the full *imperium* of the kings, and against this "consular authority" the plebeian, though a citizen, had no protection and no appeal, nor were matters improved when for the two consuls was substituted in some emergency a single, all-powerful, irresponsible dictator.

The history of this struggle between the orders opens with a concession made to the *plebs* by one of the consuls themselves, a concession possibly due to a desire to secure the allegiance of the plebeian landholders, who formed the backbone of the army. In the first year of the Republic, according to the received chronology, P. Valerius Publicola or Poplicola carried in the *comitia centuriata* his famous law of appeal.⁵ It enacted that no magistrate, saving only a dictator, should execute a capital sentence upon any Roman citizen unless the sentence had been confirmed on appeal by the assembly of the centuries. But, though the "right of appeal" granted by this law was justly regarded in later times as the greatest safeguard of a Roman's liberties, it was by no means at first so effective a protection as it afterwards became. For not only was the operation of the law limited to the bounds of the city, so that the consul in the field or on the march was left as absolute as before, but no security was provided for its observance even within the city by consuls resolved to disregard it.⁶

It was by their own efforts that the plebeians first obtained any real protection against magisterial despotism. The traditional accounts of the first secession are confused and contradictory,⁷ but its causes and results are tolerably clear. The seceders were the plebeian legionaries recently returned from a victorious campaign. Indignant at the delay of the promised reforms, they ignored the order given them to march afresh against Volsci and Aequi, and instead entrenched themselves on a hill across the Anio, some 3 m. from Rome, and known afterwards as the Mons Sacer. The frightened patricians came to terms, and a solemn agreement (*lex sacrata*)⁸ was concluded between the orders, by which it was provided that henceforth the plebeians should have annual magistrates of their own called tribunes (*tribuni plebis*), members of their own order, who should be authorized to protect them against the consuls,⁹ and a curse was invoked upon the man who should injure or impede the tribune in the performance of his duties.¹⁰ The number of tribunes was possibly at first two, then five; before 449 B.C. it had been raised to ten.

The tribunate is an institution which has no parallel in history. The tribune was not, and, strictly speaking, never became, a magistrate of the Roman people. His one proper prerogative was that of granting protection to the oppressed plebeian against a patrician officer. This prerogative (*ius auxilii*) was secured to him, not by the ordinary constitution, but by a special compact between the orders, and was protected by the ancient oath (*netus jusjurandum*),¹¹ which invoked a curse upon the violator of a tribune. This exceptional and anomalous right the tribunes could only exercise in person, within the limits of the "pomoerium," and against individual acts of magisterial oppression.¹² It was only gradually that it expanded into a wide power of interference with the whole machinery of government, and was supplemented by the legislative powers which rendered the tribunate of the last century B.C. so formidable (see TRIBUNES).

But from the first the tribunes were for the *plebs* not only protectors but leaders, under whom they organized themselves in opposition to the patricians. The tribunes convened *Lex* assemblies of the *plebs* (*concilia plebis*), and carried *Publician* resolutions on questions of interest to the order. This important

¹ Livy ii. 8, *lex Valeria de provocazione*; Cic. *De Rep.* ii. 31; cf. Livy iii. 20.

² Greenidge, *Legal Procedure of Cicero's Time*, pp. 344-349.

³ Schwegler ii. 226 sqq. ⁴ *Ibid.* ii. 251 n.; Livy i. 33.

⁵ Cic. *De Rep.* ii. 34. ⁶ *contra consule imperium creati.*

⁷ Livy iii. 55. ⁸ Festus 318.

⁹ Gell. xiii. 12. ¹⁰ *ut injuria quae coram fieret arceretur.*

¹ This is the view taken by the present writer, as against Schwegler and others. For Ridgeway's theory, see above.

² Cf. *audilis, aedilis*, &c.; Cic. *De Rep.* ii. 12; Livy i. 8; for a full discussion of other views, see Soltau 179 sqq.; Christensen, *Hermes*, ix. 196.

³ For the clientela, see Mommsen (*Forsch.* i. 355 sqq.; *Staatsr.* iii. 54 sqq.); Schwegler (i. 638 sqq.); Pauly-Wissowa, *Realencyklopädie*, iv. 23 sqq. (von Premerstein).

⁴ The offspring of such a union ranked as plebeians.

Lex Valeria de provocazione.

The first secession and the tribunate.

plebeian organization was materially advanced by the Publilian law of 471 B.C.,¹ which appears to have formally recognized as lawful the plebeian *concilia*, and established also the tribune's right *cum plebe agere*, i.e. to propose and carry resolutions in them. These assemblies were *tributa*, or, in other words, the voting in them took place not by curies or centuries but by tribes. In them, lastly, after the Publilian law, if not before, the tribunes were annually elected.² By this law the foundations were laid both of the powerful *concilia plebis* of later days and also of the legislative and judicial prerogatives of the tribunes. The patricians maintained indeed that resolutions (*plebiscita*) carried by tribunes in the *concilia plebis* were not binding on their order, but the moral weight of such resolutions, whether they affirmed a general principle or pronounced sentence of condemnation on some single patrician, was no doubt considerable.

The next stage in the struggle is marked by the attempt to substitute a public written law for unwritten usage.

The proposal of C. Terentilius Arsa (462 B.C.) to appoint a plebeian commission to draw up laws restricting the powers of the consuls³ was resolutely opposed by the patricians, but after ten years of bitter party strife a compromise was effected. A commission of ten patricians was appointed, who should frame and publish a code of law binding equally on both the orders. These decemviri were to be the sole and supreme magistrates for the year, and the law of appeal was suspended in their favour.⁴ The code which they promulgated, the famous XII. Tables, owed little of its importance to any novelties or improvements contained in its provisions. For the most part it seems merely to have reaffirmed existing usages and laws (see ROMAN LAW). But it imposed, as it was intended to do, a check on the arbitrary administration of justice by the magistrates. With the publication of the code the proper work of the decemviri was finished; nevertheless, for the next year a fresh decemvirate was elected, and it is conceivable that the intention was permanently to substitute government by an irresponsible patrician "council of ten" for the old constitution.⁵ However this may have been, the tyranny of the decemviri themselves was fatal to the continuance of their power. We are told of a second secession of the *plebs*, this time to the Janiculum, and of negotiations with the senate, the result of which was the enforced abdication of the decemviri. The *plebs* joyfully chose for themselves tribunes, and in the *comitia centuriata* two consuls were created. But this restoration of the old régime was accompanied by legislation which

made it an important crisis in the history of the struggle between the orders. With the fall of the decemvirate this struggle enters upon a new phase. The tribunes appear as at once more powerful and more strictly constitutional magistrates; the plebeian *concilia* take their place by the side of the older assemblies; and finally this improved machinery is used not simply in self-defence against patrician oppression but to obtain complete political equality. This change was no doubt due in part to circumstances outside legislation, above all to the expansion of the Roman state, which swelled the numbers and added to the social importance of the *plebs* as compared with the dwindling forces of the close corporation of patrician *gentes*. Still the legislation of 449 clearly involved more than a restoration of the old form of government. The Valerio-Horatian laws, besides reaffirming the right of appeal and the inviolability of the tribunes, improved the position of the plebeian assemblies by enacting that *plebiscita* passed in them, and, as seems probable, approved by the *patres*, should be binding on patricians as well as plebeians.⁶

The tribunes appear as at once more powerful and more strictly constitutional magistrates; the plebeian *concilia* take their place by the side of the older assemblies; and finally this improved machinery is used not simply in self-defence against patrician oppression but to obtain complete political equality.

This change was no doubt due in part to circumstances outside legislation, above all to the expansion of the Roman state, which swelled the numbers and added to the social importance of the *plebs* as compared with the dwindling forces of the close corporation of patrician *gentes*. Still the legislation of 449 clearly involved more than a restoration of the old form of government. The Valerio-Horatian laws, besides reaffirming the right of appeal and the inviolability of the tribunes, improved the position of the plebeian assemblies by enacting that *plebiscita* passed in them, and, as seems probable, approved by the *patres*, should be binding on patricians as well as plebeians.⁶

¹ Livy ii. 56, 60; Dionys. ix. 41; Schwieger ii. 541; Soltau 493.

² For theories as to the original mode of appointing tribunes see Mommsen, *Forsch.* i. 185, *Staatsr.* ii. 274 sqq.

³ Livy iii. 9. ⁴ Ibid. iii. 32.

⁵ On the disputed question of the date of the XII. Tables see Pais, *Storia di Roma*, vol. i. chap. iv., and Greenidge, *Eng. Hist. Review* (1905), pp. 1 sqq.

⁶ Livy iii. 55. "quum veluti in controverso jure esset, tenerentur

By this law the tribunes obtained a recognized initiative in legislation. Henceforth the desired reforms were introduced and carried by tribunes in what were now styled *comitia tributa*, and, if sanctioned by the *patres*, became laws of the state. From this period, too, must be dated the legalization at any rate of the tribune's right to impeach any citizen before the assembly of the tribes.⁷ Henceforward there is no question of the tribune's right to propose to the *plebs* to impose a fine, or of the validity of the sentence when passed. The efficiency of these new weapons of attack was amply proved by the subsequent course of the struggle. Only a few years after the Valerio-Horatian legislation came the *lex Canuleia*, itself a *plebiscitum* (445 B.C.), by which mixed marriages between patricians and plebeians were declared lawful, and the social exclusiveness of the patriciate broken down. In the same year with this measure, and like it in the interests primarily of the wealthier plebeians, a vigorous attack commenced on the patrician monopoly of the consulate, and round this stronghold of patrician ascendancy the conflict raged until the passing of the Licinian laws in 367. The original proposal of the tribune Gaius Canuleius, in 445, that the people should be allowed to elect a plebeian consul was evaded by a compromise. The senate resolved that for the next year, in the stead of consuls, six military tribunes with consular powers should be elected,⁸ and that the new office should be open to patricians and plebeians alike. The consulship was thus for the time saved from pollution, as the patricians phrased it, but the growing strength of the *plebs* is shown by the fact that in fifty years out of the seventy-eight between 444 and 366 they succeeded in obtaining the election of consular tribunes rather than of consuls.

Despite, however, these discouragements, the patricians fought on. Each year they strove to secure the creation of consuls rather than consular tribunes, and failing this strained every nerve to secure for their own order at least a majority among the latter. Even the institution of the censorship (435), though rendered desirable by the increasing importance and complexity of the census, was, it is probable, due in part to their desire to discount beforehand the threatened loss of the consulship by diminishing its powers.⁹ Other causes, too, helped to protract the struggle. Between the wealthier plebeians, who were ambitious of high office, and the poorer, whose minds were set rather on allotments of land, there was a division of interest of which the patricians were not slow to take advantage, and to this must be added the pressure of war. The death struggle with Veii and the sack of Rome by the Gauls absorbed for the time all the energies of the community. In 377, however, two of the tribunes, C. Licinius Stolo (see LICINIUS STOLO, GAIVS) and L. Sextius, came forward with proposals which united all sections of the *plebs* in their support. Their proposals were as follows:¹⁰ (1) that consuls and not consular tribunes be elected; (2) that one consul at least should be a plebeian; (3) that the priestly college, which had the charge of the Sibylline books, should consist of ten members instead of two, and that of these half should be plebeians; (4) that no single citizen should hold in occupation more than 500 acres of the common lands, or pasture upon them more than 100 head of cattle and 500 sheep; (5) that all landowners should employ a certain amount of free as well as slave labour on their estates; (6) that interest already paid on debts should be deducted from the principal, and the remainder paid off in three years. The three last proposals were obviously intended to meet the *patres plebiscitis legem comitis centuriatis tulere*, ut quod tributum *plebs jussisset populum teneret*, qua lege tribuniciis rogationibus telum acerrium datum est.¹¹ What were the precise conditions under which a *plebiscitum* became law can only be conjectured. The control of the *patres* over legislation certainly remained effective until 287 B.C. (See below.)

⁷ After the decemvirate, the tribunes no longer pronounce capital sentences. They propose fines, which are confirmed by the *comitia tributa*.

⁸ Livy iv. 6; cf. Mommsen, *Staatsrecht*, ii. 181.

⁹ Mommsen, *Staatsrecht*, ii. 331.

¹⁰ Livy vi. 35, 42; Appian, *B.C.* i. 8.

Lex
Canuleia.
369.

Leges
Liciniae
Sextiae.
367.

310-88.

319.

377.

demands of the poorer plebeians, and to secure their support for the first half of the scheme. Ten years of bitter conflict

followed, but at last, in 367 B.C., the Licinian rogations became law, and one of their authors, L. Sextius, was created the first plebeian consul. For the moment it was some consolation to the patricians that they not only succeeded in detaching from the consulship the administration of civil law, which was entrusted to a separate officer, *praetor urbanus*, to be elected by the *comitia* of the centuries, with an understanding apparently that he should be a patrician, but also obtained the institution of two additional aediles (*aediles curules*), who were in like manner to be members of their own order.¹ With the opening of the consulship, however, the issue of the long contest was virtually decided, and the next eight years witnessed a rapid succession of plebeian victories. Now that a plebeian consul might preside at the elections, the main difficulty in the way of the nomination and election of plebeian candidates was removed. The proposed patrician monopoly of the new curule aedileship was almost instantly abandoned. In 356 the first plebeian was made dictator; in 350 the censorship, and in 337 the praetorship were filled for the first time by plebeians; and lastly, in 300, by the *lex Ogulnia*, even the sacred colleges of the pontiffs and augurs, the old strongholds of patrician supremacy, were thrown open to the *plebs*.² The patricians lost also the control they had exercised so long over the action of the people in assembly. The *patrum auctoritas*, the sanction given or refused by the patrician senators to laws and to elections, had hitherto been a powerful weapon in their hands. But in 339 a law of Q. Publilius Philo, a plebeian dictator, enacted that this sanction should be given beforehand to laws enacted in the *comitia centuriata*,³ and a *lex Maenia* of uncertain date extended the rule to elections in the same assembly. Livy ascribes to the same Publilius a law emancipating the *concilium plebis* from the control of the *patres*; but this seems in reality to have been effected by the famous *lex Hortensia*, carried by another plebeian dictator.⁴ Henceforward the *patrum auctoritas* sank into a meaningless form, though as such it still survived in the time of Livy. From 287 onwards it is certain that measures passed by the *plebs*, voting by their tribes, had the full force of laws without any further conditions whatsoever. The legislative independence of the plebeian assembly was secured, and with this crowning victory ended the long struggle between the orders.

Opening of the magistracies.

398. 404.

417.

454.

(b) *Conquest of Italy*.—Twelve years after the passing of the *lex Hortensia*, King Pyrrhus, beaten at Beneventum, withdrew from Italy, and Rome was left mistress of the peninsula. The steps by which this supremacy had been won have now to be traced.⁵

The expulsion of the Tarquins from Rome, followed as it seems to have been by the emancipation from Etruscan supremacy of all the country between the Tiber and the Liris, entirely altered the aspect of affairs. North of the Tiber the powerful Etruscan city of Veii, after a vain attempt to restore the Tarquins, relapsed into an attitude of sullen hostility towards Rome, which, down to the outbreak of the final struggle in 407, found vent in constant and harassing border forays. The Sabines recommenced their raids across the Anio; from their hills to the south-east the Aequi pressed forward as far as the eastern spurs of the Alban range, and ravaged the low country between that range and the Sabine mountains; the Volsci overran the coast-lands as far as Antium, established them-

selves at Velitiae and even wasted the fields within a few miles of Rome. But the good fortune of Rome did not leave her to face these foes single-handed, and it is a significant fact that the history of the Roman advance begins, not with a brilliant victory, but with a timely alliance. According to Livy, it was in 493, only a few years after the defeat of the prince of Tusculum at Lake Regillus, that a treaty was concluded between Rome and the Latin communities of the Campagna.⁶ The alliance was in every respect natural. The Latins were the near neighbours and kinsmen of the Romans, and both Romans and Latins were just freed from Etruscan rule to find themselves as lowlanders and dwellers in towns face to face with a common foe in the ruder hill tribes on their borders. The exact terms of the treaty cannot, any more than the precise circumstances under which it was concluded, be stated with certainty (see LATIUM), but two points seem clear. There was at first a genuine equality in the relations between the allies; Romans and Latins, though combining for defence and offence, did so without sacrificing their separate freedom of action, even in the matter of waging wars independently of each other.⁷ But, secondly, Rome enjoyed from the first one inestimable advantage. The Latins lay between her and the most active of her foes, the Aequi and Volsci, and served to protect her territories at the expense of their own. Behind this barrier Rome grew strong, and the close of the Aequian and Volscian wars left the Latins her dependents rather than her allies. Beyond the limits of the Campagna Rome found a second ally, hardly less useful than the Latins, in the tribe of the Hernici ("the men of the rocks"), in the valley of the Trerus, who had equal reason with the Romans and Latins to dread the Volsci and Aequi, while their position midway between the two latter peoples made them valuable auxiliaries to the lowlanders of the Campagna.

The treaty with the Hernici is said to have been concluded in 486,⁸ and the confederacy of the three peoples—Romans, Latins and Hernicans—lasted down to the great Latin war in 340. Confused and untrustworthy as are the chronicles of the early wars of Rome, it is clear that, notwithstanding the acquisition of these allies, Rome made but little way against her foes during the first fifty years of the existence of the Republic. In 474, it is true, an end was put for a time to the harassing border feud with Veii by a forty years' peace, an advantage due not so much to Roman valour as to the increasing dangers from other quarters which were threatening the Etruscan states.⁹ But this partial success stands alone, and down to 449 the raids of Sabines, Aequi and Volsci continue without intermission, and are occasionally carried up to the very walls of Rome.

Very different is the impression left by the annals of the next sixty years (449–390). During this period there is an unmistakable development of Roman power on all sides. In southern Etruria the capture of Veii (396) virtually gave Rome the mastery as far as the Ciminian forest. Sutrium and Nepete, "the gates of Etruria," became her allies and guarded her interests against any attack from the Etruscan communities to the north, while along the Tiber valley her suzerainty was acknowledged as far as Capena and Falerii. On the Anio frontier we hear of no disturbances from 449 until some ten years after the sack of Rome by the Gauls. In 446 the Aequi appear for the last time before the gates of Rome. After 418 they disappear from Mount Algidus, and in the same year the communications of Rome and Latium with the Hernici in the Trerus valley were secured by the capture and colonization of Labicum. Successive invasions, too, broke the strength of the Volsci, and in 393 a Latin colony was founded as far south as Circeii. In part, no doubt, these Roman successes were due to the improved condition of

Legue with the Latins and Hernicans. 261.

268. 414. 280. 305. 305-64. Capture of Veii. 358. 308. 336.

8 Livy vi. 42.
9 Ibid. vii. 22; viii. 15; x. 6.
10 Ibid. viii. 12, "ut . . . ante initium suffragium patres auctores ferent," cf. Livy. l. 17. For the *lex Maenia*, see Cic. *Brut.* 14, 55; Soltau 112.
11 Plin. *N.H.* xvi. 10; Gell. xv. 27; Gaius i. 3, "plebscita lege Hortensia non minus valere quam leges."
12 For details of these wars see articles on the various cities, districts and tribes. For ethnographic and philological evidence see ITALY, *Ancient Peoples*.

8 Livy i. 33; Cic. *Pro Balbo*, 23.

9 Livy viii. 2.

10 From the Celts in the north especially.

11 Ibid. li. 41.

affairs in Rome itself, consequent upon the great reforms carried between 450 and 442; but it is equally certain that now, as often afterwards, fortune befriended Rome by weakening, or by diverting the attention of, her opponents. In particular, her rapid advance in southern Etruria was facilitated by the heavy blows inflicted upon the Etruscans during the 5th century B.C. by Celts, Greeks and Samnites. By the close of this century the Celts had expelled them from the rich plains of what was afterwards known as Cisalpine Gaul, and were even threatening to advance across the Apennines into Etruria proper. The Sicilian Greeks, headed by the tyrants of Syracuse, wrested from them their mastery of the seas, and finally, on the capture of Capua by the Samnites in 423, they lost their possessions in the fertile Campanian plain. These conquests of the Samnites were part of a great southward movement of the highland Sabellian peoples, the immediate effects of which upon the fortunes of Rome were not confined to the weakening of the Etruscan power. It is probable that the cessation of the Sabine raids across the Anio was partly due to the new outlets which were opened southwards for the restless and populous hill tribes which had so long disturbed the peace of the Latin lowlands. We may conjecture, also, that the growing feebleness exhibited by Volsci and Aequi was in some measure caused by the pressure upon their rear of the Sabellian clans which at this time established themselves near the Fucine lake and along the course of the Liris.

Decline of Etruscan power.

But in 390, only six years after the great victory over her ancient rival Veii, the Roman advance was for a moment checked by a disaster which threatened to alter the course of history in Italy, and which left a lasting impress on the Roman mind. In 391 a Celtic horde left their newly won lands on the Adriatic, and, crossing the Apennines into Etruria, laid siege to the Etruscan city of Clusium (Chiusi). Thence, provoked, it is said, by the conduct of the Roman ambassadors, who, forgetting their sacred character, had fought in the ranks of Clusium and slain a Celtic chief, the barbarians marched upon Rome. On July the 18th of 390 B.C., only a few miles from Rome, was fought the disastrous battle of the Allia. The defeat of the Romans was complete, and Rome lay at the mercy of her foe. But in characteristic fashion the Celts halted three days to enjoy the fruits of victory, and time was thus given to put the Capitol at least in a state of defence. The arrival of the barbarians was followed by the sack of the city, but the Capitol remained impregnable. For seven months they besieged it, and then in as sudden a fashion as they had come they disappeared. The Roman chroniclers explain their retreat in their own way, by the fortunate appearance of M. Furius Camillus with the troops which he had collected, at the very moment when famine had forced the garrison on the Capitol to accept terms. More probably the news that their lands across the Apennines were threatened by the Veneti, coupled with the unaccommodated tedium of a long siege and the difficulty of obtaining supplies, inclined the Celts to accept readily a heavy ransom as the price of their withdrawal. But, whatever the reason, it is certain that they retreated, and, though during the next fifty years marauding bands appeared at intervals in the neighbourhood of Rome, and even once penetrated as far south as Campania (361-60), the Celts never obtained any footing in Italy outside the plains in the north which they had made their own.

Nor, in spite of the defeat on the Allia and the sack of the city, was Rome weakened except for the moment by the Celtic attack. The storm passed away as rapidly as it had come on. The city was hastily rebuilt, and Rome dismayed the enemies who hastened to take advantage of her misfortunes by her undiminished vigour. Her conquests in southern Etruria were successfully defended against repeated attacks from the Etruscans to the north. The creation in 387 of four new tribes (Stellatina, Sabatina, Tromentina, Arnsensis) marked the final annexation of the territory of Veii and of the lands lying along the Tiber valley.

A few years later Latin colonies were established at Sutrium and Nepete for the more effectual defence of the frontier, and finally, in 353, the subjugation of South Etruria was completed by the submission of Caere (*q.v.*) and its partial incorporation with the Roman state as a "municipium sine suffragio"—the first, it is said, of its kind.¹

Next to the settlement of southern Etruria, the most important of the successes gained by Rome between 390 and 343 B.C. were those won against her old foes the Aequi and Volsci, and her old allies the Latins and Hernicans. The Aequi indeed, already weakened by their long feud with Rome, and hard pressed by the Sabellian tribes in their rear, were easily dealt with, and after the campaign of 389 we have no further mention of an Aequian war until the last Aequian rising in 304. The Volsci, who in 389 had advanced to Lanuvium, were met and utterly defeated by Camillus, the conqueror of Veii, and this victory was followed up by the gradual subjugation to Rome of all the lowland country lying between the hills and the sea as far south as Tarracina. Latin colonies were established at Satricum (385), at Setia (379), and at Antium and Tarracina some time before 348. In 358 two fresh Roman tribes (Pompina and Publilia) were formed in the same district.²

Rome had now nothing more to fear from the foes who a century ago had threatened her very existence. The lowland country, of which she was the natural centre, from the Ciminius forest to Tarracina, was quiet, and within its limits Rome was by far the strongest power. But she had now to reckon with the old and faithful allies to whose loyal aid her present position was largely due. The Latini and Hernici had suffered severely in the Aequian and Volscian wars; it is probable that not a few of the smaller communities included in the league had either been destroyed or been absorbed by larger states, and the independence of all alike was threatened by the growing power of Rome. The sack of Rome by the Celts gave them an opportunity of reasserting their independence, and we are consequently told that this disaster was immediately followed by the temporary dissolution of the confederacy, and this again a few years later by a series of actual conflicts between Rome and her former allies. Between 383 and 358 we hear of wars with Tibur, Praeneste, Tusculum, Lanuvium, Circeii and the Hernici. But in all Rome was successful. In 382 Tusculum was fully incorporated with the Roman state by the bestowal of the full franchise;³ in 358, according to both Livy and Polybius, the old alliance was formally renewed with Latini and Hernici. We cannot, however, be wrong in assuming that the position of the allies under the new league was far inferior to that accorded them by the treaty of Spurius Cassius.⁴ Henceforth they were the subjects rather than the equals of Rome, a position which it is evident that they accepted much against their will, and from which they were yet to make one last effort to escape.

We have now reached the close of the first stage in Rome's advance towards supremacy in Italy. By 343 B.C. she was already mistress both of the low country stretching from the Ciminius forest to Tarracina and Circeii and of the bordering highlands. Her own territory had largely increased. Across the Tiber the lands of Veii, Capena and Caere were nearly all Roman, while in Latium she had carried her frontiers to Tusculum on the Alban range and to the southernmost limits of the Pomptine district. And this territory was protected by a circle of dependent allies and colonies reaching northward to Sutrium and Nepete, and southward to Soraa on the upper Liris, and to Circeii on the coast. Already, too, she was beginning to be recognized as a power outside the

¹ For the status of Caere and the "Caerite franchise," see Marquardt, *Staatssagen*. i. 28 seq.; Madvig, *R. Verf.* i. 39; Beloch, *Ital. Bund*. i. 20; Mommsen, *Staatsr.* iii. 583 seq.

² Livy vii. 15.

³ Mommsen, *R.G.* i. 347 n.; Beloch, *Ital. Bund*, cap. ix.

⁴ *Ibid.* vi. 26.

Annexation of southern Etruria.

367.

Successes against Aequi and Volsci.

364-411.

365.

450.

369, 378.

406, 396.

Re-organization of the Latin league.

371-96.

372.

396.

411.

limits of the Latin lowlands. The fame of the capture of Rome by the Celts had reached Athens, and her subsequent victories over marauding Celtic bands had given her prestige in South

Italy as a bulwark against northern barbarians. In 406. 406. she had formed her first connexions beyond the Liris by a treaty with the Samnites, and in 348 followed a far more important treaty with the great maritime state of Carthage.¹

Rome had won her supremacy from the Ciminian forest to the Liris as the champion of the comparatively civilized communities of the lowlands against the rude highland tribes which threatened to overrun them, and so, when her legions first crossed the Liris, it was in answer to an appeal from a lowland city against invaders from the hills. While she was engaged in clearing Latium of Volsci and Aequi, the Sabellian tribes of the central Apennines had rapidly spread over the southern half of the peninsula. Foremost among these tribes were the Samnites, a portion of whom had captured the Etruscan city of Capua in

431, 334. 423, the Greek Cumae in 420, and had since then ruled as masters over the fertile Campanian territory. But in their new homes the conquerors soon lost all sense of relationship and sympathy with their highland brethren. They dwelt in cities, amassed wealth, and inherited the civilization of the Greeks and Etruscans whom they had dispossessed;² above all, they had before long to defend themselves in their turn against the attacks of their ruder kinsmen from the hills, and it was for aid against these that the Samnites of Campania appealed to the rising state which had already made herself known as the bulwark of the lowlands north of the Liris, and which with her Latin and Hernican allies had scarcely less interest than the Campanian cities themselves in checking the raids of the highland Samnite tribes.

The Campanian appeal was listened to. Rome with her confederates entered into alliance with Capua and the neighbouring Campanian towns, and war was formally declared (343) against the Samnites.³ While to the Latins and Hernicans was entrusted apparently the defence of Latium and the Hernican valley against the northerly members of the Samnite confederacy, the Romans themselves undertook the task of driving the invaders out of Campania. After two campaigns the war was ended in

341 by a treaty, and the Samnites withdrew from the lowlands, leaving Rome the recognized suzerain of the Campanian cities which had sought her aid.⁴

There is no doubt that the check thus given by Rome to the advance of the hitherto invincible Sabellian highlanders not only made her the natural head and champion of the low countries, south as well as north of the Liris, but also considerably added to her prestige. Carthage sent her congratulations; and the Etruscan city of Falerni voluntarily enrolled herself among the allies of Rome.⁵ Of even greater service, however, was the fact that for fifteen years the Samnites remained quiet, for this inactivity, whatever its cause, enabled Rome triumphantly to surmount a danger which threatened for the moment to wreck her whole position. This danger was nothing less than a desperate effort on the part of nearly all her allies and dependants south of the Tiber to throw off the yoke of her supremacy. The way was thrown by her ancient confederates

the Latini, whose smouldering discontent broke into open flame directly the fear of a Samnite attack was removed. From the Latin Campagna and the Sabine hills the revolt spread westward and southward to Antium and Tarracina, and even to the towns of the Campanian plain,

¹ Livy vii. 27. For the whole question of the early treaties with Carthage, see Polybius iii. 22; Mommsen, vol. ii. Appendix (p. 523); Strachan-Davidson, *Polybius*, pp. 50 ff.; Pais, *Storia di Roma*, i. 2, 305, n. 1; also article CARTHAGE.

² For the Samnites in Campania, see Mommsen, *Hist. of Rome*, i. 453; Schwieger-Clason, *R.G.* v. 98 seq.; Beloch, *Campanien* (Berlin, 1879).

³ Livy vii. 32.

⁴ For the difficulties in the traditional accounts of this war, see Mommsen, *Hist. of Rome*, i. 459 n.; Schwieger-Clason, *R.G.* v. 14 seq.

where the mass of the inhabitants at once repudiated the alliance formed with Rome by the ruling class. The struggle was sharp but short. In two pitched battles⁶ the strength of the insurrection was broken, and two more campaigns sufficed for the complete reduction of such of the insurgent communities as still held out. The revolt crushed, Rome set herself deliberately to the task of re-establishing on a new and firmer basis her supremacy over the lowlands, and in doing so laid the foundations of that marvellous organization of Latium; which was destined to spread rapidly over Italy, and to withstand the attacks even of Hannibal. The old historic Latin league ceased to exist, though its memory was still preserved by the yearly Latin festival on the Alban Mount. Most if not all of the common land of the league became Roman territory;⁷ five at least of the old Latin cities were compelled to accept the Roman franchise⁸ and enter the pale of the Roman state. The rest, with the Latin colonies, were ranked as Latin allies of Rome, but on terms which secured their complete dependence upon the sovereign city. The policy of isolation, which became so cardinal a principle of Roman rule, was now first systematically applied. No rights of *consubium* or *commercium* were any longer to exist between these communities. Their federal councils were prohibited, and all federal action independent of Rome forbidden.⁹

In Campania and the coast-lands connecting Campania with Rome, a policy of annexation was considered safer than that of alliance. Of the two frontier posts of the Volsci, Antium and Velitrae, the former was constituted a Roman colony, its long galleys burnt and their crews set up in the Forum at Rome, while the walls of Velitrae were razed to the ground, its leading men banished beyond the Tiber, and their lands given to Roman settlers. Farther south on the route to Campania, Fundi and Formiae were, after the precedent set in the case of Caere, declared Roman and granted the civil rights of Roman citizenship, while lastly in Campania itself the same status was given to Capua, Cumae, and the smaller communities dependent upon them.¹⁰ During the ten years from 338 to 328 the work of settlement was steadily continued. Tarracina, like Antium, was made a Roman colony. Privernum, the last Volscian town to offer resistance to Rome, was subdued in 330, part of its territory allotted to Roman citizens, and the state itself forced to accept the Roman franchise. Lastly, to strengthen the lines of defence against the Sabellian tribes, two colonies with the rights of Latin allies were established at Cales (334) and at Fregellae (328). The settlement of the lowlands was accomplished. As a single powerful and compact state with an outer circle of closely dependent allies, Rome now stood in sharp contrast with the disunited and degenerate cities of northern Etruria, the loosely organized tribes of the Apennines, and the decaying and disorderly Greek towns of the south.

The strength of this system was now to be tried by a struggle with the one Italian people who were still ready and able to contest with Rome the supremacy of the peninsula. The passive attitude of the Samnites between 342 and 327 was no doubt largely due to the dangers which had suddenly threatened them in South Italy. But the death of Alexander of Epirus, in 332,¹¹ removed their only formidable opponent there, and left them free to turn their attention to the necessity of checking the steady advance of Rome. In 327, the year after the ominous foundation of a Roman colony at Fregellae, a pretext for renewing the struggle was offered them. The

⁶ At the foot of Mount Vesuvius, Livy viii. 9; at Trifanum, *ibid.*, viii. 11.

⁷ *Ibid.*, loc. *cit.*; "ceteris Latinis populis conubia commerciaque et concilia inseri se ademerunt."

⁸ For the controversy as to the precise status of Capua and the "equites Campani" (Livy viii. 14), see Beloch, *Ital. Bund.*, 122 seq.; *idem*, *Campanien*, 317; Mommsen, *Staatsr.* iii. 574.

¹⁰ Livy viii. 3, 17, 24.

Cumaean colony of Palaepolis¹ had incurred the wrath of Rome by its raids into her territory in Campania. The Samnites sent a force to defend it, and Rome replied by a declaration of war. The two opponents were not at first sight unequally matched, and had the Sabellian tribes held firmly together the issue of the struggle might have been different. As it was, however, the Lucanians to the south actually joined Rome from the first, while the northern clans, Marsi, Vestini, Paelligni, Frentani, after a feeble and lukewarm resistance, subsided into
 450. a neutrality which was exchanged in 304 for a formal alliance with Rome. An even greater advantage to Rome from the outset was the enmity existing between the Samnites and the Apulians, the latter of whom from the first joined Rome and thus gave her a position in the rear of her enemy and in a country eminently well fitted for maintaining a large military force. These weaknesses on the Samnite side were amply illustrated by the events of the war.

The first seven or eight years were marked by one serious disaster to the Roman arms, the defeat at the Caudine Forks
 433, 436. (321), but, when in 318 the Samnites asked for and obtained a two years' truce, Rome had succeeded not only in inflicting several severe blows upon her enemies but in isolating them from outside help. The Lucanians to the south were her allies. To the east, in the rear of Samnium, Apulia acknowledged the suzerainty of Rome, and

434. Luceria, captured in 320, had been established as a base of Roman operations. Finally to the north the Romans had easily overcome the feeble resistance of the Vestini and Frentani, and secured through their territories a safe passage for their legions to Apulia. On the renewal of hostilities in
 438. 316, the Samnites, bent on escaping from the net which was being slowly drawn round them, made a series of desperate efforts to break through the lines of defence which protected Latium and Campania. Sora and Fregellae on the upper Liris were captured by a sudden attack; the Ausones in the low country near the mouth of the same river were encouraged to revolt by the appearance of the Samnite army; and in Campania another army, attracted by rumours of disturbance, all but defeated the Roman consuls under the very walls of Capua. But these efforts were unavailing. Sora and Fregellae were recovered as quickly as they had been lost, and the frontier there was strengthened by the establishment of a colony at Interamna. The Ausones were punished by the confiscation of their territory, and Roman supremacy further secured by the two colonies of Suessa and Pontia (312). The construction of the famous Via Appia,² the work of the censor Appius Claudius Caecus, opened a safe and direct route to Campania, while the capture of Nola deprived the Samnites of their last important stronghold in the Campanian lowlands. The failure of these attempts broke the courage even of the Samnites. Their hopes were indeed raised for a moment by the news that Etruria had risen against Rome (310), but their daring scheme of effecting a union with the Etruscans was frustrated

449. by the energy of the Roman generals. Five years later (305) the Romans avenged a Samnite raid into Campania by an invasion of Samnium itself. Arpinum on the frontier was taken, and at last, after a twenty-two years' struggle, the Second Samnite War was closed by a renewal of the ancient treaty with Rome (304).³

The six years of peace which followed (304-298) were employed by Rome in still further strengthening her position.
 440-86. Already, two years before the peace, a rash revolt of the Hernici⁴ had given Rome a pretext for finally annexing the territory of her ancient allies. The tribal confederacy was broken up, and all the Hernican communities, with the exception of three which had not joined the revolt, were incorporated with the Roman state as municipia, with the civil rights of the Roman franchise. Between the Hernican

valley and the frontiers of the nearest Sabellian tribes lay what remained of the once formidable people of the Aequi. In their case, too, a revolt (304) was followed by the annexation of their territory, which was marked in this case by the formation there (301) of two Roman tribes (Aniensis and Terentina).⁵ Not content with thus carrying the borders of their own territory up to the very frontiers of the Sabellian country, Rome succeeded (304) in finally detaching from the Sabellian confederacy all the tribes lying⁶ between the north-east frontier of Latium and the Adriatic Sea. Henceforward the Marsi, Paelligni, Vestini, Marrucini and Frentani were enrolled among the allies of Rome, and not only swelled her forces in the field but interposed a useful barrier between her enemies to the north in Etruria and Umbria and those to the south in Samnium, while they connected her directly with the friendly Apulians. Lastly, as a security for the fidelity at least of the nearest of these allies, colonies were planted in the Marsian territories at Alba Fucentia (303) and at Carsoli (298). A significant indication of the widening range of Rome's influence in Italy, and of the new responsibilities rapidly pressing upon her, is the fact that when in 302 the Spartan Cleonymus landed in the territory of the Salentini, far away in the south-east, he was met and repulsed by a Roman force.⁷

451, 456. Six years after the conclusion of the treaty which ended the Second Samnite War, news arrived that the Samnites were harassing the Lucanians. Rome at once interfered to protect her allies. Samnium was invaded in force, the country ravaged and one stronghold after another captured. Unable any longer to hold their own in a position where they were hedged round by enemies, the Samnite leaders turned as a last hope to the communities of northern Etruria, to the free tribes of Umbria and to the once dreaded Celts. With a splendid daring they formed the scheme of uniting all these peoples with themselves in a last desperate effort to break the power of Rome.

463. For some forty years after the final annexation of southern Etruria (351 B.C.) matters had remained unchanged in that quarter. Sutrium and Nepete still guarded the Roman frontier; the natural boundary of the Ciminius forest was still intact; and up the valley of the Tiber Rome had not advanced beyond Falerii, a few miles short of the most southerly Umbrian town Orculum. But in 311, on the expiry, apparently of the long truce with Rome, concluded in 351, the northern Etruscans, alarmed no doubt by the rapid advances which Rome was making farther south, rose in arms and attacked Sutrium. The attack, however, recoiled disastrously upon the heads of the assailants. A Roman force promptly relieved Sutrium, and its leader, Q. Fabius Rullianus, without awaiting orders from home, boldly plunged into the wilds of the Ciminius forest, and crossing them safely swept with fire and sword over the rich lands to the north. Then turning southward he met and utterly defeated the forces which the Etruscans had hastily raised in the hopes of intercepting him at the Vadimonian Lake.⁸ This decisive victory ended the war. The Etruscan cities, disunited among themselves, and enervated by long years of peace, abandoned the struggle for the time, paid a heavy indemnity and concluded a truce with Rome (309-8). In the same year the promptitude of Fabius easily averted a threatened attack by the Umbrians, but Rome proceeded nevertheless to fortify herself in her invariable fashion against future dangers on this side, by an alliance with Orculum, which was followed ten years later (299) by a colony at Nequinum,⁹ and an alliance with the Picentes, whose position in the rear

¹ Livy x. 9.² Ibid. ix. 45.³ Ibid. x. 2.⁴ Ibid. ix. 39. Inne (*Römische Geschichte*, i. 2 394 seq.) throws some doubts on the traditional accounts of this war and of that in 296.⁵ It received the name of Narnia (Livy x. 10).

Third Samnite War, 298-90-456-64.

Romans in N. Etruria.

403.

443.

445-46.

of Umbria rendered them as valuable to Rome as the Apulians had proved farther south.

Fourteen years had passed since the battle on the Vadimonian Lake, when the Samnites appeared on the borders of Etruria and called on the peoples of northern Italy to rise against the common enemy. Their appeal, backed by the presence of their troops, was successful. The Etruscans found courage to face the Roman legions once more; a few of the Umbrians joined them; but the most valuable allies to the Samnites were the Celts, who had for some time threatened a raid across the Apennines, and who now marched eagerly into Umbria and joined the coalition. The news that the Celts were in motion produced a startling effect at Rome, and every nerve was strained to meet this new danger. While two armies were left in southern Etruria as reserves, the two consuls, Q. Fabius Maximus Rullianus and P. Decius Mus the younger, both tried soldiers, marched northwards up the valley of the Tiber and into Umbria at the head of four Roman legions and a still larger force of Italian allies. At Sentinum, on the further side of the Apennines, they encountered the united forces of the Celts and Samnites, the Etruscans and Umbrians having, it is said, been withdrawn for the defence of their own homes. The battle that followed was desperate, and the Romans lost one of their consuls, Decius, and more than 8000 men.¹ But the Roman victory was decisive. The Celts were annihilated, and the fear of a second Celtic attack on Rome removed. All danger from the coalition was over. The Etruscan communities gladly purchased peace by the payment of indemnities. The rising in Umbria, never formidable, died away, and the Samnites were left single-handed to bear the whole weight of the wrath of Rome. During four years more, however, they desperately defended their highland

461, 462. homes, and twice at least, in 293 and 292, they managed to place in the field a force sufficient to meet the Roman legions on equal terms. At last, 464. in 290, the consul M. Curius Dentatus finally exhausted their power of resistance. Peace was concluded, and it is significant of the respect inspired at Rome by their indomitable courage that they were allowed to become the allies of Rome, on equal terms and without any sacrifice of independence.²

473. Between the close of the Third Samnite War and the landing of Pyrrhus in 281 B.C. we find Rome engaged, as her wont was, in quietly extending and consolidating her power. In southern Italy she strengthened her hold on Apulia by planting on the borders of Apulia and Lucania the strong colony of Venusia.³ In central Italy the annexation of the Sabine country (290) carried her frontiers eastward to the borders of her Picentine allies on the Adriatic.⁴ Farther east, in the territory of the Picentes themselves, she established colonies on the Adriatic coast at Hadria and Castrum (285-83).⁵ North of the Picentes lay the territories of the Celtic Senones stretching inland to the north-east borders of Etruria, and these too now fell into her hands. Ten years after their defeat at Sentinum (285-84) a Celtic force descended into Etruria, besieged Arretium and defeated the relieving force despatched by Rome. In 283 the consul L. Cornelius Dolabella was sent to avenge the insult. He completely routed the Senones. Their lands were annexed by Rome, and a colony established at Sena on the coast. This success, followed as it was by the decisive defeat of the neighbouring tribe of the Boii, who had invaded Etruria and penetrated as far south as the Vadimonian Lake, awed the Celts into quiet, and for more than forty years there was comparative tranquillity in northern Italy.⁶

In the south, however, the claims of Rome to supremacy

¹ Livy x. 27.
² Livy, *Epit.* xi., "pacem petentibus Samnitibus foedus quarto renovatum est."

³ Dion. Hal. *Exc.* xvi. xvii. 5; Vell. Pat. i. 14.

⁴ Livy, *Epit.* xi.; Vell. Pat. i. 14.

⁵ Livy, *Epit.* x. ⁶ *Ibid.* xii.; Polyb. ii. 20.

474. were now to be disputed by a new and formidable foe. At the close of the Third Samnite War the Greek cities on the southern coast of Italy found themselves once more harassed by the Sabelian tribes on their borders, whose energies, no longer absorbed by the long struggles in central Italy, now found an attractive opening southward. Naturally enough the Greeks, like the Capuans sixty years before, appealed for aid to Rome (283-82), and like the Capuans they offered in return to recognize the suzerainty of the great Latin Republic. In reply a Roman force under C. Fabricius Luscinus marched into south Italy, easily routed the marauding bands of Lucanians, Brutians and Samnites, and established Roman garrisons in Locri, Croton, Rhegium and Thurii. At Tarentum, the most powerful and flourishing of the Greek seaports, this sudden and rapid advance of Rome excited the greatest anxiety. Tarentum was already allied by treaty (301) with Rome, and she had now 453. to decide whether this treaty should be exchanged for one which would place her, like the other Greek communities, under the protectorate of Rome, or whether she should find some ally able and willing to assist in making a last stand for independence. The former course, in Tarentum, as before at Capua, was the one favoured by the aristocratic party; the latter was eagerly supported by the mass of the people and their leaders. While matters were still in suspense, the appearance, contrary to the treaty, of a Roman squadron off the harbour decided the controversy. The Tarentines, indignant at the insult, attacked the hostile fleet, killed the admiral and sunk most of the ships. Still Rome, relying probably on her partisans in the city, tried negotiation, and an alliance appeared likely after all, when suddenly the help for which the Tarentine democrats had been looking appeared, and war with Rome 473-74. was resolved upon (281-80).⁷

King Pyrrhus,⁸ whose timely appearance seemed for the moment to have saved the independence of Tarentum, was the most brilliant of the military adventurers whom the disturbed times following the death of Alexander the Great had brought into prominence. High-spirited, generous and ambitious, he had formed the scheme of rivaling Alexander's achievements in the East, by winning for himself an empire in the West. He aspired not only to unite under his rule the Greek communities of Italy and Sicily, but to overthrow the great Phœnician state of Carthage—the natural enemy of Greeks in the West, as Persia had been in the East. Of Rome it is clear that he knew little or nothing; the task of ridding the Greek seaports of their barbarian foes he no doubt regarded as an easy one; and the splendid force he brought with him was intended rather for the conquest of the West than for the preliminary work of chastising a few Italian tribes, or securing the submission of the unwelcome Italian Greeks. He defeated the Roman consul, M. Valerius Laevinus, on the banks of the Liris (280), and gained the support of the Greek cities 474. as well as that of numerous bands of Samnites, Lucanians and Brutians. But, to the disappointment of his new allies, Pyrrhus showed no anxiety to follow up his advantage. His heart was set on Sicily and Africa, and his immediate object was to come to terms with Rome. But though he advanced as near Rome as Anagnina (279), nothing could 475. shake the resolution of the senate, and in the next year (278) he again routed the legions at Asculum (Ascoli), but only to find that the indomitable resolution of the enemy was strengthened by defeat. He now crossed into Sicily, where, though at first successful, he was unable to achieve any lasting result. Soured and disappointed, Pyrrhus returned to Italy 476. (276) to find the Roman legions steadily moving southwards, and his Italian allies disgusted by his desertion of their cause. In 275 the decisive battle of the war 479. was fought at Beneventum. The consul, M. Curius Dentatus, the conqueror of Samnium, gained a complete victory, ⁷ Livy, *Epit.* xii.; Plut. *Pyrrh.* 13.
⁸ For his career and for the story of his wars with Rome, see the article PYRRHUS.

and Pyrrhus, unable any longer to face his opponents in the field, and disappointed of all assistance from his allies, retreated to disgust to Tarentum and thence crossed into Greece.¹

A few years later (272) Tarentum was surrendered to Rome by its Epirot garrison; it was granted a treaty of alliance, but its walls were razed and its fleet handed over to Rome. In 270 Rhegium also entered the ranks of Roman allies, and finally in 269 a single campaign crushed the last efforts at resistance in Samnium. Rome was now at leisure to consolidate the position she had won. Between 273 and 263 three new colonies were founded in Samnium and Lucania—Paestum in 273, Beneventum in 268, Aesernia in 263. In central Italy the area of Roman territory was increased by the full enfranchisement (268) of the Sabines,² and of their neighbours to the east, the people of Picenum.

To guard the Adriatic coast colonies were established at Ariminum (268), at Firmum and at Castrum Novum (264), while to the already numerous maritime colonies was added that of Cosa in Etruria.³

Rome was now the undisputed mistress of Italy. The limits of her supremacy to the north were represented roughly by a line drawn across the peninsula from the mouth of the Arno to the west to that of the Aesis on the east.⁴

Beyond this line lay the Ligurians and the Celts; all south of it was now united as "Italy" under the rule of Rome.

But the rule of Rome over Italy, like her wider rule over the Mediterranean coasts, was not an absolute dominion over conquered subjects. It was in form at least a confederacy under Roman protection and guidance; and the Italians, like the provincials, were not the subjects, but the "allies and friends" of the Roman people.⁵

In the treatment of these allies Rome consistently followed the maxim, *divide et impera*. In every possible way she strove to isolate them from each other, while binding them closely to herself. The old federal groups were in most cases broken up, and each of the members united with Rome by a special treaty of alliance. In Etruria, Latium, Campania and Magna Graecia the city state was taken as the unit; in central Italy where urban life was non-existent, the unit was the tribe. The northern Sabellian peoples, for instance—the Marsi, Paeligni, Vestini, Marrucini, Frentani—were now constituted as separate communities in alliance with Rome. In many cases, too, no freedom of trade or intermarriage was allowed between the allies themselves, a policy afterwards systematically pursued in the provinces. Nor were all these numerous allied communities placed on the same footing as regarded their relations with Rome herself. To begin with, a sharp distinction was drawn between the "Latin" and the general mass of Italian allies. The "Latin" of this period had little more than the name in common with the old thirty Latin peoples of the days of Spurius Cassius. With a few exceptions, such as Tibur and Praeneste, the latter had either disappeared or had been incorporated with the Roman state, and the Latins of 268 a.c. were almost exclusively the "Latin colonies," that is to say, communities founded by Rome, composed of men of Roman blood, and whose only claim to the title "Latin" lay in the fact that Rome granted to them some portion of the rights and privileges formerly enjoyed by the old Latin cities under the Cassian treaty.⁶ Though nominally allies, they were in fact offshoots of Rome herself, bound to her by community of race, language and interest, and planted as Roman garrisons among alien and conquered peoples. The Roman citizen who joined a Latin colony lost his citizenship—to have allowed him to retain it would no doubt have been regarded as enlarging too rapidly the limits of the citizen body; but he received in

exchange the status of a favoured ally. The member of a Latin colony had the right of *commercium* and down to 268⁷ of *conubium* also with Roman citizens. Provided they left sons and property to represent them at home, they were free to migrate to Rome and acquire the Roman franchise. In war-time they not only shared in the booty, but claimed a portion of any land confiscated by Rome and declared "public." These privileges, coupled with their close natural affinities with Rome, successfully secured the fidelity of the Latin colonies, which became not only the most efficient props of Roman supremacy, but powerful agents in the work of Romanizing Italy. Below the privileged Latins stood the Italian allies; and here again we know generally that there were considerable differences of status, determined in each case by the terms of their respective treaties with Rome. We are told that the Greek cities of Neapolis and Heraclea were among the most favoured;⁸ the Bruttii, on the other hand, seem, even before the Hannibalic War, to have been less generously treated. But beyond this we have no detailed information.

Rome, however, did not rely only on this policy of isolation. Her allies were attached as closely to herself as they were clearly separated from each other, and from the first she took every security for the maintenance of her own paramount authority. Within its own borders, each ally was left to manage its own affairs as an independent state.⁹ The badges which marked subjection to Rome in the provinces—the resident magistrate and the tribute—were unknown in Italy. But in all points affecting the relations of one ally with another, in all questions of the general interests of Italy and of foreign policy, the decision rested solely with Rome. The place of a federal constitution, of a federal council, of federal officers, was filled by the Roman senate, assembly and magistrates. The maintenance of peace and order in Italy, the defence of the coasts and frontiers, the making of war or peace with foreign powers, were matters the settlement of which Rome kept entirely in her own hands. Each allied state, in time of war, was called upon for a certain contingent of men, but, though its contingent usually formed a distinct corps under officers of its own, its numerical strength was fixed by Rome, it was brigaded with the Roman legions, and was under the orders of the Roman consul.¹⁰

This paramount authority of Rome throughout the peninsula was confirmed and justified by the fact that Rome herself was now infinitely more powerful than any one of her numerous allies. Her territory, as distinct from that of the allied states, covered something like one-third of the peninsula south of the Aesis. Along the west coast it stretched from Caere to the southern borders of Campania. Inland, it included the former territories of the Aequi and Hernici, the Sabine country, and even extended eastward into Picenum, while beyond these limits were outlying districts, such as the lands of the Senonian Celts, with the Roman colony of Sena, and others elsewhere in Italy, which had been confiscated by Rome and given over to Roman settlers. Since the first important annexation of territory after the capture of Veii (396), twelve new tribes had been formed,¹¹ and the number of male citizens registered at the census had risen from 152,000 to 290,000.¹² Within this enlarged Roman

¹ Livy, *Epit.* xiv.; Plut. *Pyrrh.* 26.

² Vell. Pat. i. 14; "suffragii ferendi jus Sabinis datum."

³ Ibid.; Livy, *Epit.* xv.

⁴ Mommsen, *Hist. of Rome*, ii. 60, note 1; Nissen, *Ital. Landeskunde*, i. p. 71.

⁵ Beloch, *Ital. Bund*, 203; Mommsen, *Hist. of Rome*, ii. 60, note 2.

⁶ For the *coloniae Latinae* founded before the First Punic War, see Beloch, 136 seq.

⁷ The year of the foundation of Ariminum, the first Latin colony with the restricted rights; Cic. *Pro Caec.* 35, 202; Mommsen, *Hist. of Rome*, ii. 52 n.; *Staatsr.* iii. 624; Marquardt, *Staatsverw.* i. 54; Beloch, 155-58, takes a different view.

⁸ Beloch, *Comp.* 39; Cic. *Pro Balbo*, 8, 21, 22, 50.

⁹ For the relation of the *socii Italici* to Rome, see Mommsen, *Hist. of Rome*, ii. 53 ff.; Beloch, *Ital. Bund*, cap. x.

¹⁰ Beloch, 203. The importance of this duty of the allies is expressed in the phrase, "socii nominis Latini quibus ex formula togatorum milites in terra Italia imperare solent."

¹¹ Four in South Etruria (387), two in the Pomptine territory (358), two in Latium (332), two in the territory of the southern Volsci and the Ager Falernus (313), two in the Aequian and Hernican territory (299).

¹² The total of thirty-five is completed in 241 by formation of the *Vulsi* and *Quirina*, probably in the Sabine and Picentine districts, enfranchised in 268. See Beloch, 32.

¹³ Livy, *Epit.* xvi.; Eutrop. ii. 18; Mommsen, *Hist. of Rome*, ii. 55 n.; Beloch, cap. iv. pp. 77 seq.

Rome the mistress of Italy.

The Italian allies.

The Roman state.

The Latins.

state were now included numerous communities with local institutions and government. At their head stood the Roman colonies (*coloniae civium Romanorum*), founded to guard especially the coasts of Latium and Campania.¹ Next to these eldest children of Rome came those communities which had been invested with the full Roman franchise, such, for instance, as the old Latin towns of Aricia, Lanuvium, Tusculum, Nomentum and Pedum. Lowest in the scale were those which had not been considered ripe for the full franchise, but had, like Caere, received instead the *civitas sine suffragio*, the civil without the political rights.² Their members, though Roman citizens, were not enrolled in the tribes, and in time of war served not in the ranks of the Roman legions but in separate contingents. In addition to these organized town communities, there were also the groups of Roman settlers on the public lands, and the dwellers in the village communities of the enfranchised highland districts in central Italy.

The administrative needs of this enlarged Rome were obviously such as could not be adequately satisfied by the system which had done well enough for a small city state with a few square miles of territory. The old centralization of all government in Rome itself had become an impossibility, and the Roman statesmen did their best to meet the altered requirements of the time. The urban communities within the Roman pale, colonies and *municipia*, were allowed a large measure of local self-government. In all we find local assemblies, senates and magistrates, to whose hands the ordinary routine of local administration was confided, and, in spite of differences in detail, e.g. in the titles and numbers of the magistrates, the same type of constitution prevailed throughout.³ But these local authorities were carefully subordinated to the higher powers in Rome. The local constitution could be modified or revoked by the Roman senate and assembly, and the local magistrates, no less than the ordinary members of the community, were subject to the paramount authority of the Roman consuls, praetors and censors. In particular, care was taken to keep the administration of justice well under central control. The Roman citizen in a colony or *municipium* enjoyed, of course, the right of appeal to the Roman people in a capital case. We may also assume that from the first some limit was placed to the jurisdiction of the local magistrate, and that cases falling outside it came before the central authorities. But an additional safeguard for the equitable and uniform administration of Roman law, in communities to many of which the Roman code was new and unfamiliar, was provided by the institution of *praefecti* (*praefecti iuri dicundo*),⁴ who were sent out annually, as representatives of the Roman praetor, to administer justice in the colonies and *municipia*. To *praefects* was, moreover, assigned the charge of those districts within the Roman pale where no urban communities, and consequently no organized local government, existed. In these two institutions, that of municipal government and that of *praefectures*, we have already two of the cardinal points of the later imperial system of government.

Lastly, the changes which the altered position and increased responsibilities of Rome had effected in her military system⁵ tended to weaken the intimate connexion between the Roman army in the field and the Roman people at home, and thus prepared the way for that complete breach between the two which in the end proved fatal to the Republic. It is true that service in the legion was still the first duty and the highest privilege of the fully qualified citizen. But this service was gradually altering in character. Though new legions were still raised each year for the summer

campaigns, this was by no means always accompanied, as formerly, by the disbandment of those already on foot, and this increase in the length of time during which the citizen was kept with the standards had, as early as the siege of Veii, necessitated a further deviation from the old theory of military service—the introduction of pay.⁶ Moreover, while in the early days of the Republic the same divisions served for the soldier in the legion and the citizen in the assembly, in the new manipular system,⁷ with its three lines, no regard was paid to civic distinctions, but only to length of service and military efficiency, while at the same time the more open order of fighting which it involved demanded of each soldier greater skill, and therefore a more thorough training in arms than the old phalanx. One other change resulted from the new military necessities of the time, which was as fruitful of results as the incipient separation between the citizen and the soldier. Under the early Republic, the chief command of the legions rested with the consuls of the year. But, as Rome's military operations increased in area and in distance from Rome, a larger staff became necessary, and the inconvenience of summoning home a consul in the field from an unfinished campaign became intolerable. The remedy found, that of prolonging for a further period the imperium of the consul, was first applied in 327 B.C. in the case of Q. Publilius Philo,⁸ and between 327 and 264 instances of this *prorogatio imperii* became increasingly common. This proconsular authority, originally an occasional and subordinate one, was destined to become first of all the strongest force in the Republic, and ultimately the chief prop of the power of the Caesars.

PERIOD B: ROME AND THE MEDITERRANEAN STATES, 265-146 B.C.—(a) *Conquest of the West*.—Though marked out by her geographical position as the natural centre of the Mediterranean, Italy had hitherto played no active part in Mediterranean politics, but, now that she was for the first time united, it was felt throughout the Mediterranean world that a new power had arisen, and Rome, as the head and representative of Italy, found herself irresistibly drawn into the vortex of Mediterranean affairs. Egypt sought her alliance, and Greek scholars began to interest themselves keenly in the history, constitution, and character of the Latin Republic which had so suddenly become famous. But Rome looked naturally westward rather than eastward. The western coasts of the peninsula were the most fertile and populous and wealthy; and it was in this direction that the natural openings for Italian commerce were to be found. It was, however, precisely on this side that Rome had serious ground for anxiety. Carthage was now at the height of her power. Her outposts were threateningly near to Italy in Sardinia and in Sicily, while her fleets swept the seas and jealously guarded for the benefit of Carthage alone the hidden treasures of the West. In the east of Sicily, Syracuse still upheld the cause of Greek independence against the hereditary foe of the Greek race; but Syracuse stood alone, and her resources were comparatively small. What Rome had to fear was the establishment, and that at no distant date, of an absolute Carthaginian domination over the Western seas—a domination which would not only be fatal to Italian commerce, but would be a standing menace to the safety of the Italian coasts.

It was above all things essential for Rome that the Carthaginians should advance no farther eastward. But already in 272 Tarentum had almost fallen into their grasp, and seven years later Rome was threatened with the establishment of Carthaginian rule at Messana, within sight of the Italian coast. The intervention of both powers in a quarrel between the Mamertines, a body of Campanian mercenaries who had occupied Messana, and Hiero II.

¹ Ostia, Antium, Tarracina, Minturnae, Sinuessa, and, on the Adriatic, Sena and Castrum Novum.

² To both these classes the term *municipia* was applied.

³ For details, see Beloch, *Ital. Bund.*, caps. v., vi., vii. The enfranchised communities in most cases retained the old titles for their magistrates, and hence the variety in their designations.

⁴ For the *praefecti*, see Mommsen, *Hist. of Rome*, ii. 49, 67, and *Staatsr.* ii. 608; Beloch, 130-33.

⁵ Mommsen, *Hist. of Rome*, ii. 72 seq.; Livy viii. 8; Polyb. vi. 17-42.

⁶ Livy iv. 59.

⁷ This system was probably introduced in order to meet the charge of the Celtic swordsmen, but it was perfected during the Samnite wars. See Marquardt, *Staatsverw.* iii. 350 seq.; Daremberg-Saglio, *Dictionnaire des antiquités*, s.v. "Legio" (Cagnat).

⁸ Livy viii. 23, "ut pro consul rem gereret quoad debellatum esset."

The Proconsulate.

427-90.

489-608.

First Punic War, 265-41-489-513.

of Syracuse, led to the outbreak of war between Rome and

Carthage in 264 B.C. The military history of the struggle which followed is treated in the article PUNIC WARS; it will suffice to note here that the war lasted until 241 B.C., when the Carthaginians were compelled to cede Sicily and the Lipari islands to Rome, and to pay an indemnity of 3200 talents (about £800,000).

The struggle was one in which both Rome and Carthage were serving an apprenticeship in a warfare the conditions of which were unfamiliar to both. The Roman legions were foes very unlike any against which the Carthaginian leaders had ever led their motley array of mercenaries, while Rome was called upon for the first time to fight a war across the sea, and to fight with ships against the greatest naval power of the age. The novelty of these conditions accounts for much of the vacillating and uncertain action observable on both sides. It is possible that Hamilcar had already made up his mind that Rome must be attacked and crushed in Italy, but his government attempted nothing more than raids upon the coast. There are indications also that some in the Roman senate saw no end to the struggle but in the destruction of Carthage; yet an invasion of Africa was only once seriously attempted, and then only a half-hearted support was given to the expedition. But these peculiarities in the war served to bring out in the clearest relief the strength and the weakness of the two contending states. The chief dangers for Carthage lay obviously in the jealousy exhibited at home of her officers abroad, in the difficulty of controlling her mercenary troops, and in the ever-present possibility of disaffection among her subjects in Libya—dangers which even the genius of Hannibal failed finally to surmount. Rome, on the other hand, was strong in the public spirit of her citizens, the fidelity of her allies, the valour and discipline of her legions. What she needed was a system which should make a better use of her splendid materials than one under which her plans were shaped from day to day by a divided senate, and executed by officers who were changed every year, and by soldiers most of whom returned home at the close of each summer's campaign.

The interval between the First and Second Punic Wars was employed by both Rome and Carthage in strengthening their respective positions. The eastern end of Sicily was still left under the rule of Hiero as the ally of Rome, but the larger western portion of the island became directly subject to Rome, and a temporary arrangement seems to have been made for its government, either by one of the two praetors, or possibly by a quaestor.¹ Sardinia and Corsica had not been surrendered to

Rome by the treaty of 241, but three years later (239), on the invitation of the Carthaginian mercenaries stationed in the islands, a Roman force occupied them; Carthage protested, but, on the Romans threatening war, she gave way, and Sardinia and Corsica were formally ceded to Rome, though it was some seven or eight years before all resistance on the part of the natives themselves was crushed.

In 227, however, the senate considered matters ripe for the establishment of a separate administration in her overseas possessions. In that year two additional praetors were elected; to one was assigned the charge of western Sicily, to the other that of Sardinia and Corsica,² and thus the first stones of the Roman provincial system were laid. Of at least equal importance for the security of the peninsula was the subjugation of the Celtic tribes in the valley of the Po. These, headed by the Boii and Insubres and assisted by levies from

the Celts to the westward, had in 225 alarmed the whole of Italy by invading Etruria and penetrating to Clusium, only three days' journey from Rome. Here, however, their courage seems to have failed them. They retreated northward along the Etruscan coast, until at Telamon their way was barred by the Roman legions, returning from Sardinia to the defence of Rome, while a second consular army hung upon their rear. Thus hemmed in, the Celts fought desperately,

¹ Marquardt, *Staatsverw.* i. 243; Mommsen, *Hist. of Rome*, ii. 209; Appian, *Sic.* 2.

² Livy, *Epit.* xx.

but were completely defeated and the flower of their tribesmen slain. The Romans followed up their success by invading the Celtic territory. The Boii were easily reduced to submission. The Insubres, north of the Po, resisted more obstinately, but by 222 the war was over, and all the tribes in the rich Po valley acknowledged the supremacy of Rome. The conquered Celts were not enrolled among the Italian allies of Rome, but were treated as subjects beyond the frontier. Three colonies were founded to hold them in check—Placentia (218) and Cremona in the territory of the Insubres, Mutina (183) in that of the Boii; and the great northern road (Via Flaminia) was completed as far as the Celtic border at Ariminum.

On the Adriatic coast the immediate interests of Rome were limited to rendering the sea safe for Italian trade. It was with this object that, in 229, the first Roman expedition crossed the Adriatic, and inflicted severe chastisement on the Illyrian pirates of the opposite coast.³ This expedition was the means of establishing for the first time direct political relations between Rome and the states of Greece proper, to many of which the suppression of piracy in the Adriatic was of as much importance as to Rome herself. Alliances were concluded with Corcyra, Epidamnus, and Apollonia; and embassies explaining the reasons which had brought Roman troops into Greece were sent to the Aetolians, the Achaeans, and even to Athens and Corinth. Everywhere they were well received, and the admission of the Romans to the Isthmian games⁴ (228) formally acknowledged them as the

natural allies of the free Greek states against both barbarian tribes and foreign despots. Meanwhile Carthage had acquired a possession which promised to compensate her for the loss of Sicily, Sardinia and Corsica. The genius of her greatest citizen and soldier, Hamilcar Barca, had appreciated the enormous value of the Spanish peninsula, and conceived the scheme of founding there a Carthaginian dominion which should not only add to the wealth of Carthage, but supply her with a base of operations for a war of revenge with Rome. The conquest of southern and eastern Spain, begun by Hamilcar (236-28) and carried on by his kinsman Hasdrubal (228-21), was completed by his son Hannibal, who, with all his father's genius, inherited also his father's hatred of Rome, and by 219 the authority of Carthage had been extended as far as the Ebro (see SPAIN, *History*). Rome had not watched this rapid advance without anxiety, but, probably owing to her troubles with the Celts, she had contented herself with stipulating (226) that Carthage should not carry her arms beyond the Ebro, so as to threaten Rome's ancient ally, the Greek Massilia (mod. Marseilles), and with securing the independence of the two nominally Greek communities, Emporiae and Saguntum,⁵ on the east coast.

But these precautions were of no avail against the resolute determination of Hannibal, with whom the conquest of Spain was only preliminary to an attack upon Italy, and who could not afford to leave behind him in Spain a state allied to Rome. In 219, therefore, disregarding the protests of a Roman embassy, he attacked and took Saguntum, an act which, as he had foreseen, rendered a rupture with Rome inevitable, while it set his own hands free for a further advance.

For the details of the war which followed, the reader may be referred to the articles PUNIC WARS, HANNIBAL, and SCIPHO. From the outbreak of hostilities until the crowning victory of Cannae in 216 Hannibal's career of success was unchecked; and the annihilation of the Roman army in that battle was followed by the defection of almost the whole of southern Italy, with the exception of the Latin colonies and the Greek coast towns. In 215, moreover, Philip V. of Macedon formed an alliance with Hannibal and threatened to invade Italy; in 214 Syracuse revolted, and in 212 the Greek cities in S. Italy went over to Hannibal. But the indomitable spirit

Second Punic War, 218-1—536-53.

³ Polyb. ii. 8 seq. ⁴ *Ibid.* ii. 12.

⁵ Livy *xxi.* 2. 5; Polyb. *iii.* 15, 31.

of the Romans asserted itself in the face of these crushing misfortunes. In 212 Syracuse was recovered; in 211 542, 543. Capua fell after a long siege which Hannibal failed to raise, even by his famous march up to the gates of Rome, and in the same year a coalition was formed in Greece against Philip V. of Macedonia, which effectually paralysed his offensive action. Hannibal was now confined to Lucania and Bruttium; and his brother Hasdrubal, marching from Spain to join him, was defeated and slain on the river Metaurus (207). 547.

The war in Italy was now virtually ended, for, though during four years more Hannibal stood at bay in a corner of Bruttium, he was powerless to prevent the restoration of Roman authority throughout the peninsula. Sicily was once more secure; and finally in 206, the year after the victory on the Metaurus, the successes of the young P. Scipio in Spain (211-6) were crowned by the complete expulsion of the Carthaginians from the peninsula. On his return from Spain Scipio eagerly urged an immediate invasion of Africa. The senate hesitated; but Scipio gained the day. He was elected consul for 205, and given the province of Sicily, with permission to cross into Africa if he thought fit. Voluntary contributions of men, money, and supplies poured in to the support of the popular hero; and by the end of 205 Scipio had collected in Sicily a sufficient force for his purpose. In 204 he crossed to Africa, where he was welcomed by the Numidian prince Massinissa, whose friendship he had made in Spain. In 203 he twice defeated the Carthaginian forces, and a large party at Carthage were anxious to accept his offer of negotiations. But the advocates of resistance triumphed.

Hannibal was recalled from Italy, and returned to fight his last battle against Rome at Zama, where Scipio, who had been continued in command as proconsul for 202 by a special vote of the people, won a complete victory. 552.

The war was over. The Roman assembly voted that the Carthaginian request for peace should be granted, and entrusted the settlement of the terms to Scipio and a commission of ten senators. Carthage was allowed to retain her territory in Africa; but she undertook to wage no wars outside Africa, and none inside without the consent of Rome. She surrendered all her ships but ten triremes, her elephants, and all prisoners of war, and agreed to pay an indemnity of 10,000 talents in fifty years. The Numidian Massinissa (q.v.) was rewarded by an increase of territory, and was enrolled among the "allies and friends" of the Roman people.

The battle of Zama decided the fate of the West. The power of Carthage was broken and her supremacy passed to Rome. Henceforth Rome had no rival to fear westward of Italy, and it rested with herself to settle within what limits her supremacy should be confined and what form it should take. For the next fifty years, however, Rome was too deeply involved in the affairs of the East to think of extending her rule far beyond the limits of the rich inheritance which had fallen to her by the defeat of Carthage; but within this area considerable advance was made in the organization and consolidation of her rule. In Sicily and Spain, the immediate establishment of a Roman government was imperatively necessary, if these possessions were not either to fall a prey to internal anarchy, or be recovered for Carthage by some second Hamilcar. Accordingly, we find that in Sicily the former dominions of Hiero were at once united with the western half of the island as a single province,¹ and that in Spain, after nine years of a provisional government (206-197), two provinces were in 197² definitely established, and each, like Sicily, assigned to one of the praetors for the year, two additional praetors being elected for the

The West under Roman rule.

631.

631. of Carthage; but within this area considerable advance was made in the organization and consolidation of her rule. In Sicily and Spain, the immediate establishment of a Roman government was imperatively necessary, if these possessions were not either to fall a prey to internal anarchy, or be recovered for Carthage by some second Hamilcar. Accordingly, we find that in Sicily the former dominions of Hiero were at once united with the western half of the island as a single province,¹ and that in Spain, after nine years of a provisional government (206-197), two provinces were in 197² definitely established, and each, like Sicily, assigned to one of the praetors for the year, two additional praetors being elected for the

¹ Livy xxvi. 40. The union was apparently effected in 210.
² Ibid. xxxii. 27; cf. Marquardt, *Staatsverw.* i. 252, and Hübner in *Hermes*, i. 105 seq.

purpose. But here the resemblance between the two cases ends. From 201 down to the outbreak of the Slave War in 136 there was unbroken peace in Sicily, and its part in the history is limited to its important functions in supplying Rome with corn and in provisioning and clothing the Roman legions.³ It became every year a more integral part of Italy; and a large proportion even of the land itself passed gradually into the hands of enterprising Roman speculators. The governors of the two Spains had very different work to do from that which fell to the lot of the Sicilian praetors. The condition of Spain required that year after year the praetors should be armed with the consular authority, and backed by a standing force of four legions, while more than once the presence of the consuls themselves was found necessary. Still, in spite of all difficulties, the work of pacification proceeded. To M. Porcius Cato, the censor, and to Tiberius Sempronius Gracchus (praetor and propraetor, 180-79), father of the two tribunes, is mainly due the credit of quieting the Celtiberian tribes of central Spain, and the government of Gracchus was followed by thirty years of comparative tranquillity. The insurrection headed by Viriathus in 149 was largely caused by exactions of the Roman magistrates themselves, while its obstinate continuance down to the capture of Numantia, in 133, was almost as much the result of the incapacity of the Roman commanders.⁴ But the re-settlement of the country by Scipio Africanus the younger in that year left all Spain, with the exception of the highland Astures and Cantabri in the north-west, finally and tranquilly subject to Rome. Roman traders and speculators flocked to the seaport towns and spread inland. The mines became centres of Roman industry; the Roman legionaries quartered in Spain year after year married Spanish wives, and when their service was over gladly settled down in Spain in preference to returning to Italy. The first Roman communities established outside Italy were both planted in Spain, and both owed their existence to the Roman legions.⁵

In Africa there was no question at first of the introduction of Roman government by the formation of a province (see AFRICA, ROMAN). Carthage, bound hand and foot by the treaty of 201, was placed under the jealous watch of the loyal prince of Numidia, who himself willingly acknowledged the suzerainty of Rome. But it was impossible for this arrangement to be permanent. Every symptom of reviving prosperity at Carthage was regarded at Rome with feverish anxiety, and neither the expulsion of Hannibal in 195 nor his death in 183 did much to check the growing conviction that Rome would never be secure while her rival existed. It was therefore with grim satisfaction that many in the Roman senate watched the increasing irritation of the Carthaginians under the harassing raids and encroachments of their favoured neighbour Massinissa, and waited for the moment when Carthage should, by some breach of the conditions imposed upon her, supply Rome with a pretext for interference. At last in 151 came the news that Carthage, in defiance of treaty obligations, was actually at war with Massinissa. The anti-Carthaginian party in the senate, headed by M. Porcius Cato, eagerly seized the opportunity, and war was declared, and nothing short of the destruction of their city itself was demanded from the despairing Carthaginians. The demand was refused, and in 149 the siege of Carthage begun. During the next two years little progress was made, but in 147 P. Cornelius Scipio Aemilianus, grandson by adoption of the conqueror of Hannibal, was, at the age of thirty-seven, and though

³ Livy xxvii. 5, "pace ac bello fidissimum annonae subsidium"; cf. xxvii. 27.
⁴ Some fresh light has been thrown upon the later campaigns in Spain by the recently discovered fragment of an epitome of Livy (Oxyrhynchus Papyri, iv. 668; Kornemann, *Die neue Liviusseptimae aus Oxyrhynchus* (1904).
⁵ Italica (206), Appian, *Iber.* 38; Carteia (171), Livy xliii. 3.

Africa--Third Punic War, 153-46=605-8. 559, 571. much to check the growing conviction that Rome would never be secure while her rival existed. It was therefore with grim satisfaction that many in the Roman senate watched the increasing irritation of the Carthaginians under the harassing raids and encroachments of their favoured neighbour Massinissa, and waited for the moment when Carthage should, by some breach of the conditions imposed upon her, supply Rome with a pretext for interference. At last in 151 came the news that Carthage, in defiance of treaty obligations, was actually at war with Massinissa. The anti-Carthaginian party in the senate, headed by M. Porcius Cato, eagerly seized the opportunity, and war was declared, and nothing short of the destruction of their city itself was demanded from the despairing Carthaginians. The demand was refused, and in 149 the siege of Carthage begun. During the next two years little progress was made, but in 147 P. Cornelius Scipio Aemilianus, grandson by adoption of the conqueror of Hannibal, was, at the age of thirty-seven, and though

³ Livy xxvii. 5, "pace ac bello fidissimum annonae subsidium"; cf. xxvii. 27.
⁴ Some fresh light has been thrown upon the later campaigns in Spain by the recently discovered fragment of an epitome of Livy (Oxyrhynchus Papyri, iv. 668; Kornemann, *Die neue Liviusseptimae aus Oxyrhynchus* (1904).
⁵ Italica (206), Appian, *Iber.* 38; Carteia (171), Livy xliii. 3.

only a candidate for the aedileship, elected consul, and given the command in Africa. In the next year (146) Carthage was taken and razed to the ground. Its territory became the Roman province of Africa, while Numidia, now ruled by the three sons of Massinissa, remained as an allied state under Roman suzerainty, and served to protect the new province against the raids of the desert tribes (see CARTHAGE).

In Italy itself the Hannibalic war had been followed by important changes. In the north the Celtic tribes paid for their sympathy with Hannibal by the final loss of all separate political existence. Cispadane Gaul, studded with colonies and flooded with Roman settlers, was rapidly Romanized. Beyond the Padus (Po) in Polybius's time Roman civilization was already widely spread. In the extreme north-east the Latin colony of Aquileia, the last of its kind, was founded in 181, to control the Alpine tribes, while in the north-west the Ligurians were held in check by the colony of Luna (180), and by the extensive settlements of Roman citizens and Latins made on Ligurian territory in 173.¹ In southern Italy the depression of the Greek cities on the coast, begun by the raids of the

Sabellian tribes, was completed by the repeated blows inflicted upon them during the Hannibalic struggle. Some of them lost territory;² all suffered from a decline of population and loss of trade; and their place was taken by such new Roman settlements as Brundisium (Brindisi) and Puteoli (Pozzuoli).³ In the interior the southern Sabellian tribes suffered scarcely less severely. The Brutii were struck off the list of Roman allies, and nearly all their territory was confiscated.⁴ To the Apulians and Lucanians no such hard measure was meted out; but their strength had been broken by the war, and their numbers dwindled; large tracts of land in their territories were seized by Rome, and allotted to Roman settlers, or occupied by Roman speculators. That Etruria also suffered from declining energy, a dwindling population, and the

spread of large estates is clear from the state of things existing there in 133. It was indeed in central Italy, the home of the Latins and their nearest kinsmen, and in the new Latin and Roman settlements throughout the peninsula that progress and activity were henceforth concentrated.

(b) *Rome in the East, 200-133.*—Ever since the repulse of Pyrrhus from Italy, Rome had been slowly drifting into closer contact with the Eastern states. With one of the three great powers which had divided between them the empire of Alexander, with Egypt, she had formed an alliance in 273, and the alliance had been cemented by the growth of commercial intercourse between the two countries.⁵ In 228 her chastisement of the Illyrian pirates had led naturally enough to the establishment of friendly relations with some of the states of Greece proper. In 214 the alliance between Philip V. and Hannibal, and the former's threatened attack on Italy, forced her into war with Macedon, at the head of a coalition of the Greek states against him, which effectually frustrated his designs against herself; at the first opportunity, however (205), she ended the war by a peace which left the position unchanged. The results of the war were not only to draw closer the ties which bound Rome to the Greek states, but to inspire the senate with a genuine dread of Philip's restless ambition, and with a bitter resentment against him for his union with Hannibal. The

events of the next four years served to deepen both these feelings. In 205 Philip entered into a compact with Antiochus III. of Syria for the partition between them

of the dominions of Egypt,⁶ now left by the death of Ptolemy Philopator to the rule of a boy-king. Antiochus was to take Coele-Syria and Phoenicia, while Philip claimed for his share the districts subject to Egypt on the coasts of the Aegean and the Greek islands. Philip no doubt hoped to be able to secure these unlawful acquisitions before the close of the Second Punic War should set Rome free to interfere with his plans. But the obstinate resistance offered by Attalus of Pergamum and the Rhodians upset his calculations. In 201 Rome made peace with Carthage, and the senate had leisure to listen to the urgent appeal for assistance which reached her from her Eastern allies. With Antiochus indeed the senate was not yet prepared to quarrel; but with Philip the senate had no thoughts of a peaceful settlement. Their animosity against him has been deepened by the assistance he had recently rendered to Carthage. Always an unsafe and turbulent neighbour, he would, if allowed to become supreme in the Aegean, prove as dangerous to her interests in the East as Carthage had been in the West. To cripple or at least to stay the growth of Philip's power was in the eyes of the senate a necessity; but it was only by representing a Macedonian invasion of Italy as imminent that they persuaded the assembly, which was longing for peace, to pass a declaration of war⁷ (200).

The war began in the summer of 200 B.C., and, though the landing of the Roman legions in Epirus was not followed, as had been hoped, by any general rising against Philip, yet the latter had soon to discover that, if they were not enthusiastic for Rome, they were still less inclined actively to assist himself. Neither by force nor by diplomacy could he make any progress south of Boeotia. The fleets of Pergamum and Rhodes, now the zealous allies of Rome, protected Attica and watched the eastern coasts. The Achaeans and Nabis of Sparta were obstinately neutral, while nearer home in the north the Epirotes and Aetolians threatened Thessaly and Macedonia. His own resources both in men and in money had been severely strained by his constant wars,⁸ and the only ally who could have given him effective assistance, Antiochus, was fully occupied with the conquest of Coele-Syria. It is no wonder then that, in spite of his dashing generalship and high courage, he made but a brief stand. T. Quinctius Flamininus (consul 198), in his first year of command, defeated him on the Aous, drove him back to the pass of Tempe, and in the next year utterly routed him at Cynoscephalae. Almost at the same moment the Achaeans, who had now joined Rome, took Corinth, and the Rhodians defeated his troops in Caria.⁹ Further resistance was impossible; Philip submitted, and early the next year a Roman commission reached Greece with instructions to arrange terms of peace. These were such as effectually secured Rome's main object in the war, the removal of all danger to herself and her allies from Macedonian aggression.¹⁰ Philip was left in possession of his kingdom, but was degraded to the rank of a second-rate power, deprived of all possessions in Greece, Thrace and Asia Minor, and forbidden, as Carthage had been in 201, to wage war without the consent of Rome, whose ally and friend he now became.

The second point in the settlement now effected by Rome was the liberation of the Greeks. The "freedom of Greece" was proclaimed at the Isthmian games amid a scene of wild enthusiasm,¹¹ which reached its height when two years later (194) Flamininus withdrew his troops even from the "three fetters of Greece"¹²—Chalcis, Demetrias and Corinth.¹³ There is no reason to doubt that, in acting thus, not only Flamininus himself, but the senate and people at home were influenced, partly at any rate, by feelings of genuine

¹ Livy xlii. 4.

² E.g. Tarentum, Livy xiv. 16. A Roman colony was established at Croton in 194, and a Latin colony (Copia) at Thurii in 193 (Livy xxv. 45. 53).

³ Brundisium was established in 246 (Livy, *Epit.* xix.) or 245 (Vell. i. 14). Puteoli was fortified during the Second Punic War and became a Roman colony in 194 (Livy xxxv. 45).

⁴ Appian, *Hann.* 61; Aul. Gell. x. 3; cf. Beloch, *Ital. Bund.*

⁵ Egypt had supplied corn to Italy during the Second Punic War (Polyb. ix. 44).

⁶ Polyb. iii. 2, xv. 20; Livy xxxi. 14.

⁷ *Ibid.* xxxi. 6, 7.

⁸ *Ibid.* xvii. 44-47; Livy xxxiii. 30-34.

⁹ *Ibid.* xxxiii. 32, 33.

¹⁰ *Ibid.* xxxiv. 48-52.

¹¹ *Ibid.* 18.

Second
Hann-
domin
War-
200-197-
554-57.

556.

The
liberation
of Greece.
560.

sympathy with the Greeks and reverence for their past. It is equally clear that no other course was open to them. For Rome to have annexed Greece, as she had annexed Sicily and Spain, would have been a flagrant violation of the pledges she had repeatedly given both before and during the war; the attempt would have excited the fiercest opposition, and would probably have thrown the Asiatic as well as the European Greeks into the arms of Antiochus. But a friendly and independent Greece would be at once a check on Macedon, a barrier against aggression from the East, and a promising field for Roman commerce. Nor while liberating the Greeks did Rome abstain from such arrangements as seemed necessary to secure the predominance of her own influence. In the Peloponnese, for instance, the Achaeans were rewarded by considerable accessions of territory; and it is possible that the Greek states, as allies of Rome, were expected to refrain from war upon each other without her consent.¹

Antiochus III. of Syria, Philip's accomplice in the proposed partition of the dominions of their common rival, Egypt, returned from the conquest of Coele-Syria (198) to learn first of all that Philip was hard pressed by the Romans, and shortly afterwards that he had been decisively beaten at Cynoscephalae. It was already too late to assist his formerly ally, but Antiochus resolved at any rate to lose no time in securing for himself the possessions of the Ptolemies in Asia Minor and in eastern Thrace, which Philip had claimed, and which Rome now pronounced free and independent. In 197-96 he overran Asia Minor and crossed into Thrace.² But Antiochus was pleasure-loving, irresolute, and no general, and it was not until 192 that the urgent entreaties of the Aetolians, and the withdrawal of the Roman troops from Greece, nerved him to the decisive step of crossing the Aegean; even then the force he took with him was so small as to show that he completely failed to appreciate the nature of the task before him.³ At Rome the prospect of a conflict with Antiochus excited great anxiety, and it was not until every resource of diplomacy had been exhausted that war was declared,⁴ and the real weakness which lay behind the once magnificent pretensions of the "king of kings" was revealed.

Had Antiochus acted with energy when in 192 he landed in Greece, he might have won the day before the Roman legions appeared. As it was, in spite of the warnings of Hannibal,⁵ who was now in his camp, and of the Aetolians, he frittered away valuable time between his pleasures at Chalcis and useless attacks on petty Thessalian towns. In 191

Glabrio landed at the head of an imposing force; and a single battle at Thermopylae broke the courage of Antiochus, who hastily recrossed the sea to Ephesus, leaving his Aetolian allies to their fate. But Rome could not pause here. The safety of her faithful allies, the Pergamenes and Rhodians, and of the Greek cities in Asia Minor, as well as the necessity of chastising Antiochus, demanded an invasion of Asia. A Roman fleet had already (191) crossed the Aegean, and in concert with the fleets of Pergamum and Rhodes worsted the navy of Antiochus.

In 190 the new consul L. Scipio, accompanied by his famous brother, the conqueror of Africa, led the Roman legion for the first time into Asia. At Magnesia ad Sipylum, in Lydia, he met and defeated the motley and ill-disciplined hosts of the great king.⁶ For the first time the West, under Roman leadership, successfully encountered the forces of the East, and the struggle began which lasted far on into the days of the emperors. The terms of the peace which followed the victory at Magnesia tell their own story clearly enough. There is no question, any more than in Greece, of annexation; the main object in view is that of securing the predominance of Roman interests and influence

throughout the peninsula of Asia Minor, and removing to a safe distance the only eastern power which could be considered dangerous.⁷ The line of the Halys and the Taurus range, the natural boundary of the peninsula eastward, was established as the boundary between Antiochus and the kingdoms, cities and peoples now enrolled as the allies and friends of Rome. This line Antiochus was forbidden to cross; nor was he to send ships of war farther west than Cape Sarpedon in Cilicia. Immediately to the west of this frontier lay Bithynia, Paphlagonia and the immigrant Celtic Galatae, and these frontier states, now the allies of Rome, served as a second line of defence against attacks from the east. The area lying between these "buffer states" and the Aegean was organized by Rome in such a way as should at once reward the fidelity of her allies and secure both her own paramount authority and safety from foreign attack. Pergamum and Rhodes were so strengthened—the former by the gift of the Chersonese, Lycycaonia, Phrygia, Mysia and Lydia, the latter by that of Lycia and Caria—as not only amply to reward their loyalty, but to constitute them effective props of Roman interests and effective barriers alike against Thracian and Celtic raids in the north and Syrian aggression in the south. Lastly, the Greek cities on the coast, except those already tributary to Pergamum, were declared free, and established as independent allies of Rome.

In a space of little over eleven years (200-189) Rome had broken the power of Alexander's successors and established throughout the eastern Mediterranean a Roman protectorate.

It was in the western half of this protectorate that the first steps in the direction of annexation were taken. The enthusiasm provoked by the liberation of the Greeks had died away, and its place had been taken by feelings of dissatisfied ambition or sullen resentment. Intermecine feuds and economic distress had brought many parts of Greece to the verge of anarchy, and, above all, the very foundations of the settlement effected in 197 were threatened by the reviving power and aspirations of Macedon. Loyally as Philip had aided Rome in the war with Antiochus, the peace of Magnesia brought him nothing but fresh humiliation. He was forced to abandon all hopes of recovering Thessaly, and he had the mortification to see the hated king of Pergamum installed almost on his borders as master of the Thracian Chersonese. Resistance at the time was unavailing, but from 189 until his death (179) he laboured patiently and quietly to increase the internal resources of his own kingdom,⁸ and to foment, by dexterous intrigue, feelings of hostility to Rome among his Greek and barbarian neighbours. His successor, Perseus, his son by a left-handed alliance, continued his father's work. He made friends among the Illyrian and Thracian princes, connected himself by marriage with Antiochus IV. of Syria and with Prusias of Bithynia, and, among the Greek peoples, strove, not without success, to revive the memories of the past glories of Greece under the Macedonian leadership of the great Alexander.⁹ The senate could no longer hesitate. They were well aware of the restlessness and discontent in Greece; and after hearing from Eumenes of Pergamum, and from their own officers, all details of Perseus's intrigues and preparations, they declared war.¹⁰ The struggle, in spite of Perseus's courage and the incapacity at the outset of the Roman commanders, was short and decisive. The sympathy of the Greeks with Perseus, which had been encouraged by the hitherto passive attitude assumed by Rome, instantly evaporated on the news that the Roman legions were on their way to Greece. No assistance came from Prusias or Antiochus, and Perseus's only allies were the Thracian king Cotys and the Illyrian Genthius. The victory gained by L. Aemilius Paulus at Pydna (168) ended the war.¹¹ Perseus became the prisoner of Rome, and as such died in Italy a few years later.¹² Rome had begun the war with the

554-65. Rome had broken the power of Alexander's successors and established throughout the eastern Mediterranean a Roman protectorate.

557-58. It was in the western half of this protectorate that the first steps in the direction of annexation were taken. The enthusiasm provoked by the liberation of the Greeks had died away, and its place had been taken by feelings of dissatisfied ambition or sullen resentment. Intermecine feuds and economic distress had brought many parts of Greece to the verge of anarchy, and, above all, the very foundations of the settlement effected in 197 were threatened by the reviving power and aspirations of Macedon. Loyally as Philip had aided Rome in the war with Antiochus, the peace of Magnesia brought him nothing but fresh humiliation. He was forced to abandon all hopes of recovering Thessaly, and he had the mortification to see the hated king of Pergamum installed almost on his borders as master of the Thracian Chersonese. Resistance at the time was unavailing, but from 189 until his death (179) he laboured patiently and quietly to increase the internal resources of his own kingdom,⁸ and to foment, by dexterous intrigue, feelings of hostility to Rome among his Greek and barbarian neighbours. His successor, Perseus, his son by a left-handed alliance, continued his father's work. He made friends among the Illyrian and Thracian princes, connected himself by marriage with Antiochus IV. of Syria and with Prusias of Bithynia, and, among the Greek peoples, strove, not without success, to revive the memories of the past glories of Greece under the Macedonian leadership of the great Alexander.⁹ The senate could no longer hesitate. They were well aware of the restlessness and discontent in Greece; and after hearing from Eumenes of Pergamum, and from their own officers, all details of Perseus's intrigues and preparations, they declared war.¹⁰ The struggle, in spite of Perseus's courage and the incapacity at the outset of the Roman commanders, was short and decisive. The sympathy of the Greeks with Perseus, which had been encouraged by the hitherto passive attitude assumed by Rome, instantly evaporated on the news that the Roman legions were on their way to Greece. No assistance came from Prusias or Antiochus, and Perseus's only allies were the Thracian king Cotys and the Illyrian Genthius. The victory gained by L. Aemilius Paulus at Pydna (168) ended the war.¹¹ Perseus became the prisoner of Rome, and as such died in Italy a few years later.¹² Rome had begun the war with the

557-58. It was in the western half of this protectorate that the first steps in the direction of annexation were taken. The enthusiasm provoked by the liberation of the Greeks had died away, and its place had been taken by feelings of dissatisfied ambition or sullen resentment. Intermecine feuds and economic distress had brought many parts of Greece to the verge of anarchy, and, above all, the very foundations of the settlement effected in 197 were threatened by the reviving power and aspirations of Macedon. Loyally as Philip had aided Rome in the war with Antiochus, the peace of Magnesia brought him nothing but fresh humiliation. He was forced to abandon all hopes of recovering Thessaly, and he had the mortification to see the hated king of Pergamum installed almost on his borders as master of the Thracian Chersonese. Resistance at the time was unavailing, but from 189 until his death (179) he laboured patiently and quietly to increase the internal resources of his own kingdom,⁸ and to foment, by dexterous intrigue, feelings of hostility to Rome among his Greek and barbarian neighbours. His successor, Perseus, his son by a left-handed alliance, continued his father's work. He made friends among the Illyrian and Thracian princes, connected himself by marriage with Antiochus IV. of Syria and with Prusias of Bithynia, and, among the Greek peoples, strove, not without success, to revive the memories of the past glories of Greece under the Macedonian leadership of the great Alexander.⁹ The senate could no longer hesitate. They were well aware of the restlessness and discontent in Greece; and after hearing from Eumenes of Pergamum, and from their own officers, all details of Perseus's intrigues and preparations, they declared war.¹⁰ The struggle, in spite of Perseus's courage and the incapacity at the outset of the Roman commanders, was short and decisive. The sympathy of the Greeks with Perseus, which had been encouraged by the hitherto passive attitude assumed by Rome, instantly evaporated on the news that the Roman legions were on their way to Greece. No assistance came from Prusias or Antiochus, and Perseus's only allies were the Thracian king Cotys and the Illyrian Genthius. The victory gained by L. Aemilius Paulus at Pydna (168) ended the war.¹¹ Perseus became the prisoner of Rome, and as such died in Italy a few years later.¹² Rome had begun the war with the

557-58. It was in the western half of this protectorate that the first steps in the direction of annexation were taken. The enthusiasm provoked by the liberation of the Greeks had died away, and its place had been taken by feelings of dissatisfied ambition or sullen resentment. Intermecine feuds and economic distress had brought many parts of Greece to the verge of anarchy, and, above all, the very foundations of the settlement effected in 197 were threatened by the reviving power and aspirations of Macedon. Loyally as Philip had aided Rome in the war with Antiochus, the peace of Magnesia brought him nothing but fresh humiliation. He was forced to abandon all hopes of recovering Thessaly, and he had the mortification to see the hated king of Pergamum installed almost on his borders as master of the Thracian Chersonese. Resistance at the time was unavailing, but from 189 until his death (179) he laboured patiently and quietly to increase the internal resources of his own kingdom,⁸ and to foment, by dexterous intrigue, feelings of hostility to Rome among his Greek and barbarian neighbours. His successor, Perseus, his son by a left-handed alliance, continued his father's work. He made friends among the Illyrian and Thracian princes, connected himself by marriage with Antiochus IV. of Syria and with Prusias of Bithynia, and, among the Greek peoples, strove, not without success, to revive the memories of the past glories of Greece under the Macedonian leadership of the great Alexander.⁹ The senate could no longer hesitate. They were well aware of the restlessness and discontent in Greece; and after hearing from Eumenes of Pergamum, and from their own officers, all details of Perseus's intrigues and preparations, they declared war.¹⁰ The struggle, in spite of Perseus's courage and the incapacity at the outset of the Roman commanders, was short and decisive. The sympathy of the Greeks with Perseus, which had been encouraged by the hitherto passive attitude assumed by Rome, instantly evaporated on the news that the Roman legions were on their way to Greece. No assistance came from Prusias or Antiochus, and Perseus's only allies were the Thracian king Cotys and the Illyrian Genthius. The victory gained by L. Aemilius Paulus at Pydna (168) ended the war.¹¹ Perseus became the prisoner of Rome, and as such died in Italy a few years later.¹² Rome had begun the war with the

557-58. It was in the western half of this protectorate that the first steps in the direction of annexation were taken. The enthusiasm provoked by the liberation of the Greeks had died away, and its place had been taken by feelings of dissatisfied ambition or sullen resentment. Intermecine feuds and economic distress had brought many parts of Greece to the verge of anarchy, and, above all, the very foundations of the settlement effected in 197 were threatened by the reviving power and aspirations of Macedon. Loyally as Philip had aided Rome in the war with Antiochus, the peace of Magnesia brought him nothing but fresh humiliation. He was forced to abandon all hopes of recovering Thessaly, and he had the mortification to see the hated king of Pergamum installed almost on his borders as master of the Thracian Chersonese. Resistance at the time was unavailing, but from 189 until his death (179) he laboured patiently and quietly to increase the internal resources of his own kingdom,⁸ and to foment, by dexterous intrigue, feelings of hostility to Rome among his Greek and barbarian neighbours. His successor, Perseus, his son by a left-handed alliance, continued his father's work. He made friends among the Illyrian and Thracian princes, connected himself by marriage with Antiochus IV. of Syria and with Prusias of Bithynia, and, among the Greek peoples, strove, not without success, to revive the memories of the past glories of Greece under the Macedonian leadership of the great Alexander.⁹ The senate could no longer hesitate. They were well aware of the restlessness and discontent in Greece; and after hearing from Eumenes of Pergamum, and from their own officers, all details of Perseus's intrigues and preparations, they declared war.¹⁰ The struggle, in spite of Perseus's courage and the incapacity at the outset of the Roman commanders, was short and decisive. The sympathy of the Greeks with Perseus, which had been encouraged by the hitherto passive attitude assumed by Rome, instantly evaporated on the news that the Roman legions were on their way to Greece. No assistance came from Prusias or Antiochus, and Perseus's only allies were the Thracian king Cotys and the Illyrian Genthius. The victory gained by L. Aemilius Paulus at Pydna (168) ended the war.¹¹ Perseus became the prisoner of Rome, and as such died in Italy a few years later.¹² Rome had begun the war with the

557-58. It was in the western half of this protectorate that the first steps in the direction of annexation were taken. The enthusiasm provoked by the liberation of the Greeks had died away, and its place had been taken by feelings of dissatisfied ambition or sullen resentment. Intermecine feuds and economic distress had brought many parts of Greece to the verge of anarchy, and, above all, the very foundations of the settlement effected in 197 were threatened by the reviving power and aspirations of Macedon. Loyally as Philip had aided Rome in the war with Antiochus, the peace of Magnesia brought him nothing but fresh humiliation. He was forced to abandon all hopes of recovering Thessaly, and he had the mortification to see the hated king of Pergamum installed almost on his borders as master of the Thracian Chersonese. Resistance at the time was unavailing, but from 189 until his death (179) he laboured patiently and quietly to increase the internal resources of his own kingdom,⁸ and to foment, by dexterous intrigue, feelings of hostility to Rome among his Greek and barbarian neighbours. His successor, Perseus, his son by a left-handed alliance, continued his father's work. He made friends among the Illyrian and Thracian princes, connected himself by marriage with Antiochus IV. of Syria and with Prusias of Bithynia, and, among the Greek peoples, strove, not without success, to revive the memories of the past glories of Greece under the Macedonian leadership of the great Alexander.⁹ The senate could no longer hesitate. They were well aware of the restlessness and discontent in Greece; and after hearing from Eumenes of Pergamum, and from their own officers, all details of Perseus's intrigues and preparations, they declared war.¹⁰ The struggle, in spite of Perseus's courage and the incapacity at the outset of the Roman commanders, was short and decisive. The sympathy of the Greeks with Perseus, which had been encouraged by the hitherto passive attitude assumed by Rome, instantly evaporated on the news that the Roman legions were on their way to Greece. No assistance came from Prusias or Antiochus, and Perseus's only allies were the Thracian king Cotys and the Illyrian Genthius. The victory gained by L. Aemilius Paulus at Pydna (168) ended the war.¹¹ Perseus became the prisoner of Rome, and as such died in Italy a few years later.¹² Rome had begun the war with the

557-58. It was in the western half of this protectorate that the first steps in the direction of annexation were taken. The enthusiasm provoked by the liberation of the Greeks had died away, and its place had been taken by feelings of dissatisfied ambition or sullen resentment. Intermecine feuds and economic distress had brought many parts of Greece to the verge of anarchy, and, above all, the very foundations of the settlement effected in 197 were threatened by the reviving power and aspirations of Macedon. Loyally as Philip had aided Rome in the war with Antiochus, the peace of Magnesia brought him nothing but fresh humiliation. He was forced to abandon all hopes of recovering Thessaly, and he had the mortification to see the hated king of Pergamum installed almost on his borders as master of the Thracian Chersonese. Resistance at the time was unavailing, but from 189 until his death (179) he laboured patiently and quietly to increase the internal resources of his own kingdom,⁸ and to foment, by dexterous intrigue, feelings of hostility to Rome among his Greek and barbarian neighbours. His successor, Perseus, his son by a left-handed alliance, continued his father's work. He made friends among the Illyrian and Thracian princes, connected himself by marriage with Antiochus IV. of Syria and with Prusias of Bithynia, and, among the Greek peoples, strove, not without success, to revive the memories of the past glories of Greece under the Macedonian leadership of the great Alexander.⁹ The senate could no longer hesitate. They were well aware of the restlessness and discontent in Greece; and after hearing from Eumenes of Pergamum, and from their own officers, all details of Perseus's intrigues and preparations, they declared war.¹⁰ The struggle, in spite of Perseus's courage and the incapacity at the outset of the Roman commanders, was short and decisive. The sympathy of the Greeks with Perseus, which had been encouraged by the hitherto passive attitude assumed by Rome, instantly evaporated on the news that the Roman legions were on their way to Greece. No assistance came from Prusias or Antiochus, and Perseus's only allies were the Thracian king Cotys and the Illyrian Genthius. The victory gained by L. Aemilius Paulus at Pydna (168) ended the war.¹¹ Perseus became the prisoner of Rome, and as such died in Italy a few years later.¹² Rome had begun the war with the

¹ Livy xxxviii. 55, xxxviii. 38; Polyb. xxi. 17.

² Livy xxxix. 24 seq. ³ Ibid. xlii. 5.

⁴ Ibid. xliii. 36-41; Plut. Aemil. 15 seq.

⁵ Diod. xxxi. 9; Livy xlv. 42; Polyb. xxxvii. 16.

fined resolution no longer of crippling but of destroying the Macedonian state. Perseus's repeated proposals for peace during the war had been rejected; and his defeat was followed by the final extinction of the kingdom of Philip and Alexander.¹ Macedonia, though it ceased to exist as a single state, was not, however, definitely constituted a Roman province.² On the contrary, the mistake was made of introducing some of the main principles of the provincial system—taxation, disarmament and the isolation of the separate communities—without the addition of the element most essential for the maintenance of order—that of a resident Roman governor. The four petty republics now created were each autonomous, and each separated from the rest by the prohibition of *commercium* and *conubium*, but no central controlling authority was substituted for that of the Macedonian king. The inevitable result was confusion and disorder, resulting finally (149-48) in the attempt of a pretender, Andronicus, who claimed to be a son of Perseus, to resuscitate the ancient monarchy.³ On his defeat in 148 the senate declared Macedonia a Roman province, and placed a Roman magistrate at its head.⁴

From 189 to the defeat of Perseus in 168 no formal change of importance in the status of the Greek states had been made by Rome. The senate, though forced year after year to listen to the mutual recriminations and complaints of rival communities and factions, contented itself as a rule with intervening just enough to remind the Greeks that their freedom was limited by its own paramount authority, and to prevent any single state or confederacy from raising itself too far above the level of general weakness which it was the interest of Rome to maintain. After the victory at Pydna, however, the sympathy shown for Perseus, exaggerated as it seems to have been by the interested representations of the romanizing factions in the various states, was made the pretext for a more emphatic assertion of Roman ascendancy. All those suspected of Macedonian leanings were removed to Italy, as hostages for the loyalty of their several communities,⁵ and the real motive for the step was made clear by the exceptionally severe treatment of the Achaeans, whose loyalty was not really doubtful, but whose growing power in the Peloponnese and independence of language had awakened alarm at Rome. A thousand of their leading men, among them the historian Polybius, were carried off to Italy (see POLYBIUS). In Aetolia the Romans connived at the massacre by their so-called friends of five hundred of the opposite party. Acarnania was weakened by the loss of Leucas, while Athens was rewarded for her unambitious loyalty by the gift of Delos and Samos.

But this somewhat violent experiment only answered for a time. In 148 the Achaeans rashly persisted, in spite of warnings, in attempting to compel Sparta by force of arms to submit to the league. When threatened by Rome with the loss of all that they had gained since Cynoscephalae, they madly rushed into war.⁶ They were easily defeated, and a "commission of ten," under the presidency of L. Mummius, was appointed by the senate thoroughly to resettle the affairs of Greece.⁷ Corinth, by orders of the senate, was burnt to the ground and its territory confiscated. Thebes and Chalcis were destroyed, and the walls of all towns which had shared in the last desperate outbreak were razed to the ground. All the existing confederacies were dissolved; no *commercium* was allowed between one community and another. Everywhere an aristocratic type of constitution, according to the invariable Roman practice, was established, and the pay-

ment of a tribute imposed. Into Greece, as into Macedonia in 167, the now familiar features of the provincial system were introduced—disarmament, isolation and taxation. The Greeks were still nominally free, and no separate province with a governor of its own⁸ was established, but the needed central control was provided by assigning to the neighbouring governor of Macedonia a general supervision over the affairs of Greece. From the Adriatic to the Aegean, and as far north as the river Drilo and Mount Scardus, the whole peninsula was now under direct Roman rule.⁹

Beyond the Aegean the Roman protectorate worked no better than in Macedonia and Greece, and the quarrels and disorders which flourished under its shadow were aggravated by its longer duration and by the still more selfish view taken by Rome of her responsibilities.¹⁰ At one period indeed, after the battle of Pydna, it seemed as if the more vigorous, if harsh, system then initiated in Macedon and Greece was to be adopted farther east also. The levelling policy pursued towards Macedon and the Achaeans was applied with less justice to Rome's two faithful and favoured allies, Rhodes and Pergamum. The former had rendered themselves obnoxious to Rome by their independent tone and still more by their power and commercial prosperity. On a charge of complicity with Perseus they were threatened with war, and though this danger was averted¹¹ they were forced to exchange their equal alliance with Rome for one which placed them in close dependence upon her, and to resign the lucrative possessions in Lycia and Caria given them in 180. Finally, their commercial prosperity was ruined by the establishment of a free port at Delos,¹² and by the short-sighted acquiescence of Rome in the raids of the Cretan pirates. With Eumenes of Pergamum no other fault could be found than that he was strong and successful; but this was enough. His brother Attalus was invited, but in vain, to become his rival. His turbulent neighbours, the Galatae, were encouraged to harass him by raids. Pamphylia was declared independent, and favours were heaped upon Prusias of Bithynia. These and other annoyances and humiliations had the desired effect. Eumenes and his two successors—his brother and son, Attalus II. and Attalus III.—contrived indeed by studious humility and dexterous flattery to retain their thrones, but Pergamum (*q.v.*) ceased to be a powerful state, and its weakness, added to that of Rhodes, increased the prevalent disorder in Asia Minor. During the same period we have other indications of a temporary activity on the part of Rome. The frontier of the protectorate was pushed forward to the confines of Armenia by alliances with the kings of Pontus and Cappadocia beyond the Halys. In Syria, on the death of Antiochus Epiphanes (164), Rome intervened to place a minor, Antiochus Eupator, on the throne, under Roman guardianship.¹³ In 168 Egypt formally acknowledged the suzerainty of Rome,¹⁴ and in 163 the senate, in the exercise of this new authority, restored Ptolemy Philometor to his throne, but at the same time weakened his position by handing over Cyrene and Cyprus to his brother Euergetes.¹⁵

But this display of energy was shortlived. From the death of Eumenes in 159 down to 133 Rome, secure in the absence of any formidable power in the East, and busy with affairs in Macedonia, Africa and Spain, relapsed into

¹ Mommsen, *loc. cit.* note; Marquardt, *Staatsverw.* i. 321 seq.; Niese, *Geschichte der griechischen und makedonischen Staaten*, iii. 358.

² North of the Drilo the former kingdom of Perseus's ally Genthius had been treated as Macedon was in 167 (*Livy* xlv. 26); cf. Zippel, *Röm. Herrschaft in Illyrien* (Leipzig, 1877). Epirus, which had been desolated after Pydna (*Livy* xlv. 34), went with Greece; Marquardt i. 319.

³ Mommsen, *Hist. of Rome*, ii. 510 ff., iii. 274 ff.

⁴ *Livy* xiv. 20; *Polyb.* xxx. 5.

⁵ *Polyb.* xxxi. 7. The Rhodian harbour dues suffered severely.

⁶ Rome had already intervened between Syria and Egypt: *Livy* xlv. 12; *Polyb.* xxxix. 11, xxxi. 12.

⁷ *Livy* xlv. 13. "Regni maximum praesidium in fide populi Romani."

⁸ *Ibid.* *Epit.* xlvii.

¹ *Livy* xlv. 9.

² *Ibid.* xlv. 17, 29; *Plut.* *Aemil.* 28; Mommsen, *Hist. of Rome*, ii. 508; *Thuc.* *Hist. of Rome*, iii. 258; Marquardt, *Staatsverw.* i. 316.

³ *Polyb.* xxxvii. 2; *Livy.* *Epit.* i.

⁴ For the boundaries of the province, see Ptolemy iii. 13; Marquardt, *loc. cit.*, 318 f.

⁵ *Livy* xlv. 31.

⁶ *Ibid.* *Epit.* li. ii.

⁷ *Ibid.* *Epit.* lii.; *Polyb.* xl. 9 seq.; Pausanias vii. 16; Mommsen, *Hist. of Rome*, iii. 270.

inactivity the disastrous results of which revealed themselves in the next period, in the rise of Mithradates of Pontus, the spread of Cretan and Cilician piracy, and the advance of Parthia.

Both the western and eastern Mediterranean now acknowledged the suzerainty of Rome, but her relations with the two were from the first different. The West fell to her as the prize of victory over Carthage, and, the Carthaginian power broken, there was no hindrance to the immediate establishment in Sicily, Sardinia, Spain, and finally in Africa, of direct Roman rule. To the majority, moreover, of her western subjects she brought a civilization as well as a government of a higher type than any before known to them. And so in the West she not only formed provinces but created a new and wider Roman world. To the East, on the contrary, she came as the liberator of the Greeks; and it was only slowly that in this part of the Empire her provincial system made way. In the East, moreover, the older civilization she found there obstinately held its ground. Her proconsuls governed and her legions protected the Greek communities, but to the last the East remained in language, manners and thought Greek and not Roman.

PERIOD C: THE PERIOD OF THE REVOLUTION (146-49 B.C.).—In the course of little more than a century, Rome had become the supreme power in the civilized world. By all men, says Polybius, it was taken for granted that nothing remained but to obey the commands of the Romans.¹ For the future the interest of Roman history centres in her attempts to perform the two Herculean tasks which this unique position laid upon her,—the efficient government of the subject peoples, and their defence against the barbarian races which swarmed around them on all sides. They were tasks under which the old republican constitution broke down, and which finally overtaxed the strength even of the marvellous organization framed and elaborated by Augustus and his successors.

Although in its outward form the old constitution had undergone little change during the age of war and conquest from 205 to 146,² the causes, both internal and external, which brought about its fall had been silently at work throughout. Its form was in strictness that of a moderate democracy. The patriciate had ceased to exist as a privileged caste,³ and there was no longer any order of nobility recognized by the constitution. The senate and the offices of state were in law open to all,⁴ and the will of the people in assembly had been in the most explicit and unqualified manner declared to be supreme alike in the election of magistrates, in the passing of laws, and in all matters touching the *caput* of a Roman citizen. But in practice the constitution had become an oligarchy. The senate, not the assembly, ruled Rome, and both the senate and the magistracies were in the hands of a class which, in defiance of the law, arrogated to itself the title and the privileges of a nobility.⁵ The ascendancy of the senate is too obvious and familiar a fact to need much illustration here. It was but rarely that the assembly was called upon to decide questions of policy, and then the proposal was usually made by the magistrate in obedience to the express directions of the senate.⁶ In the enormous majority of cases the matter was settled by a *senatus consultum*, without any reference to

Ascendancy of the senate.

Constitutional changes, 265-146-489-608.

534.

545.

¹ Polyb. iii. 4.
² The most important change was the assimilation of the division by classes and centuries with that by tribes, a change possibly due to the censorship of Gaius Flaminius in 220 (Mommsen, *Staatsr.* iii. 270). On this point see COMITIA.

³ A few offices of a more or less priestly character were still filled only by patricians, e.g. *rex sacrorum*, *flamen Dialis*. A plebeian first became *curio maximus* in 209 (Liv. xxviii. 8).

⁴ The *lectio senatus* was in the hands of the censors, but whether before Sulla's time their choice was subject to legal restrictions is doubtful (see SENATE).

⁵ Mommsen, *Hist. of Rome*, iii. 7; Lange, *Röm. Alterth.* ii. 1 ff.
⁶ Ex auctoritate *senatus*. The *lex Flaminia agraria* of 232 was an exception (Cic. *De senect.* 4; Polyb. ii. 21). In 167 B.C. a praetor brought the question of war with Rhodes directly before the assembly, but this was condemned as unprecedented (*nono maloque exemplo*, Liv. xlv. 21).

the people at all. The assembly decides for war or peace,⁷ but the conduct of the war and the conditions of peace are matters left to the senate (*q.s.*). Now and then the assembly confers a command upon the man of its choice, or prolongs the *imperium* of a magistrate,⁸ but, as a rule, these and all questions connected with foreign affairs are settled within the walls of the senate-house.⁹ It is the senate which year after year assigns the commands and fixes the number and disposition of the military forces,¹⁰ directs the organization of a new province,¹¹ conducts negotiations, and forms alliances. Within Italy, though its control of affairs was less exclusive, we find that, besides supervising the ordinary current business of administration, the senate decides questions connected with the Italian allies, sends out colonies, allots lands, and directs the suppression of disorders. Lastly, both in Italy and abroad it managed the finances.¹² Inseparably connected with this monopoly of affairs to the exclusion of the assembly was the control which in practice, if not in theory, the senate exercised over the magistrates. The latter had become what Cicero wrongly declares they were always meant to be, merely the subordinate ministers of the supreme council,¹³ which assigned them their departments, provided them with the necessary equipment, claimed to direct their conduct, prolonged their commands, and rewarded them with triumphs. It was now at once the duty and the interest of a magistrate to be in *auctoritate senatus*, "subject to the authority of the senate," and even the once formidable *tribuni plebis* are found during this period actively and loyally supporting the senate, and acting as its spokesmen in the assembly.¹⁴

The causes of this ascendancy of the senate are to be found firstly in the fact that the senate was the only body capable of conducting affairs in an age of incessant war. The voters in the assembly, a numerous, widely scattered body, could not readily be called together, and when assembled were very imperfectly qualified to decide momentous questions of military strategy and foreign policy. The senate, on the contrary, could be summoned in a moment,¹⁵ and included in its ranks all the skilled statesmen and soldiers of the commonwealth. The subordination of the magistrates was equally the result of circumstances, for, as the numbers of the magistrates, and also the area of government, increased, some central controlling power became absolutely necessary to prevent collisions between rival authorities, and to secure a proper division of labour, as well as to enforce the necessary concert and co-operation.¹⁶ No such power could be found anywhere in the republican system but in the senate, standing as it necessarily did in the closest relations with the magistrate, and composed as it was increasingly of men who were or had been in office.

Once more, behind both senate and magistrates, lay the whole power and influence of the new nobility.¹⁷ These *nobiles* were essentially distinct from the older and more legitimate patrician aristocracy. Every patrician was of course noble, but the majority of the "noble families" in 146 were not patrician but plebeian.¹⁸ The title had been gradually appropriated, since the opening of the magistracies, by those families whose members had held curule office, and had thereby acquired the *ius imaginum*. It was thus in theory within the reach of any citizen who could win election even to the curule aedileship, and moreover, it carried with it no legal privileges whatsoever. Gradually,

⁷ Liv. xxxi. 5, xxxiii. 25, xxxvii. 55.
⁸ *Ibid.* xxx. 27, &c.
⁹ Polyb. (vi. 15) expressly includes the prorogation of a command among the prerogatives of the senate.
¹⁰ Liv. xxvi. 1, "consules de republica, de administratione belli, de provinciis exercitibusque patres consuluerunt."
¹¹ *Ibid.* xlv. 18.
¹² *Ibid.*, *Hist. of Rome*, iv. 43; Polyb. vi. 13.
¹³ *Pro Sestio* 65, "quasi ministros gravissimi consilii."
¹⁴ Liv. xxvii. 5, xxxviii. 45.
¹⁵ Liv. xxii. 7. In 191 the senators were forbidden to leave Rome for more than a day, nor were more than five to be absent at once (Liv. xxvii. 3).
¹⁶ *Ibid.* xxvii. 35.
¹⁷ Mommsen, *Hist. of Rome*, iii. 7 ff.
¹⁸ E.g. Livii, Sempronii, Caecilii, Licinii, &c.

however, the ennobled plebeian families drew together, and combined with the older patrician *gentes* to form a distinct order. Office brought wealth and prestige, and both wealth and prestige were liberally employed in securing for this select circle a monopoly of political power, and excluding new men.¹ Already by the close of the period it was rare for any one but a noble to find his way into high office or into the senate. The senate and magistrates are the mouthpieces of this order, and identified with it in policy and interest. Lastly, it must be allowed that both the senate and the nobility had to some extent justified their power by the use they made of it. It was their tenacity of purpose and devoted patriotism which had carried Rome through the dark days of the Hannibalic War. The heroes of the struggle with Carthage belonged to the leading families; the disasters at the Trasimene Lake and at Cannae were associated with the blunders of popular favourites.

From the first, however, there was an inherent weakness in this senatorial government. It had no sound constitutional basis, and with the removal of its accidental supports it fell to the ground. Legally the senate had no positive authority. It could merely advise the magistrate when asked to do so, and its decrees were strictly only suggestions to the magistrate, which he was at liberty to accept or reject as he chose.² It had, it is true, become customary for the magistrate not only to ask the senate's advice on all important points, but to follow it when given. But it was obvious that if this custom were weakened, and the magistrates chose to act independently, the senate was powerless. It might indeed anathematize³ the refractory official, or hamper him if it could by setting in motion against him a colleague or the tribunes, but it could do no more, and these measures failed just where the senate's control was most needed and most difficult to maintain—in its relations with the generals and governors of provinces abroad. The virtual independence of the proconsul was before 146 already exciting the jealousy of the senate and endangering its supremacy.⁴ Nor again had the senate any legal hold over the assembly. Except in certain specified cases, it rested with the magistrate to decide whether any question should be settled by a decree of the senate or a vote of the assembly.⁵ If he decided to make a proposal to the assembly, he was not bound except by custom to obtain the previous approval of the senate,⁶ and the constitution set no limits to the power of the assembly to decide any question whatsoever that was laid before it.

587. From 167, at least, onwards, there were increasing indications that both the acquiescence of the people in senatorial government and the loyalty of the magistrates to the senate were failing. The absorbing excitement of the great wars had died away; the economic and social disturbance and distress which they produced were creating a growing feeling of discontent; and at the same time the senate provoked inquiries into its title to govern by its failure any longer to govern well. In the East there was confusion; in the West a single native chieftain defied the power which had crushed Carthage. At

¹ Livy xiii. 34. "plebeios nobiles... contempnere plebem, ex quo contemni a patribus desierint, coepisse"; cf. Sall. Jug. 41. "paucorum arbitrio belli domique agitabatur; penes eosdem aerarium, provincia, magistratus." Mommsen, *Hist. of Rome*, iii. 15 n. The number of new families ennobled dwindles rapidly after 200 B.C.; Willems, *Le Sénat de la république romaine*, i. 366 seq. (Paris, 1878).

² The senators' whole duty is "sententiam dicere." The senator was asked "quid censes?"; the assembly "quid velitis jubeteis?"; Cf. also the saving clause, "Si eis videretur" ("sc. consulibus, &c.") in Seta., e.g. Cic. Phil. v. 19, 53.

³ By declaring his action to be "contra republicam." The force of this anathema varied with circumstances. It had no legal value.

⁴ Livy xxxviii. 42, of Cn. Manlius Vulso in Asia, 189 B.C.; cf. also the position of the two Scipios.

⁵ Hence the same things, e.g. founding of colonies, are done in one year by a *Scetum*., in another by a *lex*; cf. Cic. *De rep.* ii. 32, 56; *Phil.* i. 2, 6, of Antony, as consul, "mutata omnia, nihil per senatum, omnia per populum."

⁶ There was no legal necessity, before Sulla's time, for getting the *senatus auctoritas* for a proposal to the assembly.

home the senate was becoming more and more simply an organ of the nobility, and the nobility were becoming every year more exclusive, more selfish, and less capable and unanimous.⁷

But if the senate was not to govern, the difficulty arose of finding an efficient substitute, and it was this difficulty that mainly determined the issue of the struggles which convulsed Rome from 133 to 49. As the event showed, neither the assembly nor the numerous and disorganized magistracy was equal to the work; the magistrates were gradually pushed aside in favour of a more centralized authority, and the former became only the means by which this new authority was first encouraged in opposition to the senate and finally established in a position of impregnable strength. The assembly which made Pompey and Caesar found out too late that it could not unmake them.

It is possible that these constitutional and administrative difficulties would not have proved so rapidly fatal to the Republic had not its very foundations been sapped by the changes which followed more or less directly on the conquests of the 3rd and 2nd centuries B.C. For the opening of the world to Rome, and of Rome to the world, produced a radical change in the structure of Roman society. The subjugation of the Mediterranean countries, by placing at the disposal of Rome the vast natural resources of the West and the accumulated treasures of the East, caused a rapid rise in the standard of wealth and a marked change in its distribution. The Roman state was enabled to dispense with the direct taxation of its citizens,⁸ since it derived all the revenue which it needed from the subject countries. But the wealth drawn from the provinces by the state was trifling in amount compared with that which flowed into the pockets of individual citizens. Not only was the booty taken in war largely appropriated by the Roman commanders and their men, but a host of money-makers settled upon the conquered provinces and exploited them for their profit. The nobles engaged in the task of administration, the contractors (*publicani*) who farmed the revenues, and the "men of business" (*negotiantes*) who, as money-lenders, merchants or speculators, penetrated to every corner of the Empire, reaped a rich harvest at the expense of the provincials. Farming in Italy on the old lines became increasingly laborious and unprofitable owing to the importation of foreign corn and foreign slaves,⁹ and capitalists sought easier methods of acquiring wealth. If this had meant that capital was expended in developing the natural resources of the provinces, the result would have been to increase the prosperity of the countries subject to Rome; but it was not so. The Roman *negotiantes*, who were often merely the agents of the great families of Rome, drained the accumulated wealth of the provinces by lending money to the subject communities at exorbitant rates of interest. Cicero, for example, found when governor of Cilicia that M. Junius Brutus had lent a large sum to the people of Salamis in Cyprus at 48% compound interest; and we cannot suppose that this was an exceptional case. Such practices as these, together with the wasteful and oppressive system of tax-farming, and the deliberate extortions carried on by senatorial governors, reduced the flourishing cities of the Greek East, within the space of two generations, to utter economic exhaustion.

But the reaction of the same process on Rome herself had far more important consequences. The whole structure of Roman society was altered, and the equality and homogeneity which had once been its chief characteristics were destroyed. The Roman nobles had not merely ceased, as in old days, to till their own farms; they had found a means of enriching themselves beyond the dreams of avarice,

⁷ See generally Mommsen, *Hist. of Rome*, i. bk. ii. cap. 6; Lange, *Röm. Alterth.* vol. ii.; Ihne, *bk. v. cap. i.* The first law against bribery at elections was passed in 181 B.C. (Livy xl. 19), and against managerial extortion in the provinces in 149 (*Lex Calpurnia de pecuniis repetundis*). The senators had special seats allotted to them in the theatre in 194 B.C.; Livy xxiv. 44, 54.

⁸ The *tributum* was no longer levied after 167 B.C. (Cic. *Off.* ii. 22; Plin. *H.N.* xxxiii. 56).

⁹ See, however, p. 637, note 1 and ref.

Effects of conquest on Roman society; the new wealth.

621-705.

Accentuation of class distinctions.

and when they returned from the government of a province it was to build sumptuous villas, filled with the spoils of Greece and Asia, to surround themselves with troops of slaves and dependants, and to live rather as princes than as citizens of a republic. The *publicani* and *negotiores* formed a second order in the state, which rivalled the first in wealth and coveted a share in its political supremacy; while the third estate, the *plebs urbana*, was constantly increasing in numbers and at the same time sinking into the condition of an idle proletariat. The accentuation of class distinctions is indeed inevitable in a capitalist society, such as that of Rome was now becoming. But the process was fraught with grave political danger owing to the peculiarities of the Roman constitution, which rested in theory on the ultimate sovereignty of the people, who were in practice represented by the city mob. To win the support of the *plebs* became a necessity for ambitious politicians, and the means employed for this end poisoned the political life of Rome. The wealth derived from the provinces was freely spent in bribery,¹ and the populace of Rome was encouraged to claim as the price of its support a share in the spoils of empire.

It was not only the structure and composition of Roman society that underwent a transformation. The victory of Rome in her struggle for supremacy in the Mediterranean basin had been largely due to the powerful conservative forces by which her institutions were preserved from decay. Respect for the *mos majorum*, or ancestral custom, imposed an effective check on the desire for innovation. Though personal religion, in the deeper sense, was foreign to the Roman temperament, there was a genuine belief in the gods whose favour had made Rome great in the past and would uphold her in the future so long as she trod in the old paths of loyalty and devotion. Above all, the healthy moral traditions of early Rome were maintained by the discipline of the family, resting on the supreme authority of the father—the *patria potestas*—and the powerful influence of the mother, to whom the early training of the child was entrusted.² Finally, the institution of the censorship, backed as it was by the mighty force of public opinion, provided a deterrent which prevented any flagrant deviation from the accepted standard of morals. All this was changed by the influence of Greek civilization, with which Rome was first brought face to face in the 3rd century B.C. owing to her relations with Magna Graecia. At first the results of contact with the older and more brilliant culture of Hellas were on the whole good. In the 2nd century B.C., when constant intercourse was established with the communities of Greece proper and of Asia Minor, "philhellenism" became a passion, which was strongest in the best minds of the day and resulted in a quickened intellectual activity, wider sympathies and a more humane life. But at the same time the "new learning" was a disturbing and unsettling force. The Roman citizen was confronted with new doctrines in politics and religion, and initiated into the speculations of critical philosophy.³ Under the influence of this powerful solvent the fabric of tradition embodied in the *mos majorum* fell to pieces; a revolt set in against Roman discipline and Roman traditions of self-effacement, and the craving for individual distinction asserted itself with irresistible vehemence. As it had been in the days of the "Sophistic" movement at Athens, so it was now with Rome; a higher education, which, owing to its expense, was necessarily confined to the wealthier classes, interposed between the upper and lower ranks of society a barrier even more effectual than that set up by differences of material condition, and by releasing the individual from the trammels of traditional morality, gave his ambition free course. The effect on private morals may be gauged by the vehemence with which the reactionary opposi-

¹ From 181 B.C. onwards a succession of laws de ambitu were passed to prevent bribery, but without effect.

² Cf. Tacitus's account of Cornelia, the mother of the Gracchi, and Aurelia, the mother of Julius Caesar, in the dialogue *De oratoribus*, c. 28.

³ It is to be noted that these subjects were, generally speaking, taught by freedmen or slaves.

tion, headed by M. Porcius Cato (consul, 195 B.C.; censor, 184 B.C.), inveighed against the new fashions, and by the list of measures passed to check the growth of luxury and licence, and to exclude the foreign teachers of the new learning.⁴ It was all in vain. The art of rhetoric, which was studied through the medium of Greek treatises and Greek models, furnished the Roman noble with weapons of attack and defence of which he was not slow to avail himself in the forum and the senate-house. In the science of money-making, which had been elaborated under the Hellenistic monarchies, the Roman capitalists proved apt pupils of their Greek teachers. Among the lower classes, contact with foreign slaves and freedmen, with foreign workshops and foreign vices, produced a love of novelty which no legislation could check. Even amongst women there were symptoms of revolt against the old order, which showed itself in a growing freedom of manners and impatience of control,⁵ the marriage tie was relaxed,⁶ and the respect for mother and wife, which had been so powerful a factor in the maintenance of the Roman standard of morals, was grievously diminished. Thus Rome was at length brought face to face with a moral and economic crisis which a modern historian has described in the words: "Italy was living through the fever of moral disintegration and incoherence which assails all civilized societies that are rich in the manifold resources of culture and enjoyment, but tolerate few or no restraints on the feverish struggle of contending appetites." In this struggle the Roman Republic perished, and personal government took its place. The world had outgrown the city-state and its political machinery, and as the notions of federalism (on any large scale) and representative government had not yet come into being, no solution of the problem was possible save that of absolutism. But a far stronger resistance would have been opposed to political revolution by the republican system had not public morals been sapped by the influences above described. Political corruption was reduced to a science? for the benefit of individuals who were often faced with the alternatives of ruin or revolution;⁸ there was no longer any body of sound public opinion to which, in the last resort, appeal could be made; and, long before the final catastrophe took place, Roman society itself had become, in structure and temper, thoroughly un-republican.

The first systematic attack upon the senatorial government is connected with the names of Tiberius and Gaius Gracchus (q.v.) and its immediate occasion was an attempt to deal with no less a danger than the threatened disappearance of the class to which of all others Rome owed most in the past.⁹ The small landholders throughout the greater part of Italy were sinking deeper into ruin under the pressure of accumulated difficulties. The Hannibalic war had laid waste their fields and thinned their numbers, nor when peace returned to Italy did it bring with it any revival of prosperity. The heavy burden of military service still pressed ruinously upon them,¹⁰ and in addition they were called upon to compete with the foreign corn

⁴ In 161 B.C. a decree of the senate was passed against "philosophi et rhetores Latini, ut Romae ne essent" (Gell. xv. 11). In 155 B.C. the philosopher Carneades was expelled from Rome (Plut. *Cato*. 22).

⁵ The elder Cato complained of this as early as 195 B.C. (Liv. xxxiv. 2).

⁶ Divorce was unknown at Rome until 231 B.C. (Dionys. ii. 25). In the last century of the Republic it was of daily occurrence.

⁷ In the Ciceronian period the lower classes of Rome, with whom the voting power in the *comitia* rested, were openly organized for purposes of bribery by means of *collegia* and *sodalicia*, nominally religious bodies.

⁸ Caesar had accumulated debts amounting to £800,000 by the time of his praetorship. Catiline and his fellow-bankrupts, amongst whom were several women, including a certain Sempronio who, as we are told by Sallust, "danced and played better than an honest woman need do," hoped to bring about a cancelling of debts (*novae tabulae*).

⁹ For authorities, see under GRACCHUS.

¹⁰ To Spain alone more than 150,000 men were sent between 196 and 169 (Ihm iii. 319); compare the reluctance of the people to declare war against Macedonia in 200 B.C., and also the case of Spurius Ligustinus in 171 (Livy, xlii. 34).

imported from beyond the sea, and with the foreign slave-labour purchased by the capital of wealthier men.¹ Farming became unprofitable, and the hard laborious life with its scanty returns was thrown into still darker relief when compared with the stirring life of the camps with its opportunities of booty, or with the cheap provisions, frequent largesses and gay spectacles to be had in the large towns. The small holders went off to follow the eagles or swell the proletariat of the cities, and their holdings were left to run waste or merged in the vineyards, oliveyards and above all in the great cattlefarms of the rich, and their own place was taken by slaves. The evil was worst in Etruria and in southern Italy; but everywhere it was serious enough to demand the earnest attention of Roman statesmen. Of its existence the government had received plenty of warning in the declining numbers of able-bodied males returned at the census,² in the increasing difficulties of recruiting for the legions,³ in servile outbreaks in Etruria and Apulia,⁴ and

554 94. between 200 and 160 a good deal was attempted by way of remedy. In addition to the foundation of twenty colonies,⁵ there were frequent allotments of land to veteran soldiers, especially in Apulia and Samnium.⁶

574. 180, 40,000 Ligurians were removed from their homes and settled on vacant lands once the property of a Samnite tribe,⁷ and in 160 the Pomptine marshes were drained for the purpose of cultivation.⁸ But these efforts were only partially successful. The colonies planted in Cisalpine Gaul and in Picenum flourished, but of the others the majority slowly dwindled away, and two required re-colonizing only eight years after their foundation.⁹ The veterans who received land were unfitted to make good farmers; and large numbers, on the first opportunity, gladly returned as volunteers to a soldier's life. Moreover, after 160 even these efforts ceased, and with the single exception of the colony of Auximum in Picenum (157) nothing was done to check the spread of the evil, until in 133

594 Tiberius Gracchus, on his election to the tribunate, set his hand to the work.

The remedy proposed by Gracchus¹⁰ amounted in effect to the resumption by the state of as much of the "common land" as was not held in occupation by authorized persons and conformably to the provisions of the Licinian law,¹¹ and the distribution in allotments of the land thus rescued for the community from the monopoly of a few. It was a scheme which could quote in its favour ancient precedent as well as urgent necessity. Of the causes which led to its ultimate failure something will be said later on; for the present we must turn to the constitutional conflict which it provoked. The senate from the first identified itself with the interests of the wealthy occupiers, and Tiberius found himself forced into a struggle with that body, which had been no part of his original plan. He fell back on the legislative sovereignty of the assembly; he resuscitated the half-forgotten powers of interference vested in the tribunate in order to paralyse the action of the senatorial magistrates, and finally lost his life in an attempt to make good one of the weak points in the tribune's position by securing his own re-election for a second year. But the conflict did not end with his death. It was

renewed on a wider scale, and with a more deliberate aim by his brother Gaius, who on his election to the tribunate (123) at once came forward as the avowed enemy of the senate.¹² The latter suddenly found its control of the administration threatened at a variety of points. On the invitation of the popular tribune the assembly proceeded to restrict the senate's freedom of action in assigning the provinces.¹³ It regulated the taxation of the province of Asia¹⁴ and altered the conditions of military service.¹⁵ In home affairs it inflicted two serious blows on the senate's authority by declaring the summary punishment of Roman citizens by the consuls on the strength of a *senatus consultum* to be a violation of the law of appeal,¹⁶ and by taking out of the senate's hands the control of the newly established court for the trial of cases of magisterial misgovernment in the provinces.¹⁷ Tiberius had committed the mistake of relying too exclusively on the support of one section only of the community; his brother endeavoured to enlist on the popular side every available ally. The Latins and Italians had opposed an agrarian scheme which took from them land which they had come to regard as rightfully theirs, and gave them no share in the benefit of the allotments.¹⁸ Gaius not only removed this latter grievance,¹⁹ but ardently supported and himself brought forward the first proposals made in Rome for their enfranchisement.²⁰ The indifference of the city populace, to whom the prospect of small holdings in a remote district of Italy was not a tempting one, was overcome by the establishment of regular monthly doles of corn at a low price.²¹ Finally, the men of business—the publicans, merchants and money-lenders—were conciliated by the privilege granted to them of collecting the tithes of the new province of Asia, and placed in direct rivalry with the senate by the substitution of men of their own class as judges in the "questio de repetundis," in place of senators.²² The organizer of this concerted attack upon the position of the senate fell, like his brother, in a riot.

The agrarian reforms of the two Gracchi had little permanent effect.²³ Even in the lifetime of Gaius the clause in his brother's law rendering the new holdings inalienable was repealed, and the process of absorption recommenced. In 118 a stop was put to further allotment of occupied lands, and finally, in 111, the whole position of the agrarian question was altered by a law which converted all land still held in occupation into private land.²⁴ The old controversy as to the proper use of the lands of the community was closed by this act of alienation. The controversy in future turns, not on the right of the poor

Failure of the attempt at agrarian reform. 636, 642.

¹⁰ On the legislation of C. Gracchus, see Warde Fowler in *Eng. Hist. Review* (1905), pp. 200 seq.; 417 seq.
¹¹ *Lex Sempronia de provinciis consularibus*; Cic. *Pro domo*, 9, 24; *De Prov. Cons.* 2, 3; Sallust, *Jug.* 27.
¹² *Lex de provincia Asia*; Cic. *Verr.* 3, 6, 12; Fronto, *Ad Ver.* ii. 125.

¹³ Plut. *C.G.* 5; Diod. xxxiv. 25.
¹⁴ Plut. *C.G.* 4; Cic. *Pro domo*, 31, 82; *Pro Rab. Perd.* 4, 12.
¹⁵ *Quaestio de repetundis*, est. 149 B.C. See Plut. *C.G.* 5; Livy, *Epit.* lx.; *Cat. Ann.* xii. 60; *App. B.C.* i. 22. For the *lex Acilia*, see *C.I.L.* i. 189; Wordsworth, *Fragm.* 424; Bruns, *Fontes juris Romani*, ed. 6, pp. 56 seq.
¹⁶ They had succeeded in 129 in suspending the operations of the agrarian commission. *App. B.C.* i. 18; Livy, *Epit.* lix.; Cic. *De Rep.* iii. 29, 41.
¹⁷ Lange, *R.A.* iii. 32; *Lex Agr.* line 21.
¹⁸ *The rogatio Fulvia*, 125 B.C.; Val. Max. ix. 5, 1; *App. B.C.* i. 21.
¹⁹ Plut. *C.G.* 5; App. i. 21; Livy, *Epit.* lx.; Festus, 290.
²⁰ Hence Gaius ranked as the founder of the equestrian order. Plin. *N.H.* xxxiii. 34, "judicium appellatione separare eum ordinem . . . instituitur Gracchi"; Varro ap. Non. 454, "bicipitem civitatem fecit".

¹ Mommsen, *Hist. of Rome*, iii. 75 seq. Inne, *Hist. of Rome*, iv. 364, argues that Mommsen has exaggerated the depressing effects of foreign competition; cf. Salvioli, *Le Capitalisme dans le monde antique*, chaps. v.-vii.

² Beloch, *Ital. Bund.* 80 seq.
³ Livy xliii. 14; *Epit.* xviii., lv. During the period the minimum qualification for service in the legion was reduced from 11,000 to 4000 asses.

⁴ Livy xxxii. 26, xxxiii. 36, xxxix. 29, 41.
⁵ Sixteen Roman and four Latin colonies. See Marquardt, *Staatsverh.* i. 6. ⁶ *E.g.* Livy xxxi. 4, 49, xxxii. 1.
⁷ Livy xl. 38. ⁸ Livy, *Epit.* xvi.
⁹ Sipontum and Buxentum in 186; Livy xxxix. 23.
¹⁰ Plut. *T. G.* 9-14; Appian, *B.C.* i. 9-13; Livy, *Epit.* lviii. Compare also Mommsen, *Hist. of Rome*, iii. 320 seq.; Lange, *Röm. Alterth.* iii. 8 seq.; Nitzsch, *Gracchen*, 294; Greenidge, *Hist. of Rome*, i. (1904), pp. 110 seq.

²¹ See App. i. 27. *The lex agraria*, still extant in a fragmentary condition in the museum at Naples, is that of 111. See Mommsen, *C.I.L.* i. 200; Wordsworth, 441 seq.; Bruns, *Fontes juris Rom.* ed. 6, pp. 74 seq., and cf. the article AGRARIAN LAWS.

¹¹ For the details, see the article AGRARIAN LAWS.

citizens to the state lands, but on the expediency of purchasing other lands for distribution at the cost of the treasury.¹

But, though the agrarian reform failed, the political conflict it had provoked continued, and the lines on which it was waged were in the main those laid down by Gaius Gracchus. The sovereignty of the assembly continued to be the watchword of the popular party, and a free use of the tribunician powers of interference and of legislation remained the most effective means of accomplishing their aims.

Ten years after the death of Gaius the *populares* once more summoned up courage to challenge the supremacy of the senate; but it was on a question of foreign administration that the conflict was renewed. The course of affairs in the client state of Numidia since Micipsa's death in 118 had been such as to discredit a stronger government than that of the senate.² In defiance of Roman authority, and relying on the influence of his own well-spent gold, Jugurtha had murdered both his legitimate rivals, Hiempsal and Adherbal, and made himself master of Numidia. The declaration of war wrung from the senate (112) by popular indignation had been followed by the corruption of a consul³ (111) and the crushing defeat of the proconsul Albinus.⁴ On the news of this crowning disgrace the storm burst, and on the proposal of the tribunes a commission of inquiry was appointed into the conduct of the war.⁵ But the popular leaders did not stop here. Q. Caecilius

Metellus, who as consul (109) had succeeded to the command in Numidia, was an able soldier but a rigid aristocrat; and they now resolved to improve their success by entrusting the command instead to a genuine son of the people. Their choice fell on Gaius Marius (see MARIUS), an experienced officer and administrator, but a man of humble birth, wholly illiterate, and one who, though no politician, was by temperament and training a hater of the polished and effeminate nobles who filled the senate.⁶ He was triumphantly elected, and, in spite of a decree of the senate continuing Metellus as proconsul, he was entrusted by a vote of the assembly with the charge of the war against Jugurtha (*q.v.*).⁷

Jugurtha was vanquished; and Marius, who had been a second time elected consul in his absence, arrived at Rome in January 104, bringing the captive prince with him in chains.⁸ But further triumphs awaited the popular hero. The Cimbri and Teutones were at the gates of Italy; they had four times defeated the senatorial generals, and Marius was called upon to save Rome from a second invasion of the barbarians.⁹ After two years of suspense the victory at Aquae Sextiae (102), followed by that on the Raudine plain (101), put an end to the danger by the annihilation of the invading hordes; and Marius, now consul for the fifth time, returned to Rome in triumph. There the popular party welcomed him as a leader with all the prestige of a successful general. Once more, however, they were destined to a brief success followed by disastrous defeat. Marius became for the sixth time consul;¹⁰ of the two popular leaders Gaius became praetor and Saturninus tribune. But Marius and his allies were not statesmen of the stamp of the Gracchi; and the laws proposed by Saturninus had evidently no serious aim in view other than that of harassing the senate. His corn law merely reduced the price fixed in 123 for the monthly dole of corn, and the main point of his agrarian law lay in the clause appended to it requiring all senators to swear to observe its pro-

visions.¹¹ The laws were carried, but the triumph of the popular leaders was short-lived. Their recklessness and violence had alienated all classes in Rome; and their period of office was drawing to a close. At the elections fresh rioting took place, and Marius as consul was called upon by the senate to protect the state against his own partisans. Saturninus and Glauca surrendered, but while the senate was discussing their fate they were surrounded and murdered by their opponents.

The popular party had been worsted once more in their struggle with the senate, but none the less their alliance with Marius, and the position in which their votes placed him, marked an epoch in the history of the revolution. The transference of the political leadership to a consul who was nothing if not a soldier was at once a confession of the insufficiency of the purely civil authority of the tribunate and a dangerous encouragement of military interference in political controversies. The consequences were already foreshadowed by the special provisions made by Saturninus for Marius's veterans, and in the active part taken by them in the passing of his laws. Indirectly, too, Marius, though no politician, played an important part in this new departure. His military reforms¹² at once democratized the army and attached it more closely to its leader for the time being. He swept away the last traces of civil distinctions of rank or wealth within the legion, admitted to its ranks all classes, and substituted voluntary enlistment under a popular general for the old-fashioned compulsory levy. The efficiency of the legion was increased at the cost of a complete severance of the ties which bound it to the civil community and to the civil authorities.

The next important crisis was due partly to the rivalry which had been growing more bitter each year between the senate and the commercial class, and partly to the long-impending question of the enfranchisement of the Italian allies. The *publicani*, *negotiators* and others, who constituted what was now becoming known as the equestrian order (see *EQUITES*), had made unscrupulous use of their control of the courts and especially of the *questio de repetundis* against their natural rivals, the official class in the provinces. The threat of prosecution before a hostile jury was held over the head of every governor, legate and quaestor who ventured to interfere with their operations in the provinces. The average official preferred to connive at their exactions; the bolder ones paid with fines and even exile for their courage. In 92 the necessity for a reform was proved beyond a doubt by the scandalous condemnation of P. Rutilius Rufus,¹³ ostensibly on a charge of extortion, in reality as the reward of his efforts to check the extortions of the Roman equites in Asia. The difficulties of the Italian question were more serious. That the Italian allies were discontented was notorious. After nearly two centuries of close alliance, of common dangers and victories, they now eagerly coveted as a boon that complete amalgamation with Rome which they had at first resented as a dishonour. But, unfortunately, Rome had grown more exclusive in proportion as the value set upon Roman citizenship increased. During the last forty years feelings of hope and disappointment had rapidly succeeded each other; Marcus Fulvius Flaccus, Gaius Gracchus, Saturninus, had all held out promises of relief—and nothing had yet been done. On each occasion they had crowded to Rome, full of eager expectation, only to be harshly ejected from the city by the consul's orders.¹⁴ The justice of their claims could hardly be denied, the danger of continuing to ignore them was obvious—yet the difficulties in the way of granting them were formidable in the extreme, and from a higher than a merely selfish point of view there was much

to be done. The Italian allies were discontented was notorious. After nearly two centuries of close alliance, of common dangers and victories, they now eagerly coveted as a boon that complete amalgamation with Rome which they had at first resented as a dishonour. But, unfortunately, Rome had grown more exclusive in proportion as the value set upon Roman citizenship increased. During the last forty years feelings of hope and disappointment had rapidly succeeded each other; Marcus Fulvius Flaccus, Gaius Gracchus, Saturninus, had all held out promises of relief—and nothing had yet been done. On each occasion they had crowded to Rome, full of eager expectation, only to be harshly ejected from the city by the consul's orders.¹⁴ The justice of their claims could hardly be denied, the danger of continuing to ignore them was obvious—yet the difficulties in the way of granting them were formidable in the extreme, and from a higher than a merely selfish point of view there was much

to be done. The Italian allies were discontented was notorious. After nearly two centuries of close alliance, of common dangers and victories, they now eagerly coveted as a boon that complete amalgamation with Rome which they had at first resented as a dishonour. But, unfortunately, Rome had grown more exclusive in proportion as the value set upon Roman citizenship increased. During the last forty years feelings of hope and disappointment had rapidly succeeded each other; Marcus Fulvius Flaccus, Gaius Gracchus, Saturninus, had all held out promises of relief—and nothing had yet been done. On each occasion they had crowded to Rome, full of eager expectation, only to be harshly ejected from the city by the consul's orders.¹⁴ The justice of their claims could hardly be denied, the danger of continuing to ignore them was obvious—yet the difficulties in the way of granting them were formidable in the extreme, and from a higher than a merely selfish point of view there was much

to be done. The Italian allies were discontented was notorious. After nearly two centuries of close alliance, of common dangers and victories, they now eagerly coveted as a boon that complete amalgamation with Rome which they had at first resented as a dishonour. But, unfortunately, Rome had grown more exclusive in proportion as the value set upon Roman citizenship increased. During the last forty years feelings of hope and disappointment had rapidly succeeded each other; Marcus Fulvius Flaccus, Gaius Gracchus, Saturninus, had all held out promises of relief—and nothing had yet been done. On each occasion they had crowded to Rome, full of eager expectation, only to be harshly ejected from the city by the consul's orders.¹⁴ The justice of their claims could hardly be denied, the danger of continuing to ignore them was obvious—yet the difficulties in the way of granting them were formidable in the extreme, and from a higher than a merely selfish point of view there was much

to be done. The Italian allies were discontented was notorious. After nearly two centuries of close alliance, of common dangers and victories, they now eagerly coveted as a boon that complete amalgamation with Rome which they had at first resented as a dishonour. But, unfortunately, Rome had grown more exclusive in proportion as the value set upon Roman citizenship increased. During the last forty years feelings of hope and disappointment had rapidly succeeded each other; Marcus Fulvius Flaccus, Gaius Gracchus, Saturninus, had all held out promises of relief—and nothing had yet been done. On each occasion they had crowded to Rome, full of eager expectation, only to be harshly ejected from the city by the consul's orders.¹⁴ The justice of their claims could hardly be denied, the danger of continuing to ignore them was obvious—yet the difficulties in the way of granting them were formidable in the extreme, and from a higher than a merely selfish point of view there was much

¹ *Cic. Agr.* ii. 25, 65. ² *Sallust, Jug.* 5 seq.; *Livy, Epit.* lxii., lxiv. ³ L. Calpurnius Bestia, tribune 121; *Sall.* *Jug.* 28.

⁴ *Ibid.* 38, 39. ⁵ *Ibid.* 40. ⁶ *Ibid.* 40.

⁷ *Sallust, Jug.* 63; *Plut. Marius*, 2, 3. For the question as to the position of his parents, see *Madvig, Verf.* i. 170; *Diod.* xxxiv. 38.

⁸ *Sallust, Jug.* 73.

⁹ *Ibid.* 114. For the chronology of the Jugurthine war, see *Mommsen, Hist. of Rome*, iii. 398; *Pelham, Journ. of Phil.* vii. 91; *Meinel, Zur Chronologie des jugurthinschen Kriegs* (1883).

¹⁰ *Livy, Epit.* lxvii.; *Plut. Mar.* 12; *Mommsen, Hist. of Rome*, iii. 414 seq.

¹¹ *Livy, Epit.* lxix.; *Appian, B.C.* i. 28 seq.

¹² *Livy, Epit.* lxix.; *Appian, B.C.* i. 28 seq.

Military reforms of Marius.

Discontent of the Italian allies.

Military reforms of Marius.

Discontent of the Italian allies.

Military reforms of Marius.

Discontent of the Italian allies.

to be said against the revolution involved in so sudden and enormous an enlargement of the citizen body.

Marcus Livius Drusus (*q.v.*), who as tribune gallantly took up the task of reform, is claimed by Cicero¹ as a member of that party of the centre to which he belonged himself. Noble, wealthy and popular, he seems to have hoped to be able by the weight of his position and character to rescue the burning questions of the day from the grasp of extreme partisans and to settle them peacefully and equitably. But he, like Cicero after him, had to find to his cost that there was no room in the fierce strife of Roman politics for moderate counsels. His proposal to reform the law courts excited the equestrian order and their friends in the senate to fury. The agrarian and corn laws which he coupled with it² alienated many more in the senate, and roused the old anti-popular party feeling; finally, his known negotiations with the Italians were eagerly misrepresented to the jealous and excited people as evidence of complicity with a widespread conspiracy against Rome. His laws were carried, but the senate pronounced them null and void.³ Drusus was denounced in the senate house as a traitor, and on his way home was struck down by the hand of an unknown assassin. His assassination was the signal for an outbreak which had been secretly prepared for some time before.

Throughout the highlands of central and southern Italy the flower of the Italian peoples rose as one man.⁴ Etruria and Umbria held aloof; the isolated Latin colonies stood firm; but the Sabellian clans, north and south, the Latinized Marsi and Pacligni, as well as the Oscan-speaking Samnites and Lucanians, rushed to arms. No time was lost in proclaiming their plans for the future. A new Italian state was to be formed. The Paclignian town of Corfinium was selected as its capital and rechristened with the proud name of Italica. All Italians were to be citizens of this new metropolis, and here were to be the place of assembly and the senate house. A senate of 500 members and a magistracy resembling that of Rome completed a constitution which adhered closely to the very political traditions which its authors had most reason to abjure.

Now, as always in the face of serious danger, the action of Rome was prompt and resolute. Both consuls took the field;⁵ with each were five legates, among them the veteran Marius and his destined rival L. Cornelius Sulla, and even freedmen were pressed into service with the legions. But the first year's campaign opened disastrously. In central Italy the northern Sabellians, and in the south the Samnites, defeated the forces opposed to them. And though before the end of the year Marius and Sulla in the north, and the consul Caesar himself in Campania, succeeded in inflicting severe blows on the enemy, and on the Marsi especially, it is not surprising that, with an empty treasury, with the insurgents' strength still unbroken, and with rumours of disaffection in the loyal districts, opinion in Rome should have turned in the direction of the more liberal policy which had been so often scornfully rejected and in favour of some compromise which should check the spread of the revolt, and possibly sow discord among their enemies. Towards the close of the year 90 the consul L. Julius Caesar (killed by Fimbria in 87) carried the *lex Julia*,⁶ by which the Roman franchise was offered to all communities which had not as yet revolted; early in the next year (89) the Julian law was supplemented by the *lex Plautia Papiria*, introduced by two of the tribunes, M. Plautius Silvanus and C. Papirius Carbo Arvina, which

664.

Lex Julia
and *lex*
Plautia
Papiria.

665.

¹ Cic. *De orat.* i. 7, 24 f., and *De orbo*, 19, 50; Appian, *B.C.* i. 35; Diod. Sic. xxxvii. 10; Ihne, bk. vii. cap. xiii.

² For the provisions of the *leges Livianae*, see App. *B.C.* i. 35; Livy, *Epit.* lxxi. They included, according to Pliny, *N.H.* xxxiii. 3, a proposal for the debasement of the coinage.

³ Cic. *Pro Druso*, 16, 41.

⁴ For the Social War, see, besides Mommsen, Ihne and Lange, Kiene, *Der römische Bundesgenossenkrieg* (Leipzig, 1845).

⁵ App. *B.C.* i. 39-49; Livy, *Epit.* lxxii-lxxvi.

⁶ For the *lex Julia*, see Cicero, *Pro Balbo*, 8, 21; Gell. iv. 4; App. *B.C.* i. 49. For the *lex Plautia Papiria*, see Cic. *Pro Archia*, 4, 7, and Schol. Bob. p. 353.

enacted that any citizen of an allied community then domiciled in Italy might obtain the franchise by giving in his name to a praetor in Rome within sixty days. A third law (*lex Calpurnia*), apparently passed at the same time, empowered Roman magistrates in the field to bestow the franchise there and then upon all who were willing to receive it. This sudden opening of the closed gates of Roman citizenship was completely successful, and its effects were at once visible in the diminished vigour of the insurgents. By the end of 89 the Samnites and Lucanians were left alone in their obstinate hostility to Rome, and neither, thanks to Sulla's brilliant campaign in Samnium, had for the moment any strength left for active aggression.

The termination of the Social War brought with it no peace in Rome. The old quarrels were renewed with increased bitterness, and the newly enfranchised Italians themselves complained as bitterly of the restriction⁷ which robbed them of their due share of political influence by allowing them to vote only in a specified number of tribes. The senate itself was distracted by violent personal rivalries—and all these feuds, animosities and grievances were aggravated by the widespread economic distress and ruin which affected all classes.⁸ Lastly, war with Mithradates VI. had been declared; it was notorious that the privilege of commanding the force to be sent against him would be keenly contested, and that the contest would lie between the veteran Marius and L. Cornelius Sulla.⁹

It was in an atmosphere thus charged with the elements of disturbance that P. Sulpicius Rufus as tribune¹⁰ brought forward his laws. He proposed—(1) that the command of the Mithradatic war should be given to Marius, (2) that the new citizens should be distributed through all the tribes, (3) that the freedmen should no longer be confined to the four city tribes, (4) that any senator owing more than 2000 denarii should lose his seat, (5) that those exiled on suspicion of complicity with the Italian revolt should be recalled. These proposals inevitably provoked a storm, and both sides were ominously ready for violent measures. The consuls, in order to prevent legislation, proclaimed a public holiday. Sulpicius replied by arming his followers and driving the consuls from the forum. The proclamation was withdrawn and the laws carried, but Sulpicius's triumph was short-lived. From Nola in Campania, where lay the legions commanded by him in the Social War, Sulla advanced on Rome, and for the first time a Roman consul entered the city at the head of the legions of the Republic. Resistance was hopeless. Marius and Sulpicius fled,¹¹ and Sulla, summoning the assembly of the centuries, proposed the measures he considered necessary for the public security, the most important being a provision that the sanction of the senate should be necessary before any proposal was introduced to the assembly.¹² Then, after waiting in Rome long enough to hold the consular elections, he left for Asia early in 87.

Sulla had conquered, but his victory cost the Republic dear. He had first taught political partisans to look for final success, not to a majority of votes in the forum or campus, but to the swords of the soldiery. The lesson was well learnt. Shortly after his departure L. Cornelius Cinna, Cinna as consul revived the proposals of Sulpicius,¹³ his colleague, Gnaeus Octavius, at the head of an armed force fell upon the new citizens who had collected in crowds to vote,

⁷ Vell. ii. 20; App. *B.C.* i. 49, 53. It is impossible to reconcile in detail the statements of these authors.

⁸ App. *B.C.* i. 54, and *Mithr.* 22; Oros. v. 18; Livy, *Epit.* lxxvi.

⁹ It had been already declared a consular province for 87, and early in 88 seems to have been assigned to Sulla by decree of the senate.

¹⁰ See SULPICIVS RUFUS, P.

¹¹ Marius finally escaped to Africa (see MARIUS); Sulpicius was taken and killed; App. i. 60.

¹² App. *B.C.* i. 59, *ἄρσιν ἐπι ἀπορούλωντος ἐν τῷ δήμῳ ἐσφίρεσθαι*. For the other laws mentioned by Appian, see Mommsen, *Hist. of Rome*, iii. 541 f.

¹³ Livy, *Epit.* lxxix.; Vell. ii. 20.

P. Sulpicius
Rufus,
88-666.

667.

Marius
and
Cinna.

and the forum was heaped high with the bodies of the slain.¹ Cinna fled, but fled, like Sulla, to the legions. When the senate declared him deposed from his consulship, he replied by invoking the aid of the soldiers in Campania in behalf of the violated rights of the people and the injured dignity of the consulship, and, like Sulla, found them ready to follow where he led. The neighbouring Italian communities, who had lost many citizens in the recent massacre, sent their new champion men and money;² while from Africa, whither he had escaped after Sulla's entry into Rome, came Marius with 1000 Numidian horsemen. The senate had prepared for a desperate defence, but fortune was adverse, and after a brief resistance they gave way. Cinna was acknowledged as consul, the sentence of outlawry passed on Marius was revoked and Cinna and Marius entered Rome with their troops. Marius's thirst for revenge was gratified by a frightful massacre, and he lived long enough to be nominated consul for the seventh time. But he held his consulship only a few weeks. Early in 86 he died, and

668.

669, 670.

for the next three years Cinna ruled Rome. Constitutional government was virtually suspended. For 85 and 84 Cinna nominated himself and a trusted colleague as consuls.³ The state was, as Cicero⁴ says, without lawful authority.⁵ One important matter was carried through—the registration in all the tribes of the newly enfranchised Italians,⁶ but beyond this little was done. The attention of Cinna and his friends was in truth engrossed by the ever-present dread of Sulla's return from Asia. The consul of 86, L. Valerius Flaccus (who had been consul with Marius in 100 B.C.), sent out to supersede him, was murdered by his own soldiers at Nicomedia.⁷

In 85 Sulla, though disowned by his government, concluded a peace with Mithradates.⁸ In 84, after settling affairs in Asia and crushing Flaccus's successor, C. Flavius Fimbria, he crossed into Greece, and in the spring of 83 landed at Brundisium with 40,000 soldiers and a large following of *émigré* nobles. Cinna was dead,⁹ murdered like Flaccus by his mutinous soldiers; his most trusted colleague, Cn. Papirius Carbo, was commanding as proconsul in Cisalpine Gaul; and the resistance offered to Sulla's advance was slight. At Capua, Sulla routed the forces of one consul, Gaius Norbanus; at Teanum the troops of the other went over in a body to the side of the outlawed proconsul. After a winter spent in Campania he pressed forward to Rome, defeated the younger Marius (consul, 82) near Praeneste, and entered the city without further opposition. In north Italy the success of his lieutenants, Q. Caecilius Metellus Pius (son of Metellus Numidicus), P. Pompeius and Marcus Crassus, had been fully as decisive. Cisalpine Gaul, Umbria and Etruria had all been won for Sulla, and the two principal leaders on the other side, Carbo and Norbanus, had each fled, one to Rhodes, the other to Africa. Only one foe remained to be conquered. The Samnites and Lucanians whom Cinna had conciliated, and who saw in Sulla their bitterest foe, were for the last time in arms, and had already joined forces with the remains of the Marian army close to Rome. The decisive battle was fought under the walls of the city, and ended in the complete defeat of the Marians and Italians (battle of the Colline Gate).¹⁰

For a period of nearly ten years Rome and Italy had been distracted by civil war. Sulla was now called upon to heal

the divisions which rent the state asunder, to set in working again the machinery of civil government and above all so to modify it as to meet the altered conditions, and to fortify it against the dangers which visibly threatened it in the future. The real charge against Sulla¹¹ is not that he failed to accomplish all this, for to do so was beyond the powers even of a man so able, resolute and self-confident as Sulla, armed though he was with absolute authority and backed by overwhelming military strength and the prestige of unbroken success. He stands convicted rather of deliberately aggravating some and culpably ignoring others of the evils he should have tried to cure, and of contenting himself with a party triumph when he should have aimed at the regeneration and confirmation of the whole state. His victory was instantly followed, not by any measures of conciliation, but by a series of massacres, proscriptions and confiscations, of which almost the least serious consequence was the immediate loss of life which they entailed.¹² From this time forward the fear of proscription and confiscation recurred as a possible consequence of every political crisis, and it was with difficulty that Caesar himself dissipated the belief that his victory would be followed by a Sullan reign of terror. The legacy of hatred and discontent which Sulla left behind him was a constant source of disquiet and danger. In the children of the proscribed, whom he excluded from holding office, and the dispossessed owners of the confiscated lands, every agitator found ready and willing allies.¹³ The moneyed men of the equestrian order were more than ever hostile to the senatorial government, which they now identified with the man who cherished towards them a peculiar hatred,¹⁴ and whose creatures had hunted them down like dogs. The attachment which the new Italian citizens might in time have learnt to feel for the old republican constitution was nipped in the bud by the massacres at Praeneste and Norba, by the harsh treatment of the ancient towns of Etruria, and by the ruthless desolation of Samnium and Lucania.¹⁵ Quite as fatal were the results to the economic prosperity of the peninsula. Sulla's confiscations, following on the civil and social wars, opened the doors wide for a long train of evils. The veterans whom he planted on the lands he had seized¹⁶ did nothing for agriculture, and swelled the growing numbers of the turbulent and discontented.¹⁷ The "Sullan men" became as great an object of fear and dislike as the "Sullan reign."¹⁸ The *latifundia* increased with startling rapidity—whole territories passing into the hands of greedy partisans.¹⁹ Wide tracts of land, confiscated but never allotted, ran to waste.²⁰ In all but a few districts of Italy the free population finally and completely disappeared from the open country; and life and property were rendered insecure by the brigandage which now developed unchecked, and in which the herdsmen slaves played a prominent part. The outbreaks of Spartacus in 73, and of Catiline ten years later, were significant commentaries on this part of Sulla's work.²¹ His constitutional legislation, while it included many useful administrative reforms, is marked by as violent a spirit of partisanship, and as apparently wilful a blindness to the future. The re-establishment on a legal basis of the ascendancy which custom had so long accorded to the

Sulla's
dictator-
ship,
81-673.

Effects
of the
Sullan
proscrip-
tions.

668.

669.

The return of Sulla, 83-81.

672.

681.

Constitutional legislation of Sulla.

¹ Cic. *Pro Sestio*, 36, 77; *Catil.* iii. 10, 24.
² Tibur and Praeneste especially.
³ The consuls of 86, 85, 84 were all nominated without election. Livy, *Epit.* lxxx. lxxxiii.; App. i. 75.
⁴ *Ibid.* 227.
⁵ The nobles had fled to Sulla in large numbers; Vell. ii. 23.
⁶ This work was accomplished apparently by the censors of 86; cf. Lange iii. 133; Mommsen, *Hist. of Rome*, iv. 70; Livy, *Epit.* lxxxiv.
⁷ Livy, *Epit.* lxxxii.; Appian, *Mithr.* 52; Plut. *Sulla*, 23.
⁸ Livy, *Epit.* lxxxiii.; Vell. ii. 23; Plut. *Sulla*, 24.
⁹ In 84; App. B.C. i. 78; Livy, *Epit.* lxxxiii.
¹⁰ Livy, *Epit.* lxxxviii., "cum Samnitibus ante portam Collinam delibavit"; Plut. *Sulla*, 29; and Crassus, 6. According to App. i. 93, and Livy, *loc. cit.*, 8000 captives were massacred. Florus, iii. 21, gives 4000. Praeneste surrendered, was razed to the ground, and its population put to the sword.
¹¹ Compare especially Mommsen's brilliant chapter, which is, however, too favourable (bk. iv. cap. x.), and also Lange (iii. 146 seq.). Further references will be found in the article SULLA (*q.v.*).
¹² App. i. 95 seq.; Dio Cassius, fr. 109; Plut. *Sulla*, 31. The number of the proscribed is given as 4700 (Val. Max.), including, according to Appian, 2600 members of the equestrian order.
¹³ E.g. Catiline, in 63. *Sall. Cat.* 21, 37. For the *liberi proscriptorum*, see Vell. ii. 28.
¹⁴ Cic. *Pro Cluent.* 55, 151.
¹⁵ Cic. *Phil.* v. 16, 43, "tot municipiorum maximae calamitates." Cic. *Pro Domo*, 30, 79; Cic. *Ad Att.* i. 19; Florus iii. 21; Strabo, 223, 254.
¹⁶ Livy, *Epit.* lxxxix.; App. B.C. i. 100; Cicero, *Catil.* ii. 79, 20. *Sall. Cat.* 28.
¹⁷ Cic. *Agr.* ii. 26, 69 seq.; 28, 78; iii. 2, 2. The territories of Praeneste and of the Hirpinii.
¹⁸ *Ibid.* iii. 4, 14.
¹⁹ See especially Cicero's oration *Pro Tullio*. For the *pastores* of Apulia, *Sall. Cat.* 28.

senate was his main object. With this purpose he had already, when consul in 88, made the *senatus auctoritas* legally necessary for proposals to the assembly. He now as dictator¹ followed this up by crippling the power of the magistracy, which had been the most effective weapon in the hands of the senate's opponents. The legislative freedom of the tribunes was already hampered by the necessity of obtaining the senate's sanction; in addition, Sulla restricted their wide powers of interference (*intercessio*) to their original purpose of protecting individual plebeians,² and discredited the office by prohibiting a tribune from holding any subsequent office in the state.³ The control of the courts (*quaestiones perpetuae*) was taken from the equestrian order and restored to the senate.⁴ To prevent the people from suddenly installing and keeping in high office a second Marius, he re-enacted the old law against re-election,⁵ and made legally binding the custom which required a man to mount up gradually to the consulship through the lower offices.⁶ His increase of the number of praetors from six to eight,⁷ and of quaestors to twenty,⁸ though required by administrative necessities, tended, by enlarging the numbers and further dividing the authority of the magistrates, to render them still more dependent upon the central direction of the senate. Lastly, he replaced the pontifical and augural colleges in the hands of the senatorial nobles, by enacting that vacancies in them should, as before the *lex Domitia* (104), be filled up by co-optation.⁹ It cannot be said that Sulla was successful in fortifying the republican system against the dangers which menaced it from without. He accepted as an accomplished fact the enfranchisement of the Italians,¹⁰ but he made no provision to guard against the consequent reduction of the *comitia* to an absurdity,¹¹ and with them of the civic government which rested upon them, or to organize an effective administrative system for the Italian communities.¹² Of all men, too, Sulla had the best reason to appreciate the dangers to be feared from the growing independence of governors and generals in the provinces, and from the transformation of the old civic militia into a group of professional armies, devoted

to Sulla's dictatorship as in itself a novelty, see App. i. 98; Plut. Sulla, 33; Cic. *Ad Alt.* 9, 15; Cic. *De Legg.* i. 15, 42.
² Cic. *De Legg.* iii. 9, 22; "injuriae faciendae potestatem ademit, auxilii ferendi reliquit." Cf. Cic. *Verr.* i. 60, 155; Livy, *Epit.* LXXIX.
³ Cic. *Pro Cornel.* fr. 78; Ascon. *In Corn.* pp. 59, 70; Appian i. 100.
⁴ Vell. ii. 32; Tac. *Ann.* xi. 22; Cic. *Verr.* Act. i. 13, 37.
⁵ App. *B.C.* i. 100; cf. Livy vii. 42 (342 B.C.), "ne quis eundem magistratum intra decem asperet."
⁶ The custom had gradually established itself. Cf. Livy xxxii. 7. The "certus ordo magistratum" legalized by Sulla was—quaestorship, praetorship, consulate; App. i. 100.
⁷ Pompon. *De orig. juris* (Dig. i. 2, 2, 32); Vell. ii. 89. Compare also Cicero, *In Pison.* 15, 35 with Cic. *Pro Milone*, 15, 39: The increase was connected with his extension of the system of *quaestiones perpetuae*, which threw more work on the praetors as the magistrates in charge of the courts.
⁸ Tac. *Ann.* xi. 22. The quaestorship henceforward carried with it the right to be called up to the senate. By increasing the number of quaestors, Sulla provided for the supply of ordinary vacancies in the senate and restricted the censors' freedom of choice in filling them up. Fragments of the *lex Cornelia de XX quaestoribus* survive. See C.I.L. i. 108; Bruns, *Fontes juris Romani* (ed. 6), p. 91.
⁹ Dio xxxvii. 37; Ps. Ascon. 102 (Orelli). He also increased their numbers; Livy, *Epit.* LXXIX.
¹⁰ He did propose to deprive several communities which had joined Cinna of the franchise, but the deprivation was not carried into effect; Cic. *Pro domo*, 30, 79.
¹¹ The inadequacy of the *comitia* as a representative body was increased by the unequal distribution of the new citizens amongst the thirty-five tribes, each of which formed a single voting unit. Some tribes represented only a thinly populated district in the Campagna with one or two outlying communities, others included large and populous territories. See Mommsen, *Staatsr.* iii. 187; *Hermes*, xxii. 101 sqq.
¹² Sulla does not appear to have passed any general municipal law; the necessary resettlement of the local constitutions after the Social War was seemingly carried out by commissioners. The fragment of a municipal charter found at Tarentum (*Ephem. epigr.* ix. 1, Dessau, *Inscr. Lat. sel.* 6086) is probably a specimen of such *leges datae*.

only to a successful leader, and with the weakest possible sense of allegiance to the state. He had himself, as proconsul of Asia, contemptuously and successfully defied the home government, and he, more than any other Roman general, had taught his soldiers to look only to their leader, and to think only of booty.¹³ Yet, beyond a few inadequate regulations, there is no evidence that Sulla dealt with these burning questions, the settlement of which was among the greatest of the achievements of Augustus.¹⁴ One administrative reform of real importance must, lastly, be set down to his credit. The judicial procedure first established in 149 for the trial of cases of magisterial extortion in the provinces, and applied between 149 and 81 to cases of treason and bribery, Sulla extended so as to bring under it the chief criminal offences, and thus laid the foundations of the Roman criminal law.¹⁵

The Sullan system stood for nine years, and was then overthrown—as it had been established—by a successful soldier. It was the fortune of Cn. Pompeius, a favourite officer of Sulla, first of all to violate in his own person the fundamental principles of the constitution re-established by his old chief, and then to overturn it. In Spain the Marian governor Q. Sertorius (see SERTORIUS) had defeated one after another of the proconsuls sent out by the senate, and was already in 77 master of all Hither Spain. To meet the crisis, Pompey, who was not yet thirty, and had never held even the quaestorship, was sent out to Spain with proconsular authority.¹⁶ Still Sertorius held out, until in 73 he was foully murdered by his own officers. The native tribes who had loyally stood by him submitted, and Pompey early in 71 returned with his troops to Italy, where, during his absence in Spain, an event had occurred which had shown Roman society with startling plainness how near it stood to revolution. In 73 Spartacus,¹⁷ a Thracian slave, escaped with seventy others from a gladiators' training school at Capua. In an incredibly short time he found himself at the head of 70,000 runaway slaves, outlaws, brigands and impoverished peasants, and for two years terrorized Italy, routed the legions sent against him, and even threatened Rome. He was at length defeated and slain by the praetor, M. Licinius Crassus, in Apulia. In Rome itself the various classes and parties hostile to the Sullan system had, ever since Sulla's death in 78, been incessantly agitating for the repeal of his most obnoxious laws, and needed only

¹³ Sall. *Cat.* 11. "L. Sulla exercitum, quo sibi fidem faceret, contra morem majorum luxuriose nimisque liberaliter habuerat."

¹⁴ There was a *lex Cornelia de provinciis ordinandis*, but only two of its provisions are known; (1) that a magistrate sent out with the *imperium* should retain it till he re-entered the city (Cic. *Ad Fam.* i. 9, 25), a provision which increased rather than diminished his freedom of action; (2) that an outgoing governor should leave his province within thirty days after his successor's arrival (Cic. *Ad Fam.* iii. 6, 3). A *lex Cornelia de majestate* contained, it is true, a definition of treason evidently framed in the light of recent experience. The magistrate was forbidden "exire de provincia, educere exercitum, bellum sua sponte gerere, in regnum injussu populi ac senatus accedere." Cic. *Pis.* 21, 50. Sulla also added one to the long list of laws dealing with extortion in the provinces. But the danger lay, not in the want of laws, but in the want of security for their observance by an absolutely autocratic proconsul. The present writer cannot agree with those who would include among Sulla's laws one retaining consuls and praetors in Rome for their year of office and then sending them out to a province. This was becoming the common practice before 81. After 81 it is invariably for praetors, as needed for the judicial work, and invariable but for two exceptions in the case of consuls; but nowhere is there a hint that there had been any legislation on the subject, and there are indications that it was convenience and not law which maintained the arrangement. Mommsen, *Hist. of Rome*, iv. 118 sqq.; Marquardt, *Staatsverw.* i. 518; cf. also Cic. *Att.* 8, 15; "consules, quibus more majorum concessum est vel omnes adire provincias."

¹⁵ For this, the most lasting of Sulla's reforms, see Mommsen, *Hist. of Rome*, iv. 127 sqq.; Rein, *Criminal-Recht*; Zumpt, *Criminal-Process d. Römer*; Greenwood, *Legal Procedure of Cicero's Time*, p. 418 sqq.

¹⁶ Plut. *Pomp.* 17; Livy, *Epit.* xci. For Pompey's earlier life, see POMPEY.

¹⁷ For the Slave War, see SPARTACUS.

a leader in order successfully to attack a government discredited by failure at home and abroad. With the return of Pompey from Spain their opportunity came. Pompey, who understood politics as little as Marius, was anxious to obtain a triumph, the consulship for the next year (70), and as the natural consequence of this an important command in the East. The opposition wanted his name and support, and a bargain was soon struck. Pompey and with him Marcus Licinius Crassus, the real conqueror of Spartacus, were elected consuls, almost in the presence of their troops, which lay encamped outside the gates in readiness to assist at the triumph and ovation granted to their respective leaders. Pompey lost no time in performing his part of the agreement. The tribunes regained their prerogatives.¹ The "perpetual courts" (*questiones perpetuae*) were taken out of the hands of the senatorial justices, who had outdone the equestrian order in scandalous corruption,² and finally the censors, the first since 86 B.C., purged the senate of the more worthless and disreputable of Sulla's partisans.³ The victory was complete; but for the future its chief significance lay in the clearness with which it showed that the final decision in matters political lay with neither of the two great parties in Rome, but with the holder of the military authority. The tribunes ceased to be political leaders and became lieutenants of the military commanders, and the change was fatal to the dignity of politics in the city. Men became conscious of the unreality of the old constitutional controversies, indifferent to the questions which agitated the forum and the curia, and contemptuously ready to alter or disregard the constitution itself when it stood in the way of interests nearer to their hearts.

When his consulship ended, Pompey impatiently awaited at the hands of the politicians he had befriended the further gift of a foreign command. He declined an ordinary province, and from the end of 70 to 67 he remained at Rome in a somewhat affectedly dignified seclusion.⁴

But in 67 and 66 the laws of Gabinus and Manilius gave him all and more than all that he expected (see POMPEY). By the former he obtained the sole command for three years against the Mediterranean pirates.⁵ He was to have supreme authority over all Roman magistrates in the provinces throughout the Mediterranean and over the coasts for 50 miles inland. Fifteen legati, all of praetorian rank, were assigned to him, with two hundred ships, and as many troops as he thought desirable. The Manilian law transferred from Lucullus and Gabrio to Pompey the conduct of the Mithradatic War in Asia, and with it the entire control of Roman policy and interests in the East.⁶ The unrepudiated character of the position thus granted to Pompey, and the dangers of the precedent established, were clearly enough pointed out by such moderate men as Q. Lutatius Catulus, the "father of the senate," and by the orator Hortensius—but in vain. Both laws were supported, not only by the tribunes and the populace, but by the whole influence of the *publicani* and *negotiatores*, whose interests in the East were at stake.

Pompey left Rome in 67. In a marvellously short space of time he freed the Mediterranean from the Cilician pirates and established Roman authority in Cilicia itself. He then crushed Mithradates, added Syria to the list of Roman provinces,

¹ The exact provisions of Pompey's law are nowhere given; Livy, *Epit.* xxviii, "tribunicianum potestatem restituerunt." Cf. Vell. ii. 30. A *lex Aurelia*, in 75, had already repealed the law disqualifying a tribune for further office; Cf. *Corn. fr.* 78.

² This was the work of L. Aurelius Cotta, praetor in this year. The justices were to be taken in equal proportions from senators, equites and *tribuni aequarii*. For the latter and for the law generally, see Lange, *R. Alt.* iii. 103; Greenidge, *Legal Procedure of Cicero's Time*, pp. 443 sqq.; and article AERARIUM. Compare also Cicero's language, *In Verres*, Act. i. 1. The prosecution of Verres shortly preceded the *lex Aurelia*.

³ Livy, *Epit.* xxviii. Sixty-four senators were expelled. Cf. Plut. *Pomp.* 22.

⁴ Vell. ii. 31; Plut. *Pomp.* 23.

⁵ Plut. *Pomp.* 25; Dio xxxvi. 6; Livy, *Epit.* c.

⁶ Cic. *Pro Lege Manilia*; Dio xxxvi. 25; Plut. *Pomp.* 30.

and led the Roman legions to the Euphrates and the Caspian, leaving no power capable of disputing with Rome the sovereignty of western Asia.⁷ He did not return to Italy till 68, 69, 67, 62, towards the end of 62. The interval was marked in Rome by the rise to political importance of Caesar and Cicero, and by Catiline's attempt at revolution. As the nephew of Marius and the son-in-law of Cinna, Caesar possessed a strong hereditary claim to the leadership of the popular and Marian party.⁸ He had already taken part in the agitation for the restoration of the tribunate; he had supported the Manilian law; and, when Pompey's withdrawal left the field clear for other competitors, he stepped at once into the front rank on the popular side.⁹ He took upon himself, as their nearest representative, the task of clearing the memory and avenging the wrongs of the great popular leaders, Marius, Cinna and Saturninus. He publicly reminded the people of Marius's services, and set up again upon the Capitol the trophies of the Cimbric War. He endeavoured to bring to justice, not only the ringleaders in Sulla's bloody work of proscription, but even the murderers of Saturninus, and vehemently pleaded the cause of the children of the proscribed. While thus carrying on in genuine Roman fashion the feud of his family, he attracted the sympathies of the Italians by his efforts to procure the Roman franchise for the Latin communities beyond the Po, and won the affections of the populace in Rome and its immediate neighbourhood by the splendour of the games which he gave as *curule aedile* (65), and by his lavish expenditure upon the improvement of the

Appian Way. But these measures were with him only means to the further end of creating for himself a position such as that which Pompey had already won; and this ulterior aim he pursued with an audacious indifference to constitutional forms and usages. His coalition with Crassus, soon after Pompey's departure, secured him an ally whose colossal wealth and wide financial connexions were of inestimable value, and whose vanity and inferiority of intellect rendered him a willing tool. The story of his attempted *coup d'état* in January 65 is probably false,¹⁰ but it is evident that by the beginning of 63 he was bent on reaping the reward of his exertions by obtaining from the people an extraordinary command abroad, which should secure his position before Pompey's return; and the agrarian law proposed early that year by the tribune P. Servilius Rullus had for its object the creation, in favour of Caesar and Crassus, of a commission with powers so wide as to place its members almost on a level with Pompey himself.¹¹ It was at this moment when all seemed going well, that Caesar's hopes were dashed to the ground by Catiline's desperate outbreak, which not only discredited every one connected with the popular party, but directed the suspicions of the well-to-do classes against Caesar himself, as a possible accomplice in Catiline's revolutionary schemes.¹²

The same wave of indignation and suspicion which for the moment checked Caesar's rise carried Marcus Tullius Cicero to the height of his fortunes. Cicero, as a politician, has been equally misjudged by friends and foes. That he was deficient in courage, that he was vain, and that he attempted the impossible, may be admitted at once. But he was neither a brilliant and unscrupulous adventurer nor an aimless trimmer, nor yet a devoted champion merely of senatorial

⁷ See POMPEY and MITHRADATES.

⁸ For his early life, see CAESAR.

⁹ Prof. Beesly has vainly endeavoured to show that Catiline and not Caesar was the popular leader from 67 to 63. That this is the inference intentionally conveyed by Sallust, in order to screen Caesar, is true, but the inference is a false one.

¹⁰ The story is so told by Suetonius, *Jul.* 8. In Sallust, *Cat.* 18, it appears as an intrigue originating with Catiline, and Caesar's name is omitted.

¹¹ Cic. *Agr.* ii. 6, 15, "nihil aliud actum nisi ut decem reges constituerentur."

¹² That Caesar and Crassus had supported Catiline for the consulship in 65 is certain, and they were suspected naturally enough of favouring his designs in 63, but their complicity is in the highest degree improbable.

Gabinian and Manilian laws.

684-87.
687, 688.

687, 692.

Caesar.
684.

689.

689.

691.

Cicero.

ascendancy.¹ He was a representative man, with a numerous following, and a policy which was naturally suggested to him by the circumstances of his birth, connexions and profession, and which, impracticable as it proved to be, was yet consistent, intelligent and high-minded. Born at Arpinum, he cherished like all Arpinates the memory of his great fellow-townsmen Marius, the friend of the Italians, the saviour of Italy and the irreconcilable foe of Sulla and the nobles. A "municipal" himself, his chosen friends and his warmest supporters were found among the well-to-do classes in the Italian towns.² Unpopular with the Roman aristocracy, who despised him as a *peregrinus*,³ and with the Roman populace, he was the trusted leader of the Italian middle class, "the true Roman people," as he proudly styles them. It was they who carried his election

691, 696. for the consulship⁴ (63), who in 58 insisted on his recall from exile,⁵ and it was his influence with them which made Caesar so anxious to win him over in 49. He represented their antipathy alike to socialistic schemes and to aristocratic exclusiveness, and their old-fashioned simplicity of life in contrast with the cosmopolitan luxury of the capital.⁶ By birth, too, he belonged to the equestrian order, the foremost representatives of which were indeed still the *publicani* and *negotiores*, but which since the enfranchisement of Italy included also the substantial burgesses of the Italian towns and the smaller "squires" of the country districts. With them, too, Cicero was at one in their dread of democratic excesses and their social and political jealousy of the *nobiles*.⁷ Lastly, as a lawyer and a scholar, he was passionately attached to the ancient constitution. His political ideal was the natural outcome of these circumstances. He advocated the maintenance of the old constitution, but not as it was understood by the extreme politicians of the right and left. The senate was to be the supreme directing council,⁸ but the senate of Cicero's dreams was not an oligarchic assemblage of nobles, but a body freely open to all citizens, and representing the worth of the community.⁹ The magistrates, while deferring to the senate's authority, were to be at once vigorous and public-spirited; and the assembly itself which elected the magistrates and passed the laws was to consist, not of the "mob of the forum," but of the true Roman people throughout Italy.¹⁰ For the realization of this ideal he looked, above all things, to the establishment of cordial relations between the senate and nobles in Rome and the great middle class of Italy represented by the equestrian order, between the capital and the country towns and districts. This was the *concordia ordinum*, the *consensus Italiae*, for which he laboured.¹¹

Cicero's election to the consulship for 63 over the heads of Caesar's nominees, Antonius and Catiline, was mainly the work of the Italian middle class, already rendered uneasy both by the rumours which were rife of revolutionary schemes and of Caesar's boundless ambition, and by the numerous disquieting signs of disturbance noticeable in Italy. The new consul vigorously set himself to discharge the trust placed in him. He defeated the insidious proposals of Rullus for Caesar's aggrandizement and assisted in quashing the prosecution of Gaius Rabirius (*q.v.*). But with the consular elections in the autumn of 63 a fresh danger arose from a different quarter. The "conspiracy of Catiline" (see CATILINE) was not the work of the popular

The conspiracy of Catiline, 63-691.

¹ Mommsen is throughout unfair to Cicero, as also are Drumann and Professor Beesly. The best estimates of Cicero's political position are those given by Mr Strachan-Davidson in his *Cicero* (1894), and by Professor Tyrrell in his *Introductions* to his edition of Cicero's *Letters*.

² *Cic. Ad Att. i. 19, 4*; "noster exercitus . . . locupletium."

³ *Cic. Pro Sulla, 7, 22*; *Sall. Cat. 31*; "iniquum urbis Romae."

⁴ See *De petitione consulatus*, *passim*.

⁵ *De Domo*, 28, 75; *Pro Plancio*, 41, 97.

⁶ *Cic. Pro Quinctio*, 8, 31; *Pro Cluentio*, 46, 153.

⁷ *Cic. In Ver. ii. 73*; *De Fel. Cons. i.* He shared with them their dislike of Sulla, as the foe of their order; *Pro Cluentio*, 55, 151.

⁸ *De Legg. iii. 12*. ⁹ *Pro Sestio*, 65, 136; *De Legg. iii. 4*.

¹⁰ *Pro Sestio*, 45. ¹¹ *Ad Att. i. 18*.

party, and still less was it an unselfish attempt at reform; Catiline himself was a patrician, who had held high office, and possessed considerable ability and courage; but he was bankrupt in character and in purse, and two successive defeats in the consular elections had rendered him desperate. To retrieve his broken fortunes by violence was a course which was only too readily suggested by the history of the last forty years, and materials for a conflagration abounded on all sides. The danger to be feared from his intrigues lay in the state of Italy, which made a revolt against society and the established government only too likely if once a leader presented himself, and it was such a revolt that Catiline endeavoured to organize. Bankrupt nobles like himself, Sullan veterans and the starving peasants whom they had dispossessed of their holdings, outlaws of every description, the slave population of Rome, and the wilder herdsmen-slaves of the Apulian pastures, were all enlisted under his banner, and attempts were even made to excite disaffection among the newly conquered people of southern Gaul and the warlike tribes who still cherished the memory of Sertorius in Spain. In Etruria, the seat and centre of agrarian distress and discontent, a rising actually took place headed by a Sullan centurion, but the spread of the revolt was checked by Cicero's vigorous measures. Catiline fled from Rome, and died fighting with desperate courage at the head of his motley force of old soldiers, peasants and slaves. His accomplices in Rome were arrested, and, after an unavailing protest from Caesar, the senate authorized the consuls summarily to put them to death.

The Catilinarian outbreak had been a blow to Caesar, whose schemes it interrupted, but to Cicero it brought not only popularity and honour, but, as he believed, the realization of his political ideal. But Pompey was now on his way home,¹² and again as in 70 the political future seemed to depend on the attitude which the successful general would assume; Pompey himself looked simply to the attainment by the help of one political party or another of his immediate aims, which at present were the ratification of his arrangements in Asia and a grant of land for his troops. It was the impracticable jealousy of his personal rivals in the senate, aided by the versatility of Caesar, who presented himself not as his rival but as his ally, which drove Pompey once more, in spite of Cicero's efforts, into the camp of what was still nominally the popular party. In 60,

Return of Pompey from Asia.

on Caesar's return from his proprietorship in Spain, the coalition was formed which is known by the somewhat misleading title of the First Triumvirate.¹³ Pompey was ostensibly the head of this new alliance, and in return for the satisfaction of his own demands he undertook to support Caesar's candidature for the consulship. The wealth and influence of Crassus were enlisted in the same cause, and the *publicani* were secured by a promise of release from their bargain for collecting the taxes of Asia. Cicero was under no illusions as to the significance of this coalition. It scattered to the winds his dreams of a stable and conservative republic. The year 59 saw the republic powerless in the hands of three citizens. Caesar as consul procured the ratification of Pompey's acts in Asia, granted to the *publicani* the relief refused by the senate, and carried an agrarian law of the new type, which provided for the purchase of lands for allotment at the cost of the treasury and for the assignment of the rich *ager Campanus*.¹⁴ But Caesar aimed at more than the carrying of laws in the teeth of the senate or any party victory in the forum. An important military command was essential to him. An obedient tribune, P. Vatinius, was found, and by the *lex Vatinia* he was given for five years the command of Cisalpine Gaul and Illyricum, to which

Coalition of Pompey, Caesar and Crassus, 60-694.

695.

Caesar's command in Gaul.

¹² For the history of the next eighteen years, the most important ancient authority is Cicero in his letters and speeches.

¹³ Misleading, because the coalition was unofficial. The "triumvirs" of 43 were actual magistrates, "Illviri reipublicae constituendae causa."

¹⁴ For the *lex Julia Agraria* and the *lex Campana*, see Dio Cass. xxxviii. 1; App. B.C. ii. 10; Suet. Jul. 20; Cic. Ad Att. ii. 16, 18.

was added by a decree of the senate Transalpine Gaul also.¹ This command not only opened to him a great military career, but enabled him, as the master of the valley of the Po, to keep an effective watch on the course of affairs in Italy.

Early the next year the attack upon himself which Cicero had foreseen was made. P. Clodius (*q. s.*) as tribune brought forward a law enacting that any one who had put a Roman citizen to death without trial by the people should be interdicted from fire and water. Cicero, finding himself deserted even by Pompey, left Rome in a panic, and by a second Clodian law he was declared to be outlawed.² With Caesar away in his province, and Cicero banished, Clodius was for the time master in Rome. But, absolute as he was in the streets, and recklessly as he parodied the policy of the Gracchi by violent attacks on the senate, his tribunate merely illustrated the anarchy which now inevitably followed the withdrawal of a strong controlling hand. A reaction speedily followed. Pompey, bewildered and alarmed by Clodius's violence, at last bestirred himself. Cicero's recall was decreed by the senate, and early in August 57 in the *comitia centuriata*, to which his Italian supporters flocked in crowds, a law was passed revoking the sentence of outlawry passed upon him.

Intoxicated by the acclamations which greeted him, and encouraged by Pompey's support, and by the salutary effects of Clodius's excesses, Cicero's hopes rose high.³ With indefatigable energy he strove to reconstruct a solid constitutional party, but only to fail once more. Pompey was irritated by the hostility of a powerful section in the senate, who thwarted his desires for a fresh command and even encouraged Clodius in insulting the conqueror of the East. Caesar became alarmed at the reports which reached him that the repeal of his agrarian law was threatened and that the feeling against the coalition was growing in strength; above all, he was anxious for a renewal of his five years' command. He acted at once, and in the celebrated conference at Luca (56) the alliance of the three self-constituted rulers of Rome was renewed. Cicero succumbed to the inevitable and withdrew in despair from public life.

Pompey and Crassus became consuls for 55. Caesar's command was renewed for another five years, and to each of his two allies important provinces were assigned for a similar period—Pompey receiving the two Spains and Africa, and Crassus Syria.⁴ The coalition now divided between them the control of the empire. For the future the question was, how long the coalition itself would last. Its duration proved to be short. In 53 Crassus was defeated and slain by the Parthians at Carrhae, and in Rome the course of events slowly forced Pompey into an attitude of hostility to Caesar. The year 54 brought with it a renewal of the riotous anarchy which had disgraced Rome in 58–57. Conscious of its own helplessness, the senate, with the eager assent of all respectable citizens, dissuaded Pompey from leaving Italy; and he accordingly left his provinces to be governed by his legates. But the anarchy and confusion only grew worse, and even strict constitutionalists like Cicero talked of the necessity of investing Pompey with some extraordinary powers for the preservation of order.⁵ At last

Death of Crassus, 53 = 701.

700. ¹ Suet. *Jul.* 22; Dio Cass. xxxviii. 8; App. *B. C.* ii. 13; Plut. *Caes.* 14. ² Both laws were carried in the *concilium plebis*. The first merely reaffirmed the right of appeal, as the law of Gaius Gracchus had done. The second declared Cicero to be already by his own act in leaving Rome "interdicted from fire and water"—a procedure for which precedents could be quoted. Clodius kept within the letter of the law. ³ Cicero's speech *Pro Sestio* gives expression to these feelings; it contains a passionate appeal to all good citizens to rally round the old constitution. The acquittal of Sestius confirmed his hopes. See *Ad Q. Fr.* ii. 4. ⁴ Livy, *Epit.* cv.; Dio Cass. xxxix. 33. For Cicero's views, see *Ep. ad Fam.* i. 9; *Ad Att.* iv. 5. ⁵ A dictatorship was talked of in Rome; Plut. *Pomp.* 54; Cic. *Ad Q. Fr.* iii. 8. Cicero himself anticipated Augustus in his picture of a *princeps civitatis* sketched in a lost book of the *De republica*,

in 52 he was elected sole consul, and not only so, but his provincial command was prolonged for five years more, and fresh troops were assigned him.⁶ The rôle of "saviour of society" thus thrust upon Pompey was one which flattered his vanity, but it entailed consequences which it is probable he did not foresee, for it brought him into close alliance with the senate, and in the senate there was a powerful party who were resolved to force him into heading the attack they could not successfully make without him upon Caesar. It was known that the latter, whose command expired in March 49, but who in the ordinary course of things would not have been replaced by his successor until January 48, was anxious to be allowed to stand for his second consulship in the autumn of 49 without coming in person to Rome.⁷ His opponents in the senate were equally bent on bringing his command to an end at the legal time, and so obliging him to disband his troops and stand for the consulship as a private person, or, if he kept his command, on preventing his standing for the consulship. Through 51 and 50 the discussions in the senate and the negotiations with Caesar continued, but with no result. On 1st January 49 Caesar made a last offer of compromise. The senate replied by requiring him on pain of outlawry to disband his legions. Two tribunes who supported him were ejected from the senate-house, and the magistrates with Pompey were authorized to take measures to protect the republic. Caesar hesitated no longer; he crossed the Rubicon and invaded Italy. The rapidity of his advance astounded and bewildered his foes. Pompey, followed by the consuls, by the majority of the senate and a long train of nobles, abandoned Italy as untenable, and crossed into Greece.⁸ At the end of March Caesar entered Rome as the master of Italy. Four years later, after the final victory of Munda (45), he became the undisputed master of the Roman world.⁹

The task which Caesar had to perform was no easy one. It came upon him suddenly; for there is no sufficient reason to believe that Caesar had long premeditated revolution, or that he had previously aspired to anything more than such a position as that which Pompey had already won, a position unrepugnant indeed, but accepted by republicans as inevitable.¹⁰ War was forced upon him as the alternative to political suicide, but success in war brought the responsibilities of nearly absolute power, and Caesar's genius must be held to have shown itself in the masterly fashion in which he grasped the situation, rather than in the supposed sagacity with which he is said to have foreseen and prepared for it. In so far as he failed, his failure was mainly due to the fact that his tenure of power was too short for the work which he was required to perform. From the very first moment when Pompey's ignominious retreat left him master of Italy, he made it clear that he was neither a second Sulla nor even the reckless anarchist which many believed him to be.¹¹ The Roman and Italian public were written about this time, which was based upon his hopes of what Pompey might prove to be; *Ad Att.* viii. 11; August. *De civ. Dei.* v. 13. ¹ Plut. *Pomp.* 54; App. *B. C.* ii. 24.

² For the rights of the question involved in the controversy between Caesar and the senate, see Mommsen, *Rechtsfrage zw. Caesar und d. Senat*; Guiraud, *Le Différend entre César et le Sénat* (Paris, 1878), and the article *CAESAR*.

³ Cicero severely censures Pompey for abandoning Italy, but strategically the move was justified by the fact that Pompey's strength lay in the East, where his name was a power, and in his control of the sea. Politically, however, it was a blunder, as it enabled Caesar to pose as the defender of Italy.

⁴ For the Civil Wars, see *CAESAR*; *CICERO*; and *POMPEY*. ⁵ On this, as on many other points connected with Caesar, divergence has here been ventured on from the views expressed by Mommsen in his brilliant chapter on Caesar (*Hist. of Rome*, bk. v, cap. xi.). Too much stress must not be laid on the gossip related by Suetonius as to Caesar's early intentions.

⁶ Cicero vividly expresses the revulsion of feeling produced by Caesar's energy, humanity and moderation on his first appearance in Italy. Compare *Ad Att.* vii. 11, with *Ad Att.* viii. 13.

so, but Pompey sole consul, 52 = 702.

705. 706.

Proposed recall of Caesar.

703-4. 705.

Caesar crosses the Rubicon, 49 = 705.

709.

Dictatorship of Caesar, 48-44 = 706-10.

first startled by the masterly rapidity and energy of his movements, and then agreeably surprised by his lenity and moderation. No proscriptions or confiscations followed his victories, and all his acts evinced an unmistakable desire to effect a sober and reasonable settlement of the pressing questions of the hour; of this, and of his almost superhuman energy, the long list of measures he carried out or planned is sufficient proof. The "children of the proscribed" were at length restored to their rights,¹ and with them many of the refugees² who had found shelter in Caesar's camp during the two or three years immediately preceding the war; but the extreme men among his supporters soon realized that their hopes of *novae tabulae* and grants of land were illusory. In allotting lands to his veterans, Caesar carefully avoided any disturbance of existing owners and occupiers,³ and the mode in which he dealt with the economic crisis produced by the war seems to have satisfied all reasonable men.⁴ It had been a common charge against Caesar in former days that he paid excessive court to the populace of Rome, and now that he was master he still dazzled and delighted them by the splendour of the spectacles he provided, and by the liberality of his largesses. But he was no indiscriminate flatterer of the mob. The popular clubs and guilds which had helped to organize the anarchy of the last few years were dissolved.⁵ A strict inquiry was made into the distribution of the monthly doles of corn, and the number of recipients was reduced by one-half;⁶ finally, the position of the courts of justice was raised by the abolition of the popular element among the judges.⁷ Nor did Caesar shrink from the attempt, in which so many had failed before him, to mitigate the twin evils which were ruining the prosperity of Italy—the concentration of a pauper population in the towns, and the denudation and desolation of the country districts. His strong hand carried out the scheme so often proposed by the popular leaders since the days of Gaius Gracchus, the colonization of Carthage and Corinth. Allotments of land on a large scale were made in Italy; decaying towns were reinforced by fresh drafts of settlers; on the large estates and cattle farms the owners were required to find employment for a certain amount of free labour; and a slight and temporary stimulus was given to Italian industry by the reimposition of harbour dues upon foreign goods.⁸

The reform of the calendar, which is described elsewhere,⁹ completes a record of administrative reform which entitles Caesar to the praise of having governed well, whatever may be thought of the validity of his title to govern at all. But how did Caesar deal with what was after all the greatest problem which he was called upon to solve, the establishment of a satisfactory government for the Empire? One point indeed was already settled. Some centralization of the executive authority was indispensable, and this part of his work Caesar thoroughly performed. From the moment when he seized the moneys in the treasury on his first entry into Rome¹⁰ down to the day of his death, he recognized no other authority but his throughout the Empire. He alone directed the policy of Rome in foreign affairs; the legions were led, and the provinces governed, not by independent magistrates, but by his "legates";¹¹ and the title *Imperator* which he adopted was intended to express the absolute and unlimited nature of the *imperium* he claimed, as distinct from the limited spheres of authority possessed by republican magistrates.¹² In so centralizing the executive authority over the Empire at large, Caesar was but

developing the policy implied in the Gabinian and Manilian laws, and the precedent he established was closely followed by his successors. It was otherwise with the more difficult question of the form under which this new executive authority should be exercised and the relation it should hold to the republican constitution. We must be content to remain in ignorance of the precise shape which Caesar intended ultimately to give to the new system. The theory that he contemplated a revival of the old Roman kingship¹³ is supported by little more than the popular gossip of the day, and the form under which he actually wielded his authority can hardly have been regarded by so sagacious a statesman as more than a provisional arrangement. This form was that of the dictatorship; and in favour of the choice it might have been urged that the dictatorship was the office naturally marked out by republican tradition as the one best suited to carry the state safely through a serious crisis, that the powers it conveyed were wide, that it was as dictator that Sulla had reorganized the state, and that a dictatorship had been spoken of as the readiest means of legalizing Pompey's protectorate of the Republic in 53—
701.2
52. The choice nevertheless was a bad one. It was associated with those very Sullan traditions from which Caesar was most anxious to sever himself; it implied necessarily the suspension for the time of all constitutional government; and, lastly, the dictatorship as held by Caesar could not even plead that it conformed to the old rules and traditions of the office. The "perpetual dictatorship" granted him after his crowning victory at Munda (45) was a contradiction in terms
709.
and a repudiation of constitutional government
which excited the bitterest animosity.¹⁴

A second question, hardly less important, was that of the position to be assigned to the old constitution. So far as Caesar himself was concerned, the answer was for the time sufficiently clear. The old constitution was not formally abrogated. The senate met and deliberated; the assembly passed laws and elected magistrates; there were still consuls, praetors, aediles, quaestors and tribunes; and Caesar himself, like his successors, professed to hold his authority by the will of the people. But senate, assembly and magistrates were all alike subordinated to the paramount authority of the dictator; and this subordination was, in appearance at least, more direct and complete under the rule of Caesar than under that of Augustus. Caesar was by nature as impatient as Augustus was tolerant of established forms; and, dazzled by the splendour of his career of victory and by his ubiquitous energy and versatility, the Roman public, high and low, prostrated themselves before him and heaped honours upon him with a reckless profusion which made the existence of any authority by the side of his own an absurdity.¹⁵ Hence under Caesar the old constitution was repeatedly disregarded, or suspended in a way which contrasted unfavourably with the more respectful attitude assumed by Augustus. For months together Rome was left without any regular magistrates, and was governed like a subject town by Caesar's prefects.¹⁶ At another time a tribune was seen exercising authority outside the city bounds and invested with the *imperium* of a praetor.¹⁷ At the elections, candidates appeared before the people backed by a written recommendation from the dictator, which was equivalent to a command.¹⁸ Finally, the senate itself was

¹ See Mommsen, *Hist. of Rome*, v. 333, and Ranke, *Weltgeschichte*, ii. 319 seq. According to Appian ii. 110, and Plutarch, *Caes. 64*, the title *rex* was only to be used abroad in the East, as likely to strengthen Caesar's position against the Parthians.

² Cicero, *Phil. i. 2, 4*, praises Antony, "quum dictatoris nomen . . . propter perpetuae, dictaturae recentem memoriam funditus ex republica sustulisset."

³ For the long list of these, see Appian ii. 106; Dio xliii. 43-45; Plut. *Caes. 57*; Suet. *Jul. 76*. Cf. also Mommsen, *Hist. of Rome*, v. 329 ff.; Watson, *Cicero's Letters*, App. x.; Zumpt, *Studia Romana*, 199 seq. (Berlin, 1859).

⁴ Zumpt, *Stud. Rom.* 241; Suet. *Jul. 76*.

⁵ Cic. *Ad Att. x. 8a*.

⁶ Suet. *Jul. 41*, "Caesar dictator . . . commendo vobis illum et illum, ut vestro suffragio suam dignitatem teneant."

¹ Dio xli. 18.

² App. ii. 48; Dio xli. 36.

³ Plut. *Caes. 51*; Suet. 38, "adsignavit agros, sed non continuos, ne quis possessorum expelleretur." Cf. App. ii. 94.

⁴ For the *lex Julia de pecuniis mutuis*, see Suet. *Jul. 42*; Caesar, *B.C. iii. 1*; Dio xli. 37; App. ii. 48. The *faeneratores* were satisfied; Cic. *Ad Fam. viii. 17*. But the law displeased anarchists like M. Caesilius Rufus and P. Cornelius Dolabella.

⁵ Suet. *Jul. 42*.

⁶ *Ibid.* 41; Dio xliii. 21.

⁷ Suet. *Jul. 41*; Dio xliii. 25. ⁸ Suet. *Jul. 42*, 43.

⁹ See CALENDAR; Mommsen, *Hist. of Rome*, v. 438, and Fischer, *Röm. Zeitafeln*, 292 seq.

¹⁰ Plut. *Caes. 35*.

¹¹ Dio xliii. 47.

¹² Dio xliii. 44. For this use of the title *Imperator*, see Mommsen, *Hist. of Rome*, v. 332, and note.

transformed out of all likeness to its former self by the raising of its numbers to 900, and by the admission of old soldiers, sons of freedmen and even "semi-barbarous Gauls."¹ But, though Caesar's high-handed conduct in this respect was not imitated by his immediate successors, yet the main lines of their policy were laid down by him. These were—(1) the municipalization of the old republican constitution, and (2) its subordination to the paramount authority of the master of the legions and the provinces. In the first case he only carried further a change already in progress. Of late years the senate had been rapidly losing its hold over the Empire at large. Even the ordinary proconsuls were virtually independent potentates, ruling their provinces as they chose, and disposing absolutely of legions which recognized no authority but theirs. The

672.

consuls and praetors of each year had since 81 been stationed in Rome, and immersed in purely municipal business; and, lastly, since the enfranchisement of Italy, the *comitia*, though still recognized as the ultimate source of all authority, had become little more than assemblies of the city populace, and their claim to represent the true Roman people was indignantly questioned, even by republicans like Cicero. The concentration in Caesar's hands of all authority outside Rome completely and finally severed all real connexion between the old institutions of the Republic of Rome and the government of the Roman Empire. But the institutions of the Republic not merely became, what they had originally been, the local institutions of the city of Rome; they were also subordinated even within these narrow limits to the paramount authority of the man who held in his hands the army and the provinces. Autocratic abroad, at home he was the chief magistrate of the commonwealth; and this position was marked, in his case as in that of those who followed him, by a combination in his person of various powers, and by a general right of precedence which left no limits to his authority but such as he chose to impose upon himself. During the greater

706.

part of his reign he was consul as well as dictator. In 48, after his victory at Pharsalia, he was given the *tribunicia potestas* for life,² and after his second success at Thapsus the *praefectura morum* for three years.³ As chief magistrate he convenes and presides in the senate, nominates candidates, conducts elections, carries laws in the assembly and administers justice in court.⁴ Finally, as a reminder that the chief magistrate of Rome was also the autocratic ruler of the Empire, he wore even in Rome the laurel wreath and triumphal dress, and carried the sceptre of the victorious imperator.⁵

Nor are we without some clue as to the policy which Caesar had sketched out for himself in the administration of the Empire, the government of which he had centralized in his own hands. The much-needed work of rectifying the frontiers⁶ he was forced, by his premature death, to leave to other hands, but within the frontiers he anticipated Augustus in lightening the financial burdens of the provincials,⁷ and in establishing a stricter control over the provincial governors,⁸ while he went beyond him in his desire to consolidate the Empire by extending the Roman franchise⁹ and admitting provincials to a share in the government.¹⁰ He completed the Romanization of Italy by his enfranchisement of the Transpadane Gauls,¹¹ and by establishing throughout the peninsula a uniform system of municipal government, which under his successors was gradually extended to the provinces.¹²

On the eve of his departure for the East, to avenge the death of Crassus and humble the power of Parthia, Caesar fell a victim to the wounded pride of the republican nobles; and between the day of his death (March 15, 44) and that on which Octavian defeated Antony at Actium (September 2, 31) lies a dreary period of anarchy and bloodshed.¹³

For a moment, in spite of the menacing attitude of Caesar's self-constituted representative Marcus Antonius (Mark Antony), it seemed to one man at least as if the restoration of republican government was possible. With indefatigable energy Cicero strove to enlist the senate, the people, and above all the provincial governors in support of the old constitution. But, though his eloquence now and again carried all before it in senate-house and forum, it was powerless to alter the course of events. By the beginning of 43 civil war had recommenced; in the autumn Antony was already threatening an invasion of Italy at the head of seventeen legions. Towards the end of October Antony and his ally M. Aemilius Lepidus coalesced with the young Octavian, who had been recently elected consul at the age of twenty, in spite of senatorial opposition; and the coalition was legalized by the creation of the extraordinary commission for the "reorganization of the commonwealth" known as the "Second Triumvirate."¹⁴ It was appointed for a period of five years, and was continued in 37 for five years more.¹⁵ The rule of the triumvirs was inaugurated in the Sullan fashion by a proscription, foremost among the victims of which was Cicero himself.¹⁶ In the next year the defeat of M. Junius Brutus and C. Cassius Longinus at Philippi, by the combined forces of Octavian and Antony, destroyed the last hopes of the republican party.¹⁷ In 40 a threatened rupture between the two victors was avoided by the treaty concluded at Brundisium. Antony married Octavian's sister Octavia, and took command of the eastern half of the empire; Octavian appropriated Italy and the West; while Lepidus was forced to content himself with Africa.¹⁸ For the next twelve years, while Antony was indulging in dreams of founding for himself and Cleopatra an empire in the East, and shocking Roman feeling by his wild excesses and his affectation of oriental magnificence,¹⁹ Octavian was patiently consolidating his power. Lepidus his fellow-triumvir was in 36 ejected from Africa and banished to Circiæ, while Sextus Pompeius, who had since his defeat at Munda maintained a semi-piratical ascendancy in the western Mediterranean, was decisively defeated in the same year, and his death in 35 left Octavian sole master of the West. The inevitable trial of strength between himself and Antony

was not long delayed. In 32 Antony openly challenged the hostility of Octavian by divorcing Octavia in favour of the beautiful and daring Egyptian princess, with whom, as the heiress of the Ptolemies, he aspired to share the empire of the Eastern world. By a decree of the senate Antony was declared deposed from his command, and war was declared against Queen Cleopatra.²⁰ On the 2nd of September 31 was fought the battle of Actium.²¹ Octavian's victory was complete. Antony and Cleopatra committed suicide (30), and the Eastern provinces submitted in 29. Octavian returned to Rome to celebrate his triumph and mark the end of the long-continued anarchy

710.

718.

719.

722.

723.

724.

725.

¹ Suet. *Jul.* 41, 76; Dio xliii. 47.

² Dio xliii. 40.

³ Dio xliii. 14; Suet. *Jul.* 76. The statement is rejected by Mommsen; see CAESAR.

⁴ Suet. *Jul.* 43. "jus laboriosissime ac severissime direct." ⁵ App. ii. 106; Dio xliii. 43.

⁶ Plut. *Caes.* 58, "ὀνόμαζα τὸν ἄλλοθεν τῆς ἡγεμονίας"; Suet. *Jul.* 44; Dio xliii. 51.

⁷ Plut. *Caes.* 48; App. v. 4.

⁸ He limited the term of command to two years in consular and one year in praetorian provinces; Cicero, *Phil.* i. 8, 19; Dio xliii. 25.

⁹ Suet. *Jul.* 42; Cic. *Ad. Att.* xiv. 12.

¹⁰ Suet. *Jul.* 76.

¹¹ Dio xli. 36; Tac. *Ann.* xi. 24.

¹² *Lex Julia municipalis*; see CAESAR.

¹³ For this period see Merivale, *Romans under the Empire*, vol. iii.; Lange, *Röm. Alterth.* iii. 506 seq.; Gardthausen, *Augustus*, bk. i.

¹⁴ The triumvirate was formally constituted in Rome (Nov. 27th) by a *plebiscitum*; App. iv. 7; Dio xlvi. 56, xlvii. 2; Livy, *Epit.* cxx., "ut IIIviri republicae constituendae per quinque annos essent."

¹⁵ Dio xlviii. 54; App. v. 95. For the date, cf. Mommsen, *Staatsr.* ii. 718.

¹⁶ Livy, *Epit.* cxx.; App. iv. 7; and article CICERO.

¹⁷ Dio xlvii. 35-49; App. iv. 87-138.

¹⁸ Vell. ii. 76; Dio xlviii. 28; App. v. 65.

¹⁹ For Antony's policy and schemes in the East, see Ranke, *Weltgeschichte*, ii. 381-85; Mommsen, *Provinces of the Roman Empire*, ii. p. 24 sqq.; Lange, *Röm. Alterth.* iii. 573 sqq.

²⁰ Suet. *Aug.* 17; Dio i. 1-8; Plutarch, *Anton.* 53.

²¹ Dio li. 1; Zonaras x. 30.

by closing the temple of Janus;¹ at the end of the next year he formally laid down the extraordinary powers which he had held since 43, and a regular government was established.

III. *The Empire.*

PERIOD I: THE PRINCIPATE, 27 B.C.—A.D. 284.—(a) *The Constitution of the Principate.*—The conqueror of Antonius at Actium, the great-nephew and heir of the dictator Caesar, was now summoned, by the general consent of a world wearied out with twenty years of war and anarchy,² to the task of establishing a government which should as far as possible respect the forms and traditions of the Republic, without sacrificing that centralization of authority which experience had shown to be necessary for the integrity and stability of the Empire. It was a task for which Octavian was admirably fitted. To great administrative capacity and a quiet tenacity of purpose he united deliberate caution and unflinching tact; while his bourgeois birth³ and genuinely Italian sympathies enabled him to win the confidence of the Roman community to an extent impossible for Caesar, with his dazzling pre-eminence of patrician descent, his daring disregard of forms and his cosmopolitan tastes.

The new system which was formally inaugurated by Octavian in 28–27 B.C.⁴ assumed the shape of a restoration of the republic under the leadership of a *princeps*.⁵ Octavian voluntarily resigned the extraordinary powers which he had held since 43, and, to quote his own words, “handed over the republic to the control of the senate and people of Rome.”⁶ The old constitutional machinery was once more set in motion; the senate, assembly and magistrates resumed their functions;⁷ and Octavian himself was hailed as the “restorer of the commonwealth and the champion of freedom.”⁸ It was not so easy to determine what relation he himself, the actual master of the Roman world, should occupy towards this revived republic. His abdication, in any real sense of the word, would have simply thrown everything back into confusion. The interests of peace and order required that he should retain at least the substantial part of his authority;⁹ and this object was in fact accomplished, and the rule of the emperors founded, in a manner which has no parallel in history. Any revival of the kingly title was out of the question, and Octavian himself expressly refused the dictatorship.¹⁰ Nor was any new office created or any new official title invented for his benefit. But by senate and people he was invested according to the old constitutional forms with certain powers, as many citizens had been before him, and so took his place by the side of the lawfully appointed magistrates of the republic;—only, to mark his pre-eminent dignity, as the first of them all, the senate decreed that he should take as an additional cognomen that of “Augustus,”¹¹ while in common parlance he was henceforth styled *princeps*, a simple title of courtesy, familiar to republican usage, and conveying no other idea than that of a

recognized primacy and precedence over his fellow-citizens.¹² The ideal sketched by Cicero in his *De Republica*, of a constitutional president of a free republic, was apparently realized; but it was only in appearance. For in fact the special prerogatives conferred upon Octavian gave him back in substance the autocratic authority he had resigned, and as between the restored republic and its new *princeps* the balance of power was overwhelmingly on the side of the latter.

Octavian had held the *imperium* since 43; in 33, it is true, the powers of the triumvirate had legally expired, but he had continued to wield his authority, as he himself puts it,¹³ “by universal consent.” In 27–27 B.C. he received a formal grant of the *imperium* from the senate and people for the term of ten years, and his *provincia* was defined as including all the provinces in which military authority was required and legions were stationed.¹⁴ He was declared commander-in-chief of the Roman army, and granted the exclusive right of levying troops, of making war and peace, and of concluding treaties.¹⁵ As consul, moreover, he not only continued to be the chief magistrate of the state at home, but took precedence, in virtue of his *majus imperium*, over the governors of the “unarmed provinces,” which were still nominally under the control of the senate. Thus the so-called “restoration of the republic” was in essence the recognition by law of the personal supremacy of Octavian, or Augustus, as he must henceforth be called.

In 23 an important change was made in the formal basis of Augustus's authority. In that year he laid down the consulship which he had held each year since 31, and could therefore only exert his *imperium pro consule*, like the ordinary governor of a province. He lost his authority as chief magistrate in Rome and his precedence over the governors of senatorial provinces. To remedy these defects a series of extraordinary offices were pressed upon his acceptance; but he refused them all,¹⁶ and caused a number of enactments to be passed which determined the character of the principate for the next three centuries.¹⁷ Firstly, he was exempted from the disability attaching to the tenure of the *imperium* by one who was not an actual magistrate, and permitted to retain and exercise it in Rome. Secondly, his *imperium* was declared to be equal with that of the consuls, and therefore superior to that of all other holders of that power. Thirdly, he was granted equal rights with the consuls of convening the senate and introducing business, of nominating candidates at elections,¹⁸ and of issuing edicts.¹⁹ Lastly, he was placed on a level with the consuls in outward rank. Twelve lictors were assigned to him and an official seat between those of the consuls themselves (Dio liv. 10).

Thus the proconsular authority²⁰ was for the first time admitted within the walls of Rome; but Augustus was too cautious a statesman to proclaim openly the fact that the power which he wielded in the city was the same as that exercised in camps and provinces by a Roman military commander. Hence he sought for a title which should disguise the nature of his authority, and found it in the

¹ He celebrated his triumph on the 13th, 14th and 15th of August; Dio li. 21; Livy, *Epit.* cxxxiil. For the closing of the temple of Janus, see Livy l. 19; Vell. li. 38; Suet. *Aug.* 22.

² Tac. *Ann.* i. 2, “cunctos dulcedine otii pellexit.”

³ Suet. *Aug.* i. 1. His grandfather was a citizen of Velitrae; “municipalibus magistris contentus.”

⁴ Mommsen, *Staatsrecht*, ii. 745 ff.; *Mon. Anryanum* (ed. Mommsen, Berlin, 1883), vi. 13–23, pp. 144–53; Herzog, *Gesch. u. System d. rom. Verfassung*, ii. 126 sqq.

⁵ Tac. *Ann.* iii. 28, “sexto demum consulatu . . . quae IIIviratu jussertat abolevit, deditque jura quae pax et principis uteretur”; *Ibid.* i. 9, “non regno, neque dictatura sed principis nomine constitutum republicam.”

⁶ *Mon. Anc.* vi. 13.

⁷ Vell. ii. 89, “prisca et antiqua reipublicae forma revocata.”

⁸ Ovid, *Fastii*, i. 589. On a coin of Asia Minor Augustus is styled “libertatis P. R. vindex.” The 13th of January, 27 B.C., was marked in the calendar as the day on which the republic was restored (C.I.L. l. p. 384).

⁹ Dio Cassius describes Augustus as seriously contemplating abdication (iii. 1; iii. 1–11); cf. Suet. *Aug.* 28.

¹⁰ Suet. *Aug.* 52; *Mon. Anc.* i. 31.

¹¹ *Mon. Anc.* vi. 16, 21–23.

¹² *Ibid.* 721. The settlement of 27–27 B.C.

The re-settlement of 23–731. 723.

Tribunus potestas.

¹³ The explanation of *princeps* as an abbreviated form of *princeps senatus* is quite untenable. For its real significance, see Mommsen, *Staatsrecht*, ii. 774; Pelham, *Journ. of Philol.* vol. viii. It is not an official title.

¹⁴ *Mon. Anc.* 6, 14, “pro consensu universorum.”

¹⁵ Dio lii. 12; Suet. *Aug.* 47.

¹⁶ He was offered the dictatorship, a life-consulship, a “cura legum et morum.” It is stated by Suetonius (*Aug.* 53) and Dio (liv. 10) that he accepted the last named; but this is disproved by his own language in the *Mon. Anc.* (i. 31); cf. Pelham, *Journ. of Philol.* xvii. 47.

¹⁷ Dio liii. 32. Part of the law by which the rights essential to the principate were conferred upon Vespasian is extant; see Rushforth, *Latin Historical Inscriptions*, No. 70 (the *Lex de imperio Vespasiano*).

¹⁸ Tac. *Ann.* i. 81.

¹⁹ *Lex de imperio*, li. 17–21.

²⁰ The term *proconsulare imperium*, which we find used, e.g., by Tacitus, was not employed in republican times, and Augustus himself speaks of his *consulare imperium* (*Mon. Anc.* 2, 5, 8).

"tribunician power," which had been conferred upon him for life in 36, and was well suited, from its urban and democratic traditions, to serve in Rome as "a term to express his supreme position."¹ From 23 onwards the *tribunicia potestas* appears after his name in official inscriptions, together with the number indicating the period during which it had been held (also reckoned from 23); it was in virtue of this power that Augustus introduced the social reforms which the times demanded;² and, though far inferior to the *imperium* in actual importance, it ranked with or even above it as a distinctive prerogative of the emperor or his chosen colleague.³

The *imperium* and the *tribunicia potestas* were the two pillars upon which the authority of Augustus rested, and the other offices and privileges conferred upon him were of secondary importance. After 23 he never held the consulship save in 5 and 2 B.C., when he became the colleague of his grandsons on their introduction to public life. He permitted the triumvir Lepidus to retain the chief pontificate until his death, when Augustus naturally became *pontifex maximus* (12 B.C.).⁴

He proceeded with the like caution in reorganizing the chief departments of the public service in Rome and Italy. The *cura annonae*, i.e. the supervision of the corn supply of Rome, was entrusted to him in 22 B.C.,⁵ and this important branch of administration thus came under his personal control; but the other boards (*curae*), created during his reign to take charge of the roads, the water-supply, the regulation of the Tiber and the public buildings, were composed of senators of high rank, and regarded in theory as deriving their authority from the senate.⁶

Such was the ingenious compromise by which room was found for the master of the legions within the narrow limits of the old Roman constitution. Augustus could say with truth that he had accepted no office which was "contrary to the usage of our ancestors," and that it was only in dignity that he took precedence of his colleagues. Nevertheless, as every thinking man must have realized, the compromise was unreal, and its significance was ambiguous. It was an arrangement avowedly of an exceptional and temporary character, yet no one could suppose that it would in effect be otherwise than permanent. The powers voted to Augustus were (like those conferred upon

Pompey in 67 B.C.) voted only to him, and (save the *tribunicia potestas*) voted only for a limited time; in 27 he received the *imperium* for ten years, and it was afterwards renewed for successive periods of five, five, ten and ten years.⁷

In this way the powers of the princeps were made coextensive in time with the life of Augustus, but there was absolutely no provision for hereditary or any other form of succession, and various expedients were devised in order to indicate the destined successor of the *princeps* and to bridge the gap created by his death. Ultimately Augustus associated his stepson Tiberius with himself as co-regent. The *imperium* and the *tribunicia potestas* were conferred upon him, and he was thus marked out as the person upon whom the remaining powers of the princeps would naturally be bestowed after the death of his stepfather. But succeeding emperors did not always indicate their successors so clearly, and, in direct contrast to the maxim that "the king never dies," it has been well said that the Roman princeps died with the death of the *princeps*.⁸

In theory, at least, the Roman world was governed according to the "maxims of Augustus" (Suet. *Ner.* 10), down to the *Changes in the constitution of the principate*. Even in the 3rd century there is still in name at least, a republic, of which the emperor is in strictness only the chief magistrate, deriving his authority from the senate and people, and with prerogatives limited and defined by law. The case is quite different when we turn from theory to practice. The

division of authority between the republic and its chief magistrate became increasingly unequal. Over the provinces the *princeps* from the first ruled autocratically; and this autocracy reacted upon his position in Rome, so that it became every year more difficult for a ruler so absolute abroad to maintain even the fiction of republican government at home. The republican institutions, with the partial exception of the senate, lose all semblance of authority outside Rome, and even as the municipal institutions of the chief city of the empire they retain but little actual power. The real government even of Rome passes gradually into the hands of imperial prefects and commissioners, and the old magistracies become merely decorations which the emperor bestows at his pleasure. At the same time the rule of the *princeps* assumes an increasingly personal character, and the whole work of government is silently concentrated in his hands and in those of his own subordinates. Closely connected with this change is the different aspect presented by the history of the empire in Rome and Italy on the one hand and in the provinces on the other. Rome and Italy share in the decline of the republic. Political independence and activity die out; their old pre-eminence and exclusive privileges gradually disappear; and at the same time the weight of the overwhelming power of the *princeps*, and the abuses of their power by individual *princeps*, press most heavily upon them. On the other hand, in the provinces and on the frontiers, where the imperial system was most needed, and where from the first it had full play, it is seen at its best as developing or protecting an orderly civilization and maintaining the peace of the world.

The decay of the republican institutions had commenced before the revolutionary crisis of 49. It was accelerated by the virtual suspension of regular government between 49 and 28; and not even the diplomatic deference towards ancient forms which Augustus displayed availed to conceal the unreality of his work of restoration. The *comitia* received back from him "their ancient rights" (Suet. *Aug.* 40), and during his lifetime they continued to pass laws and to elect magistrates. But after the end of the reign of Tiberius we have only two instances of legislation by the assembly in the ordinary way,⁹ and the law-making of the empire is performed either by decrees of the senate or by imperial edicts and constitutions. Their prerogative of electing magistrates was, even under Augustus, robbed of most of its importance by the control which the *princeps* exercised over their choice by means of his rights of nomination and commendation, which effectually secured the election of his own nominees.¹⁰ By Tiberius this restricted prerogative was still further curtailed. The candidates for all magistracies except the consulship were thenceforward nominated and voted for in the senate-house and by the senators,¹¹ and only the formal return of the result (*renuntiatio*) took place in the assembly (Dio lvi. 20). And, though the election of consuls was never thus transferred to the senate, the process of voting seems to have been silently abandoned. In the time of the younger Pliny we hear only of the nomination of the candidates and of their formal *renuntiatio* in the Campus Martius.¹² The *princeps*, himself as long as the Principate lasted, continued to receive the *tribunicia potestas* by a vote of the assembly, and was thus held to derive his authority from the people.¹³

Decay of republican institutions. 705, 726.
The comitia.

⁹ The *plebiscita* of Claudius, Tac. *Ann.* xi. 13, 14, and the *lex agraria* of Nerva; *Digest*, xlvii. 21, 3; Dio lxxvii. 2; Plin. *Epp.* vii. 31.

¹⁰ On these rights, the latter of which was not exercised in the case of the consulship until the close of Nero's reign, see Mommsen, *Staatsr.* ii. 916-28; Tac. *Ann.* i. 14, 15, 81; Suet. *Aug.* 56; Dio lvi. 20.

¹¹ Tac. *Ann.* i. 15, "comitia e campo ad patres translata sunt"; compare *Ann.* xv. 28. The magistracy directly referred to is the praetorship, but that the change affected the lower magistracies also is certain; see, e.g., Pliny's *Letters, passim*, especially iii. 20, vi. 19.

¹² Plin. *Paneg.* 92.

¹³ Galus i. 5, "cum ipse imperator per legem imperium accipiat."

¹ Tac. *Ann.* iii. 56; "summi fastigii vocabulum."

² *Mon. Anc. Graec.* 3, 19.

³ Tac. *Ann.* i. 3 (of Tiberius), "collega imperii, consors tribuniciae potestatis"; cf. Mommsen, *Staatsr.* ii. 1160.

⁴ Suet. *Aug.* 31. ⁵ *Mon. Anc.* i. 32; Dio liv. 1.

⁶ See Hirschfeld, *Verwaltungsgesch.* i. 173.

⁷ Dio liii. 13, 16. ⁸ Mommsen, *Staatsr.* ii. 1143.

THE ROMAN EMPIRE 14 A.D. - 117 A.D.

Scale, 1:25,000,000
English Miles
0 50 100 200 300 400

Roman Miles
0 50 100 200 300 400

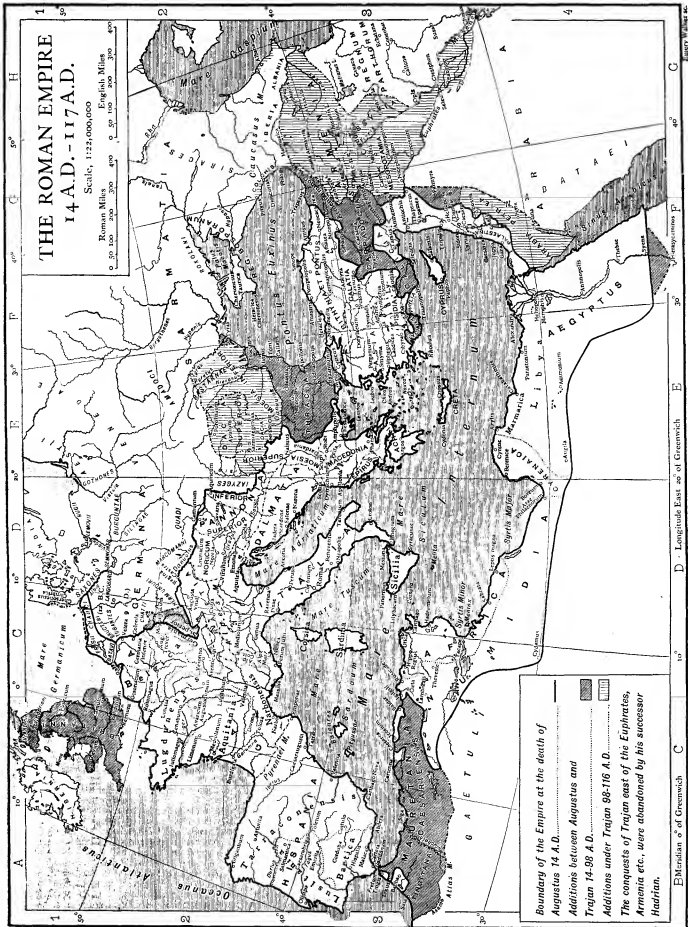

Boundary of the Empire at the death of Augustus 14 A.D......

Additions between Augustus and Trajan 14-98 A.D......

Additions under Trajan 98-116 A.D......

The conquests of Trajan east of the Euphrates, Armenia etc., were abandoned by his successor Hadrian......

THE ROMAN EMPIRE in the reign of Diocletian

A. D. 297

Scale, 1:119,000,000
 Roman Miles 0 50 100 200 300
 English Miles 0 50 100 200 300

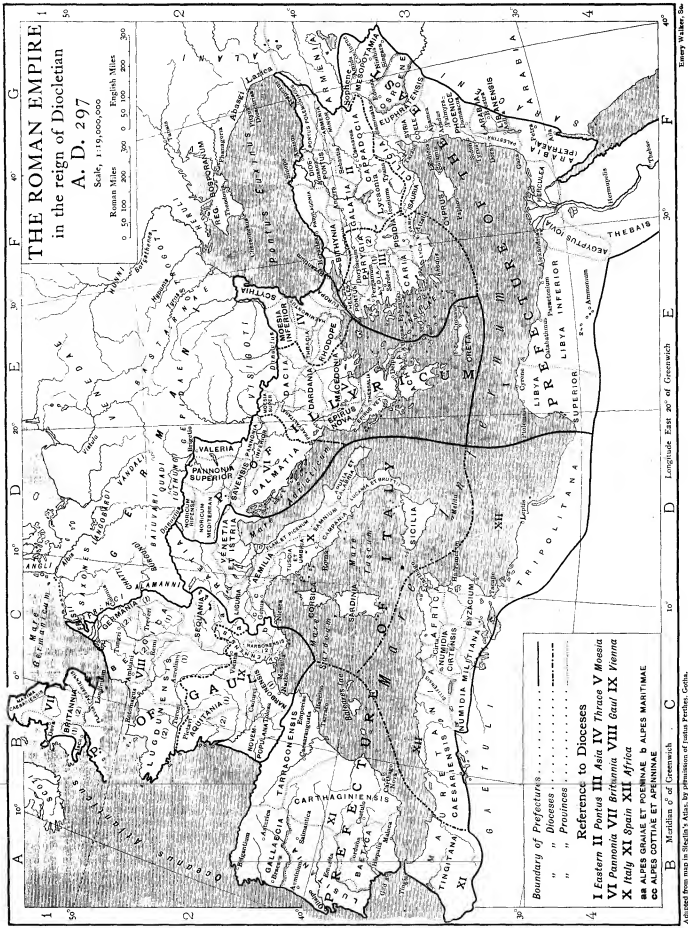

- Boundary of Praefecturae
 - Dioceses
 - Provinces
- Reference to Dioceses
- I Eastern II Pontus III Asia IV Thrace V Messia
 - VI Pannonia VII Britannia VIII Gaul IX Vienna
 - X Italy XI Spain XII Africa
 - aa ALPES GRAINAE ET POENINAE b ALPES MARITIMAE
 - cc ALPES COTTIAE ET APENNINAE

Longitude East 30° of Greenwich E 10° D Longitude East 20° of Greenwich E 30° F 40°

Latitude North 50° A 60° B 70° C 80° D 90° E 100° F 110° G 120° H 130° I 140° J 150° K 160° L 170° M 180° N 190° O 200° P 210° Q 220° R 230° S 240° T 250° U 260° V 270° W 280° X 290° Y 300° Z

Scale, 1:119,000,000
 Roman Miles 0 50 100 200 300
 English Miles 0 50 100 200 300

Map of the Roman Empire in the reign of Diocletian, A.D. 297. The map shows the extent of the empire at its greatest, from the British Isles in the west to the Persian Gulf in the east, and from the Alps in the north to the Nile delta in the south. Major cities and provinces are labeled. The map is overlaid with a grid of latitude and longitude lines.

Map of the Roman Empire in the reign of Diocletian, A.D. 297. The map shows the extent of the empire at its greatest, from the British Isles in the west to the Persian Gulf in the east, and from the Alps in the north to the Nile delta in the south. Major cities and provinces are labeled. The map is overlaid with a grid of latitude and longitude lines.

This almost complete effacement of the *comitia* was largely due to the fact that they had ceased to represent anything but the populace of Rome, and the comparatively greater vitality shown by the old magistracies is mainly attributable to the value they continued to possess in the eyes of the Roman upper class. But, though they were eagerly sought (Plin. *Epp.* ii. 9, vi. 6), and conferred on their holders considerable social distinction, the magistracies ceased, except in name, to be the popularly chosen executive officers of the Roman state. In the administration of the empire at large they had no share, if we except the subordinate duties still assigned to the quaestor in a province. In Rome, to which their sphere of work was limited, they were overshadowed by the dominant authority of the *princeps*, while their range of duties was increasingly circumscribed by the gradual transference of administrative authority, even within the city, to the emperor and his subordinate officials. And their dependence on the *princeps* was confirmed by the control he exercised over their appointment. For all candidates the approval, if not the commendation, of the *princeps* became the indispensable condition of success, and the *princeps* on his side treated these ancient offices as pieces of preferment with which to reward his adherents or gratify the ambition of Roman nobles. The dignity of the office, too, was impaired by the practice, begun by Caesar and continued by Augustus and his successors, of granting the insignia to men who had not held the actual magistracy itself.¹ The consulship was still the highest post open to the private citizen, and consular rank a necessary qualification for high office in the provinces;² but the actual consuls have scarcely any other duties than those of presiding in the senate and occasionally executing its decrees, while their term of office dwindles from a year to six and finally to two months.³ In the age of Tacitus and the younger Pliny, the contrast is striking between the high estimate set on the dignity of the office and the frankness with which its limited powers and its dependence on the emperor are acknowledged.⁴ The praetors continued to exercise their old jurisdiction with little formal change down at least to the latter half of the second century, but only as subordinate to the higher judicial authority of the emperor.⁵ The aediles retained only such petty police duties as did not pass to one or another of the imperial prefects and commissioners. The tribunate: fared still worse, for, by the side of the *tribunicia potestas* wielded by the *princeps*, it sank into insignificance.⁶ The quaestorship suffered less change than any other of the old offices. It kept its place as the first step on the ladder of promotion, and there was still a quaestor attached to each governor of a senatorial province, to the consuls in Rome, and to the *princeps* himself.⁷

The senate alone among republican institutions retained some importance and influence, and it thus came to be regarded as sharing the government of the Empire with the *princeps* himself. It nominally controlled the administration of Italy and of the "public provinces," whose governors

¹ On the permission to use the *ornamenta consularia, praetoria, &c.*, see Mommsen, *Staatsr.* i. 455 sqq.; Suet. *Jul.* 76; Claud. v. 24; Tac. *Ann.* xii. 21, xv. 72; Dio Cass. ix. 8. Cf. also Friedländer, i. 691.

² For a consular senatorial province and for the more important of the imperial legations.

³ Mommsen, *Staatsr.* ii. 82 sqq. Six months was the usual term down to the death of Nero; we have then four or two months; in the 3rd century two is the rule. The consuls who entered on office on the 1st of January were styled *consules ordinarii*, and gave their name to the year, whilst the others were distinguished as *consules suffecti* or *minores*; Dio Cass. xlviii. 35.

⁴ Plin. *Paneg.* 92; Tac. *Hist.* i. 1, *Agric.* 44.

⁵ Mommsen, *Staatsr.* ii. 225.

⁶ Plin. *Epp.* i. 23, "inanem umbram et sine honore nomen." There are a few instances of the exercise by the tribunes of their power of interference within the senate; Tac. *Ann.* i. 77, vi. 47, xvi. 26; Plin. *Epp.* ix. 13.

⁷ Mommsen, *Staatsrecht*, ii. 567-69. Pliny was himself "quaestor Caesaris," *Epp.* vii. 16.

it appointed. It is to the senate, in theory, that the supreme power reverts in the absence of a *princeps*. It is by decree of the senate that the new *princeps* immediately receives his powers and privileges,⁸ though he is still supposed to derive them ultimately from the people. After the cessation of all legislation by the *comitia*, the only law-making authority, other than that of the *princeps* by his edicts, was that of the senate by its decrees.⁹ Its judicial authority was co-ordinate with that of the emperor, and at the close of the 1st century we find the senators claiming, as the emperor's "peers," to be exempt from his jurisdiction.¹⁰ But in spite of the outward dignity of its position, and of the deference with which it was frequently treated, the senate became gradually almost as powerless in reality as the *comitia* and the magistracies. The senators continued indeed to be taken as a rule from the ranks of the wealthy, and a high property qualification was established by Augustus as a condition of membership; but this merely enabled the emperors to secure their own ascendancy by subsidizing those whose property fell short of the required standard, and who thus became simply the paid creatures of their imperial patrons.¹¹ Admission to the senate was possible only by favour of the emperor, both as controlling the elections to the magistracies, which still gave entrance to the curia, and as invested with the power of directly creating senators by *adlectio*, a power which from the time of Vespasian onwards was freely used.¹² As the result, the composition of the senate rapidly altered. Under Augustus and Tiberius it still contained many representatives of the old republican families, whose prestige and ancestral traditions were some guarantee for their independence. But this element soon disappeared. The ranks of the old nobility were thinned by natural decay and by the jealous fears of the last three Claudian emperors. Vespasian¹³ flooded the senate with new men from the municipal towns of Italy and the Latinized provinces of the West. Trajan and Hadrian, both provincials themselves, carried on the same policy, and by the close of the 2nd century even the Greek provinces of the East had their representatives in the senate. Some, no doubt, of these provincials, who constituted the great majority of the senate in the 3rd century, were men of wealth and mark, but many more were of low birth, on some rested the stain of a servile descent, and all owed alike their present position and their chances of further promotion to the emperor.¹⁴ The procedure of the senate was as completely at the mercy of the *princeps* as its composition. He was himself a senator and the first of senators;¹⁵ he possessed the magisterial prerogatives of convening the senate, of laying business before it, and of carrying *senatus consulta*;¹⁶ above all, his tribunician power enabled him to interfere at any stage, and to modify or reverse its decisions. The share of the senate in the government was in fact determined by the amount of administrative activity which each *princeps* saw fit to allow it to exercise, and this share became steadily smaller. The jurisdiction assigned it by Augustus and Tiberius was in the 3rd century limited to the hearing of such cases as the emperor thought fit to send for trial, and these became steadily fewer in number. Its control of the state treasury, as distinct from the imperial *Fiscus*, was in fact little more than nominal, and became increasingly unimportant as the great bulk of the revenue passed

⁸ Mommsen, *Staatsrecht*, ii. 842; Tac. *Ann.* xii. 69, *Hist.* i. 47. In the 3rd century the honours, titles and powers were conferred *en bloc* by a single decree; *Vit. Sev. Alex.* 1.

⁹ Gaius i. 4; Ulpian, *Dig.* i. 3. 9.

¹⁰ Under Domitian; Dio Cass. lxxvii. 2. Even Septimius Severus caused a decree to be passed "ne liceret imperatori inconsulato senatu occidere senatorem" *Vita Severi*, 7.

¹¹ Suet. *Nero*, 10, *Vesp.* 17.

¹² Mommsen, *Staatsrecht*, ii. 939 sqq. The power was derived from the censorial authority. Domitian was censor for life; Suet. *Dom.* 8. After Nerva it was exercised as falling within the general authority vested in the *princeps*; Dio liii. 17.

¹³ Suet. *Vesp.* 90; Tac. *Ann.* iii. 55.

¹⁴ See on this point Friedländer, *Sittengeschichte Roms*, i. 237 sqq. in *Mon. Ancyr.* Gr. iv. 3, πῶτος ἀδελφός τῶτος.

¹⁵ *Lex de imp. Vesp.*, *C.I.L.* vi. 930: "Senatum habere, reipublicam facere, remittere; Seta, per relationem discessionemque facere."

into the hands of the emperor. Even in Rome and Italy its control of the administration was gradually transferred to the prefect of the city, and after the reign of Hadrian to imperial officers (*juridici*) charged with the civil administration.¹ The part still played by its decrees in the modification of Roman law has been dealt with elsewhere (see SENATE), but it is clear that these decrees did little else than register the expressed wishes of the emperor and his personal advisers.

The process by which all authority became centralized in the hands of the *princesps* and in practice exercised by an organized bureaucracy² was of necessity gradual; but it had its beginnings under Augustus, who formed the equestrian order (admission to which was henceforth granted only by him) into an imperial service, partly civil and partly military, whose members, being immediately dependent on the emperor, could be employed on tasks which it would have been impossible to assign to senators (see EQUITES). From this order were drawn the armies of "procurators"—the term was derived from the practice of the great business houses of Rome—who administered the imperial revenues and properties in all parts of the empire. Merit was rewarded by independent governorships such as those of Raetia and Noricum, or the command of the naval squadrons at Misenum and Ravenna; and the prizes of the knight's career were the prefectures of the praetorian guard, the corn-supply and the city police, and the governorship of Egypt. The household offices and imperial secretariats were held by freedmen, almost always of Greek origin, whose influence became all-powerful under such emperors as Claudius.³ The financial secretary (*a rationibus*) and those who dealt with the emperor's correspondence (*ab epistulis*) and with petitions (*a libellis*) were the most important of these.

This increase of power was accompanied by a corresponding elevation of the *princeps* himself above the level of all other citizens. The comparatively modest household and simple life of Augustus were replaced by a more than regal splendour, and under Nero we find all the outward accessories of monarchy present, the palace, the palace guards, the crowds of courtiers, and a court ceremonial. In direct opposition to the republican theory of the principate, members of the family of the *princeps* share the dignities of his position. The males bear the cognomen of Caesar, and are invested, as youths, with high office; their names and even those of the females are included in the yearly prayers for the safety of the *princeps*; their birthdays are kept as festivals; the praetorian guards take the oath to them as well as to the *princeps* himself. The logical conclusion was reached in the practice of Caesar-worship,⁴ which was in origin the natural expression of a widespread sentiment of homage, which varied in form in different parts of the empire and in different classes of society, but was turned to account by the statecraft of Augustus to develop something like an imperial patriotism. The official worship of the deified Caesar, starting from that of the "divine Julius," gave a certain sanctity and continuity to the regular succession of the emperors, but it was of less importance politically than the worship of "Rome and Augustus," first instituted in Asia Minor in 29 B.C., and gradually diffused throughout the provinces, as a symbol of imperial unity. It must be observed that living emperors were not officially worshipped by Roman citizens; yet we find that even in Italy an unauthorized worship of Augustus sprang up during his lifetime in the country towns.⁵

¹ *Vit. Hadr.* 22; "Juridici" were appointed by Marcus Aurelius, *Vit. Aut.* 11; Marquardt i. 224.

² On the growth of the imperial bureaucracy see Hirschfeld, *Die kaiserlichen Verwaltungsbeamten bis auf Diocletian* (1905).

³ For the position of the imperial freedmen under Claudius, see Friedländer i. 88 sqq.; Tac. *Ann.* xii. 60, xiv. 39, *Hist.* ii. 57, 95.

⁴ *Acta Fr. Arval.* (ed. Henzen), 33, 98, 99.

⁵ For Caesar-worship, see Mommsen, *Staatsr.* ii. 755 sqq.; Wissowa, *Religion und Kultus der Römer*, p. 283 sqq.; and Kornemann in *Beiträge zur alten Geschichte*, i.

⁶ See Rushforth, *Roman Historical Inscriptions*, Nos. 38 sqq. and notes.

On the accession of Augustus, there could be little doubt as to the nature of the work that was necessary, if peace and prosperity were to be secured for the Roman world. He was called upon to justify his position by rectifying the frontiers and strengthening their defences, by reforming the system of provincial government, and by reorganizing the finance; and his success in dealing with these three difficult problems is sufficiently proved by the prosperous condition of the empire for a century and a half after his death. To secure peace it was necessary to establish on all sides of the empire really defensible frontiers; and this became possible now that for the

The frontiers.

first time the direction of the foreign policy of the state and of its military forces was concentrated in the hands of a single magistrate. To the south and west the generals of the republic, and Caesar himself, had extended the authority of Rome to the natural boundaries formed by the African deserts and the Atlantic Ocean, and in these two directions Augustus's task was in the main confined to the organization of a settled Roman government within these limits. In Africa the client state of Egypt was ruled by Augustus as the successor of the Ptolemies, and administered by his deputies (*praefecti*), and the kingdom of Numidia (25 B.C.) was incorporated with the old province of Africa. In Spain the hill-tribes of the north-west were finally subdued and a third province, Lusitania, established.⁷ In Gaul Augustus (27 B.C.) established in addition to the "old province" the three new ones of Aquitania, Lugdunensis and Belgica,⁸ which included the territories conquered by Julius Caesar. Towards the north the republic had left the civilized countries bordering on the Mediterranean with only a very imperfect defence against the threatening mass of barbarian tribes beyond them. The result⁹ of Augustus's policy was to establish a protecting line of provinces running from the Euxine to the North Sea, and covering the peaceful districts to the south,—Moesia (A.D. 6), Pannonia (A.D. 9), Noricum (15 B.C.), Raetia (15 B.C.) and Gallia Belgica. Roman rule was thus carried up to the natural frontier lines of the Rhine and the Danube. It was originally intended to make the Elbe the frontier of the empire; but after the defeat of P. Quintilius Varus (A.D. 9) the forward policy was abandoned. Tiberius recalled Germanicus as soon as Varus had been avenged; and after the peace with Maroboduus, the chief of the Marcomanni on the upper Danube, in the next year (A.D. 17), the defensive policy recommended by Augustus was adopted along the whole of the northern frontier. The line of the great rivers was held by an imposing mass of troops. Along the Rhine lay the armies of Upper and Lower Germany, consisting of four legions each; eight more guarded the Danube and the frontiers of Pannonia and Moesia. At frequent intervals along the frontier were the military colonies, the permanent camps and the smaller intervening *castella*. Flotillas of galleys cruised up and down the rivers, and Roman roads opened communication both along the frontiers and with the seat of government in Italy.

The North.

In the East, Rome was confronted with a well-organized and powerful state whose claims to empire were second only to her own. The victory of Carrhae (53 B.C.) had encouraged among the Parthians the idea of an invasion of Syria and Asia Minor, while it had awakened in Rome a genuine fear of the formidable power which had so suddenly arisen in the East. Caesar was at the moment of his death preparing to avenge the death of Crassus by an invasion of Parthia, and Antony's schemes of founding an Eastern empire which should rival that of Alexander included the conquest of the kingdom beyond the Euphrates. Augustus, however, adhered to the policy which he recommended to his successors of "keeping the empire within its bounds"; and the Parthians, weakened by internal feuds and dynastic quarrels, were in no mood for vigorous action. Roman pride was satisfied by the restoration of the standards taken at Carrhae. Four legions guarded the line of the Euphrates, and, beyond the frontiers of Pontus and

The East.

⁷ Marquardt i. 257; Mommsen, *Provinces*, i. 64.

⁸ Marquardt i. 264; Mommsen, *Provinces*, i. 84 sqq.

⁹ See especially Mommsen, *Provinces*, i. caps. 4 and 6.

Cappadocia, Armenia was established as a "friendly and independent ally."¹

Next in importance to the rectification and defence of the frontiers was the reformation of the administration, and the restoration of prosperity to the distracted and exhausted provinces. The most serious defect of the republican system had been the absence of any effective control over the Roman officials outside Italy. This was now supplied by the general proconsular authority vested in the emperor. The provinces were for the first time treated as departments of a single state, while their governors, from being independent and virtually irresponsible rulers, became the subordinate officials of a higher authority.² Over the *legati* of the imperial provinces the control of the emperor was as complete as that of the republican proconsul over his staff in his own province. They were appointed by him, held office at his good pleasure, and were directly responsible to him for their conduct. The proconsuls of the senatorial provinces were in law magistrates equally with the *princeps*, though inferior to him in rank; it was to the senate that they were as of old responsible; they were still selected by lot from among the senators of consular and praetorian rank. But the distinction did not seriously interfere with the paramount authority of the emperor. The provinces left nominally to the senate were the more peaceful and settled districts in the heart of the empire, where only the routine work of civil administration was needed, and where the local municipal governments were as yet comparatively vigorous. The senatorial proconsuls themselves were indirectly nominated by the emperor through his control of the praetorship and consulship. They wielded no military and only a strictly subordinate financial authority, and, though Augustus and Tiberius, at any rate, encouraged the fiction of the responsibility of the senatorial governors to the senate, it was in reality to the emperor that they looked for direction and advice, and to him that they were held accountable. Moreover, in the case of all governors this accountability became under the empire a reality. Prosecutions for extortion (*de pecuniis repetundis*), which were now transferred to the hearing of the senate, are tolerably frequent during the first century of the empire; but a more effective check on maladministration lay in the appeal to Caesar from the decisions of any governor, which was open to every provincial, and in the right of petition. Finally, the authority both of the legate and the proconsul was weakened by the presence of the imperial procurator, to whom was entrusted the administration of the fiscal revenues; while both legate and proconsul were deprived of that right of requisitioning supplies which, in spite of a long series of restrictive laws, had been the most powerful instrument of oppression in the hands of republican governors.

Financial reforms.

The financial reforms of Augustus³ are marked by the same desire to establish an equitable, orderly and economical system, and by the same centralization of authority in the emperor's hands. The institution of an imperial census, or valuation of all land throughout the empire, and the assessment upon this basis of a uniform land tax, in place of the heterogeneous and irregular payments made under the republic, were the work of Augustus, though the system was developed and perfected by the emperors of the 2nd century and by Diocletian. The land tax itself was directly collected, either by imperial officials or by local authorities responsible to them, and the old wasteful plan of selling the privilege of collection to *publicani* was henceforward applied only to such indirect taxes as the customs duties. The rate of the land tax was fixed by the emperor, and with him rested the power of remission even in senatorial provinces.⁴ The effect of these reforms is clearly visible in the improved financial condition of

¹ Mommsen, *Provinces*, cap. 9. Armenia, however, long continued to be a debatable ground between Rome and Parthia—passing alternately under the influence of one or the other.

² For the provincial reforms of Augustus, see Marquardt, *Staatsverw.*, i. 544 sqq.

³ Marquardt, ii. 204 sqq.; Hirschfeld, *Verwaltungsbeamten*, 55 sqq.; Tac. *Ann.* ii. 47.

the empire. Under the republic the treasury had been nearly always in difficulties, and the provinces exhausted and impoverished. Under the emperors, at least throughout the 1st century, in spite of a largely increased expenditure on the army, on public works, on shows and largesses, and on the machinery of government itself, the better emperors, such as Tiberius and Vespasian, were able to accumulate large sums, while the provinces show but few signs of distress. Moreover, while the republic had almost entirely neglected to develop the internal resources of the provinces, Augustus set the example of a liberal expenditure on public works, in the construction of harbours, roads and bridges, the reclamation of waste lands, and the erection of public buildings.⁵ The crippling restrictions which the republic had placed on freedom of intercourse and trade, even between the separate districts of a single province, disappeared under the empire. In the eyes of the republican statesmen the provinces were merely the estates of the Roman people, but from the reign of Augustus dates the gradual disappearance of the old pre-eminence of Rome and Italy. It was from the provinces that the legions were increasingly recruited; provincials rose to high rank as soldiers, statesmen and men of letters,⁶ and the methods of administration, formerly distinctive of the provinces, were adopted even in Rome and Italy. From Augustus himself, jealous as he was of the traditions and privileges of the ruling Roman people, date the rule of an imperial prefect⁷ in the city of Rome, the division of Italy into *regiones* in the provincial fashion, and the permanent quartering there of armed troops.⁸

Augustus founded a dynasty which occupied the throne for more than half a century after his death. The first and by far the ablest of its members was Tiberius (A.D. 14-37). The Julio-Claudian line, who enforced justice in the government of the provinces, maintained the integrity of the frontiers and husbanded the finances of the empire, but he became intensely unpopular in Roman society, and was painted as a cruel and odious tyrant. His successor, Gaius (A.D. 37-41), generally known as Caligula, was the slave of his wild caprices and uncontrolled passions, which issued in manifest insanity. He was followed by his uncle, Claudius (A.D. 41-54), whose personal uncouthness made him an object of derision to his contemporaries, but who was by no means devoid of statesmanlike faculties. His reign left an abiding mark on the history of the empire, for he carried forward its development on the lines intended by Augustus. Client-states were absorbed, southern Britain was conquered, the Romanization of the West received a powerful impulse, public works were executed in Rome and Italy, and the organization of the imperial bureaucracy made rapid strides. Nero (A.D. 54-68), the last of the Julio-Claudian line, has been handed down to posterity as the incarnation of monstrous vice and fantastic luxury. But his wild excesses scarcely affected the prosperity of the empire at large; the provinces were well governed, and the war with Parthia led to a compromise in the matter of Armenia which secured peace for half a century.⁹

⁵ Suet. *Aug.* 18, 47.

⁶ Jung, *Die romanischen Landschaften* (Innsbruck, 1881); Budinsky, *Die Ausbreitung d. lateinischen Sprache* (Berlin, 1881).

⁷ The *praefectus urbi*, unlike the other imperial prefects, was always a senator. He commanded the three *cohortes urbanae*, which preserved order in the city, and possessed a power of jurisdiction which tended to increase in importance. The office, which was only temporary under Augustus, became a permanent one under his successor.

⁸ Besides the *cohortes urbanae* mentioned above, the nine regiments of the imperial guard (*cohortes praetorianae*) were quartered in Rome. The guards were not at first concentrated but billeted in Rome and the neighbouring towns; the praetorian barracks on the Esquiline were built under Tiberius (Tac. *Ann.* iv. 2). Augustus also formed the quasi-military police force of the *vigiles* (in seven cohorts), which performed the duties of a fire brigade and night watch. Police duties in those parts of Italy which were subject to brigandage were performed by *stationes militum* (Suet. *Aug.* 32).

⁹ For an estimate of the Julio-Claudian Caesars, based on the results of recent research, see Pelham in *Quarterly Review* (April

*Liberal
towards
the
pro-
vinces.*

*Italy and
the
pro-
vinces
under the
empire.*

The fall of Nero and the extinction of the "progeny of the Caesars" was followed by a war of succession which revealed the military basis of the Principate and the weakness of the tie connecting the emperor with Rome. Galba, Otho, Vitellius and Vespasian represented in turn the legions of Spain, the household troops, the army of the Rhine, and a coalition of the armies of the Danube and the Euphrates; and all except Otho were already *de facto* emperors when they entered Rome. The final survivor in the struggle, Vespasian (A.D. 69-79), was a man of comparatively humble origin, and as the Principate ceased to possess the prestige of high descent it became imperatively necessary to remove, as far as possible, the anomalies of the office and to give it a legitimate and permanent form. Thus we find an elaborate and formal system of titles substituted for the personal names of the emperors.

The Flavian and Antonine emperors.

Julio-Claudian emperors, an increasing tendency to insist on the inherent prerogatives of the Principate (such as the censorial power), and an attempt to invest Caesarism with an hereditary character, either by natural descent or by adoption, while the worship of the *Divi*, or deified Caesars, was made the symbol of its continuity and legitimacy. The dynasty of Vespasian and his sons (Titus, A. D. 79-81, Domitian, A. D. 81-96) became extinct on the murder of the last named, whose high-handed treatment of the senate earned him the name of a tyrant; his successor, Nerva (A. D. 96-98), opened the series of "adoptive" emperors (Trajan, A. D. 98-117, Hadrian, 117-38, Antoninus Pius, 138-61, Marcus Aurelius, 161-80) under whose rule the empire enjoyed a period of internal tranquility and good government. Its boundaries were extended by the subjugation of northern Britain (by Agricola, A. D. 78-84; see BRITAIN, § Roman), by the annexation of the districts included in the angle of the Rhine and Danube under the Flavian emperors, and by the conquest of Dacia (the modern Transylvania) under Trajan (completed in A. D. 106). Trajan also annexed Arabia Petraea and in his closing years invaded Parthia and formed provinces of Armenia, Mesopotamia and Assyria; but these conquests were surrendered by his successor, Hadrian, who set himself to the task of consolidating the empire and perfecting its defences. To him is due the system of permanent *limites* or frontier fortifications, such as the wall which protected northern Britain and the palisade which replaced the chain of forts established by the Flavian emperors from the Rhine to the Danube.¹ The construction of these defences showed that the limit of expansion had been reached, and under M. Aurelius the tide began to turn. A great part of his reign was occupied with wars against the Marcomanni, Quadi, Sarmatians, &c., whose irruptions seriously threatened the security of Italy. Henceforth Rome never ceased to be on the defensive.

Condition of the provinces.

Within the frontiers the levelling and unifying process commenced by Augustus had steadily proceeded. A tolerably uniform provincial system covered the whole area of the empire. The client states had one by one been reconstituted as provinces, and even the government of Italy had been in many respects assimilated to the provincial type. The municipal system had spread widely; the period from Vespasian to Aurelius witnessed the elevation to municipal rank of an immense number of communities, not only in the old provinces of the West, in Africa, Spain and Gaul, but in the newer provinces of the North, and along the line of the northern frontier; and everywhere under the influence of the central imperial authority there was an increasing uniformity (1905). It is now generally admitted that Tacitus's picture is overdrawn.

¹ On the *limes imperii*, see Pelham, "A Problem of Roman Frontier Policy" (*Transactions of the Royal Historical Society*, 1906), and Kornemann, "Die neueste Limesforschung" (*Klio*, 1907, pp. 73 ff.). The *limes* connecting the Rhine with the Danube has been systematically excavated in recent years; for the results see *Der obergermanisch-rätische Limes* (Heidelberg, 1894-), and *Der römische Limes in Österreich* (Vienna, 1900-).

in the form of the local constitutions, framed and granted as they all were by imperial edict.² Throughout the empire again the extension of the Roman franchise was preparing the way for the final act by which Caracalla assimilated the legal status of all free-born inhabitants of the empire,³ and in the west and north this was preceded and accompanied by the complete Romanizing of the people in language and civilization. Yet, in spite of the internal tranquillity and the good government which have made the age of the Antonines famous, we can detect signs of weakness. It was in this period that the centralization of authority in the hands of the *principes* was completed; the "dual control" established by Augustus, which had been unreal enough in the 1st century, was now, though not formally abolished, systematically ignored in practice. The senate ceased to be an instrument of government, and became an imperial peage, largely composed of men not qualified by election to the quaestorship but directly ennobled by the emperor.⁴ The restricted sphere of administration left by Augustus to the old magistracies was still further narrowed; their jurisdiction, for example, tended to pass into the hands of the Greek officers appointed by Caesar—the prefect of the city and the prefect of the guards. The complete organization of Caesar's own administrative service, and its recognition as a state bureaucracy, was chiefly the work of Hadrian, who took the secretariats out of the hands of freedmen and entrusted them to procurators of equestrian rank.⁵ All these changes, inevitable, and in some degree beneficial, as they were, brought with them the attendant evils of excessive centralization. Though these were hardly felt while the central authority was wielded by vigorous rulers, yet even under Trajan, Hadrian and the Antonines we notice a failure of strength in the empire as a whole, and a corresponding increase of pressure on the imperial government itself. The reforms of Augustus had given free play to powers still fresh and vigorous. The ceaseless labours of Hadrian were directed mainly to the careful husbanding of such strength as still remained, or to attempts at reviving it by the sheer force of imperial authority. Among the symptoms of incipient decline were the growing depopulation, especially of the central districts of the empire, the constant financial difficulties, the deterioration in character of the local governments in the provincial communities,⁶ and the increasing reluctance exhibited by all classes to undertake the now onerous burden of municipal office.

It is to such facts as these that we must look in passing a final judgment on the imperial government, which is admittedly seen in its best and most perfect form in the Antonine period. In our review of the conditions which brought about the fall of the Roman Republic, we saw that the collapse of the city-state made Caesarism inevitable, since the extension of federal and representative institutions to the world-empire lay beyond the horizon of ancient thought. The benefits which Caesarism conferred upon mankind are plain. In the first place, the Roman world, which had hitherto not been governed in the true sense of the word, but exploited in the interests of a dominant clique, now received an orderly and efficient government, under which the frightful ravages of misrule and civil strife were repaired. The financial resources of the empire were husbanded by skilled and, above all, trained administrators, to whom the imperial service offered a *carrière ouverte aux talents*; many of these were Greeks, or half-Greek Orientals, whose business capacity formed an invaluable asset hitherto

² Marquardt, i. 132 ff.; cf. especially the *leges Sulpensianae et Malacitanæ*; Bruns, *Fontes Juris Romani* (ed. 6, p. 142).

³ Dio lxxvii. 9 (A. D. 212).

⁴ For the use of *adlectio* see Mommsen, *Staatsr.* ii. 877.

⁵ *Vit. Hadr.* 21. Besides Hirschfeld's *Verwaltungsbeamten* reference may be made to Liebenan, *Die Laufbahn der Procuratoren* (Jena, 1886), and Schurz, *De multationibus in imperio Romano ordinando ab imperatore Hadriano factis* (Bonn, 1883).

⁶ This led to the appointment of the *curatores* and *correctores* in the 2nd century. The younger Pliny was one of these imperial commissioners, and his correspondence with Trajan throws much light on the condition of the provinces.

neglected. Augustus caused an official survey of the empire to be made, and a scientific census of its resources was gradually carried out and from time to time revised; thus the balance of revenue and expenditure could be accurately estimated and adjusted, and financial stability was established. The system of tax-farming was gradually abolished and direct collection substituted; commerce was freed from vexatious restrictions, and large customs-districts were formed, on whose borders duties were levied for revenue only. The government took even more direct measures for the encouragement of industry and especially of agriculture. The most remarkable of these were the "alimentary" institutions, originally due to Nerva and developed by succeeding emperors. Capital was advanced at moderate rates of interest to Italian landowners on the security of their estates, and the profits of this system of land-banks were devoted to the maintenance and education of poor children. The foundation of colonies for time-expired soldiers, who received grants of land on their discharge, contributed something to the formation of a well-to-do agricultural class; and although the system was not successful in lower Italy, where economic decline could not be arrested, there can be no doubt that central and northern Italy, where the vine and olive were largely cultivated, and manufacturing industries sprang up, enjoyed a considerable measure of prosperity. The extension of the Roman municipal system to the provinces, and the watchful care exercised by the imperial government over the communities, together with the profuse liberality of the emperors, which was imitated by the wealthier citizens of the towns, led to the creation of a flourishing municipal life still evidenced by the remains which in districts such as Asia Minor or Tunis stand in significant contrast with the desolation brought about by centuries of barbaric rule. Mommsen¹ has, indeed, expressed the opinion that "if an angel of the Lord were to strike the balance whether the domain ruled by Severus Antoninus were governed with the greater intelligence and the greater humanity at that time or in the present day, whether civilization and national prosperity generally had since that time advanced or retrograded, it is very doubtful whether the decision would prove in favour of the present."

But there is another side to the picture. The empire brought into being a new society and a new nationality, due to the fusion of Roman ideas with Hellenic culture, beside which other elements, saving only, as we shall see, those contributed by the Oriental religions, were insignificant. This new nationality grew in definition through the gradual disappearance of distinctions of language and manners, the assimilating influence of commercial and social intercourse, and the extinction of national jealousies and aspirations. But the cosmopolitan society thus formed was compacted of so many disparate elements that a common patriotism was hard to foster, and doubly hard when the autocratic system of government prevented men from aspiring to that true political distinction which is attainable only in a self-governing community. It is true that there was much good work to be done, and that much good work was done, in the service of the emperors; true, also, that the *carrière ouverte aux talents* was in large measure realized. Distinctions of race were slowly but steadily effaced by the grant of citizen rights to provincials and by the manumission of slaves; and the career open to the Romanized provincial or the liberated slave might culminate in the highest distinctions which the emperor could bestow. In the hierarchy of social orders—senate, *equites* and *plebs*—ascent was easy and regular from the lower grade to the higher; and the more enlightened of the emperors—especially Hadrian—made a genuine endeavour to give a due share in the work of government to the various subject races. But nothing could compensate for the lack of self-determination, and although during the first century and a half of imperial rule a flourishing local patriotism in some degree filled the place of the wider sentiment, this gradually sank into decay and became a pretext under cover of which the lower classes in the several communities

¹ *Provinces*, i. p. 5.

took toll of their wealthier fellow-citizens in the shape of public works, largesses, amusements, &c., until the resources at the disposal of the rich ran dry, the communities themselves in many cases became insolvent, and the inexorable claims of the central government were satisfied only by the surrender of financial control to an imperial commissioner. Then the organs of civic life became atrophied, political interest died out, and the whole burden of administration, as well as that of defence, fell upon the shoulders of the bureaucracy, which proved unequal to the task.

In a world thus governed the individual was thrown more and more upon his own resources—the pursuit of wealth² and pleasure, or the satisfaction of intellectual interests. Under the rule of the Caesars much was done for education. Julius Caesar bestowed Roman citizenship on "teachers of the liberal arts"; Vespasian endowed professorships of Greek and Latin oratory at Rome;³ and later emperors, especially Antoninus Pius, extended the same benefits to the provinces. Local enterprise and munificence were also devoted to the cause of education; we learn from the correspondence of the younger Pliny that public schools were founded in the towns of northern Italy. But though there was a wide diffusion of knowledge under the empire, there was no true intellectual progress. Augustus, it is true, gathered about him the most brilliant writers of his time, and the debut of the new monarchy coincided with the Golden Age of Roman literature; but this was of brief duration, and the beginning of the Christian era saw the triumph of classicism and the first steps in the decline which awaits all literary movements which look to the past rather than the future. Political oratory could not exist under an absolute ruler; public life furnished no inspiring theme to poet or historian; and literature became didactic or imitative, while rhetoric degenerated into declamation. It is true that for some time both literature and philosophy maintained an alliance with the old republican aristocracy and voiced the undercurrent of opposition to the empire; but both had ceased to be irreconcilable before the time of Hadrian. Under his rule classicism gave way to the archaism of which Fronto and Apuleius furnish the most notable examples, and which preferred Cato and Ennius to Cicero and Virgil. But this return to the past was not followed by any renewed creative energy. It was a confession of weakness and little more; and the widely diffused culture of the Antonine period, though outwardly brilliant, had no progressive energy and presented but a feeble resistance to the dissolving forces of barbarism.

To strike the balance of loss and gain in the field of morals is an exceedingly difficult task. The denunciations of the satirists, especially of Juvenal, might lead us to believe that an appalling state of depravity existed in the society of the early empire; but satirists notoriously paint in glaring colours for literary effect, and whatever may be said of the morality of Rome—which was probably no better and no worse than that of any cosmopolitan capital—there were sound and healthy elements in plenty amongst the population of Italy and the provinces. Doubtless the craving for amusement—especially for the shows of the amphitheatre and the chariot-races of the circus—infected the idle masses of the populace in Rome and the larger towns, and was fostered by the policy of despotism, which always aims at securing cheap popularity with the proletariat; but the tendency of the time, not only in the higher ranks, but also amongst humbler folk, was towards a broader humanity and a more serious view of life and its problems. Greek philosophy, especially the Stoic system, in order to appeal to the practical Roman intelligence, found itself obliged to elaborate a rule of conduct, and in many

² Immense fortunes were accumulated under the early empire, especially by imperial freedmen, such as Pallas, who is said to have possessed the equivalent of £3,000,000 sterling; and there were instances of extravagant luxury, which was encouraged by Nero. But we are told that there was a return to simpler habits of life under the Flavian dynasty.

³ Quintilian occupied the chair of Latin rhetoric, and received the *ornamenta consularia*.

households the philosopher, generally a Greek, played the part of a director of consciences. The influence of these doctrines is shown in the humane provisions of the civil law as elaborated in the Antonine period, which did much to mitigate the lot of the slave and to smooth the process by which freedom might be attained.¹ Above all, a religious movement which drew its motive power not from Greek philosophy, but from Oriental mysticism, carried the human race far from its old moorings, and culminated in the triumph of Christianity. All the Eastern cults—whether of Cybele, of Isis, of the Syrian Baalim or of the Persian Mithras—had this in common, that they promised to their adherents redemption from the curse of the flesh and a glorious immortality after death; and this fact gave them an irresistible attraction for the disillusioned and overburdened subjects of the emperors. The religion of Mithras, whose doctrines were specially suited to the military temperament, made its way wherever the armies of the empire were stationed, and seemed likely at one moment to become universal; but it was forced to yield to Christianity, which refused to tolerate any rival, faced the empire with a claim to absolute dominion in the spiritual sphere, and at length made that claim good (see ROMAN RELIGION; MITHRAS; GREAT MOTHER OF THE GODS).

Marcus Aurelius died in 180, and the reign of his worthless son, Commodus (A.D. 180-93), was followed by a century of war and disorder, during which nothing but the stern rule of soldier emperors saved the empire from dissolution. The first and ablest of these was Septimius Severus (193-211), whose claims were disputed by Clodius Albinus in the West, and by Pescennius Niger in the East; in these struggles rival Roman forces, for the first time since the accession of Vespasian, exhausted each other in civil war.² Severus emphasized strongly the military character of the Principate; he abstained from seeking confirmation for his authority from the senate, and deprived that body of most of the share in the government which it still retained; he assumed the title of proconsul in Rome itself, made the prefect of the guard the vicegerent of his authority, and heaped privileges upon the army, which, although they secured its entire devotion to his family, impaired its efficiency as a fighting force and thus weakened Rome in face of the barbarian invader.³ He succeeded in founding a short-lived dynasty, which ended with the attempt of the virtuous but weak Alexander (222-35) to restore the independence of the senate. This led to a military reaction, and the elevation of the brutal Maximinus, a Thracian peasant, to the throne. The disintegration of the empire was the natural result; for the various provincial armies put forward their commanders as claimants to the purple. A hundred ties bound them closely to the districts in which they were stationed; their permanent camps had grown into towns, they had families and farms; the unarmed provincials looked to them as their natural protectors, and were attached to them by bonds of intermarriage and by long intercourse. Now that they found themselves left to repel by their own efforts the invaders from without, they reasonably enough claimed the right to ignore the central authority which was powerless to aid them, and to choose for themselves *imperatores* whom they knew and trusted. These "tyrants," as they were called when unsuccessful, sprang up in ever-increasing numbers, and weakened Rome's power of resistance to the new enemies who were threatening her frontiers—the Alamanni and Franks, who broke through the German *limes* in 236; the Goths, who crossed the Danube in 247, raided the Balkan provinces, and defeated and slew the emperor, Decius, in 251, and the restored Persian kingdom of

the Sassanidae (see PERSIA), whose rulers laid claim to all the Asiatic possessions of Rome and in 260 captured Antioch and made the emperor, Valerian, a prisoner. During the reign of Gallienus, the son of Valerian (260-68), the evil reached its height. The central authority was paralysed; the Romanized districts beyond the Rhine were irrevocably lost; the Persians were threatening to overrun the Eastern provinces; the Goths had formed a fleet of 500 sail which harried Asia Minor and even Greece itself, where Athens, Corinth, Sparta and Argos were sacked; and the legions on the frontiers were left to repel the enemies of Rome as best they could. A provincial empire was established by M. Cassianus Latinus Postumus in Gaul and maintained by his successors, M. Plavianus Victorinus and C. Pius Esuvius Tetricus.⁴ Their authority was acknowledged, not only in Gaul and by the troops on the Rhine, but by the legions of Britain and Spain; and under Postumus at any rate (259-69) the existence of the Gallic Empire was justified by the repulse of the barbarians and by the restoration of peace and security to the provinces of Gaul. On the Danube, in Greece and in Asia Minor none of the "pretenders" enjoyed more than a passing success. In the Far East, the Syrian Odaenathus, prince of Palmyra⁵ (q.v.), though officially only the governor of the East (*dux Orientis*) under Gallienus, drove the Persians out of Asia Minor and Syria, recovered Mesopotamia, and ruled Syria, Arabia, Armenia, Cappadocia and Cilicia with all the independence of a sovereign. Odaenathus was murdered in 266. His young son Vaballathus (Wahab-allath) succeeded him in his titles, but the real power was vested in his widow Zenobia, under whom not only the greater part of Asia Minor but even the province of Egypt was forcibly added to the dominions governed by the Palmyrene prince, who ceased to acknowledge the supremacy of Rome.

Gallienus was murdered at Milan in 268, and after the brief reign of Claudius II. (A.D. 268-70), who checked the advance of the Goths, Aurelian (270-75) restored unity to the distracted empire. Palmyra was destroyed and Zenobia led a prisoner to Rome (in 273) and in the next year the Gallic empire came to an end by the surrender of Tetricus. Aurelian, it is true, abandoned the province of Dacia, but the defences of the Danube were strengthened, and in 276 Probus repulsed the Franks and Alamanni, who had been pressing on the Rhine frontier for some forty years. Finally, Carus (282) recovered Armenia and Mesopotamia from the Persians and restored the frontier fixed by Septimius Severus.

Although any serious loss of territory had been avoided, the storms of the 3rd century had told with fatal effect upon the general condition of the empire. The "Roman peace" had vanished; not only the frontier territories, but the central districts of Greece, Asia Minor, and even Italy itself, had suffered from the ravages of war, and the fortification of Rome by Aurelian was a significant testimony to the altered condition of affairs. War, plague and famine had thinned the population and crippled the resources of the provinces. On all sides land was running waste, cities and towns were decaying, and commerce was paralysed. Only with the greatest difficulty were sufficient funds squeezed from the exhausted taxpayers to meet the increasing cost of the defence of the frontiers. The old established culture and civilization of the Mediterranean world rapidly declined, and the mixture of barbaric rudeness with Oriental pomp and luxury which marked the court, even of the better emperors, such as Aurelian, was typical of the general deterioration, which was accelerated by the growing practice of settling barbarians on lands within the empire, and of admitting them freely to service in the Roman army.

¹ The massacre of the slaves of Pedanius Secundus, who had been murdered by some person unknown (*Tac. Ann.* xiv. 42), was, it is true, decreed by the senate; but it was a highly unpopular act, and is chiefly significant as showing that the senatorial aristocracy was out of harmony with the spirit of the time.

² Gibbon (ed. Bury), i. chap. v.; Schiller, *Gesch. d. Kaiserzeit*, i. (2) 660.

³ The common soldier was now permitted to marry, and ceased to live in camp (*Herodian* iii. 8. 5).

⁴ Gibbon, i. chap. x.; Mommsen, *Provinces*, i. 164; Schiller, i. (2) 827.

⁵ Gibbon, i. chap. x.; Mommsen, *Provinces*, ii. 103; cf. PALMYRA.

The
empire
from
180-284.

Reign of
Gallienus,
260-268.

Odaena-
thus and
Zenobia
at
Palmyra.

Restora-
tion of
unity by
Aurelian,
273.

State
of the
empire at
the close
of the 3rd
century.

PERIOD II.: THE DOMINATE, A.D. 284-476.—(a) *From the Accession of Diocletian to the Death of Theodosius* (A.D. 284-395).

The work of fortifying the empire alike against internal sedition and foreign invasion, begun by Aurelian and Probus, was completed by Diocletian and Constantine the Great, whose system of government, novel as it appears at first sight, was in reality the natural and inevitable outcome of the history of the previous century.¹ Its object was twofold, to give increased stability to the imperial authority itself, and to organize an efficient administrative machinery throughout the empire. In the second year of his reign Diocletian associated Maximian with himself as colleague, and six years later (293) the hands of the two "Augusti" were further strengthened by the proclamation of Constantius and Galerius as "Caesars." Precedents for such an arrangement were to be found in the earlier history of the Principate²; and it divided the burdens and responsibilities of government, without sacrificing the unity of the empire; for, although to each of the Augusti and Caesars a separate sphere was assigned, the Caesars were subordinate to the higher authority of the Augusti, and over all his three colleagues Diocletian claimed to exercise a paramount control. It also reduced the risk of a disputed succession by establishing in the two Caesars the natural successors to the Augusti, and it satisfied the jealous pride of the rival armies by giving them *imperatores* of their own. The distribution of power between Diocletian and his colleagues followed those lines of division which the feuds of the previous century had marked out. The armies of the Rhine, the Danube and of Syria fell to the lot respectively of Constantius, Galerius and Diocletian, the central districts of Italy and Africa to Maximian.³

In the new system the imperial authority was finally emancipated from all constitutional limitation and control and the last traces of its republican origin disappeared. The emperors from Diocletian onwards were autocrats in theory as well as in practice. This avowed despotism Diocletian, following in the steps of Aurelian, hedged round with all the pomp and majesty of Oriental monarchy. The final adoption of the title *dominus*, the diadem on the head, the robes of silk and gold, the replacement of the republican salutation of a fellow-citizen by the adoring prostration even of the highest in rank before their lord and master, were all significant marks of the new regime.⁴ In

the hands of this absolute ruler was placed the entire control of an elaborate administrative machinery. Most of the old local and national distinctions, privileges and liberties which had once flourished within the empire had already disappeared under the levelling influence of imperial rule, and the process was now completed.

Roman citizenship had, since the edict of Caracalla, ceased to be the privilege of a minority. Diocletian finally reduced Italy and Rome to the level of the provinces: the provincial land-tax and provincial government were introduced into Italy,⁵ while Rome ceased to

be even in name the seat of imperial authority.⁶ Throughout the whole area of the empire a uniform system of administration was established, the control of which was centred in the imperial palace.⁷ Between the civil and military departments the separation was complete. At the head of the former were the praetorian prefects,⁸ next below them the *vicarii*, who had charge of the *dioceses*; below these again the governors of the separate provinces (*praesides, correctores, consulares*),⁹ under each of whom was a host of minor officials. Parallel with this civil hierarchy was the series of military officers, from the *magistri militum*, the *duces*, and *comites* downwards.¹⁰ In both there is the utmost possible subordination and division of authority. The subdivision of provinces, begun by the emperors of the 2nd century, was systematically carried out by Diocletian, and each official, civil or military, was placed directly under the orders of a superior; thus a continuous chain of authority connected the emperor with the meanest official in his service. Finally, the various grades in these two imperial services were carefully marked by the appropriation to each of distinctive titles, the highest being that of *illustris*, which was confined to the prefects and to the military *magistri* and *comites*, and to the chief ministers.¹¹

There can be little doubt that on the whole these reforms prolonged the existence of the empire, by creating a machinery which enabled the stronger emperors to utilize effectively all its available resources, and which even to some extent made good the deficiencies of weaker rulers. But in many points they failed to attain their object. Diocletian's division of the imperial authority among colleagues, subject to the general control of the senior Augustus, was effectively discredited by the twenty years of almost constant conflict which followed his own abdication (305-23). Constantine's partition of the empire among his three sons was not more successful in ensuring tranquility, and in the final division of the East and West between Valens and Valentinian (364) the essential principle of Diocletian's scheme, the maintenance of a single central authority, was abandoned. The "tyrants," the curse of the 3rd century, were far from unknown in the 4th. The system, moreover, while it failed altogether to remove some of the existing evils, aggravated others. The already overburdened financial resources of the empire were strained still further by the increased expenditure necessitated by the substitution of four imperial courts for one, and by the multiplication in every direction of paid officials. The gigantic bureaucracy of the 4th century proved, in spite of its undoubted services, an intolerable weight upon the energies of the empire.

Diocletian and Maximian formally abdicated their high office in 305. Nineteen years later Constantine I., the Great, the sole survivor of six rival emperors, united the whole empire under his own rule. His reign of fourteen years was marked by two events of first-rate importance,—the recognition of Christianity as the religion of the

Altered character of the imperial authority.

Levelling policy of Diocletian.

Degradation of Italy and Rome.

The new administrative system.

Effects of these reforms.

Constantine the Great.

¹ See Gibbon (ed. Bury), ii. chap. xvii. 158 ff.; Marquardt, *Staatsverw.* i. pp. 81, 336, 337, ii. 217 seq.; Madvig, *Verf. d. Rom. Reichs*, i. 585; Böcking, *Notitia dignitatum* (Bonn, 1853); Hodgkin, *Italy and her Invaders* (ed. 2), bk. i. chap. xiii.; Preuss, *Diocletian* (Leipzig, 1869); Seeck, *Untergang der antiken Welt*, vols. i., ii. (1897-1902).

² Mommsen, *Staatsrecht*, ii. 1168 seq. Verus was associated with Marcus Aurelius as Augustus; Severus gave the title to his two sons. The bestowal of the title "Caesar" on the destined successor dates from Hadrian. Mommsen, *op. cit.* 1139.

³ The division was as follows:—(1) Diocletian—Thrace, Egypt, Syria, Asia Minor; (2) Maximian—Italy and Africa; (3) Galerius—Illyricum and the Danube; (4) Constantius—Britain, Gaul, Spain. See Gibbon, i. 354; Aurelius Victor, c. 39.

⁴ Aurel. Victor, 39; Eutrop. ix. 26.

⁵ Marquardt, *Staatsverw.* i. 233 ff. Italy, together with Sicily, Sardinia and Corsica, was divided into 17 provinciae. Each had its own governor; the governors were subject to the two *vicarii* (*vic. urbis, vic. Italiae*), and they in turn to the prefect of Italy, whose prefecture, however, included as well Africa and Western Illyricum.

⁶ The seats of government for Diocletian and his three colleagues were Mediolanum, Augusta Treverorum, Sirmium, Nicomedia.

⁷ For these last, see Gibbon, ii. chap. xvii. p. 188; cf. also *Notitia Dignitatum* and Böcking's notes.

⁸ At first the number of these varied, there was no fixed division of provinces between them; but by the close of the 4th century there were four prefectures, viz. Oriens, Illyricum, Italia, Gallia, to which must be added the prefectures of Rome and Constantinople. See Mommsen in *Hermes*, xxxvi. 204 ff.

⁹ There were 12 dioceses and 101 provinces; cf., in addition to the authorities mentioned above, Bethmann-Hollweg, *Civil-Prozess*, iii.; Kuhn, *Die städtische und bürgerliche Verfassung des römischen Reichs* (1877).

¹⁰ The army was completely remodelled, and the old frontier garrisons (now called *Limitanei*) were supplemented by a field force attached to the persons of the Augusti and Caesars, and hence called *Comitatenses*. The change was accompanied by the subdivision of the old legions into units of about 2000 men. For these reforms see Seeck, *Untergang der antiken Welt*, bk. iii. chap. v.; Mommsen in *Hermes*, xxiv. 225 ff.

¹¹ The grades were as follows: *illustris, spectabilis, clarissimus, perfectissimus, egregii*. For the other insignia, see Madvig, ii. 590, and the *Notitia Dignitatum*.

empire, and the building of the new capital at Byzantium. The alliance which Constantine inaugurated between the Christian church and the imperial government, while it enlisted on the side of the state one of the most powerful of the new forces with which it had to reckon, imposed a check, which was in time to become a powerful one, on the imperial authority. The establishment of the new "City of Constantine" as a second Rome paved the way for the final separation of East and West by providing the former for the first time with a suitable seat of government on the Bosphorus. The death of Constantine in 337 was followed, as the abdication of Diocletian had been, by the outbreak of quarrels among rival Caesars. Of the three sons of Constantine who in 337 divided the empire between them, Constantine the eldest fell in civil war against his brother Constans; Constans himself was, ten years afterwards, defeated and slain by Magnentius; and the latter in his turn was in 353 vanquished by Constantine's only surviving son Constantius.

Thus for the second time the whole empire was united under the rule of a member of the house of Constantine. But in 355 Constantius granted the title of Caesar to his cousin Julian and placed him in charge of Gaul, where the momentary elevation of a tyrant, Silvanus, and still more the inroads of Franks and Alamanni, had excited alarm. But Julian's successes during the next five years were such as to arouse the jealous fears of Constantius. In order to weaken his suspected rival the legions under Julian in Gaul were suddenly ordered to march eastward against the Persians (360). They refused; and when the order was repeated, replied by proclaiming Julian himself emperor and Augustus. Julian, with probably sincere reluctance, accepted the position, but the death of Constantius in 361 saved the empire from the threatened civil war. Julian's attempted restoration of pagan and in especial of Hellenic worship had no more permanent effect than the war which he courageously waged against the multitudinous abuses which had grown up in the luxurious court of Constantius.¹ But his vigorous administration in Gaul undoubtedly checked the barbarian advance between the Rhine, and postponed the loss of the Western provinces; on the contrary, his campaign in Persia, brilliantly successful at first, ended in his own death (363), and his successor, Jovian, immediately surrendered the territories beyond the Tigris won by Diocletian seventy years before. Jovian died on the 17th of February 364; and on the 26th of February Valentinian was acknowledged as emperor of the army at Nicæa. In obedience to the wish of the soldiers that he should associate a colleague with himself, he conferred the title of Augustus upon his brother Valens, and the division of the empire was at last effected.—Valentinian became emperor of the West, Valens of the East. Valentinian maintained the integrity of the empire until his death (in 375), which deprived the weaker Valens of a trusted counsellor and ally, and was followed by a serious crisis on the Danube. In 376 the Goths, hard pressed by their new foes from the eastward, the Huns, sought and obtained the protection of the Roman Empire. They were transported across the Danube and settled in Moesia, but, indignant at the treatment they received, they rose in arms against their protectors. In 378 at Adrianople Valens was defeated and killed, and the victorious Goths advanced eastward to the very walls of Constantinople. Once more, however, the danger passed away. The skill and tact of Theodosius, who had been proclaimed emperor of the East by Gratian,² conciliated the Goths; they were granted an allowance, and in large numbers entered the service of the Roman emperor. The remaining

years of Theodosius's reign (382-95) were mainly engrossed by the duty of upholding the increasingly feeble authority of his western colleague against the attacks of pretenders. Maximus, the murderer of Gratian (383), was at first recognized by Theodosius as Caesar, and left in undisturbed command of Gaul, Spain and Britain; but, when in 386 he proceeded to oust Valentinian II. from Italy and Africa, Theodosius marched westward, crushed him, and installed Valentinian as emperor of the West. In the very next year, however, the murder of Valentinian (392) by Arbogast, a Frank, was followed by the appearance of a fresh tyrant in the person of Eugenius, a domestic officer and nominee of Arbogast himself. Once more Theodosius marched westward, and near Aquileia decisively defeated his opponents. But his victory was quickly followed by his own illness and death (395), and the fortunes of East and West passed into the care of his two sons Arcadius and Honorius.

(b) *From the Death of Theodosius to the Extinction of the Western Empire (395-476).*—Through more than a century from the accession of Diocletian the Roman Empire had succeeded in holding at bay the swarming hordes of barbarians. But, though no province had yet been lost, as Dacia had been lost in the century before, and though the frontier lines of the Rhine and the Danube were still guarded by Roman forts and troops, there were signs in plenty that a catastrophe was at hand.

From all the writers who deal with the 4th century we have one long series of laments over the depression and misery of the provinces.³ To meet the increased expenditure necessary to maintain the legions, to pay the hosts of officials, and to keep up the luxurious splendour of the imperial courts, not only were the taxes raised in amount, but the most oppressive and inquisitorial methods were adopted in order to secure for the imperial treasury every penny that could be wrung from the wretched taxpayer. The results are seen in such pictures as that which the panegyrist Eumenius⁴ draws of the state of Gaul (306-12) under Constantine, in the accounts of the same province under Julian fifty years later, in those given by Zosimus early in the 5th century, and in the stringent regulations of the Theodosian code, dealing with the assessment and collection of the taxes. Among the graver symptoms of economic ruin were the decrease of population, which seriously diminished not only the number of taxpayers, but the supply of soldiers for the legions;⁵ the spread of infanticide; the increase of waste lands whose owners and cultivators had fled to escape the tax collector; the declining prosperity of the towns; and the constantly recurring riots and insurrections, both among starving peasants, as in Gaul,⁶ and in populous cities like Antioch.⁷ The distress was aggravated by the civil wars, by the rapacity of tyrants, such as Maxentius and Maximus, but above all by the raids of the barbarians, who seized every opportunity afforded by the dissensions or incapacity of the emperors to cross the frontiers and harry the lands of the provincials. Constantine (306-12), Julian (356-60) and Valentinian I. (364-75) had each to give a temporary breathing-space to Gaul by repelling the Franks and Alamanni. Britain was harassed by Picts and Scots from the north (367-70), while the Saxon pirates swept the northern seas and the coasts both of Britain and Gaul. On the Danube the Quadi, Sarmatae, and above all the Goths, poured at intervals into the provinces of Pannonia and Moesia, and penetrated to Macedonia and Thrace. In the East, in addition to the constant border feud with Persia, we hear of ravages by the Isaurian mountaineers, and by a new enemy, the Saracens.⁸

¹ F. Dill, *Roman Society in the Last Century of the Western Empire* (2nd ed., 1899).

² Eumenius, *Paneg. Vet. vii.*

³ Gibbon ii. 179.

⁴ For the Bagaudae, see Jung, *Die romanischen Landschaften*, p. 264, where the authorities are given.

⁵ In 387; Hodgkin i. 483.

⁸ *Amm. Marc. xiv. 4.*

Constantinople.

Thus for the second time the whole empire was united under the rule of a member of the house of Constantine. But in 355 Constantius granted the title of Caesar to his cousin Julian and placed him in charge of Gaul, where the momentary elevation of a tyrant, Silvanus, and still more the inroads of Franks and Alamanni, had excited alarm. But Julian's successes during the next five years were such as to arouse the jealous fears of Constantius. In order to weaken his suspected rival the legions under Julian in Gaul were suddenly ordered to march eastward against the Persians (360). They refused; and when the order was repeated, replied by proclaiming Julian himself emperor and Augustus. Julian, with probably sincere reluctance, accepted the position, but the death of Constantius in 361 saved the empire from the threatened civil war. Julian's attempted restoration of pagan and in especial of Hellenic worship had no more permanent effect than the war which he courageously waged against the multitudinous abuses which had grown up in the luxurious court of Constantius.¹ But his vigorous administration in Gaul undoubtedly checked the barbarian advance between the Rhine, and postponed the loss of the Western provinces; on the contrary, his campaign in Persia, brilliantly successful at first, ended in his own death (363), and his successor, Jovian, immediately surrendered the territories beyond the Tigris won by Diocletian seventy years before. Jovian died on the 17th of February 364; and on the 26th of February Valentinian was acknowledged as emperor of the army at Nicæa. In obedience to the wish of the soldiers that he should associate a colleague with himself, he conferred the title of Augustus upon his brother Valens, and the division of the empire was at last effected.—Valentinian became emperor of the West, Valens of the East. Valentinian maintained the integrity of the empire until his death (in 375), which deprived the weaker Valens of a trusted counsellor and ally, and was followed by a serious crisis on the Danube. In 376 the Goths, hard pressed by their new foes from the eastward, the Huns, sought and obtained the protection of the Roman Empire. They were transported across the Danube and settled in Moesia, but, indignant at the treatment they received, they rose in arms against their protectors. In 378 at Adrianople Valens was defeated and killed, and the victorious Goths advanced eastward to the very walls of Constantinople. Once more, however, the danger passed away. The skill and tact of Theodosius, who had been proclaimed emperor of the East by Gratian,² conciliated the Goths; they were granted an allowance, and in large numbers entered the service of the Roman emperor. The remaining

years of Theodosius's reign (382-95) were mainly engrossed by the duty of upholding the increasingly feeble authority of his western colleague against the attacks of pretenders. Maximus, the murderer of Gratian (383), was at first recognized by Theodosius as Caesar, and left in undisturbed command of Gaul, Spain and Britain; but, when in 386 he proceeded to oust Valentinian II. from Italy and Africa, Theodosius marched westward, crushed him, and installed Valentinian as emperor of the West. In the very next year, however, the murder of Valentinian (392) by Arbogast, a Frank, was followed by the appearance of a fresh tyrant in the person of Eugenius, a domestic officer and nominee of Arbogast himself. Once more Theodosius marched westward, and near Aquileia decisively defeated his opponents. But his victory was quickly followed by his own illness and death (395), and the fortunes of East and West passed into the care of his two sons Arcadius and Honorius.

(b) *From the Death of Theodosius to the Extinction of the Western Empire (395-476).*—Through more than a century from the accession of Diocletian the Roman Empire had succeeded in holding at bay the swarming hordes of barbarians. But, though no province had yet been lost, as Dacia had been lost in the century before, and though the frontier lines of the Rhine and the Danube were still guarded by Roman forts and troops, there were signs in plenty that a catastrophe was at hand.

From all the writers who deal with the 4th century we have one long series of laments over the depression and misery of the provinces.³ To meet the increased expenditure necessary to maintain the legions, to pay the hosts of officials, and to keep up the luxurious splendour of the imperial courts, not only were the taxes raised in amount, but the most oppressive and inquisitorial methods were adopted in order to secure for the imperial treasury every penny that could be wrung from the wretched taxpayer. The results are seen in such pictures as that which the panegyrist Eumenius⁴ draws of the state of Gaul (306-12) under Constantine, in the accounts of the same province under Julian fifty years later, in those given by Zosimus early in the 5th century, and in the stringent regulations of the Theodosian code, dealing with the assessment and collection of the taxes. Among the graver symptoms of economic ruin were the decrease of population, which seriously diminished not only the number of taxpayers, but the supply of soldiers for the legions;⁵ the spread of infanticide; the increase of waste lands whose owners and cultivators had fled to escape the tax collector; the declining prosperity of the towns; and the constantly recurring riots and insurrections, both among starving peasants, as in Gaul,⁶ and in populous cities like Antioch.⁷ The distress was aggravated by the civil wars, by the rapacity of tyrants, such as Maxentius and Maximus, but above all by the raids of the barbarians, who seized every opportunity afforded by the dissensions or incapacity of the emperors to cross the frontiers and harry the lands of the provincials. Constantine (306-12), Julian (356-60) and Valentinian I. (364-75) had each to give a temporary breathing-space to Gaul by repelling the Franks and Alamanni. Britain was harassed by Picts and Scots from the north (367-70), while the Saxon pirates swept the northern seas and the coasts both of Britain and Gaul. On the Danube the Quadi, Sarmatae, and above all the Goths, poured at intervals into the provinces of Pannonia and Moesia, and penetrated to Macedonia and Thrace. In the East, in addition to the constant border feud with Persia, we hear of ravages by the Isaurian mountaineers, and by a new enemy, the Saracens.⁸

From all the writers who deal with the 4th century we have one long series of laments over the depression and misery of the provinces.³ To meet the increased expenditure necessary to maintain the legions, to pay the hosts of officials, and to keep up the luxurious splendour of the imperial courts, not only were the taxes raised in amount, but the most oppressive and inquisitorial methods were adopted in order to secure for the imperial treasury every penny that could be wrung from the wretched taxpayer. The results are seen in such pictures as that which the panegyrist Eumenius⁴ draws of the state of Gaul (306-12) under Constantine, in the accounts of the same province under Julian fifty years later, in those given by Zosimus early in the 5th century, and in the stringent regulations of the Theodosian code, dealing with the assessment and collection of the taxes. Among the graver symptoms of economic ruin were the decrease of population, which seriously diminished not only the number of taxpayers, but the supply of soldiers for the legions;⁵ the spread of infanticide; the increase of waste lands whose owners and cultivators had fled to escape the tax collector; the declining prosperity of the towns; and the constantly recurring riots and insurrections, both among starving peasants, as in Gaul,⁶ and in populous cities like Antioch.⁷ The distress was aggravated by the civil wars, by the rapacity of tyrants, such as Maxentius and Maximus, but above all by the raids of the barbarians, who seized every opportunity afforded by the dissensions or incapacity of the emperors to cross the frontiers and harry the lands of the provincials. Constantine (306-12), Julian (356-60) and Valentinian I. (364-75) had each to give a temporary breathing-space to Gaul by repelling the Franks and Alamanni. Britain was harassed by Picts and Scots from the north (367-70), while the Saxon pirates swept the northern seas and the coasts both of Britain and Gaul. On the Danube the Quadi, Sarmatae, and above all the Goths, poured at intervals into the provinces of Pannonia and Moesia, and penetrated to Macedonia and Thrace. In the East, in addition to the constant border feud with Persia, we hear of ravages by the Isaurian mountaineers, and by a new enemy, the Saracens.⁸

From all the writers who deal with the 4th century we have one long series of laments over the depression and misery of the provinces.³ To meet the increased expenditure necessary to maintain the legions, to pay the hosts of officials, and to keep up the luxurious splendour of the imperial courts, not only were the taxes raised in amount, but the most oppressive and inquisitorial methods were adopted in order to secure for the imperial treasury every penny that could be wrung from the wretched taxpayer. The results are seen in such pictures as that which the panegyrist Eumenius⁴ draws of the state of Gaul (306-12) under Constantine, in the accounts of the same province under Julian fifty years later, in those given by Zosimus early in the 5th century, and in the stringent regulations of the Theodosian code, dealing with the assessment and collection of the taxes. Among the graver symptoms of economic ruin were the decrease of population, which seriously diminished not only the number of taxpayers, but the supply of soldiers for the legions;⁵ the spread of infanticide; the increase of waste lands whose owners and cultivators had fled to escape the tax collector; the declining prosperity of the towns; and the constantly recurring riots and insurrections, both among starving peasants, as in Gaul,⁶ and in populous cities like Antioch.⁷ The distress was aggravated by the civil wars, by the rapacity of tyrants, such as Maxentius and Maximus, but above all by the raids of the barbarians, who seized every opportunity afforded by the dissensions or incapacity of the emperors to cross the frontiers and harry the lands of the provincials. Constantine (306-12), Julian (356-60) and Valentinian I. (364-75) had each to give a temporary breathing-space to Gaul by repelling the Franks and Alamanni. Britain was harassed by Picts and Scots from the north (367-70), while the Saxon pirates swept the northern seas and the coasts both of Britain and Gaul. On the Danube the Quadi, Sarmatae, and above all the Goths, poured at intervals into the provinces of Pannonia and Moesia, and penetrated to Macedonia and Thrace. In the East, in addition to the constant border feud with Persia, we hear of ravages by the Isaurian mountaineers, and by a new enemy, the Saracens.⁸

From all the writers who deal with the 4th century we have one long series of laments over the depression and misery of the provinces.³ To meet the increased expenditure necessary to maintain the legions, to pay the hosts of officials, and to keep up the luxurious splendour of the imperial courts, not only were the taxes raised in amount, but the most oppressive and inquisitorial methods were adopted in order to secure for the imperial treasury every penny that could be wrung from the wretched taxpayer. The results are seen in such pictures as that which the panegyrist Eumenius⁴ draws of the state of Gaul (306-12) under Constantine, in the accounts of the same province under Julian fifty years later, in those given by Zosimus early in the 5th century, and in the stringent regulations of the Theodosian code, dealing with the assessment and collection of the taxes. Among the graver symptoms of economic ruin were the decrease of population, which seriously diminished not only the number of taxpayers, but the supply of soldiers for the legions;⁵ the spread of infanticide; the increase of waste lands whose owners and cultivators had fled to escape the tax collector; the declining prosperity of the towns; and the constantly recurring riots and insurrections, both among starving peasants, as in Gaul,⁶ and in populous cities like Antioch.⁷ The distress was aggravated by the civil wars, by the rapacity of tyrants, such as Maxentius and Maximus, but above all by the raids of the barbarians, who seized every opportunity afforded by the dissensions or incapacity of the emperors to cross the frontiers and harry the lands of the provincials. Constantine (306-12), Julian (356-60) and Valentinian I. (364-75) had each to give a temporary breathing-space to Gaul by repelling the Franks and Alamanni. Britain was harassed by Picts and Scots from the north (367-70), while the Saxon pirates swept the northern seas and the coasts both of Britain and Gaul. On the Danube the Quadi, Sarmatae, and above all the Goths, poured at intervals into the provinces of Pannonia and Moesia, and penetrated to Macedonia and Thrace. In the East, in addition to the constant border feud with Persia, we hear of ravages by the Isaurian mountaineers, and by a new enemy, the Saracens.⁸

From all the writers who deal with the 4th century we have one long series of laments over the depression and misery of the provinces.³ To meet the increased expenditure necessary to maintain the legions, to pay the hosts of officials, and to keep up the luxurious splendour of the imperial courts, not only were the taxes raised in amount, but the most oppressive and inquisitorial methods were adopted in order to secure for the imperial treasury every penny that could be wrung from the wretched taxpayer. The results are seen in such pictures as that which the panegyrist Eumenius⁴ draws of the state of Gaul (306-12) under Constantine, in the accounts of the same province under Julian fifty years later, in those given by Zosimus early in the 5th century, and in the stringent regulations of the Theodosian code, dealing with the assessment and collection of the taxes. Among the graver symptoms of economic ruin were the decrease of population, which seriously diminished not only the number of taxpayers, but the supply of soldiers for the legions;⁵ the spread of infanticide; the increase of waste lands whose owners and cultivators had fled to escape the tax collector; the declining prosperity of the towns; and the constantly recurring riots and insurrections, both among starving peasants, as in Gaul,⁶ and in populous cities like Antioch.⁷ The distress was aggravated by the civil wars, by the rapacity of tyrants, such as Maxentius and Maximus, but above all by the raids of the barbarians, who seized every opportunity afforded by the dissensions or incapacity of the emperors to cross the frontiers and harry the lands of the provincials. Constantine (306-12), Julian (356-60) and Valentinian I. (364-75) had each to give a temporary breathing-space to Gaul by repelling the Franks and Alamanni. Britain was harassed by Picts and Scots from the north (367-70), while the Saxon pirates swept the northern seas and the coasts both of Britain and Gaul. On the Danube the Quadi, Sarmatae, and above all the Goths, poured at intervals into the provinces of Pannonia and Moesia, and penetrated to Macedonia and Thrace. In the East, in addition to the constant border feud with Persia, we hear of ravages by the Isaurian mountaineers, and by a new enemy, the Saracens.⁸

From all the writers who deal with the 4th century we have one long series of laments over the depression and misery of the provinces.³ To meet the increased expenditure necessary to maintain the legions, to pay the hosts of officials, and to keep up the luxurious splendour of the imperial courts, not only were the taxes raised in amount, but the most oppressive and inquisitorial methods were adopted in order to secure for the imperial treasury every penny that could be wrung from the wretched taxpayer. The results are seen in such pictures as that which the panegyrist Eumenius⁴ draws of the state of Gaul (306-12) under Constantine, in the accounts of the same province under Julian fifty years later, in those given by Zosimus early in the 5th century, and in the stringent regulations of the Theodosian code, dealing with the assessment and collection of the taxes. Among the graver symptoms of economic ruin were the decrease of population, which seriously diminished not only the number of taxpayers, but the supply of soldiers for the legions;⁵ the spread of infanticide; the increase of waste lands whose owners and cultivators had fled to escape the tax collector; the declining prosperity of the towns; and the constantly recurring riots and insurrections, both among starving peasants, as in Gaul,⁶ and in populous cities like Antioch.⁷ The distress was aggravated by the civil wars, by the rapacity of tyrants, such as Maxentius and Maximus, but above all by the raids of the barbarians, who seized every opportunity afforded by the dissensions or incapacity of the emperors to cross the frontiers and harry the lands of the provincials. Constantine (306-12), Julian (356-60) and Valentinian I. (364-75) had each to give a temporary breathing-space to Gaul by repelling the Franks and Alamanni. Britain was harassed by Picts and Scots from the north (367-70), while the Saxon pirates swept the northern seas and the coasts both of Britain and Gaul. On the Danube the Quadi, Sarmatae, and above all the Goths, poured at intervals into the provinces of Pannonia and Moesia, and penetrated to Macedonia and Thrace. In the East, in addition to the constant border feud with Persia, we hear of ravages by the Isaurian mountaineers, and by a new enemy, the Saracens.⁸

From all the writers who deal with the 4th century we have one long series of laments over the depression and misery of the provinces.³ To meet the increased expenditure necessary to maintain the legions, to pay the hosts of officials, and to keep up the luxurious splendour of the imperial courts, not only were the taxes raised in amount, but the most oppressive and inquisitorial methods were adopted in order to secure for the imperial treasury every penny that could be wrung from the wretched taxpayer. The results are seen in such pictures as that which the panegyrist Eumenius⁴ draws of the state of Gaul (306-12) under Constantine, in the accounts of the same province under Julian fifty years later, in those given by Zosimus early in the 5th century, and in the stringent regulations of the Theodosian code, dealing with the assessment and collection of the taxes. Among the graver symptoms of economic ruin were the decrease of population, which seriously diminished not only the number of taxpayers, but the supply of soldiers for the legions;⁵ the spread of infanticide; the increase of waste lands whose owners and cultivators had fled to escape the tax collector; the declining prosperity of the towns; and the constantly recurring riots and insurrections, both among starving peasants, as in Gaul,⁶ and in populous cities like Antioch.⁷ The distress was aggravated by the civil wars, by the rapacity of tyrants, such as Maxentius and Maximus, but above all by the raids of the barbarians, who seized every opportunity afforded by the dissensions or incapacity of the emperors to cross the frontiers and harry the lands of the provincials. Constantine (306-12), Julian (356-60) and Valentinian I. (364-75) had each to give a temporary breathing-space to Gaul by repelling the Franks and Alamanni. Britain was harassed by Picts and Scots from the north (367-70), while the Saxon pirates swept the northern seas and the coasts both of Britain and Gaul. On the Danube the Quadi, Sarmatae, and above all the Goths, poured at intervals into the provinces of Pannonia and Moesia, and penetrated to Macedonia and Thrace. In the East, in addition to the constant border feud with Persia, we hear of ravages by the Isaurian mountaineers, and by a new enemy, the Saracens.⁸

¹ In especial against the overweening influence of the eunuchs, an influence at once greater and more pernicious than even that of the imperial freedmen in the days of Claudius.

² The son of Valentinian and ruler of the West.

Even more ominous of coming danger was the extent to which the European half of the empire was becoming barbarized.

The policy which had been inaugurated by Augustus himself of settling barbarians within the frontiers had been taken up on a larger scale and in a more systematic way by the Illyrian emperors of the 3rd century, and was continued by their successors in the 4th. In Gaul, in the provinces south of the Danube, even in Macedonia and Italy, large barbarian settlements had been made—Theodosius in particular distinguishing himself by his liberality in this respect. Nor did the barbarians admitted during the 4th century merely swell the class of half-servile *coloni*. On the contrary, they not only constituted to an increasing extent the strength of the imperial forces, but won their way in ever-growing numbers to posts of dignity and importance in the imperial service. Under Constantine the palace was crowded with Franks.¹ Julian led Gothic troops against Persia, and the army with which Theodosius defeated the tyrant Maximus (388) contained large numbers of Huns, and Alans, as well as of Goths. The names of Arbogast, Stilicho and Rufinus are sufficient proof of the place held by barbarians near the emperor's person and in the control of the provinces and legions of Rome; and the relations of Arbogast to his nominee for the purple, Eugenius, were an anticipation of those which existed between Ricimer and the emperors of the latter half of the 5th century.

It was by barbarians already settled within the empire that the first of the series of attacks which finally separated the western provinces from the empire and set up a barbarian ruler in Italy were made, and it was in men of barbarian birth that Rome found her ablest and most successful defenders. The Visigoths whom Alaric led into

Italy had been settled south of the Danube as the allies of the empire since the accession of Theodosius. But, like the Germans of the days of Caesar, they wanted land for their own, and Alaric himself aspired to raise himself to the heights which had been reached before him by the Vandal Stilicho at Ravenna and the Goth Rufinus at Constantinople. The jealousy which existed between the rulers of the western and eastern empires furthered his plans. In the name of Arcadius, the emperor of the east, or at least with the connivance of Arcadius's minister Rufinus, he occupied the province of Illyricum, and from thence ravaged Greece, which, according to the existing division of provinces, belonged to the western empire. Thence in 396 he retreated before Stilicho to Illyricum, with the command of which he was now formally invested by Arcadius; he thus gained a base of operations against Italy.² In 400 he led his people, with their wives and families, their wagons and treasure, to seek lands for themselves south of the Alps. But in this first invasion he penetrated no farther than the plains of Lombardy, and after the desperate battle of Pollentia (402 or 403) he slowly withdrew from Italy, his retreat being hastened by the promises of gold freely made to him by the imperial government. Not until the autumn of 408 did Alaric again cross the Alps. Stilicho was dead; the barbarian troops in Honorius's service had been provoked into joining Alaric by the anti-Teutonic policy of Honorius and his ministers, and Alaric marched unopposed to Rome. The payment of a heavy ransom, however, saved the city. Negotiations followed between Alaric and the court of Ravenna. Alaric's demands were moderate, but Honorius would grant neither lands for his people nor the honourable post in the imperial service which he asked for himself. Once more Alaric sat down before Rome, and the citizens were forced to agree to his terms. Attalus, a Greek, the prefect of the city, was declared Augustus, and Alaric accepted the post of commander-in-chief. But after a few months Alaric formally deposed Attalus, on account of his incapacity, and renewed his offers to Honorius. Again they were declined,

¹ Amm. Marc. xv. 5.

² Hodgkin *op. cit.* i. 661.

and Alaric marched to the siege and sack of Rome (410).³ His death followed hard on his capture of Rome. Two years later (412) his successor Ataulf led the Visigoths to find in Gaul the lands which Alaric had sought in Italy. It is characteristic of the anarchical condition of the west that Ataulf and his Goths should have fought for Honorius in Gaul against the tyrants,⁴ and in Spain against the Vandals, Suebi and Alani; and it was with the consent of Honorius that in 419 Wallia, who had followed Ataulf as king of the Visigoths, finally settled with his people in south-western Gaul and founded the Visigothic monarchy.⁵

It was about the same period that the accomplished fact of the division of Spain between the three barbarian tribes of Vandals, Suebi and Alani was in a similar manner recognized by the paramount authority of the emperor of the west.⁶ These peoples had crossed the Rhine at the time when Alaric was making his first attempt on Italy. A portion of the host led by Radagaisus⁷ actually invaded Italy, but was cut to pieces by Stilicho near Florence (405); the rest pressed on through Gaul, crossed the Pyrenees, and entered the as yet untouched province of Spain.

Honorius died in 423. With the single exception of Britain,⁸ no province had yet formally broken loose from the empire. But over a great part of the west the authority of the emperors was now little more than nominal; throughout the major part of Gaul and in Spain the barbarians had settled, and barbarian states were growing up which recognized the supremacy of the emperor, but were in all essentials independent of his control.

The long reign of Valentinian III. (423-55) is marked by two events of first-rate importance—the conquest of Africa by the Vandals⁹ and the invasion of Gaul and Italy by Attila. The Vandal settlement in Africa was closely akin in its origin and results to those of the Visigoths and of the Vandals themselves in Gaul and Spain. Here, as there, the occasion was given by the jealous quarrels of powerful imperial ministers.

The feud between Boniface, count of Africa, and Aëtius, the "master-general" or "count of Italy," opened the way to Africa for the Vandal king Gaiseric (Genserich), as that between Stilicho and Rufinus had before set Alaric in motion westward, and as the quarrel between the tyrant Constantine and the ministers of Honorius had paved the way for the Vandals, Suebes and Alans into Spain. In this case, too, land-hunger was the impelling motive with the barbarian invader, and in Africa, as in Gaul and Spain, the invaders' acquisitions were confirmed by the imperial authority which they still professed to recognize. In 429 Gaiseric, king of the Vandals, crossed with his warriors, their families and goods, to the province of Africa, hitherto almost untouched by the ravages of war. Thanks to the quarrels of Boniface and Aëtius, their task was an easy one. The province was quickly overrun. In 435¹⁰ a formal treaty secured them in the possession of a large portion of the rich lands which were the granary of Rome, in exchange for a payment probably of corn and oil. Carthage was taken in 439, and by 440 the Vandal kingdom was firmly established.

³ For the treatment of Rome by Alaric, see Hodgkin i. 798; Gibbon iii. 321 sqq.; Ranke iv. 246. Allowance must be made for the exaggerations of the ecclesiastical writers.

⁴ For these tyrants, see Freeman in the *Eng. Hist. Rev.* i. 53-86.

⁵ The capital of the new state was Tolosa (Toulouse).

⁶ Jung, *Die Romanischen Landschaften*, 73 seq.

⁷ For the connexion between his movement and those of Alaric and of the Vandals, see Hodgkin i. 711; Gibbon iii. 262 seq.

⁸ The Roman troops were withdrawn from Britain by Constantine in 407; Mommsen, *Chron. min.* i. 465.

⁹ Hodgkin vol. ii. bk. iii. chap. ii.; Gibbon ii. 400 sqq.; Jung, 183. The leading ancient authority is Procopius. See Ranke iv. (2) 285; Papencordt, *Gesch. d. Vandal. Herrschaft in Africa*.

¹⁰ Prosper 659; Ranke iv. (1) 282.

Eleven years later (451) Attila invaded Gaul, but this Hunnish movement was in a variety of ways different from those of the Visigoths and Vandals. Nearly a century had passed since the Huns first appeared in Europe, and drove the Goths to seek shelter within the Roman lines. Attila was now the ruler of a great empire in central and northern Europe and, in addition to his own Huns, the German tribes along the Rhine and Danube and far away to the north owned him as king. He confronted the Roman power as an equal; and, unlike the Gothic and Vandal chieftains, he treated with the emperors of east and west as an independent sovereign. His advance on Gaul and Italy threatened, not the establishment of one more barbaric chieftain on Roman soil, but the subjugation of the civilized and Christian West to the rule of a heathen and semi-barbarous conqueror. But the Visigoths in Gaul, Christian and already half Romanized, rallied to the aid of the empire against a common foe. Attila, defeated at Châlons¹ by Aëtius, withdrew into Pannonia (451). In the next year he overran Lombardy, but penetrated no farther south, and in 453 he died. With the murder of Valentinian III. (455) the western branch of the house of Theodosius came to an end, and the next twenty years witnessed the accession and deposition of nine emperors.

Under the three-months' rule of Maximus, the Vandals under Gaiseric invaded Italy and sacked Rome. From 456-72 the actual ruler of Italy was Ricimer, the Suebe. Of the four emperors whom he placed on the throne, Majorian (457-61) alone played any imperial part outside Italy.² Ricimer died in 472, and two years later a Pannonian, Orestes, attempted to fill his place. He deposed Julius Nepos and proclaimed as Augustus his own son Romulus. But the barbarian mercenaries in Italy determined to secure for themselves a position there such as that which their kinsfolk had won in Gaul and Spain and Africa. Their demand for a third of the lands of Italy was refused by Orestes,³ and they instantly rose in revolt. On the defeat and death of Orestes they proclaimed their leader, Odoacer the Rugian,⁴ king of Italy. Romulus Augustulus laid down his imperial dignity, and the court at Constantinople was informed that there was no longer an emperor of the West.⁵

The installation of a barbarian king in Italy was the natural climax of the changes which had been taking place in the West throughout the 5th century. In Spain, Gaul and Africa barbarian chieftains were already established as kings. In Italy, for the last twenty years, the real power had been wielded by a barbarian officer, Odoacer, when he decided to dispense with the nominal authority of an emperor of the West, placed Italy on the same level of independence with the neighbouring provinces. But the old ties with Rome were not severed. The new king of Italy formally recognized the supremacy of the one Roman emperor at Constantinople, and was invested in return with the rank of "patrician," which had been held before him by Aëtius and Ricimer. In Italy too, as in Spain and Gaul, the laws, the administrative system and the language remained Roman.⁶

But the emancipation of Italy and the Western provinces from direct imperial control, which is signaled by Odoacer's accession, has rightly been regarded as marking the opening of a new epoch. It made possible in the West the development of a Romano-German civilization; it facilitated the growth of new and distinct states and nationalities; it gave a new impulse

¹ For the battle of Châlons, see Gibbon iv. 464; Hodgkin ii. 124 n. 6, 143, where the topography is discussed.

² Majorian was the last Roman emperor who appeared in person in Spain and Gaul.

³ Hodgkin ii. 520.

⁴ The nationality of Odoacer is a disputed point. Hodgkin ii. 516; Ranke iv. (1) 372.

⁵ Gibbon iv. 50 seq. The authority for the embassy to Zeno is Maichus (Müller, *Fragm. Hist. Gr.* i. 119).

⁶ Gibbon iv. 54 seq.; Jung 66 seq.; Bryce, *Holy Roman Empire*, 24-33. See also ROMAN LAW.

to the influence of the Christian church, and laid the foundations of the power of the bishops of Rome.

CHRONOLOGICAL TABLE OF THE ROMAN EMPERORS

B.C.		A.D.	
27.	Augustus.	244.	Philip.
A.D.		249.	Decius.
14.	Tiberius.	251.	Gallus.
37.	Caligula.	253.	Aemilianus.
41.	Claudius.	260.	{ Valerian. Gallienus.
54.	Nero.	268.	Claudius.
68, 69.	{ Galba. Otho. Vitellius.	270.	{ Quintrillus. Aurelianus.
69.	Vespasian.	275.	Tacitus.
79.	Titus.	276.	Probus.
81.	Domitian.	282.	Carus.
96.	Nerva.	283.	Carinus and Numerian.
98.	Trajan.	284.	{ Diocletian (Maximian associated with him, 286).
117.	Hadrian.	305.	Constantianus and Galerius.
138.	Antoninus Pius.	311.	{ Licinius. Constantine I.
161.	Marcus Aurelius.	324.	Constantine I.
180.	Commodus.	325.	{ Constantine II. Constantianus II.
193.	{ Pertinax. Didius Julianus. Septimius Severus.	337.	{ Constantius II. Constans.
211.	Caracalla.	350.	Constantianus II., sole emperor.
217.	Macrinus.	361.	Julian.
218.	Elagabalus.	363.	Jovian.
222.	Alexander Severus.		
235.	Maximinus.		
238.	{ The two Gordiani. Pupienus and Balbinus. Gordian III.		

Division of the Empire.

A.D.	West.	A.D.	East.
364.	Valentinian I.	364.	Valens.
375.	Gratian and Valentinian II.	379.	Theodosius I.
383.	Valentinian II.		
392.		Theodosius I.	
395.	Honorius.	395.	Arcadius.
423.	Valentinian III.	408.	Theodosius II.
455.	Maximus.	450.	
455.	Aëtius.		
455.	Majorian.	457.	Leo I.
457.	Avitus.		
457.	Severus.		
467.	Anthemius.		
472.	Olybrius.		
473.	Glycerius.		
474.	Julius Nepos.	474.	Leo II.
475.	Romulus Augustulus.		

(H. F. P.; H. S. J.)

AUTHORITIES.—I. REPUBLICAN PERIOD: *Ancient Sources.*—The writing of history, like other branches of literature, was a late growth amongst the Romans, and it is very difficult to determine how far authentic records were preserved of the earlier republican period. It seems that the calendars issued yearly by the pontifices and posted on the walls of the Regia were inscribed with brief notices of important events ("digna memoratu . . . domi militiaeque terra marique gesta per singulos dies," *Serv. Ad Aen.* i. 373); these tabulae were preserved and edited in 80 books by P. Mucius Scaevola (*pontifex maximus*, 130-7114 B.C.) under the name of *Annales Maximi*. The *Commentarii* preserved in the archives of the various priestly colleges and official boards (e.g. consuls and censors), which appear to have consisted mainly of instructions as to official procedure, doubtless furnished historical material in the shape of precedents and decisions. It is hard to say how much of this documentary evidence survived the burning of Rome by the Gauls; the fact that the earliest solar eclipse mentioned in the *Annales Maximi* was that of the 5th of June, 351 B.C., casts doubt on the completeness of the earlier records.

Many modern scholars have supposed that these meagre official records were supplemented by—(a) popular poetry, more or less legendary in content; (b) family chronicles, the substance of which was worked up into the funeral orations (*laudationes funebres*) pronounced at the grave of distinguished Romans. The existence of the former class of documents is, however, quite unsupported by evidence; as to family tradition, we cannot say more than that it has probably left a deposit in the accounts of republican history handed down to us, and caused the exploits of the members of illustrious houses to be exaggerated in importance.

Setting aside the works of Greek historians who incidentally touched on Roman affairs, such as Hieronymus of Cardia, who wrote of the wars of Pyrrhus as a contemporary, and Timaeus of Tauromenium (c. 345-250 B.C.), who treated of the history of Sicily and the West down to 272 B.C., the earliest writers on Roman history

were Q. Fabius Pictor¹ and L. Cincius Alimentus, who lived during the Second Punic War and wrote in Greek. We are told by Dionysius that they treated the earlier history summarily, but wrote more fully of their own times. They were followed in their use of the Greek language by C. Acilius (introduced a Greek embassy to the senate, 155 B.C.) and A. Postumius Albinus (consul, 151-149 B.C.). In the meantime, however, M. Porcius Cato the Elder (234-184 B.C.), the leader of the national party at Rome and a vigorous opponent of Greek influence, had treated of Roman antiquities in his *Origines*. This work was not purely a nationalistic but treated of the ethnography and customs of the Italian peoples, &c. Cato founded no school of antiquarian research, but his use of the Latin language as the medium of historical writing was followed by the annalists of the Gracchan period, L. Cassius Hemina, L. Calpurnius Piso (consul, 133 B.C.), C. Sempronius Tuditanus (consul, 129 B.C.), Cn. Gellius Vennonius, C. Fannius (consul, 122 B.C.), and L. Caelius Antipater.² By these writers some attempt was made to apply canons of criticism to the traditional accounts of early Roman history, but they did little more than rationalize the more obviously mythical narratives; they also followed Greek literary models and introduced speeches, &c., for artistic effect. Where they wrote as contemporaries, however, e.g. Fannius in his account of the Gracchan movement, their works were of the highest value. About the beginning of this period Polybius (q.v.) had published his history, which originally embraced the period of the Punic wars, and was afterwards continued to 146 B.C. His influence was not fully exerted upon Roman historians until the close of the 2nd and early part of the 1st century B.C., when a school of writers arose who treated history with a practical purpose, endeavouring to trace the motives of action and to point a moral for the edification of their readers. To this school belonged Sallustius, Sallustius Crispus, Valerius, Valerius Antias and C. Licinius Macer (d. 66 B.C.). Their writings were diffuse, rhetorical and inaccurate; Livy complains of the gross exaggerations of Valerius (whom he followed blindly in his earlier books), and Macer seems to have drawn much of his material from sources of very doubtful authenticity. Contemporary history was written by Cornelius Sisenna (119-67 B.C.), and the work of Polybius was continued to 86 B.C. by the Stoic Posidonius (c. 135-45 B.C.), a man of encyclopaedic knowledge. From the Gracchan period onwards the memoirs, speeches and correspondence of distinguished statesmen were collected, and some of these are preserved to us until we come to the Ciceronian period, when the Speeches and Letters of Cicero (q.v.) and the Commentaries of Julius Caesar (q.v.)—the latter continued to the close of the Civil War by other hands—furnish invaluable evidence for the history of their times. We possess examples of historical pamphlets with a strong party colouring in Sallust's tracts on the Jugurthine War and the conspiracy of Catiline. During the same period Roman antiquities, genealogy, chronology, &c., were exhaustively treated by M. Terentius Varro (116-27 B.C.) (q.v.) in his *Antiquitates* (in 41 books) and other works. Cicero's friend, M. Pomponius Atticus, also compiled a chronological table which was widely used, and Cornelius Nepos (q.v.) wrote a series of historical biographies which have come down to us.

In the Augustan age the materials accumulated by previous generations were worked up by compilers whose works are in some cases preserved. The work of Livy (q.v.) covered the history of Rome from its foundation to 9 B.C. in 142 books; of these only 35 are preserved in their entirety, while the contents of the rest are known in outline from an epitome (*periochae*) and from the compendia of Florus and later authors. Diodorus Siculus (q.v.) of Agrigum in Sicily followed the earlier annalists in the sections of *Universal History*, but of these specimens we remain with Roman affairs; Dionysius of Halicarnassus (q.v.), in his *Roman Antiquities* (published in 7 B.C.), treated early Roman history in a more ambitious and rhetorical style, with greater fulness than Livy, whose work he seems to have used. Universal histories were also written in the Augustan age by Nicolaus of Damascus, a protégé of Herod the Great, and Trogus Pompeius, whose work is known to us from the epitome of Justin (2nd century A.D.). Juba, the learned king of Mauretania installed by Augustus, wrote a History of Rome as well as antiquarian works. Strabo (q.v.), whose *Geography* is extant, was the author of a continuation of Polybius's history (1st or 7 B.C.). The learning of the time was enshrined in the encyclopaedic *Verborum Significatio*, of which we possess part of Festus's abridgment (2nd century A.D.), together with an Epitome of Festus by Paulus Diaconus (*lemp. Charlemagne*). An official list of the consuls and other chief magistrates of the republic was inscribed on the walls of the Regia (rebuilt 36 B.C.), followed somewhat later by a similar list of triumphators; the former of these is known as the *Fasti Capitolini*, (*C.I.L.* 1, 1 sq.), since the fragments which have been recovered are preserved in the Palace of the Conservatori on the Capitol. The Forum of Augustus (see *ROME*, section *Archaeology*) was decorated with the statues of Roman consuls, on the bases of which were inscribed short accounts of their exploits; some of these *elogia* are preserved (cf. Dessau, *Inscr. Lat. sel.* 50 sq.).

¹ Amongst writers of the imperial period who dealt with republican

history the most important are Velleius Paterculus, whose compendium of Roman history was published in A.D. 30; Plutarch (c. A.D. 45-125), in whose biographies much contemporary material was worked up; Appian, who wrote under the Antonines and described the wars of the republic under geographical headings (partly preserved) and the civil wars in five books, and Dio Cassius (q.v. *infra*), of whose history only that portion which deals with events from 69 B.C. onwards is extant. The date of Granicus Licinianus, whose fragments throw light on the earlier civil wars, is not certain. The evidence of inscriptions (q.v.) and coins (q.v.) begins to be of value during the 150 years of the republic. A series of laws and *Senatus consulta* (beginning with the *Senatus consultum de Bacchanalibus*, 189 B.C.) throws light on constitutional questions, while the coins struck from about 150 B.C. onwards bear types illustrative of the traditions preserved by the families to which the masters of the mint (*III viri monetales*) belonged.

MODERN AUTHORITIES.—The principles of historical criticism may be said to have been formulated by Gianbattista Vico (q.v.), whose *Principi di scienza nuova* were published in 1725. The credibility of the traditional account of Roman republican history was called in question by Louis de Beaufort (*Dissertation sur l'incertitude des cinq premiers siècles de l'histoire romaine*, 1738); but the modern critical movement dates from Niebuhr, two volumes of whose *Römische Geschichte* appeared in 1811-12 (the third was published after his death in 1832, his lectures in 1846). The early history of Rome was fully treated by Niebuhr's follower, F. C. A. Schwieger, whose *Römische Geschichte* in 3 vols. (1853-58) was continued to 327 B.C. by O. Clason (vols. 4 and 5, 1873-76). A reaction against the negative criticism of Niebuhr was headed by G. Rohmbo, who showed in his *Internationale der römischen Verfassungsgeschichte und Geschichte* (1839) that the growth of the Roman constitution might be traced with some approach to certainty by the analysis of institutions. It was left for Theodor Mommsen (*Römische Geschichte*, 1st ed., 1854-56; Eng. trans. new ed. in 5 vols., 1894; *Römische Forschungen*, 1864-79; *Römisches Staatsrecht*, 1st ed., 1872-75 [in the *Handbuch der römischen Alterthümer*, begun by Becker in 1843 and continued under the supervision of J. Marquardt]; *Römisches Strafrecht*, 1899, and many other works) to reduce Roman constitutional history to a science. Mommsen substituted for the detailed criticism of Niebuhr a generalization of a network of the Roman civilization based on linguistic, literary and monumental evidence. W. Ihne (*Römische Geschichte*, 8 vols., 1868-90) dealt more fully with the course of events as related by ancient historians. L. Lange's *Römische Alterthümer* (1856-71), 3 vols., treated constitutional history in a narrative form. In more recent times Eduard Meyer has treated of early Italian history in his *Geschichte des Alterthums*, vols. ii.-v. (1803-1902); and Ettore Pais, in his *Storia di Roma*, vols. i.-ii. (1898-99), has subjected the narratives of Roman history down to the Samnite wars to a searching and in many cases exaggerated criticism. De Sanctis, in his *Storia dei Romani* (2 vols., 1907) down to the establishment of the Roman hegemony in Italy, combines radical criticism of tradition with a constructive use of archaeological and other evidence. Heitland's *Roman Republic* (3 vols., 1909) is a fresh and independent work. The last century of the republic has been the subject of many works (see ref. in text and biographical articles). W. Drumann (*Geschichte Roms*, 1834-44; new ed. by Groebe in progress) gave an exhaustive biographical account of the contemporaries of Caesar and Cicero; A. H. J. Greenidge's *History of Rome from 133 B.C. to A.D. 70* (vol. i., 1904) was unfortunately cut short by the author's early death in 1906; G. Ferrero's *Grandes Epées* (a network of the republic), Eng. trans. 2 vols. i., ii. (1907, ii.-v., 1909) is ambitious but unsound.

II. IMPERIAL PERIOD: *Ancient Sources*.—The memoirs of Augustus as well as those of his contemporaries (Messalla, Agrippa, Maecenas, &c.) and successors (Tiberius, Agrippina the younger, &c.) have perished, but we possess the *Res gestae divi Augusti* inscribed on the walls of his temple at Ancyra (ed. Mommsen, 1883). Few historical works were produced under the earlier Julio-Claudian emperors; Cremutius Cordus lost his life under Tiberius for the freedom with which his opinion of the triumphs was expressed. Aulidius Bassus wrote the history of the civil wars and the early empire, perhaps to A.D. 49, and this was continued by Pliny the Elder (q.v.) in 31 books probably to the accession of Vespasian.³ These works together with those of Fabius Rusticus, a friend of Seneca, and Cluvius Rufus, a courtier under Nero, were amongst the authorities used by Tacitus (q.v.), whose *Annals* (properly called *ab excessu divi Augusti*) and *Histories*, when complete, carried the story of the empire down to A.D. 96.⁴ Tacitus wrote under Trajan, upon whom the younger Pliny pronounced his *Panegyric*; Pliny's correspondence with Trajan about the affairs of Bithynia, which he administered in A.D. 111-13, is of great historical value. Suetonius (q.v.), who was for some time secretary of state to Hadrian, wrote the biography of the emperors from Julius Caesar to Domitian, which contain much interesting gossip. Arrian, a Bithynian Greek promoted by Hadrian

¹ For these writers see further under ANNALISTS and LIVY.

² Caelius's work dealt only with the Second Punic War.

³ The *Jewish Antiquities* and *Jewish War* of Josephus (q.v.), composed under the Flavian dynasty, are of great value for the events of the writer's time.

⁴ The *Histories* (A.D. 69-96) were written before the *Annals*.

to important posts, wrote on Rome's policy and wars in the East. Appian (*v. supra*) dealt with the wars waged under the early empire in the closing books of his work, which have not been preserved. Dio Cassius, a Bithynian who attained to the dignity of a second consulship as the colleague of Severus Alexander, wrote a history of Rome to the death of Elagabalus in 217 by A.D. 229. He possesses only fragments of interest of the portion dealing with events from A.D. 46 onwards, except for parts of the 78th and 79th books, in which Dio's narrative of contemporary events is especially valuable. Herodian, a Syrian employed in the imperial service, wrote a history of the emperors from Commodus to Gordian III., which as the work of a contemporary is not without value, although the author had no historical insight. L. Marius Maximus compiled biographies of the emperors from Nerva to Elagabalus which, like those of Suetonius, contained much worthless gossip. His work was amongst the sources used in the compilation of the *Historia Augusta* (see further AUGUSTAN HISTORY) upon which we are obliged to rely for the history of the 3rd century A.D. This work consists in a series of lives of the emperors (including most of the pretenders to that title) from Hadrian to Carinus, professedly written by six authors, Spartianus, Vulcacius Gallicanus, Capitolinus, Lampridius, Trebellianus Pollio, and Vopiscus, under Diocletian and Constantine. Modern criticism has shown that (at least in its present form) it is a compilation made towards the close of the 4th century; it is not even certain that any of the names mentioned actually existed, and the documents inserted in the text are palpable forgeries. The earlier biographies, however, contain much authentic information, which seems to have been derived from a good contemporary source. The fragments of Dexippus, an Athenian who successfully defended his native town against the Goths, throw much light on the barbaric invasions of the 3rd century. Under Diocletian and his successors (A.D. 289-321) were delivered twelve *Panegyrics* by Eumenius and other court rhetoricians which possess slight historical value. The history of the final struggle between church and empire is told from the Christian point of view by the author of the *De mortibus persecutorum*—perhaps Lactantius, the tutor of Crispus. Eusebius's *Ecclesiastical History and Life of Constantine* give an *ex parte* version of the events which they relate; the first of two tracts published under the name of the Anonymous Valesianus furnishes a brief contemporary narrative of the period 305-37, without Christian prepossessions; while the lost work of Praxagoras treated the history of Constantine from the pagan standpoint. The most important historian of the 4th century was Ammianus Marcellinus, a native of Antioch and an official in the imperial army, who continued the work of Tacitus (in Latin) to the death of Valens. We possess the last eighteen books of his history which cover the years A.D. 353-78. Two compendia of imperial history pass under the name of Aurelius Victor, the *Caesares*, or lives of the emperors from Augustus to Julian, and the *Építome de Caesariis* (not by the same author,) which goes down to Theodosius I. Similar works are the *Breviarum* of Eutropius (secretary of state under Valens) and the still more brief epitome of Festus. The writings of the Emperor Julian and of the rhetoricians Valentinus, Theodoretus and Eunapius—the last-named continued the history of Dexippus to A.D. 404—were of great value for the latter part of the 4th century A.D. They were as pagans, while the Christian version of events is given by the three orthodox historians Socrates, Sozomen and Theodoret, and the Arian Philostorgius, all of whom wrote in the 5th century. An imperial official, Zosimus, writing in the latter half of that century, gave a sketch of imperial history to A.D. 410; the latter part is valuable, being based on contemporary writings, e.g. those of the Egyptian Olympic victor of whose work some fragments are preserved. The bishops Synesius and Palladius, who lived under Arcadius and Theodosius II., furnish valuable information as to their own times; while the fragments of Priscus tell us much of Attila and the Hunnish invasions. Mention must also be made of the poets and letter-writers of the 4th and 5th centuries—Ausonius, Claudian, Symmachus, Paulinus of Nola, Sidonius Apollinaris, Prudentius, Merobaudes and others—from whose writings much historical information is derived. Cassiodorus, the minister of Theodoric, wrote a history of the Goths, transmitted to us in the *Historia Gothorum* or *ordines* (c. A.D. 550), which gives an account of the earlier barbaric invasions.

Several chronological works were compiled in the 4th and 5th centuries. It will suffice to name the Chronology of Eusebius (to A.D. 324), translated by Jerome and carried down to A.D. 378; the Chronicle of Prosper Tiro, based on Jerome and continued to A.D. 455; the *Chronography of A.D. 354*, an illustrated calendar containing miscellaneous information; and the works based on the so-called *Chronica Constantinopolitana* (not the same as the *Chronica* of Hydruntis containing valuable notices of the period A.D. 379-468). Some minor chronological works such as the *Chronicon Ravennae* are published in Mommsen's *Chronica Minora*. The *Chronicon Paschale*, primarily a table giving the cycle of Easter celebrations, was compiled in the 7th century A.D.

The Codes of Law, especially the *Codex Theodosianus* (A.D. 438) and the Code of Justinian, as well as the Army List of the early 5th century, known as the *Notitia Dignitatum*, possess great historical value. For the inscriptions of the empire, which are of incalculable

importance as showing the working of the imperial system in its details, see INSCRIPTIONS; the coins (*q.v.*) also throw much light on the dark places of history in the lack of other authorities. Egyptian papyri are not only instructive as to legal, economic and administrative history, but also (by the formulae employed in their dating) contribute to our general knowledge of events. The *Zeitschrift für Papyrologie*, edited by U. Wilcken, gives an account of progress in this branch of study.

MODERN AUTHORITIES.—Tillemont's *Histoire des empereurs* (6 vols., 1690-1738), supplemented by his *Mémoires pour servir à l'histoire ecclésiastique*, a laborious and erudite compilation, furnished Gibbon with material for his *Decline and Fall of the Roman Empire* (1776-1788), which has never been superseded as a history of the entire imperial period, and has been rendered adequate for the purposes of the modern reader by Professor J. B.ury's edition (1897-1900). The history of the empire has yet to be written in the light of recent discoveries. Mommsen's fifth volume (*Eng. tr.* as *Provinces of the Roman Empire*, 1886) is not a narrative, but an account of Roman culture in the various provinces. C. Merivale's *History of the Romans under the Empire* (8 vols., 1850-62, to Marcus Aurelius) is literary rather than scientific. H. Schiller's *Geschichte der römischen Kaiserzeit* (1883-88) is a useful handbook. For the later period we have Bury's *History of the Later Roman Empire* (1889), beginning from A.D. 395, and T. Hodgkin's *Italy and her Invaders* (8 vols., 1885-99), which tells the story of the barbaric invasions at great length. The imperial constitution is described by Mommsen in the second volume of his *Staatsrecht* (*v. supra*); divergent views will be found in Herzog's *Geschichte und System der römischen Staatsverfassung* (1884-91); the working of the imperial bureaucracy is treated by O. Hirschfeld, *Die römischen Verwaltungbeamten* (1905). The *Prosopographia Imperii Romani*, compiled by Dessau and Klebs (1897-1898), is a mine of information, as is the new edition of Pauly's *Realencyclopädie der classischen Alterthumswissenschaft* (in progress). Von Domaszewski's *Geschichte der römischen Kaiser* (2 vols., 1909) is popularly written and gives no references to authorities. See further the articles on individual emperors and provinces.

A general history of Rome to the barbarian invasions, popular in character and richly illustrated, was written in French by Victor Duruy (*Eng. tr.* in 6 vols., 1883-86). The 2nd, 3rd and 4th vols. of Leopold von Ranke's *Weltgeschichte* deal with Roman history. An outline of Roman history is given by B. Niese in the 3rd vol. of Müller's *Handbuch der klassischen Alterthumswissenschaft* (3rd ed., 1906). A. H. J. Greenidge's *Roman Public Life* (1901) is an excellent guide to Roman institutions. The principal authorities on Roman chronology are: Ideler, *Handbuch der mathematischen und technischen Chronologie* (1825-26); Fynes-Clinton, *Fasti Romani* (1845) (a continuation of the same author's *Fasti Hellenici*, 1830-41, which goes down to A.D. 14); Fischer, *Römische Zeitfahnen* (1846); Mommsen, *Römische Chronologie* (2nd ed., 1850); Matzat, *Römische Chronologie* (1883-84) and *Römische Zeitfahnen* (1889); Holzappel, *Römische Chronologie* (1885); Soltau, *Römische Chronologie* (1889); Unger, *Römische Zeitrechnung* in the 1st vol. of Müller's *Handbuch der klassischen Alterthumswissenschaft* (2nd ed., 1862). Guyau's *Chronologie de l'empire romain* (Paris, 1891) is a useful handbook.

(H. S. J.)

IV. The Roman Republic in the Middle Ages

The history of the Roman commune as distinguished from the papacy during the middle ages has yet to be written, and only by the discovery of new documents can the difficulties of the task be completely overcome. Although very different in its origin, the Roman Republic gradually assumed the same form as the other Italian communes, and with almost identical institutions. But, owing to the special local conditions amid which it arose, it maintained a distinct physiognomy and character. The deserted Campagna surrounding the city checked any notable increase of trade or industry, and prevented the establishment of the guilds on the solid footing that elsewhere made them the basis and support of the commune. There was also the continual and oppressive influence of the empire, and, above all, the presence of the papacy, which often appeared to absorb the political vitality of the city. At such moments the commune seemed annihilated, but it speedily revived and reasserted itself. Consequently there are many apparent gaps in its history, and we have often extreme difficulty in discovering the invisible links connecting the visible fragments.

Even the aristocracy of Rome had a special stamp. In the other republics, with the exception of Venice, it was feudal, of German origin, and in perpetual conflict with the popular and commercial elements which sought its destruction. The history of municipal freedom in Italy lay in this struggle. But the infiltration of Teutonic and feudal elements broke up the

ancient aristocracy of Rome, gave it a special character and left it at the mercy of the people. Then the popes, by the bestowal of lucrative offices, rich benefices and vast estates, and, above all, by raising many nobles to the purple, introduced new blood into the Roman aristocracy, and ended it with increasing strength and vitality. Always divided, always turbulent, this irrepressible body was a continual source of discord and civil war, of permanent confusion and turmoil. Amidst all these difficulties the commune struggled on, but never succeeded in preserving a regular course of administration for long. What with continual warfare, attacks on the Capitol and consequent slaughter, pillage and incendiarism, it is no wonder that so few original documents are left to illustrate the history of the Roman Republic. Nor have chroniclers and historians done much to supply this want, since, in treating of Roman affairs, their attention is mainly devoted to the pope and the emperor. Nevertheless, we will attempt to connect in due order all the facts gleaned from former writers and published records.

The removal of the seat of the empire to Constantinople effected a radical change in the political situation of Rome; nor was this change neutralized by the formation of the weak Western empire soon to be shattered by the Germanic invasions. But we still find Roman laws and institutions; and no sign is yet manifest of the rise of a medieval municipality. The earliest germ of this new type of municipality is seen during the barbarian invasions. Of these we need only enumerate the four most important—those of the Goths, Byzantines (who, however, were not mere barbarians but civilized and corrupt), Lombards and Franks. The Gothic rule merely superimposed upon the Roman social order a Teutonic stratum, that never penetrated beneath its surface. The Goths always remained a conquering army; according to the

The Goths.

German custom, they took possession of one-third of the vanquished territory, but, while forbidding the Romans to bear arms, left their local administration intact. The senate, the curiae, the principal magistrates, both provincial and municipal, the prefect of the city, and the Roman judges enforcing the enactments of the Roman law, were all preserved. Already, under the empire, the civil power had been separated from the military, and this separation was maintained. Hence there was no visible change in the constitution of the state. Only, now there were conquered and conquerors. All real and effective power was on the side of brute force, and the Goths alone bore arms. In every province they had their *comites*, or heads of the army, who had judicial power over their countrymen, especially in criminal cases. Here, then, was a combination of civil and military jurisdiction altogether contrary to Roman ideas. Nor can it be denied that the *comites*, as chiefs of the armed force, necessarily exerted a direct or indirect influence on the civil and administrative power of the provinces, and especially upon the collection of the imposts. The civil arm, being virtually subordinate to the military, suffered unavoidable change. Notwithstanding the praise lavished on Theodoric, the kingdom founded by him in Italy had no solid basis. It was composed of two nations differing in race and traditions and even in religion, since the Goths were Arians and the Romans Catholics. The latter were sunk in degeneracy and corruption; their institutions were old and decrepit. It was necessary to infuse new life into the worn-out body. This was difficult, perhaps impossible; and at any rate Theodoric never attempted the task. Little wonder then if the Gothic kingdom succumbed to the Byzantine armies from Constantinople.

The wars of Belisarius and Narses against the Goths lasted twenty years (535-55 A.D.), caused terrible slaughter and the devastation in Italy, and finally subjected her to the *The Byzantine rule.* Constantinople. In place of a Gothic king she was now ruled by a Greek patrician, afterwards entitled the exarch, who had his seat of government at Ravenna as lieutenant of the empire. In the chief provincial cities the ruling counts were replaced by dukes, sub-

ordinate to the exarch; and the smaller towns were governed by military tribunes. Instead of dukes, we sometimes find *praefecti militum*, apparently of higher rank. The *praefectus praetorio* of Italy, likewise a dependent of the exarch, was at the head of the civil administration. The pragmatic sanction (554), promulgating the Justinian code, again separated the civil from the military power, which was no longer allowed to intervene in the settlement of private disputes, and, by conferring on the bishops the superintendence of and authority over the provincial and municipal government, soon led to the increase of the power of the church, which had already considerable influence.

The new organization outwardly resembled that of the Goths: one army had been replaced by another, the counts by dukes; there was an exarch instead of a king; the civil and military jurisdictions were more exactly defined. But the army was not, like that of the Goths, a conquering nation in arms; it was a Graeco-Roman army, and did not hold a third of the territory which was now probably added to the possessions of the state (*fisc*). The soldiery took its pay from Constantinople, whence all instructions and appointments of superior officers likewise proceeded. In Rome we find a *magister militum* at the head of the troops. The Roman senate still existed, but was reduced to a shadow. Theodoric had left it intact until he suspected it of hostile designs and dealings with the Byzantines, but then began to persecute it, as was proved by the wretched fate of Boetius and Symmachus. Nevertheless the senate survived, added the functions of a *curia* or municipal council to those of a governmental assembly, and took part in the election of the pope—already one of the chief affairs of Rome. So many senators, however, were slaughtered during the Byzantine War that it was commonly believed to be extinct. The pragmatic sanction, conferring on senate and pope the superintendence of weights and measures in Italy, might seem a convincing proof to the contrary, although, in the general chaos, now that Rome was a mere provincial city, constantly exposed to attack, we may imagine to what the senate was reduced.

All Roman institutions were altered and decayed; but their original features were still to be traced, and no heterogeneous element had been introduced into them. The first dawn of a completely new epoch can only be dated from the invasion of the Lombards (568-72). Their conquest of a large portion of Italy was accompanied by the *The Lombards.* harshest oppression. They abolished all ancient laws and institutions, and not only seized a third of the land, but reduced the inhabitants almost to slavery. But, in the unsubdued parts of the country—namely, in Ravenna, Rome and the maritime cities—a very different state of things prevailed. The necessity for self-defence and the distance of the empire, now too worn out to render any assistance, compelled the inhabitants to depend solely on their own strength. Thus, certain maritime cities, such as Naples, Amalfi, Pisa and Venice, soon attained to a greater or less degree of liberty and independence.

This is the moment in which ancient society seems to disappear completely and a new one begins to rise. Ancient customs disappear, Christian processions take the place of the ancient games, ancient temples are transformed into churches and dedicated to new saints. If Roman tradition in Italy can ever be said to have been completely broken, this could only be during the Longobard domination. It is certain, however, that soon the elements of ancient culture began to revive once more.

A special state of things now arose in Rome. We behold the rapid growth of the papal power and the continual increase of its moral and political influence. This had already begun under Leo I., and been further promoted by the pragmatic sanction. Not only the superintendence but often the nomination of public functionaries and judges was now in the hands of the popes. And the accession to St Peter's chair of a man of real genius in the person of Gregory I., surnamed the Great, marked the beginning of a new era. By force of individual character, as well as by historic

The popes.

Gregory I.

necessity, this pope became the most potent personage in Rome. Power fell naturally into his hands; he was the true representative of the city, the born defender of church and state. His ecclesiastical authority, already great throughout Italy, was specially great in the Roman diocese and in southern Italy. The continual offerings of the faithful had previously endowed the church with enormous possessions in the province of Rome, in Sicily, Sardinia and other parts. The administration of all this property soon assumed the shape of a small government council in Rome. In the middle ages the owner of the land was also master of the men who cultivated it, and exercised political authority as well; these administrators therefore protected and succoured the oppressed, settled disputes, nominated judges and controlled the ecclesiastical authorities. The use made by the pope of his revenues greatly contributed to the increase of his moral and political authority. When the city was besieged by the Lombards, and the emperor left his army unpaid, Gregory supplied the required funds and thus made resistance possible. And, when the defence could be no longer maintained, he alone, by the weight of his personal influence and the payment of large sums, induced the Lombards to raise the siege. He negotiated in person with Agilulph, and was recognized by him as the true representative of the city. Thus Rome, after being five times taken and sacked by the barbarians, was, on this occasion, saved by his bishop. The exarch, although unable to give any help, protested against the assumption of so much authority by the pope; but Gregory was no usurper; his attitude was the natural result of events. "For twenty-seven years"—so wrote this pontiff to the imperial government of Constantinople—"we lived in terror of the Longobards, nor can I say what sums we had to pay them. There is an imperial treasurer with the army at Ravenna; but here it is I who am treasurer. Likewise I have to provide for the clergy, the poor and the people, and even to succour the distress of other churches."

It was at this moment that the new Roman commune began to take shape and acquire increasing vigour owing to its distance from the seat of the empire and its resistance to the Lombard besiegers. Its special character was now to be traced in the preponderance of the military over the civil power. A Roman element had penetrated into the army, which was already possessed of considerable political importance. The prefect of Rome loses authority and seems almost a nullity compared with the *magister militum*. Hardly anything is heard of the senate. "Quia enim Senatus deest, populus interit," exclaims Gregory in a moment of despair. The popes now make common cause with the people against the Lombards on the one hand and the emperor on the other. But they avoid an absolute rupture with the empire, lest they should have to face the Lombard power without any prospect of help. Later, when the growing strength of the commune becomes menacing, they remain faithful to the empire in order not to be at the mercy of the people. It was a permanent feature of their policy never to allow the complete independence of the city until they should be its sole and absolute masters. But that time was still in the future. Meanwhile pope and people joined in the defence of their common interests.

This alliance was cemented by the religious disputes of the East and the West. First came the Monothelite controversy regarding the twofold nature of Christ. Later a long and violent struggle ensued, in which the people of Rome and of other Italian cities sided so vigorously with the popes that John VI. (701-5) had to interpose in order to release the exarch from captivity and prevent a definitive rupture with the empire. Then (710-11) Ravenna revolted against the emperor, organized its armed population under twelve flags, and almost all the cities of the exarchate joined in a resistance that was the first step towards the independence of the Italian communes. A still fiercer religious quarrel then broke out concerning images. Pope Gregory II. (715-31) opposed the celebrated edict of the iconoclastic emperor Leo the Isaurian.

Venice and the Pentapolis took up arms in favour of the pope, and elected dukes of their own without applying to the emperor. Again public disorder rose to such a pitch that the pope was obliged to check it lest it should go too far.

In the midst of these warlike tumults a new constitution, almost a new state, was being set up in Rome. During the conflict with Philippicus, the Monothelite and heretical emperor who ascended the throne in 711, the *Liber Pontificalis* makes the first mention of the duchy of Rome (*ducatu Romanæ urbis*), and we find the people struggling to elect a duke of their own. In the early days of the Byzantine rule the territory appertaining to the city was no greater than under the Roman Empire. But, partly through the weakness of the government of Constantinople, and above all through the decomposition of the Italian provinces under the Lombards, who destroyed all unity of government in the peninsula, this dukedom was widely extended, and its limits were always changing in accordance with the course of events. It was watered by the Tiber, and stretched into Tuscia to the right, starting from the mouth of the Marta, by Tolfa and Bleda, and reaching as far as Orte. Viterbo was a frontier city of the Lombards. On the left the duchy extended into Latium as far as the Garigliano. It spread very little to the north-east and was badly defended on that side, inasmuch as the duchy of Spoleto reached to within fourteen miles of the Salara gate. On the other side, towards Umbria, the river Nera was its boundary line.

The constitution of the city now begins to show the results of the conditions amid which it took shape. The separation of the civil from the military power has entirely disappeared. This is proved by the fact that, after the year 600, there is no further mention of the prefect. His office still survived, but with a gradual change of functions, until, in the 8th century, he once more appears as president of a criminal tribunal. The constitution of the duchy and of the new republic formed during the wars with the Lombards and the exarch was substantially of an aristocratico-military nature. At its head was the duke, first appointed by the emperor, then by the pope and the people, and, as his strength and influence grew with those of the commune, he gradually became the most respected and powerful personage in Rome. The duke inhabited the palace of the Caesars on the Palatine Hill, and had both the civil and the military power in his hands; he was at the head of the army, which, being composed of the best citizens and highest nobility of Rome, was a truly national force. This army was styled the *felicitissimus* or *florens exercitus Romanus* or also the *militia Romana*. Its members never lost their citizen stamp; on the contrary they formed the true body of the citizens. We find mention of other *duces* in Rome, but these were probably other leaders or superior officers of the army. Counts and tribunes are found in the subject cities bound to furnish aid to the capital. In fact during the pontificate of Sergius II. (844), when the duchy was threatened by a Saracenic invasion, they were requested to send troops to defend the coast, and as many soldiers as possible to the city.

At that time the inhabitants of Rome were divided into four principal classes—clergy, nobles, soldiers and simple citizens. The nobles were divided into two categories, first the genuine *optimales*, i.e. members of old and wealthy families with large estates, and filling high, and often hereditary, offices in the state, the church and the army. These were styled *proceres* and *primates*. The second category comprised landed proprietors, of moderate means but exalted position, mentioned as *nobiles* by Gregory I., and constituting in fact a numerous petty nobility and the bulk of the army. Next followed the citizens, i.e. the commercial class, merchants and craftsmen, who, having as yet no fixed organization and but little influence, were simply designated as *honesti cives*. These, however, were quite distinct from the plebeians, *plebs*, *vilgus populi*, *virii humiles*, who in their turn ranked above bondsmen and slaves. The *honesti cives* did not

The duchy of Rome.

The first constitution of the commune.

The Roman commune.

The different classes of society in Rome.

usually form part of the army, and were only enrolled in it in seasons of emergency. Nevertheless the army was not only national, but became increasingly democratic, so that in the 10th century it included every class of inhabitants except churchmen and slaves. At that period we sometimes find the whole people designated as the *exercitus*, those actually under arms being distinguished as the *militia exercitus Romani*.

This again was divided into bands or "numbers," *i.e.* regiments, and also, in a manner peculiar to Rome, into *scholae militum*. These *scholae* were associations derived from antiquity, gaining strength and becoming more general in the middle ages as the central power of the state declined. There were *scholae* of notaries, of church singers, and of nearly every leading employment; there were *scholae* of foreigners of diverse nationalities, of Franks, Lombards, Greeks, Saxons, &c. Even the trades and crafts began to form *scholae*. These were at first very feeble institutions, and only later gained importance and became guilds. As early as the 8th century there were *scholae militum* in the army, which was thus doubly divided. But we have no precise definition of their functions. They were *de facto* corporations with separate property, churches and magistrats of their own. The latter were always *optimates*, and guarded the interests of the army. But the real chiefs of the bands or *numeri* were the *duces* or tribunes, and under the Franks the latter became *comites*. These chiefs were styled *magnifici consules*, *optimates de militia*, often too *iudices de militia*, since, as was the custom of the middle ages, they wielded political and judicial as well as military authority. The title of consul was now generally given to superior officers, whether civil or military. The importance of the *scholae militum* began to decline in the 10th century; towards the middle of the 12th they disappeared altogether, and, according to Felix Papencordt, were last mentioned in 1145. It is probable that the *scholae militum* signified local divisions of the army, corresponding with the city wards, which were twelve in number during the 10th and 11th centuries, then increased to thirteen, and occasionally to fourteen. It is certain that from the beginning the army was distributed under twelve flags; after the *scholae* had disappeared, we find it classified in districts, which were subdivided into companies. The division of cities into quarters, *sestieri* or *riani*, corresponding with that of the army, and also with that of the municipal government, was the common practice of Florence, Siena and almost all the Italian communes. But, while usually losing importance as the guilds acquired power, in Rome the insignificance of the guilds added to the strength of the *regioni* or *riani*, which not only became part of the army but finally grasped the reins of government. This was a special characteristic of the political constitution of the Roman commune.

We now come to a question of weightier import for all desiring to form a clear idea of the Roman government at that period.

What had become of the senate? It had undoubtedly lost its original character now that the empire was extinct. But, after much learned discussion, historical authorities are still divided upon the subject. Certain

Italian writers of the 18th century—Vendettini, for example—asserted with scanty critical insight that the Roman senate did not disappear in the middle ages. The same opinion backed by much learned research was maintained by the great German historian Savigny. And Leo, while denying the persistence of the curia in Lombard Italy, adhered to Savigny's views as regarded Rome. Papencordt did the same, but held the Roman senate to be no more than a curia. This judgment was vigorously contested, first by Hegel and Giesebrecht, then by Gregorovius. These writers believe that after the middle of the 6th century the senate had a merely nominal existence. According to Gregorovius its last appearance was in the year 579. After that date it is mentioned in no documents, and the chroniclers are either equally silent or merely allude to its decay and extinction. In the 8th century, however, the terms *senator*, *senatores*, *senatus* again reappear. We find letters addressed to Pippin, beginning thus: *Omnis*

senatus atque universi populi generalitas. When Leo III. returned from Germany he was met by *tam proceres clericorum cum omnibus clericis, quamque optimates et senatus, cunctaque militia* (see Anastasius, in Muratori, vol. iii. 198c). But it has been noted that the senate was never found to act as a political assembly; on occasions when it might have been mentioned in that capacity we hear nothing of it, and only meet with it in ceremonials and purely formal functions. Hence the conclusion that the term *senator* was used in the sense of noble, *senatus* of nobility, and no longer referred to an institution but only to a class of the citizens. Even when we find that the emperor Otto III. (who sought to revive all the ancient institutions of Rome) addressed an edict to the "consuls and senate of Rome," and read that the laws of St Stephen were issued *senatus decreto*, the learned Giesebrecht merely remarks that no important changes in the Roman constitution are to be attributed to the consuls and senate introduced by Otto III. Thus for the next glimpse of the senate we must pass to the 12th century, when it was not only reformed, as some writers believe, but entirely reconstituted.

But in this case a serious difficulty remains to be disposed of. Gregorovius firmly asserts that the nobles acquired great power between the 7th and 10th centuries, not only filling the highest military, judicial and ecclesiastical offices, "but also directing the municipal government, presumably with the prefect at their head." He further adds: "Notwithstanding the disappearance of the senate, it is difficult to suppose that the city was without governing magistrats, or without a council." Thus, after the 7th century, the *optimates* at the head of the army were also at the head of the citizens, and "formed a communal council in the same manner in which it was afterwards formed by the *banderesi*."¹ Now, if the nobles were called *senatores* and the nobility *senatus*, and if this body of nobles met in council to administer the affairs of the republic, there is no matter for dispute, inasmuch as all are agreed that the original senate must have had a different character from the senate of the middle ages. And, since the absence of all mention of a prefect after the 7th century is not accepted as a proof of his non-existence, and we find him reappear under another form in the 8th century, so the silence as to the senate after the year 579, the fresh mention of it in the 8th century, and its reappearance in the 12th as a firmly reconstituted body reasonably lead to the inference that, during that time, the ancient senate had been gradually transformed into the new council. Its meetings must have been held very irregularly, and probably only in emergencies when important affairs had to be discussed, previously to bringing them before the parliament or general assembly of the people. Historians

are better agreed as to the significance of the term *consul*. At first this was simply a title of honour bestowed on superior magistrats, and retained that meaning from the 7th to the 11th century, but then became—as in other Italian cities—a special title of the chief officers of the state. During this period the Roman constitution was very simple. The duke, commanding the army, and the prefect, presiding over the criminal court, were the chiefs of the republic; the armed nobility constituted the forces, filled all of superior offices, and occasionally met in a council called the senate, although it had, as we have said, no resemblance to the senate of older times. In moments of emergency a general parliament of the people was convoked. This constitution differed little from that of the other Italian communes, where, in the same way, we find all the leading citizens under arms, a parliament, a council, and one or more chiefs at the head of the government.

But Rome had an element that was lacking elsewhere. We have already noted that, in the provinces, the administrators of church lands were important personages, and exercised during the middle ages, when there was no exact division of power, both judicial and political functions. It was very natural that the heads of this vast administration resident in Rome should have a still higher standing, and in fact, from the

¹ Gregorovius, *Geschichte*, vol. ii. pp. 427-28 and note (2nd ed.).

6th century, their power increased to such an extent that in the times of the Franks they already formed a species of papal cabinet with a share and sometimes a predominance in the affairs of the republic. There were seven principal administrators, but two of them held the chief power—the *primicerius notariorum* and the *secundicerius*, i.e. the first and under secretaries of state. When, on the constitution of the new empire, these ministers were declared to be palatine or imperial as well as papal officials, the *primicerius* and the *secundicerius* were also in waiting on the emperor, who sat in council with them when in Rome. Next came the *arcarius*, or treasurer; the *scellarius*, or cashier; the *protoscriniarius*, who was at the head of the papal chancery; the *primus defensor*, who was the advocate of the church and administered its possessions. Seventh and last came the *nomenclator*, or *admirator*, who pleaded the cause of widows, orphans and paupers. There were also some other officials, such as the *vestiarius*, the *vicedominus* or steward, the *cubicularius* or major-domo, but these were of inferior importance. They were ecclesiastics, but not bound to be in priest's orders. The first seven were those specially known as *proceres clericorum* and oftener still as *judices de clero*, since they speedily assumed judicial functions and ranked among the chief judges of Rome. But as ecclesiastics they did not give decisions in criminal cases. Thus Rome had two tribunals, that of the *judices de clero*, or *ordinarii*, presided over by the pope, and that of the *judices de militia*, leaders of the army, dukes and tribunes, also bearing the generic title of consuls. First appointed by the exarch and then frequently by the pope, these decided both civil and criminal cases. In the latter they were sole judges under the presidency of the prefect.

The pope was thus at the head of a large administrative body with judicial and civil powers that were continually on the increase, and, in addition to his moral authority over Christendom, was possessed of enormous revenues. So in course of time he considered himself the real representative of the Roman Republic. Gregory II. (715-31) accepted in the name of the republic the submission of other cities, and protested against the conquest by the Lombards of those already belonging to Rome. He seemed indeed to regard the territory of the duchy as the patrimony of the church. The duke was always at the head of the army, and, officially, was always held to be an imperial magistrate. But the empire was now powerless in Italy. Meanwhile the advance of the Lombards was becoming more and more threatening; they seized Ravenna in 751, thus putting an end to the exarchate, and next marched towards Rome, which had only its own forces and the aid of neighbouring cities to rely upon. To avoid being crushed by the brute force of a foreign nation unfit to rule, and only capable of oppression and pillage, it was necessary to make an energetic stand.

Accordingly, the reigning pope, Stephen II. (752-57), appealed to Pippin, king of the Franks, and concluded with that monarch an alliance destined to inaugurate a new epoch of the world's history. The pope consecrated Pippin king of the Franks, and named him *patricius Romanorum*. This title, as introduced by Constantine, had no longer the ancient meaning, but now became a sign of lofty social rank. When, however, it was afterwards conferred on barbarian chieftains such as Odoacer and Theodoric, and then on the representative of the Byzantine empire in Italy, it acquired the meaning of a definite dignity or office. In fact, the title was now given to Pippin as defender of the church, for the pope styled him at the same time *patricius Romanorum* and *defensor* or *protector ecclesiae*. And the king pledged himself not only to defend the church but also to wrest the exarchate and the Pentapolis from the Lombards and give them to Rome, or rather to the pope, which came to the same thing. This was considered as a restitution made to the head of the church, who was also the representative of the republic and the empire. And, to preserve the character

of a restitution, the famous "donation of Constantine" was invented during this period (752-77). Pippin brought his army to the rescue (754-55) and fulfilled his promise. The pope accepted the donation in the name of St Peter, and as the visible head of the church. Thus in 755 central Italy broke its connexion with the empire and became independent; thus was inaugurated the temporal power of the papacy, the cause of so much subsequent warfare and revolution in Rome.

Its first consequences were speedily seen. In 767 the death of Paul I. was followed by a fierce revolt of the nobles under Duke Toto (Theodoro) of Nepi, who by violent means raised his brother Constantine to the chair of St Peter, although Constantine was a layman and had first to be ordained. For more than a year the new pontiff was a pliable tool in the hands of Toto and of the nobles. But the genuine papal faction, headed by a few *judices de clero*, asked the aid of the Lombards and made a formidable resistance. Their adversaries were defeated, tortured and put to death. Toto was treacherously slain during a fight. The pope was blinded and left half dead on the highway. Fresh and no less violent riots ensued, owing to the public dread lest the new pope, Stephen III. (768-72), elected by favour of the Lombards, should give them the city in return. But Stephen went over to the Franks, whom he had previously deserted, and his successor, Adrian I. (772-95), likewise adhered to their cause, called the city to arms to resist King Desiderius and his Lombard hordes, and besought the assistance of Charlemagne. This monarch accordingly made a descent into Italy in 773, and not only gained an easy victory over Desiderius, but destroyed the Lombard kingdom and seized the iron crown. Entering Rome for the first time in 774, he confirmed and augmented the donation of Pippin by the addition of the dukedom of Spoleto. He returned several times to Italy and Rome, making new conquests and fresh concessions to Adrian I., until the death of the latter in 795.

The position of Rome and of the pope is now substantially changed. Duke, prefect, militia and the people exist as heretofore, but are all subordinate to the head of the church, who, by the donations of Pippin and Charlemagne, has been converted into a powerful temporal sovereign. Henceforth all connexion with Byzantium is broken off, but Rome is still the mainspring of the empire, the Roman duchy its sole surviving fragment in Italy, and the pope stands before the world as representative of both. And, although it is difficult to determine how this came about, the pope is now regarded and regards himself as master of Rome. In the year 772 he entrusts the *vestiarius* with judicial powers over the laity, ecclesiastics, freemen and slaves *nostrae Romanae reipublicae*. He writes to Charlemagne that he has issued orders for the burning of the Greek ships employed in the slave trade, "in our city of Civita Vecchia" (Centumcellae), and he always speaks of Rome and the Romans as "our city," "our republic," "our people." The donations of Pippin and Charlemagne are restitutions made to St Peter, the holy church and the republic at the same time. It is true that Charlemagne held the supreme power, had an immensely increased authority and actively fulfilled his duties as *patricius*. But his power was only occasionally exercised in Rome; it was the result of services rendered to the church, and of the church's continual need of his help; it was, as it were, the power of a mighty and indispensable ally. The pope, however, was most tenacious of his own authority in Rome, made vigorous protest whenever rebels fled to Charlemagne or appealed to that monarch's arbitration, and contested the supremacy of the imperial officials in Rome. Yet the pope was no absolute sovereign, nor, in the modern sense of the term, did any then exist. He asserted supremacy over many lands which continually rebelled against him, and which, for want of an army of his own, he was unable to reduce to obedience without others' help. Neither did the republic acknowledge him as its head. It profited by

Judices de clero.

Donation of Pippin.

Charlemagne in Italy.

The popes and the papal power.

The popes appeal to the Franks for aid.

The papacy, the republic and the Franks.

the growing power of the pope, could not exist without him, respected his moral authority, but considered that he usurped undue power in Rome. This was specially the feeling of the nobles, who had hitherto held the chief authority in the republic, and, being still the leaders of the army, were by no means willing to relinquish it. The Roman nobles were very different from other aristocratic bodies elsewhere. They were not as they pretended, descendants of the Camilli and the Scipios, but neither were they a feudal aristocracy, inasmuch as the Teutonic element had as yet made small way among them. They were a mixture of different elements, national and foreign, chiefly by the special conditions of Rome. Their power was firmly derived from the high offices and large grants of money and land conferred on them by the popes; but, as no dynasty existed, they could not be dynastic. Every pope aggrandized his own kindred and friends, and these were the natural and often open adversaries of the next pontiff and his favourites. Thus the Roman nobility was powerful, divided, restless and turbulent; it was continually plotting against the pope, threatening not only his power, but even his life; it continually appealed to the people for assistance, stirred the militia to revolt and rendered government an impossibility. Hence, notwithstanding his immense moral authority, the pope was the effective head neither of the aristocracy, the army nor of the as yet unorganized lower classes. The lord of vast but often insubordinate territories, the recognized master of a capital city torn by internecine feud and plots against himself, he needed the support of an effective force for his own preservation and the maintenance of the authority proffered him from all quarters. Hence the necessity of creating an empire of the West, after having snapped every link with that of the East. Thus the history of Rome is still, as in the past, a history of continual strife between pope, emperor and republic; and the city, while imbibing strength from all three, keeps them in perpetual tumult and confusion.

Leo III. (796-816) further strengthened the ties between Charlemagne and the church by sending the former a letter with the keys of the shrine of St Peter and the banner of Rome. Charlemagne had already joined to his office of patrician the function of high justice. The new symbols now sent constituted him *miles* of Rome and general of the church. The pope urged him to despatch an envoy to receive the oath of fealty, thus placing himself, the representative of the republic, in the subordinate position of one of the bishops who had received the immunities of counts. And all these arrangements took place without the slightest reference to the senate, the army or the people. Much resentment was felt, especially by the nobles, and a revolution ensued headed by the *primicerius* Paschalis and the *secundicerius* Campulus, and backed by all who wished to liberate the city from the papal rule. During a solemn procession the pope was attacked and barbarously maltreated by his assailants, who tried to tear out his eyes and tongue (799). He was thrown into prison, escaped and overtook Charlemagne at Paderborn, and returned guarded by ten of the monarch's envoys, who condemned to death the leaders of the revolt, reserving, however, to their sovereign the right of final judgment. Charlemagne arrived in December 800, and as high justice assembled a tribunal of the clergy, nobles, citizens and Franks; he pronounced Leo to be innocent, and confirmed the capital sentence passed on the rebels. But through the intercession of the pope, who dreaded the wrath of the nobles, this was presently commuted into perpetual exile. And finally on Christmas day, in St Peter's, before an assemblage of Roman and Frankish lords, the clergy and the people, the pontiff placed the imperial crown on Charlemagne's head and all proclaimed him emperor.

Thus the new emperor was elected by the Romans and consecrated by the pope. But he was their real master and supreme judge. The pope existed only by his will, since he alone supplied the means for the maintenance of the temporal power, and already pretended to the right of controlling the

papal elections. Yet Charlemagne was not sovereign of Rome; he possessed scarcely any regalia there, and was not in command of the army; he mainly represented a principle, but this principle was the law which is the basis of the state. The pope still nominated the Roman judges, but the emperor or his *missi* presided over them, together with those of the pope, and his decision was appealed to in last resort. During the Carolingian times no mention is found of the prefect, and it would seem that his office was filled by the imperial *missus*, or legate, the *judices de clero* and *judices de militia*. The power of the pope was now entangled with that of the republic on the one hand and that of the empire on the other. The consequent confusion of sacred and secular functions naturally led to infinite complications and disputes.

The death of Charlemagne in 814 was the signal for a fresh conspiracy of the nobles against the pope, who, discovering their design, instantly put the ringleaders to death, and was severely blamed by Louis for this violation of the imperial prerogative. While the matter was under discussion the nobles broke out in fiercer tumults, both in Rome and the Campagna. At last, in 824, the emperor Lothair came to re-establish order in Rome, and proclaimed a new and noteworthy constitution, to which Pope Eugenius II. (824-27) gave his oath of adherence. By this the partnership of pope and emperor in the temporal rule of Rome and the states of the church was again confirmed. The more direct power appertained to the pope; the supreme authority, presidency of the tribunals, and final judgment on appeal to the emperor. The new constitution also established the right of contending parties to select either the Roman or the Teutonic code for the settlement of their disputes. During the Carolingian period it is not surprising that the commune should have been, as it were, absorbed by the church and the empire. In fact, it is scarcely mentioned in history throughout that time. And when, no longer sustained by the genius of its founder, the Frankish empire began to show signs of dissolution, the popes, finding their power thereby strengthened, began to assume many of the imperial attributes. Soon, however, as a natural consequence of the loss of the main support of the papacy, the nobles regained vigour and were once more masters of the city. Teutonic and feudal elements had now largely penetrated into their organization. The system of granting lands, and even churches and convents, as benefices according to feudal forms, became more and more general. It was vain for the popes to offer opposition, and they ended by yielding to the current. The fall of the Frankish empire left all Italy a prey to anarchy, and torn by the faction fights of Berengar of Friuli and Guido of Spoleto, the rival claimants to the crowns of Italy and the empire. The Saracens were advancing from the south, the Huns from the north; the popes had lost all power; and in the midst of this frightful chaos a way was opened for the rise of the republics. Anarchy was at its climax in Rome, but the laity began to overpower the clergy to such an extent that the *judices de militia* prevailed over the *judices de clero*. For a long time no imperial *missi* or legates had been seen, and the papacy was incredibly lowered. The election of the popes had positively fallen into the hands of certain beautiful women notorious for their evil life and depravity. The aristocracy alone gained strength; now freed from the domination of the emperor, it continually wrested fresh privileges from the impotent pontiffs, and became organized as the ruling force of the republic.

Gregorovius, notwithstanding his denial of the continuation of the senate after the 6th century, is obliged to acknowledge that it appeared to have returned to life in the power of this new baronage. And, although this body was now permeated with the feudal principle, it did not discard its ancient traditions. The nobles claimed to be the main source of the empire; they wished to regain the dignity and office of *patricius*, and to make it, if possible, hereditary in some of their families. Nothing is known of their system of organization, but it seems

Charlemagne crowned emperor.

Decline of the empire.

Renewed power of the aristocracy.

that they elected a chief bearing the title of *consul, senator, princeps Romanorum*, who was officially recognized by the pope, as a *patricius* presided over the tribunals, and was the head of the commune.

Theophylact was one of the first to assume this dignity. His wife Theodora, known as the *senatrix*, was one of the women then dominating Rome by force of their charms and licentiousness. She was supposed to be the concubine of Pope John X. (914-28), whose election was due to her influence. Her daughter Marozia, in all things her worthy rival, was married to Alberic, a foreign mercenary of uncertain birth who rose to a position of great influence, and, although an alien, played a leading part in the affairs of the city. He helped to increase the power of Theophylact, who seemingly shared the rule of the city with the pope. In the bloody war that had to be waged against the Saracens of southern Italy, and at the defeat of the latter on the Garigliano (916), Theophylact and Alberic were the Roman leaders, and distinguished themselves by their valour. They disappeared from the scene after this victory, but Marozia retained her power, and bore a son, Alberic, who was destined to greater deeds. The pope found himself caught in this woman's toils, and struggled to escape, but Marozia, gaining fresh influence by her marriage with Hugo, margrave of Tuscany, imprisoned the pontiff himself in the castle of St Angelo (928). This fortress was the property of Marozia and the basis of her strength. The unfortunate John died within its walls. Raised to the chair by Theodora, he was deposed and killed by her daughter. The authority of the latter reached its culminating point in 931, when she succeeded in placing her son John XI. on the papal throne. On the death of her second husband she espoused Hugh of Provence, the same who in 928 had seized the iron crown at Pavia, and now aspired to the empire. Dissolute, ambitious and despotic, he came to Rome in 932, and, leaving his army outside the walls, entered the castle of St Angelo with his knights, instantly began to play the tyrant, and gave a blow to Alberic his stepson, who detested

him as a foreign intruder. This blow proved the cause of a memorable revolution; for Alberic rushed from the castle and harangued the people, crying that the time was come to shake off the tyrannous yoke of a woman and of barbarians who were once the slaves of Rome. Then, putting himself at the head of the populace, he closed the city gates to prevent Hugh's troops from coming to the rescue, and attacked the castle. The king fled; Marozia was imprisoned, Alberic proclaimed lord of the Romans, and the pope confined to the Lateran in the custody of his own brother. Rome was again an independent state, a republic of nobles. Rid of the temporal dominion of emperor and pope, and having expelled the foreigners with great energy and courage, it chose Alberic for its chief with the title of *princeps atque omnium Romanorum senator*. The tendency of the Roman Republic to elect a supreme authority, first manifested in the case of Theophylact, was repeated in those of Alberic, Brancalione, Crescenzo, Cola di Rienzo and others. One of the many causes of this tendency may be traced to the conception of the new empire of which Rome was the original and enduring fountainhead. As Rome had once transferred the empire from Byzantium to the Franks, so Rome was surely entitled to reclaim it. The imperial authority was represented by the office of patrician, now virtually assumed by Alberic. That he gave the name of Octavian to his son is an additional proof of this fact. In the Eternal City the medieval political idea has always the aspect of a resurrection or transformation of classic antiquity. This is another characteristic of the history of the Roman commune.

Alberic's strength was due to his connexion with the nobility, to his father's valiant service against the Saracens at the battle of Garigliano, and to the militia under his command, on which everything depended amid the internal and external dangers now threatening the new state. As yet no genuine municipal constitution was possible in Rome, where neither the people nor the wealthy burghers engaged in industry and commerce

had any fixed organization. All was in the hands of the nobles, and Alberic, as their chief, frequently convened them in council, although obliged to use pressure to keep them united and avoid falling a prey to their disputes. Hence the whole power was concentrated in his grasp; he was at the head of the tribunals as well as of the army. The *judices de clero* and *judices de militia* still existed, but no longer met in the Lateran or the Vatican, under the presidency of emperor and pope or their *missi*. Alberic himself was their president; and, a still more significant fact, their sittings were often held in his private dwelling. There is no longer any mention of prefect or *patricius*. The papal coinage was inscribed with Alberic's name instead of the emperor's. His chief attention was given to the militia, which was still arranged in *scholae*, and it is highly probable that he was the author of the new division of the city into twelve *regions*, with a corresponding classification of the army in as many regiments under twelve flags and twelve *banderes*, one for every region. The organization of the *scholae* could not have been very dissimilar, but doubtless Alberic had some important motive for altering the old method of classification. By means of the armed regions he included the people in the forces. It is certain that after his time we find the army much changed and far more democratic. It was only natural that so excellent a statesman should seek the aid of the popular element as a defence against the arrogance of the nobles, and it was requisite to reinforce the army in order to be prepared for the attacks threatened from abroad. This change effected, Alberic felt prepared for the worst, and began to rule with energy, moderation and justice. His contemporaries award him high praise, and he seems to have been exempt from the vices of his mother and grandmother.

In 933 Hugh made his first attack upon the city, and was repulsed. A second attempt in 936 proved still more unfortunate, for his army was decimated by a pestilence. Thoroughly disheartened, he not only made peace, but gave his daughter in marriage to Alberic, thus satisfying the latter's desire to ally himself with a royal house. But this union led to no conciliation with Hugh. For Alberic, finding his power increased, marched at the head of his troops to consolidate his rule in the Campagna and the Sabine land. On the death of his brother, Pope John XI., in 936, he controlled the election of several successive popes, quelled a conspiracy formed against him by the clergy and certain nobles instigated by Hugh, and brilliantly repulsed, in 947, another attack by that potentate. At last, however, this inveterate foe withdrew from Rome, being summoned to the north by the victories of his rival Berengarius. But Alberic, after procuring the election of various popes who were docile instruments of his will, experienced a check when Agapetus II. (946-55), a man of firmness and resource, was raised to the papal throne. The fortunes of Berengarius were now in the ascendant. In 950 he had seized the iron crown, and ruled in the Pentapolis and the exarchate. This being singularly painful to the pope, he proceeded to make alliance with all those enemies of Berengarius preferring a distant emperor to a neighbouring and effective sovereign, with the Roman nobles who were discontented with Alberic, and with all who foresaw danger, even to Rome, from the extended power of Berengarius. And Agapetus recurred to the old papal policy, by making appeal to Otto I., whose rule in Germany was distinguished by a prestige almost comparable with that of Charlemagne.

Otto immediately responded to the appeal and descended into Italy; but his envoys were indignantly repulsed by Alberic, and, being prudent as well as firm, he decided to wait a more opportune moment for the accomplishment of his designs. Meanwhile Alberic died in 954, and the curtain fell on the first great drama of the Roman Republic. He had reigned for twenty-two years with justice, energy and prudence; he had repelled foreign invaders, maintained order and authority. He seems, however, to have realized that the aspect of affairs was about to change, that the work he had accomplished would be exposed to new dangers. These dangers, in fact, had already begun with the accession of an enterprising pope to the Holy

See. The name of Octavian given by Alberic to his son leads to the inference that he meant to make his power hereditary. But, suddenly, he began to educate this son for the priesthood, and, assembling the nobles in St Peter's shortly before his death, he made them swear to elect Octavian as pope on the decease of Agapetus II. They kept their word, for in this way they freed themselves from a ruler. Possibly Alberic trusted that both offices might be united, and that his son would be head of the state as well as the church. But the nobles knew this to be a delusion, especially in the case of a nature such as Octavian's. The lad was sixteen years old when his father died, received princely honours until the death of Agapetus, and was then elected pope with the name of John XII. He had inherited the ungoverned passions of his grandmothers Marozia and great-grandmother Theodora, but without their intelligence and cunning. His palace was the scene of the most scandalous licence, while his public acts were those of a baby tyrant. He conferred a bishopric on a child of ten, consecrated a deacon in a stable, invoked Venus and Jupiter in his games, and drank to the devil's health. He desired to be both pope and prince, but utterly failed to be either. Before long, realizing the impossibility of holding in check Berengarius, who still ruled over the exarchate, he sought in 960 the aid of Otto I., and promised him the imperial crown. Thus the new ruler was summoned by the son of the man by whom he had been repulsed. Otto vowed to defend the church, to

restore her territories, to refrain from usurping the power of the pope or the republic, and was crowned on the 2nd of February 962 with unheard-of pomp and display.

Accordingly, after being extinct for thirty-seven years, the empire was revived under different but no less difficult conditions. The politico-religious unity founded by Charlemagne had been dissolved, partly on account of the heterogeneous elements of which it was composed, and partly because other nations were in course of formation. Now too the feudal system was converting the officers of the empire into independent princes, and the new spirit of communal liberty was giving freedom to the cities. Otto once more united the empire and the church, Italy and Germany, in order to combat these new foes. But the difficulties of the enterprise at once came to light. John XII., finding a master in the protector he had invoked, now joined the discontented nobles who were conspiring with Berengarius against the emperor. But the latter hastened to Rome in November 963, assembled the clergy, nobles and heads of the people, and made them take an oath never again to elect a pope without his consent and that of his son. He also convoked a synod presided over by himself in St Peter's, which judged, condemned and deposed Pope John and elected Leo VIII. (863-65), a Roman noble, in his stead. All this was done at the direct bidding of the emperor, who thus deprived the Romans of their most valued privilege, the right of choosing their own pope. But the people had now risen to

considerable importance, and, for the first time, we find it officially represented in the synod by the plebeian Pietro, surnamed Imperiola, together with the leaders of the militia, which had also become a popular institution since Alberic's reign. It was no longer easy to keep the lower orders in subjection, and by their junction with the discontented nobles they formed a very respectable force. On the 3rd of January 964 they sounded the battle-peak and attacked the Vatican, where the emperor was lodged. The German knights repulsed them with much slaughter, and this bloodshed proved the beginning of an endless feud. Otto departed in February, and John XII., as the chosen pope of the Romans, returned with an army of followers and compelled the defenceless Leo VIII. to seek safety in flight. Soon afterwards Leo was deposed and excommunicated by a new synod, and many of his adherents were cruelly murdered. But on the 14th of May 964 John suddenly expired; the Romans, amid violent struggles and tumults, resumed their rights, elected Benedict V., and procured his consecration in spite of the emperor's veto. Otto now appeared at the head

of an army, committed fresh slaughter, besieged the city, reduced it by famine, and, after holding a council which deposed Benedict and sent him a prisoner to Hamburg, restored Leo VIII. to the papal throne.

But, although the emperor thus disposed of the papacy at his will, his arbitrary exercise of power roused a long and obstinate resistance, which had no slight effect upon the history of the commune. Leo VIII. died in 965, and the imperial party elected John XIII. (965-72).

Upon this the nobles of the national party joined the people and there was a general revolt. The nobles were led by Pietro, prefect of Rome. As we have noted, this office seemed to be extinct during the Carolingian rule, but we again meet with it in 955, after an interval of a century and a half. The leaders of the people were twelve *decarconi*, a term of unknown derivation, but probably indicating chiefs of the twelve regions (*dodecarchi*, *dodecarconi*, *decarconi*). The new pope was seized and confined, first in the castle of St Angelo, then in a fortress in the Campagna. But the emperor quickly marched an army against Rome, and this sufficed to produce a reaction which recalled the pope (November 966), sent the prefect into exile, and put several of the rebellious nobles to death. And shortly after the emperor sacked the city. Many Romans were exiled, some tortured, others, including the twelve *decarconi*, killed. John XIII. died in 972 and Otto in 973.

All these events clearly prove how great a change had now taken place in the conditions of Rome. The people (*plebs*) had made its appearance upon the stage; the army had become democratic; the twelve regions were regularly organized under leaders. Opposed to them stood the nobles, headed by the prefect, also a noble, precisely as in Florence the nobles and the *podestà* were later opposed to the *gilds* and the people. So far, it is true, nobles and people had made common cause in Rome; but this harmony was soon to be interrupted. The feudal spirit had made its way among the Roman aristocrats, had split them into two parties and diminished their strength. It was now destined to spread, and, as it was always vigorously detested and opposed by the people elsewhere in Italy, so the same consequence was inevitable in Rome. Another notable change, and a subject of unending controversy, had also occurred in the administration of justice. So far there were the *judices de clero*, also known as

ordinary or palatine judges, and the *judices de militia*, also styled *consules* or *duces*. These judges generally formed a court of seven, three being *de clero*, four *de militia*, or vice versa, under the presidency of the papal or imperial *missi*. In criminal cases the *judices de militia* had the prefect or the imperial *missus* for their president. But there was a third order of judges called *pedanei*, a *consulibus creati*. It seems clear that the *duces*, being *distributi per iudicatus*, found themselves isolated in the provinces, and to obtain assistance nominated these *pedanei*, who were legal experts. In Rome, with its courts of law, they were less needed, but possibly in those sections of the city where cases of minor importance were submitted to a single magistrate reference was made to the *pedanei*. But many changes were made under the Franks, and when the edict of Lothar (824) granted free choice of either the Roman or Germanic law, and the *duces* were replaced by *comites* and *gastaldiones*, chiefly of German origin, the use of legal experts became increasingly necessary. And the custom of employing them was the more easily diffused by being already common among the Franks, whose *scabini* were legal experts acting as judges, though not qualified to pass sentence. Thus the *pedanei* multiplied, came to resemble the *scabini*, and were designated *judices dativi* (a magistratus dati) or simply *dativi*. These were to be found in the exarchate in 838, but not in Rome until 961, when the *judices de militia* had ceased to exist. The great progress of the German legal procedure may then have contributed to the formation of the new office.

Meanwhile Pope John XIII. had been succeeded by Benedict VI. (973-74) and Otto I. by his son Otto II., a youth

Another revolution.

Judices dativi.

Rising importance of the people.

Otto I. crowned emperor.

of eighteen married to the Byzantine princess Theophano. Thereupon the Romans, who had supported the election of another pope, and were in no awe of the new emperor, rose to arms under the command of Crescenzio, a rich and powerful noble. They not only seized Benedict VI. by force, but strangled him in the castle of St Angelo. The national and imperial parties then elected several popes who were either exiled or persecuted, and one of them was said to be murdered. In 985 John XV. was elected (985-96). During this turmoil, the national party, composed of nobles and people, led by Giovanni Crescenzio, son of the other Crescenzio mentioned above, had taken complete possession of the government. This Crescenzio assumed the title of patrician, and sought to imitate Alberic, although far his inferior in capacity. Fortunately for him, the reigning pope was a detested tyrant, and the emperor a child entirely guided by his mother. But the new emperor Otto III. was backed by a powerful party, and on coming to Rome in 996 was able, although only aged fifteen, to quell the rebellion, oust Crescenzio from public life, and elect as successor to John XV. his own cousin, Pope Gregory V. (996-99). But this first German pope surrounded himself with compatriots, and by raising them to lofty posts even in the tribunals excited a revolt that drove him from the throne (20th September 999). Crescenzio, being master of the castle of St Angelo, resumed the title of patrician or consul of the Romans, expelled the German judges, reconstituted the government, prepared his troops for defence, and created a new pope. But the following year Otto III. came to Rome, and his party opened the gates to him. Although deserted by nearly all his adherents, Crescenzio held the castle valiantly against its besiegers. At last, on the 29th of April 998, he was forced to make terms, and the imperialists, violating their pledges, first put him to torture and then hurled him from the battlements. Gregory V. dying shortly after these events, Sylvester II., another native of southern France, who had been tutor to the emperor Otto III., was raised to the papacy (999-1003).

Thus Otto III. was enabled to establish his mastery of Rome. But, as the son of a Greek mother, trained amid Greek influences, his fantastic and contradictory nature seemed only to grasp the void. He wished to reconstitute a Romano-Byzantine empire with Rome for his capital. His discourse always turned on the ancient republic, on consuls and senate, on the might and grandeur of the Roman people; and his edicts were addressed to the senate and the people. The senate is now constantly mentioned, and its heads bear the title of consuls. The emperor also gave renewed honour to the title of patrician, surrounded himself with officials bearing Greek and Roman designations, and raised the prestige of the prefect, who, having now almost the functions of an imperial vicar, bore the eagle and the sword as his insignia. Nevertheless Otto III. was thoroughly German, and during his reign all Germanic institutions made progress in Rome. This was particularly the case with feudalism, and Sylvester II. was the first pope to treat it with favour. Many families of real feudal barons now arose. The Crescenzi held sway in the Sabine hills, and Praeneste and Tusculum were great centres of feudalism in the 11th century. The system of feudal benefits was recognized by the church, which made grants of lands, cities and provinces in the feudal manner. The bishops, like feudal barons, became actual counts. And, in consequence of these changes, when the emperor, as head of the feudal system, seeks to impose his will upon the church (which has also become feudal) and control the papal elections, he is met by the great question of the investitures, a question destined to disturb the whole world. Meanwhile the Roman barons were growing more and more powerful, and were neither submissive nor faithful to the emperor. On the contrary, they resented his attitude as a master of Rome, and, when he subjected Tivoli to the Holy See, attacked both him and the pope with so much vigour as to put both to flight (16th February 1001). Thereupon Rome again became a republic, headed by Gregory of

Tusculum, a man of a powerful family claiming descent from Alberic.

By the emperor's death in January 1002 the race of the Ottos became extinct, the papacy began to decline, as at the end of the Carolingian period, and the nobles, divided into an imperial and a national party, were again predominant. They reserved to themselves the office of patrician, and, electing popes from their own ranks, obtained enlarged privileges and power. At the time when Ardoin, marquis of Ivrea, profiting by the extinction of the Ottos and the anarchy of Germany, was stirring Italy in the vain hope of constituting a national kingdom, the Roman Republic was being consolidated under another Giovanni Crescenzio, of the national faction. He was now elected patrician; one of his kinsmen was invested with the office of prefect, and the new pope John XVIII. (1003-9) was one of his creatures. Although the power of Henry of Bavaria was then gaining ascendancy in Germany, and giving strength to the imperialist nobles, Crescenzio still remained supreme ruler of the city and the Campagna. Surrounded by his judges, the senators and his kinsman the prefect, he continued to dispense justice in his own palace until his death in 1012, after ten years' rule. And, Pope Sergius IV. having died the same year, the counts of Tusculum compassed the election of Benedict VIII. (1012-24), one of their own kin. This pope expelled the Crescenzi, changed the prefect and reserved the title of patrician for Henry II., whom he consecrated emperor on the 14th February 1014. A second Alberic, bearing the title of "eminentissimus consul et dux," was now at the head of the republic and dispensed *placita* in the palace of his great ancestor, from whom the counts of Tusculum were also descended.

The new emperor endeavoured to re-establish order in Rome, and strengthen his own authority together with that of the pope. But the nobles had in all things the upper hand. They were regularly organized under leaders, held meetings, asserted their right to nominate both pope and emperor, and in fact often succeeded in so doing. Even Henry II. himself was obliged to secure their votes before his coronation. The terms senate and senator now recur still more frequently in history. Nevertheless, Benedict VIII. succeeded in placing his own brother, Romano, at the head of the republic with the title of "consul, dux and senator," thus making him leader of the nobles, who met at his bidding, and chief of the militia and the tribunals. The prefect still retained his authority, and the emperor was by right supreme judge. But, a violent revolt breaking out, the emperor only stayed to suppress it and then went to Germany in disgust. The pope, aided by his brother, conducted the government with energy; he awed the party of Crescenzio, and waged war against the Saracens in the south. But he died in 1024, and in the same year Henry II. was succeeded by Conrad II. There was now beheld a repetition of the same strange event that had followed the death of Alberic, and with no less fatal consequences. Benedict's brother Romano, head of the republic, and still retaining office, was, although a layman, elected pope. He took the name of John XIX. (1024-33), and in 1027 conferred the imperial crown on Conrad the Salic, who, abolishing the Lothairian edict of 824, decreed that throughout Rome and its territory justice should be henceforth administered solely by the Justinian code. Thus, notwithstanding the spread of feudalism and Germanic procedure, the Roman law triumphed through the irresistible force of the national character, which was already manifested in many other ways.

Meanwhile John XIX. was succeeded by his nephew, Benedict IX. (1033-45), a lad of twelve, who placed his own brother at the head of the republic. Thus church and state assumed the aspect of hereditary possessions in the powerful house of the counts of Tusculum. But the vices and excesses of Benedict were so monstrous that the papacy sank to the lowest depth of corruption; there followed a series of tumults

The second Giovanni Crescenzio.

Henry II.

and reactionary attempts, and so many conflicting elections that in 1045 three popes were struggling for the tiara in the midst of scandal and anarchy. The streets and neighbourhood of Rome swarmed with thieves and assassins; pilgrims were plundered; citizens trembled for their lives; and a hundred petty barons threatened the rival popes, who were obliged to defend themselves by force. This state of things lasted until Henry III. came to re-establish order. He appointed a synod to depose the three popes, and then, with the consent of the wearied and anarchy-stricken Romans, assuming the right of election, proposed a German, Clement II., who was consecrated at Christmas 1046. Henry III. was then crowned, and also took the title of patrician. Thus the emperor was lord over church and state. This, however, stirred both people and pope against him, and led to the terrible contest of the investitures, although for the moment the Romans, being exhausted by past calamities, seemed not only resigned but contented.

In fact, the idea of reform and independence was already germinating in the church and was soon to become tenacious and irresistible. Hildebrand was the promoter and hero of this idea. He sought to abolish the simony and concubinage of the priesthood, to give the papal elections into the hands of the higher ecclesiastics, and to emancipate the church from all dependence on the empire. Henry III. procured the election of four German popes in succession, and Hildebrand was always at hand to inspire their actions and dominate them by his strength of intellect and still greater strength of will. But the fourth German pope, Victor II., died in 1057, and Henry III. had been succeeded in 1056 by the young Henry IV. under the regency of a weak woman, the empress Agnes. Hildebrand seized this favourable moment for trying his strength and procured the election of Stephen IX. (1057-58), a candidate he had long had in view. Stephen, however, died in 1058; the nobles instantly rose in rebellion; and Gregory of Tusculum, who had assumed the patriciate, caused an incapable cousin to be named pope (Benedict X.). Upon this Hildebrand postponed his design of maintaining the papacy by the help of Italian potentates and had recourse to the empress. In a synod held at Siena with her consent Benedict was deposed and Nicholas II. (1059-61) elected in his stead. This pope entered Rome escorted by the troops of Godfrey of Tuscany, and, when also assured of help from Naples, assembled a council of one hundred and thirteen bishops (1059), who condemned the deposed pontiff and renewed the prohibition of simony and concubinage among the priesthood. Finally Nicholas instituted the college of cardinals, entrusting it with the election of the pope, who was in future to be chosen from its ranks. The assent of the clergy and people was left purely formal. The decree also contained the proviso—"saving the honour and reverence due to the emperor"; but this too was an empty expression.

The new decree was a master-stroke of Hildebrand's genius, for by means of it he placed the papal election in the hands of a genuine ecclesiastical senate and gave a monarchical form to the church. Backed by the Normans who were in Rome, and whose commander, Richard of Capua, did not scruple to strike off the heads of many recalcitrant nobles, Hildebrand and the pope could now pursue their work of reform. Nevertheless the nobles again revolted on the death of Nicholas II. in 1061, and declared their purpose of restoring to Henry IV. the patriciate and right of election; but Hildebrand, by speedily convoking the cardinals, procured the election of Alexander II. (1061-73). This pope, although friendly to the empire, did not await the imperial sanction, but, protected by the Romans, at once entered the Lateran and put some other riotous nobles to death. The German bishops, however, elected Honorius II., who had the support of the barons. Thus the city was split into two camps and a deadly civil war ensued, terminating, despite the vigorous resistance of the nobility, in the defeat of Honorius II. But the nobles persevered in

the contest and were the real masters of Rome. By conferring the patriciate on the emperor, as their feudal chief, they hoped to organize themselves under the prefect, who now, with greatly increased authority, presided over both the civil and criminal courts in the absence of the pope's representative. In a general assembly the Romans elected their prefect, whose investiture was granted by the emperor, while the pope elected another. Thus disorder was brought to a climax.

Alexander died on the 21st April 1073, and thereupon Hildebrand was at last raised to the chair as pope Gregory VII. (1073-85). He reconfirmed his predecessors' decrees, dismissed all simoniacal and non-celibate priests, and then in a second council (1075) forbade the clergy to receive investiture at the hands of laymen. No bishop nor abbot was again to accept ring or crozier from king or emperor. Now, as ecclesiastical dignities included the possession of extensive benefices, privileges and feudal rights, this decree gave rise to tremendous dispute and to fierce contest between the empire and the church. The nobles took a very decided part in the struggle. With Cenci, their former prefect, at their head, they rose in revolt, assailed the pope on Christmas day 1075, and threw him into prison. But their fear of the popular wrath compelled his speedy release; and he then decreed the excommunication and deposition of the emperor who had declared him deposed. That monarch afterwards made submission to Gregory at Canossa (1077), but, again turning against him, was again excommunicated. And in 1081 he returned to Italy bringing the antipope Clement III., and besieged Rome for forty days. Assembling the nobles in his camp, he there arranged a new government of the city with prefect and senate, palatine judges and other magistrates, exactly similar to the existing government within the walls. He then took his departure, returned several times in vain, but at last forced his way into the city (March 1084) and compelled Gregory VII. to seek refuge in the castle of St Angelo. The emperor was then master of Rome, established the government he had previously arranged and, calling a parliament of nobles and bishops, procured the deposition of Gregory and the consecration of Clement III., by whom he was crowned in 1084. He then attacked and seized the Capitol, and assaulted the castle in order to capture the pope. But Robert Guiscard brought his army to the rescue. Emperor and antipope fled; the city was taken, the pope liberated and Rome reduced to ruin by fire and pillage. Upon this Gregory VII., broken with grief, went away with the Normans, and died at Salerno on the 25th May 1085. He had separated the church from the people and the empire by a struggle that, as Gregorovius says, disturbed the deep sleep of the middle ages.

Pope Paschal II. (1099-1118) found himself entirely at the mercy of the tyrannous nobles who were alike masters of Rome, of its government, and its spiritual lord. As they were divided among themselves, all the pope could do was to side with one party in order to overcome the other. With the help of his own nephew Gualfredo, the prefect Pietro Pierleone, and the Frangipani, he was able to keep down the Corsi, and hold the Colonna in check. Being compelled to repair to Benevento in 1108, he left Gualfredo to command the militia, Tolomeo of Tusculum to guard the Campagna, and the consuls Pierleone and Leone Frangipani, together with the prefect, in charge of the government. The consulship was no longer a mere title of honour. The consuls seem to have been elected, as at Ravenna, in imitation of those of the Lombard cities, and were at the head of the nobles and senate. The expressions "præfectus et consules," "de senatoribus et consulis," are now of frequent occurrence. We have no precise knowledge of the political organization of the city at this moment; but it was an aristocratic government, similar to that originally formed in Florence, as Villani tells us, with a senate and consuls. The nobles were so completely the masters that the pope, in spite of having trusted them

Gregory VII.

Hildebrand and the question of investiture.

Paschal II. and the nobles.

with the government, could only return to Rome with the aid of the Normans. Being now absorbed in the great investiture question, he had recourse to a daring plan. He proposed to Henry V. that the bishops should resign all property derived from the crown and depend solely on tithes and donations, while the empire should resign the right of investiture. Henry seemed disposed to accept the suggestion, but, suddenly changing his mind, took the pope prisoner and forced him to yield the right of investiture and to give him the crown (1111). But the following year the party of reform annulled in council this concession, which the pope declared to have been extorted by force. By the death of Countess Matilda in 1115 and the bequest of her vast possessions to the Holy See, the pope's dominions were greatly enlarged, but his authority as a ruler was nowise increased. Deeds of violence still continued in Rome; and then followed the death of the prefect Pietro. The nobles of the imperial party, joined with the people, wished to elect Pietro's son, also nephew to Tolomeo of Tusculum, who then held the position of a potent imperial margrave, had territories stretching from the Sabine mountains to the sea, was the dictator of Tusculum, master of Latium and consul of the Romans. The pope opposed this election to the best of his strength; but the nobles carried the day, and their new prefect received investiture from the emperor. Upon this the pope again quitted Rome, and on his return, two years later, was compelled to shut himself up in the castle of St Angelo, where he died in 1118.

The popes were now the sport of the nobles whom they had aggravated by continual concessions for the sake of peace. And peace seemed at hand when Innocent II. (1130-43), after triumphing over two antipopes, came to terms with Roger I., recognized him as king of Sicily, and gained his friendship and protection. But now still graver tumults took place. In consequence of the division of the nobles neither party could overcome its foes without the aid of the people, which thus became increasingly powerful. Throughout upper and central Italy the cities were being organized as free and independent communes on a democratic basis. Their example soon followed in the ancient duchy of Rome and almost in the immediate neighbourhood of the city. Even Tivoli was converted into a republic. This excited the deepest jealousy in the Romans, and they became furious when this little city, profiting by its strong position in the Tevere valley, not only sought to annex Roman territory, but dared to offer successful resistance to the descendants of the conquerors of the world. In 1141 Tivoli openly rebelled against the mother city, and the pope sent the Romans to subdue it. They were not only repulsed, but ignominiously pursued to their own gates. Afterwards, returning to the assault in greater numbers, they conquered the hostile town. Its defenders surrendered to the pope, and he immediately concluded a treaty of peace without consulting either the people or the republic. The soldiery, still flushed with victory, were furious at this slight. They demanded not only submission of Tivoli to the Roman people, but also permission to demolish its walls and dwellings and expel its population. Innocent II. refused consent to these excesses, and a memorable revolution ensued by which the temporal power of the papacy was entirely overthrown.

In 1143 the rebellious people rushed to the Capitol, proclaimed the republic, reconstituted the senate, to the almost entire exclusion of the nobles, declared the abolition of the temporal power, issued coin inscribed to the senate, the people and St Peter, and began to reckon time from the day of the restoration of liberty. Arnold of Brescia was not, as has been incorrectly stated, the author of this revolution, for he had not yet arrived in Rome. It was the outcome of an historic necessity—above all, of the renewed vigour of the people and its detestation of the feudal aristocracy. This body, besides being divided into an imperial and a national party, had almost excluded from the government the powerful baronage of the Campagna

and the provinces. Also, as we have before noted, the Roman aristocracy was by no means an exclusive caste. Between the great aristocrats and the people there stood a middle or new nobility, which made common cause with the people, whose chief strength now lay in the army. This, divided into twelve and then into thirteen or fourteen regions, assembled under its banners all arm-bearing citizens. Thus the *exercitus* was also the real *populus Romanus*, now bent on the destruction of the temporal power. This purpose, originating in the struggle of the investitures, was the logical and inevitable result of the proposals of Paschal II., which, despite their rejection, found a loud echo in Italy. Lucius II. (1144-45) tried to withstand the revolution by seeking Norman aid and throwing himself into the arms of the feudal party, but this only precipitated the course of events. The people, after having excluded nearly all aristocrats from the senate, now placed at its head the noble Giordano dei Pierleoni, who had joined the revolutionary party. They named him patrician, but without prejudice to the authority of the empire, still held by them in respect, and also conferred on him the judicial powers appertaining to the aristocratic and imperial office of prefect. The pope was requested to resign the temporal power, the regalia and every other possession, and content himself with the tithes and offerings of the faithful according to the scheme of Paschal II. He indignantly refused, marched at the head of the nobles against the Capitol, but was violently repulsed, and received a blow on the head from a stone, which is supposed to have occasioned his speedy death on the 15th February 1145. Eugenius III. was then elected (1145-53), but soon had to fly to Viterbo in quest of armed assistance, in consequence of the senate's resolve to prevent his consecration by force until he recognized the new state of things in the Eternal City.

It was at this moment that Arnold of Brescia arrived in Rome. His ideas, already well known in Italy, had inspired and promoted the Roman revolution, and he now came to determine its method and direction. Born at Brescia in the beginning of the 12th century, Arnold had studied in France under the celebrated Abelard, who had instructed him in theology and philosophy, inspired him with a great love for antiquity, and stimulated his natural independence of mind. On returning to his native land he assumed the monkish habit, and proved the force and fervour of his character by taking part in all struggles for liberty. And, together with political reform, he preached his favourite doctrine of the necessary renunciation by the clergy of all temporal wealth. Expounded with singular eloquence, these doctrines had a stirring effect on men's minds, spread throughout the cities of northern Italy, and were echoed on all sides. It seems undoubted that they penetrated to Rome and helped to promote the revolution, so that Arnold was already present in spirit before he arrived there in person. It is known that at the Lateran council of 1139 Innocent II. had declared these doctrines to be inimical to the church and enjoined silence on their author. And, as at that time the party hostile to liberty was triumphant in Brescia, Arnold left his native place, crossed the Alps and returned to France, where other struggles awaited him. He professed no anti-Catholic dogmas,—only maintaining that when the pope and the prelate deviated from the gospel rule of poverty they should not be obeyed, but fearlessly opposed. In France, finding his master, Abelard, exposed to the persecutions of St Bernard, he assumed his defence with so much ardour that St Bernard directed the thunders of his eloquence against the disciple as well as the master, saying of the former, "He neither eats nor drinks, suffers hunger, and, being leagued with the devil, only thirsts for the blood of souls." In 1142 we find Arnold a wanderer in Switzerland, and then, suddenly reappearing in Italy, he arrived in Rome.

Three different elements entered into his nature and inspired his eloquence—an exalted and mystic temperament, a great and candid admiration for classic antiquity added to an equal admiration for republican freedom independent of the church

New
power
of
the
people.

Arnold
of
Brescia.

Popular
revolution.
Reconstruction
of senate
and
republic.

and the empire, and a profound conviction, derived from the Vaudois and Paterine doctrines, that the church could only be purified by the renunciation of temporal wealth. Finding Rome already revolutionized in accordance with his own ideas, he immediately began to preach there. His mystic exhortations against the riches of the church had an inflammatory effect, while his classical reminiscences aroused the enthusiasm of the Romans, and his suggestion that they should imitate the republican institutions of upper Italy met the necessities of the time that had created the revolution. He urged the reconstitution of the ancient senate and senatorial order, which indeed was already partially accomplished, and of the ancient equestrian order, and the reconstruction and fortification of the Capitol. His proposed senate was a body somewhat resembling the communal councils of upper Italy, his equestrian order a mounted force composed of the lesser nobility, since at Rome, as elsewhere, the lower classes had neither time nor means to form part of it. All his suggestions were accepted; the citizens laboured strenuously on the fortification of the Capitol. The pope soon beheld the revolution spread beyond the walls, and several cities of the state proclaimed their independence. The barons of the Campagna profited by the opportunity to act as independent sovereigns. Thus the whole domain of the church was threatened with dissolution. The pope marched towards Rome with his newly gathered army, but hoped to come to terms. The Romans in fact recognized his authority, and he in his turn recognized the republic. The office of patrician was abolished, and seems to have been replaced by that of gonfalonier, and the prefect, answering to the podestà of the other republics, was revived. The senators received investiture from the pope, who returned to Rome at Christmas 1145.

There public now seems to have been fully constituted. The senate was drawn from the lower classes and the petty nobility, and this was the special characteristic of the new revolution. In 1144 there were fifty-six senators, probably four to each of the fourteen regions, but the number often varied. By the few existing documents of the period we notice that the senators were divided into *senatores consiliarii* and ordinary senators. The former constituted a smaller council, which, like the *credenza* or lesser council found in other cities, consulted with the head or heads of the republic on the more urgent and secret affairs of the state. And, conjointly with the rest of the senators, it formed the greater council. Thus classic traditions were identified with new republican usages, and the commonwealth of Rome resembled those in other parts of Italy. But, of course, every republic had special local customs of its own. So the Roman senate had judicial as well as political attributes, and there was a *curia senatus* composed of senators and legal experts.

As was easily to be foreseen, the agreement with the pope was of short duration. The revolution could not be checked; the Romans desired independence, and their spiritual lord fled to France, whence, in 1147, he proclaimed a new crusade, while the Romans were employed in demolishing Tivoli, banishing its inhabitants, and waging war on other cities. Giordano Pierleone was gonfalonier and head of the republic, and Arnold, supported by the popular favour and the enthusiasm of the lower clergy, was preaching with even greater fervour than before. But the pope now re-entered Italy, proclaimed Arnold a schismatic, and then advancing to Tusculum assembled an army in order to attack Rome. In this emergency the Romans applied to Conrad III., the first emperor of the house of Hohenstaufen; and their urgent letters are clearly expressive of Arnold's theories and his medley on ancient and modern, sacred and profane, ideas. "Rome," so they said, "is the fountain of the empire conceived to you by the Almighty, and we seek to restore to Rome the power possessed by her under Constantine and Justinian. For this end we conquered and destroyed the strongholds of the barons who, together with the pope and the Normans, sought to resist us. These are now attacking us on all sides. Haste to Rome, the capital of the world, thus to

establish thy imperial sway over the Italian and German lands."

After long hesitation the king of the Romans at last replied to these appeals, stating that he would come "to re-establish order, reward the faithful, and punish the rebellious." These words promised ill. In fact Conrad had already arranged terms with the pope; but his life came to an end on the 15th of February 1152.

He was succeeded by Frederick I. surnamed Barbarossa, who took no notice of the numerous letters urging him to come and receive the empire from the Roman people, which alone had the right of conferring it. In accordance with his design of subduing all the independent cities, he made an agreement with the pope, in which he vowed to give no truce to the Romans, but subject them to their spiritual lord, whose temporal power should be restored. The pope, on his side, promised to crown him emperor. Thereupon the people again rose to arms, and Arnold broke off all negotiations with Eugenius III. The senate was reorganized, formed of one hundred members, and, according to the old Roman precedent, had two consuls, one for internal and the other for external affairs. Frederick was a daring statesman, a valiant soldier in command of a powerful army, and was no friend of half measures. Accordingly the nobles ventured on reaction. Finally, to increase the gravity of the situation, an English pope, Adrian IV., was elected (1154-59), who was also a man of strong and resolute temper. In fact, even before being able to take possession of the Lateran, he requested the Romans to banish Arnold, who, with greater eloquence than ever, was directing his thunders against the papacy. These utterances increased the wrath of Adrian, who, encouraged by the knowledge that Frederick and his host were already in Italy, at last launched an interdict against Rome. It was the first time that a pope had ventured to curse the Eternal City. The interdict put a summary stop to the religious life of the inhabitants. Men's minds were seized with a sudden terror, and a fierce tumult broke out. Thereupon the senators, whose opposition to the pope was less courageous than that of the fallen magnates, prostrated themselves at his feet and implored pardon. But Adrian demanded the expulsion of Arnold before consenting to raise the interdict. Arnold was therefore obliged to leave Rome. After having for nine years preached successfully in favour of liberty, after having been the moving spirit of the new revolution, the new constitution, he was now abandoned by all, and forced to wander from castle to castle, in the hope of reaching some independent city capable of shielding him from the fierce enmity of the pope. Meanwhile Frederick I. had achieved his first victories in Lombardy, and, leaving ruined cities and bloodshed in his track, was rapidly advancing towards central Italy. The pope sent three cardinals to him, with a request for the capture and consignment of Arnold, who had taken refuge in the castle of the Visconti of Campagnatico. Frederick without delay caused one of the Visconti to be seized and kept prisoner until Arnold was given up, and then consigned the latter to the papal legates. The pope in his turn gave the reformer into the hands of the prefect, Pietro di Vico, who immediately hanged his prisoner, burnt his body at the stake and cast his ashes into the Tiber. The execution took place in June 1155. The exact date and place of it are unknown; we only know that Arnold met his fate with great serenity and firmness.

But the Romans who had so basely deserted their champion would not give up their republic. Their envoys went to meet Frederick near Sutri, and made an address in the usual fantastic style on the privileges of the Roman people and its sole right to confer the imperial crown. But Frederick indignantly cut short their harangue, and they had to depart full of rage. He then continued his march, and, entering Rome on the 18th of June 1155, was forthwith crowned in St Peter's by the pope. Thereupon the Romans rushed to arms, and made a furious attack on the Leonine city and the imperial camp. A desperate battle went on throughout the day; and the knights proved that the equestrian order instituted at Arnold's suggestion was no empty

Frederick I.

Arnold's execution.

sham. About a thousand Romans perished by the sword or by drowning, but their fellow-citizens made such determined preparations to continue the struggle that Frederick, on the 19th of June, hastily retreated, or rather fled, and was escorted as far as Tivoli by the pope and the cardinals. After all, the temporal power of the papacy was not restored, and the republic still survived in the form bestowed on it by Arnold of Brescia.

The republic still remains. Its existence was in truth favourable rather than injurious to Frederick, whose aim was to rule over Rome and treat the bishops as his vassals. He had not yet discerned that his best policy would have been to use the republic as a lever against the pope. The latter, with keener acumen, while remaining faithful to the feudal party in Rome, made alliance with the communes of Lombardy and encouraged them in their resistance to the emperor. Adrian IV. died in 1159, and the national party elected Alexander III. (1159-81), who energetically opposed the pretensions of Frederick, but, having to struggle with three antipopes successively raised against him by the imperial party, was repeatedly driven into exile. During these schisms the senate quietly carried on the government, administered justice, and made war on some neighbouring cities and barons. An army comprising many nobles of the national party marched against Tusculum, but found it defended by several valiant officers and a strong band of German soldiery, who, on the 20th of May 1167, inflicted on the Romans so severe a defeat that it is styled by Gregorovius the Cannae of the middle ages. Shortly afterwards the emperor arrived in Rome with his antipope Paschal III., and Alexander had to fly before him to Benevento. Then, at last, Frederick came to terms with the republic, recognized the senate, which accepted investiture at his hands, re-established the prefecture as an imperial office, and bestowed it on Giovanni, son of Pietro di Vico. He then hastily departed, without having advanced outside the Leonine city.

Meanwhile Pope Alexander continued the crafty policy of Adrian and with better success, for the Lombard cities had now formed a league and inflicted a signal defeat on the emperor at Legnano on the 29th of May 1166. One of the results of this battle was the conclusion of an agreement between the pope and the emperor, the latter resigning his pretensions on Rome and yielding all that he had denied to Adrian. And by the treaty of Venice (1st of August 1177) the antipope was forsaken, Alexander III. recognized and hailed as the legitimate pontiff, and the prefect of Rome again nominated by the pope, to whom the emperor restored the temporal power, acknowledging him the independent sovereign of Rome and of the ecclesiastical state, from Acquapendente to Ceprano. Frederick's troops accompanied the pope to Rome, where the republic was forced to make submission to him. But, proudly conscious as it still was of its strength, its surrender wore the aspect of a voluntary concession, and its terms began with these words: "Totius populi Romani consilio et deliberatione statutum est," &c. The senators, elected yearly in September, had to swear fealty to the pope, and a certain proportion of nobles was included in their number. On his return to Rome, Alexander received a solemn welcome from all, but he had neither extinguished nor really subdued the republic. On the contrary, men's minds were more and more inflamed by the example of freedom displayed in the north of Italy. He died on the 30th of August 1181. The fact that between 1181 and 1187 there were three popes always living in exile proves that the republic was by no means crushed. During the same period another blow was inflicted on the papacy by the marriage of Henry VI., son and successor to Frederick I., with Constance, sole heiress of the Norman line in Naples. For thus the kingdom was joined to the empire, and the popes were more than ever in the latter's power. On the 20th of December 1187 Clement III. (1187-91), being raised to the pontificate, made a solemn agreement with the government of the Capitol before coming to Rome. And this peace or *concordia* had the air of a treaty between potentates of equal importance. Rome confronted

the pope from the same standpoint from which the Lombard cities had confronted the emperor after Legnano. This treaty, the basis of the new constitution, was confirmed on the last day of May 1188 (Anno XLIV. of the senate). It begins with these words: "Concordia inter Dominum Papam Clementem III. et senatores populumque Romanum super regalibus et aliis dignitatibus urbis." The pope was recognized as supreme lord, and invested the senators with their dignity. He resumed the privilege of coinage, but allowed one-third of the issue to be made by the senate. Almost all the old pontifical rights and prerogatives were restored to him. The pope might employ the Roman militia for the defence of his patrimony, but was to furnish its pay. The rights of the church over Tivoli and Tusculum were confirmed; but the republic reserved to itself the right of making war on those cities, and declared its resolve to dismantle and destroy the walls and castle of Tusculum. In this undertaking the pope was to co-operate with the Romans, even should the unhappy city make surrender to him alone.

From all this it is clear, that the church had been made independent of the empire, and that the republic, despite its numerous concessions, was by no means subject to the church. The pope, in fact, had obtained liberty of election, and Frederick I., by resigning the investiture of the prefect, had virtually renounced his claim to imperial power in Rome. The republic had no patrician nor any other imperial magistrate, and preserved its independence even as regarded the pope, who merely granted investiture to magistrates freely chosen by the people, and had no legislative nor administrative power in the city. His temporal dominion was limited to his great possessions, to his regalia, to a supreme authority that was very indefinite, and to a feudal authority over the barons of the Campagna and many cities of a state that seemed ever on the point of dissolution. The senate continued to frame laws, to govern, and to administer justice. The army carried on the wars of the republic, as we see by the tragic fate of Tusculum, which was razed to the ground on the 19th of April 1191. Thus the powerful counts of Tusculum disappeared; they sought refuge in the Campagna, and according to all probability the no less potent family of the Colonna sprang from their line. In consequence of these events, the nobles realized that the papacy sought to reduce them to vassalage. And, seeing that the republic remained firmly established and able to help them, they began to adhere to it and succeeded in obtaining admission to the new senate. In fact, whereas since 1143 plebeians and petty nobles had prevailed in its ranks, nobles of ancient descent are now found outnumbering the knights and burghers. But in 1191 this state of things caused a sudden popular outbreak which abolished the aristocratic senate and gave the headship of the republic to a single senator, *summus senator*, named Benedetto "Carissimus" or "Carus Homo" or "Carosomo," of unknown, but undoubtedly plebeian, origin. During the two years he remained in office this personage stripped the pope of his revenues, despatched *justitiarum* even to the provinces, and with the aid of the parliament and other popular assemblies promulgated laws and statutes. But he was overthrown by a counter-revolution, and Giovanni Capoccio of the party of the nobles became senator for two years, and had been succeeded by one of the Pierleoni when, in 1197, a fresh revolution re-established a senate of fifty-six members, chiefly consisting of feudal barons in high favour with Henry VI., who had revived the imperial faction in Rome. But this emperor's life ended the same year as the pope's, in 1198, and the new pontiff, Innocent III. (1198-1216), began to make war on the nobles, who were again masters of the republic. Their leader was the prefect Pietro di Vico. Owing to the revolution of 1143, most of the prefectorial attributes were now vested in the senate; nevertheless, Pietro still retained a tribunal of police both within and without the

Rome independent of the empire.

The nobles re-enter the senate.

Popular revolution and counter-revolution of the aristocracy.

city. But his main strength was derived from the vast possessions of the Vico family, in which the office of prefect now became hereditary. Very soon, however, these prefects of Vico were chiefly regarded as the great feudal lords of Tuscia, and the independent municipal office lost its true character. Then the popes made a point of according great pomp and dignity to this nominal prefect, in order to overshadow the senator, who still represented the independence of the republic and had assumed many of the attributes wrested from the prefect.

But Innocent III., dissatisfied with this state of things, contrived by bribing the people to arrogate to himself the right of electing the senator, who had now to swear fealty and submission to the pope, and also that of nominating the provincial *justitiarum*, formerly chosen by the government of the Capitol. This was a deadly blow to the republic, for the principal rights of the people—i.e. the election of pope and emperor, prefect and senate—were now lost. The general discontent provoked fresh revolutions, and Innocent III. employed all his political dexterity to ward off their effects. But shortly afterwards the people made a loud outcry for a senate of fifty-six members; and the pope, again making a virtue of necessity, caused that number to be chosen by twelve *mediani* specially named by him for the purpose. Even this did not calm the popular discontent, which was also stirred by other disputes. The consequence was that when, six months later, the pope again elected a single senator the Romans rose to arms, and in 1204 formed a government of *Buoni Uomini* in opposition to that created by the pope. But an amicable arrangement being concluded, the pope once more nominated fifty-six senators; and when, soon after, he again reduced them to one, the people were too weary to resist (1205). Thus the Capitol was subdued, and Innocent III. spent his last years in tranquility.

On the 22d of November 1200 Honorius III. (1216-27) conferred the imperial crown on Frederick II., who confirmed to the church the possession of her former states, of those bequeathed to her by Countess Matilda, and even of the March of Ancona. But it was soon seen that he sought to dominate all Italy, and was therefore a foe to be dreaded. The successor of Honorius, Pope Gregory IX. (1227-41), was speedily insulted and put to flight by the Ghibelline nobles, whose courage had revived, and the republic began to subdue the Latian cities on its own account. Peace was several times made and unmade by pope and people; but no enduring harmony was possible between them, since the former wished to subject the entire state to the church, and the latter to escape from the rule of the church and hold sway over "the universal land from Ceprano to Radicofani" formerly belonging to the duchy. Accordingly, the Roman people now appointed judges, imposed taxes, issued coin, and made the clergy amenable to secular tribunals. In 1234 the senator Luca Savelli published an edict declaring Tuscia and Campania territories of the republic, and sent judges thither to exact an oath of obedience. He also despatched the militia to the coast, where it occupied several cities and erected fortresses; and columns were raised everywhere inscribed with the initials S. P. Q. R. The pope, unable to prevent but equally unable to tolerate these acts, fled from Rome, hurling his anathema against Savelli, "et omnes illos consiliarios urbis quorum consilio," &c. The Romans sacked the Lateran and the houses of many cardinals, and marched

on Viterbo, but were driven back by the papal troops. When Savelli fled office and Angelo Malabranca was elected in his stead, the people made peace and submission in 1235, and were obliged to give up their pretensions of subjecting the clergy to ordinary tribunals and the urban territory to the republic. Thus matters were virtually settled on the footing established by Innocent III., thanks to the aid given to the pope by Frederick II., who had been one of the promoters of the rebellion.

The
republic
submits
to the
people.

It may appear strange that, at this period of their history, the Romans, after showing such tenacious adherence to the republic and senate, should have accepted the rule of a single senator without rushing to arms, and passed and repassed from one form of government to another with such surprising indifference. But on closer examination it is plain that these changes were greater in appearance than reality. We have already seen, in treating of Carosomo, how the single senator convoked the people in parliament to pass sanction on the laws. But, whenever there is only one senator, we also continually meet with the expression "consilium vel consilia urbis." It is evident that when, instead of laws to be approved in parliament by a simple placet or rejected by a non-placet, matters requiring consideration had to be discussed, the senator convoked a much smaller council, consisting only of the leaders of the people. These leaders were the heads of the twelve or thirteen guilds of the guilds, now becoming organized and soon to be also thirteen in number, and of the militia. As in the other Italian republics, all these associations had been formed in Rome.

The senator therefore held consultation with the leading men of the city; and, although, especially at first, these meetings were rather loosely organized, it is clear that they took the form of two councils—one numerous (*consiglio maggiore*), the other limited (*consiglio minore or speciale*), co-operating with and forming part of the first. Such was the prevailing custom throughout Italy at the time when Roman institutions most nearly resembled those of the other republics. We already know that, from the date of Arnold's reforms, the senate, with its junta of counsellors, had been divided into two parts, forming when united a species of greater council. Therefore the transition from a senate divided into two parts to the greater and lesser councils must have been very easy and natural. And, seeing that later, when the nomination of a single senator had become a constant practice, the meetings of the two councils are frequently mentioned without the slightest remark or hint as to their origin, it is clear that they had been gradually formed and long established. Not long after the revolution of 1143 the grandees sought to re-enter the senate; and the popes themselves, partly from dread of the people and partly to aggrandize their own kindred, contributed to build up the power of a new and no less turbulent nobility. This class, arising between the 12th and 13th centuries, was composed of families newly created by the popes, together with remnants of the old aristocracy, such as the Frangipani, Colonna, &c. These nobles, regaining possession of the senate, so completely eliminated the popular element that, when the popes again opposed them, and, obtaining from the parliament the right of electing the senators, adopted the expedient of appointing one only, the senator was always chosen from the ranks of the nobles. And then the people, unable and unwilling to renounce republican forms, replaced their suppressed senate by a greater and a lesser council. This was an easy task—a natural consequence of the fact that the people now began to constitute the real strength of the republic. Later, with an increasing detestation for their nobility, the Romans decreed that the single senator should be of foreign birth, and, as we shall see, chose Brancaleone in the middle of the 13th century.

Thus, after a long series of frequent changes and revolutions, the Roman republic became a commonwealth, with an increasing resemblance to those of the other Italian cities. The people were organized and armed, the guilds almost established, the two councils gradually constituted, and the aristocracy, while retaining special local characteristics, assumed its definitive shape. It is not surprising to find that the Roman, like other Italian cities, now possessed statutes of its own. There has been much controversy on this point. Certain writers had alluded to a statute of 1246. As no one, however, could discover any statute of that date, others decided that it had never existed. A statute of 1363

was recently published by Professor Camillo Re, who asserted it to be the first and most ancient that Rome had possessed. But the still more recent researches of Messrs La Mantia and Levi prove that Professor Re's assertions were somewhat too bold. There is certain evidence of a *statutum senatus* existing between 1212 and 1227, of a *statutum vel capitulare senatoris vel senatus* of 1235, followed in 1241 by a *statutum urbis*. This brings us very near to the statute of 1246 mentioned by Vitale and others. So it is well ascertained that, in the first half of the 13th century, Rome possessed statutes at large composed of older limited statutes. The consuls of the trade guilds were from 1267 regular members of the councils; and the merchants' guild held general meetings in 1255. Its statutes were confirmed in 1296 by the senator Pandolfo Savelli, and the compilation of these, published in 1880 by Signor Gatti, refers to 1317.

Meanwhile the struggle between Frederick II. and the pope was once more renewed. The former sought to dominate Italy, separate the state from the church, and repress the republics. The latter, although really hostile to the Roman free government, joined it against the emperor, who on his side favoured the republic of Rome and the nobles most adverse to the pope. Thus the new nobility, composed, as we have seen, of two different elements, was again split into a Guelph party headed by the Orsini and a Ghibelline party under the Colonna. And in 1238 it was deemed advisable to elect two senators instead of one, in the hope of conciliating both factions by simultaneously raising them to power. Afterwards one only was elected, alternately an Orsini and a Colonna, then again two, and so on. But all these changes failed in their aims, since the struggle between emperor and pope exasperated party feeling in Rome. Frederick was king of southern Italy and emperor; had he been able to enforce the whole of his authority he would have been absolute master of all Italy, a state of things which the popes could not in any way tolerate. Hence the obstinate and uninterrupted struggle which proved injurious both to the papacy and the empire. The political genius of Frederick might have wrought great harm to the city had not his mind teemed with contradictory ideas. Although desirous to emancipate the state from the church, he was opposed to the communal democracy, which was then the chief strength of the secular state in Italy. While combating the church and persecuting her defenders, he yet set heretics to the stake; although excommunicated, he undertook a crusade; he feasted at his table philosophers, sceptic and atheist poets, bishops and Mussulmans; he proclaimed anti-Christian the possession of wealth by the church, yet made lavish gifts to altar and monastery. Thus, although he had a strong party in Rome, it seemed to dissolve at his approach, inasmuch as all feared that he might abolish the statutes and liberties of the commune. In fact, when he advanced towards Rome on the death of Gregory IX. in 1241 he was energetically repulsed by the people, and later even by Viterbo, a city that had always been faithful to him. But after he had withdrawn, his adherents gained strength and put to flight his opponent, Innocent IV. (1243-54), the newly elected pope, who then from his asylum at Lyons hurled an excommunication against him. Frederick's death in December 1250 determined the fall of the Ghibelline party and the close of the imperial epoch in Italy. The pope instantly returned to Rome with the set purpose of destroying the power of the Hohenstaufens. This was no longer difficult when, by the decease of Conrad IV. (1254), the child Conradin became the last legitimate representative of that line, and negotiations were already on foot for placing the Angevins on the Neapolitan throne.

The republic meanwhile preserved its independence against the pope, who, among other concessions, had entirely given up to it the right of coinage. Nevertheless, being much harassed by the factiousness of the nobility, it was obliged in 1252 to decide on the election of an alien senator armed with ample powers, precisely as other communes gave the government into

the hands of a podestà. Accordingly a Bolognese noble, Brancalione degli Andalò, count of Casalecchio, and a Ghibelline of much energy and talent, was invited to Rome. But before accepting office he insisted on making definite terms. He desired to hold the government for three years; and this, although contrary to the statutes, was granted. Further, to ensure his personal safety, he demanded that many scions of the noblest Roman houses should be sent as hostages to Bologna; and to this also the republic consented. Then, in August 1252, he came with his judges and notaries, made oath to observe justice and the laws, and began to govern. He was head of the republic in peace and in war, supreme judge and captain in chief. He nominated the podestàs of subject territories, despatched ambassadors, issued coin, concluded treaties and received oaths of obedience. The pope, who was then at Perugia, was greatly afflicted by the arrival of this new master, but, despairing of aid from any quarter, was forced to make a virtue of necessity. Thus Brancalione was able to seize the reins of power with a firm grasp. The parliament still met in the square of the Capitol, and the greater and lesser councils in the church of Ara Coeli. There were besides frequent assemblies of the college of Capitoline judges or *assessamentum*. Unfortunately, no records having been preserved of the proceedings of the Roman councils and parliament, little can be said of the manner in which affairs were conducted. Certainly Brancalione's government was not very parliamentary. He convoked the councils as seldom as was possible, although he frequently assembled the people in parliament. The chief complaint made against him was of undue severity in the administration of justice. He rendered the clergy amenable to secular tribunals, subdued the neighbouring cities of Tivoli, Palestrina, &c., and commanded in person the attacking force. But his greatest energy was directed to the repression of the more turbulent nobles who were opposed to him; and he soon made them feel the weight of his hand by hanging some, banishing others, and persecuting several more. But he too recognized the expediency of winning the popular favour. He was the first senator to add to his title that of captain of the people ("Almae Urbis Senator Illi: et Romani Populi Capitaneus"). He befriended the people by promoting the organization of guilds after the manner of those of his native Bologna. There were already a few in Rome, such as the merchants' guild and that of the agriculturists, *Bobacteriorum* or *Bovattari*, who must have resembled the so-called *mercanti di campagna* or graziers of the present day, since no peasant guild existed in Italian republics. The merchants' guild, definitely established in 1255 under Brancalione's rule, had four consuls and twelve councillors, held meetings and made laws. The other guilds, thirteen in all, were organized much on the same plan. The admission of their heads into the councils of the republic in 1267 shows how efficaciously their interests had been promoted by Brancalione.

The death of Innocent IV. and the election of Alexander IV. (1254-61), who was milder and less shrewd than his predecessor, were favourable events for Brancalione; but he failed to check the growing discontent of the clergy and the more powerful nobles, who had received deadly injuries at his hands. And when, on the expiration of his three years' term of office, his re-election was proposed, his enemies rose against him, accused him before the *sindacato*, threw him into prison, and vehemently protested against the continuance of "foreign tyranny." His life was only spared on account of the hostages sent to Bologna. The next senator chosen was a Brescian Guelph, Emanuele de Madio, a tool of the nobles, who were now masters of the situation. But soon afterwards, in 1257, the guilds rose in revolt, drove the nobles from power, put the pope to flight, and recalled Brancalione for another three years' term. He ruled more sternly than before, hung several nobles, and made alliance with Manfred, the representative of the Swabian party in Italy. This rendered him increasingly odious to the pope and procured his excommunication. But, disregarding the

Brancalione degli Andalò, the first foreign senator.

thunders of the church, he marched against Anagni, the pope's birthplace, and Alexander was quickly obliged to humiliate himself before the senator of Rome. Brancalione next set to work to destroy the fortified towers of the nobility, and in razing them to the ground ruined many of the adjacent dwellings. Accordingly, a considerable number of nobles became homeless exiles. In 1258, while engaged on the siege of Corneto, Brancalione was attacked by a violent fever, and, being carried back to Rome, died on the Capitoline Hill. Thus ended the career of a truly remarkable statesman. He was succeeded by his uncle, Castellano degli Andalò, who, lacking the political genius of his nephew, only retained office until the following spring (1259), in the midst of fierce and perpetual disturbances. Then the people, being bribed by the pope, joined with the nobles and drove him away. His life too was saved by having followed his nephew's shrewd plan of sending hostages to Bologna. Two senators of Roman birth were next elected; and on the death of Alexander IV. a French pope was chosen, Urban IV. (1261-64), thus giving fresh predominance in the church to the anti-Swabian policy. But the internal disturbances of the city soon drove Urban to flight.

At this period the fall of the empire had induced many Italian republics to seek strength by placing their governments in the hands of some prince willing to swear respect to their laws and to undertake their defence against neighbouring states and the pope. In Rome the Guelphs and Ghibellines proposed various candidates for this office, and after many fierce quarrels ended by electing a committee of *boni homines*, charged with the revision of the statutes, reorganization of the city, and choice of a senator. This committee sat for more than a year without nominating any one, so, the Guelph party being now predominant, and all being wearied of this provisional state of things, the majority agreed on the election as senator of Charles of Anjou, who, at the pope's summons, was already preparing for the conquest of Naples. The Romans thought that he would defend Rome against the pope, and the pope would defend Rome against him; and by thus taking advantage of either's jealousy the citizens hoped to keep their republic intact. In fact, although Urban IV. had incited Charles to attack Naples, he was by no means willing to see him established as master in Rome. He accordingly declared that, if Charles really wished to obtain the Neapolitan crown, he must only accept the offered dignity pending the conquest of that kingdom. And he must likewise promise to recognize the supremacy of the pope over the senate. Charles soothed him with the amplest verbal promises, but in fact accepted the senatorship for life. In 1265, when Urban was succeeded by Clement IV. (1265-68), who as a Provençal was a subject of Charles, the latter entered Rome and was immediately made senator. Seven days later (28th of June) he received the investiture of the Neapolitan kingdom, and in the following January its crown. On the 26th of February 1266 the battle of Benevento was fought, and the valiant Manfred being killed, the triumph of the Guelph Angevins in Italy was assured. Then, at the urgent command of the pope, Charles was forced to resign the senatorship in the May of the same year. Two Romans were elected in his stead, but soon fell out with the pope, because the Guelph nobles again tried to exercise tyranny. The people, however, profited by these disturbances to rise on its own account, and formed a democratic government of twenty-six *boni homines* with Angelo Capocci, a Ghibelline, as its captain. By this government Don Henry, son of Ferdinand III. of Castile, was elected senator; and he came to Rome for the purpose of promoting a Ghibelline and Swabian policy in favour of Conradin, who was preparing for conflict. The clergy of the new senator was very energetic, for he kept down the clerics, subdued the Campagna, persecuted the Guelph nobles, made alliance with the Tuscan Ghibellines, forcibly drove back the troops of King Charles, who was advancing towards Rome, and gave a splendid reception to Conradin. But the battle of Tagliacozzo (23rd of August 1268), followed by the murder of Conradin, proved fatal to the Ghibelline party. Charles was re-elected senator imme-

diately after the battle, and the pope confirmed his powers for a term of ten years, after having already named him imperial vicar in Tuscany. On the 16th of September Charles for the second time took possession of the Capitol, and ruled Rome firmly by means of vice-governors or vicars.

The Swabian line was now extinct, and in Charles's hands the Neapolitan kingdom had become a fief of the church. The empire had fallen so low as to be no longer formidable. Now therefore was the moment for treating with it in order to restrain Charles, and also for making use of the French king to keep the empire in check. And this was the policy of Nicholas III. (1277-80), who hastened to extract advantageous promises from Rudolph of Habsburg, the new candidate for the imperial crown. In 1278, the ten years' term having expired, he deprived Charles of the senatorship and appointed Rudolph vicar of Tuscany. After declaring that he left to the people the right of electing the senator, he promulgated a new constitution (18th of July 1278) which, while confirming the rights of the church over the city, prohibited the election of any foreign emperor, prince, marquis, count or baron as senator of Rome. Thus the Colonna, Savelli, Orsini, Annibaldi and other Roman nobles again rose to power, and the republic was again endangered and plunged in disorder. The Romans then gave the reconstitution of the city into the pope's hands by yielding to him the right of nominating senators, declaring, however, that this was a personal concession to himself, and not to the popes in general. So Nicholas proceeded to name senators, alternating a Colonna with an Orsini, or simultaneously choosing one of each faction. The same power over the senate was granted with the same restriction to Martin IV. (1281-85), and he at once re-elected Charles of Anjou. Thus, greatly to the disgust of the Romans, the Capitol was again invaded by French vicars, notaries, judges and soldiery. But the terrible blow dealt at Charles's power by the Sicilian Vespers (31st of March 1282) resounded even in Rome. The Orsini, backed by the people, rose to arms, massacred the French garrison, and quickly re-established a popular government. Giovanni Cencio, a kinsman of the Orsini, was elected captain and defender of the people, and ruled the city with the co-operation of the senator and a council of priors of the guilds. This government was of brief duration, for, although the pope had professed his willingness to tolerate the experiment, he quickly arranged fresh terms, and, forsaking Charles of Anjou, again nominated two Roman senators. Pope and king both died in 1285, and Nicholas IV. (1288-92), also holding sway over the senate, favoured the Colonna in order to curb the growing mastery of the Orsini. But thus there were two powerful houses instead of one. In fact, Giovanni Colonna, when elected senator, ruled from the Capitol as an independent sovereign, conducted in person the campaign against Viterbo, and subjected that city to the republic on the 3rd of May 1291.

When one of the Gaetani, Boniface VIII. (1294-1303), was raised to the papal chair, the extent of the Colonnas' power became evident to all. Boniface opposed them in order to aggrandize his own kin, and they showed equal violence in return. The Cardinals Colonna refused to acknowledge him as the legitimate pope, and he excommunicated them and proclaimed a crusade against their house. Even after he had subdued them and destroyed Palestrina, their principal fief, the drama did not yet come to an end. Boniface had a very lofty conception of the church, and desired to establish her supremacy over the state. The king of France (Philip the Fair) believed, on the contrary, that the Angevin successes entitled him to fill the place in Italy vacated by the Swabians, and to play the master there. This led to a tremendous contest in which all the French sided with their king. And shortly afterwards a plot was hatched against the pope by the agents of France and the Colonna. These determined enemies of the pope met with much favour in Rome, on account of the general irritation against the Gaetani and the enormous power conferred on them by Boniface.

Charles of Anjou senator.

Don Henry of Castile senator.

The senate in the hands of the popes.

Boniface VIII.

Suffice it to say that they were now lords of the whole of lower Latium, from Capo Circeo to Ninfia, from Ceprano to Subiaco. Thus Sciarra Colonna and a Frenchman named Nogaret were able to fall on the pope at Anagni, insult him, and take him prisoner. The people rising to his rescue, the conspirators were put to flight. But when Boniface returned to Rome with the escort and protection of the Orsini, who had made themselves masters of the city, he found that he was virtually a captive in their hands. He felt this so keenly that he died of rage and exhaustion on the 11th of October 1303. The brief pontificate of his successor Benedict XI. was followed by that of Clement V. (1305-14), a Frenchman, who, instead of coming to Rome, summoned the cardinals to France. This was the beginning of the church's so called exile in Avignon, which, although depriving Rome of a source of wealth and influence, left the republic to pursue its own course. It employed this

The republic again takes a democratic form. freedom in trying to hold its own against the nobles, whose power was much lessened by the absence of the pope, and endeavoured to gain fresh strength by organizing the thirteen regions, which, as we have shown, were associations of a much firmer nature in Rome than the guilds. Accordingly, in 1305, a captain of the people was elected with thirteen elders and a senator, Paganino della Torre, who governed for one year. The pope was opposed to these changes at first, but in 1310 he issued a brief granting Rome full permission to select its own form of government. Thus, the first pope in Avignon restored the rights of the Romans. But the latter, even with church and empire so far removed, still considered Rome the Eternal City, the source of all law, and the only natural seat of the spiritual and temporal government of the world. To their republic, they thought, appertained a new and lofty destiny, nor could it ever be content to descend to the level of other Italian municipalities.

On the 6th of January 1309 Henry VII. was crowned king of the Romans at Aix-la-Chapelle; and so greatly were men's minds changed in Italy that, throughout the land, he was hailed as a deliverer. He wished to restore the grandeur of the empire, and the Italians, above all Dante Alighieri, beheld in him the champion of the state against the church, who, after becoming the foe of communal liberty, had forsaken Italy and withdrawn to France. The Roman people shared these ideas, and awaited Henry with equal impatience, but the nobles rose in opposition. The Orsini, leaders of the Guelphs, and allied with Robert of Naples, took possession of the castle of St Angelo and the Trastevere. Hence, when Henry reached Rome in May 1312, after seizing the iron crown at Milan, he was obliged to act on the offensive. He took the Capitol by assault, but, failing in his attack on the castle of St Angelo, was pursued by its Neapolitan garrison. Forsaken by many discouraged adherents, he was forced to recognize the expediency of departure. First, however, he desired to be crowned at the Lateran, St Peter's being held by his foes. The cardinals refused his request, but were compelled to yield by the threats of the people, who, reasserting their ancient rights, insisted that the coronation should take place without delay. And the ceremony was performed on the 20th of June 1312. The emperor then resolved to depart in spite of the popular protest against his leaving the natural seat of the empire, and on the 20th of August started for Tuscany, where worse fortune awaited him.

Their differences settled, the nobles expelled the captain of the people left by Henry, and elected as senators Sciarra Colonna and Francesco Orsini. But this was the signal for a popular revolt. The Capitol was attacked, the senators put to flight, and Jacopo Arlotti elected captain with a council of twenty-six worthies (*buoni homini*). The new leader instantly summoned the chief nobles before his tribunal, had them chained and cast into prison, and demolished many of their houses and strongholds. But, having thus humiliated their pride, Arlotti dared not put them to death, and, releasing them

from confinement, banished them to their estates, where they plunged into hostile preparations. Meanwhile the victorious people convoked a parliament and decreed that, the aristocracy being now overthrown, the *tribunizia potestas* alone should invite the emperor to make his triumphal entry into the Capitol, and receive his authority from the people of Rome. This conception of the Roman power will now be seen to become more and more definite until finding its last expression in Cola di Rienzi. Pope Clement, resigning himself to necessity, acknowledged the new government under the energetic rule of Arlotti. The latter now joined the Ghibellines of the Campagna against the Orsini and the Neapolitans, subdued Velletri, and gave it a podestà. But then the Gactani, who were Guelphs, united with the Orsini and the Neapolitans, and, giving battle to the Ghibellines in the Campagna, routed them in such wise as to put an end to the popular government. The nobles forced their way into the city, attacked the Capitol, made Arlotti their prisoner, and re-elected the senators Sciarra Colonna and Francesco Orsini. Close upon these reverses came the death of Henry VII. (24th of August 1313) at Buonconvento near Siena, which put an end to the Ghibelline party in Italy. Thereupon King Robert of Naples, being named senator by the pope, immediately appointed a vicar in Rome. Clement likewise profited by the vacancy of the imperial throne to name the king imperial vicar in Tuscany. And he died on the 20th of April 1314, well content to have witnessed the triumphs of the Guelphs in Italy.

Affairs took a fresh turn under Pope John XXII. (1316-34). Rome was still ruled by the vicars of King Robert; but, owing to the continued absence of the popes, matters grew daily worse. Trade and industry declined, revenue diminished, the impoverished nobles were exceedingly turbulent, deeds of murder and violence occurred on all sides; even by day the streets of the city were unsafe. Hence there was universal discontent. Meanwhile Louis the Bavarian, who in 1314 had been crowned king of the Romans, having overcome his German enemies at Mühlendorf in 1322, turned against the pope, one of his fiercest opponents. Louis was surrounded by Minorite friars, supporters of the poverty of the church, and consequently enemies to the temporal power. They were men of the stamp of William of Occam, Marsilio of Padua, Giovanni Janundo, and other philosophers favourable to the rights of the empire and the people. Accordingly the Italian Ghibellines hailed Louis as they had previously hailed Henry. Even the Roman people were roused to action, and, driving out the representatives and partisans of King Robert, in the spring of 1327, seized on the castle of St Angelo, and again established a democratic government. "Nearly all Italy was stirred to new deeds," says G. Villani, "and the Romans rose to arms and organized the people" (bk. x. c. 20). Regardless of the reproaches of the pope, they elected a haughty Ghibelline, Sciarra Colonna, captain of the people and general of the militia, with a council of fifty-two *popolani*, four to each region. Then, ranged under the standards of the militia, the Romans gave chase to the foes of the republic, and Sciarra, returning victorious, ascended to the Capitol and invited Louis the Bavarian to Rome. The summons was obeyed; on the 7th of January 1328 the king was already encamped in the Neronian Fields with five thousand horse and a considerable number of foot soldiers, and, with better fortune than Henry VII., was able to enter the Vatican at once.

Encircled by a crowd of heretics, reformers and Minorite brethren, he convoked a parliament on the Capitol, asking that the imperial crown might be conferred upon him by the people, from whom alone he wished to receive it. And the people proclaimed him their captain, senator and emperor. On the 17th of January his coronation took place in St Peter's. But, as he had neither money nor practical sense, his method of taxation and the excesses committed by himself and his over-excited philosophers speedily aroused the popular discontent. His ecclesiastical vicar, Marsilio of Padua, and

Sciarra Colonna, captain of the people.

Louis the Bavarian.

Giovanni Janduno placarded the walls with insulting manifestoes against the pope, whom the Minorites stigmatized as a heretic and wished to depose. In April Louis twice assembled the parliament in St Peter's Square, and, after obtaining its sanction to several anti-papal edicts, declared John XXII degraded and deposed as a heretic. This was a very strange and novel spectacle, the more so that, as speedily proved, the Romans were stirred by no anti-Catholic spirit, no yearning for religious reform. Jacopo Colonna, a canon of the Lateran, was able to make his way into Rome with four masked companions, to publicly read, at the top of his voice and before a great multitude, the excommunication launched against the emperor by the deposed pope, to traverse the entire city, and to withdraw unmolested to Palestrina. Meanwhile the emperor contented himself with decreeing that henceforth the popes must reside in Rome,—that if, when invited, they should fail to come they would be thereby held deposed from the throne. As a logical consequence, proceedings were immediately begun for the election of the new pope, Nicholas V., who on the 12th of May was proclaimed by the popular voice in St Peter's Square, and received the imperial sanction. But this ephemeral drama came to an end when the emperor departed with his antipope on the 4th of August. This caused the immediate downfall of the democratic government. Bertoldo Orsini, who had returned to Rome with his Guelphs, and Stefano Colonna were elected senators, and confirmed in the office by Cardinal Giovanni Orsini in the name of the pope. A new parliament cancelled the emperor's edicts, and had them burnt by the public executioner. Later, Nicholas, the antipope, went with a rope about his neck to make submission to John XXII., and Louis promised to disavow and retract all that he had done against the church, provided the sentence of excommunication were withdrawn. This, however, was refused. Never had the empire fallen so low. Meanwhile King Robert was again supreme in Rome, and, being re-elected senator, appointed vicars there as before. Anarchy reigned. The city was torn by factions, and the provinces rebelled against the French representatives of the pope, who, in their ignorance of Italian affairs, were at a loss how to act.

And after the election of Benedict XII. (1334-42) confusion reached so great a pitch that, on the expiration of Robert's senatorial term, the Romans named thirteen heads of regions to carry on the government with two senators, while the king still sent vicars as before. The people, for the sake of peace, once more granted the supremacy of the senate to the pope, and he nominated two knights of Gubbio, Giacomo di Cante dei Gabrielli and Bosone Novello dei Gabrielli, who were succeeded by two other senators the following year. But in

Reconstitution of the republic. 1339 the Romans attacked the Capitol, named two senators of their own choice, re-established a democratic government, and sent ambassadors to Florence to ask for the ordinances of justice (*ordinamenti della giustizia*), by which that city had broken the power of the nobles, and also that a few skilled citizens should lend their help in the reconstitution of Rome. Accordingly some Florentines came with the *ordinamenti*, some portions of which may be recognized in the Roman statutes, and, after first rearranging the taxes, elected thirteen priors of the guilds, a gonfalonier of justice, and a captain of the people after the Florentine manner. But there was a dissimilarity in the conditions of the two cities. The guilds having little influence in Rome, the projected reform failed, and the pope, who was opposed to it, re-elected the senators. Thereupon public discontent swelled, and especially when, by the foundation of the papal palace of Avignon, it was evident that Benedict XII. had no intention of restoring the Holy See to Italy. This pope was succeeded in 1342 by Clement VI. (1342-52), and King Robert in 1343 by his niece Joanna; and the latter event, while plunging the kingdom in anarchy, likewise aggravated the condition of Rome. For not only were the Neapolitan sovereigns still very powerful there, but the principal Roman nobles held large fiefs across the Neapolitan borders.

Shortly before this another revolution in Rome had re-established the government of the thirteen elders and the two senators. The people, being anxious to show their intention of respecting the papal authority, had despatched to Avignon as ambassador of the republic, in 1343, a man destined to make much noise in the world. This was Cola di Rienzi, son of a Roman innkeeper, a notary, and an impassioned student of the Bible, the fathers, Livy, Seneca, Cicero, and Valerius Maximus. Thoroughly imbued with a half pagan, half Christian spirit, he believed that he had a divinely inspired mission to revive the ancient glories of Rome. Of handsome presence, full of fantastic eloquence, and stirred to enthusiasm by contemplation of the ruined monuments of Rome, he harangued the people with a stilted oratory that enchanted their ears. He hated the nobles, because one of his brothers had been killed by them; he loved the republic, and in its name addressed a stately Latin speech to the astonished pope, and, offering him the supreme power, besought his instant return to Rome. He also begged him to allow the city to celebrate a jubilee every fifty years, and then, as a personal request, asked to be nominated notary to the urban chamber. The pope consented to everything, and Rienzi communicated this good news to Rome in an emphatically worded epistle. After Easter, in 1344, he returned to Rome, and found to his grief that the city was a prey to the nobles. He immediately began to admonish the latter, and then, draped in a toga adorned with symbols, exhibited and explained allegorical designs to the people, and announced the speedy restoration of the past grandeur of Rome. Finally he and a few burghers and merchants, whom he had secretly inflamed by his discourses, made a solemn vow to overthrow the nobility and consolidate the republic. The moment was favourable, owing to the anarchy of Naples, the absence of the pope, the weakness of the empire and the disputes of the barons, although the latter were still very potent and constituted, as it were, a separate government opposed to that of the people. Rienzi, having gained the pope's ecclesiastical vicar to his side, passed in prayer the night of the 10th of May 1347, placing his enterprise under the protection of the Holy Spirit, and the following day marched to the Capitol, surrounded by his adherents, convoked a parliament of the people, and obtained its sanction for the following proposals:—that all pending lawsuits should be at once decided; that justice should be equally administered to all; that every region should equip one hundred foot soldiers and twenty-five horse; that the dues and taxes should be rearranged; that the forts, bridges and gates of the city should be held by the rector of the people instead of by the nobility; and that granaries should be opened for the public use. On the same day, amid general homage and applause, Rienzi was proclaimed head of the republic, with the title of tribune and liberator of the Holy Roman Republic, "by authority of the most merciful Lord Jesus Christ." The nobles withdrew scoffing but alarmed. Rienzi engaged a body-guard of one hundred men, and assumed the command of thirteen hundred infantry and three hundred and ninety light horse; he abolished the senators, retained the Thirteen and the general and special councils, and set the administration on a new footing. These measures and the prompt submission of the other cities of the state brought an instant increase of revenue to Rome.

This revolution, as will be noted, was of an entirely novel stamp. For its leader despatched envoys to all the cities of Italy, exhorting them to shake off the yoke of their tyrants, and send representatives to the parliament convoked for the 1st of August, inasmuch as the liberation of Rome also implied the "liberation of the sacred land of Italy." In Rienzi's judgment the Roman revolution must be, not municipal, but national, and even in some points universal. And this idea was welcomed with general enthusiasm throughout the peninsula. Solemn festivals and processions were held in Rome; and, when the tribune went in state to St Peter's, the canons met him on the steps chanting the *Veni, Creator Spiritus*. Even the pope, willingly or unwillingly, accorded his approval to

Rienzi's deeds. The provincial cities did homage to Rome and her tribune, and almost all the rest of Italy gave him its enthusiastic adherence. The ancient sovereign people seemed on the point of resuscitation. And others besides the multitude were fascinated and carried off their feet. Great men like Petrarch were transported with joy. The poet lauded Cola di Rienzi as a sublime and supernatural being, the greatest of ancient and modern men. But it was soon evident that all this enthusiasm was mainly factitious. On the 26th of July a new parliament was called, and this decreed that all the rights and privileges granted to the empire and church must now be vested in the Roman people, from whom they had first emanated. But on the convocation of the national parliament few representatives obeyed the summons and the scheme was a failure. All had gone well so long as principles only were proclaimed, but when words had to be followed by deeds the municipal feeling awoke and distrust began to prevail. Nevertheless, on the 1st of August Rienzi assumed the spurs of knighthood and passed a decree declaring that Rome would now resume her old jurisdiction over the world, invoking the Holy Spirit upon Italy, granting the Roman citizenship to all her cities, and proclaiming them free in virtue of the freedom of Rome. This was a strange jumble of the ancient Roman idea combined with the medieval. It was a dream of Rienzi's brain, but it was also the dream of Dante and Petrarch. The conception of the empire and the history of Italy, particularly that of ancient and medieval Rome, were inevitably preparing the way for the national idea. This Rienzi foresaw, and this constitutes the true grandeur of his character, which in other respects was not exempt from pettiness and infirmity. He pursued his course, therefore, undismayed, and had indeed gone too far to draw back. On the 15th of August he caused himself to be crowned tribune with great pomp, and confirmed the rights of Roman citizenship to all natives of Italy. But practical matters had also to be taken into account, and it was here that his weakness and lack of judgment were shown. The nobles remained steadily hostile, and refused to yield to the charm of his words. Hence conflict was unavoidable; and at first Rienzi succeeded in vanquishing the Gaetani by means of Giovanni Colonna. He next endeavoured to suppress the Guelph and Ghibelline factions, and to restore Italy to "holy union" by raising her from her present abasement.

The pope, however, was weary of toleration, and, coming to terms with the nobles, incited them to war. They accordingly moved from Palestrina, and on the 30th of November were encamped before Rome. Rienzi now put forth his energy. He had already called the militia to arms, and a genuine battle took place in which eighty nobles, chiefly of the Colonna clan, were left dead. This was a real catastrophe to them, and the aristocracy never again achieved the rule of the republic. But Rienzi's head was turned by this sudden success. In great need of money, he began to play the tyrant by levying taxes and exacting instant obedience. The papal legate saw his opportunity and seized it, by threatening to bring a charge of heresy against the tribune. Rienzi was dismayed. He declared himself friendly to the pope and willing to respect his authority; and he even sought to conciliate the nobles. At this moment certain Neapolitan and Hungarian captains, after levying soldiers with the tribune's consent, joined the nobles and broke out in revolt. On their proving victorious in a preliminary encounter with some of Rienzi's guards, the tribune suddenly lost heart, resigned the power he had held for seven months, and took refuge with a few trusty adherents in the castle of St Angelo on the 15th December 1347. Thence he presently fled to Naples, vainly hoping to find aid, and afterwards disappeared for some time from the scene.

Meanwhile the Romans remained tranquil, intent on making money by the jubilee; but no sooner was this over than disorders broke out and the tyranny of the baronage recommenced. To remedy this state of things, application was made to the pope. He consulted with a committee of cardinals, who sought the advice of Petrarch, and the poet suggested a popular govern-

ment, to the complete exclusion of the nobles, since these, he said, were strangers who ruined the city. The people had already elected the Thirteen, and now, encouraged by these counsels, on the 26th of December 1351 chose Giovanni Perrone as head of the republic. But the new leader was unable to withstand the hostilities of the nobles; and in September 1353 Francesco Baroncelli was elected tribune. He was a follower of Rienzi, had been his ambassador to Florence and did little beyond imitating his mode of government and smoothing the way for his return.

Rienzi had spent two years in the Abruzzi, leading a life of mystic contemplation on Monte Maiella. Then, in 1350, he had gone to Prague and endeavoured to convert to his ideas the yet uncrowned emperor Charles IV. When apparently on the point of success, he was sent under arrest to the new pope, Innocent VI. (1352-62), a man of great shrewdness and practical sense. On Rienzi's arrival at Avignon it became evident that his popularity was still very great, and that it would be no easy task to dispose of him. The Romans were imploring his return; Petrarch lauded him as a modern Gracchus or Scipio; and the pope finally released him from confinement. Innocent had decided to send to Italy, in order to settle affairs and bring the state into subjection to the church, that valiant captain and skilled politician, Cardinal Albornoz. And, having no fear that the latter's hand would be forced, he further decided that Rienzi should be sent to give him the support of his own popularity in Rome. In fact, directly the pair arrived Baroncelli was overthrown, the supremacy of the senate granted to the pope and the government confided to Albornoz, who, without concerning himself with Rienzi, nominated Guido Patrizi as senator. He then marched at the head of his troops against Giovanni, prefect of Vico, and forced him to render submission at Montefiascone on the 5th of June 1354. With the same promptitude and skill he reduced Umbria and the Tuscan and Sabine districts, consented to leave the privileges of the cities intact in return for their recognition of the papal authority and planted fortresses in suitable positions. In the meantime Rienzi's popularity was increasing in Rome; without either money or arms, the ex-tribune succeeded by his eloquence in winning over the two Provençal leaders, brothers of the famous free captain Fra Monreale; and, seduced by his promises and hopes, they supplied him with funds. Then, profiting by his prestige, the apparent favour of the pope, and the sums received, he was able to collect a band of five hundred soldiers of mixed nationalities and returned towards Rome. On Monte Mario he was met by the *cavallerotti*. On the 1st of August 1354 he entered the Castello gate, took possession of the government, named Monreale's two brothers his captains, and sent them to lay siege to Palestrina, which was still the headquarters of the Colonna. But then money ran short, and he again lost his head. Inviting Fra Monreale to a banquet, he put him to death for the sake of his health, and kept the two brothers in confinement. This act excited general indignation. And when, after his ill-gotten gains were spent, he again resorted to violence to fill his purse, the public discontent was vented in a sudden revolt on the 8th of October. The people stormed the Capitol with cries of "Death to the traitor." Rienzi presented himself at a window waving the flag of Rome. But the charm was finally broken. Missiles were hurled at him; the palace was fired. He hid himself in the courtyard, shaved his beard and, disguised as a shepherd with a cloth over his head, slipped into the crowd and joined in their cries against himself. Being recognized, however, by the golden bracelets he had forgotten to remove, he was instantly stabbed. For two days his corpse was left exposed to the insults of the mob, and was then burned. Such was the wretched end of the man who, at one moment, seemed destined to fill the world with his name as the regenerator of Rome and of Italy.

In all the Italian cities the overthrow of the aristocracy had led to military impotence and pressing danger of tyranny. The same thing had happened in Rome when the nobility, weakened by the absence of church and empire, received its death-blow

from Rienzi. But, whereas elsewhere tyrants were gradually arising in the citizen class, Rome was always in danger of oppression by the pope. Nor was any aid available from the empire, which had never recovered from its abasement under Louis the Bavarian. In fact, when Charles of Luxemburg came to Rome to be crowned, he was obliged to promise the pope that he would not enter the city. On Easter day 1355

The popes seek to constitute a temporal kingdom. he received the crown, and departed after counselling the Romans to obey the pope. And the pontiffs had greater need than ever of an established kingdom. Their position in France was much endangered by that country's disorder. New states were being formed on all sides; the medieval unity was shattered; and the shrunken spiritual authority of the church increased her need of material strength. As Italian affairs stood, it would be easy for the popes to found a kingdom, but their presence was required in Rome before it could be firmly established. The blood-stained sword of Albornoz had prepared the way before them. In 1355-56 he vanquished the lords or tyrants of Rimini, Fano, Fossombrone, Pesaro, Urbino and other cities. And all these places had been so rudely oppressed that the cardinal was often hailed as a liberator after subduing their masters by fire and sword. But everywhere he had been obliged to leave existing governments and rulers *in statu quo* after exacting their oaths of fealty. Thus the state was still dissevered, and it was impossible to bind it together with the pope at Avignon and Rome a republic. Bologna was still independent, Ordelaffi still lord of Forlì; Cesena and other cities were still rebellious; and the Campagna was still in the hands of the barons. Some places were ruled by rectors nominated by the pope; at Montefiascone there was an ecclesiastical rector, with a bench of judges, and a captain commanding a mixed band of adventurers. Rome had submitted to the haughty cardinal, but hated him mortally, and, on his departure for Avignon in 1357 to assist the threatened pontiff, immediately conceded to the latter the supremacy of the senate. And the pope, instead of two senators, hastened to name a single one of foreign birth. This was a shrewd device of Albornoz and another blow to the nobles, with whom he was still at war. Thus was inaugurated, by the nomination of Raimondo de'

Foreign senators.

Tolomei in 1358, a series of foreign senators, fulfilling the functions of a podestà, and changed every six months, together with their staff of judges, notaries and knights. The people approved of this reform as being inimical to the nobles and favourable to the preservation of liberty. Hitherto the senators had been assisted, or rather kept in check, by the thirteen representatives of the regions. These were now replaced by seven reformers, in imitation of the priors of Florence, the better to follow that city's example. The reformers were soon the veritable chiefs of the republic. They first appeared in 1360, were either *popolani* or *cavallerotti*, and were elected by ballot every three months. When Albornoz returned to Italy, although desirous to keep Rome in the same subjection as the other cities, he had first to vanquish Ordelaffi and reduce Bologna. The latter enterprise was the more difficult task, and provoked a lengthy war with Matteo Visconti of Milan. Thus Rome, being left to herself, continued to be governed by her reformers; and the nobles, already shut out from power, were also excluded from the militia, which had been reorganized, like that of Florence, on the democratic system.

The band-ers. Three thousand men, mostly archers, were enrolled under the command of two *banderesi*, "in the likeness," says M. Villani, "of our gonfaloniers of the companies," with four *antepositi* constituting a supreme council of war. And the whole body was styled the "Felix Societas Balestrariorum et Pavestatorum." It was instituted to support the reformers and re-establish order in the city and Campagna, to keep down the nobles and defend the republic. It fulfilled these duties with much, and sometimes excessive, severity. *Banderesi* and *antepositi* had seats in the special council beside those of the reformers, as, in Florence, the gonfaloniers of the companies were seated beside the priors. Later these officials

constituted the so-called *signoria dei banderesi*. In 1362, the Romans having subjected Velletri, which was defended by the nobles, the latter made a riot in Rome. Thereupon the *banderesi* drove them all from the city, killed some of their kindred, and did not even spare the *cavallerotti*. The fight became so furious that from gate to gate all Rome was in arms, and even mercenaries were hired. But in the end renewed submission was made to the pope.

On the death of Innocent VI. in 1362, an agreement was concluded with his successor, Urban V. (1362-70), also a Frenchman, who was obliged to give his sanction to the government of the reformers and *banderesi*. And then, Albornoz being recalled in disgrace to Avignon, and afterwards sent as legate to Naples, these Roman magistrates were able, with or without the co-operation of the foreign senator, to rule in their own way. They did justice on the nobles by hanging a few more; and they defended the city from the threatening attacks of the mercenaries, who had now become Italy's worst foes. It was at this period that the Roman statutes were revised and rearranged in the compilation erroneously attributed by some writers to Albornoz, which has come down to us supplemented by alterations of a later date.

But now the popes, being no longer in safety at Avignon, really decided to return to Italy. Even Urban V. had to pay ransom to escape from the threatened attacks of the free companies. The Romans implored his return, and he was further urged to it by the Italian *literati*, with Petrarch at their head. In April 1367 he finally quitted Avignon, and, entering Rome on the 16th of October, was given the lordship of the city. Cardinal Albornoz had fallen mortally ill at Viterbo, but, though unable to accompany the pope to Rome, had, before dying, suggested his course of action. Certainly Urban showed much acumen in profiting by the first burst of popular enthusiasm to effect quick and dexterous changes in the constitution of the republic. After naming a

Urban V. begins to destroy the republic.

senator, he abolished the posts of reformers and *banderesi*, substituting three conservators, or rather a species of municipal council, alone charged with judicial and administrative powers, which has lasted to the present day. The thirteen leaders of the regions and the consuls of the guilds still sat in the councils, which were left un-suppressed. But all real power was in the hands of the pope, who, in Rome, as in his other cities, nominated the principal magistrates. Thus, by transforming political into civil institutions and concentrating the supreme authority in his own grasp, Urban V. dealt a mortal blow to the liberties of Rome. Yet he felt no sense of security among a people who, after the first rejoicings over the return of the Holy See, were always on the brink of revolt. Besides, he felt himself a stranger in Italy, and was so regarded. Accordingly, in April 1370 he decided to return to France; on the 20th of that month he wrote from Viterbo that no change was to be made in the government; and he died in Avignon on the 19th of December.

The Romans retained the conservators, conferring on them the political power of the reformers; they re-established the *banderesi* with the Florentine title of *executores justitiarum* and the four *antepositi* with that of *consiliarii*. Thus the "Felix Societas Balestrariorum et Pavestatorum Urbis" was restored, and the two councils met as before. The new French pope, Gregory XI. (1370-78), had to be content with obtaining supremacy over the senate and the possession of the castle of St Angelo. It was a difficult moment for him. The Florentines had come to an open rupture with his legates, and had adopted the expedient of inviting all the cities of the Roman state to redeem their lost freedom. Accordingly, in 1375 many of them rose against the legates, who were mostly French and regarded with dislike as foreigners. Florentine despatches, full of classical allusions and chiefly composed by the famous scholar Secretary Coluccio Salutati, were rapidly sent in all directions. Those addressed to the Romans were specially fervid, and emphatically appealed to their patriotism and memories of

Re-establishment of the republic and the banderesi.

the past. But the Romans received them with doubt and mistrust, for they saw that the revolution threatened to dismember the state, by promoting the independence of every separate city. Besides, while maintaining their republic, they also desired the pope's presence in Rome. Nevertheless, they went with the current to the extent of reforming their constitution. In February 1376 they nominated Giovanni Cenci captain of the people, and gave him uncontrolled power over the towns of the patrimony and the Sabine land. The conservators, with their new political authority, the *executores*, the *anepositi* and the two councils were all preserved, and a new magistracy was created, the "Tres Gubernatores Pacis et Libertatis Reipublicae Romanae." This answered to the Eight (afterwards Ten) of War in Florence, likewise frequently called the Eight of Liberty and Peace. It was this Council of Eight that was now directing the war against the pope and braving his sentence of excommunication; and their fiery zeal had won them the title of the Holy Eight from the Florentines.

Realizing that further absence would cost him his state, Gregory XI. quitted Avignon on the 13th of September 1376, and, reaching Corneto in December, despatched to Rome three legates, who, on the 21st of the month, concluded an agreement with the parliament. The people gave up the gates, the fortresses and the Trastevere, and promised that if the pope returned to Rome he should have the same powers which had been granted to Urban V. But, on his side, he must pledge himself to maintain the *executores* and their council, and allow the Romans the right of reforming the *banderesi*, who would then swear fealty to him. The terms of this peace and the pope's epistles clearly prove that the two councils still exercised their functions, that the *banderesi* were still the virtual heads of the government, and that their suppression was not contemplated. In fact, when the pope made his entry on the 17th of January 1377, accompanied by two thousand armed men, he perceived that there was much public agitation, that the Romans did not intend to fulfil their agreement, and that the government of the *banderesi* went on as before. Accordingly, after naming Gomez Albornoz, a nephew of the deceased cardinal, to the office of senator, he retired to Anagni, and remained there until November 1377. The Romans presently waited on him with conciliating offers, and begged him to negotiate a peace for them with the prefect of Vico. In fact, the treaty was concluded at Anagni in October, and on the 10th of November confirmed in Rome by the general council. The meeting was held in the great hall of the Capitol, *ubi consilia generalia urbis fieri solent*, in the presence of all the members of the republican government. But the pope was enraged by the survival of this government, and, being worn out by the persistent hostility of the Florentines, which reduced his power to a low ebb, had determined to make peace, when surprised by death on the 27th of March 1378.

The next pope, Urban VI. (1378-89), a Neapolitan, was the spirit of discord incarnate. His election was not altogether regular: the French party among the cardinals was against him; and the people were ripe for insurrection. But, regardless of all this, Urban threatened the cardinals in his first consistory, saying that church reform must begin with them; and he used the same tone with the people, reproving them for failing to suppress the *banderesi*. In consequence of this the cardinals of the French party, assembling at Fondi, elected the antipope Clement VII. (1378-94) and started a long and painful schism in the church. Clement resided in Avignon, while Urban in Rome was engaged in opposing Queen Joanna I. of Naples and favouring Charles of Durazzo, who, on conquering the Neapolitan kingdom, was made gonfalonier of the church and senator of Rome, where he left a vicar as his deputy. Shortly afterwards the pope went to Naples, and made fierce war on the king. Then, after many adventures, during which he tortured and put to death several cardinals whom he suspected of hostile intentions, he returned to Rome,

where the utmost disorder prevailed. The conservators and the *banderesi* were still at the head of the government, and the pope speedily falling out with them, a riot ensued, after which he excommunicated the *banderesi*. These at last made submission to him, and Urban VI. became master of Rome before his death in 1389. He was succeeded by Boniface IX. (1389-1404), another Neapolitan, but a man of greater shrewdness and capacity. His first act was to crown Ladislaus king of Naples, and secure the friendship and protection of this ambitious and powerful prince. In all the principal cities of the state he chose the reigning lords for his vicars. But he allowed Fermo, Ascoli and Bologna the privilege of assuming their own vicariate for twenty-five years. And, as these different potentates and governments had only to pay him an annual tribute, all parties were satisfied, and the pope was able to bestow at least an appearance of order and unity on his state. But fresh tumults soon arose, partly because the conservators and *banderesi* sought to govern on their own account, and especially because the pope seems for a time to have omitted naming the senator. Boniface was a prudent man; he saw that events were turning in his favour, now that throughout Italy liberty was tottering to its fall, and bided his time. He was satisfied for the moment by obtaining a recognition of the immunities of the clergy, rendering them solely amenable to ecclesiastical tribunals, and thus distinguishing the powers of the church from those of the state in Rome. The republic also pledged itself neither to molest the prelates nor to levy fresh contributions on them towards repairing the walls, to aid in recovering the estates of the church in Tuscany, and to try to conciliate the baronage. This concordat, concluded with the conservators and *banderesi* on the 11th of September 1391, was also confirmed on the 5th of March 1392 by the heads of the regions, together with a fresh treaty binding both parties to furnish a certain number of armed men to combat the prefect of Vico and the adherents of the antipope at Viterbo. With the exception of this city, Orchi and Civita Vecchia, all other conquered territory was to belong to the republic. But the Romans soon discovered that they were playing into the hands of the pope, who kept everything for himself, without even paying the troops. Upon this a riot broke out; Boniface fled to Perugia in October 1392, and resolved to exact better terms when next recalled to Rome. Meanwhile the Romans subdued the prefect, captured Viterbo, and, being already repentant, handed it over to the pope and implored his return. He then proposed his own terms, which were approved, not only by the conservators, *banderesi* and four councillors, but also by the special council and by the unanimous vote of a general assembly, composed of the above-mentioned authorities, heads of regions, other officials and a hundred citizens (8th August 1393). These terms prescribed that the

pope was to elect the senator, and that, on his failing so to do, the conservators would carry on the government after swearing fealty to him. The senatorial function was to be neither controlled nor hampered by the *banderesi*. The immunities of the clergy were to be preserved, and all church property was to be respected by the magistrates. The expenses of the pope's journey were to be paid, and he was to be escorted to Rome in state. Boniface tried to complete his work by abolishing the *banderesi*, the last bulwarks of freedom; but the people, although weakened and weary, made efforts to preserve them and, although their fall was inevitable, the struggle went on for some time.

During the spring of 1394 the *banderesi* provoked an insurrection in which the pope's life was endangered; it was only saved by the arrival of King Ladislaus, who came from Naples with a large force in the early autumn. But for the Neapolitan soldiery Boniface could not have withstood the long series of revolts that continually exposed him to fresh perils and the anxiety caused by the persistent schism of the church. The death of Clement VII. in 1394 was followed by the election of

Urban VI.
under-
takes the
destruction
of the
republic.

Boniface
IX. con-
tinues the
destruction
of the
republic.

another antipope, Benedict XIII. But a new jubilee was in prospect for the year 1400, and this was always an efficacious means of bending the will of the Romans. Depending upon this and the assistance of Ladislaus, Boniface not only demanded full powers to nominate senators (none having been recently elected), but insisted on the suppression of the *banderesi*. Both requests were granted; but, directly Angelo Alaone was made senator, a conspiracy was hatched for the re-establishment of the *banderesi*. However, the pope felt sure of his strength; the plot was discovered and the conspirators were beheaded on the stairs of the Capitol. This proved the end of the *banderesi* and of the liberties of Rome. The government was again directed by an alien senator together with three conservators; but the latter were gradually deprived of their political attributes, and became mere civil officers. The militia, regiments, guilds and other associations now rapidly lost all political importance, and before long were little more than empty names. Thus in 1398 the Romans submitted to the complete sway of the pope, and in July of the same year the senator chosen by him was Malatesta dei Malatesti of Rimini, one of a line of tyrants, a valiant soldier, who was also temporal vicar and captain-general of the church. Boniface continued to appoint foreign senators during the rest of his life; he fortified the castle of St Angelo, the Vatican and the Capitol; he stationed galleys at the mouth of the Tiber, and proved himself in all things a thoroughly temporal prince. He aggrandized all his kindred, especially his brother, and, with the aid of his senator, his armed force and the protection of Ladislaus, succeeded in keeping down all the surviving nobles. In 1400, however, these made an attempt to upset the government. Niccolò Colonna forced his way into the city with cries of "Popolo, popolo! death to Boniface!" But the Romans had grown deaf to the voice of liberty; they refused to rise, and the senator, a Venetian named Zaccaria Trevisan, behaved with much energy. Colonna and his men had to beat a swift retreat to Palestrina. A charge of high treason was immediately instituted against him, and thirty-one rebels were beheaded. The pope then proclaimed a crusade against all the Colonna, and sent a body of two thousand men and some of the Neapolitan soldiery to attack them. Several of their estates were seized and devastated, but Palestrina continued to hold out, and on the 7th of January 1401 the Colonna finally made submission to the pope. Nevertheless, they obtained advantageous terms, for Boniface left them their lands, appointed them vicars of other territories, and made similar agreements with the Gaetani and Orsini. In this way he became absolute master of Rome. One chronicler remarks that "Romanis tanquam rigidus imperator dominabatur," and the same tone is taken by others. But he did not succeed in putting an end to the schism of the church, which was still going on when he died in the Vatican on the 1st of October 1404.

Innocent VII. (1404-6) was the next pope. He too was a Neapolitan, and on his election the people again rose in revolt and refused to acknowledge him unless he consented to resign the temporal power. But Ladislaus of Naples hastened to his help, and an agreement was made which, under the cover of apparent concessions, really riveted the people's chains. Rome was recognized as the seat of the temporal and spiritual sovereignty of the pope, and the pope continued to appoint the senator. The people were to elect seven governors of the city, who were to swear fealty to the pope and carry on the government in conjunction with three other governors chosen by the pontiff or Ladislaus. The stipulations of Boniface IX. concerning ecclesiastical immunities were again confirmed. The barons were forbidden to place more than five lances each at the service of the people, and—which was the real gist of the covenant—the people were henceforth forbidden to make laws or statutes without the permission of the pope. The captain of the people, deprived of his political and judicial functions and reduced to a simple judge, was also to be chosen by the pope. But this treaty, drawn up on the 27th of October 1404, was not signed

at the time, and many difficulties and disturbances arose when its terms were to be put into effect. The Romans nominated the seven governors, but, without waiting until the pope had chosen three more, placed the state in their hands, and styled them "governors of the liberty of the Roman Republic." They were, in fact, *banderesi* or *reformatori* under a new name. But the attempt proved inefficacious, for, at the pope's first threat of departure, the Romans made their submission, and the treaty of October was subscribed on the 15th of May 1405. Nevertheless, as it only bears the signatures of the "seven governors of the liberty of the Roman Republic," the pope would seem to have made some concessions. His position was by no means assured. Ladislaus was known to aspire to absolute dominion in Italy, and, although willing to aid in suppressing the republic, tried to prepare the way for his own designs, and frequently held out a helping hand to the vanquished. On the 6th of August fourteen influential citizens of Rome boldly presented themselves at the Vatican, and in a threatening manner called the pope to account for giving his whole attention to worldly things, instead of endeavouring to put a stop to the schisms of the church. But, on leaving his presence, they were attacked by Luigi Migliorati, the pope's nephew, and notorious for his violence, who killed eleven of their number, including several heads of the regions and two of the governors. An insurrection ensued, and the pope and his nephew fled to Viterbo. The Colonna tried to profit by these events, and applied to Ladislaus, who, hoping that the moment had come to make himself master of Rome, sent the count of Troia thither with a troop of three thousand horse. But the people, enraged by this treachery, and determined not to fall under the yoke of Naples, awoke for an instant to the memory of their past glories, and bravely repulsed the Colonna and the Neapolitans. And, on the speedy arrival of the Orsini with some of the papal troops, the people voluntarily restored the papal government, and, assembling the parliament, besought the pope to return on his own terms. Accordingly, after first naming Francesco Pancia-tichi of Pistoia to the senatorship, the pope came back on the 13th of March 1406, bringing his whole curia with him, and also the murderer Migliorati, who, triumphing in impunity, became more arrogant than before. Here indeed was a proof that the Romans were no longer worthy of liberty! And now, by means of the Orsini, Innocent had only to reduce the Colonna and other nobles raised to power by Ladislaus; nor was this very difficult, seeing that the king, in his usual fashion, abandoned them to their fate, and, making terms with the pope, was named gonfalonier of the church and again protected her cause.

Innocent, dying in 1406, was succeeded by Gregory XII., a Venetian, who, as we shall presently see, resigned the chair in 1415. On his accession, finding his state firmly established, he seemed to be seriously bent on putting an end to the Great Schism, and for that purpose arranged a meeting with the antipope Benedict XIII. at the congress of Savona in 1408. But Gregory and Benedict only used the congress as a pretext for making war upon each other, and were urged on by Ladislaus, who hoped by weakening both to gain possession of Rome, where, although opposed by the Orsini, he had the support of the Colonna. Gregory, who had then fled from Rome, made a momentary attempt to win the popular favour by restoring the government of the *banderesi*; but Ladislaus marched into Rome in June 1408 and established a senator of his own. Meanwhile the two popes were continuing their shameful struggle, and the council of Pisa (March 1409), in attempting to check it, only succeeded in raising up a third pontiff, first in the person of Alexander V. (1409-10), and then in the turbulent Baldassarre Cossa, who assumed the name of John XXIII. The latter began by sending a large contingent to assist Louis of Anjou against Ladislaus. But the enterprise failed, and, seeing himself deserted by all, Pope John next embraced the cause of his foe by naming him gonfalonier of the church. Thereupon Ladislaus concluded a sham peace, and then, seizing Rome, put it to the sack and established his own government there. Thus John, like the other two popes,

Ladislaus
master of
Rome.

became a wanderer in Italy. In August 1474 Ladislaus died, and was succeeded by the scandalous Queen Joanna II. The Roman people promptly expelled the Neapolitans, and Cardinal Isolani, John's legate, succeeding in rousing a reaction in favour of the church, constituted a government of thirteen "conservators" on the 19th of October.

In November 1414 the council of Constance assembled, and at last ended the schism by deposing all the popes and incarcerating John XXIII., the most turbulent of the three. On the 11th of November 1417 Oddo Colonna was unanimously elected to the papal chair; he was consecrated in the cathedral on the 27th as Pope Martin V., and, being acknowledged by all, hastened without delay to take possession of his see. Meanwhile disorder was at its height in Rome. The cardinal legate Isolani governed as he best could, while the castle of St Angelo remained in the hands of the Neapolitans, who still had a party in the city. In this divided state of affairs, Braccio, a daring captain of adventurers, nicknamed Fortebraccio, was inspired with the idea of making himself master of Rome. Overcoming the feeble resistance opposed to him, he succeeded in this on the 16th of June 1416, and assumed the title of "Defensor Urbis." But Joanna of Naples despatched Sforza, an equally valiant captain, against him, and, without offering battle, Fortebraccio withdrew on the 26th of August, after having been absolute master of the Eternal City for seventy days. Sforza marched in on the 27th and took possession of the city in the name of Joanna. Martin V. instantly proved himself a good statesman. He confirmed the legate Isolani as his vicar and Giovanni Savelli as senator. Leaving Constance on the 16th of May 1418, he reached Milan on the 12th of October, and slowly proceeded on his journey. While in Florence he despatched his brother and nephew to Naples to make alliance with Joanna, and caused her to be crowned on the 28th of October 1420 by his legate Morosini. Upon this she promised to give up Rome to the pope. Her general, Sforza, then entered the service of Martin V., and compelled Fortebraccio, who was lingering in a threatening attitude at Perugia, to make peace with the pope. The latter entrusted Fortebraccio with the conduct of the campaign against Bologna, and that city was reduced to submission on the 15th of July 1420. The Romans had already yielded to Martin's brother the legate, and now earnestly besought the arrival of their pope. Accordingly, he left Florence on the 19th of September 1420, and entered the Vatican on the 28th. Rome was in ruins; nobility and burghers were equally disorganized, the people unable to bear arms and careless of their rights, while the battered walls of the Capitol recorded the fall of two republics.

Martin V. had now to fulfil a far more difficult task than that of taking possession of Rome. Throughout Italy municipal freedom was overthrown, and the Roman Republic had ceased to exist. The Middle Ages were ended; the Renaissance was beginning. The universal unity both of church and of empire was dissolved; the empire was now Germanic, and derived its principal strength from direct dominion over a few provinces. Independent and national states were already formed or forming on all sides. The papacy itself had ceased to claim universal supremacy over the world's governments, and the possession of a temporal state had become essential to its existence. In fact, Martin V. was the first of the series of popes who were real sovereigns, and more occupied with politics than religion. Involved in all the foreign intrigues, falsehoods and treacheries of Italian diplomacy in the 15th century, their internal policy was imbued with all the arts practised by the tyrants of the Renaissance, and nepotism became necessarily the basis of their strength. It was natural that men suddenly elected sovereigns of a new country where they had no ties, and of which they had often no knowledge, should seek to strengthen their position by aggrandizing so-called nephews who were not unfrequently their sons.

Martin V. reduced the remains of the free Roman government to a mere civil municipality. Following the method of the other despots of Italy, the old republican institutions were allowed to retain their names and forms, their administrative and some of their judicial attributes, while all their political functions were transferred to the new government. Order was re-established, and justice rigidly observed. Many rebellious places were subdued by the sword, and many leaders of armed bands were hanged. The pope, however, was forced to lean on his kinsmen the Colonna and again raise them to power by grants of vast fiefs both in his own state and the Neapolitan territory. And, after first supporting Joanna II., who had assisted his entry into Rome, he next sided with her adversary, Louis of Anjou, and then with Alphonso of Aragon, the conqueror of both and the constant friend of the pope, who at last felt safe on his throne. Rome now enjoyed order, peace and security, but had lost all hope of liberty. And when Martin died (20th February 1431) these words were inscribed on his tomb, "Temporur suorum felicitas."

Eugenius IV. (1437-47) leant on the Orsini, and was fiercely opposed by the Colonna, who excited the people against him. Accordingly on the 29th of May 1434 the Romans rose in revolt to the old cry of "Popolo e popolo," and again constituted the rule of the seven governors of liberty. The pope fled by boat down the Tiber, and, being pursued with stones and shots, narrowly escaped with his life. On reaching Florence, he turned his energies to the recovery of the state. It was necessary to quell the people; but, first of all, the Colonna and the clan of the prefects of Vico, with their renewed princely power, had to be overthrown. The Orsini were still his friends. Eugenius entrusted the campaign to Patriarch (afterwards Cardinal) Vitelleschi, a worthy successor of Alborno, and of greater ferocity if less talent. This leader marched his army towards Rome, and, instantly attacking Giovanni, prefect of Vico, captured and beheaded him. The family was now extinguished; and its possessions reverting to the church, the greater part of them were sold or given to Count Everso d'Anguillara, of the house of Orsini. The prefecture, now little more than an honorary title, was bestowed at will by the popes. Eugenius gave it to Francesco, founder of the powerfullness of the Gravina-Orsini. Thus one noble family was raised to greatness while another perished by the sword. Vitelleschi had already begun to persecute the Colonna and the Savelli, and committed terrible slaughter among them. Many castles were demolished, many towns destroyed; and their inhabitants, driven to wander flame-stricken over the Campagna, had to sell themselves as slaves for the sake of bread. Finally the arrogant patriarch marched into Rome, as into a conquered city, at the head of his men, and the Romans crouched at his feet. The pope now began to distrust him, and sent Scarampo, another prelate of the same stamp, to take his place. This new commander soon arrived, and, perceiving that Vitelleschi proposed to resist, had him surrounded by his soldiers, who were obliged to use force to compel his surrender. Vitelleschi was carried bleeding to the castle of St Angelo, where he soon afterwards died. The pope at last returned to Rome in 1443, and remained there quietly till his death in 1447.

His successor Nicholas V. (1447-55) was a scholar solely devoted to the patronage of *literati* and artists. During his reign there was a fresh attempt to restore the republic, but it was rather prompted by literary and classical enthusiasm than by any genuine patriotic ardour. Political passions and interests had ceased to exist. The conspiracy was headed by Stefano Porcari, a man of the people, who claimed to be descended from Cato. He had once been captain of the people in Florence, and was made podestà of Bologna by Eugenius IV. He was a caricature of Cola di Rienzi, and extravagantly proud of his

The temporal kingdom of the popes raised on the ruins of the republic.

A revolution expels the pope.

Eugenius IV. resumes possession.

Conspiracy of Stefano Porcari.

Latin speeches in honour of ancient republican liberty. The admiration of antiquity was then at its height, and Porcari found many enthusiastic hearers. Directly after the death of Eugenius IV. he made a first and unsuccessful attempt to proclaim the republic. Nevertheless Nicholas V., with the same indulgence for scholars that had prompted him to pardon Valla for denying the temporal power of the papacy and laughing to scorn the pretended donation of Constantine, freely pardoned Porcari and named him *podestà* of Anagni. He filled this office with credit, but on his return to Rome again began to play the agitator, and was banished to Bologna with a pension from the pope. Nicholas V. had conferred all the state offices upon priests and abbots, and had erected numerous fortresses. Hence there were many malcontents in Rome, in communication with Porcari at Bologna, and ready to join in his plot. Arms were collected, and on the day fixed he presented himself to his fellow-conspirators adorned with rich robes and a gold chain, and harangued them in Latin on the duty of freeing their country from the yoke of the priests. His design was to set fire to the Vatican on the 6th of January 1453, the feast of the Epiphany; he and his followers were to seize the pope, the cardinals and the castle of St Angelo. But Nicholas received timely warning; the conspirators' house was surrounded; and Porcari himself was seized while trying to escape, confined in the castle of St Angelo, and put to death with nine of his companions on the 9th of January. Others shortly suffered the same fate.

Under Calixtus III. and Pius II. affairs went on quietly enough, but Paul II. (1464-71) had a somewhat troubled reign. Yet he was a skilled politician. He re-ordered the finances and the courts of justice, punished crime with severity, was an energetic foe to the Malatesta of Rimini, put an end to the oppression exercised in Rome by the wealthy and arrogant house of Anguillara, and kept the people in good humour with continual festivities. But—and this was a grave defect at that period—he extended no favour to learning, and, by driving many scholars from the curia to make room for his own kinsmen, brought a storm about his ears. At that time the house of Pomponio Leto was the rendezvous of learned men and the seat of the Roman Academy. Leto was an enthusiast of antiquity; and, as the members of the Academy all assumed old Latin names, they were suspected of a design

Men of
learning
persecuted on
suspicion
of re-
publican
ten-
dencies.

to re-establish paganism and the republican government. It is certain that they all inveighed against the pope; and, as the latter was no man of half measures, during the carnival of 1468 he suddenly imprisoned twenty Academicians, and even subjected a few of them to torture. Pomponio Leto, although absent in Venice, was also arrested and tried; but he exculpated himself, craved forgiveness, and was set at liberty. His friends were also released, for the charge of conspiracy proved to be unfounded. Certain members of the Academy, and notably Platina in his *Lives of the Popes*, afterwards revenged themselves by stigmatizing Paul II. as the persecutor of philosophy and letters. But he was no more a persecutor than a patron of learning; he was a politician, the author of some useful reforms, and solely intent on the consolidation of his absolute power. Among his reforms may be classed the revision of the Roman statutes in 1469, for the purpose of destroying the substance while preserving the form of the old Roman legislation, and entirely stripping it of all political significance. In fact the pope's will was now absolute, and even in criminal cases he could trample unhindered on the common law.

There was still a senator of Rome, whose nomination was entirely in the hands of the pope, still three conservators, the heads of the *trioni*, and an elected council of twenty-six citizens. Now and then also a shadowy semblance of a popular assembly was held to cast dust in the eyes of the public, but even this was not for long. All these officials, together with the judges of the Capitol, retained various attributes of different kinds. They administered justice and gave sentence. There were numerous

tribunals all with undefined modes of procedure, so that it was very difficult for the citizens to ascertain in which court justice should be sought. But in last resort there was always the supreme decision of the pope. Thus matters remained to the time of the French Revolution.

For the completion of this system a final blow had to be dealt to the aristocracy, whose power had been increased by nepotism; and it was dealt by bloodshed under the three following popes—Sixtus IV. (1471-84), Innocent VIII. (1484-92) and Alexander VI. (1492-1503)—each of whom was worse than his predecessor. The first, by means of his nephews, continued the slaughter of the Colonna, sending an army against them, devastating their estates at Marino, and beheading the protonotary Lorenzo Colonna. Innocent VIII. was confronted by the power of the Orsini, who so greatly endangered his life by their disturbances in the city that he was only saved by an alliance with Naples. Neither peace nor order could be lastingly established until these arrogant barons were overthrown. This task was accomplished by the worst of the three pontiffs, Alexander VI. All know how the massacre of the Orsini was compassed, almost simultaneously, by the pope in Rome and his equally iniquitous son, Caesar Borgia, at Sinigaglia (1502). This pair dealt the last blow to the Roman aristocracy and the tyrants of Romagna, and thus the temporal dominion of the papacy was finally assured. The republic was now at an end; it had shrivelled to a civil municipality. Its institutions, deprived of all practical value, lingered on like ghosts of the past, subject from century to century to unimportant changes. The history of Rome is henceforth absorbed in that of the papacy.

Nevertheless the republic twice attempted to rise from its grave, and on the second occasion gave proofs of heroism worthy of its most glorious past. It was first resuscitated in February 1798, by the influence of the Post-
medieval
Rome. French Revolution, and the French constitution of the year III. was rapidly imitated. Rome had again two councils—the tribunate and the senate, with five consuls constituting the executive power. But in the following year, owing to the military reverses of the French, the government of the popes was restored until 1809, when Napoleon I. annexed to his empire the States of the Church. Rome was then governed by a *consula straordinaria*—a special commission—with the municipal and provincial institutions of France. In 1814 the papal government was again reinstated, and the old institutions, somewhat modified on the French system, were recalled to life. Pius IX. (1846-77) tried to introduce political reforms, and to improve and simplify the old machinery of state; but the advancing tide of the Italian revolution of 1848 drove him from Rome; the republic was once more proclaimed, and had a brief but glorious existence. Its programme was dictated by Giuseppe Mazzini, who with Saffi and Armellini formed the triumvirate at the head of the government. United Italy was to be a republic with Rome for her capital. The rhetorical idea of Cola di Rienzi became heroic in 1849. The constituent assembly (9th February 1849) proclaimed the fall of the temporal power of the popes, and the establishment of a republic which was to be not only of Rome but of all Italy. France, although then herself a republic, assumed the unenviable task of re-establishing the temporal power by force of arms. But the gallant defence of Rome by Garibaldi covered the republic with glory. The enemy was repulsed, and the army of the Neapolitan king, sent to restore the pope, was also driven off. Then, however, France despatched a fresh and more powerful force; Rome was vigorously besieged, and at last compelled to surrender. On the 2nd of July 1849 the heroic general departed from the city with some thousands of his followers. Almost at the same time the constituent assembly proclaimed in the Capitol the constitution of the Roman Republic. Immediately afterwards the French restored the government of Pius IX., whose reign down to 1870 was that of an absolute sovereign. Then the Italian government entered Rome (20th September 1870), proclaimed the national constitution (9th October 1870), and the Eternal City became the capital of Italy. Thus the

scheme of national unity, the natural outcome of the history of Rome and of Italy, impossible of accomplishment under the rule of the popes, was finally achieved by the monarchy of Savoy, which, as the representative and personification of Italian interests, abolished the temporal power of the papacy and made Rome the seat of government of the united country (see ITALY).

AUTHORITIES.—The history of the commune of Rome in the middle ages has to be collected from the scattered materials in special treatises, or from the general histories of the papacy. The greater part of the facts are to be found in the *Liber Pontificalis*, edited by the Abbé Duchesne (2 vols., Paris, 1886-92), and in the excellent histories of Rome by Felix Papencordt and Gregorius (see below). Vitale, *Storia diplomatica de Senatori di Roma* (2 vols., Rome, 1791); Galletti, *Del primicerio della Santa Sede Apostolica e di altri ufficiali maggiori del sacro palazzo Lateranense* (Rome, 1776); Vendettini, *Del Senato Romano* (Rome, 1782); Baronius, *Annales Ecclesiastici*, continued by Raynaldus (42 vols. fol., 1738-56), and the recent continuations of Theiner relating to the years 1572-85; J. Ficker, *Forschungen zur Reichs- und Rechtsgeschichte Italiens* (4 vols., Innsbruck, 1868-74); Savigny, *Geschichte des römischen Rechts im Mittelalter* (frequently reprinted and translated into all the principal languages); Leo, *Entwicklung der Verfassung der lombardischen Städte* (Hamburg, 1824); M. A. von Bethmann-Hollweg, *Ursprung der lombardischen Städtefreiheit* (Anhang: *Schicksale der römischen Städteverfassung im Exarchat und in Rom*) (Bonn, 1846); Hegel, *Geschichte der Städteverfassung von Italien* (Leipzig, 1847); Giesebrecht, "Ueber die städtischen Verhältnisse im X. Jahrhundert," at end of vol. I of *Geschichte der deutschen Kaiserzeit* (Brunswick, 1863); "Studi e documenti di Storia e Diritto," in *Annuario di Conferenze storico-giuridiche* (Rome, 1880 seq.); *Archivio della Reale Società Romana di Storia Patria* (the other publications of the same society, as, e.g., the *Regesto di Farfa*, may also be consulted with advantage); F. Papencordt, *Geschichte der Stadt Rom* (Paderborn, 1857); Id. *Cola di Rienzo* (Hamburg, 1841); Gregorius, *Geschichte der Stadt Rom* (8 vols., Stuttgart, finished in 1872; 3rd ed., Stuttgart, 1875-84); A. von Reumont, *Geschichte der Stadt Rom* (3 vols., Berlin, 1867-68).

Among more recent works see especially M. Creighton, *History of the Papacy* (London, 1897); L. Pastor, *Geschichte der Päpste seit dem Ausgang des Mittelalters* (Freiburg i/B., 1886, &c.), a learned work, but written in an extremely clerical spirit; more impartial, although written by a Jesuit, is P. H. Grisar's *Storia di Roma e dei Papi nel Medio Evo* (Italian edition, Rome, 1899, &c., not yet completed). For the history of the republic in 1849 accounts will be found in all the histories of the Italian Risorgimento (see under ITALY). A very important and complete work on the events of Rome in 1848-49 is G. Trevelyan's *Garibaldi's Defense of the Roman Republic* (London, 1907), which contains a full bibliography. (P. V.)

ROME, a province of modern Italy, co-extensive with the *compartimento* of Lazio, but really covering a considerably larger area than the ancient Latium, even including Latium adjectum. On the S.E. and E. alone it does not extend so far, the boundary being that between the former papal states and the kingdom of Naples, running from a point S.E. of Terracina along the eastern edge of the Volscian mountains to Ceprano, and thence along the Liris valley. It then runs N.E. through the mountains to Carsoli, being continuous with the Abruzzi; it then includes part of the ancient Sabine country, reaching the Tiber near the railway station of Fara Sabina, 25 m. N. of Rome. It follows the river for some distance, where it is continuous with Umbria, and then runs S.W. to the coast, where it is continuous with the province of Grosseto (Tuscany), thus including a considerable portion of the ancient Etruria. The resident population in 1901 was estimated at 1,196,000 (including Rome itself, 520,196), and the floating population, Italian and foreign, 54,383. In 1907 the total number was calculated at 1,278,000. In 1871 the aggregate population was only 836,704. Emigration rose from 2222 in 1896 to 18,507 in 1906, there being a great rise in 1905, as over all Italy. The economic crisis in the United States in 1907, led, however, to a set-back, many emigrants being obliged to return to Italy for lack of work. Alum is extracted from the mines principally near Tolfa. At Flettino above Subiaco asphaltic rock is obtained, and salt from a rocksalt mine near Corneto Tarquinia. Chemical fertilizers are manufactured by several firms. The main industries of the district are, however, agricultural (see LATIUM).

ROME, a city and the county-seat of Floyd county, in the N.W. part of Georgia, U.S.A., at the junction of the Etowah and

Oostanaula rivers, which here form the Coosa. Pop. (1900) 7291, of whom 2830 were negroes; (1910) 12,000. It is served by the Central of Georgia, the Western & Atlantic (leased by the Nashville, Chattanooga & St Louis), the Southern and the Rome & Northern railways, and the Coosa river is navigable from this point to the falls of the river in Alabama. The city is the seat of Shorter College (for women), which was established in 1873 as the Cherokee Female College, and received its present name in 1877, when it was rebuilt and endowed by Colonel Alfred Shorter; and of the Berry Industrial School (1902), for mountain boys. Rome is situated in a rich agricultural region producing cotton, cereals, vegetables and fruits, for which it is a trading centre, and is a shipping point for bauxite, mined in the vicinity. Other mineral products of this region are iron, limestone, cement rock, fire-brick clay, coal, slate and marble. Rome's principal manufactures are cotton, cotton-seed oil, lumber, foundry and machine-shop products, bricks and agricultural implements. Its site was originally within the territory of the Cherokee, and on the other side of the Oostanaula river there is said to have been at one time an Indian village, which, like several other Creek villages, was called Chiaha (or Chehaw). Here, in October 1703, in his Etowah campaign, John Sevier, with militia from Tennessee, crushed a party of marauding Indians; the battle is commemorated by a monument in Myrtle Hill cemetery. Floyd county was erected in 1833. The first settlement of Rome was made in 1834, and immediately afterwards it became the county-seat. Rome was first chartered as a city in 1847. In 1863 there were brilliant cavalry manoeuvres in its vicinity, which resulted in the capture (May 3) of Colonel Abel D. Straight (Federal) with 1800 men by General Nathan B. Forrest (Confederate), with a force one-third the size of that of his opponent. On the 19th of May 1864 the city was captured by a detachment of the Federal Army of General William T. Sherman, then conducting his Atlanta campaign. In 1848-75 Rome was the home of Charles Henry Smith (1826-1903), a popular humorist, who wrote under the name "Bill Arp." In 1906 East Rome (pop. 671 in 1900) and North Rome (pop. 960 in 1900), which was formerly called Forestville, were annexed to the city.

ROME, a city of Oneida county, New York, U.S.A., on the Mohawk river and Wood Creek, and the Erie and the Black river canals, 14 m. N.W. of Utica. Pop. (1890) 14,991; (1900) 15,343, of whom 2527 were foreign-born; (1910, census) 20,497. Rome is served by the New York Central & Hudson River, the Rome, Watertown & Ogdensburg (controlled by the New York Central), the New York, Ontario & Western, and the Utica & Mohawk Valley (electric) railways. It is about 450 ft. above sea-level. The city is the seat of the Academy of the Holy Names (opened in 1865 as St Peter's Academy), of the State Custodial Asylum for unteachable idiots, of the Central New York Institution for Deaf Mutes (1875), and of the Oneida County Home. The Jervis Public Library (1895), founded by John Bloomfield Jervis (1705-1885), a famous railway engineer, had in 1900 about 15,000 volumes. The surrounding country is devoted largely to farming, especially vegetable gardening, and to dairying. Among the manufactures are brass and copper work, wire for electrical uses, foundry and machine-shop products, locomotives, knit goods, tin cans and canned goods (especially vegetables). In 1905 the value of the factory products was \$8,631,427 (55.6% more than in 1900).

The portage at this place between the Mohawk river and Wood Creek, which are about 1 m. apart, gave the site its Indian name, De-o-wain-sta, "place where canoes are carried from one stream to another," and its earliest English name, "The Great (or Oneida) Carrying-Place," and gave it strategic value as a key between the Mohawk Valley and Lake Ontario. About 1725 there were built, to protect the carrying-place here, Fort Bull, on Wood Creek, which was surprised and taken by French and Indians in March 1756, and Fort Williams, on the Mohawk, which, like Fort Craven, also on the Mohawk, was destroyed by Colonel Daniel Webb after the reduction of Oswego by the French

In August 1756. General John Stanwix built Fort Stanwix here at an expense of £60,000, and the first permanent settlement dates from about this time. In October-November 1768, Sir William Johnson and representatives of Virginia and Pennsylvania met 3200 Indians of the Six Nations here and made a treaty with them, under which, for £10,460 in money and provisions, they surrendered to the crown their claims to what is now Kentucky and West Virginia and the western part of Pennsylvania. Of this cession the part which lay in Pennsylvania was secured by purchase from the Indians for the proprietors Richard and Thomas Penn (see PITTSBURG). The fort was dismantled immediately afterward. After 1776, when it was partly repaired by Colonel Elias Dayton, it was called by the continentals Fort Schuyler, in honour of General Philip Schuyler, and so is sometimes confused with (old) Fort Schuyler at Utica. The third regiment of the New York line under Colonel Peter Gansevoort occupied the fort in April 1777 and completed the repairs begun in 1776; on the 3rd of August in the same year (one month before the official announcement by Congress of the design of the flag) the first flag of the United States, made according to the enactment of the 14th of June and used in battle, was raised here: it was made from various pieces of cloth. On the 2nd of August an advance party of Colonel Barry St Leger's forces coming from the west arrived before the fort, and the main body (altogether about 650 whites, including loyalists—the Royal Greens—under Sir John Johnson, and more than 800 Indians, some led by Joseph Brant) arrived soon afterwards. The fort then contained about 750 men under Colonel Gansevoort, with Lieut.-Colonel Marinus Willett as second in command. The danger to the fort roused General Nicholas Herkimer to gather a force of between 700 and 1000 men (including some Oneida Indians), who during their advance on the 6th of August were ambuscaded in a ravine near Oriskany (q.v.), about 8 m. E. of the fort; after heavy losses to both sides, about 250 men from the fort under Willett attacked the camp of the Indians who were supporting St Leger, thus relieved Herkimer through the falling back of the British and Indians to save their supplies, captured five ensigns of the Royal Greens, and seized large quantities of stores from the enemy's camp. The siege now lost force, the Indians straggled away after the loss of their camp supplies, and on the 23rd of August, St Leger, hearing exaggerated reports of the immediate approach of large reinforcements under General Benedict Arnold, withdrew, abandoning his camp and stores. The successful resistance here to St Leger contributed greatly to the American success at Saratoga. Fort Stanwix was the headquarters of Colonel Gozen Van Schaick (1736-1789) in 1779 when he destroyed the Onondaga villages. At the fort, on the 22nd of October 1784, a treaty was made by Oliver Wolcott, Richard Butler and Arthur Lee, commissioners for the United States, with the chiefs of the Six Nations. In 1796 a canal was built across the old portage between Wood Creek and the Mohawk river. In 1796 the township of Rome was formed, receiving its name, says Schoolcraft, "from the heroic defence of the republic made here." The village of Rome, in the centre of the township, was incorporated in 1819; and Rome was chartered as a city in 1870.

See Pomroy Jones, *Annals and Recollections of Oneida County* (Rome, 1851); W. M. Willett, *A Narrative of the Military Actions of Col. Marinus Willett* (New York, 1831); and *Orderly Book of Sir John Johnson during the Oriskany Campaign* (Albany, 1882), with notes by W. L. Stone and J. W. Peyster.

ROMÉ DE L'ISLE, JEAN BAPTISTE LOUIS (1736-1790), French mineralogist, was born on the 26th of August 1736 at Gray, in Haute-Saône. As secretary of a company of artillery he visited the East Indies, and was taken prisoner by the English in 1761 and held in captivity for three years. Subsequently he became distinguished for his researches on mineralogy and crystallography. He was the author of *Essai de Cristallographie* (1772), the second edition of which, regarded as his principal work, was published as *Cristallographie* (3 vols. and atlas, 1783). He died at Paris on the 7th of March 1790.

ROMESH CHANDRA MITRA, SR (1840-1890), Indian judge, was born in 1840. When the East India Company's charter was renewed in 1853, the old supreme courts and sadr courts in the presidency towns were changed into high courts, and Roma Prasad Roy, son of the great reformer Raja Ram Mohan Roy, was the first Indian who was appointed a judge of the new high court of Calcutta. He did not live, however, to take his seat on the bench, and was succeeded by Sambhu Nath Pandit, and then by Dwarka Nath Mitra, perhaps the most talented judge that India produced in the 19th century. Dwarka Nath's great ability and thorough insight into cases were universally recognized in India; his decisions were valued and often quoted; and his name was often mentioned as an illustration of the judicial capacity of the natives of India. Anukul Chandra Mukerji also sat on the bench for a time; and on his death in 1871, Romesh Chandra Mitra was appointed judge in his place. He maintained the high reputation of his predecessors, and for a period of nearly twenty years, down to 1890, he performed his judicial duties with credit and distinction. When the post of chief justice was temporarily vacant in 1882, the marquis of Ripon, then viceroy of India, appointed Romesh Chandra to officiate in that post—the highest judicial position in the Indian empire. Lord Dufferin, who succeeded Lord Ripon as viceroy of India, appointed Romesh Chandra a member of the Public Service Commission, and in this capacity he did valuable work. Failing health compelled him to retire from the high court in 1890, and he was then knighted and appointed a member of the viceroy's legislative council. Till he died in 1890, he continued to take interest in all social, educational and political reforms in India.

ROMFORD, a market town in the Romford parliamentary division of Essex, England; on the small river Rom, which flows into the Thames; 12½ m. E.N.E. from London by the Great Eastern railway. Pop. of urban district (1901) 13,656. The ancient church of St Edward the Confessor was replaced in 1850 by a structure in Decorated style. There is a large brewery in the town, and extensive market gardens in the neighbourhood. A grant of a market was obtained in 1247, and this is still of importance as regards both cattle and corn. Romford was included in the liberty of Havering-atte-Bower, which until 1892 had a jurisdiction of its own distinct from that of the county, with a high steward, magistrates, clerk of the peace, coroner and quarter sessions. The name of Bower was derived from a queen's residence attached to the ancient royal hunting-lodge in the vicinity.

The fact that Romford (*Rumford*, *Rompford*) lies on the high road between Colchester and London has determined its history. Bronze implements have been found here, but no notice of Romford occurs till the 12th century. It was included in the liberty of Havering, and the chief business of the liberty was conducted there. But the corporation which is mentioned in medieval records is not that of the town of Romford, but of the liberty of Havering. Romford has only had a separate constitution since a local board of health was formed in 1894, under the act of 1875, after the abolition of the liberty in 1892. In the middle ages Romford was rather a meeting-place for merchants than an industrial centre. Brewing, however, is mentioned in 1331, and one tanner at least carried on business in Hare Street in 1467.

ROMILLY, JOHN ROMILLY, 1ST BARON (1802-1874), English judge, was the second son of Sir Samuel Romilly, and was born on the 10th of January 1802. He was educated at Trinity College, Cambridge, and was called to the bar at Gray's Inn in 1827. He first entered parliament in 1832 as member for Bridport, and in 1843 he became a queen's counsel. He was elected M.P. for Devonport in 1847, and was appointed solicitor-general in 1848 in Lord John Russell's administration and attorney-general in 1850. In 1851 he was appointed master of the rolls, and continued to sit for Devonport till the general election in 1852, when he was defeated. He was the last master of the rolls to sit in parliament. Romilly was raised to the peerage as Baron Romilly of Barry in 1866, and

retired from the mastership of the rolls in 1873. He did much to remove the restrictions which had long hampered research among the public records and state papers. Lord Romilly died in London on the 23rd of December 1874.

ROMILLY, SIR SAMUEL (1757-1818), English legal reformer, was the second son of Peter Romilly, a watchmaker and jeweller in London, whose father had emigrated from Montpellier after the revocation of the edict of Nantes, and who had married Margaret Garnaut, a Huguenot refugee like himself, but of a far wealthier family. Samuel Romilly was born in Frith Street, Soho, on the 1st of March 1757. He served for a time in his father's shop; but his education was not neglected, and he became a good classical scholar and particularly conversant with French literature. A legacy of £2000 from one of his mother's relations led to his being articled to a solicitor and clerk in chancery with the idea of qualifying himself to purchase the office of one of the six clerks in chancery. In 1778, however, he determined to go to the bar, and entered himself at Gray's Inn. He went to Geneva in 1781, where he made the acquaintance of the chief democratic leaders, including Etienne Dumont. Called to the bar in 1783, he went the midland circuit, but was chiefly occupied with chancery practice. On the publication of Madan's *Thoughts on Executive Justice*, advocating the increase of capital punishments, he at once wrote and published in 1786 *Observations on Madan's book*. Of more general interest is his intimacy with the great Mirabeau, to whom he was introduced in 1784. Mirabeau saw him daily for a long time and introduced him to Lord Lansdowne, who highly appreciated him, and, when Mirabeau became a political leader, it was to Romilly that he applied for an account of the procedure used in the English House of Commons. He visited Paris in 1789, and studied the course of the Revolution there; and in 1790 he published his *Thoughts on the Probable Influence of the Late Revolution in France upon Great Britain*, a work of great power. His practice at the chancery bar continued largely to increase, and in 1800 he was made a K.C. In 1798 he married Anne, daughter of Francis Garbett of Knill Court, Herefordshire; and in 1805 he was appointed chancellor of the county palatine of Durham. His great abilities were thoroughly recognized by the Whig party, to which he attached himself; and in 1806, on the accession of the ministry of "All the Talents" to office, he was offered the post of solicitor-general, although he had never sat in the House of Commons. He accepted the office, and was knighted and brought into parliament for Queenborough. He went out of office with the government, but remained in the House of Commons, sitting successively for Horsham, Wareham and Arundel. It was now that Sir Samuel Romilly commenced the greatest labour of his life, his attempt to reform the criminal law of England, then at once cruel and illogical. By statute law innumerable offences were punished by death, but, as such wholesale executions would be impossible, the larger number of those convicted and sentenced to death at every assizes were respited, after having heard the sentence of death solemnly passed upon them. This led to many acts of injustice, as the lives of the convicts depended on the caprice of the judges, while at the same time it made the whole system of punishments and of the criminal law ridiculous. Romilly saw this, and in 1808 he managed to repeal the Elizabethan statute, which made it a capital offence to steal from the person. This success, however, raised opposition, and in the following year three bills repealing equally sanguinary statutes were thrown out by the House of Lords under the influence of Lord Ellenborough. Year after year the same influence prevailed, and Romilly saw his bills rejected; but his patient efforts and his eloquence ensured victory eventually for his cause by opening the eyes of Englishmen to the barbarity of their criminal law. The only success he had was in securing the repeal, in 1812, of a statute of Elizabeth making it a capital offence for a soldier or a mariner to beg without a pass from a magistrate or his commanding officer. Sir Samuel Romilly's efforts made his name famous not only in England but all over Europe, and in 1818 he had the honour of being returned at the head of the

poll for the city of Westminster. He did not long survive his triumph. On the 29th of October 1818 Lady Romilly died in the Isle of Wight. Her husband's grief was intense, and he committed suicide in a fit of temporary insanity on the 2nd of November. No man of his time was more loved than Sir Samuel Romilly; his singularly sweet nature, his upright manliness, his eloquence and his great efforts on behalf of humanity secured him permanent fame.

See the *Memoirs of the Life of Sir Samuel Romilly written by himself, with a selection from his Correspondence, edited by his Sons* (3 vols., 1840); *The Speeches of Sir Samuel Romilly in the House of Commons* (2 vols., 1820); "Life and Work of Sir Samuel Romilly," by Sir W. J. Collins, in *Trans. of the Huguenot Society* (1908).

ROMILLY-SUR-SEINE, a town of north-central France, in the department of Aube, a mile from the left bank of the Seine and 24 m. N.W. of Troyes, on the Paris-Belfort line. Pop. (1906) 9777.

Romilly is an important industrial town, with extensive manufactures of cotton and woollen hosiery, and of the special machinery and appliances required for the industry. The Eastern Railway Company has large workshops here.

ROMINTEN, a village of Germany, in the province of East Prussia, 12 m. N.E. from Goldap, situated in the Rominter Heide, a fine tract of heath and forest country, 90 sq. m. in extent, well stocked with game and affording excellent sport. Here is a favourite hunting-box of the German emperor, with a church adjacent, both in the Norwegian style. Pop. 1200.

See K. E. Schmidt, *Die Rominter Heide* (Danzig, 1898).

ROMNEY, GEORGE (1734-1802), English historical and portrait painter, was born at Dalton-in-Furness, Lancashire, on the 26th of December 1734. His father was a builder and cabinet-maker of the place, and the son, having manifested a turn for mechanics, was instructed in the latter craft, showing considerable dexterity with his fingers, executing carvings of figures in wood, and constructing a violin, which he spent much time in playing. He was also busy with his pencil; and some of his sketches of the neighbouring rustics having attracted attention, his father was at length induced to apprentice the boy, at the age of nineteen, to an itinerant painter of portraits and domestic subjects named Steele, an artist who had studied in Paris under Vanloo; but the erratic habits of his instructor prevented Romney from making great progress in his art. In 1756 he impulsively married a young woman who had nursed him through a fever, and started as a portrait painter on his own account, travelling through the northern counties, executing likenesses at a couple of guineas, and producing a series of some twenty figure compositions, which were exhibited in Kendal, and afterwards disposed of by means of a lottery.

Having, at the age of twenty-seven, saved about £100, he left a portion of the sum with his wife and family, and started to seek his fortune in London, never returning, except for brief visits, till he came, a broken-down and aged man, to die. Credit must, however, be given him for recognizing to some extent his family responsibilities. He did not allow his wife and children to fall into poverty, and he gave help to his brothers, who seem to have resembled him in a kind of shiftlessness of temperament. In London he rapidly rose into popular favour. His "Death of General Wolfe" was judged worthy of the second prize at the Society of Arts, but a word from Reynolds in praise of Mortimer's "Edward the Confessor" led to the premium being awarded to that painter, while Romney had to content himself with a donation of £50, an incident which led to the subsequent coldness between him and the president which prevented him from exhibiting at the Academy or presenting himself for its honours.

In 1764 he paid a brief visit to Paris, where he was befriended by Joseph Vernet; and his portrait of Sir Joseph Yates, painted on his return, bears distinct traces of his study of the works of Rubens then in the Luxembourg Gallery. In 1766 he became a member of the Incorporated Society of Artists, and three years later he seems to have studied in their schools-

Soon he was in the full tide of prosperity. He removed to Great Newport Street, near the residence of Sir Joshua, whose fame in portraiture he began to rival in such works as "Sir George and Lady Warren" and "Mrs Yates as the Tragic Muse"; and his professional income rose to £1200 a year. But this marked increase in his popularity had the effect of enlarging his ambitions, and he became anxious to attempt subjects which required more experience than he possessed. Realizing as he did the need for more thorough knowledge, he was seized with a longing to study in Italy; and in the beginning of 1773 he started for Rome in company with Ozias Humphrey, the miniature painter. On his arrival he separated himself from his fellow-traveller and his countrymen, and devoted himself to solitary study, raising a scaffold to examine the paintings in the Vatican, and giving much time to work from the undraped model, of which his painting of a "Wood Nymph" was a fine and graceful result. At Parma he concentrated himself upon the productions of Correggio, which fascinated him and greatly influenced his practice.

In 1775 Romney returned to London, establishing himself in Cavendish Square, and resuming his extensive and lucrative employment as a portrait painter, which in 1785, according to the estimate of his pupil Robinson, yielded him an income of over £3600. The admiration of the town was divided between him and Reynolds. "There are two factions in art," said Lord Thurlow, "and I am of the Romney faction"—and the remark, and the rivalry which it implied, caused much annoyance to Sir Joshua, who was accustomed to refer contemptuously to the younger painter as "the man in Cavendish Square." After his return from Italy Romney formed two friendships which powerfully influenced his life. He became acquainted with Hayley, his future biographer, then in the zenith of his little-merited popularity as a poet. His influence on the painter seems to have been far from salutary. Weak himself, he flattered the weaknesses of Romney, encouraged his excessive and morbid sensibility, disturbed him with amateurish fancies and suggestions, and tempted him to expend on slight rapid sketches, and ill-considered, seldom-completed paintings of ideal and poetical subjects, talents which would have found fitter exercise in the steady pursuit of portraiture. About 1783 Romney was introduced to Emma Hart, afterwards celebrated as Lady Hamilton, and she became the model from whom he worked incessantly. Her bewitching face smiles from numerous canvases; he painted her as a Magdalene and as a Joan of Arc, as a Circe, a Bacchante, a Cassandra; and he has himself confessed that she was the inspirer of what was most beautiful in his art. But her fascinations seem to have been too much for the more than middle-aged painter, and they had their own share in aggravating that nervous restlessness and instability, inherent in his nature, which finally ruined both health and mind.

In 1786 Alderman Boydell started his great scheme of the Shakespeare Gallery, apparently at the suggestion of Romney. The painter at last entered heartily into the plan, and contributed his scene from the *Tempest*, and his "Infant Shakespeare attended by the Passions," the latter characterized by the Redgraves as one of the best of his subject pictures. Gradually he began to withdraw from portrait painting, to limit the hours devoted to sitters, and to turn his thoughts to mighty schemes of the ideal subjects which he would execute. Already, in 1792, he had painted "Milton and his Daughters," which was followed by "Newton making Experiments with the Prism." He was to paint the Seven Ages, Visions of Adam with the Angel, "six other subjects from Milton—three where Satan is the hero, and three from Adam and Eve,—perhaps six of each." Having planned and erected a large studio in Hampsstead, he removed thither in 1797, with the fine collection of casts from the antique which his friend Flaxman had gathered for him in Italy. But his health was now irremediably shattered, and the man was near his end. In the summer of 1799, suffering from great weakness of body and the profoundest depression of mind, he returned to the north, to Kendal, where

his deserted but faithful and long-suffering wife received and tended him. He died on the 15th of November 1802.

The art of Romney, especially his figure subjects, suffered greatly from the waywardness and instability of the painter's disposition, from his want of fixed purpose and sustained energy. He lacked the steadfast perseverance needful to the accomplishment of a great picture. Afflicted as he was throughout his life by an unreasonable timidity and by a self-consciousness which led him at one moment into assertive affectations and at another into exaggerated humility, he avoided the society of his brother artists and lost many opportunities of receiving that frank professional criticism which might have stimulated him to more serious effort. In unwholesome surroundings he steadily deteriorated. His imagination flashed and flickered fitfully upon him, like April sunshine. His fancy would be captivated by a subject, which was presently embodied in a sketch, but the toil of elaborating it into the finished completeness of a painting too frequently overtaxed his powers; he became embarrassed by technical difficulties which, through defective early training, he was unable to surmount, and the half-covered canvas would be turned to the wall. Even in the pictures he finished he was unable to keep to any consistent level of achievement. He produced some fine things, very personal in style and very skillful in handling; but much that he did seems too tentative and too plainly deficient in shrewdness of insight to deserve serious consideration. His colour, too, was often unpleasant, hot and monotonous, and his composition was apt to be stilted and artificial. It is in the best of his portraits that we feel the painter's real ability. These, especially his female portraits, are full of grace, charm, distinction, and sweetness. When we examine his heads of Cowper and Wilkes, his delicate and dignified full-length of William Beckford, his "Parson's Daughter" in the National Gallery, and his group of the Duchess of Gordon and her Son, we cannot deny his claim to rank as one of the notable portrait painters of 18th-century England.

See the *Memoirs* by William Hayley (1809) and by the artist's son, the Rev. John Romney (1830); *Cunningham's Lives of the Painters*; *George Romney and his Art*, by Hilda Gamlin (1894). In the fully illustrated *George Romney*, by Lord Ronald Sutherland Gower (1904), pictures, mainly studies, are reproduced not elsewhere to be found. But the great work upon the artist is *Romney*, by Humphry Ward and W. Roberts (1904), a monograph of real importance, containing 70 illustrations, a biographical and critical essay, and a *catalogue raisonné* of the painter's works. Arthur B. Chamberlain's *Romney* (1910) has 73 plates.

ROMNEY, HENRY SIDNEY, EARL OF (1641-1704), fourth son of Robert, 2nd earl of Leicester, was born in Paris in 1641. He and his nephew, Robert Spencer, afterwards 2nd earl of Sunderland, his senior by a few months, were sent to travel on the continent of Europe in charge of a Calvinist divine, Dr Thomas Pierce. Sidney's handsome face helped his advancement at court, but the favour in which he was held by the duchess of York, to whom he was master of the robes, led to his dismissal in 1666. His disgrace, however, was short-lived. He was promoted captain in 1667, and colonel in 1678. In 1672 he was sent on a mission of congratulation to Louis XIV., and in 1677 became master of the robes to Charles II. He entered parliament as member for Bramber in 1679, and became a close political ally of his nephew Sunderland, with whose wife he carried on an intrigue which caused considerable scandal. Sunderland made this intimacy a means to further his political ends, while Sidney's social reputation and his apparent frivolity partly concealed his real capacity for intrigue. Sidney was sent by Sunderland and others in 1679 on a special mission to urge William of Orange to visit England, a task that he was able to discharge while acting as the official envoy of Charles II. at the Hague. He was recalled in 1682, but was again sent on a special mission to Holland in the year of the accession of James II. He returned to England in the spring of 1688, and set to work, at William's desire, to obtain promises of support for the prince of Orange in the event of his landing. He was presently allowed to leave England on giving his word not to visit the

Hague, but he broke his promise on getting clear of England, and conveyed to William a duplicate of the invitation addressed to him by the English nobility, together with intelligence of affairs of state obtained through the countess of Sunderland. He landed with William at Torbay, and received substantial rewards for his undoubted services. Sworn of the privy council in 1689, Sidney was made gentleman of the bedchamber and colonel of the king's regiment of footguards, and received the titles of Baron Milton and Viscount Sidney of Sheppey. In 1690 he received considerable grants of land from the confiscated estates of the Irish supporters of James II., much of which he lost, however, on the parliamentary investigation in 1699 into the distribution of the Irish lands. William made him secretary of state in 1690, pending the discovery of a better person. He was soon asked to resign, but was compensated by his appointment, in 1692, as lord-lieutenant of Ireland. His inability to cope with the difficulties of this position led to his recall in the next year, when he became master-general of the ordnance. He was created earl of Romney in May 1694, and he retained William's confidence to the last, but on Anne's accession he was dismissed from his various offices. He never married, and his titles became extinct on his death on the 8th of April 1704.

In 1801 the title of earl of Romney was revived in the family of Marsham. Sir Robert Marsham, Bart. (1685-1724), of Cuxton in Kent, was a member of parliament from 1708 to 1716, when he was created Baron of Romney. His grandson Charles, the 3rd Baron (1774-1811), was created earl of Romney in 1801, and from him the present earl is descended.

ROMNEY (NEW ROMNEY), a municipal borough and one of the Cinque Ports in the Ashford parliamentary division of Kent, England, 75 m. S.E. by E. of London by the South-Eastern & Chatham railway. Pop. (1901) 1328. It lies in the open, flat and low tract of Romney Marsh, part of a level extending from Winchelsea in the south-west to Hythe in the north-east, which was within historic times in great part covered by an estuarine inlet of the sea. The river Rother, which now has its mouth at Rye Harbour, formerly entered the sea here, but had its course wholly changed during a great storm in 1287, and the gradual accretion of land led to the decay, not only of Romney, but of Winchelsea and Rye as seaports. Romney Marsh itself, which extends north of New Romney, is protected by a seawall of great thickness, and its guardianship and drainage is in the hands of a special ancient corporation. The level affords pasturage for vast flocks of sheep. New Romney, which is now over a mile from the sea, has large sheep fairs, but little other trade. Of the five churches mentioned here in the Domesday Survey only one remains, but this, dedicated to St Nicholas, is a rich Norman building with later additions. Its Norman west tower is among the finest in England, and it has a beautiful Decorated east window with reticulated tracery. New Romney, the name of which distinguishes it from the decayed village of Old Romney, 2 m. W., is governed by a mayor, 4 aldermen and twelve councillors. Area, 1351 acres. **LITTLESTONE-ON-SEA**, on the coast E. of New Romney, is in some favour as a seaside resort and has excellent golf-links.

Its fine harbour was the cause of the early importance of Romney (Romenal, Romenhall). The annual assembly of the Cinque Ports, called the Brodhull, was held here owing to its central position. At the time of Domesday the archbishop of Canterbury and the bishop of Bayeux were joint lords. Romney also owed maritime service to the king, which consisted of supplying five ships to serve for fifteen days in the year. A confirmation of liberties was granted by John in 1205. The town, which was a borough by prescription, was governed "from time immemorial" by twelve jurors; a bailiff was appointed by the archbishop, but the rights of the overlord seem to have been small, and in 1521 the inhabitants denied the bailiff the right of presiding with the jurors over their court. Elizabeth changed the style of incorporation to the mayor, jurors and commonalty, and another charter was granted by James II. in 1686, which remained the governing charter until 1835. The Cinque Ports

were first summoned to parliament in 1265; the first returns for Romney are for 1266; it returned two members until it was disfranchised in 1832.

ROMORANTIN, a town of central France, capital of an *arrondissement* in the department of Loir-et-Cher, 31 m. S.E. of Blois by rail. Pop. (1906) town, 6836; commune, 8374. The town is situated on the Saultre at its confluence with the Morantin, whence its name (*Rivus Morantini*). A church dating mainly from the 12th century, a gateway of the 16th century and some old houses are the chief objects of interest. The remains of a château rebuilt by Francis I. in the Renaissance style are used as the sub-prefecture. Tribunals of first instance and of commerce, and a communal college are among the public institutions. The manufacture of flannel and cloth especially for army clothing is carried on, together with trade in wine, live stock, agricultural produce and the asparagus of the vicinity.

In 1560 Romorantin gave its name to an edict which prevented the introduction of the Inquisition into France. The industrial importance of the town dates from the later middle ages.

ROMSDAL, the valley of the river Rauma, in Norway. The Rauma is a torrent descending from Lake Lesjokogen to the Romsdal Fjord on the west coast (62° 30' N.). The nearest port is Molde, from which steamers run to Vebungssnaes (30 m.) at the foot of the valley. A good road traverses the valley, which is one of the finest in southern Norway, flanked by steep mountains terminating in abrupt peaks—Vengetinder (5960 ft.), Romsdalshorn (5105), Troldtinder ("witch-peaks," 6010) and others. Several waterfalls are seen, such as the Mongefos, and the Vaermovef, falling nearly 1000 ft., and the Slettafos. Lake Lesjokogen also drains from the opposite end by the Laagen or Lougen river to the Glommen, and so to the Skagerrack, and the road follows its valley, the Gudbrandsdal. The Romsdal gives its name to an *amt* (county) extending from the promontory of Stadt in the south to Ram Fjord in the north, including the Stor, Molde, Halse and their branch fjords, the ports of Aalesund, Molde and Christiansund, and reaching inland to the Dovrefjeld.

ROMSEY, a market town and municipal borough in the New Forest parliamentary division of Hampshire, England, 7 m. N.W. of Southampton by the London & South-Western railway. Pop. (1901) 4365. It is pleasantly situated in the rich valley of the Test. The abbey church of SS. Mary and Eilfeda is one of the finest examples in England of a great Norman church little altered by later builders. Its history is not clear, but a house was founded here by Edward the elder (c. 910), and became a Benedictine nunnery. The church, which is the only important relic of the foundation, is cruciform, with a low central tower. Building evidently began in the first half of the 12th century, and continued through it, as the western part of the nave shows the transition to the Early English style, which appears very finely in the west front. Decorated windows occur in the east end, beyond which a chapel in this style formerly extended. Perpendicular insertions are insignificant. The nave and choir have aisles, triforium and clerestory. The transepts have eastern apsidal chapels, as have the choir aisles, though the walls of these last are square without. Foundations of the apse of a large pre-Norman church have been discovered below the present building. In Romney there are tanyards, ironworks and works of the Berthon Boat Company. The borough is under a mayor, 4 aldermen and 12 councillors. Area, 533 acres.

Romsey (*Romesyng, Romesie*) probably owed its origin, as it did its early importance, to the abbey. At the time of the Domesday Survey it was owned by the abbey, which continued to be the overlord until the dissolution. There is no evidence to show that Romsey was a borough before the charter of incorporation granted by James I. in 1608. This was confirmed by William III. in 1692, and the corporation was reformed in 1835. Romsey has never been represented in parliament. The right to hold a fair was granted to the abbey by Henry III.

in 1271, and fairs were held on Easter Monday, on August 26 and November 8. The market now held on Thursday, formerly on Saturday, dates from 1272. Every alternate Thursday is a great market. In medieval times Rome had a considerable share of the woollen trade of Hampshire, but by the end of the 17th century this manufacture began to decline, and the introduction of machinery and the adoption of steam led to its subsequent transference to the northern coal centres. The clothing trade was replaced by the manufacture of paper, an industry which still exists.

ROMULUS, the legendary eponymous founder and first king (753-716?) of Rome, represented as the son of Mars by the Vestal Rhea Silvia or Ilia, daughter of Numitor, who had been dispossessed of the throne of Alba by his younger brother Amulius. Romulus and Remus, the twin sons of Silvia, were placed in a trough and cast into the Tiber by their granduncle. The trough grounded in the marshes where Rome afterwards stood, under the wild fig tree (*figus ruminialis*), which was still holy in later days. The babes were suckled by a she-wolf and fed by a woodpecker, and then fostered by Acca Larentia, wife of the shepherd Faustulus. They became leaders of a warlike band of shepherds on the Palatine, and in course of time were recognized by their grandfather, whom they restored to his throne, slaying the usurper Amulius. They now proposed to found a city on the site where they had been nurtured; but a quarrel for precedence broke out and Remus was slain. Romulus strengthened his band by offering an "asylum" to outcasts and fugitives, found wives for them by capture and waged war with their kinsmen. His most formidable foe was Titus Tatius (*q.v.*), king of the Sabines, but after an obstinate struggle he and Romulus united their forces and reigned side by side till Tatius was slain at Lavinium in the course of a blood-feud with Laurentum. Romulus then reigned alone till he suddenly disappeared in a storm. He was thereafter worshipped as a god under the name of Quirinus, which, however, is really a Sabine form of Mars. The story of Romulus, best preserved in the first book of Livy (see also Dion. Halic. i. 75-ii. 56; Plutarch, *Romulus*; Cicero, *de Republica*, ii. 2-10), belongs throughout to legend. This was felt in later times by the Romans themselves, who gave a rationalistic explanation of the miraculous incidents. Thus, Mars was converted into a stranger disguised as the god of war, and the she-wolf into a woman of ill-fame (*lupa*); Romulus was not taken up into heaven, but put to death and carried away piecemeal by the patricians under their cloaks.

The whole story, probably first given by the annalists Fabius Pictor and Cincius Alimentus, contains religious and aetiological elements. The foundation of the city by twins may be explained by the worship of the Lares, who are generally represented as a pair of brothers, especially as the mother of Romulus and Remus was connected with the worship of the hearth of the state. The introduction of the wolf may be of Greek or eastern origin; it may have a totemistic significance; or may be due to the *figus ruminialis*, the fig tree near the Lupercal on the Palatine, where the twins were first exposed. This tree was sacred to a goddess Rumina (*ruma*, "breast," whence the suckling incident), and the resemblance between Romulus and *ruminialis* led to the fig tree and the founder of the city being subsequently connected by the Roman antiquarians. The wolf would then be suggested by the proximity of the Lupercal, the grotto of Faunus Lupercus, with whom the shepherd Faustulus is identical. According to Professor Ducati of Bologna, in a paper on an old Etruscan stele, on which a she-wolf is represented suckling a child, the wolf legend is an importation from Etruria, the original home of which was Crete. Miletus, son of Apollo and a daughter of Minos, having been exposed by his mother, was suckled by she-wolves, being afterwards found and brought up by shepherds. To escape the designs of Minos, Miletus fled to Asia Minor, and founded the city called after him, where the Etruscans first became acquainted with the legend. The opening of the "asylum" is a Greek addition (as the name itself suggests). Down to imperial times, the Romans seem to have

been ignorant of the Greek custom of taking sanctuary; further, the idea was entirely opposed to the exclusive spirit of the ancient Italians. The story was probably invented to give an explanation of the sacred spot named "Inter duos lucos" between the arx and the Capitol. Another Greek touch is the deification of an eponymous hero. The rape of the Sabine women is clearly aetiological, invented to account for the custom of marriage by capture. Consus, at whose festival the rape took place, was a god of the earth and crops, the giver of fruitfulness in plants and animals. It is generally agreed that the capture of the Capitol by Titus Tatius may contain an historical element, pointing to an early conquest of Rome by the Sabines, of which there are some indications. Subsequently, to efface the recollection of an event so distasteful to Roman vanity and national pride, Sabine names and customs were accounted for by a supposed union of Romans and Sabines during the regal period, the result of a friendly league concluded between Romulus and Tatius. According to E. Pais, Romulus is merely the eponym of Roma; his life is nothing but the course of the sun, and the institutions ascribed to him are the result of long historical development.

Romulus, like his double Tullus Hostilius, is regarded as the founder of the military and political (see **ROME**), as Numa and his counterpart Ancus Marcius of the religious institutions of Rome.

For a critical examination of the story, see Schwieger, *Römische Geschichte*, bks. viii.-x.; Sir George Cornewall Lewis, *Credibility of early Roman History*, chap. 11; W. Ihne, *History of Rome*, i.; Sir J. Seeley, Introduction to his edition of Livy, bk. i.; E. Pais, *Storia di Roma* (1898), i. pt. 1, and *Ancient Legends of Roman History* (Eng. trans., 1906); also O. Gilbert, *Geschichte und Topographie der Stadt Rom im Altertum* (1883-1885).

RONCESVALLES (Fr. *Roncesvaux*), a village of northern Spain, in the province of Navarre; situated on the small river Urrobi, at an altitude of 3220 ft. among the Pyrenees, and within 5 m. from the French frontier. Pop. (1900) 152. Roncesvalles is famous in history and legend for the defeat of Charlemagne and the death of Roland (*q.v.*) in 778. The small collegiate church contains several curious relics associated with Roland, and is a favourite place of pilgrimage. The battle is said to have been fought in the picturesque valley known as Val Carlos, which is now occupied by a hamlet bearing the same name, and in the adjoining defile of Ibaneta. Both of these are traversed by the main road leading north from Roncesvalles to St Jean Pied de Port, in France.

RONCONI, GIORGIO (1810-1890), Italian baritone vocalist, was born in 1810. He learnt singing from his father Domenico, who had been a celebrated tenor in his time, and made his debut in 1831 at Pavia. After singing in Italy for some years with ever-growing success, he appeared for the first time in England, in 1842, as Henry Ashton in *Lucia di Lammermoor*. His success was immediate, and he continued to be one of the most popular artists on the lyric stage until his retirement in 1866. His voice was neither extensive in compass nor fine in quality, but the genius of his acting and the strength of his personality fully atoned for his vocal defects. He was equally at home in comedy and tragedy, and the two parts by which he is best remembered, Rigoletto and Figaro, show conclusively the range of his talent. In his later years Ronconi founded a school of singing at Granada, and he also accepted the post of professor of singing at the Madrid Conservatoire. He died in 1890.

RONDA, a town of southern Spain, in the province of Malaga; on the river Guadiaro and on the Algeciras-Bobadilla railway. Pop. (1900) 20,905. Ronda is built on a high rock nearly surrounded by the Guadiaro, which flows through an abrupt chasm 530 ft. deep and 300 ft. wide, by which the old town is separated from the new. Of the three bridges, one is said to have been built by the Romans, another by the Moors; the most modern (1761) spans the stream in a single arch at a height of about 255 ft. On the edge of the chasm is the alameda or public promenade, commanding a wide and beautiful prospect of the fertile valley or vega and the sierras beyond. The old

part of the town has a Moorish aspect, with narrow, steep and crooked lanes, and still retains some Moorish towers and other mediæval buildings. The Ronda bull-ring is one of the finest in Spain, and can accommodate 10,000 spectators. Ronda has a considerable trade in leather, saddlery, horses, soap, flour, chocolate, wine and hats.

Some remains of an aqueduct and theatre, about 7 m. N. of Ronda, are supposed to represent the *Acinipo* or *Arunda* of ancient geographers. Ronda was taken from the Moors in 1485. It gives its name to the Sierra or Serrania de Ronda, one of the main sections of the coast mountains which rise between the great plain of Andalusia and the Mediterranean.

RONDEAU (Ital. *Rondo*), a structural form in poetry and (in the form of "rondo") in music. In poetry the rondeau is a short metrical structure which in its perfect form consists of thirteen eight- or ten-syllabled verses divided into three strophes of unequal length, and knit together by two rhymes and a refrain. In Clement Marot's time the laws of the rondeau were laid down, and, according to Voiture, in the 17th century, the following was the type of the approved form of the rondeau:—

"Ma foy, c'est fait de moy, car Isabeau
M'a conjuré de luy faire un Rondeau :
Cela me met en une peine extrême.
Quoy treize vers, huit en eau, cinq en ème.
Je luy ferois aussi-tôt un bateau !

En voilà cinq pourtant en un moneau :
Faisons en huit, en invoquant Brodeau,
En puis mettons, par quelque stratagème,
Ma foy, c'est fait !

Si je pouvois encore de mon cerveau
Tirer cinq vers, l'ouvrage seroit beau ;
Mais cependant, je suis dedans l'onzième,
Et si je croy que je fais le douzième
En voilà treize ajustez au niveau.
Ma foy, c'est fait !"

All forms of the rondeau, however, are alike in this, that the distinguishing metrical emphasis is achieved by a peculiar use of the refrain. Though we have a set of rondeaux in the *Rolliad* (written by Dr. Lawrence the friend of Burke, according to Edmund Gosse, who has given us an admirable essay upon exotic forms of verse), it was not till recent years that the form had any real vogue in England. Considerable attention, however, has lately been given in England to the form. Some English rondeaux are as bright and graceful as Voiture's own. Swinburne, who in his *Century of Roundels* was perhaps the first to make the refrain rhyme with the second verse of the first strophe, has brought the form into high poetry. In German, rondeaux have been composed with perfect correctness by Weckherlin, and with certain divergences from the French type by Götze and Fischart; the German name for the form is *rundum* or *ringel-gedicht*.

Although the origin of the refrain in all poetry was no doubt the improviser's need of a rest, a time in which to focus his forces and recover breath for future flights, the refrain has a distinct metrical value of its own; it knits the structure together, and so intensifies the emotional energy, as we see in the Border ballads, in the *Orsiana* of Lord Tennyson, and in the *Sister Helen* of Rossetti. The suggestion of extreme artificiality—of "difficulty overcome"—which is one great fault of the rondeau as a vehicle for deep emotion, does not therefore spring from the use of the refrain, but from the too frequent recurrence of the rhymes in the strophes—for which there is no metrical necessity as in the case of the Petrarchan sonnet. The rondeau is, however, an inimitable instrument of gaiety and grace in the hands of a skilful poet.

RONDEL, a form of verse closely allied to the rondeau (*q.v.*) but distinguished from it by containing fourteen instead of thirteen lines, and by demanding a slightly different arrangement of rhymes. Moreover, the initial couplet is repeated in the middle and again at the close. The arrangement of rhymes is as follows: a, b, b, a; a, b, a, b; a, b, b, a, a, b. This form, which was invented in the 14th century, was largely used in

later mediæval French poetry, but particularly by Charles d'Orléans (1391–1465), the very best of whose graceful creations are all rondels. One of the most famous of this prince's rondels may be given here as a type of their correct construction:—

"Le temps a laissé son manteau
De vent, de froidure et de pluye,
Et s'est vestu de broaudier,
De souleil luisant, cler et beau.
Il n'y a beste ne oyseau
Qu'en son jargon ne chante ou crie:
Le temps a laissé son manteau
De vent, de froidure et de pluye.
Rivière, fontaine et ruisseau
Portent, en livrée jolie,
Gouttes d'argent d'or faverie;
Chascun s'abbille de nouveau;
Le temps a laissé son manteau
De vent, de froidure et de pluye."

The rondel, in French, may begin with either a masculine or a feminine rhyme, but its solitary other rhyme must be of the opposite kind. The rondel was introduced into English in the 15th century, but the early specimens of it are very clumsy. It was revised in the 19th century, but it appears to suit the French better than any other language. Correct examples are found in the poems of Robert Bridges, Dobson, Gosse and Henley. The following, by Austin Dobson, gives an exact impression of what an English rondel should be in all technical respects:—

"Love comes back to his vacant dwelling,—
The old, old Love that we knew of yore !
We see him stand by the open door,
With his great eyes sad, and his bosom swelling.
He makes as though in our arms repelling
He fain would lie as he lay before:—
Love comes back to his vacant dwelling,—
The old, old Love that we knew of yore !
Ah ! who shall help us from over-spelling
That sweet, forgotten, forbidden lore ?
E'en as we doubt, in our hearts once more,
With a rush of tears to our eyelids swelling,
Love comes back to his vacant dwelling,
The old, old Love that we knew of yore !"

Théodore de Banville remarks that the art of the rondel consists in the gay and natural reintroduction of the refrain, which should always seem inevitable, while slightly changing the point of view of the reader. If this is not successfully achieved, "on ne fera que de la marqueterie et du placage, c'est-à-dire, en fait de poésie,—rien!" In Germany, the rondel was introduced, in the 18th century, under the name of *ringel-gedicht*, by Johann Nikolaus Götze (1731–1781), and was occasionally used, in the course of the 19th century, by German poets.

RONDO, a musical form originally derived from the rondel in verse; as may be seen, long before the development of instrumental forms, in some of the *chansons* of Orlando di Lasso. The *rondeau en couplets* of Couperin and his contemporaries shows both in name and form the same connexion with verse. It consists of the alternation between a single neatly rounded phrase and several slightly contrasted episodes (the *couplets*) without any important change of key. Bach enriched it with his wealth of epigram, but did not expand its range.

The later sense of the term covers an important series of the sonata forms (*q.v.*), chiefly found in finales; but rondo-form sometimes occurs in slow movements (e.g. Mozart, *Haffner Serenade*, String Quintet in E flat; Beethoven, Fourth Symphony; Quartet, *Op. 74*, &c.). The single-phrase *ritornello* and short *couplets* of the old form are in the sonata style replaced by a broadly designed melody and well-contrasted episodes in different keys.

If the form of a Bach or Couperin rondo may be represented by *A B A C A D A*, &c., the various forms of the later rondo may be represented somewhat as follows: placing on a horizontal line those parts that are in the main key, and representing other keys by differences of level:—

(i) *Sectional rondos*; i.e. with little or no development or

transition between episode and main theme; very characteristic of Haydn, who, however, often gives it more organization

than appears on the surface— $\begin{matrix} B \\ A & A & A \\ & C & \end{matrix}$ *coda*; very rarely

with no change of key except between tonic major and minor, as in Haydn's famous *Gipsy Rondo*. Frequently the episodes are increased in number or made to recur. Beethoven most clearly shows the influence of Haydn in his frequent use of modifications of this type of rondo in his earlier works, e.g. finales of Sonatas, *Op. 10*, No. 3, *Op. 14*, Nos. 1 and 2. He also applied it very successfully to his early slow movements, as in the Sonatas, *Op. 2*, No. 2, and *Op. 13* (*Pathétique*). The sectional rondo was modernized on a gigantic scale by Brahms in the finale of his G minor Pianoforte Quartet, *Op. 25*; and Schumann's favourite art-forms are various compounds between it and the cognate idea of the dance-tune with one or more "trios," as in the *Novellettes*, the *Arabeske*, and the *Romance* in B major.

(ii) *Rondos influenced by the form of a first movement* (for which see SONATA FORMS). The normal scheme for this, which

is Mozart's favourite rondo-form, is $\begin{matrix} B \\ A & A & A & B & A & B \\ & C & \end{matrix}$ *coda*,

and it is easy to see how it may be applied to sectional rondos, as in the finale of Beethoven's Sonata, *Op. 13*. But it normally implies longer and weightier themes and a higher degree of organization. If the second episode (C) is transformed into an elaborate development of previous material in various keys, the resemblance to first-movement form is increased; the only external difference being the recurrence of A in full after the first episode B (which is treated exactly like the "second subject" of a first movement). As, however, many first movements that do not repeat their exposition (corresponding to A+B in the above rondo-scheme) make a feint of so doing before beginning the development, it is obvious that the blending of rondo and first-movement form may become very complete. In fact, the true criterion of a rondo is, as with all real art-forms, a matter of style rather than of external shape. The well rounded-off, self-repeating, tune-like character of the main theme, and a sense of pleasure and importance in the mere fact of its return (without absolute necessity for dramatic effect) are the distinctive evidences of rondo form and style. This rule is well proved by the case most frequently cited as an exception, the rondo of Beethoven's Sonata in D, *Op. 10*, No. 3; for nothing can be more significant than the way in which its fragmentary opening figure is built up into a self-contained musical epigram and ended with a full close, as contrasted with the way in which the most tuneful of first-movement beginnings (e.g. Beethoven's Quartet in F major, *Op. 59*, No. 1, Trio in B flat, *Op. 97*; Brahms's String Quintet in F major, *Op. 88*) expand gradually into their further course.

The following are some of the more important of many modifications and applications of this form:—

(a) Omission of return of main theme before recapitulation of episode— $\begin{matrix} B \\ A & A & A \\ & C & \end{matrix}$ *coda*—as in Beethoven's G major Concerto, where, however, much happens between the recapitulation of B and the following return of A, and the *coda* is nearly as long as all that has gone before.

(b) A B (A) like a first movement without a development. Here A will be very large and the transition to B important, while B will consist of a considerable number of themes. See the finales of Mozart's E flat String Quartet and C major Quintet, most of his greater slow movements, and many of Beethoven's.

In concertos the only modifying influence the balance between solo and orchestra shows in rondo-form is in the tendency to give the orchestra a large number of subsidiary themes at the outset, which perhaps do not reappear until the *coda*, where, with the aid of the solo, they can round off the design very effectively. Mozart's use of this device is not confined to concertos. (D. F. T.)

RONSARD, PIERRE DE (1524-1585), French poet and "prince of poets" (as his own generation in France called him), was born at the Château de la Poissonnière, near the village of

Couture in the province of Vendômois (department of Loir-et-Cher), on the 11th of September 1524. His family are said to have come from the Slav provinces to the south of the Danube (provinces with which the crusades had given France much intercourse) in the first half of the 14th century. Baudouin de Ronsard or Rossart was the founder of the French branch of the house, and made his mark in the early stages of the Hundred Years' War. The poet's father was named Loys, and his mother was Jeanne de Chaudrier, of a family not only noble in itself but well connected. Pierre was the youngest son. Loys de Ronsard was *maître d'hôtel du roi* to Francis I., whose captivity after Pavia had just been softened by treaty, and he had to quit his home shortly after Pierre's birth. The future Prince of Poets was educated at home for some years and sent to the Collège de Navarre at Paris when he was nine years old. It is said that the rough life of a medieval school did not suit him. He had, however, no long experience of it, being quickly appointed page, first to the king's eldest son François, and then to his brother the duke of Orleans. When Madeleine of France was married to James V. of Scotland, Ronsard was attached to the king's service, and he spent three years in Great Britain. The latter part of this time seems to have been passed in England, though he had, strictly speaking, no business there. On returning to France in 1540 he was again taken into the service of the duke of Orleans. In this service he had other opportunities of travel, being sent to Flanders and again to Scotland. After a time a more important employment fell to his lot, and he was attached as secretary to the suite of Lazare de Baif, the father of his future colleague in the *Pléiade* and his companion on this occasion, Antoine de Baif, at the diet of Spire. Afterwards he was attached in the same way to the suite of the cardinal du Bellay-Langey, and his mythical quarrel with Rabelais dates mythically from this period. His apparently promising diplomatic career was, however, cut short by an attack of deafness which no physician could cure, and he determined to devote himself to study. The institution which he chose for the purpose among the numerous schools and colleges of Paris was the Collège Coqueret, the principal of which was Daurat—afterwards the "dark star" (as he has been called from his silence in French) of the *Pléiade*, and already an acquaintance of Ronsard's from his having held the office of tutor in the Baif household. Antoine de Baif, Daurat's pupil, accompanied Ronsard; Belleau shortly followed; Joachim du Bellay, the second of the seven, joined not much later. Muretus (Jean Antoine de Muret), a great scholar and by means of his Latin plays a great influence in the creation of French tragedy, was also a student here.

Ronsard's period of study occupied seven years, and the first manifesto of the new literary movement, which was to apply to the vernacular the principles of criticism and scholarship learnt from the classics, came not from him but from Du Bellay. *The Défense et illustration de la langue française* of the latter appeared in 1549, and the *Pléiade* (or *Brigade*, as it was first called) may be said to have been then launched. It consisted, as its name implies, of seven writers whose names are sometimes differently enumerated, though the orthodox canon is beyond doubt composed of Ronsard, Du Bellay, Baif, Belleau, Pontus de Tyard (a man of rank and position who had exemplified the principles of the friends earlier), Jodelle the dramatist, and Daurat. Ronsard's own work came a little later, and a rather idle story is told of a trick of Du Bellay's which at last determined him to publish. Some single and minor pieces, an epithalamium on Antoine de Bourbon and Jeanne de Navarre (1550), a "Hymne de la France" (1549), an "Ode à la Paix," preceded the publication in 1550 of the four first books ("first" is characteristic and noteworthy) of the *Odes* of Pierre de Ronsard. This was followed in 1552 by the publication of his *Amours de Cassandre* with the fifth book of *Odes*. These books excited a violent literary quarrel. Marot was dead, but he left a numerous school, some of whom saw in the stricter literary critique of the *Pléiade*, in its outspoken contempt of merely vernacular and medieval forms, in its strenuous advice

to French poetry to "follow the ancients," and so forth, an insult to the author of the *Adolescence Clémentine* and his followers. The French court, and indeed all French society, was just then much interested in literary questions, and a curious story is told of the rivalry that ensued. Mellin de Saint-Gelais, it is said, the chief of the "École Marotique" and a poet of no small merit, took up Ronsard's book and read part of it in a more or less despondingly burlesque fashion before the king. It may be observed that if he did so it was a distinctly rash and uncourtier-like act, inasmuch as, from Ronsard's father's position in the royal household, the poet was personally known and liked both by Henry and by his family. At any rate, Marguerite de Valois, the king's sister, afterwards duchess of Savoy, is said to have snatched the book from Saint-Gelais and insisted on reading it herself, with the result of general applause. Henceforward, if not before, his acceptance as a poet was not doubtful, and indeed the tradition of his having to fight his way against cabals is almost entirely unsupported. His popularity in his own time was overwhelming and immediate, and his prosperity was unbroken. He published his *Hymns*, dedicated to Marguerite de Savoie, in 1553; the conclusion of the *Amours*, addressed to another heroine, in 1556; and then a collection of *Œuvres complètes*, said to be due to the invitation of Mary Stuart, queen of Francis II., in 1560; with *Élégies, mascarades et bergeries* in 1565. To this same year belongs his most important and interesting *Abrégé de l'art poétique français*.

The rapid change of sovereigns did Ronsard no harm. Charles IX., who succeeded his brother after a very short time, was even better inclined to him than Henry and Francis. He gave him rooms in the palace; he bestowed upon him divers abbacies and priories; and he called him and regarded him constantly as his master in poetry. Neither was Charles IX. a bad poet. This royal patronage, however, had its disagreeable side. It excited violent dislike to Ronsard on the part of the Huguenots, who wrote constant pasquinades against him, strove (by a ridiculous exaggeration of the Dionysiac festival at Arcueil, in which the friends had indulged to celebrate the success of the first French tragedy, Jodelle's *Cléopâtre*) to represent him as a libertine and an atheist, and (which seems to have annoyed him more than anything else) set up his follower Du Bartas as his rival. According to some words of his own, which are quite credible considering the ways of the time, they were not contented with this variety of argument, but attempted to have him assassinated. During this period Ronsard's work was considerable but mostly occasional, and the one work of magnitude upon which Charles put him, the *Françoïade* (1572), has never been ranked, even by his most devoted admirers, as a chief title to fame. The metre (the decasyllable) which the king chose could not but contrast unfavourably with the magnificent alexandrines which Du Bartas and Agrippa d'Aubigné were shortly to produce; the general plan is feebly classical, and of the very language has little or nothing of that racy mixture of scholarship and love of natural beauty which distinguishes the best work of the Pléiade. The poem could never have had an abiding success, but at its appearance it had the singular bad luck almost to coincide with the massacre of St Bartholomew, which had occurred about a fortnight before its publication. One party in the state were certain to look coldly on the work of a minion of the court at such a juncture, the other had something else to think of. The death of Charles made, indeed, little difference in the court favour which Ronsard enjoyed, but, combined with his increasing infirmities, it seems to have determined him to quit court life. During his last days he lived chiefly at a house which he possessed in Vendôme, the capital of his native province, at his abbey at Croix-Val in the same neighbourhood, or else at Paris, where he was usually the guest of Jean Galland, well known as a scholar, at the Collège de Boncourt. It seems also that he had a town house of his own in the Faubourg Saint-Marcel. At any rate his preferences made him in perfectly easy circumstances, and he seems neither to have derived nor wished for any profit

from his books. A half-jocular suggestion that his publisher should give him money to buy "du bois pour se chauffer" in return for his last revision of his *Œuvres complètes* is the only trace of any desire of the kind. On the other hand, he received not merely gifts and endowments from his own sovereign but presents from many others, including Elizabeth of England. Mary, queen of Scots, who had known him earlier, addressed him from her prison; and Tasso consulted him on the *Gerusalemme*. His last years were, however, saddened not merely by the death of many of his most intimate friends, but by constant and increasing ill-health. This did not interfere with his literary work in point of quality, for he was rarely idle, and some of his latest work is among his best. But he indulged (what few poets have wisely indulged) the temptation of constantly altering his work, and many of his later alterations are by no means for the better. Towards the end of 1585 his condition of health grew worse and worse, and he seems to have moved restlessly from one of his houses to another for some months. When the end came, which, though in great pain, he met in a resolute and religious manner, he was at his priory of Saint-Cosme at Tours, and he was buried in the church of that name on Friday, December 27.

The character and fortunes of Ronsard's works are among the most remarkable in literary history, and supply in themselves a kind of illustration of the progress of French literature during the last three centuries. It was long his fortune to be almost always extravagantly admired or violently attacked. At first, as has been said, the enmity, not altogether unprovoked, of the friends and followers of Marot fell to his lot, then the self fiercer antagonism of the Huguenot faction, who happening to possess a poet of great merit in Du Bartas, were able to attack Ronsard in his tenderest point. But fate had by no means done its worst with him in his lifetime. After his death the classical reaction set in under the auspices of Malherbe, who seems to have been animated with a sort of personal hatred of Ronsard, though it is not clear that they ever met. After Malherbe the rising glory of Corneille and his contemporaries obscured the tentative and unequal work of the Pléiade, which was, moreover, directly attacked by Boileau himself, the dictator of French criticism in the last half of the 17th century. But this, except by a few members of the academy and Fénelon, forgotten when he was not sneered at. In this condition he remained during the whole 18th century and the first quarter of the 19th. The Romantic revival, seeing in him a victim of its special *bête noire* Boileau, and attracted by his splendid diction, rich metrical faculty, and combination of classical and medieval peculiarities, adopted his name as a kind of battle-cry, and for the moment exaggerated his merits somewhat. The critical work, however, first of Sainte-Beuve in his *Tableau de la littérature française au 16ème siècle*, and since of others, has established Ronsard pretty securely in his right place, a place which may be defined in a few sentences.

For the general position of the Pléiade, see FRENCH LITERATURE. Ronsard, its acknowledged chief and its most voluminous poet, was probably also its best, though a few isolated pieces of Belleau excel him in airy lightness of touch. Several sonnets of Du Bellay exhibit what may be called the intense and voluptuous melancholy of the Renaissance more perfectly than anything of his, and the finest passages of the *Tragiques* and the *Divine Sepmaine* surpass his work in command of the alexandrine and in power of turning it to the purposes of satirical invective and descriptive narration. But that work is, as has been said, very extensive (like those at a rough guess not much short of a hundred thousand lines of his), and it is extraordinarily varied in form. He did not introduce the sonnet into France, but he practised it very soon after its introduction with admirable skill—the famous "Quand vous serez bien vieille" being one of the acknowledged gems of French literature. His odes, which are very numerous, are also very interesting and in their best shape very perfect compositions. He began by imitating the strophic arrangement of the ancients, but very soon had the wisdom to desert this for a kind of adjustment of the Horatian ode to rhyme, instead of exact quantitative metre. In this latter kind he devised some exquisitely melodious rhythms of which, till our own day, the secret died with the 17th century. His more sustained work sometimes displays a bad selection of measure; and his occasional poetry—epistles, eclogues, elegies, &c.—is injured by its vast volume. But the preface to the *Françoïade* is a very fine piece of verse, far superior (it is in alexandrines) to the poem itself. Generally speaking, Ronsard is best in his amatory verse (the long series of sonnets and odes to Cassandra, Marie, Genvève, Hélène—Hélène de Surgères, a later and mainly "literary," love—&c.), and in his descriptions of the country (the famous "Mignonnes allons voir si la rose" the "Fontaine Bellerie," the "Forêt de Gastine," and so forth), which have an extraordinary grace and freshness. No one used with more art than he the graceful diminutives which

his school set in fashion. He knew well too how to manage the gorgeous adjectives ("marbrine," "cinabrine," "ivoirine" and the like) which were another fancy of the *Pélasde*, and in his hands they rarely became stiff or cumbrous. In short, Ronsard shows eminently the two great attractions of French 16th-century poetry as compared with that of the two following ages—magnificence of language and imagery and graceful variety of metre.

BIBLIOGRAPHY.—The chief separately published works of Ronsard are noted above. He produced, however, during his life a vast number of separate publications, some of them mere pamphlets or broadsheets, which from time to time he collected, often striking out others at the same time, in the successive editions of his works. Of these he himself published seven—the first in 1560, the last in 1584. Between his death and the year 1630 ten more complete editions were published, the most famous of which is the folio of 1609. A copy of this presented by Sainte-Beuve to Victor Hugo, and later in the possession of M. Maxime du Camp, has a place of its own in French literary history. The work of C. Binet in 1586, *Discours de la vie de Pierre de Ronsard*, is very important for early information, and the author seems to have revised some of Ronsard's work under the poet's own direction. From 1630 Ronsard was not again reprinted for more than two centuries. Just before the close of the second, however, Sainte-Beuve printed a selection of his poems to accompany the above-mentioned *Tableau* (1828). There are also selections by M. Noël (in the *Collection Didot*) and Becc de Fouquieres. In 1857 M. Prosper Blanchemain, who had previously published a volume of *Œuvres inédites de Ronsard*, undertook a complete edition for the *Bibliothèque Elzévirienne*. The eighth and last volume of this appeared ten years later. It is practically complete; a few pieces of a somewhat free character which are ascribed with some certainty to the poet are, however, excluded. A later and better edition still is that of Marty-Laveaux (1887-1893), and another that of B. Piteu (1891). As for criticism, Sainte-Beuve followed up his early work by articles in the *Causeries du lundi*, and the chief later critics have dealt with him in their collected works. Of books may be mentioned those of E. Gandar (Metz, 1854), which considers him chiefly in his relation to the ancients, *Ronsard, imitateur d'Homère et de Pindare*; the marquis de Rochambeau *La Famille de Ronsard* (1868); C. Schuchas *Les réformes littéraires* (1874); G. Bizos, *Ronsard* (1891); the Abbé Faurer, *Les Premières poésies de Ronsard* (1892); L. Mellerio, *Lexique de Ronsard* (1895); P. Perdrizet, *Ronsard et la réforme* (1902), with a still more recent series of articles in different publications by M. Paul Lemonnier. In English Mr A. Tilley's *Literature of the French Renaissance* (1904) may be consulted, and on Ronsard's critical standpoint Saintsbury's *History of Criticism*, vol. ii. (G. SA.)

RONSDORF, a town of Germany, in the Prussian Rhine province, situated on the Morsbach, a small affluent of the Rhine, 18 m. E. of Düsseldorf and 5 m. S. of Elberfeld-Barmen by rail. Pop. (1905) 14,005. It is the seat of iron, steel and copper industries, besides carrying on extensive manufactures of ribbons, trimmings and silk goods generally. It has also breweries, distilleries and electrical works.

Founded in 1737 by the followers of Elias Eller, a religious enthusiast, Ronsdorf received civic rights in 1745. The Ronsdorf sect, the members of which called themselves Zionites, is now extinct.

RÖNTGEN, DAVID, sometimes called DAVID DE LONÉVILLE (1743-1807), German cabinet-maker, eldest son of Abraham Röntgen, was born at Herrenhag. In 1753 his father migrated to the Moravian settlement at Neuwied, near Coblenz, where he established a furniture factory. He learned his trade in his father's workshop, and succeeded to the paternal business in 1772, when he entered into some kind of partnership with the clock-maker Kintzing. At that time the name of the firm appears already to have been well known, at all events in France; but it is a curious circumstance that although he is always reckoned as one of the little band of foreign cabinet-makers and workers in marquetry who, like Oeben and Riesener, achieved distinction in France during the superb *floraison* of the Louis Seize style, he never ceased to live at Neuwied, where apparently the whole of his furniture was made, and merely had a shop, or show-room, in Paris. We have, as it happens, a record of his first appearance there. The engraver Wille enters in his journal of August 30, 1774, that "M. Röntgen, célèbre ébéniste, établi à Neuwied, près de Coblenz, m'est venu voir, en m'apportant une lettre de recommandation de M. Zick, peintre à Coblentz. . . . Comme M. Röntgen connaissait personnel à Paris, je lui fus utile en lui enseignant quelques sculpteurs et dessinateurs dont il avait besoin."

Röntgen was first and foremost an astute man of business and it is not improbable that the moving cause of this opening up of relations with Paris was the accession to the throne of Marie Antoinette, whose Teutonic sympathies were only too well known. Before very long she appointed him her *ébéniste-mécanicien*. He appears, indeed, to have acquired considerable favour with the queen, for on several occasions she took advantage of his journeys through Europe to charge him with the delivery of presents and of dolls dressed in the Paris fashions of the moment—they were intended to serve as patterns for the dressmakers—to her mother and her sisters. He appears at once to have opened a shop in Paris, but despite, and perhaps because of, the favour in which he was held at court, all was not plain sailing. The powerful trade corporation of the *maîtres-ébénistes* disputed his right to sell in Paris furniture of foreign manufacture, and in 1780 he found that the most satisfactory way out of the difficulty was to get himself admitted a member of the corporation to which all his great rivals belonged. By this time he had attracted a good deal of attention by the introduction of a new style of marquetry, in which light and shade, instead of being represented as hitherto by burning, smoking or engraving the materials, were indicated by small pieces of wood so arranged as to create the impression of *pietra dura*. We have seen that Röntgen had been appointed *ébéniste-mécanicien* to Marie Antoinette, and the appointment is explained by his fondness for and proficiency in constructing furniture in which mechanical devices played a great part. The English cabinet-makers of the later eighteenth century often made what was called, with obvious allusion to his character, "harlequin furniture," especially little dressing-tables and washstands which converted into something else or held their essentials in concealment until a spring was touched. David was a past master in this kind of work, and unquestionably much of the otherwise inexplicable reputation he enjoyed among contemporaries who were head and shoulders above him is explained by his mechanical genius. The extent of his fame in this direction is sufficiently indicated by the fact that Goethe mentions him in *Wilhelm Meister*. He compares the box inhabited by the fairy during her travels with her mortal lover to one of Röntgen's desks, in which "at a pull a multitude of springs and latches are set in motion." For a desk of this kind Louis XVI. paid him 80,000 livres. Outwardly it was in the form of a commode, its marquetry panels symbolizing the liberal arts. A personification of sculpture was in the act of engraving the name of Marie Antoinette upon a column to which Minerva was hanging her portrait. Above a riot of architectural orders was a musical clock (the work of the partner Kintzing), surmounted by a cupola representing Parnassus. The interior of this monumental effort, 11 ft. high, was a marvel of mechanical precision; it disappeared during the First Empire. Röntgen did not confine his activities to Paris, or even to France. It has been said that he travelled about Europe accompanied by furniture vans, and undoubtedly his aptitude as a commercial traveller was remarkable. He had shops in Berlin and St Petersburg, and himself apparently twice went to Russia. On one of these visits he sold to the Empress Catherine furniture to the value of 20,000 roubles, to which she added a personal present of 5000 roubles and a gold snuff-box—in recognition, it would seem, of his readiness and ingenuity in surmounting a secretaire with a clock indicating the date of the Russian naval victory over the Turks at Cheshme, news of which had arrived on the previous evening. This suite of furniture is believed still to be in the Palace of the Hermitage, the hiding-place of so much remarkable and forgotten art. To the protection of the queen of France and the empress of Russia David added that of the king of Prussia, Frederick William II., who in 1792 made him a *Commerzienrath* and commercial agent for the Lower Rhine district. The French Revolution and the Napoleonic Wars which so speedily followed, eclipsed Röntgen's star as they eclipsed those of so many other great cabinet-makers of the period. In 1793 the Revolutionary government, regarding him as an *émigré*, seized the contents

of his show-rooms and his personal belongings, and after that date he appears neither to have done business in Paris nor to have visited it. Five years later the invasion of Neuwid led to the closing of his workshops; prosperity never returned, and he died half ruined at Wiesbaden on the 12th of February 1807.

Röntgen was not a great cabinet-maker. His forms were often clumsy, ungraceful and commonplace; his furniture lacked the artistry of the French and the English cabinet-makers of the great period which came to an end about 1790. His bronzes were poor in design and coarse in execution—his work, in short, is tainted by commercialism. As a *marqueteur*, however, he holds a position of high distinction. His marquetry is bolder and more vigorous than that of Riesener, who in other respects soared far above him. As an adroit deviser of mechanism he fully earned a reputation which former generations rated more highly than the modern critic, with his facilities for comparison, is prepared to accept. On the mechanical side he produced, with the help of Kintzing, many long-cased and other clocks with ingenious indicating and registering apparatus. Röntgen delighted in architectural forms, and his marquetry more often than not represents those scenes from classical mythology which were the dear delight of the 18th century. He is well represented at South Kensington.

RÖNTGEN, WILHELM KONRAD (1845-), German physicist, was born at Lennep on the 27th of March 1845. He received his early education in Holland, and then went to study at Zürich, where he took his doctor's degree in 1869. He then became assistant to Kundt at Würzburg and afterwards at Strassburg, becoming *privat-docent* at the latter university in 1874. Next year he was appointed professor of mathematics and physics at the Agricultural Academy of Hohenheim, and in 1876 he returned to Strassburg as extraordinary professor. In 1879 he was chosen ordinary professor of physics and director of the Physical Institute at Giessen, whence in 1885 he removed in the same capacity to Würzburg. It was at the latter place that he made the discovery for which his name is chiefly known, the Röntgen rays. In 1895, while experimenting with a highly exhausted vacuum tube on the conduction of electricity through gases, he noticed that a paper screen covered with barium platino-cyanide, which happened to be lying near, became fluorescent under the action of some radiation emitted from the tube, which at the time was enclosed in a box of black cardboard. Further investigation showed that this radiation had the power of passing through various substances which are opaque to ordinary light, and also of affecting a photographic plate. Its behaviour being curious in several respects, particularly in regard to reflection and refraction, doubt arose in his mind whether it was to be looked upon as light or not, and he was led to put forward the hypothesis that it was due to longitudinal vibrations in the ether, not to transverse ones like ordinary light; but in view of the uncertainty existing as to its nature, he called it X-rays. For this discovery he received the Rumford medal of the Royal Society in 1896, jointly with Philip Lenard, who had already shown, as also had Hertz, that a portion of the cathode rays could pass through a thin film of a metal such as aluminium. Röntgen also conducted researches in various other branches of physics, including elasticity, capillarity, the conduction of heat in crystals, the absorption of heat-rays by different gases, piezo-electricity, the electromagnetic rotation of polarized light, &c.

RÖNTGEN RAYS, W. K. Röntgen discovered in 1895 (*Wied. Ann.* 64, p. 1) that when the electric discharge passes through a tube exhausted so that the glass of the tube is brightly phosphorescent, phosphorescent substances such as potassium platino-cyanide became luminous when brought near to the tube. He found that if a thick piece of metal, a coin for example, were placed between the tube and a plate covered with the phosphorescent substance a sharp shadow of the metal was cast upon the plate; pieces of wood or thin plates of aluminium cast, however, only partial shadows, thus showing that the agent which produced the phosphorescence could traverse with considerable freedom bodies opaque to ordinary light. He found that as a general rule the greater the density of the substance the greater its opacity to this agent. Thus while this effect could pass through the flesh

it was stopped by the bones, so that if the hand were held between the discharge tube and a phosphorescent screen the outline of the bones was distinctly visible as a shadow cast upon the screen, or if a purse containing coins were placed between the tube and the screen the purse itself cast but little shadow while the coins cast a very dark one. Röntgen showed that the cause of the phosphorescence, now called Röntgen rays, is propagated in straight lines starting from places where the cathode rays strike against a solid obstacle, and the direction of propagation is not bent when the rays pass from one medium to another, *i.e.* there is no refraction of the rays. These rays, unlike cathode rays or *Canalstrahlen*, are not deflected by magnetic force; Röntgen could not detect any deflection with the strongest magnets at his disposal, and later experiments made with stronger magnetic fields have failed to reveal any effect of the magnet on the rays. The rays affect a photographic plate as well as a phosphorescent screen, and shadow photographs can be readily taken. The time of exposure required depends upon the intensity of the rays, and this depends upon the state of the tube, and the electric current going through it, as well as upon the substances traversed by the rays on their journey to the photographic plate. In some cases an exposure of a few seconds is sufficient, in others hours may be required. The rays coming from different discharge tubes have very different powers of penetration. If the pressure in the tube is fairly high, so that the potential difference between its electrodes is small, and the velocity of the cathode rays in consequence small, the Röntgen rays coming from the tube will be very easily absorbed; such rays are called "soft rays." If the exhaustion of the tube is carried further, so that there is a considerable increase in the potential differences between the cathode and the anode in the tube and therefore in the velocity of the cathode rays, the Röntgen rays have much greater penetrating power and are called "hard rays." With a highly exhausted tube and a powerful induction coil it is possible to get appreciable effects from rays which have passed through sheets of brass or iron several millimetres thick. The penetrating power of the rays thus varies with the pressure in the tube; as this pressure gradually diminishes when the discharge is kept running through the tube, the type of Röntgen ray coming from the tube is continually changing. The lowering of pressure due to the current through the tube finally leads to such a high degree of exhaustion that the discharge has great difficulty in passing, and the emission of the rays becomes very irregular. Heating the walls of the tube causes some gas to come off the sides, and by thus increasing the pressure creates a temporary improvement. A thin-walled platinum tube is sometimes fused on to the discharge tube to remedy this defect; red-hot platinum allows hydrogen to pass through it, so that if the platinum tube is heated, hydrogen from the flame will pass into the discharge tube and increase the pressure. In this way hydrogen may be introduced into the tube when the pressure gets too low. When liquid air is available the pressure in the tube may be kept constant by fusing on to the discharge tube a tube containing charcoal; this dips into a vessel containing liquid air, and the charcoal is saturated with air at the pressure which it is desired to maintain in the tube. Not only do bulbs emit different types of rays at different times, but the same bulb emits at the same time rays of different kinds. The property by which it is most convenient to identify a ray is the absorption it suffers when it passes through a given thickness of aluminium or tin-foil. Experiments made by McClelland and Sir J. J. Thomson on the absorption of the rays produced by sheets of tin-foil showed that the absorption by the first sheets of tin-foil traversed by the rays was much greater than that by the same number of sheets when the rays had already passed through several sheets of the foil. The effect is just what would occur if some of the rays were much more readily absorbed by the tin-foil than others, for the first few layers would stop all the easily absorbable rays while the ones left would be those that were but little absorbed by tin-foil.

The fact that the rays when they pass through a gas ionize it and make it a conductor of electricity furnishes the best means of measuring their intensity, as the measurement of the amount of conductivity they produce in a gas is both more accurate and more convenient than measurements of photographic or phosphorescent effects. Röntgen rays when they pass through matter produce—as Perrin (*Comptes rendus*, 124, p. 455), Sagnac (*Jour. de Phys.*, 1899, (3), 8, and J. Townsend (*Proc. Camb. Phil. Soc.*, 1899, 10, p. 17), have shown—secondary Röntgen rays as well as cathodic rays. A very complete investigation of this subject has been made by Barkla and Sadler (*Phil. Mag.*, *Phil. Mag.*, June 1906, pp. 812–828; Barkla and Sadler, *Phil. Mag.*, October 1908, pp. 550–584; Sadler, *Phil. Mag.*, July 1909, p. 107; Sadler, *Phil. Mag.*, March 1910, p. 337). They have shown that the secondary Röntgen rays are of two kinds: one kind is of the same type as the primary incident ray and may be regarded as scattered primary rays, the other kind depends only on the matter struck by the rays, its quality independent of that of the incident ray. When the atomic weight of the element exposed to the primary rays was less than that of calcium, Barkla and Sadler could only detect the first type of ray, i.e. the secondary radiation consisted entirely of scattered primary radiation; elements with atomic weights greater than that of calcium gave out, in addition to the scattered primary radiation, Röntgen rays characteristic of the element and independent of the quality of the primary rays. The higher the atomic weight of the metal the more penetrating are the characteristic rays it gives out. This is shown in the table, which gives for the different elements the reciprocal of the distance, measured in centimetres, through which the rays from the element can pass through aluminium before their energy sinks to 1/2.7 of the value it had when entering the aluminium; this quantity is denoted in the table by λ .

Element.	Atomic weight.	λ .
Chromium	52	367
Iron	55.9	239
Cobalt	59.0	193.2
Nickel	58.77 (61.3)	159.5
Copper	63.6	127.9
Zinc	65.4	106.3
Selenium	75.0	60.7
Selenium	79.2	51.0
Strontium	87.6	35.2
Molybdenum	96.0	12.7
Rhodium	103.0	8.44
Silver	107.9	6.75
Tin	119.0	4.33

The radiation from chromium cannot pass through more than a few centimetres of air without being absorbed, while that from tin is as penetrating as that given out by a fairly efficient Röntgen tube. Barkla and Sadler found that the radiation characteristic of the metal is not excited unless the primary radiation is more penetrating than the characteristic radiation. Thus the characteristic radiation from silver can excite the characteristic radiation from iron, but the characteristic radiation from iron cannot excite that from silver. We may compare this result with Stokes's rule for phosphorescence, that the phosphorescent light is of longer wave-length than the light which excites it.

The discovery that each element gives out a characteristic radiation (or, as still more recent work indicates, a line spectrum of characteristic radiation) is one of the utmost importance. It gives us, for example, the means of getting homogeneous Röntgen radiation of a perfectly definite type; it is also of fundamental importance in connexion with any theory of the Röntgen rays. We have seen that there is no evidence of refraction of the Röntgen rays; it would be interesting to try if this were the case when the rays passing through the refracting substance are those characteristic of the substance.

Secondary Cathodic Rays.—The incidence of Röntgen rays on matter causes the matter to emit cathodic rays. The velocity of these rays is independent of the intensity of the primary Röntgen rays, but depends upon the "hardness" of the rays; it seems also to be independent of the nature of the matter exposed to the primary rays. The velocity of the cathodic rays increases as the hardness of the primary Röntgen rays increases. Innes (*Proc. Roy. Soc.*, 79, p. 442) measured the velocity of the cathodic radiation excited by the rays from Röntgen tubes, and found velocities varying from 6.2×10^8 cm./sec. to 8.3×10^8 cm./sec. according to the hardness of the rays given out by the tube. The cathodic rays given out under the action of the homogeneous secondary Röntgen radiation characteristic of the different elements have been studied by Sadler (*Phil. Mag.*, March 1910) and Beatty (*Phil. Mag.*, August 1910). The following table giving the properties of the cathode rays excited by the radiation from various elements is taken from Beatty's paper; t_1 is the thickness of air at atmospheric pressure and

temperature required to absorb one-half of the energy of the cathode particles, t_2 is the corresponding quantity for hydrogen.

Radiator.	t_1	t_2
Iron	0.0804	0.410
Copper	0.135	0.733
Zinc	0.167	0.909
Arsenic	0.255	
Tin	0.1672	1.37

The properties of the cathode rays excited by the radiation from tin correspond very closely with those produced in a discharge tube when the potential difference between the anode and cathode is about 30,000 volts. When Röntgen rays pass through a thin plate the cathodic radiation on the side the rays emerge is more intense than on the side they enter. Kaye (*Phil. Trans.*, 209, p. 123) has shown that when cathode rays fall upon a metal two kinds of Röntgen rays are excited, one being the characteristic radiation of the metal and the other a kind independent of the nature of the metal and dependent only upon the velocity of the cathode rays. The faster the cathode rays the harder the Röntgen rays they produce. It would be interesting to see if there is any connexion between the velocity of the cathode rays required to excite Röntgen rays as hard as those given out say by tin and the velocity of the cathode rays which the radiation from tin produces when it falls upon any metal. Sadler has shown that metals can give off cathodic radiation even when the incident Röntgen rays are too soft to excite the characteristic Röntgen radiation of the metal, but that there is a large increase in the cathodic radiation as soon as the characteristic Röntgen radiation is excited. It is possible that the shock produced by the emission of these cathode particles starts the vibrations which give rise to the characteristic rays; the cathode particles emitted when the incident rays are too soft to excite the characteristic radiation coming from a different source from those tapped by the hard rays.

Absorption of Röntgen Rays.—The wide variations in the penetrating power of Röntgen rays from different sources is shown by the above table of the penetrating power of the characteristic rays of the different elements. Many experiments have been made on the penetration of the same rays for different substances. It is a rule to which there is no well-established exception that the greater the density of the substance the greater is its power of absorbing the rays. The connexion, however, between the absorption and the density of the substance is not in general a simple one, though there is evidence that for exceedingly hard rays the absorption is proportional to the density.

The power of any material to absorb rays is usually measured by a coefficient λ , the definition of which is that a plate 1/λ centimetres thick reduces the energy of the rays when they pass through it normally to their original intensity, where λ is the base of the Napierian logarithms and equal to 2.7128. It has been shown that however the physical state of a substance may alter,—if, for example, it changes from the liquid to the gaseous,—λ/D, where D is the density of the substance, remains constant. It has also been shown that if we have a mass M made up of masses M₁, M₂, M₃, . . . of substances having coefficients of absorption λ₁, λ₂, λ₃, . . . and densities D₁, D₂, D₃, . . . then if λ/D for the mixture is given by the equation

$$M\lambda/D = M_1\lambda_1/D_1 + M_2\lambda_2/D_2 + M_3\lambda_3/D_3 + \dots$$

this equation is true whether the substances are chemically combined or chemically mixed. From this equation, when we know λ/D for a binary compound and for one of its constituents, we can find the value of λ/D for the other constituent. By the use of this principle we can find the value of λ/D for the elements which cannot be obtained in a free state. Benoist (*Jour. de Phys.* (7), 28, p. 289) has shown that if the values of λ/D are plotted against the atomic weight we get a smooth curve; if we draw this curve it is evident that we have the means of determining the atomic weight of an element by measuring its transparency to Röntgen rays when in contact with a substance whose transparency is known. Benoist has applied this method to determine the atomic weight of indium.

The value of λ/D for any one substance depends upon the type of ray used, and the ratio of the values of λ/D for two substances may vary very greatly with the type of ray; this is especially the case when one of the substances is hydrogen. Thus Crowther (*Proc. Roy. Soc.*, March 1909) has shown that the ratio of λ for air to λ for hydrogen varied from 100 for rays given out by a Röntgen tube at a comparatively high pressure when the rays were very soft to 0.56 when the pressure in the bulb was very low and the rays very hard. Beatty (*Phil. Mag.*, August 1910) found that this ratio was as large as 175 for the characteristic rays given out by iron, copper, zinc and arsenic, but fell to 25.0 for the rays from tin.

Polarisation of Röntgen Rays.—A great deal of attention has been paid to a phenomenon called the polarisation of the

Röntgen rays. The nature of this effect may be illustrated by fig. 1. Suppose that AB is a stream of cathode rays striking against a solid obstacle B and giving rise to Röntgen rays, let these rays impinge on a small body P, P under these conditions will emit secondary rays in all directions. Barkla (*Phil. Trans.*, 1905, A, 204, p. 467; *Proc. Roy. Soc.* 77, p. 247) found that the intensity of the secondary rays, tested by the ionization they produced in air, was less intense in the

FIG. 1.

plane ABP than in a plane through PB at right angles to this plane, the distances from P being the same in the two cases; the difference in the intensities amounting to about 15%. Haga (*Ann. d. Phys.* 28, p. 439), who tried a similar experiment but used a photographic method to measure the intensity of the secondary rays, could not detect any difference of intensity in the two planes, but experiments by Bassler (*Ann. der Phys.* 28, p. 808) and Vegard (*Proc. Roy. Soc.* 83, p. 379) have confirmed Barkla's original observations.

The "polarization" is much more marked if instead of exciting the secondary radiation in P by the Röntgen rays from a discharge tube we do so by means of secondary rays. If, for example, in the case illustrated by fig. 1 we allow a beam of Röntgen rays to fall upon B instead of the cathode rays, the difference between the intensities in the plane ABP and in the plane at right angles to it are very much increased. It is only the scattered secondary radiation which shows this "polarization"; the characteristic secondary radiation emitted by the body at P is quite unpolarized. The existence of this effect has a very important bearing on the nature of Röntgen rays. Whether Röntgen rays are or are not a form of light, i.e. are some form of electromagnetic disturbance propagated through the aether, is a question on which opinion is not unanimous. They resemble light in their rectilinear propagation; they produce an effect, through a small one, on the retina, giving rise to a very faint illumination of the whole field of view. They resemble light in not being deflected by either electric or magnetic forces, while the characteristic secondary radiation may be compared with the phosphorescence produced by ultra-violet light, and the cathodic secondary rays with the photo-electric effect. The absence of refraction is not an argument against the rays being a kind of light, for all theories of refraction make this property depend upon the relation between the natural time of vibration T of the refracting substance and the period t of the light vibrations, the refraction vanishing when t/T is very small.

There would be no refraction for light of a very small period, and this would also be true if instead of regular periodic undulations we had a pulse of electromagnetic disturbance, provided the time taken by the light to travel over the thickness of the pulse is small compared with the periods of vibration of the molecules of the refracting substance. Experiments on the diffraction of Röntgen rays are very difficult, for, in addition to the difficulties caused by the smallness of the wavelength or the thinness of the pulse, the secondary radiation produced when the rays strike against a photographic plate or pass through air might give rise to what might easily be mistaken for diffraction effects. Röntgen has never succeeded in observing effects which prove the existence of diffraction. Forman (*Wied. Ann.* 59, p. 50) observed in the photograph of narrow slit light diffraction bands which looked like diffraction bands; but observation with slits of different sizes showed that they were not of this nature, and Haga and Wind (*Wied. Ann.* 68, p. 884) have explained them as contrast effects. These observers, however, noticed with a very narrow wedge-shaped slit a broadening of the image of the narrow part which they are satisfied could not be explained by the causes. Walter and Pohl (*Ann. der Phys.* 29, p. 331) could not observe any diffraction effects, though their arrangement would have enabled them to do so if the wave-length had not been smaller than 1.5×10^{-9} cm. Sir George Stokes (*Proc. Manchester Lit. and Phil. Soc.*, 1898) put forward the view that the disturbances which constitute the rays are not regular periodic undulations but very thin pulses. Thomson (*Phil. Mag.* 45, p. 172) has shown that when charged particles are suddenly stopped, pulses of very intense electric and magnetic disturbances are started. As the cathode rays consist of negatively electrified particles, the impact of these on a solid would give rise to these intense pulses. The electromagnetic theory therefore shows that effects resembling light, inasmuch as they are electromagnetic disturbances propagated through the aether, must be produced when the cathode rays strike against an obstacle. Since under these circumstances Röntgen rays are produced, it

seems natural, unless direct evidence to the contrary is obtained, to connect the Röntgen rays with these pulses. This view explains very simply the "polarization" of the rays; for, suppose the cathode particle moving from A to B were stopped at its first impact with the plate B (fig. 1), the electric force transmitted along BP would be in the plane ABP at right angles to BP. When this electric force reached the body at P it would accelerate any electrified particles in that body, the acceleration being parallel to AB. Each of these accelerated particles would start electric waves. The theory of such waves shows that their intensity vanishes along a line through the particle parallel to the direction of acceleration, while it is a maximum at right angles to this line; thus the intensity of the rays along a horizontal line through P would vanish, while it would be a maximum in the plane at right angles to this line. In this case there would be complete polarization. In reality the cathode particle is not stopped at its first encounter, but makes many collisions, changing its direction between each; and these collisions will send out electric disturbances which when they fall on P are able to excite waves which send some energy along PC. The polarization will therefore be only partial and will be of the kind found by Barkla.

The velocity with which the waves travel has not yet been definitely settled. Marx (*Ann. der Phys.* 20, p. 677) by an ingenious but elaborate method came to the conclusion that they travelled with the velocity of light; his interpretation of his experiments has, however, been criticized by Franck and Pohl (*Verh. d. D. Physik Ges.* 10, p. 489).

Another view of the nature of Röntgen rays has been advocated by Bragg (*Phil. Mag.* 14, p. 429); he regards them as neutral electric doublets consisting of a negative and a positive charge of electricity which are usually held together by the attraction between them, but which may be knocked asunder when the rays strike against matter and turned into cathodic rays. On this view when the rays pass through a gas only a few of the molecules of the gas are struck by the rays and so we can easily understand why so few of the molecules are ionized. On the ordinary view of an electric wave all the molecules would be affected by the wave when it passed through a gas, and to explain the small fraction ionized we must either suppose that systems sensitive to the Röntgen rays are at any time present only in a very small fraction of the molecule or else that the front of an electric or light wave is not continuous but that the energy is concentrated in patches which only occupy a fraction of the wave front.

Apparatus for producing Röntgen Rays.—The tube now used most frequently for producing Röntgen rays is of the kind introduced by Porter and known as a focus tube (fig. 2). The cathode is a portion of a hollow sphere, and the cathode rays come to a point on or near a metal plate A, called the anti-cathode, connected with the anode; this plate is the source of the rays. This ought to be made of a very unfusible metal such as platinum or, still better, tantalum, and kept cool by a water-cooling arrangement. The anti-cathode is generally set at an angle of 45° to the rays; it is probable that the action of the tube would be improved by putting the anti-cathode at right angles to the cathode rays. The walls of the tube get strongly electrified. This electrification affects the working of the tube, and the production of rays can often be improved by having an earth-connected piece of tin-foil on the outside of the bulb, and moving it about until the best position is attained. To produce the discharge an induction coil is generally employed with a mercury interrupter. Excellent results have been obtained by using an electrostatic induction machine to produce the current, the emission rays are more uniform than when an induction coil is used. The rays are emitted pretty uniformly in all directions until the plane of the anti-cathode is approached; in the neighbourhood of this plane there is a rapid falling off in the intensity of the rays. After long use the glass of the bulb often becomes distinctly purple. This is believed to be due to the presence of manganese compounds in the glass. (J. J. T.)



FIG. 2.

ROOD (O.E. *rod*, a stick, another form of "rod," O.E. *rodd*, possibly cognate with Lat. *rudis*, a staff), properly a rod or pole, and so used as the name of a surface measure of land. The rood varies locally but is generally taken as = 40 square rods, poles or perches; 4 roods = 1 acre. The term was, however, particularly applied, in O.E., to a gallow or cross, especially to the Holy Cross on which Christ was crucified, the sense in which the word survives. A crucifix, often accompanied by figures of St John and the Virgin Mary, was usually placed in churches above the screen, hence known as "rood screen"

(see SCREEN), which divides the chancel or the choir from the nave. The roof was carried either on a transverse beam, the "roof beam," or by a gallery, the "roof loft." Such a gallery was also used as a place from which to read portions of the service (see JUBÉ). It was reached by the "roof stair," a small winding stair or "vice." In English churches these stairs generally run up in a small turret in the wall at the west end of the chancel; often this also leads out on to the roof. On the continent of Europe they often lead out of the interior of the church and are enclosed with tracery, as at Rouen or Strassburg. "Roof stairs" remain in many English churches where the roof loft has been destroyed. A fine example of a roof loft is at Charlton-on-Otmoor, Oxfordshire. The screen might be separate from the roof beam or roof loft. The general construction of wooden screens is close panelling beneath, on which stands screen-work composed of slender turned balusters or regular wooden mullions, supporting tracery more or less rich with cornices, crests, &c., and often painted in brilliant colours and gilded. The central tower of a church over the intersection of the nave and chancel with the transepts is sometimes called the "roof tower"; an example is that at Notre Dame at Paris. In England roof lofts do not appear to have been introduced before the 14th century, and were not common till the 15th. The "roofs" themselves were not

The simplest form is the "flat roof" consisting of horizontal wood joists laid from wall to wall as in floor construction. The roof must not be quite flat, for a slight fall is necessary in its upper surface to allow water to drain away into gutters placed at convenient points. The joists are covered with a waterproof material such as asphalt, lead, zinc or copper, the three last materials being usually laid upon boarding, which stiffens the structure and forms a good surface to fix the weatherproof covering upon. Such roofs are not suitable for cold climates, for accumulations of snow might overburden the structure and would also cause the wet to penetrate through any small crevices and under flashings. With flat roofs the pressure exerted upon the supports is directly vertical.

"Lean-to," "shed," or "pent" roofs are practically developments of the flat roof, one end of the joists (which are now called "rafters") being tipped up to form a decided slope, which enables slates, tiles, corrugated iron and other materials to be employed which cannot be used upon a "flat" roof.

Simple roofs in general use with a double slope are the "coupled rafter roofs," the rafters meeting at the highest point upon a horizontal ridge-piece which stiffens the framework and gives a level ridge-line. In some old roofs the rafters are connected without any intervening ridge-plate, with the result that after

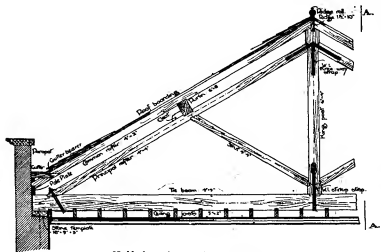

Half elevation; 25° or span.

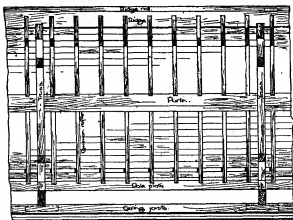

Sectional elevation on AA.

FIGS. 1 and 2.—King-post Roof Truss.

disturbed in Henry VIII.'s reign, but were generally removed under Edward VI. and Elizabeth.

The legality of roof screens or roof lofts in the Church of England depends on the law of the Church with regard to images, *i.e.* "whether they do or do not, or will or will not, encourage or lead to idolatrous or superstitious worship in the place where they are, or are to be put" (Lindley, L. 7. in *R. v. Bishop of London*, 1889, 24 Q.B.D. 213, 237; see also *St John Timberhill, Norwich*, case, 1889 Prob. 71, and article IMAGE).

ROOFS. A roof is a construction placed as a covering over the upper portion of a building to exclude the weather and preserve the contents dry and uninjured. Roofs are designed to throw off rain and snow, and their slope or "pitch," as it is generally termed, is governed to a great extent by the climate, as well as by the material used and manner of laying. The pitch may vary from an almost horizontal surface (as largely adopted in dry countries and also in temperate climates for roofs of metal or asphalt) to the steeply pitched roofs required for the ordinary flat tiles which to be weatherproof must be laid at an angle of from 45° to 80° with the horizon. Besides serving the useful purpose of protection against inclement weather the roof, both externally and internally, may be designed to form an architectural feature in keeping with the character of the building.

a time the ridge instead of remaining level takes on a wavy outline, due to the fact that some of the timbers have settled slightly owing to decay or other causes, whilst others have remained firm in their places. The lower ends of the rafters should pitch on a wood plate bedded on the top of the wall; this, as described under CARPENTRY, assists in spreading the weight over a large area of the wall, and provides good fixing for the timbers. The simple "couple roof" consists merely of two sets of rafters pitched from plates on the walls on either side of the building and sloping upwards to rest against a common ridge-piece. There are no ties between the feet of the rafters, which therefore exert a considerable thrust against the supporting walls. On account of this and of the lack of rigidity of the framing this form of roof should only be used to cover small spans of 10 to 12 ft. Generally the ends of the rafters are connected by ceiling joists which form a level ceiling and at the same time prevent any outward thrust on the supports. When used for spans between 12 ft. and 18 ft. a binder supported by an iron or wood "king" tie every 5 or 6 ft. should be run along across the centres of the ceiling joists and the latter spiked to it. Such roofs with the wood tie across the feet of the rafters are termed "couple close roofs." When the ties are fixed about half-way up the rafters it is called a "collar roof," and may be used for spans up to 16 ft. These are the type of roof commonly used in ordinary dwelling-houses where the

framing, usually of rough northern pine or spruce, is generally hidden from view by the ceilings. The spans usually are not great, and extra support is obtained at various points from partitions and cross walls. Where the span is large, that is, above 20 ft. without intermediate support, it is necessary to employ roofs with "principals" and "purlins," sometimes called "double rafter roofs." Principals are strong trusses of timber rigidly framed together and placed at intervals of about 10 ft. to support the weight of the roof covering. Purlins—stout timbers running longitudinally—are

In such large spans the straining beam often becomes of such a length as to require support and this is effected by continuing the principal rafters up to the ridge and introducing a short king-post to sustain the beam in the middle of its length.

Open timber roofs of various types but principally of "hammer-beam" construction were used in the middle ages where stone vaulting was not employed. Many of these old roofs still exist in good preservation and exhibit the great skill of the medieval carpenters who designed and erected them. Such forms are still used, chiefly for ecclesiastical buildings and the roofs over large halls. In the best periods of Gothic architecture the pitch

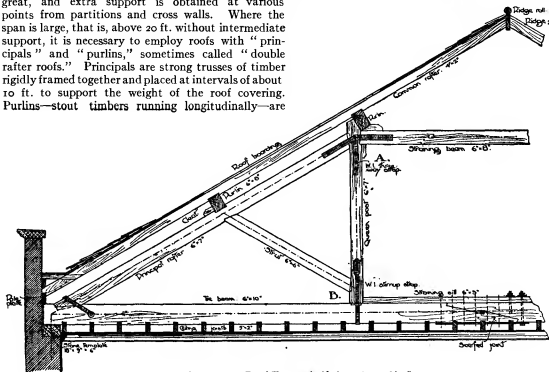

FIG. 3.—Queen-post Roof Truss; half elevation, 38' 0" span.

fixed on the principal rafters with intervals of about 8 ft., and on these the common rafters are fastened. Principals, or "roof trusses" as they are more often called, are framed together in various ways, and the members may be entirely of wood or reinforced by ties of iron rods or bars; the latter are called "composite trusses."

The "king-post truss" may be used for spans up to 30 ft. and is constructed as shown in figs. 1 and 2. It has a central post sustaining the "tie-beam" in the centre with struts projecting from its base to support the principal rafters at their centres at a point where the weight of the purlins renders strutting necessary. The members are connected by wrought-iron straps and bolts; the strap connects the king-post and tie-beam and is often fitted with a gib-and-cotter arrangement (really a pair of iron folding wedges) which allows the whole truss to be tightened up should any settlement or shrinkage occur. "Queen-post trusses" have, in place of the king-post dividing the tie-beam into two, two queen-posts supporting it at two points (fig. 3). The joints between the members are made in a similar manner to those of the king-post principal with wrought-iron straps. The purlins are two in number on each slope, one supported at the top of each "queen," the other half-way between that point and the wall-plate and resting upon the principal rafter at a point where strutted from the base of the queen-post. A stout straining beam connects the heads of the queens. In fig. 4, *a* and *b* are details at the foot of the queen-post, and *c* at the head. Trusses of this type are suitable for spans up to 45 ft. In roofs of a larger span than this and up to 60 ft. the tie-beam requires to be upheld at more than two points, and additional posts called "princesses" are introduced for this purpose. This also entails extra struts and purlins.

of these roofs was made very steep, sometimes as much as 60° with the horizon. In the hammer-beam type of roof the tie-beam at the foot of the rafters is omitted, a collar being thrown across connecting the principal rafters at a point about half-way in their length, the lower portion of the principal consisting of a number of struts and braces rigidly connected in such a manner as to throw as little thrust as possible upon the walls serving as abutments. There are two kinds of hammer beams, the arched and the bracketed; the chief examples are Westminster Hall and Middle Temple Hall (Plate I, figs. 24 and 25). The "hammer beam" projects from the top of the wall and is bracketed from a corbel projecting from the wall some distance below. This form of roof has a style and dignity of its own, and gives greater height in the upper part of the building as well as being more ornamental and lighter in effect than tie-beam trusses, which have a rather heavy effect.

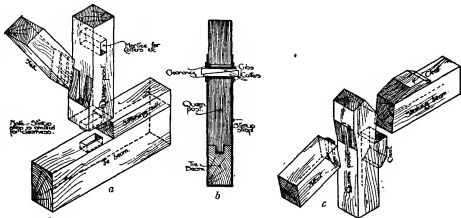

FIG. 4.—*a*. Detail of queen-post truss at *b*.
b. Vertical section through queen-post.
c. Detail of queen-post truss at head; purlin and wrought-iron straps are omitted for the sake of clearness.



Photo, G. W. Wilson & Co.

FIG. 24.—WESTMINSTER HALL.



FIG. 25.—HALL OF THE MIDDLE TEMPLE.



ROOF OF OLYMPIA, LONDON.

The Mansard roof (fig. 5) is a useful form of construction which obtains its name from François Mansard, a distinguished French architect who lived in the 17th century. This kind of roof has been largely used, especially in France and other European countries, as well as in America in the old colonial days. It adapts itself well to some styles of architecture, but should be very carefully applied, since it

Mansard roof.

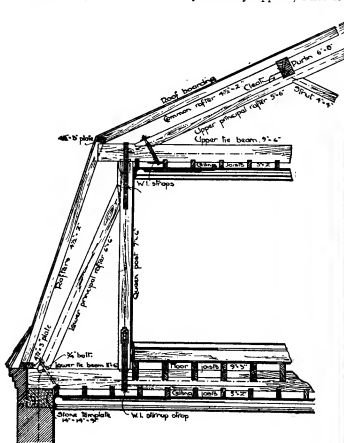

Fig. 5.—Mansard Roof Truss: detail of outline as A; other outlines at B, C, D and E.

is apt to appear ungainly in some situations. By the use of a Mansard roof extra rooms can be obtained at a small expense without adding an additional storey to the building proper. The outward thrust upon the supporting walls is not so great as with an ordinary pitched roof, the load coming practically vertically upon them. There is no recognized rule for the proportion or pitch of a roof of this description, which should be designed to suit the particular building it is intended to cover. Fig. 5, A, B, C, D and E show various forms. A similar type of curb roof is often used having a flat lead- or zinc-covered top in place of the pitched slate- or tile-covered top of the ordinary Mansard roof.

Composite roof trusses of wood and iron are frequently used for all classes of buildings, and have proved very satisfactory. They are built upon the same principles as wooden types of roof trusses. The struts—that is, those members subjected to compressional stress—are of wood, and iron bars or rods are used for the ties, which have to withstand tensile forces. When any shrinkage occurs to loosen the joints of the framing, as usually happens in large trusses, the tie-rods are tightened up by the bolts attached to them. Figs. 6, 7 and 8 are the sections and plan of a simple method of constructing the roof for an ordinary domestic building with plaster ceilings to the

top rooms. It is a simple construction of the couple close order with the addition of a collar and struts and king-rod to every fourth rafter. Trimming is necessary for openings and where portions of the structure, such as chimney stacks, cut into the roof. The trimming rafters are made an inch thicker than the others. The dragon tie is framed in connexion with the wall-plate at the hipped corners to take the thrust of the hip rafters.

Steel and iron trusses in many cases follow the wood models already described. The struts and principal rafters are usually of T section, the tensional members being rods or flat bars.

Iron roofs.

Flat plates and bolts or rivets are used to form the connexions between the members, and a means is provided in the tie-rod for tightening up the truss should any of the members "give" slightly under their load. Large trusses for very wide spans are specially designed for their work and may be of many different types of design. Big roofs on the tie-rod principle are now being discarded as being more liable to failure, through deterioration or defect, than those built on the girder principle in one form or another. Fig. 9 is a queen-rod roof principal for a span of 50 ft., and shows the sizes of the different members, a line diagram of the truss and large details of the joints. Fig. 10 in a similar manner shows the roof at Cardiff railway station, which has a span of 43 ft.

The steel roof covering the great hall at Olympia, London, is an example of a carefully designed and well-built roof which combines with strength an extremely light and elegant appearance. This is due to the fact that every member of the roof is adapted to meet the particular stresses found by calculation to affect it. By careful study of conditions the sections of steelwork used for the various members have been reduced

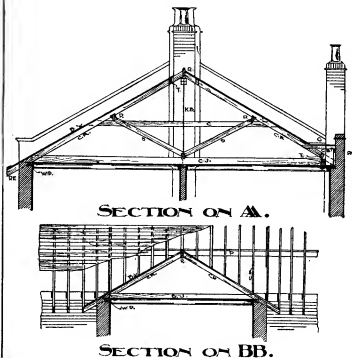

Figs. 6 and 7.—Roof for Domestic Building.

to the smallest size compatible with safety. In this way any unnecessary surplus of material is avoided, and so is the heavy, overwhelming effect noticeable in many roofs of large span. There is an entire absence of long wide plates and webs; the various members are composed wholly of flat bars and angle irons riveted together, and plates are introduced only where required to cover joints. Some notes on its size and construction

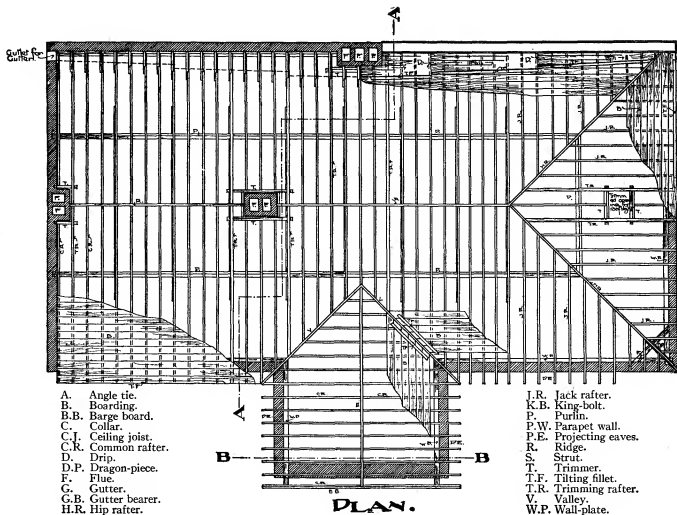

FIG. 8.

will be interesting. The dimensions of the great hall are 440 ft. long by 250 ft. wide, the height to the crown of the roof being about 100 ft. The main ribs of the roof have a clear span of 170 ft. and are placed 34 ft. apart. They are of box-girder form and measure 7 ft. deep and 2 ft. wide. The gallery around the hall is 40 ft. wide on three sides and 26 ft. wide on the remaining side. It is covered by a lean-to roof which abuts against the curved ribs on the north and south sides, and is attached to horizontal members of the screens on the east and west sides. The bricks walls of the building are not called upon to resist any portion of the thrust from the roof, as the side frames through which the gallery floor passes form a self-contained system of steelwork in which the thrust is ultimately conveyed to the ground. The screens which close the semicircular ends of the roof are of vertical ridge and furrow construction, as can be clearly seen in the illustrations, this form offering great resistance to wind pressure while at the same time requiring a minimum amount of material. Of the two illustrations, fig. 11 is a detailed cross-section showing fully the method of construction of the foot of the main rib and column, and the arrangement of the side frames above referred to is shown in fig. 12, which is a complete cross-section view, and will convey to the reader some idea of the vast size of the building and its general proportions.

The following five roofs are examples of large span: Crystal Palace (104 ft.); Olympia, London (170 ft.); St Enoch station, Glasgow (198 ft.); Central station, Manchester (210 ft.); St Pancras station, London (240 ft.).

Domes may be framed up with wood rafters cut to shape. For small spans this construction is satisfactory, but when the dome is of considerable size it is often framed in steel as being stronger and more rigid than wood, and therefore not exerting so great a thrust upon the supporting walls.

**Dome
roofs.**

The outer dome of St Paul's cathedral in London is of lead-covered wood, framed upon and supported by a conical structure of brickwork which is raised above the inner dome of brick. Concrete is a very suitable material for use in the construction of domes, and may be employed simply or with iron or steel reinforcement in the shape of wires, bars or perforated plates. One of the best modern examples of concrete vaulting and dome roofing without metal reinforcement occurs in the Roman Catholic cathedral at Westminster, a remarkable building designed by Mr J. F. Bentley. A few details of the roofs will be interesting. The circle developed by the pendentives of the nave domes is 60 ft. in diameter. The thickness of the domes at the springing is 3 ft. gradually reduced to 13 in. at the crown; the curve of equilibrium is therefore well within the material. The domes were turned on closely boarded centring in a series of superimposed rings of concrete averaging 4 ft. in width. The concrete is not reinforced in any way. The independent external covering of the domes is formed of 3 in. artificial stone slabs cast to the curve. They rest on radiating ribs 5 in. deep of similar material fixed on the concrete and rebated to receive the slabs; thus an air space of 2 in. is left between the inner shell and the outer covering, the object being to render the temperature of the interior more uniform. At the springing and at the

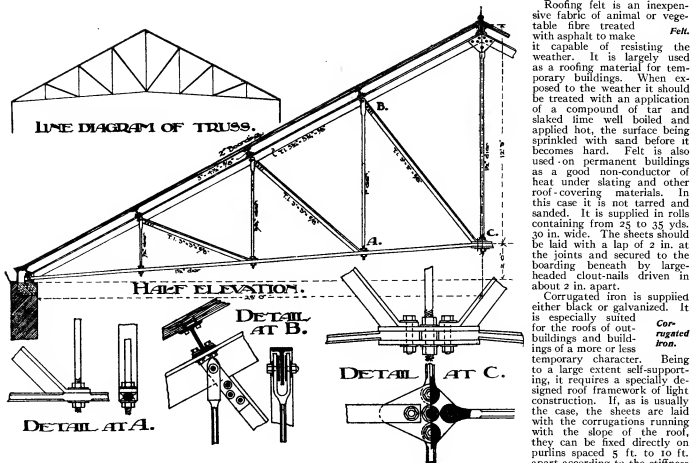

FIG. 9.—Queen-rod Roof Truss.

crown the spaces between the ribs are left open for ventilation. The sanctuary dome differs in several respects from those of the nave. Unlike the latter, which seem to rest on the flat roofing of the church, the dome of the sanctuary emerges gradually out of the sub-structure, the supporting walls on the north and south being kept down so as to give greater elegance to the eastern turrets. The apsidal termination of the choir in the east is covered in with a concrete vault surmounted by a timber roof, in striking contrast to the domes covering the other portions of the structure. Fig. 13 is a section through the nave showing how the domes are buttressed, fig. 14 is a section through the sanctuary dome, and figs. 15 and 16 a section and part plan of the vaulting of the choir with its wood span roof above the concrete vault.

Covering Materials for Roofs.—There are a large number of different roof-covering materials in common use, of which short descriptions, giving the principal characteristics, may be useful. The nature of the material employed as the outer covering affects the details of roof construction very considerably. A light covering such as felt or corrugated iron can be safely laid upon a much lighter timber framing than is necessary for a heavy covering of tiles or slates.

Roofing felt is an inexpensive fabric of animal or vegetable fibre treated with asphalt to make it capable of resisting the weather. It is largely used as a roofing material for temporary buildings. When exposed to the weather it should be treated with an application of a compound of tar and slaked lime well boiled and applied hot, the surface being sprinkled with sand before it becomes hard. Felt is also used on permanent buildings as a good non-conductor of heat under slating and other roof-covering materials. In this case it is not tarred and sanded. It is supplied in rolls containing from 25 to 35 yds. 30 in. wide. The sheets should be laid with a lap of 2 in. at the joints and secured to the boarding beneath by large-headed clout-nails driven in about 2 in. apart.

Corrugated iron is supplied either black or galvanized. It is especially suited for the roofs of out-buildings and buildings of a more or less temporary character. Being to a large extent self-supporting, it requires a specially designed roof framework of light construction. If, as is usually the case, the sheets are laid with the corrugations running with the slope of the roof, they can be fixed directly on purlins spaced 5 ft. to 10 ft. apart according to the stiffness and length of the sheets. In

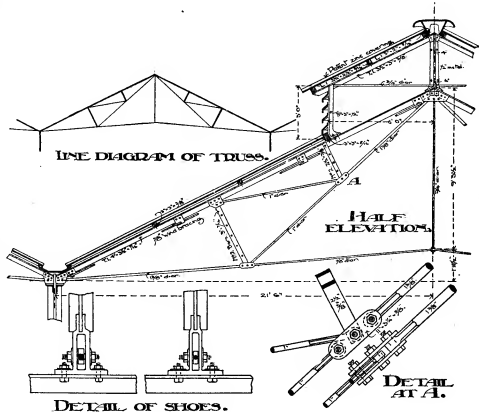

FIG. 10.—Roof at Cardiff Station.

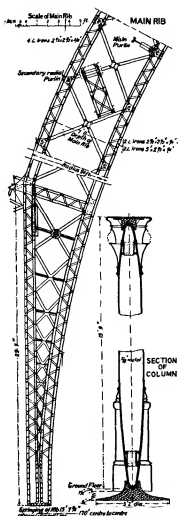

FIG. 11.—Detail of Main Rib and Column, Olympia.

pure air zinc coating of the galvanized sheets is durable for many years, but in large cities and manufacturing towns its life is short unless protected by painting. In such districts it has often been found that plain ungalvanized sheets well coated with paint will last longer than those galvanized, for the latter are attacked by corrosive influences through minute flaws in the zinc coating developed in the process of corrugation or resulting from some defect in the coating. The stock sizes of corrugated sheets vary from 5 ft. to 10 ft. long, and from 2 ft. to 2 ft. 9 in. wide with corrugations measuring 3 in. to 5 in. from centre to centre. For roofing purposes the sheets are supplied in several thicknesses ranging from No. 16 to No. 22 Standard Wire Gauge. No. 16 is for exceptionally strong work, No. 18 and No. 20 are used for good-class work, and No. 22 for the roofs of temporary buildings. The sheets when laid should lap about 3 in. at their sides and from 3 in. to 6 in. at the ends. Riveting is the best method of connecting the sheets, although galvanized bolts, which are not so satisfactory, are frequently employed. The joints should be made along the raised corrugations to lessen the risk of leakage. Holes can be punched during the erection of the roof; their positions should first be determined by placing the sheets in position and marking the

necessary point of fixing. Sheets are usually attached to timber framework with galvanized screws, or nails with domed washers placed under their heads. Fixing to a steel framework is effected by means of galvanized hooked bolts clipping the purlins passed through the sheet and held tight by nuts

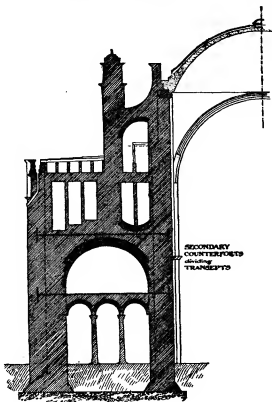

FIG. 13.—Westminster Cathedral: section through nave.

on the outside. Sheets corrugated in the Italian pattern have raised half-rounds every 15 in. or so, the portions between being flat. Such sheets have a very neat appearance and give a better effect in some positions than the ordinary corrugations.

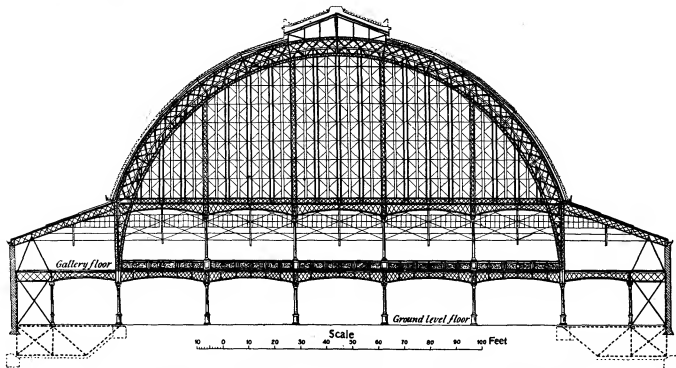
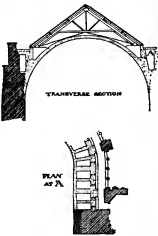

FIG. 12.—Cross-Section of Olympia from the Drawings of the architect, A. T. Walmisley, Esq.

Zinc in sheets is a material largely used as a roof covering, and if care be taken to ensure metal of good quality, it proves itself light, strong and durable, as well as inexpensive. Zinc is stronger weight for weight than lead, slate, tile and glass, but weaker than copper, wrought-iron and steel, although with the exception of the two last mentioned it is not so durable when exposed to the weather. It is not liable to easy breakage as are slate, tile and glass. It is usually supplied in flat sheets, although it can also be had in the corrugated form similar to corrugated sheet-iron. When exposed, a thin coating of oxide is formed on the surface which



Figs. 15 and 16.—Westminster Cathedral: choir-vaulting.

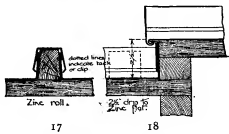

Fig. 14.—Westminster Cathedral: diagonal section through sanctuary dome.

protects the metal beneath from any further change, and obviates the necessity of painting. In laying the sheets, the use of solder and nails should be avoided entirely except for fixing clips and tacks which do not interfere with the free expansion and contraction of the sheets. The reason for this is that zinc expands freely, and sheets laid with soldered seams or fixed with nails are liable to buckle and probably break away owing to movements set up by changes of temperature. The usual sizes of zinc sheets are 7 ft. or 8 ft. long by 3 ft. wide. The thickness and weights of zinc are shown in the following table, which compares the Vieille Montagne Gauge with the Old Belgian Gauge and the British Imperial Standard Wire Gauge.

V.M.G.	O.B.G.	S.W.G.	Weight per sq. ft.
10	9	25	11½ oz.
11	10	24	13½ "
12	11	23	15 "
13	12	22	17 "
14	13	21	18½ "
15	14	20	21½ "
16	15	19	24½ "

The best method of laying a zinc flat roof is with the aid of wood "rolls" of about 2 in. x 2 in. in section, splayed at sides and spaced 2 ft. 8 in. apart and fixed to the roof boarding with zinc nails. Iron nails should not be used as this metal affects the zinc. The sheets of zinc are laid between the rolls with their sides bent up 1½ in. or 2 in. against them, and held firmly in position by clips of zinc attached to the rolls. A cap of the same metal is then slipped over each roll and fastened down by tacks about 3 in. long soldered inside it so as to hook under the same clips that hold the sheet down. Drips of about 2½ in. are made in the slope at intervals of 6 ft. or 7 ft.—that is, the length of a sheet—and special care must be taken at these points to keep the work waterproof. The lower sheet is bent up the face of the drip and under the projecting portion of the upper sheet, which is finished with a roll edge to turn off the water. The end of the roll has a specially folded cap which also finishes with a curved or beaded water check, and this in conjunction with the saddle piece of the roll beneath forms a weather-proof joint (figs. 17 and 18). The fall between the drips is usually made about 1 in.,



Figs. 17 and 18.—Details of Zinc Flats.

but where necessary it may be less, the least permissible fall being about 1 in 80. Felt laid beneath zinc has the effect of lengthening

the life of the roof and should always be used, as the edges of the boarding upon which it is laid are, when the latter warps, apt to cut the sheets. It also forms a cushion protecting the zinc if there is traffic across the roof.

Sheet-lead forms a much heavier roof covering than zinc, but it lasts a great deal longer and more easily withstands the attacks of impure air. Lead must be laid on a close boarding for its great ductility prevents it from spanning even the smallest spaces without bending and giving way. This characteristic of the metal, however, conduces largely to its usefulness, and enables it to be dressed and bossed into awkward corners without the necessity of jointing. The coefficient of expansion for lead is nearly as great as that for zinc and much higher than in the case of iron, and this fact requires precautions similar to those affecting zinc to be taken when laying the roofing. The manner of laying is with rolls and drips as in the case of zinc, the details of the work differing somewhat to suit the character of the material (see figs. 19, 20 and 21). Allowances must be made for expansion

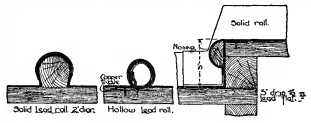

Figs. 19, 20 and 21.—Details of Lead Flats.

and contraction, and the use of nails and solder avoided as far as possible. Contact with iron sets up corrosion in lead, and when nails are necessary they should be of copper; screws should be of brass. Lead is supplied in rolls of 25 to 35 ft. long and 6 ft. to 7 ft. 6 in. wide. That in general use varies from one-fourteenth to one-seventh of an inch in thickness. The weights most suitable for employment in roofing work are 7 or 8 lb per square foot for flats and gutters, 6 lb for ridges and hips, and 5 lb for flashings.

As a roof covering copper is lighter, stronger and more durable than either zinc or lead. It expands and contracts much less than these metals, and although not so strong as wrought-iron and steel it is much more durable. From a structural point of view these qualities enable it to be classed as the best available metal for roof covering, although its heat-conducting properties require it to be well insulated by layers of felt and other non-conducting material placed beneath the metal. On exposure to the air copper develops a feature of great beauty in the coating of green carbonate which forms upon its surface protecting it from further decomposition. Perhaps the chief disadvantage in the use of copper lies in its first cost, but against this must be set the almost imperishable nature of the metal and the fact that by reason of its light weight less substantial framework is required for its support. Copper roofing should be laid in a similar manner to zinc, with wood rolls at intervals of about 2 ft. 4 in. It is, however, often laid with welted seams. The general stock sizes of sheets are from 4 ft. to 5 ft. 3 in. long and 2 ft. to 3 ft. 6 in. wide. The thickness almost invariably used is known as 24 S.W.G. and weighs 16 oz. per square foot. Thinner metal would suffice, but owing to the increased cost of rolling very little would be gained by adopting the thinner gauges.

In the United States of America "tin" roofs are quite commonly used. Sheets of wrought-iron coated either with tin or zinc are used of a size usually 14 in. by 20 in., though they may be had double this size. Preparation for laying is made by fixing an insulating foundation of somewhat stout paper or felt; this must be dry, else it is apt to spoil the impermeable covering laid upon it by causing it to rust. Junctions between the sheets are made by welted seams in which the four edges of the sheets are turned over so as to lock together, thus forming one large sheet of tin covering the roof. In high-class work of a permanent nature the seams in addition are soldered, rosin only being used as a flux. Each sheet also is secured to the roof with two or three tin cleats. The life of such roofs may be practically doubled by the application of a good coat of paint, which, however, adds considerably to the cost.

Slate is a strong and very impermeable material, and these qualities and the fact that it is easily split into thin plates suitable for laying, as well as its low cost, cause it to be by far the most generally used of all materials for roof covering. Some of the best known varieties of slates, classed according to their colour, are as follows:—

- Blue-grey . . . North Wales (Penrhyn, Festiniog, Dinorwic, &c.), France, Norway, Germany.
- Blue-grey . . . Cornwall (Delabole).
- Grey . . . North Wales (Penrhyn, Dinorwic).

Lead.

Copper.

Slate.

Purple . . . North Wales (Bangor, Penrhyn, Dinorwic), Newfoundland, and Germany.
Green . . . South Wales (Prestcely), Cumberland, Westmorland, Lancashire, Ireland, Newfoundland, Norway, United States and Germany.

Slates are cut to many different sizes varying in length from 10 in. to 36 in. and in width from 5 in. to 24 in. There are perhaps thirty or more recognized sizes, each distinguished by a different name. In common practice those generally used are "large ladies," 16 in. by 8 in.; "countesses," 20 in. by 10 in.; and "duchesses," 24 in. by 12 in. Generally speaking, the rule governing the use of the different sorts is that the steeper the pitch the smaller the slate, and vice versa. Buildings in very exposed positions naturally require steeply pitched roofs.

Some of the technical terms used by the slater are as follows:—
Bed, the under surface of a slab when laid.
Gauge, the upper surface of the slate.

Gauge, the distance between the lines of nailing. This depends on the length of the slate and equals half the length of the slate after the lap plus an inch for the nail-hole has been deducted. This is for slates nailed near the top edge; for those fixed near the middle the gauge would be half an inch more, as no allowance for nail-holes is required.

Margin, the width of the exposed portion of each course which equals the width apart of the nailing.

Head and tail, the top and bottom edges of the slate.
Lap, the lap of the tail of one course of slates over the head of the second course below it. The lap is made from 2½ in. to 4 in. (usually 3 in.), and for this distance there are three thicknesses of slate, namely, the tail of the top course, the middle of the next and the head of the third course.

Slates may be fixed by nailing at the head (see fig. 22) or at about the middle. The latter method is the stronger, as the levering effect of the wind cannot attain so great a strength. There is a small economy effected by centre nailing, as the margin is slightly larger and fewer slates are required to cover a given space; longer nails, however, are required, for as slates are laid at an angle with the pitch of the roof their centres cannot be made to approach so near

laid without provision for the admission of air will be found on removal after some time to have rotted so as to scale off and easily crumble into powder.

The nails used in slating are a very important item, and the durability of the work depends to a large extent upon them. They should have large flat heads. The most satisfactory are those made of a composition of copper and zinc, but others of copper, zinc, galvanized iron and plain iron are used. Those of copper are most durable, but are soft and expensive. Zinc nails are soft and not very durable; they will last about twenty years. Iron nails even if galvanized are objectionable in permanent work, though they may be used for temporary roofs. When the plain-iron nails are employed they should be heated and plunged in boiled linseed oil. The pitch of a roof intended for slating should not incline less than 25° with the horizontal, while 30° is a safer angle to adopt.

Tiles for roofing purposes are made from clay and burned in a manner similar to bricks. The clay from which they are made is, however, of a specially tenacious nature and prepared with great care so as to obtain a result as strong and as nearly non-porous as possible. Tiles are obtainable in many different colours, and some of these have a very beautiful effect when fixed and improve with age. They comprise a large number of tints from yellowish red, red and brown to dark blue. As with bricks the quality depends to a large extent upon the burning; underburnt tiles are weak and porous, liable to early decay, while overburning, though improving the tiles as regards durability, will cause them to warp and will spoil colour. The usual shape is the "plain tile," but they are made in various other shapes with a view both to easier fixing and better water-tight, and to ornamental effect. There are also several patented forms on the market for which the makers claim special advantages. The ordinary tiles are slightly curved in shape to enable them to lie close one upon the other. Some of them have small "nibs" moulded on at the head by which they may be hung upon the battens and nailing avoided (see fig. 23). Nail-holes are provided, and upon steep slopes it is advisable to make use of them. Others are made without the nibs, and are fixed either by nailing to the battens or boarding or hung by means of oaken pegs wedged in the holes to the battens, the pegs in the latter case acting in the same way as the above-mentioned nibs.

Plain tiles are of two general shapes. There are also angular forms, the standard dimensions are 10½ in. long by 6½ in. wide. They are usually ½ in. thick and weigh about 2½ lb each.

There are many forms of ornamental tiles, which are plain tiles having their tails cut to various shapes instead of moulded square. A number of patented forms of tiles also are on the market, some of which possess considerable merit. Pantiles are suitable for temporary and inferior buildings such as sheds and outhouses. They are laid on a different principle from plain tiles, merely overlapping each other at the edges, and this necessitates bedding in mortar and pointing inside and sometimes outside with mortar or cement. This pointing plays an important part in keeping the interior of the building free from the penetration of wind and water. Pantiles are generally made to measure 13½ in. long by 9½ in. wide, and weigh from 5 lb to 5½ lb each. Moulded on at the head of each tile is a small projecting nib which serves for the purpose of hanging the tile to the lath or batten. They are laid with a lap of 3½ in., 2½ in., or 1½ in., giving a gauge (and margin) of 10 in., 11 in. and 12 in., respectively. The side lap is generally 1½ in., leaving a width of 8 in. exposed face. There are many other forms based upon the shape of the pantile, some of which are patented and claim to have advantages which the original form does not possess. Among such are "corrugated tiles," of the ordinary shape or with angular flutes, and also the Italian pattern "double roll tiles," "Foster's locking-tiles." Poole's bonding roll tiles are a development of the Italian pattern tile.

Glass as a roof covering and the different methods of fixing it are dealt with in the article GLAZING.

There are many other materials used for roof covering besides those already described, many of them of considerable value. Some have in the past enjoyed considerable vogue, but have practically died out of use owing to the development and cheapening of other forms of roofing. Among these may be included thatch and wood shingles, the use of which in these days is practically reduced to special cases. Other little used roofing materials are those of recent invention, some of which perhaps

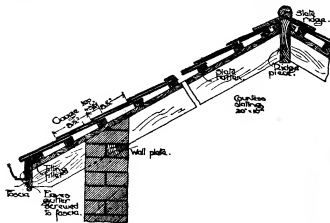

FIG. 22.—Detail of a Slated Roof.

to the slating battens or boarding as the head, which lies close on the surface to which it is fixed. Another point worth noticing is that the nail-holes in the centre nailed slating are only covered by 3 in. of the tail (the amount of the "lap") of the course of slates above, and rain is very liable to be forced under by the wind and cause the wood battens or other woodwork to rot. Head-nailed slates, on the other hand, have their holes covered by two layers of slate, and are removed from exposure by the length of the gauge plus the lap, which in the case of "countess" slating equals 11 in.

"Open slating" is an economical method of laying slates that is often adopted for the roofs of sheds and temporary buildings. The slates in the same course are not laid edge to edge as in close slating, but at a distance of two or more inches apart. This forms a roof covering light in weight and inexpensive, which, although not strictly weather-proof, is sufficiently so for the buildings upon which it is used.

Slates are laid upon open battens fixed upon the rafters or upon close boarding or upon battens fixed upon boarding. The battens are ½ in. or 1 in. thick and 1½ in. to 3 in. wide, and are spaced to suit the gauge of the slates. When close boarding is used it is often covered with inodorous asphalted felt. While taking these precautions to make the roof sound and tight it should be borne in mind that slate is liable to decay if not ventilated, and to effect this the battens are sometimes fixed vertically, ridge ventilators introduced and air inlets arranged at the eaves. The bed of slates

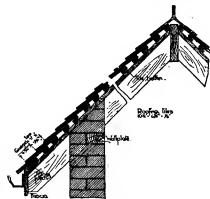

FIG. 23.—Detail of a Tiled Roof.

have a great future before them. Plates of asbestos used as slates or tiles make a light, strong and fireproof covering. Large terracotta tiles or slabs are much used in the United States of America. A good form of flat roof is that in which concrete is used as a foundation for a waterproof layer of asphalt, laid to slight falls to allow the water to run off easily. This is the usual method adopted when a roof garden is required. Shingles or hatch look extremely well on a roof, but their use is debarred in a great many districts owing to the danger of fire. Galvanized iron tiles, zinc tiles and copper tiles may be employed on small areas with good effect. "Willden paper," often used as an insulating layer beneath slates and tiles, is also at times used as a roof covering. It is cardboard chemically treated to render it tough, waterproof and fire-resisting.

The weights of some of the various materials used in the construction and covering of roofs are given in the following table. The weights which are approximate are for a square foot of roofing. The roof trusses are taken to be spaced 10 ft. apart and include the necessary purlins.

King-post wood truss 20 ft. to 30 ft. span	2 to 2½ lb
Queen-post " " 30 ft. to 50 ft. "	3 to 3½ "
Wood rafters " " " " " " " " " " " " " "	24 "
Ceiling joists and ceiling " " " " " " " " " " " " " "	11 "
½-in. boarding for roof covering " " " " " " " " " " " " " "	2½ "
1-in. "	3½ "
1½-in. "	4½ "
2½-in. X 1 in. slate battens for 8½-in. gauge	14 "
Feet "	17 "
Thatch "	6½ "
Slates (ordinary laid with 3-in. lap) " " " " " " " " " " " " " "	9 "
Tiles, plain flat "	18 "
Pantiles "	20 "
Zinc 12 to 16 gauge laid complete including rolls " " to " "	14 to 12 "
Copper 25 to 19 gauge laid complete including rolls " " to " "	12 to 21 "
Lead weighing 6 lb per square foot laid complete including rolls "	6½ "
Corrugated iron 20 S.W. gauge " " " " " " " " " " " " " "	2 "

Wind pressure is usually calculated at 22 to 25 lb on a roof with pitch of 30°, and 27 to 30 lb on a roof of 45° pitch.

From these particulars it is easy to calculate the weight of a square (100 superficial ft.) of roofing material, this being the usual standard of measurement for many roofing materials.

The London Building Act of 1894 and its amendments set forth with regard to roofs erected in the London district that every structure on a roof is to be covered with slate, tile, metal, Regula- or other incombustible material, except wooden cornices and barge boards to dormers not exceeding 12 in. in depth, and doors and windows and their frames. Every dwelling-house or factory above 30 ft. in height and having a parapet must have means of access to the roof. The pitch of the roofs of warehouse buildings must not exceed 47°, and those of other buildings must not exceed 75°, but towers, turrets and spires are excepted. In domestic buildings not more than two storeys are to be formed in the roof, and if the floor is more than 60 ft. above the street level fireproof materials must be used throughout and a sufficient means of escape provided. The building by-laws of the municipality of Johannesburg contain several clauses affecting the designing of roofs and their method of construction. In the designing of buildings roof-slopes must be within a line drawn and produced from the ground level at the opposite side of the street to the top of the eaves, gutter or parapet. No roof in the municipal fire limit may be constructed of thatch, reed or other inflammable material. Within the fire area they may be so constructed if the building stands at least 20 ft. from the boundary of its site. Roofs having stands of less than 22½" must be constructed to bear safely a load of at least 28 lb per square foot of surface. Roofs of steeper pitch must be able to support a live load of 21 lb per square foot. The framing of Mansard or other roofs of more than 60° pitch on a building exceeding 45 ft. high must be constructed of approved fireproof material at least 2 in. thick. No roofs except those of towers, turrets or spires shall exceed 70° pitch for a Mansard or 60° for an ordinary roof. Every fireproof roof, in addition to a door or scuttle for access from below, must have a skylight or skylights with metal framing, having an area equal to at least one-sixteenth the area of the roof. Skylights placed over rooms or areas to which the public have access must be protected by wire netting below or be glazed with wire-glass.

The Building and Health Laws and Regulations and Amendments of 1905 affecting the city of New York are based, so far as the construction of roofs goes, upon the same lines as those of London, the principal exceptions being that they give very full working details, under part 24, as to the strengths of materials required to be used and the wind pressure to be provided against. In part 17 they provide that where a building exceeds three storeys or 40 ft. in height and the roof has a pitch of over 60°, it shall be constructed of iron rafters and be lathed with iron or steel on the inside and plastered or be filled in with fireproof material not less than 3 in. thick and covered with metal, slate or tile. The provision as to access to roof and fire escapes therefrom adopted by the London

County Council in 1907 under the London Building Act Amendment Act 1905 were in operation in New York in 1899.

LITERATURE.—The principal reference books on this subject are the following:—Thomas Tredgold, *Elementary Principles of Carpentry*; J. Newland, *Carpenter and Joiner's Assistant*; G. L. Sutcliffe, *The Modern Carpenter, Joiner and Cabinet Maker*; J. Griffiths, *Prusses in Wood and Iron*; F. Bond, *Gothic Architecture*; J. G. Swift, *Encyclopædia of Architecture*; F. E. Kidder, *Trussed Roofs and Roof Trusses*; J. Brandon, *Analysis of Gothic Architecture*; A. Pugin, *Ornamental Gables*; M. Emy, *L'Art de la charpenterie*; Viollet le Duc, *Dictionnaire*; J. K. Colling, *Détails of Gothic Architecture*.

(J. B. T.)

ROOK (O.E. *Hrōc*, Icel. *Hrókr*,¹ Swed. *Råka*, Du. *Rook*, Gael. *Rocas*), the *Corvus frugilegus* of ornithology, and throughout a great part of Europe the commonest and best-known of the crow-tribe, belonging to the Passerine family Corvidæ. Besides its pre-eminently gregarious habits, which did not escape the notice of Virgil (*Georg.* i. 382)² and are so unlike those of nearly every other member of the Corvidæ, the rook is at once distinguished from the rest by commonly losing at an early age the feathers from its face, leaving a bare, scabrous and greyish-white skin that is sufficiently visible at some distance. In the comparatively rare cases in which these feathers persist, the rook may be readily known from the black form of crow (*c. n.*) by the rich purple gloss of its black plumage, especially on the head and neck, the feathers of which are soft and not pointed. In a general way the appearance and manners of the rook are well known, and particularly its habit of forming communities in the breeding-season, which it possesses in a measure beyond that of any other land bird of the northern hemisphere. Yet each of these communities, or rookeries, seems to have some custom intrinsically its own. In a general way the least-known parts of the rook's mode of life are facts relating to its migration and geographical distribution. Though the great majority of rooks in Britain are sedentary or only change their abode to a very limited extent, it is now certain that a very considerable number arrive in or towards autumn, not necessarily to abide, but merely to pass onward, like most other kinds of birds, to winter farther southwards; and, at the same season or even a little earlier, it cannot be doubted that a large proportion of the young of the year migrate in the same direction. As a species the rook on the European continent only resides during the whole year throughout the middle tract of its ordinary range. Farther to the northward, as in Sweden and northern Russia, it is a regular summer-immigrant, while farther to the southward, as in southern France, Spain and most parts of Italy, it is, on the contrary, a regular winter-immigrant. The same is found to be the case in Asia, where it extends eastward as far as the upper Irish and the Ob. It breeds throughout Turkestan, in the cold weather visiting Afghanistan, Cashmere and the Punjab, and Sir Oliver St John found a rookery of considerable size at Casbin in Persia. In Palestine and in lower Egypt it is only a winter-visitant, and H. B. Tristram noticed that it congregates in great numbers about the mosque of Omâr in Jerusalem. The same writer (*Proc. Zool. Soc.*, 1864, p. 444; *Ibis*, 1866, pp. 68, 69) considered the Palestine rook entitled to specific distinction as *Corvus Agricola*. The rook of China has also been described as a distinct species, *C. pasinator* (*Proc. Zool. Soc.*, 1845, p. 1) from having the feathers of its face only partially deciduous.

ROOKE, SIR GEORGE (1650–1709), English naval commander, was born near Canterbury in 1650. Entering the navy as a volunteer, he served in the Dutch Wars and became post-captain in 1673. After the Revolution of 1688, he commanded

¹ The bird, however, does not inhabit Iceland, and the language to which the name belongs would perhaps be more correctly termed Old Teutonic. From this word is said to come the French *Corbeau*. There are many local German names of the same origin, such as *Rooke*, *Rouch*, *Ruch* and others, but the bird is generally known in Germany as the *Saat-Krâhe*, i.e. seed—=corn—crow.

² This is the more noteworthy as the district in which he was born and educated is almost the only part of Italy in which the rook breeds. Shelley also very truly speaks of the "legioned rooks" to which he stood listening "mid the mountains Euganean."

the squadron which raised the siege of Londonderry in 1689. He became rear-admiral in 1690, and fought at the battle of Beachy Head. In May of 1692 he served under Russell at the battle of Barfleur, and he greatly distinguished himself in a night attack on the French fleet at La Hogue, when he succeeded in burning six of their ships. Shortly afterwards he received the honour of knighthood and a reward of £1000. In 1693 he commanded the Smyrna convoy, which was scattered and partly taken by the French admiral Tourville near Lagos Bay. Till the peace of Nymwegen (1697), he continued to serve in the Channel and Mediterranean. In 1702 he commanded the expedition against Cadiz, and on the passage home destroyed the Plate fleet in Vigo. With Sir Cloudesley Shovel he took part in the capture of Gibraltar on the 21st of July 1704. On the 13th of August of the same year he attacked the French fleet off Malaga, the battle being drawn. On account of the dissatisfaction expressed indirectly at the result of the contest, he retired from the service in February 1705. He died on the 24th of January 1709.

Rooke's Journal for 1700-2 has been printed by the Navy Record Society.

ROOM, originally a word meaning space or accommodation; the ordinary meaning of an apartment in a building, one of the interior divisions of a house, dates from the 15th century. The word is common to Teutonic languages, cf. Du. *ruim*, Ger. *Raum*, Swed. and Dan. *rum*, with the original meaning of space. Skeat connects the word with the root seen in Lat. *rus*, open country.

ROON, ALBRECHT THEODOR EMIL, COUNT VON (1803-1879), Prussian general field-marshal, was born at Pleushagen, near Colberg, in Pomerania, on the 30th of April 1803. His family was of Flemish origin, and was settled in Pomerania. His father, an officer of the Prussian army, died in poverty during the French occupation, and young von Roon was brought up, in a country ravaged in the War of Liberation and in straitened circumstances, by his maternal grandmother. He entered the corps of cadets at Kulin in 1816, whence in 1818 he proceeded to the military school at Berlin, and in January 1821 received a commission in the 14th (3rd Pomeranian) regiment quartered at Stargard in Pomerania. In 1824 he went through the three years' higher course of study at the war school in Berlin, where he also applied himself with the greatest energy to improving his general education. In 1826 he was transferred to the 15th regiment at Minden, but in the same year was appointed an instructor in the military cadet school at Berlin, where he devoted himself especially to the subject of military geography. He published in 1832 the well-known *Principles of Physical, National and Political Geography*, in three volumes (*Grundzüge der Erd-, Völker- und Staaten-Kunde*), which gained him a great reputation, and of which over 40,000 copies were sold in a few years. This work was followed in 1834 by *Elements of Geography (Anfangsgründe der Erdkunde)*, in 1837 by *Military Geography of Europe (Militärische Länderbeschreibung von Europa)*, and in 1839 by *The Iberian Peninsula (Die Iberische Halbinsel)*.

Meantime, in 1832, he rejoined his regiment, and was afterwards attached to the headquarters of General von Müffling's corps of observation at Crefeld, when he first became alive to the very inefficient state of the Prussian army. In 1833 he was appointed to the Topographical Bureau at Berlin, in 1835 he entered the General Staff, and in the following year was promoted captain and became instructor and examiner in the military academy at Berlin. In 1842, after an illness of two years brought on by overwork, he was promoted to be major and attached to the staff of the VII. corps, in which post he was again impressed with the inefficiency of the organization of the army, and occupied himself with schemes for its reform. Two years later, as tutor to Prince Frederick Charles, he attended him at Bonn university and in his European travels. In 1848 he was appointed chief of the staff of the VIII. Army Corps at Coblenz. During the disturbances of that year he served under the Crown Prince William (afterwards German emperor) in the suppression of the insurrection at Baden, and distinguished

himself by his energy and bravery, receiving the 3rd class of the order of the Red Eagle in recognition of his services. While attached to the Crown Prince's staff at that time he broached to him the subject of his schemes of army reform. In 1850 came the revelation of defective organization and efficiency which led to the humiliating treaty of Olmütz. In the same year Roon was made a lieutenant-colonel, and in 1851 full colonel. He now enjoyed the confidence of Prince William, and began active work as reorganizer of the army.

Promoted to be major-general in 1856 and lieutenant-general in 1859, Roon had held since 1850 several commands and had been employed on important missions. Prince William became regent in 1857, and in 1859 he appointed Roon a member of a commission to report on the reorganization of the army. Supported by Manteuffel and Moltke, Roon was able to get his plans seriously considered and generally adopted. His aim was to create an armed nation, to extend Scharnhorst's system and to adapt it to Prussia's altered circumstances. To attain this he proposed a universal three years' service, and a reserve (*Landwehr*) for the defence of the country when the army was actively engaged. During the Italian War he was charged with the mobilization of a division. At the end of 1859, though the junior lieutenant-general in the army, he succeeded von Bonin as war minister, and two years later the ministry of marine was also entrusted to him. His proposals of army reorganization met with the bitterest opposition, and it was not until after long fighting against a hostile majority in the chambers that, with Bismarck's aid, he carried the day. Even the Danish campaign of 1864 did not wholly convince the country of the necessity of his measures, and it required the war with Austria of 1866 to convert obstinate opposition into enthusiastic support. After that von Roon, from being the best-hated man in Prussia, became the most popular, and his reforms were ultimately copied throughout continental Europe. He was promoted general of infantry at the outbreak of this war, was present at the brilliant and decisive victory of Königgratz, and received the Black Eagle at Nikolsburg on the road to Vienna. His system, adopted after 1866 by the whole North German Confederation, produced its inevitable result in the victorious war with France 1870-71, throughout which von Roon was in attendance on the German emperor. The fiftieth anniversary of his entrance into the army was celebrated at Versailles on the 19th of January 1871, when the emperor expressed his gratitude for the great services he had rendered. He was created a count, and in December 1871, having resigned the ministries of war and marine, he succeeded Bismarck as president of the Prussian ministry. Ill-health compelled him to resign in the following year. He was promoted to be field-marshal on the 1st of January 1873. He died at Berlin on the 23rd of February 1879.

After his death his son published the valuable *Denkwürdigkeiten aus dem Leben des Generalfeldmarschalls Kriegsministers Grafen Roon* (2 vols., Breslau, 1892), and *Kriegsminister von Roon als Redner politisch und militärisch erläutert* (Breslau, 1895). His correspondence with his friend Professor Cl. Perthes, 1864-67, was also published at Breslau in 1895.

ROORKEE, or **RURKI**, a town of British India, in the Saharanpur district of the United Provinces, on the Oudh & Rohilkhand railway, 22 m. E. of Saharanpur. Pop. (1901) 17,197. It is the headquarters of the workshops of the Ganges canal, and also of the Bengal Sappers and Miners. Two heavy batteries of artillery are usually stationed in the cantonment. The Thomason Civil Engineering College, founded in 1848, was transferred from the Public Works to the Education Department in 1895 and reorganized. It was instituted in order to train natives in engineering, and students originally received stipends. After 1875 the emoluments were limited, and became in the nature of scholarships, but the education of all students remained practically free till 1896, when fees began to be charged. The college works in co-operation with the workshops and foundry of the canal, and also trains in surveying, photography and other subjects, having chemical, physical, electrical and mechanical laboratories and workshops.

ROOSEVELT, THEODORE (1858-), twenty-sixth president of the United States, was born in New York City on the 27th of October 1858. The Roosevelt family¹ has been prominent in the life of New York for many generations, and is of Dutch origin. Mr Roosevelt's mother, Martha Bullock, came from a family of Scotch-Irish and Huguenot origin equally prominent in Georgia. Each family may lay just claims to a history of more than ordinary social and political distinction. Although born in New York, Mr Roosevelt spent much of his boyhood at Oyster Bay, the country home of his father, on Long Island Sound, where he began with a distinct purpose, unusual among boys of his age, to build up a naturally frail physique by rowing and swimming in the waters of Long Island Sound, and by riding over the hills and tramping through the woods of Long Island. That his early outdoor life furnished a definite training for his after career is indicated by the fact that when he was about fourteen years of age he went with his father on a tour up the Nile as far as Luxor, and on this journey he made a collection of Egyptian birds found in the Nile valley, which is now in the Smithsonian Museum in Washington, D.C. Mr Roosevelt was educated at Harvard University, where he graduated in the class of 1880;² his record for scholarship was creditable, and his interest in sports and athletics was especially manifest in his skill as a boxer. On leaving college he made a short visit to Europe, was elected to the London Alpine Club for climbing the Jungfrau and the Matterhorn, and returning to New York studied law for a brief period in the Law School of Columbia University and in the office of his uncle Robert B. Roosevelt. Determining to enter active politics, he gave up his legal studies without qualifying for the bar, and in 1881 was elected to the New York legislature as a regular Republican, although in opposition to the "boss" of the assembly district for which he was a candidate. He was elected again in 1882 and in 1883, and at the age of twenty-four was his party's candidate for Speaker of the Assembly. In 1884 he was a delegate of the Republican party to the convention in Chicago which nominated James G. Blaine for president. In the convention he opposed the nomination of Mr Blaine, and in a speech which attracted considerable

¹ Claas Martenszen van Roosevelt (or Rosenvelt) settled in New Amsterdam in 1649; his son Claas (or Nicholas) in 1700-1 was a New York alderman of the Leislerian party; in the next three generations, Johannes, Cornelius and Jacobus (James) were merchants and (in 1748-67, 1785-1801 and 1797-99 and 1809, respectively) aldermen of New York; in the third generation the family became allied with the Schuylers. Isaac Roosevelt was a member of the Provincial Congress in 1775-77 and of the state Senate in 1777-86 and in 1788-92; in the state Assembly were James Roosevelt (1796-97), Cornelius C. Roosevelt (1803), James I. Roosevelt, jun. (1835-40), and Clinton Roosevelt (1837-40). James I. Roosevelt, jun. (1795-1875), was a Democratic member of the national House of Representatives in 1841-43, and a justice of the state Supreme Court in 1851-59. Nicholas J. Roosevelt (1767-1854), with John Stevens, Robert R. Livingston and Robert Fulton, was prominent in the development of steam navigation. His brother, Cornelius van Schaik Roosevelt (1794-1871), was a founder of the Chemical National Bank of New York, and the grandfather of the president. The president's uncle, Robert Barnwell Roosevelt (1829-1906), was a New York lawyer, New York state fish commissioner in 1866-68, a member of the Committee of Seventy which exposed the corruption of Tammany in New York City, a Democratic member of the national House of Representatives in 1871-73, U.S. minister to the Netherlands in 1888, and author of works on American game birds and fish. B. B. Roosevelt's brother, the president's father, Theodore Roosevelt (1858-1878), was a glass importer, prominent in city charities, an organizer of the United League Club, and the founder of the Orthopaedic Hospital. A cousin, James Henry Roosevelt (1800-1863), was founder of the Roosevelt Hospital in New York City. The president's mother, Martha Bullock, was of an old Georgia family of Scotch-Irish and Huguenot extraction; her grandfather was Archibald Bullock (1730-1777), first president (1776-77) of Georgia; and her brother, James Dunwoody Bullock, often compared by Theodore Roosevelt to Colonel Newcome, was in the Confederate navy, and equipped in England vessels (including the "Alabama") as Confederate cruisers.

² In the same year he married Alice Hathaway Lee of Boston, who died in 1884 leaving one daughter. Later (in 1886) he married Edith Kermit Carow of New York City, and by this marriage had four sons and one daughter.

attention for its vigour and courage advocated the nomination of Senator George F. Edmunds. After Mr Blaine's nomination, however, he supported him in the campaign as the chosen candidate of the party, in spite of the fact that an important wing of the Republican party "bolted" the nomination and espoused the candidacy of Grover Cleveland, who was elected president. In 1884, partly because his political life seemed at least for the immediate present to be at an end, partly on account of the freedom and activity of out-of-door life, he bought two cattle ranches near Medora on the Little Missouri river in North Dakota, where he lived for two years, becoming intimately associated with the life and spirit of the western portion of the United States.

In 1886 he was the Republican candidate for mayor of New York City, but was defeated by Abram F. Hewitt, the Tammany candidate, and received a smaller vote than Henry George, the candidate of the United Labor party. Mr Roosevelt, however, received a larger proportion of the total vote cast than any mayoralty candidate of the Republican party had previously received in New York City. In April 1889, on the accession to the presidency of Benjamin Harrison, Mr Roosevelt, then closely identified with the work of Civil Service reform, was appointed a member of the United States Civil Service Commission. In this office, until then one of minor importance, he served for six years. He made it not only nationally prominent, but instrumental in shaping the course of legislative and executive action by introducing into the work of the Commission an entirely new spirit and new methods. The annual reports, of which he was the chief author, became controversial pamphlets; he published bold replies to criticisms upon the work of the Commission; he explained its purposes to newspaper correspondents; when Congress refused to appropriate the amount which he believed essential for the work, he made the necessary economies by abandoning examinations of candidates for the Civil Service in those districts whose representatives in Congress had voted to reduce the appropriation, thus very shrewdly bringing their adverse vote into disfavour among their own constituents; and during the six years of his commissionership more than twenty thousand positions for government *employés* were taken out of the realm of merely political appointment and added to the classified service to be obtained and retained for merit only. In 1895 he resigned from the Civil Service Commission and became President of the Board of Police Commissioners for the City of New York. After a strenuous two years in this office, he was appointed by President McKinley in 1897 assistant-secretary of the navy. He was certain that war with Spain was inevitable, and he did much to prepare the navy for hostilities, framing an important personnel bill, collecting ammunition, getting large appropriations for powder and ammunition used in improving the marksmanship of the navy by gunnery practice, buying transports and securing the distribution of ships and supplies (especially in the Pacific) in such a way that, when hostilities were declared, American naval victories would be assured. He urged upon the administration the bold policy of protesting against the sailing of Cervera's fleet, on the ground that it would be regarded as a warlike measure not against the Cuban revolutionaries, who had no navy, but against the United States; and he advised that, if Cervera sailed, an American squadron be sent to meet him and to prevent his approach to America. At the outbreak of the war with Spain he resigned from the Navy Department and raised the first volunteer regiment of cavalry, popularly known as the "Rough Riders," because many of its members were Western cowboys and ranchmen expert in the handling of the rough and often unbroken horses of the Western frontier. The regiment also included college athletes, city clubmen and members of the New York police force, every man possessing some special qualification for the work in view. Mr Roosevelt declined the colonelcy of the regiment, preferring to take the post of lieutenant-colonel under his intimate friend Dr Leonard Wood, who, while a surgeon in the United States Army, had served

in action with gallantry and skill against the Indians. On the promotion of Colonel Wood to the command of the brigade, Mr Roosevelt became colonel of the regiment, which took an especially prominent part in the storming of San Juan Hill. In this battle Colonel Roosevelt became the ranking officer and, abandoning his horse, led the charge up the hill on foot under severe fire at the head of his troops. This charge, in which many of the "Rough Riders" were killed or wounded, drove the Spaniards from the trenches and opened the way to the surrender of Santiago. At the conclusion of the war, while the troops were still in camp in the South, Mr Roosevelt joined in a "round robin" of protest against the mismanagement in the War Department, which had resulted in widespread suffering among the troops from wretched food and bad sanitary arrangements. This "round robin" created a sensation which aroused public opinion and was instrumental in bringing about some desirable reforms in the War Department.

When his regiment was mustered out of service in September 1898, Mr Roosevelt was nominated by the Republican party for the governorship of New York State and was elected in November by a substantial plurality. He was governor for two years. He reformed the administration of the state canals, making the Canal Commission non-partisan; he introduced the merit system into many of the subordinate offices of the state; and he vigorously urged the passage of and signed the Ford Franchise Act (1899), taxing corporation franchises. In various contests, in which he was almost uniformly victorious, he showed himself to be independent of "boss" control. In 1900, although he wished to serve another term as governor in order to complete and establish certain policies within the state, he was nominated for the vice-presidency of the United States on the ticket with President McKinley by the Republican National Convention in Philadelphia in spite of his protest. It was very commonly believed at the time that this nomination for the vice-presidency was participated in and heartily approved of by the machine politicians or "bosses" of the State of New York in their belief that it would result in his elimination from active political life. The office of vice-president of the United States had so far in the history of the country been almost purely a perfunctory one, and has rarely, if ever, led to political promotion. The vice-president is *ex officio* president of the Senate, but has little voice or part in shaping either legislation or the affairs of the party. Mr Roosevelt never, however, presided over the deliberations of the Senate, because before the session following his inauguration convened he had ceased to be vice-president.

Upon the assassination of McKinley, on the 14th of September 1901, he succeeded to the presidency. No previous president had entered the office at so early an age as forty-three. It was his frankly expressed wish to be nominated and elected president in 1904, and he was nominated unanimously by the Republican National Convention at Chicago, and was elected in November of that year by the largest popular majority ever given to any candidate in any presidential election. He received 7,623,486 popular votes and 336 electoral votes to 5,077,971 popular votes and 140 electoral votes cast for Judge Alton B. Parker, the nominee of the Democratic party. Immediately after his election he publicly declared that he would not accept the nomination for the presidency in 1908, and he adhered to that pledge in spite of great popular pressure brought to bear upon him to accept the nomination of the party for another term. The nomination and election of President Taft, who had been a member of Mr Roosevelt's cabinet, was very largely due to the latter's great influence in the party. On March 23rd, two weeks after he ceased to be president, Mr Roosevelt sailed for Africa, to carry out a long-cherished plan of conducting an expedition for the purpose of making a scientific collection of the fauna and flora of the tropical regions of that continent. Expert naturalists accompanied the party, which did not emerge from the wilderness until the middle of the following March, bringing with it a collection which scientists

pronounce of unusual value for students of natural history. Most of the specimens were sent to the National Museum of the Smithsonian Institution at Washington. The experiences of his African journey were recorded by Mr Roosevelt in a volume entitled *African Game Trails: The Wanderings of an American Hunter Naturalist*. The spring and early summer of 1910 were spent by Mr Roosevelt in travelling through Egypt, the continent of Europe, and England, in acceptance of invitations which he had received to make various public speeches in these countries. Honorary academic degrees were conferred upon him by the universities of Cairo, Christiania, Berlin, Cambridge and Oxford, and he was given both popular and official ovations of almost royal distinction—ovations which were repeated by his own countrymen on his return to America.

It may be said without exaggeration that no American public man in the history of the country has achieved such extraordinary popularity during his lifetime as Mr Roosevelt had attained at fifty years of age, both at home and abroad. Great popularity necessarily brings with it bitter enmity and genuine criticism. To understand clearly his career as a public man, and to appreciate the forces at work which caused both the popularity and the enmity, two facts must be kept distinctly in mind: first, that at twenty-two years of age he deliberately decided to make politics his life-work at a time when in the United States the word "politics" had a sinister sound in the ears of almost all of the so-called cultivated classes; and secondly, that in making this deliberate choice he recognized that the government of the United States is primarily a party government. He therefore allied himself with the Republican party, to which by tradition, by family association, and by political principles he was naturally drawn.

In the history of the United States the politician has been too often the man who, in connexion with some other trade or profession, has taken up politics as a tool to carve out some personal ambition or manufacture a financial profit. Mr Roosevelt from the beginning apparently believed with the lexicographers that politics is the science and practice of government. He has himself told the story of an early experience that illustrates his point of view. When in 1881 he decided to join the Republican Association of his assembly district in New York City, members of his family were shocked. "You will find at the meetings," they said, "nobody but grooms, liquor dealers and low politicians." "Well," said Mr Roosevelt in reply, "if that is so, they belong to the governing class, and you do not. I mean if I can be to one of the governing class." He forthwith became an active member of the political organization of his district. He also early determined to work with his party as being the only way in which a legislator can work. A free lance, an independent, a journalist, or a preacher, without definite political affiliations, may create public opinion, but a legislator or an administrator must belong to a party. Mr Roosevelt was severely criticized by many "independent Republicans" for having supported the presidential candidacy of James G. Blaine in 1884, when he had vigorously opposed his nomination in the convention on moral grounds. The reply to this criticism is that Mr Blaine was the choice of the majority of the party, and that while Mr Roosevelt felt free to fight within the party vigorously for reform, he did not feel that the nomination justified a schism like that which occurred in the Democratic party over the free silver issue in 1896—a schism which remained afterwards a hopeless weakness in that party. His position in the Blaine campaign, his attitude in tariff discussions and legislation, his relations with United States senators, congressional representatives, and other party leaders, his methods in making official appointments, were entirely consistent with his constantly reiterated conviction that in politics permanent good is achieved not by guerilla warfare, but by working through and within the party. He was so often accused by political purists for associating politically with men of discredited reputation that his own picturesque statement of his conversion to a belief that in legislative or administrative politics

one must work with all sorts and conditions of men is illuminating. This statement is related by his intimate friend Jacob A. Riis,¹ to whom Mr Roosevelt made it in commenting upon his first political success in the New York legislature.

"I suppose that my head was swelled. It would not be strange if it was. I stood out for my own opinion alone. I took the best 'mugwump' stand—my own conscience, my own judgment were to decide in all things. I would listen to no argument, no advice. I took the isolated peak on every issue, and my associates left me. When I looked around, before the session was well under way, I found myself alone. I was absolutely deserted. The people didn't understand. The men from Erie, from Suffolk, from anywhere, would not work with me. 'He won't listen to anybody,' they said, and I would not. My isolated peak had become a valley; every bit of influence I had was gone. The things I wanted to do I was powerless to accomplish. I looked the ground over, and made up my mind that there were several other excellent people there, with honest opinions of the right, even though they differed from me. I turned in to help them, and they turned to and gave me a hand. And so we were able to get things done. We did not agree in all things; but we did in some, and those we pulled at together. That was my first lesson in real politics. It is just this: if you are cast on a desert island with only a screw-driver, a hatchet and a chisel to make a boat with, why, go make the best one you can. It would be better if you had a saw, but you haven't. So with men. Here is my friend in Congress who is a good man, a strong man, but cannot be made to believe in some things in which I trust. It is too bad that he doesn't look at it as I do, but he *does not*, and we have to work together as we can. There is a point, of course, where a man must take the isolated peak and break with all his associates for clear principle: but until that time comes he must work, if he would be of use, with men as they are. As long as the good in them overbalances the evil, let him work with them for the best that can be obtained."

In his successive offices Mr Roosevelt not merely exerted a strong influence upon the immediate community, whose official representative he was at the time being, but by reason both of his forceful personality and of the often unconventional, although always effective, methods of work which he employed he achieved a national prominence out of ordinary proportion to the importance of his official position. His record in the Assembly was such that his party nominated him for the mayoralty of the city of New York when he was absent on his ranch in Dakota. Although defeated in the mayoralty election, his work on behalf of the merit system, as opposed to the spoils system of politics, was such that he was made a Civil Service commissioner—probably the last office a politician would wish to hold who desired further promotion, for the conflict which a Civil Service commissioner must have with members of Congress and other party leaders on questions of patronage is usually, or, at any rate, has been in the past history of American politics, inevitably detrimental to further official advancement. He was taken from the Federal service in Washington to New York City by a reform mayor and put in charge of the police, because he had shown both physical and moral courage in fighting corruption of all sorts; and the New York police force at that time was thoroughly tainted with corruption, not in its rank and file, but among its superior officers, who used the power in their hands to extort money bribes chiefly from saloon-keepers, liquor-dealers, gamblers and prostitutes. As police commissioner Mr Roosevelt brought to his side every honest man on the force. By personal detective work, that is, by visiting police stations at unexpected times and by making the rounds at night of disorderly places where were suspected of violating the law, he not only displayed personal courage in positions of some danger, but aroused public opinion. The very sensation created by the novelty of his methods set standards and started reforms which have greatly improved the *morale* of the entire force. The hopelessly vicious policemen hated him, but no man ever had a stronger personal hold upon the great body of the honest officers—a hold which existed long after he left the police department, and was frequently expressed by members of the force as he passed through the city streets. When he became assistant-secretary of the navy, his work was not so publicly conspicuous,

¹ In a volume entitled *Roosevelt the Citizen*, which, while it is frankly written as the enthusiastic tribute of a personal admirer, may be relied upon for accuracy in its statement of historical or biographical facts.

but in this office he gained an experience which was of great value in his administration of naval affairs during his presidency. It is doubtful if, without the experience of this secretaryship, he could have successfully originated and carried out the plan of sending the United States navy around the world in 1907. He went to the Spanish War as a volunteer against the urgent wishes of his political advisers, and in spite of the protests of some of his best and most intimate friends. The conditions in Cuba had long convinced him that war with Spain was inevitable, and that, for humane reasons alone, it was both right and necessary to drive the Spanish power out from the Caribbean Sea. Having urged this view upon the country, when war was declared he felt that it would be inconsistent for him not to share personally in the perils of a conflict which he believed to be a just one, and which he had done as much as he could to bring about. His record in the war for efficiency and personal gallantry no doubt contributed largely to his nomination and election as governor of the state of New York; but he attained the governorship not on this ground alone. There are many instances in American politics of nominations made solely on a war record which have led to hopeless defeat in election. His work in the governorship brought him still more into prominence as a national leader. His uncompromising antagonism to political blackmail and bribery, and his determination to pursue the right, as he saw the right, only in a common-sense fashion, made bitter enemies on the one hand among the corrupt politicians, and, on the other hand, among theoretical reformers, and discussions raged in the newspapers about his executive acts, his speeches, and his official messages much as they raged during his seven years in the White House. If he had never reached the presidency he would probably have been a figure long remembered in American political life. But it was his course in the presidency that gave him his international reputation, and it is as President Roosevelt that future historians of American political life must chiefly discuss him.

Mr Roosevelt entered the presidency definitely committed to two principles which profoundly affected his course as chief executive of the United States. He had a well wrought-out belief in centralized authority in government and a passionate hatred of political and commercial corruption. He believed the United States to be a unified republic, a sovereign nation, and not a federation of independent states united only for mutual benefit and protection. He not only hated corruption *per se*, but he clearly saw that as efficiency has a greater power for good, so corruption has a greater power for evil in a strongly centralized government. He understood that political materialism, selfishness and corruption in federal administration afford the strongest possible argument for those who advocate strengthening the independent power of the separate states at the expense of nationalism. At the very outset of his administration he therefore set himself to work, not only to improve the personnel of the government service, but by exhortations in his messages and public speeches to arouse a sense of civic responsibility both among office-holders and among all the citizens. His official messages to Congress, probably more frequent, certainly much longer than those of any of his predecessors, were quite as often treatises on the moral principles of government as they were recommendations of specific legislative or administrative policies. The effect of his exhortations, as well as of his personal character and public acts, upon the standards and spirit of official life in the United States, was a pronounced one in attracting to the federal service a group of men who took up their work of public office with the same spirit of enthusiasm and self-sacrifice that actuates the military volunteer in time of war. No American president has done so much to discredit and destroy the old Jacksonian theory of party government that "to the victors belong the spoils," and to create confidence in the practical success as well as the moral desirability of a system of appointments to office which rests upon efficiency and merit only. Mr Roosevelt not only attacked dishonesty in public affairs but in private business as well, asserting that "malefactors of great wealth" endeavour to

control legislation so as to increase the profits of monopolies or "trusts," and that to prevent such control it is necessary to extend the powers of the federal government. In carrying out this policy of government regulation and supervision of corporations he became involved in a great struggle with the powerful financial interests whose profits were threatened, and with those legislators who sincerely believed that government should solely concern itself with protecting life and property, and should leave questions of individual and social relations in trade and finance to be settled by the operation of so-called natural economic laws. In the struggle, although he was bitterly accused of violating the written constitution, of arresting and destroying business prosperity and of attempting a radical departure from the accepted social system of the country, he was remarkably successful. By his speeches and messages, and by his frank use of one of the greatest of modern social engines—the newspaper press—he created a public opinion which heartily supported him. Under his effective influence laws were framed which were not merely in themselves measures of stringent regulation of business and the accumulation of wealth, but which established precedents, that as time goes on will inevitably make the doctrine of federal control permanent and of wider application. The struggle against some of the most powerful financial and political influences of the time not unnaturally gave rise to the idea that his work as president was destructive—perhaps the necessarily destructive work of the reformer—but not essentially constructive. Even those friendly to him sometimes felt it necessary to defend his political course by saying that he was compelled to raze the old buildings and prepare the ground on which his successors might build new and better structures. A brief consideration of some of the constructive achievements of his administration will show that the "destructive" theory of his political activities is not sustained by the facts.

Civil Service Reform.—Some reference has already been made to the fact that in every office which Mr Roosevelt held he constantly dwelt upon the truism, often forgotten or ignored, that no government can accomplish any permanent good unless its administrative and legislative officers are chosen and maintained for merit only. As assemblyman, as police commissioner, as naval secretary and as president, he advocated this fundamental doctrine. When Federal Civil Service commissioner he did more than any other single public man in the United States has had either the ability or the opportunity to do, to promote the doctrine of service for merit only out of the realm of theory into the realm of governmental practice. While he was criticized by the friends of Civil Service Reform for not going far enough during his presidency to protect the encroachments of those who desire to have the offices distributed as political rewards or for partisan ends, such specific acts as his transference to the classified service of all fourth-class postmasters east of the Mississippi and north of the Ohio rivers, his insistence upon a thorough investigation of the scandals in the Post Office department, and his order forbidding federal employees to use their offices for political purposes in the campaign of 1908 are typical of his vigorous support of the merit system.

Conservation of National Resources.—If Mr Roosevelt did not invent this term he literally created as well as led the movement which made Conservation in 1910 the foremost political and social question in the United States. The old theory was that the general prosperity of the country depends upon the development of its natural resources—a development which can best be achieved by private capital, acting under the natural incentive of financial profits. Upon this theory public land was either given away or sold for a trifle by the nation to individual holders. While it is true that the building of railways, the opening of mines, the growth of the lumber industry and the settlement of frontier lands by hardy pioneers was rapidly promoted by this policy, it also resulted naturally in the accumulation of great wealth in the hands of a comparatively few men who were controlling lumber, coal, oil and railway transportation in a way that was believed to be a menace to the public welfare. Nor was the concentration of wealth the only danger of this policy; it led to the destruction of forests, the exhaustion of farming soils and the wasteful mining of coal and minerals, since the desire for quick profits, even when they entail risk to permanency of capital, is always a powerful human motive. Mr Roosevelt not only framed legislation to regulate this concentration of wealth and to preserve forests, water power, mines and arable soil, but organized departments in his administration for carrying his legislation into effect (see IRRIGATION: *United States*). His official acts and the influence of his speeches and

messages led to the adoption by both citizens and government of a new theory regarding natural resources. It is that the government acting for the people, who are the real owners of all public property, shall permanently retain the fee in public lands, leaving their products to be developed by private capital under leases which are limited in their duration and which give the government complete power to regulate the industrial operations of the lessees.

Government Regulation of Corporations.—The growth of the corporation as an industrial machine, had in recent years been very rapid in the United States. The industrial and financial corporations had grown so powerful as to venture to contend for the first place with the authority of the government itself. As Mr Roosevelt often pointed out, no nation will live long in which the authority of government—especially in a democracy—is supplanted by the private interest of a real money power. Early in his political career, Mr Roosevelt foresaw this conflict, and as president he aroused public opinion so that the people understood it, and threw his effective influence into the framing of legislation under which the Federal government is now successfully combating the illegal acts of the powerful trusts. He established the Federal Department of Commerce and Labor, the secretary of which has a seat in the cabinet, and in which there exists a bureau of corporate control, the specific function of inspecting and supervising interstate corporations—an entirely new feature in American government. He strengthened the interstate commission for the regulation of railroads, inaugurated successful suits against monopolies—notably the Standard Oil Company and the so-called Sugar Trust,—and achieved distinct practical results in favour of a system of "industrial democracy" where all men shall have equal rights under the law and where there shall be no privileged interests exempt from the operation of the law. Both his friends and his enemies agree that he did more than any other public man to effect these changes of government and industry. There is, however, a violent disagreement regarding the desirability and the results of his course. His critics assert that he simply interrupted the orderly course of business, inspired panic and dangerously arrested prosperity. Mr Roosevelt and his supporters were convinced that his policy was necessary to save the country from the social and political dangers of plutocracy, and that in establishing a definite system of government regulation not only were popular rights preserved and justice promoted but industrialism and finance were placed upon a basis of regularity and honesty that paved the way for an era of general prosperity in the United States, unbroken by the fluctuations of industrial schemes, such as the country had so far in its history, been unable to effect.

The Army and Navy.—Mr Roosevelt was a pronounced advocate of international peace but also an advocate of law and order. He believed that international controversies would ultimately be settled by judicial procedure, and in the Russo-Japanese War and the establishment of the Hague Court he took an active part in promoting the judicial settlement of disputes between nations. For his efforts leading to the settlement of the Russo-Japanese War he received the Nobel Peace Prize, and in May 1910 he delivered an address on "International Peace" before the Nobel committee in Christiania. But, with this advocacy of international peace, he also advocated the maintenance by the United States of an efficient and thoroughly equipped army and navy. To some of his critics these two positions seem inconsistent. Mr Roosevelt argued not only that they were consistent but that the one logically followed the other. In his Nobel address he said: "In any community of any size the authority of the courts rests upon actual potential force; on the existence of a police or on the knowledge that the able-bodied men of the country are both ready and willing to see that the decrees of judicial and legislative bodies are put into effect;" and he expressed the opinion that until a recognized international supreme court was firmly established, every nation must be prepared to defend itself, and when it was established all the nations must be prepared to maintain its decrees against any recalcitrant nation. On this ground during his presidential administration Mr Roosevelt was deeply concerned in many measures for improving the administrative side of the War Department and educating, training and strengthening the army. Although he himself served in the army during the Spanish War his special interest was in the navy, springing probably from his relationship with the navy during his brief term as assistant secretary. The successful and dramatic voyage of the American fleet around the world, undertaken in spite of predictions of disaster made by naval experts in Europe and the United States, was conceived and inspired by him, and this single feat would alone justify the statement that no American public man had done so much since the Civil War as he to strengthen the physical power and the moral character of the United States navy.

The Panama Canal.—The greatest single material achievement of Mr Roosevelt's presidency was the taking over by the United States of the project to build a Panama Canal. The project itself is nearly four centuries old; for a century Great Britain and the United States had been sometimes in friendly, sometimes in acrimonious dispute as to how this was to be accomplished; the French undertook the work and failed. Mr Roosevelt recognized the new republic of Panama, and obtained from it for

the United States, in return for a commercial and military protection advantageous to Panama, the right to build a canal and control it in perpetuity. His critics said that his course in this matter was unconstitutional, although the question of constitutionality has never been raised before any national or international tribunal. The fact remains that the construction of the Panama Canal was undertaken to the practical satisfaction of the civilized world. But for Mr Roosevelt's vigorous official action and his characteristic ability to inspire associates with enthusiasm the canal would still be a subject of diplomatic discussion instead of a physical actuality.

Colonial Policy.—Strictly speaking, the United States has no colonial policy, for the Philippine Islands and Porto Rico can scarcely be called colonies. It has, however, a policy of territorial expansion. Although this policy was entered upon at the conclusion of the Spanish War under the presidency of Mr McKinley, it has been very largely shaped by Mr Roosevelt. He determined that Cuba should not be taken over by the United States, as all Europe expected it would be, and an influential section of his own party hoped it would be, but should be given every opportunity to govern itself as an independent republic; by assuming supervision of the finances of San Domingo, he put an end to controversies in that unstable republic, which threatened to disturb the peace of Europe; and he personally inspired the body of administrative officials in the Philippines, in Porto Rico and (during American occupancy) in Cuba, who with efficiency and unselfish devotion to duty compare favourably with any similar body in the world. In numerous speeches and addresses he expressed his belief in a strong colonial government, but a government administered for the benefit of the people under its control and not for the profit of the people at home. In this respect, for the seven years of his administration at Washington, he developed a policy of statesmanship quite new in the history of the United States.

No account of Mr Roosevelt's career is complete without a reference to his literary work, which has been somewhat overshadowed by his reputation as a man of public affairs. He was all his life an omnivorous reader of the best books in very varied fields of literature, and he developed to an unusual degree the faculty of digesting and remembering what he has read. His history of the War of 1812 between the United States and Great Britain, written when he was twenty-four years old, is still the standard history of that conflict, and his *Winning of the West* is probably the best work which has been written on American frontier life of the 19th century, a life that developed certain fundamental and distinctive American social and political traits. His *African Game Trails*, the record of his scientific hunting expedition in Africa in 1909-10, is much more than a narrative of adventures on a wild continent. It is a study of social and ethnological conditions, and contains many passages of literary charm, describing bird life, animal life and natural scenery. An appendix that gives some account of the "Pigskin Library" which he carried with him for daily reading in the heart of Africa is a surprising exposition of the wide range of his reading. As a public speaker his style was incisive, forceful and often eloquent, although he made no effort to practise oratory as an art. The volume of his African and European addresses, published in the autumn of 1910, not only presents an epitome of his political philosophy, but discloses the wide range of his interest in life and the methods by which he had striven to bring public opinion to his point of view.

Personally of great physical and mental vigour, his work was done at high pressure and he had the faculty of inspiring his colleagues or his subordinates with his own enthusiasm for doing things. The volume of his letters and his writings in books, articles for the press and speeches and official messages, is enormous, and yet this work was done in the midst of the executive labours of a long political career. Besides being famous as a hunter of big game, he was a skillful horseman and a good tennis player. Regular physical exercise in the open air contributed much to his abounding vitality. A man of decisive action when his mind was made up on any given question, his very decisiveness sometimes gave the impression that his judgments were hasty. On the contrary, few men were more deliberate in considering all sides of an important problem. His long experience, his wide reading and his thorough knowledge of all sorts and conditions of men, enabled him to act quickly at a time of crisis, but his important speeches,

or a course of political action that might be far-reaching in its effect, were not cast into their final form without careful consultation with the best advisers he could obtain. The first form of his written speeches was always painstakingly edited and revised, and not infrequently entirely rewritten. He expressed his own judgment of his success as a public man by saying that it was not due to any special gifts or genius, but to the fact that by patience and laborious persistence he had developed ordinary qualities to a more than ordinary degree. (L. F. A.)

The following is a list of his principal works:—*The Naval Operations of the War between Great Britain and the United States—1812-1815* (1882), written to correct the history of James: *Thomas Hart Benton* (1887) and *Gouverneur Morris* (1888), both in the American Statesmen Series; *New York City* (1891; revised 1895) in the Historic Towns Series; *Hero Tales, from American History* (1895) with H. C. Lodge; *Winning of the West* (4 vols., 1889-96); a part of the sixth volume of the *History of the Royal Navy of England* (1898) by W. L. Clowes; *The Rough Riders* (1899); *Oliver Cromwell* (1901); the following works on hunting and natural history, *Hunting Trips of a Ranchman* (1886), *Ranch Life and Hunting Trails* (1888), *The Wilderness Hunter* (1893), *Big Game Hunting in the Rockies and on the Plains* (1899; a republication of *Hunting Trips of a Ranchman and The Wilderness Hunter*), *The Deer Family* (1902), with other authors, and *African Game Trails* (1910); and the essays, *American Ideals* (2 vols., 1897) and *The strenuous Life* (1900); and *State Papers and Addresses* (1905) and *African and European Addresses* (1910). Several of his works have been translated into French and German. Uniform editions were published in 1900 and 1903. Early in 1909 he became a "contributing editor" of the *Outlook*.

The biographical sketches by Jacob A. Riis (New York, 1904), F. E. Leupp (ibid., 1904), G. W. Douglas (ibid., 1907), James Morgan (ibid., 1907), and Murat Halstead (Akron, 1902) are personal or political eulogies. John Burroughs's *Camping and Tramping with Roosevelt* (Boston, 1907) is an appreciation of Roosevelt as a naturalist. J. W. Bennett, *Roosevelt and the Republic* (New York, 1908), is bitterly hostile. There is a sketch by F. V. Greene in *Roosevelt's American Ideals*.

ROOT, ELIHU (1845-), American lawyer and political leader, was born at Clinton, New York, on the 15th of February 1845, the son of Oren Root (d. 1885), professor of mathematics at Hamilton College from 1849-81. He graduated at Hamilton College in 1864, taught at the Rome (N.Y.) Academy in 1865, and graduated at the University Law School, New York City, in 1867. As a corporation lawyer he soon attained high rank and was counsel in many famous cases. Politically, he became identified with the reform element of the Republican party. He was United States attorney for the Southern District of New York (1883-85), and a delegate to the State Constitutional Convention of 1894, acting as chairman of its judiciary committee. From August 1899 until February 1904 he was secretary of war in the cabinets of Presidents McKinley and Roosevelt, and in this position reorganized the army and created a general staff, and in general administered his department with great ability during a period marked by the Boxer uprising in China, whither troops were sent under General A. R. Chaffee, the insurrection of the Filipinos, the withdrawal of the United States troops from Cuba, and the establishment of a government for the Philippines under a Philippine Commission, for which he drew up the "instructions," in reality comprising a constitution, a judicial code and a system of laws. In 1903 he was a member of the Alaskan Boundary Tribunal. In July 1905 he re-entered President Roosevelt's cabinet as secretary of state. In the summer of 1906, during a visit to the Pan-American Conference at Rio de Janeiro, he was elected its honorary president, and during a tour through the Latin-American republics, brought about a better understanding between the United States and these republics. In general he did much to further the cause of international peace, and he concluded treaties of arbitration with Japan, Great Britain, France, Italy, Spain, Portugal, Austria-Hungary, Switzerland, Norway, Sweden, Denmark, Holland and other countries. Upon his resignation from the cabinet he was elected, in January 1909, as United States senator from New York. In 1910 he was chief counsel for the United States before the Hague tribunal for the arbitration of the long-standing dispute concerning fisheries between his country and Great Britain (see NEWFOUNDLAND). He received the degree of LL.D. from

Hamilton, 1896; Yale, 1900; Columbia, 1904; New York University, 1904; Williams, 1905; Princeton, 1906; University of Buenos Aires, 1906; University of San Marcos, of Lima, 1906; and Harvard, 1907.

ROOT (late O.E. *rot*, adopted from Scand., cf. Norw. and Swed. *rot*, Dan. *rod*; the true O.E. word was *wyr*t, plant, represented in Ger. *Wurz* or *Wurzel*; the ultimate root is the same in both words, and is seen in Lat. *radix*), the underground part of a plant. This is the popular meaning of the word. In its botanical use the term is more restricted (see below). The various other meanings have all developed from this, its primary, significance. Of these the principal are: the source or origin of a condition, state, quality, &c.; the base or embedded part of a structure of the body, such as a nail, tooth, the hair, &c.; in mathematics, a number, quantity or dimension which produces a given expression when multiplied by itself a requisite number of times; and in philology an ultimate element of language, incapable of further analysis. A particular extension of the primary meaning is that which applies the word generally to a class of plants, such as the turnip or carrot, whose root is fleshy, and edible either by man or domestic animals.

The embryo of a typical plant, for instance a pea plant (fig. 1), has an ascending axis which will grow into the shoot, and a descending axis or radicle which will grow into the root.



FIG. 1.—The Dicotyledonous Embryo of the Pea laid open. *c*, *c*, the two fleshy cotyledons, or seed-lobes, which remain under ground when the plant sprouts; *r*, the radicular extremity of the axis which develops into the root; *l*, the axis bearing the young stalk and leaves *g*, which lie in a depression of the cotyledons *f*.

protects it in its passage through the soil. The root also generally bears root-hairs, slender unicellular outgrowths of

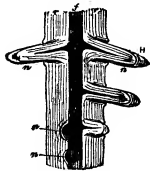

From Vines's *Student's Botany*, by permission.

FIG. 2.—Lateral Roots *r* arising endogenously from the pericycle of the Tap-Root of *Vicia faba* (longitudinal section. *f*, axial cylinder (stele); *r*, cortex of main root; *h*, root-cap of lateral root.

tissue of the parent root (fig. 2). True forking of the root (dichotomy) occurs in the Lycopodiaceae (the shoots of which also branch dichotomously), but is unknown in the higher plants.

Roots which originate elsewhere than as acropetal outgrowths of a main root are known as *adventitious*, and may



From Green's *Vegetable Physiology*, by permission.

FIG. 3 *a* and *b*.

Root-hair in contact with particles of soil (highly magnified). Ultimate root-branches, showing position of root-hairs.

arise on any part of a plant. They are especially numerous on underground stems, such as the under side of rhizomes, and also develop from stem nodes under favourable conditions, such as moisture and absence of light; a young shoot or a cutting placed in moist soil quickly forms adventitious roots. They may also arise from leaves under similar conditions, as, for instance, from begonia leaves when planted in soil.

The forms of roots depend on their shape and mode of branching. When the central axis goes deep into the ground in a tapering manner, without dividing, a *tap-root* is produced. This kind of root is sometimes shortened, and becomes swollen by storage of food-stuffs, forming the *conical* root of carrot, or the *fusiform* or spindle-shaped root of radish, or the *napiiform* root of turnip. In ordinary forest trees the first root protruded continues to elongate and forms a long primary root-axis, whence secondary axes come off. In primary plants, especially Monocotyledons, the primary axis soon dies and the secondary axes take its place. When the descending axis is very short, and at once divides into thin, nearly equal fibrils, the root is called *fibrifous*, as in many grasses (fig. 4); when the fibrils are thick and succulent, the root is *fasciculated*, as in *Ranunculus Ficaria*, *Asphodelus luteus*, and *Oenanthe crocata*; when some of the fibrils are developed in the form of tubercles, the root is *tubercular*, as in dahlia (fig. 5); when the fibrils enlarge in certain



FIG. 4.—Fibrifous Root of a Grass. Numerous fibrils coming off from one point.

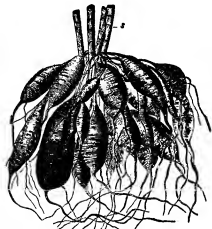

From Strasburger's *Lehrbuch der Botanik*, by permission of Gustav Fischer.

FIG. 5.—Root-Tubers of *Dahlia variabilis*. The smaller portions of the cut stems.

parts only, the root is *nodulose*, as in *Spiraea Filipendula*, or *moniliform*, as in *Pelargonium triste*, or *annulated*, as in *Ipecacuanha*. Some of these so-called roots are formed of a stem and root combined, as in *Orchis* (fig. 6), where the tuber consists of a fleshy swollen

root bearing at the apex a stem bud. As in the case of the stem, growth in length occurs only for a short distance behind the apex, but in long-lived roots increase in diameter occurs continually in a similar manner to growth in thickness in the stem.



FIG. 6.—Base of plant of *Orchis*, showing tubercles or tuberous roots.

tents and are now filled with air. This layer is called the *telenen*, and serves to condense the moisture contained in the air, on which



FIG. 7.—*Ficus indica*, the Banyan tree, sending out numerous aerial roots, which reach the soil, and prop the branches.

the plant is dependent for its water supply. The aerial roots of the ivy are not the nutritive roots of the plant, but are only intended for mechanical support. The climbing roots of many orchids, aroids and epiphytic ferns branch and form places of lodgment for humus into which absorbent branches of the climbing roots penetrate. Some leafless epiphytic orchids, such as species of *Angraecum*, depend entirely upon their aerial roots for nourishment; the roots, which are green, perform the functions both of leaves and roots. A respiratory or aerating function is performed by roots of certain mangroves growing in swampy soil or water and sending vertical roots up into the air which are provided with aërating passages by which the root system below can communicate with true outside air.

Parasitic plants, as the mistletoe (*Viscum*), broom-rape (*Orobancha*) and *Rafflesia*, send root-like processes into the substance of the plants whence they derive nourishment. In the dodder (*Cuscuta*), the tissue around the root swells into a kind of sucker (haustorium), which is applied flat upon the other plant, and ultimately becomes concave, so as to attach the plant by a vacuum. From the bottom of the sucker the root protrudes, and penetrates the tissue of the host plant. Leaf-buds are sometimes formed on roots, as in plum, cherry and other fruit trees; the common elm affords an excellent example, the young shoots which grow up in the neighbourhood of a tree arising from the roots beneath the soil. In some plants no roots are formed at all; thus in the orchid *Coralorhiza*, known as coral-root, a stem-structure, the shortly branched underground rhizome, performs all the functions of a true root which is absent. In aquatic plants the root acts merely as a holdfast or is altogether absent as in *Salvinia*, *Utricularia* and others.

ROPE AND ROPE-MAKING. All varieties of cordage having a circumference of an inch or more are known by the general name of "rope." Twisted cordages of smaller dimensions are called cords, twines and lines, and when the sectional area is still smaller, the article is known as thread or doubled yarn. All these varieties of cordage are composed of a number of separate yarns, each of which is made from some kind of textile fibre by preparing and spinning machinery. The number of separate yarns which ultimately form the rope or cord depends upon the fineness of the yarn, and also upon the circumference of the finished article. From thread and fine twine upwards the whole art of manufacture is that of twisting together fibres and yarns; but the comparative heaviness and coarseness of the materials operated on in rope-making render necessary the adoption of heavy machinery and modified processes which clearly define this manufacture as a distinct calling. The modern trade of rope-making is again divided into two distinct branches dealing with vegetable fibres and metallic wire.

Many different vegetable fibres are used for rope-making, but for the combined qualities of strength, flexibility and durability, none can compete with the common hemp, which is consequently the staple of the rope-maker. Cotton ropes are, however, much more flexible, and in addition are strong and durable; they are, therefore, much preferred for power transmission in textile and other works. Manila hemp is a fibre of remarkable tenacity, of unapproached value for heavy cordage, but too stiff for small cords and twines. After these in utility come Sisal hemp of Central America (*Agave Sisalana*), Phormium hemp of New Zealand (*Phormium tenax*) and Sunn hemp of the East Indies (*Crotalaria juncea*)—all fibres of great strength, and largely used by rope-makers. Jute (*g.*) of India (*Corchorus capsularis* and *C. olitorus*) is now largely used by rope-makers on account of its cheapness. When used alone it is deficient in strength and durability, but when used in conjunction with proper proportions of hemp it makes a very satisfactory and useful rope. Among fibres more rarely seen in rope-works are Jubbuluor hemp (*Crotalaria tenuifolia*), boxstring hemp (*Sansevieria zeylanica*), and other hemsps of the East Indies, plantain fibre (*Musa paradisiaca*), and agave fibre (*Agave americana*) of America. Coir and many other fibres are used, but principally in the localities of their production.

A rope is composed of a certain number of "strands," the strand itself being made up of a number of single threads or yarns. Three strands laid or twisted together form a "hawser-laid" rope, and three such hawsers similarly laid make a "cable-laid" rope or "cable." A "shroud-laid" rope usually consists of four strands laid around a central strand or core. The prepared fibre is twisted or spun to the right hand to form yarn; the required number of yarns receive a left-hand twist to make a strand; three strands twisted to the right make a hawser; and three hawsers twisted to the left form a cable. Thus the twist in each operation is in a different direction from that of the preceding one, and this alternation of direction serves, to some extent, to preserve the parallelism of the fibres.

The primary object of twisting fibres together in a rope is that by mutual friction they may be held together when a strain is applied to the whole. Hard twisting has the further advantage of compacting the fibres and preventing, to some extent, the penetration of moisture when the ropes are exposed to water; but the yield of rope from a given length of yarn diminishes in proportion to the increase of twist. The proper degree of twist given to ropes is generally such that the rope is from three-fourths to two-thirds the length of yarn composing it.

Rope-walk Spinning.—The sequence of operations in this method of working is as follows: (1) hackling the fibre; (2) spinning the yarn; (3) tarring the yarn when necessary; (4) forming the strands; (5) laying the strands into ropes.

Hackling differs but slightly from the hand-hackling process used in the preparation of flax. The hackle board consists of a wooden block studded with strong, tapered and sharp-pointed steel prongs. A series of such hackle boards is used in the progressive hackling operation, the prongs diminishing

in size and being more closely set together. For the commoner kinds of ropes, however, hackling through the coarsest board is found to be sufficient, while in most other cases two hacklings are adopted.

The hackler takes up a handful of "streak"¹ of hemp from the bundle, wraps one end firmly round his hand, and with his fingers distributes a little oil over the hemp. The oil softens the material, keeps the hackle pins in good condition, and facilitates generally the splitting up of the fibre as the streak is drawn through the pins. In the first place, only the ends of the streak are hackled; they are dashed into the pins and drawn through them in order to separate the fibres and to lay them parallel; but as the operation proceeds a gradually increasing length of the streak is thrown on and drawn through the pins. The process is indeed very similar to the combing out of a head of human hair. When half the length of the streak is thoroughly combed, the other half is treated in precisely the same manner. The hackled streak is then weighed, doubled up to prevent any entanglement, and laid aside for the process of spinning. During the hackling process a large quantity of comparatively short fibres are retained in the pins; the longest of these are separated, and the remainder used for tow yarns. The above description refers entirely to hand hackling; machine hackling of hemp is very similar to flax hackling.

The spinning is done in what is termed the "rope-walk," and from the nature of hand-spinning, and the length of the rope required, it is necessary that this walk should be from 300 to 400 yds. in length. It is sometimes completely covered in with walls and roof; at other times only a roof is built; while in exceptional cases the whole of the walk, with the exception of a small hut at each end, is without shelter of any kind. The operation of spinning is very important, as the weight of the yarn and the appearance of the finished product depend upon it. A description of spinning and laying as performed by the aid of the hand-wheel will perhaps be the best means of giving an idea of this useful branch of manufacture.

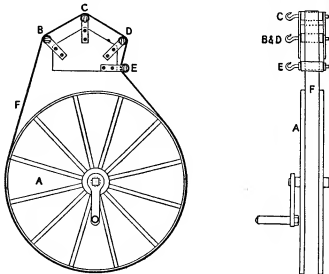

Fig. 1.

The front and end elevations of one variety of spinning-wheel are shown in figs. 1 and 2. The apparatus is fixed to some convenient part of the building, or to special supports. The wheel A, which is turned by hand, and always in the same direction, communicates motion to the rotating hooks or "whirls" B, C, D and E by means of a listing band or strap F. The arrangement of the listing shows clearly that the hook E will revolve in the opposite direction to hooks B, C, and D. The spinner takes two streaks of the hackled hemp, wraps them round his waist with the ends at his back, and keeps the fibre in position by adjusting his apron partly round it. From the middle of the streak—that is, midway between the two ends—he takes hold of a quantity of fibre and hangs it on to one of the

hooks B, C or D; the assistant at the wheel begins to turn, and thus a certain amount of twist is imparted to the material between the spinner and the hook. The spinner now walks backwards down the walk, drawing out the fibre with his left hand and adjusting it with his right. A piece of flannel or woollen cloth held in his right hand aids in the formation of the thread and protects his fingers from the rough fibre. In some cases two threads are spun simultaneously; when this is done, two of the hooks, say B and C, are used at the same time. Since the revolutions of the hook divided by the length of yarn spun give the amount of twist per inch, or foot, it follows that the ratio of the walking pace of the spinner to the revolutions of the wheel A should be constant, otherwise the yarn will not be uniform. The spinner calls to the assistant when there is any irregularity in speed, or when, from any cause, he is obliged to stop walking.

At convenient intervals in the length of the walk, and projecting from posts, are short horizontal bars; the top of each bar is provided with wires or pegs to form a number of vertical partitions something like a very coarse comb. As the spinner proceeds down the walk, he throws the spun yarn into one of these partitions, thus relieving himself of the weight and keeping the yarn off the ground. When a sufficient length of yarn has been spun, he breaks off the fibres and fastens the yarn to a convenient peg or hook until he has spun a sufficient number (usually three) to form a small rope or cord. The person at the wheel hangs these three yarns one on each of the three hooks B, C and D, while the spinner attaches the other ends to a revolving hook termed a "looper." All is now ready for "laying" the yarns. For small cords, this may be done, with or without a "top." This top is a conical-shaped piece of hard wood provided with three equidistant grooves which merge towards each other at the thin end, and into which the yarns are laid. The thick end of the top is provided with a wheel, so that the yarns may be kept separate on that side. As the hooker twists the three threads, the spinner goes up the walk with the top; the twist in the yarns causes the looping hook to revolve in the opposite direction to the other hooks, and thus it twists the three threads in the opposite direction to the original twist.



Fig. 3.

Fig. 3 shows one form of top, the three yarns being shown in distinctive marks so that the path of each may be more easily followed by the reader; a plan of the thick end of the top appears to the left of the figure. If four yarns of strands are required, the top would contain four grooves, as well as a hole through the centre to admit of a core when such a thing is required. As soon as the spinner, who carries the top, arrives at the wheel, the assistant takes the yarns off hooks B, C and D (figs. 1 and 2), and puts them all on hook E. The other ends of the strands are removed from the looper and attached to a block of wood called a "drag." The wheel is then rotated as before, which puts more twist into the cord. In any case, which is termed hardening, proceeds, a shrinkage in the length of the cord takes place, and the drag is consequently drawn up the walk. The drag, however, holds the cord taut, and serves to retain the twist which is imparted by the hook E.

If the strands require tarring before they are laid, they are separately taken off the hooks, after they have been spun, and tied at both ends to pegs to keep them taut until a sufficient number has collected to be conveniently handled at the tarring tank. The tar is heated to about 220° F., and the strands are then passed through it at a speed not greater than 15 ft. per minute. Before emerging from the tank, the strands pass between squeezing rollers which remove all superfluous tar. In a short time the strands are dry, while in the space of a few days the tar is hard enough to allow the strands to be formed into ropes.

Such is, in general, the hand process of forming ropes when they are composed of only three or four single yarns. It very often happens, however, that a number of single yarns are required to form each strand of the rope. The single yarns may be spun by hand, as described above, or by machinery. In the former case a group of yarns is usually termed a "haul," while the machine-spun yarns are formed into what is known as a "warp" or "chain." In any case, the group of yarns is stretched down the rope-walk, at each end of which is a "jack" twister. A few of the yarns taken from the group—the number depending upon the size of the yarn and also upon the required diameter of the strand—are then placed on a hook of the jack twister and twisted together. When three such strands are made they are laid into a rope in a similar manner to that explained above. A simple form of hand jack twister is illustrated in figs. 4 and 5. The wheel A gears with pinions B on the shafts of the hooks or whirls, and this imparts the necessary motion to the latter. At the other end of the walk is a similar machine which moves upon rails as the twist is put into the strands. When the hooks are empty, pinions B and wheel A (fig. 4) are out of gear, but those hooks carrying yarn are drawn out, as shown at C, until the pinion B gears with wheel A, when the hooks are rotated. The

¹ See note in the article on JUTE for variations of spelling.

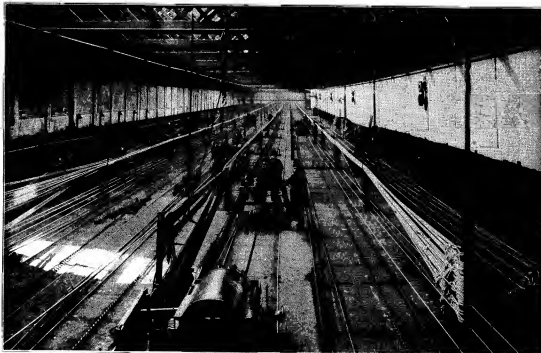

FIG. 9.—ROPE-MAKING, POTTINGER MILL.



FIG. 10.—MANILA ROPE YARN PREPARING, POTTINGER MILL, OF THE BELFAST ROPEWORK CO. LTD.

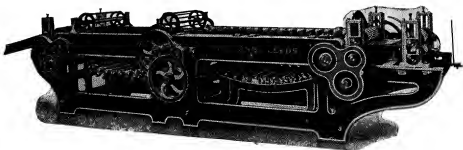

FIG. 11.—GOOD'S HACKLING AND SPREADING MACHINE.

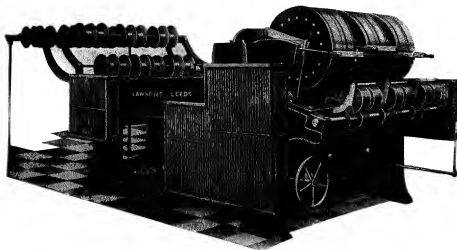

FIG. 12.—HEAVY SPIRAL OR SCREW-GILL DRAWING FRAME; ONE HEAD, SIX GILLS.

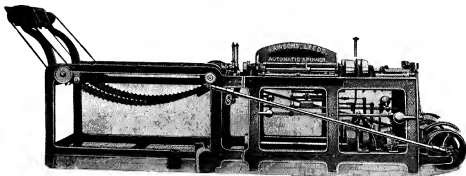
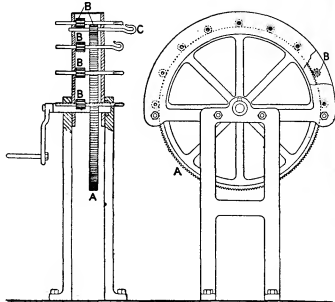

FIG. 13.—SPINNER OR JENNY.

sequence of operations is very similar to that described for the simple hand-wheel.



FIGS. 4 and 5.

Machine or Factory Rope-Making.—The most modern methods of rope-making are far superior to the foregoing, which, as stated, have been introduced to show the principle. One of the greatest drawbacks in the formation of a strand from a haul or chain, even for a small number of yarns, is the irregularity of the tension of the yarns at different parts of the strand. If a large number of yarns be required for each strand, it would be almost impossible to make a satisfactory rope by the above system. If, however, the strand be made from bobbins, each yarn bears its proper share of the tension, and an almost perfect rope is obtained.

Two mechanical methods are in use for the spinning of long vegetable fibres—the ordinary and the special. When flax or jute yarns are required, they are almost invariably spun on the ordinary spinning frames, and the yarn rewound from the spinning bobbins on warping bobbins, or else rewound in the shape of rolls or cheeses. Hemp yarns, especially the finer kinds, are sometimes treated in the same manner, but Manila hemp, New Zealand hemp (*Phormium*), and similar fibres, are invariably spun on bobbins by special machinery. The strands for light ropes may then be made on the twisting frames, and the rope finished on what is called a "house machine." When a large rope is desired, a slightly different method is usually employed. The bobbins from the automatic spinner, or the rolls from the winding frame, are placed upon pegs in a frame which answers the same purpose as a bank or creel used in conjunction with a warping machine. If the rope is to be say $3\frac{1}{2}$ in. in circumference, there may be, with fine yarns, 300 or more individual threads in its composition. Suppose that 300 threads are to be used, then 300 bobbins would be placed on the pegs of the bobbin bank or creel, and divided into three sets of 100 threads each for a three-strand rope. The threads are passed separately through a register plate, which is simply a plate containing a sufficient number of holes for the maximum quantity required, and arranged in a series of concentric circles. There are three sets of concentric rings used in the plate for a three-strand rope, and four sets for one of four strands. As the threads emerge from the register plate they are grouped together and passed through a tapered tube, the sectional area of the smaller end of the tube being equal to the sectional area of the strand. This operation is done for each group of 100 threads, and finally the three or four groups are attached to separate rotating hooks of the forming machine or "traveller." As the latter moves down the walk on rails, it draws the threads from the bobbins in the bank, and through

the register plate and tubes, while the hooks put in the twist. A perfectly circular strand, without slack threads, is thus formed; and, at the same time, a uniform strand is obtained, since the ratio of the speed of the traveller to the number of turns per inch of the hooks is constant. The process is continued until the desired length of strand is made—about 150 fathoms (300 yds.) of each of the three strands are required for 100 to 120 fathoms of rope—then a little more twist is introduced. Afterwards, all three strands are placed on one hook of the traveller, and the ends from the shaping tubes are cut off and put on the hooks of the fixed machine, called the "fore-turn." The carriage containing the "top" is now brought close to the traveller, and the strands are placed in the grooves of the top as explained under hand-laying. Similar means to those used in hand-spinning are adopted for keeping the rope off the ground. The two machines are now started, the three hooks of the fore-turn machine revolving in one direction and the single hook of the traveller revolving in the opposite direction. Simultaneously the carriage with the laying top moves forward towards the head of the walk.

Fig. 9, Plate I., shows many stages in the process of rope-making. The most prominent part shows the carriage with the top in position approaching the fore-turn machine at the head of the walk. The person on the right of the carriage is holding a top in his left hand, while the top in the carriage is laying a rope of four strands. At other parts of the figure appear three or four travellers, some twisting the strands, others moving up the walk as the laying proceeds, while on the extreme right one machine is laying two ropes, of three strands each, at the same time.

We have already stated that the yarns for the above machine may be prepared by two systems. When the hemp fibre is spun on the ordinary frame, the method of preparation for such a frame is somewhat similar to that employed for flax, but since the fibre is harsher than flax, it invariably requires softening. The softening machines crush the streaks as if the case of jute, but the fluted rollers are arranged to form a circle. The coarser fibres receive a somewhat different treatment; the first process in the preparation of Manila hemp and similar fibres used for rope yarn is illustrated in fig. 10, Plate I. The streaks are clearly shown as being led between fluted rollers on to the pins of the hackling and spreading machine; the lanterns or skeleton rollers, seen on the extreme right, press the fibres into the pins. A little oil is made to drop on to the fibre in order to soften it and to facilitate the operation. The oiling apparatus is usually of a simple character, and consists of a revolving roller partly immersed in an oil bath. The roller is driven as shown in the figure, and the oil which it draws up is scraped off its surface by a knife-edge, and led, by means of a sheet, upon the fibre between the fluted rollers and the gill-pins. A view of a similar machine is shown in fig. 11, Plate II., from which it will be seen that there are two sheets of revolving gill-pins. The sheet nearest the feed-cloth revolves slightly quicker than the surface speed of the fluted feed rollers, while the second sheet moves at a much higher rate. The difference in the speeds of the gill-pins results in the fibre being combed out and straightened, while the delivery rollers, the surface speed of which is slightly greater than that of the second sheet of gill-pins, help further to complete the process, and finally deliver the fibre in the form of a broad ribbon, termed a sliver.

In general, three such machines are used for the process; the pins in the gill-slits are graded, those in the second machine being finer and more closely set than those in the first machine, while a still finer and closer arrangement obtains in the third machine. The sliver from the first hackling and spreading machine are now placed at the back of the first drawing frame, one type of which appears in fig. 12, Plate II. Each sliver is passed separately over a guide pulley, led upon the pins, drawn out and joined by others, and finally delivered as a sliver ready for the second drawing frame. A similar process is carried on in this machine, from which the sliver emerges ready for the spinning frame. It will thus be seen that a system of doubling, as well as of drawing, obtains in these processes as in flax-preparing; such a system is adopted in order to obtain uniformity of sliver and the correct weight.

The slivers are taken from the drawing frame to the automatic spinner—a beautiful piece of mechanism. Fig. 13, Plate II., illustrates the machine as it leaves the makers. Two sliver cans from the second drawing frame are placed behind the machine, and the slivers passed between the rollers. They are then deflected and made to enter a trumpet-mouthed conductor which guides them on to the pins of the chain-sheet. As the two slivers emerge from these pins, each enters a separate self-feeding and adjusting apparatus, the function of which is, as its name implies, to regulate the delivery of the sliver to the nippers. The delivery is increased or decreased according as the sliver is thin or thick. Consequently, a very even yarn results; indeed, it is claimed that for uniformity of yarn this system of spinning has no equal. The bobbins, which

are placed in a horizontal position, have a lateral movement, so that the finished yarn may be wound on evenly. This machine is made for ordinary rope yarn, and for binder twine for self-reaping machines. When all three spreading machines are used in conjunction with the spiral drawing frames, the automatic feeding arrangement is sometimes considered unnecessary, because of the uniformity of the slivers when delivered from the finishing drawing frame.

Figs. 14 and 15, Plate III, show two sheds filled with preparing machinery for the manufacture of binder twine. A complete system of Manila machinery, as recommended by Messrs Lawsons, Leeds, would consist of the following:—

- 1 No. 1 spreading and hackling machine.
- 1 " 2 " " "
- 1 " 3 " " "
- 1 spiral 1st drawing frame, 1 head, 88 in. reach, 4 slivers per head.
- 1 " 2nd " " 2 heads, 88 in. " 6 " " "
- 20 improved automatic spinners or jennies of 2 spindles each.

The length of sliver from a given length of fibre is proportional to the drafts and inversely proportional to the doublings. Thus, if

$d_1, d_2, d_3, d_4, d_5, d_6$ = the drafts,
 $s_1, s_2, s_3, s_4, s_5, s_6$ = the number of slivers,
 l = the feet per lb on the feed-table of No. 1 spreading machine,
 L = the feet per lb delivered at the automatic spinner, then:—

$$l \times \frac{d_1}{s_1} \times \frac{d_2}{s_2} \times \frac{d_3}{s_3} \times \frac{d_4}{s_4} \times \frac{d_5}{s_5} \times \frac{d_6}{s_6} = L.$$

No. 1. No. 2. No. 3. No. 1. No. 2. Auto-
 Spreading Drawing matic
 machines. frames. spinner.

A numerical example, showing the drafts, slivers, &c., used for the production of No. 22 rope yarn of 330 ft. per lb appears below:—

$$l \times \frac{15.5}{1} \times \frac{15.5}{12} \times \frac{15.5}{12} \times \frac{7.42}{4} \times \frac{9.7}{4} \times \frac{5.6}{1} = 330 \text{ ft.}$$

Spreading Drawing Automatic
 machines. frames. spinner.

Whence $l = 536$ ft., say 54 ft. per lb; that is to say, 1 lb of Manila fibre, approximately 6 in. in length, spread on the feed-table of No. 1 spreading and hackling machine, and subjected to the above drafts and doublings, would produce yarn No. 22 of 330 ft. per lb from the automatic spinner.

The bobbins from these automatic spinners may be used in the bank at the rope-walk as already indicated, or they may be taken to what is termed a "house machine." These machines are of two distinct kinds—vertical and horizontal. They perform the same work as the machines in the rope-walk, but take up much less space.

Figs. 16 and 17, Plate IV, illustrate two types of horizontal machines, each of which is capable of completing a rope in one operation. The process is pretty clear in fig. 17, which shows that eighteen threads are treated at once. On the right, and driven by spur gearing, are three revolving carriages or creels, each containing six bobbins. Each group revolves as the yarns are drawn off the bobbins, and thus the threads are formed into three strands. As the strands emerge from the guides, they converge towards three other guides, are laid together, and finally the finished rope is wound on to the reel.

In principle the vertical machine is the same as the horizontal machine, and the rope is, consequently, made in one operation. Any number of bobbins, from 24 to 128, may be twisted at the same time; the machine in fig. 18, Plate IV., is for making a rope of three strands, each with 12 threads, or 36 threads in all. These machines are also made to make ropes of four strands. The strands are formed by the rotation of the carriages, from the top of which each strand passes. The three strands then converge to, and pass through, the top of the machine, where they are laid into a rope. The latter passes over a series of guide pulleys, and is ultimately wound on the large drum shown in front of the machine. Such a machine for making a 128-thread, four-strand rope, occupies only about 125 sq. ft.—8 ft. 9 in. \times 14 ft. 4 in.

In addition to the heavy rope there are many varieties of cord and twine made by means of the preparing, spinning and doubling machines. The fishing industry takes many different types for lines and nets, while the variety of cord and twine for other industrial and for household purposes is almost unlimited. All yarn from long vegetable fibre is more or less rough as it leaves the spinning frame, even after two or more threads have been twisted together. It is therefore necessary, for many uses, to impart a polish to the cord or twine. Special machines are used for this purpose. A certain number of bobbins, depending upon the capacity of the machine, are placed in a bank, and the ends are collected and passed under a roller which is immersed in hot starch. The yarns become saturated

with this starch, but, as they emerge from the starch-box, the superfluous starch is removed by passing the yarns between two rollers. The yarns now pass over a series of drying cylinders and polishing rollers, and are finally rewound by the same machine on bobbins. These machines are termed bobbin-to-bobbin polishing machines. In some cases the hot drying cylinders are replaced by a system of hot air drying. The finished yarns are now made up by machinery into hanks, balls or cheeses, according to which happens to be the best state for future use and for transport.

Driving Ropes.—It has already been stated that cotton driving ropes are extensively applied in the transmission of motive power. Although the mechanical efficiency of transmission by ropes is less than that obtained by wheel gearing, rope driving has several compensating advantages:—

1. It is practically noiseless.
2. It occupies less space than belt driving, and the slip is not so great.
3. The turning movement is better; machines therefore run more steadily and production is increased.
4. Shafts may be run at higher speeds.
5. Greater range of drives; anything from 10 ft. to over 80 ft., and much greater distances when carrier pulleys are used.
6. The drive is usually obtained by a number of ropes; if one should break, the rope may be removed and the machinery run, in most cases, until stopping-time.

The number of ropes to be used depends upon the power to be transmitted and upon the surface speed of the driving pulley. The speed of the rope may vary from 2000 ft. to 6000 ft. or over per minute. In some few exceptional cases 60 ropes have been used on one pulley; the number usually varies between 15 and 40. (See also POWER TRANSMISSION, § *Mechanical*.) Fig. 6 shows the

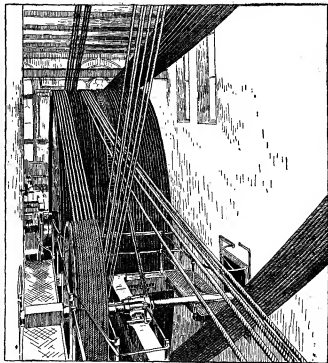

Fig. 6.—Rope Race of a Lancashire Cotton-Spinning Mill, with 38 Lambeth Cotton Driving Ropes, 1½ in. diameter; engine, 1700 H.P.

application of these ropes, which pass direct from the main driving pulley to the different flats of the mill. Fig. 7 shows the construction of the Lambeth four-strand cotton rope. There are two distinct systems of arranging the ropes on the driver and the driven pulleys. In the United Kingdom each rope is independent of all the others, and, as it is unlikely for more than one rope to break at a time, the stoppages are reduced to a minimum. In America, where hemp ropes are largely employed,



Fig. 7.—Lambeth Cotton Rope.



FIG. 14.—BINDER TWINE PREPARING, CONNSWATER MILL, OF THE BELFAST ROPEWORK CO. LTD.

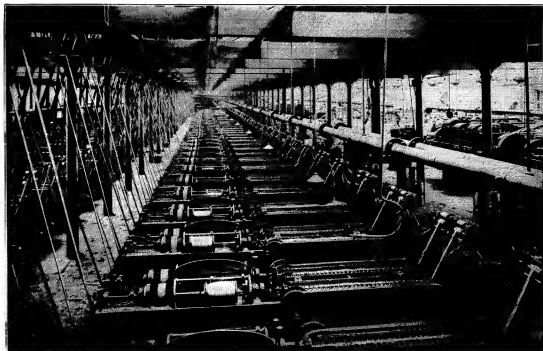

FIG. 15.—BINDER TWINE SPINNING, CONNSWATER MILL.

ROPE AND ROPE-MAKING

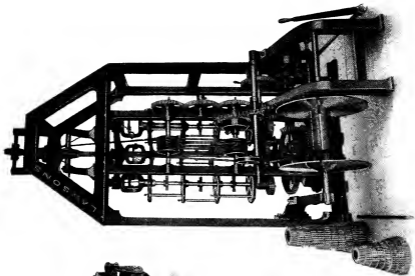

Fig. 18.—HASKELL-DAWES VERTICAL ROPE MACHINE.

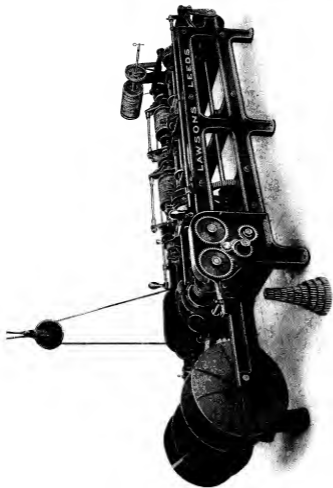

Fig. 16.—HASKELL-DAWES HORIZONTAL ROPE MACHINE.

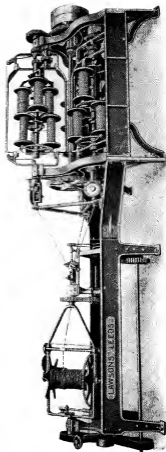

Fig. 17.—EIGHTEEN-THREAD ROPE-MAKING MACHINE.

the continuous system is mostly used; here the rope is wound round and round over driver and driven, and, except in rare cases, is joined only at one place. Although the system has the great advantage of the minimum number of joinings, it requires tension pulleys to keep the ropes taut. It is also clear that when the rope breaks at any point the machinery must stand until the repair is completed.

Wire Ropes.—Although the manufacture of ropes is of ancient origin, the practice of making ropes from wire on a large scale is of comparatively recent date. Since 1874, however, great developments have taken place in the manufacture of ropes from different kinds of wire, and the uses to which they can be put have enormously increased. This is owing almost entirely to the introduction of flexible wire ropes which were invented about this time by Messrs Bullivant & Co. Ltd., of 72 Mark Lane, London, E.C. Prior to that date the uses at which wire ropes were put were limited to winding ropes for collieries and hauling, and to cases in which flexibility was not a great desideratum. The introduction of flexibility, however, made possible the use of wire rope for ships' hawsers and rigging, for cranes, derricks and other purposes for which hempen ropes were formerly employed—indeed it has almost entirely superseded hemp for marine uses. The reason is that it is much stronger for the same size than rope made from any other material, whilst for the same strength its size and weight are only about one-third that of hempen rope. Consequently, the required power may be obtained with a wire rope of comparatively small bulk.

Wire rope is specially suited for aerial ropeways which provide a means of conveying ore, metals, merchandise, &c., over ground where it would be difficult to arrange transport by ordinary means. Messrs Bullivant & Co. Ltd., to whom we are indebted for the table of strengths and other particulars, as well as for the sectional illustration of wire ropes, construct seven different systems of aerial ropeways:—

1. The endless running rope, with carriers hanging therefrom and moving with it through frictional contact.
2. An endless rope, with the carriers hanging therefrom and moving with it, being rigidly fixed in position on the rope.
3. The fixed rope, in which the carriers are drawn along and hang from a fixed rope which acts also as a rail, returning on a parallel rope.
4. The single fixed rope, in which one carrier, hanging from a fixed rope, is drawn to and fro by means of an endless hauling rope.
5. The use of two fixed ropes with an endless hauling rope, in which one carrier travels in one direction, while the other travels on a parallel rope in the opposite direction. This is a serviceable type of ropeway, capable of being used over extremely long spans, and of carrying loads up to 5 tons.
6. The use of one fixed rope placed on an incline, on which the carriers (uncontrolled by hauling ropes) with their suspended loads are allowed to run down at a high speed. This is generally called a "shoot."
7. Bullivant's system of aerial ropeway for raising, lowering, and transporting heavy loads, by means of which a load can be hoisted, traversed in either direction and deposited at one operation.

The flexibility of a wire rope depends upon the number of wires of which it is formed; consequently the use to which a rope is to be put will partly determine the number of wires used in its construction. In some cases nearly 400 individual wires are employed in making one rope. Fig. 8 shows in section ten different types of construction, the particulars of which appear below:—

1. Laid rope made of 6 strands of 7 wires each. This is the class of rope most frequently used for hauling ropes where the size of the barrel and sheave will permit; it is also the make of rope in general use for standing rigging, and is such as is required by Lloyd's regulations.
2. Hauling rope made of 6 strands, each strand being of 7 wires covering 7 smaller ones.
3. Hauling rope made of 6 strands, each of 8 wires covering 7 smaller ones.
4. Hauling rope made of 6 strands, each of 10 wires covering 7 smaller ones.
5. Formed rope made of 6 strands of 19 wires each. In larger sizes this make of rope is used for standing rigging on vessels. In smaller sizes it is sometimes used for running rigging, and it is the usual make of rope for trawl warps.
6. Flexible steel wire rope, made of 6 strands each of 12 wires, with hemp heart and hemp centre in each strand. This is the usual make of flexible steel wire rope, $4\frac{1}{2}$ in. in circumference and smaller; used for hawsers, running lifts, hoists, &c.
7. Extra flexible steel wire rope made of 6 strands each of 24 wires.
8. Special extra flexible steel wire rope made of 6 strands each of 37 wires.

9. Special extra flexible steel wire rope made of 6 strands each of 61 wires. This is the make of rope usually adopted for large ropes—say over 10 in. in circumference—which are largely used for shipway and salvage purposes.
10. Cable-laid rope. This is an obsolete form of rope, which is composed of six complete ropes twisted together.

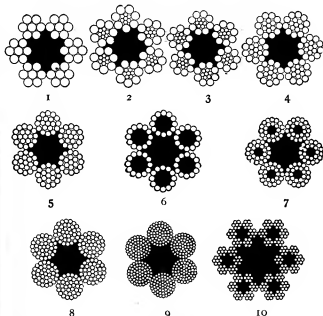

FIG. 8.

The following table supplies particulars about wire ropes which are used for general hauling purposes:—

Circumference.	Dia-meter.	Breaking Strain in Tons.				Approximate Weight per Fathom.
		"Crucible" Steel.	Best Selected Improved "Crucible" Steel.	Best Selected "Mild" Plough Steel.	Best Selected "Extra" Plough Steel.	
$1\frac{1}{2}$ in.	$\frac{3}{8}$ in.	4 $\frac{1}{2}$	4 $\frac{1}{2}$	5 $\frac{1}{2}$	5 $\frac{1}{2}$	1 $\frac{1}{2}$ lb
1 $\frac{3}{8}$ "	$\frac{7}{16}$ "	6	6 $\frac{1}{2}$	7 $\frac{1}{2}$	7 $\frac{1}{2}$	2 "
1 $\frac{1}{2}$ "	$\frac{1}{2}$ "	8 $\frac{1}{2}$	8 $\frac{1}{2}$	9 $\frac{1}{2}$	10 $\frac{1}{2}$	3 $\frac{1}{2}$ "
2 "	$\frac{5}{8}$ "	11	11 $\frac{1}{2}$	12 $\frac{1}{2}$	14 $\frac{1}{2}$	4 "
2 $\frac{1}{2}$ "	$\frac{3}{4}$ "	14 $\frac{1}{2}$	15	16 $\frac{1}{2}$	18	5 $\frac{1}{2}$ "
2 $\frac{3}{4}$ "	$\frac{7}{8}$ "	17 $\frac{1}{2}$	18 $\frac{1}{2}$	20	22 $\frac{1}{2}$	6 $\frac{1}{2}$ "
2 $\frac{1}{2}$ "	1 "	21 $\frac{1}{2}$	21 $\frac{1}{2}$	24 $\frac{1}{2}$	27 $\frac{1}{2}$	7 $\frac{1}{2}$ "
3 "	1 $\frac{1}{8}$ "	24 $\frac{1}{2}$	26 $\frac{1}{2}$	29	31 $\frac{1}{2}$	9 "
3 $\frac{1}{4}$ "	1 $\frac{1}{4}$ "	29 $\frac{1}{2}$	31 $\frac{1}{2}$	35	38	10 $\frac{1}{2}$ "
3 $\frac{1}{2}$ "	1 $\frac{3}{8}$ "	34 $\frac{1}{2}$	36 $\frac{1}{2}$	40 $\frac{1}{2}$	44 $\frac{1}{2}$	13 "
3 $\frac{3}{4}$ "	1 $\frac{7}{8}$ "	39 $\frac{1}{2}$	42	46	50 $\frac{1}{2}$	14 $\frac{1}{2}$ "
4 "	1 $\frac{1}{2}$ "	45 $\frac{1}{2}$	48 $\frac{1}{2}$	53	58	16 $\frac{1}{2}$ "
4 $\frac{1}{4}$ "	1 $\frac{5}{8}$ "	52 $\frac{1}{2}$	56	61 $\frac{1}{2}$	67	17 $\frac{1}{2}$ "
4 $\frac{1}{2}$ "	1 $\frac{3}{4}$ "	57 $\frac{1}{2}$	61	67	73	20 "
4 $\frac{3}{4}$ "	1 $\frac{7}{8}$ "	65	69	76	83	22 "
5 "	1 $\frac{7}{8}$ "	72	76	85	92	25 "

The diameter of drums and sheaves should be about thirty times the circumference of the rope.

For shaft winding at high speed one-tenth of the breaking strain of a rope is sometimes taken as a fair working load. For inclines, the proportion of load to breaking strain varies according to gradient conditions, and friction should be allowed for.

The first requisite in the manufacture of wire ropes is the selection and blending of the different iron ores. The different processes through which the metal passes, and the hammering and drawing into rods, require great experience, and give to it the peculiar properties that are essential for the finished article. The same remarks apply to the annealing and hardening processes, during which the rods are drawn through dies to the required gauge. The wire is now subjected to special processes of galvanizing in order to make it proof against atmospheric and other influences. Afterwards it is wound on bobbins of suitable size, a definite number of which are mounted on the forks or frames of the stranding machine. These forks are swung or pivoted between disks, which are keyed on a hollow main shaft, through which the wires or other material

intended for the core pass. This core is of such a size that the aggregate number of wires that are mounted in the machine exactly cover it in a spiral direction.

All the wires, including the centre core, are passed through their individual hollow spindles, then led to the nose or head of the machine, and finally passed through a stationary compression block to draw-off wheels. The speed of these wheels is regulated in proportion to the speed of the machine by means of suitable gearing. During the revolutions of the machine each bobbin and fork is kept in a vertical position, and floats thus, by means of an eccentric ring behind the back disk. This ring is connected to the spindles of the bobbin forks by means of small cranks, thus preventing any torsional movement that would otherwise be imparted to the individual wires.

Each bobbin is controlled by a brake which acts as a tensioning device so that equal strain can be applied to each, allowing the wires to unwind uniformly. The finished strands are wound in turn upon large bobbins, and mounted in the flyers or disks of the rope closing machine. These machines are similar in design to the stranding machine, but are naturally much heavier in construction, and therefore revolve at a proportionate speed. The speed of the machines varies according to the weight of material, the size of the strands and the construction of the finished rope. The modern machine, or the type most generally used, makes about fifty revolutions per minute, whilst three times this speed is often obtained when spinning the strands.

The rapid strides made by electricity have furnished another large branch of what may be termed wire rope manufacture. The ropes used for electrical purposes are almost invariably termed cables, and there are many different kinds and sizes of them. The wire must necessarily possess good conducting power, and be comparatively cheap. Up to the present copper has proved to be the chief material possessing these two important properties in combination; hence it is the metal *par excellence* for electrical conduction. Aluminium and alloys have been tried with varying degrees of success.

The conductor itself consists of a strand of soft copper wires, around which the dielectric or non-conducting material is placed. The methods of forming the strands do not differ essentially from those described above. The dielectric is usually paper, spun jute fibre, vulcanized india-rubber or vulcanized bitumen. If the first two dielectrics are used, a lead sheath is necessary to enclose the insulated strand and so exclude moisture; if the cable is likely to get damaged, it is further enclosed by steel tapes or steel wires, and finally covered with yarn or braid. Vulcanized bitumen is not only a dielectric, but is also absolutely impervious to moisture.

Hence in many instances where paper or fibre is employed as the principal dielectric, a sheath of vulcanized bitumen is used instead of lead to exclude moisture. Cables are also made with a single central strand of copper wires in addition to one or more concentric layers of copper wires, the layers being separated by some dielectric material; or there may be two or more strands, separately insulated, and more or less elaborately clothed with the above-mentioned substances. (T. Wo.)

ROPES, JOHN CODMAN (1836-1899), American military historian and lawyer, was born at St Petersburg on the 28th of April 1836, the son of a leading merchant of Boston who was engaged in business in Russia. At the age of fourteen, his family having meantime returned to Massachusetts, he developed an affection of the spine which eventually became a permanent deformity. His courage and energy, however, did not allow him to yield to his affliction. He entered Harvard in 1853, and graduated in 1857. His interests as a young man were chiefly religious, legal and historical, and these remained with him throughout life, his career as a lawyer being conspicuous and successful. But it was the outbreak of the Civil War in 1861 which fixed his attention principally on military history. He ceaselessly assisted with business and personal help and friendship the officers and men of the 20th Massachusetts regiment, in which his brother, Henry Ropes, served up to his death at Gettysburg, and after the war he devoted himself to the collection and elucidation of all obtainable evidence as to its incidents and events. In this work his clear and unprejudiced legal mind enabled him to sift the truth from the innumerable public and private controversies, and the ill-informed allotment of praise and blame by the popular historians and biographers. The focus of his work was the Military Historical Society of Massachusetts, which he founded in 1876. The work of this society was the collection and discussion of evidence relating to the great conflict. Although practically every member of this society except himself had fought through the war, and many, such as Hancock and W. F. Smith, were general officers

of great distinction, it was from first to last maintained and guided by Ropes, who presented to it his military library and his collection of prints and medals. He died at Boston on the 28th of October 1899. His principal work is an unfinished *Story of the Civil War*, to which he devoted most of his later years; this covers the years 1861-62. *The Army under Pope* is a detailed narration of the Virginia campaign of August-September 1862, which played a great part in reversing contemporary judgment on the events of those operations, notably as regards the unjustly-condemned General Fitz John Porter. Outside America, Ropes is known chiefly as the author of *The Campaign of Waterloo*, which is one of the standard works on the subject.

The greater part of his studies of the Civil War appears in the Military Historical Society's publications. Papers on the Waterloo campaign appeared in the *Atlantic Monthly* of June 1881, and in *Scribner's Magazine* of March and April 1888. Amongst his miscellaneous works is a paper on "The Likenesses of Julius Caesar" in *Scribner's Magazine* (February 1887).

See *Memoir of John Codman Ropes* (Boston, privately printed, 1901).

ROPE-WALKING, the art of walking, dancing and performing tricks of equilibrium on a rope or wire stretched between two supports. It has been popular with most Asiatic and European peoples from the beginning of history. Before the middle of the 19th century a rope was invariably used, and was stretched as tightly as possible, on which account the art was called *Tight-rope Walking*. About the year 1875 the *slack wire*, stretched loosely from support to support, was introduced, and is now more commonly used. The performer is often aided in keeping his balance by a Chinese umbrella or a long pole.

ROPS, FÉLICIEN (1833-1898), Belgian painter, designer and engraver, was born at Namur, in Belgium, on the 7th of July 1833; he spent his childhood in that town, and afterwards in Brussels, where he composed in 1856, for his friends at the university, the *Almanach Crocodilien*, his first piece of work. He also brought out two *Salons Illustrés*, and collaborated on the *Crocodile*, a magazine produced by the students. The humour shown in his contributions attracted the attention of publishers, who offered him work. He designed, among other things, frontispieces for Poulet-Malassis, and afterwards for Gay and Doucé. In 1859 he began to contribute to a satirical journal in Brussels called *Ulyenspiegel*, a sort of *Charivari*. The issue, limited unfortunately to two years, included his finest lithographs. About 1862 he went to Paris and worked at Jacquemart's. He subsequently returned to Brussels, where he founded the short-lived International Society of Etchers. In 1865 he brought out his famous "Buveuse d'Absinthe," which placed him in the foremost rank of Belgian engravers; and in 1871 the "Dame au Pantin." After 1874 Rops resided in Paris. His talent, which commanded attention by its novel methods of expression, and had been stimulated by travels in Hungary, Holland and Norway, whence he brought back characteristic sketches, now took a soaring flight. To say nothing of the six hundred original engravings enumerated in Ramiro's *Catalogue of Rops' Engraved Work* (Paris, Conquet, 1887), and one hundred and eighty from lithographs (Ramiro's *Catalogue of Rops' Lithographs*, Paris, Conquet, 1891), besides a large number of oil-paintings in the manner of Courbet, and of pencil or pen-and-ink drawings, he executed several very remarkable water-colour pictures, among which are "Le Scandale," 1876; "Une Attrapade," 1877 (now in the Brussels Museum); a "Tentation de St Antoine," 1878; and "Pornocrates," 1878. Most of these have been engraved and printed in colours by Bertrand. From 1880 to 1890 he devoted himself principally to illustrating books: *Les Rimes de joie*, by Théo Hannon; *Le Vice suprême and Curieuse*, by J. Plélan; and *Les Diaboliques*, by Barbey d'Aurévilly; *L'Amante du Christ*, by R. Darzens; and *Zadig*, by Voltaire; and the poems of Stéphane Mallarmé have frontispieces due to his fertile and powerful imagination. Before this he had illustrated the *Légendes Flamandes*, by Ch. Decoster; *Jeune France*, by Th. Gautier;

and brought out a volume of *Cent Croquis pour réjouir les Honnêtes Gens*. His last piece of work, an advertisement of an exhibition, was done in November 1896. Rops died on the 23rd of August 1898, at Essonnes, Seine-et-Oise, on the estate he had purchased, where he lived in complete retirement with his family. Scorning display, Rops almost always opposed any exhibition of his works. However, he consented to join the Art Society of the "XX.," formed at Brussels in 1884, as their revolutionary views were in harmony with the independence of his spirit. After his death, in 1899, the *Libre Esthétique*, which in 1894 had succeeded the "XX.," arranged a retrospective exhibition, which included about fifty paintings and drawings by Rops. Rops was a Chevalier of the Legion of Honour. He excelled in these three methods of artistic expression; but his engraved work is the most important, both as to mastery of technique and originality of ideas, though in all his talent was exceedingly versatile. Hardly any artist of the 19th century equalled him in the use of the dry-point and soft varnish. By his assured handling and admirable draughtsmanship, as well as the variety of his sometimes wildly fantastic conceptions, he made his place among the great artists of his time. "Giving his figures a character of grace which never lapses into limpness," says his biographer, E. Ramiro, "he has analysed and perpetuated the human form in all the elegance and development impressed on it by modern civilization."

In 1896 *La Plume* (Paris) devoted a special number to this artist, fully illustrated, by which the public were made aware how many of his works are unsuitable for display in the drawing-room or boudoir. E. Deman, the publisher at Brussels, brought out a volume in 1897 with the title, *Félicien Rops et son œuvre*—papers by various writers. We may also mention a study of *Félicien Rops*, by Eugène Demolder (Paris, Princebourde, 1894), and another by the same writer in *Trois Contemporains* (E. Deman, 1901); *Les Ropsiques*, by Pierre Gaume, brought out in London, 1898; and the admirable notice by T. K. Huysmans in his volume called *Certains*. (O. M. *)

ROQUELAURE, a title derived from a small commune in France (dep. of Gers), and borne by a French family of Armagnac, one member of which was Antoine, baron de Roqueleure (1544-1625), who was in the service of Henry IV. before he became king, and after his accession was made master of the wardrobe, lieutenant-general in Auvergne (1576) and Guienne (1610), and marshal of France in 1614. His son, Gaston Jean Baptiste de Roqueleure (1617-1683), a celebrated wit, was created duke and peer of France in 1652, and was appointed governor of Guienne in 1679. Gaston's son, Antoine Gaston Jean Baptiste de Roqueleure (1656-1738), carried on the family reputation for wit, and, in spite of his military incapacity, received the marshal's bâton in 1724.

RORQUAL, a whale of a long and elongated shape, with a small back-fin and a number of longitudinal pleatings or folds on the throat (see CETACEA). The name rorqual refers to these folds, while the alternative title of finner, or fin-whale, marks an important difference between these whales (for there are several species) and right-whales. The furrows on the throat are numerous and close-set, the flipper is comparatively small, and the dorsal fin distinct. The head is relatively small, flat and pointed in front, the whalebone short and coarse, the body long and slender, and the tail much compressed before it expands into the "flukes." Rorquals are the most abundant and widely distributed of all whales, being found in all seas, except the extreme Arctic and Antarctic regions. There are four distinct species of this genus in British seas. Firstly, Sibbald's rorqual, or blue whale (*Balaenoptera sibbaldi*), the largest of all animals, attaining a length of 80 or even sometimes 85 ft. Its colour is dark bluish grey, with small whitish spots on the breast; the whalebone is black; the flippers are larger proportionally than in other rorquals, measuring one-seventh of the total length of the body; and the dorsal fin is small and placed far back. This whale has usually 64 vertebrae, of which 16 bear ribs. Like the others, this species seems to pass the

winter in the open seas, and approaches the coast of Norway at the end of April or beginning of May. At this time its sole food is a small crustacean (*Euphausia inermis*), which swarms in the fjords. Secondly, we have the common rorqual (*B. musculus*, or *B. physalus*) with a length of from 65 ft. to 70 ft., and of a greyish slate-colour above and white underneath, and the whalebone slate-colour, variegated with yellow or brown. It has usually 62 vertebrae, of which 15 bear ribs. This is the commonest of all the large whales on the British coasts; scarcely a winter passing without the body of one being washed ashore, usually after stormy weather, and frequently on the south coast, as this species has a more southern range than the last, and enters the Mediterranean. It feeds largely on fish, and is frequently



Common Rorqual (*Balaenoptera musculus*).

seen feasting among shoals of herrings. Thirdly comes Rudolph's rorqual (*B. borealis*), a smaller species, scarcely attaining a length of 50 ft. It is bluish black above, with oblong light-coloured spots, whilst the under-parts are more or less white; the whole of the tail and both sides of the flippers are black; the whalebone is black, and the bristly ends fine, curling and white; the flippers are very small, measuring one-eleventh of the total length of the body. There are 56 vertebrae, with 14 pairs of ribs. This species, according to Dr. C. Collett, feeds chiefly on minute crustaceans, mainly *Calanus finmarchicus* and *Euphausia inermis*, and not on fish. Down to the last quarter of the 19th century it was considered the rarest of the whales of European seas, and was only known from a few individuals stranded on the coasts of northern Europe at long intervals. The most southern point at which it has been met with is Biarritz. Since the establishment of the whaling station near the North Cape it has been shown to be a regular summer visitor. Lastly, the lesser rorqual, *B. rosstrata*, the sharp-nosed finner of American whalers, is the smallest species found in the northern seas, rarely exceeding 30 ft. in length. Its colour is greyish black above, whilst the under-side is white, including the whole of the lower side of the tail; the inner side of the flippers is also white, and there is a broad white band across the outer side, which is a very characteristic mark of the species; the whalebone is yellowish white. The dorsal fin in this and the preceding species is comparatively high, and placed far forwards on the body. This whale has usually 48 vertebrae, of which 11 bear ribs. It is common in summer in the fjords of Norway, and is often seen around the British Isles. It has been taken, though rarely, in the Mediterranean, and ranges as far north as Davis Strait.

Rorquals are met with in almost all seas, and nearly all the individuals carefully examined, whether from the North Pacific, the Australian seas or the Indian Ocean, come very near in structure to one or the other of the Atlantic forms described above, so much so that some zoologists believe that there are but four species, with an almost cosmopolitan range. Other naturalists, on the contrary, have described and named almost every individual specimen captured as belonging to a different species. See WHALE and HUMP-BACK WHALE. (R. L. *)

RORSCHACH, a busy commercial town in the Swiss canton of St Gall, situated on the south-west shore of the Lake of Constance, and by rail 62 m. N.E. of Zürich, 10 m. S.E. of Romanshorn and 57 m. N. of Coire. In 1900 its population was 9140, mostly German-speaking, while there were 9535 Romanists or 3139 Protestants. From 1408 to 1708 it belonged to the abbot of St Gall, and then to the canton Sântis (named canton of St Gall in 1803) of the Helvetic Republic. It has always been a great commercial centre, though now superseded by Romanshorn as regards the corn trade. It has many industrial establishments, of which the chief is one for the manufacture of lace and

muslin. Above the town is the old convent of Mariaberg, originally built in the 15th century as a refuge for the monks of St Gall against the turbulent citizens of that town, but now a seminary for teachers. From Rorschach a cogwheel railway runs south-east in 4½ m. up to Heiden, a village in the canton of Appenzell well known for its goats' whey cure. (W. A. B. C.)

ROS, or **DE ROS**, the name of a noble English family. Robert de Ros (d. 1227), a son of Everard de Ros (d. 1191) of Helmsley, or Hamlake, in Yorkshire, possessed lands in Yorkshire, including Ros, or Ross, in Holderness, and also in Normandy. He served King John in several ways, both in England and abroad, and obtained lands in Northumberland, where he built a castle at Wark, or Werke. About 1215, however, he deserted the king and became one of the leaders of the baronial party, being one of the twenty-five executors of Magna Carta and fighting against John when he repudiated this engagement. He submitted to Henry III. and became a monk before he died in 1227. His wife was Isabella, daughter of William the Lion, king of Scotland, by whom he had two sons, William and Robert. Robert de Ros the younger (d. 1274), was an itinerant justice under Henry III., but later he was one of the barons who fought against this king. He passed much of his time, however, in Scotland, where he held a barony and where he was one of the guardians of Margaret, the English bride of King Alexander III. His son Robert was summoned to parliament as Lord Ros de Werke in 1295; just afterwards he revolted against Edward I. and his lands were forfeited. William de Ros (d. 1258), the elder son of the executor of Magna Carta, had a son Robert (d. 1285), who was summoned to parliament as a baron by Simon de Montfort in 1264; he was also summoned to parliament by Edward I. His son Robert, 2nd baron Ros of Helmsley, or Hamlake (d. 1317), obtained Belvoir Castle in Leicestershire through his mother Isabel, daughter of William d'Albini. He was one of the minor claimants for the crown of Scotland in 1292, and soon afterwards he obtained the lands in Northumberland which had been taken from his traitorous cousin Robert de Ros. His second son, John de Ros (d. 1338), was a courtier under Edward II. Later he joined Edward's queen, Isabella, was summoned to parliament by Edward III., and distinguished himself on the sea. Another John de Ros (d. 1332), bishop of Carlisle from 1325 to 1332, was doubtless a member of this family.

The second baron's descendants retained the barony of Ros until the death of Edmund de Ros, the 11th baron, in October 1508. Edmund's nephew Sir George Manners (d. 1513), of Belvoir and Helmsley, then claimed it, and was called Lord Ros, or Roos. His son, Thomas Manners, the 13th baron (d. 1543), was created earl of Rutland in 1525, but the barony was separated from the earldom when Thomas's grandson Edward died in 1587, leaving an only child, Elizabeth (d. 1591), who, as heir general of the family, became Baroness Ros, or Roos. Elizabeth married into the Cecil family, and when her only child, William Cecil, died in 1618, the barony reverted to the Manners family, Francis Manners, 6th earl of Rutland (1578-1632), becoming the 18th baron. On his death the barony again passed to a female, his daughter Katherine, through whom it came to the family of Villiers. Then in 1806, after a long abeyance, Charlotte (1769-1831), daughter of the Hon. Robert Boyle, and a descendant of the Manners family, was declared Baroness Ros, or Roos. She married Lord Henry Fitzgerald, and their son, Henry William Fitzgerald-de-Ros (1793-1839), became the 22nd baron on his mother's death. In 1907, on her father's death, Mary Frances, wife of the Hon. Anthony Dawson, became Baroness Ros, or rather, De Ros, which is the present form of the title. For a long time after they had ceased to hold the barony the earls and dukes of Rutland continued to style themselves Lords Ros.

ROS, SIR RICHARD (b. 1429), English poet, son of Sir Thomas Ros, lord of Hamlake (Helmsley) in Yorkshire and of Belvoir in Leicestershire, was born on the 8th of March 1429. In *Harl. MS.* 372 the poem of "La Belle Dame sanz Mercy," first printed in W. Thynne's *Chaucer* (1532), has the ascription

"Translatid out of Frenche by Sir Richard Ros." "La Belle Dame sanz Mercy" is a long and rather dull poem from the French of Alain Chartier, and dates from about the middle of the 15th century. It is written in the Midland dialect, and is surprisingly modern in diction. The opening lines—

"Half in a dreame, not fully well awaked,

The golden sleep me wrapped under his wing,"

have often been quoted, but the dialogue between the very long-suffering lover and the cruel lady does not maintain this high level.

See W. W. Skeat, *Chaucerian and Other Pieces* (1897); and Dr. H. Gröher, *Ueber Richard Ros' mittellenglische Uebersetzung . . .* (Breslau, 1886).

ROSA, CARL AUGUST NICHOLAS (1843-1889), English musical impresario, was born at Hamburg, his family name (which he subsequently changed) being Rose. He started as a solo violinist, studying at Leipzig and Paris, and also had considerable success as a conductor both in England and America; and it was at New York in 1867 that he met and married the famous operatic soprano Madame Parepa (1836-1874), at whose death he afterwards endowed a Parepa-Rosa scholarship at the Royal Academy of Music in London. In 1875 he started the Carl Rosa Opera Company, for producing the best operas in English versions, and both during his own life and after his death this company had much to do with popularizing good music in England, encouraging native composers and training a number of excellent singers. Carl Rosa married a second time in 1881, and died in Paris on the 30th of April 1889.

ROSA, MONTE, the name of a great glacier-clad mountain mass (the name comes from the Aostan patois word *roëse*, meaning a glacier) which rises S.E. of Zermatt, and on the frontier between Switzerland (canton of the Valais) and Italy. Ten summits in this huge mass are distinguished by name, of which four (the Nordend, 15,132 ft., the Zumsteinspitze, 15,004 ft., the Signalnuppe or Punta Gniffetti, 14,965 ft., and the Parrotspitze, 14,643 ft.) rise on the frontier. The five lower summits are on the Italian slope, but the highest of all, the Dufourspitze, 15,217 ft. (so named by the Swiss government in honour of General Dufour, the head of the great survey which first accurately fixed the position of these points), rises W. of the frontier ridge, on a buttress, and is thus entirely in Switzerland, of which it is the culminating peak (and not, as often stated, the Dom, 14,942 ft., in the Mischabel group). The loftiest point of the Dufourspitze was first attained in 1855 by a large English party, which included Messrs G. and C. Smyth, C. Hudson, Birkbeck and Stevenson. The Zumsteinspitze was first climbed in 1820, the Signalnuppe (on top of which there is now a club hut) in 1842, the Nordend in 1861 and the Parrotspitze in 1863. The ascent of all the points named is not difficult from the Swiss side, but excessively dangerous on the east or Italian side. (W. A. B. C.)

ROSA, SALVATOR (1615-1673), Italian painter of the Neapolitan school, was born in Arenella, in the outskirts of Naples, in 1615; the precise day is given as the 20th of June, and also as the 21st of July. His father, Vito Antonio de Rosa, a land surveyor, was bent upon making the youth a lawyer, or else a priest, and sent him to study in the convent of the Somaschi fathers. Here Salvator began showing a turn for art: he went in secret to his maternal uncle Paolo Greco to learn the practice of painting, but soon found that Greco had little pictorial lore to impart, so he transferred himself to his own brother-in-law Francesco Fracanzaro, a pupil of Ribera, and afterwards had some practice under Ribera himself. Above all he went to nature, frequenting the Neapolitan coast, and keeping his eyes open and his hand busy. At the age of seventeen he lost his father; the widow was left unprovided for, with at least five children, and Salvator found himself immersed in a sea of troubles and perplexities, with nothing for the while to stem them except a buoyant and adventurous temperament. He obtained some instruction under the battle-painter Aniello Falcone, but chiefly painted in solitude, haunting romantic

and desolate spots, beaches, mountains, caverns, verdure-clad recesses. Hence he became in process of time the initiator of romantic landscape, with a special turn for scenes of strange or picturesque aspect—often turbulent and rugged, at times grand, and with suggestions of the sublime. He picked up scanty doles when he could get them, and his early landscapes sold for a few pence to petty dealers. The first person to discover that Rosa's work was not as trumpery as it was cheap was the painter Lanfranco, who bought some of the paintings, and advised the youth to go to Rome. Hither in 1635, at the age of twenty, Rosa betook himself; he studied with enthusiasm, but, catching fever, he returned to Naples and Falcone, and for a while painted nothing but battlepieces, and these without exciting any attention. This class of work was succeeded by the landscape art peculiarly characteristic of him—wild scenes wildly peopled with shepherds, scamen or especially soldiers. He then revisited Rome, and was housed by Cardinal Brancaccio; this prelate being made bishop of Viterbo, Rosa painted for the Chiesa della Morte a large and noticeable picture of the "Incredulity of Thomas"—the first work of sacred art which we find recorded from his hand. At Viterbo he made acquaintance with a mediocre poet named Abati, and was hence incited to try his own faculty in verse. He then returned to Naples. Here the monopolizing triumvirate—Ribera, Caracciolo and Corenzio—were still powerful. Rosa was as yet too obscure to suffer from their machinations; but, having painted a picture of "Tityus Torn by the Vulture," which went to Rome and there produced a great sensation, he found it politic to follow in the footsteps of his fame, and once more, in 1638, resought the papal city.

Rosa was a man of facile and versatile genius, and had by this time several strings to his bow. It is said that, still keeping painting steadily in view as his real objective, he resolved to secure attention first as a musician, poet, improvisatore and actor—his mother-wit and broad Neapolitan dialect (which appears to have stuck to him through life) standing him powerfully in stead. In the carnival he masqued as Formica and Capitano Coviello, and bustled about Rome distributing satirical prescriptions for diseases of the body and more particularly of the mind. As Formica he inveighed against the farcical comedies acted in the Trastevere under the direction of the celebrated Bernini. Some of the actors, in one of their performances, retaliated by insulting Rosa, but the public was with him, and he now enjoyed every form of success—social prestige, abundant commissions and any amount of money, which he was wont to throw about broadcast to the populace. In 1646 he returned to Naples, and is said to have taken an active part in the insurrection of Masaniello; certain it is that he sympathized with and admired the fisherman autocrat, for a passage in one of his satires proves this. His actual share in the insurrection is, however, dubious; it appears only in recent narratives, and the same is the case with the well-known story that at one time he herded with a band of brigands in the Abruzzi—an incident which cannot be conveniently dove-tailed into any of the known dates of his career. As regards the popular revolt against Spanish tyranny, it is alleged that Rosa, along with other painters—Coppola, Porpora, Domenico Gargiulo, Dal Po, Masturzo, the two Vaccari and Cadogna—all under the captaincy of Aniello Falcone, formed the *Compagnia della Morte*, whose mission it was to hunt up Spaniards in the streets and despatch them, not sparing even those who had sought some place of religious asylum. He painted a portrait of Masaniello—probably from reminiscence rather than from life: indeed, it is said that he painted him several times over in less than life size. On the approach of Don John of Austria the blood-stained *Compagnia* dispersed, Rosa escaping or at any rate returning to Rome. Here he painted some important subjects, showing the uncommon bent of his mind as it passed from landscape into history—"Democritus amid Tombs," the "Death of Socrates," "Regulus in the Spiked Cask" (these two are now in England), "Justice Quitting the Earth," and the "Wheel of Fortune." This last work, the tendency of which was bitingly satirical, raised a storm of ire and remonstrance.

Rosa, endeavouring at conciliation, published a description of its meaning (probably softened down not a little from the real facts); none the less an order for his imprisonment was issued, but ultimately withheld at the instance of some powerful friends. It was about this time that Rosa wrote his satire named *Babylon*, under which name Rome was of course indicated.

Cardinal Giancarlo de' Medici now invited the painter to leave Rome—which had indeed become too hot to hold him—for Florence. Salvator gladly assented, and remained in the Tuscan capital for the better part of nine years, introducing there the new style of landscape; he had no pupils, but various imitators. Lorenzo Lippi the painter poet, and other *beaux esprits* shared with Rosa the hospitalities of the cardinal, and they formed an academy named *I Percossi* (the Stricken), indulging in a deal of ingenious jollity—Rosa being alike applauded as painter, poet and musician. His chief intimate at this time was Lippi, whom he encouraged to proceed with the poem *Il Malmantile Racquistato*. He was well acquainted also with Ugo and Giulio Maffei, and housed with them more than once in Volterra, where he wrote other four satires—*Music, Poetry, Painting and War*. About the same time he painted his own portrait, now in the Uffizi Gallery of Florence. Finally he reverted once more to Rome, and hardly left that city again. Much enmity still brooded there against him, taking the form more especially of an allegation that the satires which he zealously read and diffused in MS. were not his own production, but filched from some one else. Rosa indignantly repelled this charge, which remains indeed quite unsubstantiated, although it is true that the satires deal so extensively and with such ready manipulation in classical names, allusions and anecdotes, that one is rather at a loss to fix upon the period of his busy career at which Rosa could possibly have imbued his mind with such a multitude of semi-erudite details. It may perhaps be legitimate to suppose that his literary friends in Florence and Volterra had coached him up to a large extent—the satires, as compositions, remaining none the less strictly and fully his own. To confute his detractors he now wrote the last of the series, entitled *Evry*. Among the pictures of his closing years were the admired "Battlepiece" now in the Louvre, painted in the short space of forty days, full of long-drawn carnage, with ships burning in the offing; "Pythagoras and the Fishermen"; the "Oath of Catiline" (Pitti Gallery); and the very celebrated "Saul and the Witch of Endor" (Louvre), which is almost his latest work. He undertook a series of satirical portraits, to be closed by one of himself; but while occupied with this project he was assailed by dropsy, which, after lasting fully half a year, brought his life to a close on the 15th of March 1673. In his last moments he married a Florentine named Lucrezia, who kept his house and had borne him two sons, one of them surviving him, and he died in a contrite frame of mind. He lies buried in the Chiesa degli Angeli, where a portrait of him has been set up. Salvator Rosa, after the hard struggles of his early youth, had always been a successful man, and he left a handsome fortune.

Rosa was indisputably a great leader in that modern tendency of fine art towards the romantic and picturesque which, developing in various directions and by diversified processes, has at last almost totally differentiated modern from olden art. He saw appearances with a new eye, and presented new images of them in his canvases, and deserves therefore all the credit due to a vigorous innovator, even if we contest the absolute value of his product. He himself courted reputation for his historical works, laying comparatively little stress on his landscapes; in portraits he was forcible. In chiaroscuro he is simple and effective; his design has energy and a certain grandeur, without any high type of form or any superior measure of correctness. His colour is too constantly of a sandy or yellowish-grey tone. Personally he was a man of high spirit, and he sold his pictures at large prices, more (it is said) to assert the honour of his art than from love of money; rather than sell them cheap he destroyed them. In his later Florentine period he etched several of his works, subjects of mythology, soldiering, &c. He was choleric, but kind and generous. Though a man of gaiety and pleasure, and a jovial boon companion, he does not appear to have been vicious in any serious degree. He was talkative, very sharp-tongued and an unblushing encomiast of his own performances. Among his pictures not already mentioned we may name, in the National

Gallery, London, "Mercury and the Dishonest Woodman," and three others; in Raynham Hall, "Belisarius"; in the Grosvenor Gallery, "Diogenes"; in the Pitti Gallery, a grand portrait of a man in armour, and the "Temptation of St Anthony," which contains his own portrait. This last subject appears also in St Petersburg, and in the Berlin Gallery.

The satires of *Salvator Rosa* deserve more attention than they have generally received. There are, however, two recent books taking account of them—by Cesario, 1892, and Cartelli, 1899. The satires, though considerably spread abroad during his lifetime, were not published until 1719. They are all in *terza rima*, written without much literary correctness, but remarkably spirited, pointed and even brilliant. They are slashingly denunciatory, and from this point of view too monotonous in treatment. *Rosa* here appears as a very severe castigater of all ranks and conditions of men, not sparing the highest, and as a champion of the poor and down-trodden, and of moral virtue and Catholic faith. It seems odd that a man who took so free a part in the pleasures and diversions of life should be so ruthless to the ministers of these. The satire on *Music* exposes the insolence and profrugality of musicians, and the shame of courts and churches in encouraging them. *Poetry* dwells on the pedantry, imitativeness, adulation, affectation and indecency of poets—also their poverty, and the neglect with which they were treated; and there is a very vigorous sortie against oppressive governors and aristocrats. Tasso's glory is upheld; Dante is spoken of as obsolete, and Ariosto as corrupting. *Painting* inveighs against the pictorial treatment of squalid subjects, such as beggars (though *Rosa* must surely himself have been early in for a collection). In *Envy* (in the direction of the art), against the ignorance and lewdness of painters, and their tricks of trade, and the gross indecorum of painting sprawling half-naked saints of both sexes. *War* (which contains the eulogy of Masaniello) derides the folly of hiring soldiers, who fight and perish while kings stay at home; the vile morals of kings and lords, heresy and unbelief also come in for a collection. In *Babylon* *Rosa* represents himself as a fisherman, Tirreno, constantly unlucky in his net-hauls on the Euphrates; he converses with a native of the country, Ergasto. Babylon (Rome) is very severely treated, and Naples much the same. *Envy* (the last of the satires, and generally accounted the best, although without strong apparent reason) represents *Rosa* dreaming that, as he is about to inscribe in all modesty his name upon the threshold of the temple of glory, the god of Envy obstructs him, and a long interchange of reciprocal oburgations ensues. Here occurs the highly charged portrait of the chief Roman detractor of *Salvator* (we are not aware that he has ever been identified by name); and the painter protests that he would never condescend to do any of the lascivious work in painting so shamefully in vogue.

As authorities for the life of *Salvator Rosa*, Passeri, *Vite de' Pittori*, may be consulted, and Salvini, *Satire e Vita di Salvator Rosa*; also Baldinucci and Dominici. The *Life* by Lady Morgan is a romantic treatment, mingling tradition or mere fiction with fact. The novel, *A Company of Death*, by Albert Cotton, 1904, gives an interesting picture of *Salvator Rosa* at Naples. (W. M. R.)

ROSACEAE, in botany, a large cosmopolitan family of seed-bearing plants belonging to the subclass Polypetalae of Dicotyledons and containing about 90 genera with 2000 species. The plants vary widely in manner of growth. Many are herbaceous, growing erect, as *Geum*, or with slender creeping stem, as in species of *Potentilla*, sometimes sending out long runners, as in strawberry; others are shrubby, as raspberry, often associated with a scrambling habit, as in the brambles and roses, while apple, cherry, pear, plum and other British fruit trees represent the arborescent habit. Vegetative propagation takes place by means of runners, which root at the apex and form a new plant, as in strawberry; by suckers springing from the base of the shoot and rising to form new leafy shoots after running for some distance beneath the soil, as in raspberry; or by shoots produced from the roots, as in cherry or plum. The scrambling of the brambles and roses is effected by means of prickles on the branches and leaf-stalks.

The leaves, which are arranged alternately, are simple, as in apple, cherry, &c., but more often compound, with leaflets palmately arranged, as in strawberry and species of *Potentilla*, or pinnately arranged, as in the brambles, roses, mountain ash, &c. A difference in this respect often occurs in one and the same genus, as in *Pyrus*, where apple (*P. Malus*), and pear (*P. communis*) have simple leaves, whereas mountain ash and rowan (*P. aucuparia*) has pinnately compound leaves. In

warm climates the leaves are often leathery and evergreen. The leaves are stipulate, the stipules being sometimes small and shortlived, as in *Pyrus* and *Prunus* (cherry, plum, &c.), or more important structures adnate to the base of the leaf-stalk, as in roses, brambles, &c. The flowers, which are regular, generally bisexual, and often showy, are sometimes borne singly, as in some species of rose, or of the cloudberry (*Rubus chamaemorus*), or few or more together in a corymbose manner, as in some roses, hawthorn and others. The inflorescence in agrimony is a raceme, in *Poterium* a dense-flowered spike, in *Spiraea* a number of cymes arranged in a corymb. The parts of the flowers are arranged on a 5-merous plan, with generally considerable increase in the number of stamens and carpels. The shape of the thalamus or floral receptacle, and the relative position and number of the stamens and carpels and the character of the fruit, vary widely and form distinguishing

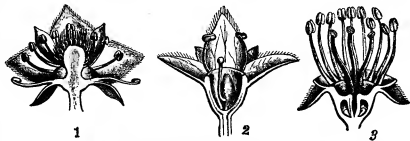

After Focke in *Naturl. Pflanzenfamilien*, from Strasburger's *Lehrbuch der Botanik*, by permission of Gustav Fischer.

FIG. 1.—Three flowers cut through longitudinally to show different forms of receptacles in the Rosaceae: 1, *Comarum palustre*; 2, *Alichemilla alpina*; 3, *Pyrus Malus*.

features of the different suborders, six of which may be recognized.

Suborder I. Spiraeoideae is characterized by a flat or slightly convex receptacle on which the carpels, frequently five in number, form a central whorl; each ovary contains several ovules, and the fruit is a follicle. There are five sepals, five petals and the stamens vary from ten to indefinite. The plants are generally shrubs with simple or compound leaves and racemes or panicles of numerous small white, rose or purple flowers. This suborder, which is nearly allied to the order Saxifragaceae, contains 17 genera, chiefly north temperate in distribution. The largest is *Spiraea*, numerous species of which are cultivated in gardens; *S. salicifolia* occurs in Britain apparently wild in plantations, but is not indigenous. The native British meadow-sweet (*S. Umaria*) and dropwort (*S. Filipendula*) have been placed in a separate genus, *Umaria*, and included in the Rosoideae on account of their one-seeded fruit. *Quillaja saponaria* is the Chilean soap tree; the bark contains saponin.

Suborder II. Pomoideae is characterized by a deep cup-shaped receptacle with the inner wall of which the five or fewer carpels are united (fig. 1, 3); the carpels are also united with each other, and each contains generally two ovules. The fruit is made up of the large fleshy receptacle surrounding the ripe ovaries, the endocarp of which is leathery or stony and contains one seed. The plants are shrubs or trees with simple or pinnately compound leaves and white or rose-coloured often showy flowers, with five sepals and petals and indefinite stamens. The 14 genera are distributed through the north temperate zone, extending southwards in the New World to the Andes of Peru and Chile. The largest genus, *Pyrus*, with about 50 species, includes apple (*P. Malus*), pear (*P. communis*) (fig. 2), wild service (*P. torminalis*), rowan or mountain-ash (*P. aucuparia*), and white beam (*P. Aria*). *Mespilus* (medlar) and *Cotoneaster* are also included. (See separate articles for most of the above.)

Suborder III. Rosoideae is characterized by the receptacle being convex and swollen (fig. 1, 1), as in strawberry, or cup-shaped, as in rose (fig. 4), and bearing numerous carpels, each of which contains one or two ovules, while the fruit is one-seeded and indehiscent. The 39 genera are grouped in tribes according to the form of the receptacle and of the fruit. The Potentilleae bear the carpels on a large, rounded or convex outgrowth of the receptacle. In the large genus *Rubus* (fig. 3) the ripe ovaries form drupels upon the dry receptacle; the genus is almost cosmopolitan, but the majority of species occur in the forest region of the north temperate zone and in the mountains of tropical America. *R. fruticosus* is blackberry, *R. Idaeus*, raspberry, and *R. Chamaemorus*, cloudberry. In the flower of *Potentilla*, *Fragaria* (strawberry) and a few allied genera an *epicalyx* is formed by stipular structures arising at the base of the sepals. The fruits consist of numerous dry achenes borne in *Fragaria* on the much-enlarged

succulent torus, which in the other genera is dry. In *Geum* (avens) and *Dryas* (an arctic and alpine genus) the style is persistent in the



After Wossido, from Strasburger's *Lehrbuch der Botanik*, by permission of Gustav Fischer.

FIG. 2.—*Pyrus communis* (pear). 1, flowering branch; 2, a flower cut through longitudinally; 3, longitudinal section of fruit; 4, floral diagram.

fruit, forming a feathery appendage (*Dryas*) or a barbed awn (avens), either of which is of service in distributing the fruit. The Potentilleae are chiefly north temperate, arctic and alpine plants.



After Wossido, from Strasburger's *Lehrbuch der Botanik*, by permission of Gustav Fischer.

FIG. 3.—*Rubus fruticosus* (blackberry). 1, flowering branch; 2, longitudinal section of a flower; 3, fruit; 4, floral diagram.

The Roseae comprise the large genus *Rosa*, characterized by a more or less urn-shaped torus (fig. 4) enclosing the numerous carpels which form dry one-seeded fruits enveloped in the bright-coloured fleshy torus. The numerous stamens surround the mouth of the torus. The plants are shrubs bearing prickles on the stems and leaves; many species have a scrambling habit resembling the brambles. The species of *Rosa*, like those of *Rubus*, are extremely variable, and a great number of subspecies, varieties and forms have been described. The Sanguisorbeae are a reduced form of Rosoideae. The dry one-seeded fruit is enclosed in the urn-shaped

torus, which, however, is dry and inconspicuous, and the number of carpels is much reduced, sometimes to one (figs. 2, 5, 6). Petals are often wanting, as in *Alchemilla* (lady's mantle) and *Poterium*, and the flowers are often unisexual and frequently wind-pollinated, as in salad burnet (*Poterium Sanguisorba*), where the small flowers are crowded in heads, the upper pistillate, with protruding feathery stigmas, and the lower staminate (or bisexual) with exerted stamens. *Agrimonia* (agrimony) has a long spike of small honeyless flowers with yellow petals; in the fruit the torus becomes hard and crowned by hooked bristles which ensure the distribution of the enclosed achenes.

Suborder IV. *Neuradoideae* contains only two genera of desert-inhabiting herbs with yellow flowers; and the five to ten carpels are united together and with the base of the cup-shaped torus, which enlarges to form a dry covering round the one-seeded fruits.

Suborder V. *Prunoideae* (fig. 7) is characterized by a free solitary carpel with a terminal style and two pendulous ovules, and the fruit a one-seeded drupe. The torus forms a cup from the edge of which spring the five sepals, five alternating petals and the ten to indefinite stamens. The plants are deciduous or evergreen trees or shrubs with simple leaves, often



After Duchatre, from Strasburger's *Lehrbuch der Botanik*, by permission of Gustav Fischer.

FIG. 4.—Fruit of Rose, consisting of the fleshy hollowed axis, *s'*, the persistent sepals *s*, and the carpels *fr*. The stamens *e* have withered.



FIG. 5.—Carpel of Lady's Mantle (*Alchemilla*) with lateral style *s*; *o*, ovary; *st*, stigma, enlarged.



FIG. 6.—Floral Diagram of *Sanguisorba*. *b*, bract; *a'*, *beta'*, bracteoles; *d*, disk.

with small caducous stipules, and racemes or umbels of generally showy, white or pink flowers. There are five genera, the chief of which is *Prunus*, to which belong the plum (*Prunus communis*), with several well-marked subspecies—*P. spinosa* (sloe or blackthorn), *P. insititia* (bullace), *P. domestica* (wild plum), the almond (*P. Amygdalus*), with the nearly allied peach (*P. persica*), cherry (*P. Cerasus*), birdcherry (*P. Padus*) and cherry



After Wossido from Strasburger's *Lehrbuch der Botanik*, by permission of Gustav Fischer.

FIG. 7.—*Prunus Cerasus*. 1, flowering branch; 2, a flower cut through longitudinally; 3, fruit in longitudinal section.

laurel (*P. Laurocerasus*). The tribe is distributed through the north temperate zone, passing into the tropics.

Suborder VI. *Chrysohalanoideae* resembles the last in having a single free carpel and the fruit a drupe, but differs in having the style basal, not terminal, and the ovules ascending, not pendulous; the flowers are also frequently zygomorphic. The 12 genera are tropical evergreen trees or shrubs, the great majority being South American. The zygomorphic flowers indicate an affinity with the closely allied order Leguminosae.

ROSAMOND, known as "The Fair" (d. c. 1176), mistress of Henry II., king of England, is believed to have been the daughter of Walter de Clifford of the family of Fitz-Ponce. The evidence for the paternity is, however, only an entry of a statement made by the jurors of the manor of Corham in a Hundred Roll of the second year of the reign of Edward I. (1274), great-grandson of Henry II. Rosamond is said to have been Henry's mistress secretly for several years, but was openly acknowledged by him only when he imprisoned his wife Eleanor of Aquitaine as a punishment for her encouragement of her sons in the rebellion of 1173-74. She died in or about 1176, and was buried in the nunnery church of Godstow before the high altar. The body was removed by order of St Hugh, bishop of Lincoln, in 1191, and was, seemingly, reinterred in the chapter house. The story that she was poisoned by Queen Eleanor first appears in the French Chronicle of London in the 14th century. The romantic details of the labyrinth at Woodstock, and the clue which guided King Henry II. to her bower, were the inventions of story-writers of later times. There is no evidence for the belief that she was the mother of Henry's natural son William Longsword, earl of Salisbury.

ROSARIO, a city and river port of Argentina, in the province of Santa Fé, on the W. bank of the Paraná, 186 m. by rail N.W. of Buenos Aires. Pop. (1904, estimate) 120,000. It is accessible to ocean-going steamers of medium draught. The city stands on the eastern margin of the great pampean plain, 65 to 75 ft. above the wide river-bed washed out by the Paraná. It extends back a considerable distance from the river, and there are country residences and gardens of the better class along the line of the Central Argentine railway and northward toward San Lorenzo. The city is laid out with chessboard regularity, and the streets are paved (in great part with cobblestones), lighted with gas and electricity, traversed by tramway lines, and provided with sewers and water mains. The Boulevard El Santafecino is an attractive residence street with double driveways separated by a strip of garden and bordered by fine shade trees. The chief edifices of an official character are the custom house, post office, municipal hall and law courts. There is a large charity hospital, and the English and German colonies maintain a well-equipped infirmary. The largest sugar refinery in Argentina is here, and there are flour-mills, breweries and some smaller manufactures. The city is chiefly commercial, being the shipping port for a large part of northern Argentina, among its exports being wheat, flour, baled hay, linned, Indian corn, sugar, rum, cattle, hides, meats, wool, quebracho extract, &c. The railway connexions are good, including the Buenos Aires and Rosario and the Central Argentine lines to the national capital, the Buenos Aires and Rosario line northward to Tucumán, where it connects with the government line to Salta, Jujuy and the Bolivian frontier, the Central Argentine line westward to Cordoba, with connexions at Villa María for Mendoza and the Chilean frontier, and two narrow-gauge lines, one running to Santa Fé and the other to Cordoba. The port of Rosario has hitherto consisted of a deep river anchorage and wooden wharves on the lower bank for the accommodation of steamers. Since 1902 work has been in progress under a contract with a French company for the construction of 12,697 ft. of quays, 23 m. of railway tracks along the quays to connect with the several railways entering the city, drawbridges, roadways, sheds, depots, elevator, offices, electric plant, fixed and movable cranes, and other appliances, &c., for the handling of produce and merchandise. The trade of the port was officially valued at 21,276,672 Arg. gold dollars imports, and 68,503,231 gold dollars exports in 1905.

Rosario was founded in 1730 by Francisco Godoy, but it grew so slowly that it was still a small village up to the middle of the 19th century. In 1854 General Justo José de Urquiza, then at the head of the Argentine Confederation, made it the port of the ten inland provinces then at war with Buenos Aires, and in 1857 imposed differential duties on the cargoes of vessels first breaking bulk at the southern port. This gave Rosario

a start, and its trade and population have grown since then with great rapidity.

ROSARY (Lat. *rosarium*), a popular devotion of the Roman Catholic Church, consisting of 15 Paternosters and Glorias and 150 Aves, recited on beads. It is divided into three parts, each containing five decades, a decade comprising 1 Pater, 10 Aves and a Gloria, in addition to a subject for meditation selected from the "mysteries" of the life of Christ and of the Blessed Virgin. The Christian practice of repeating prayers is traceable to early times: Sozomen mentions (*H. E. v. 29*) the hermit Paul of the 4th century who threw away a pebble as he recited each of his 300 daily prayers; and a canon of the English synod of Cealchythe in 816 (Mansi xiv. 360) directed *septem belidum Paternoster* to be said for a deceased bishop. In many orders the lay brothers daily said a large number of Paternosters instead of reading the breviary; it was natural that the Paternoster should be the prayer most often repeated. The Ave Maria is first mentioned as a form of prayer in the second half of the 11th century, but it was not until the 16th century that it became general in its present form. It is not known precisely when the mechanical device of the rosary was first used. William of Malmesbury (*De gest. pont. Angl. iv. 4*) says that Godiva, who founded a religious house at Coventry in 1040, left a string of jewels, on which she had told her prayers, that it might be hung on the statue of the Blessed Virgin. Thomas of Chantimpré, who wrote about the middle of the 13th century, first mentions the word "rosary" (*De apibus*, ii. 13), using it apparently in a mystical sense as Mary's rose-garden. There is no contemporary confirmation of the story that the rosary was given to St Dominic through revelation of the Blessed Virgin and was employed during the crusade against the Albigenses, although the story was later accepted by Leo X., Pius V., Gregory XIII., Sixtus V., Alexander VII., Innocent XII. and Clement XI. According to Benedict XIV. (*De Fest. 160*), the belief rests on the tradition of the Dominican order. Whatever may have been the origin of the rosary, the Dominicans did much to propagate the devotion. The practice of meditating on the mysteries doubtless began with a Dominican, Alanus de Rupe (born 1428), and another Dominican, Jacob Sprenger (d. 1495), grand-inquisitor in Germany, founded the first confraternity of the rosary at Cologne in 1475. This society spread rapidly, and was specially privileged by Sixtus IV., Innocent VIII. and Leo X. After the battle of Lepanto (1st Sunday in October 1571), which was won while the members of the confraternity at Rome were making supplication for Christian success, Pius V. ordered an annual commemoration of "St Mary of Victory," and Gregory XIII., by bull of the 1st of April 1583, set aside the 1st Sunday in October as the feast of the Rosary of the Blessed Virgin Mary, to be observed in such churches as maintained an altar in honour of the rosary. Clement XI., by bull of the 3rd of October 1716, directed the observance of the feast by all Christendom. The devotion has been particularly fostered by the Jesuits, St Ignatius Loyola having expressly ordered its use. It has been repeatedly indulged by various popes. Leo XIII. issued eight encyclicals on the devotion; he urged its recitation throughout October, and directed (1883) the insertion of the title *regina sacratissimi rosarii* in the Litany. There are several varieties of the rosary more or less in use by Roman Catholics: the Passionists, or rosary of the five wounds, approved by Leo XII. in 1823; the Crown of Our Lord, attributed to Michael of Florence, a Camaldolese monk (c. 1516), and consisting of 33 Paters, 5 Aves and a Credo; St Bridget's, 7 Paters and 63 Aves, in honour of the joys and sorrows of the Blessed Virgin and the 63 years of her life. The Living Rosary, in which 15 persons unite to say the rosary every month, was approved by Gregory XVI. (1832) and placed in charge of the Dominican order by Pius IX. (1877).

Similar expedients to assist the memory in repetitions of prayers occur among Buddhists and Mahomedans: in the former case the prayers are said on a string of some hundred beads, called the *libel-pren-ba* or the *ten-wo*; in the latter case,

the so-called *tasbih* has 33, 66 or 99 beads, and is used for the repetition of the 99 names which express the attributes of God.

See the critical dissertation in the *Acta sanctorum*, Aug. 1, 422 sqq.; Quetif and Echart, *Script. Ord. Praed.* i. 411 sqq.; Benedict XIV. olim Prospero de Lambertini, *De festis B.V.M.* i. 170 sqq.; H. Holzapfel, O.F.M., *St Dominikus u. der Rosenkranz* (Munich, 1903); vrom hl. *Rosenkranz-Büchel* (Trier, 1885); D. Dahm, *Die Bruderschaft vom hl. Rosenkranz* (Trier, 1902). For the indulgences attached to the devotion consult Beringer, S.J., *Die Abässe*, 11th ed. 292 ff. 354 ff. (Paderborn, 1895). For the corresponding devotion among Buddhists, consult Waddell, *The Buddhism of Tibet, or Lamaism* (London, 1895), and an article by Monier Williams in the *Athenaeum*, 9th of Feb. 1878; for that of the Mahomedans, see L. Petit, *Les Conférences musulmanes* (Paris, 1899), and E. Arnold, *Pearls of the Faith, or Islam's Rosary* (London, 1882). There is an excellent article, "Rosenkranz," by Zöckler in Herzog-Hauck, *Realencyklopädie*, 3rd ed. vol. 17, pp. 144-50. (C. H. Ha.)

ROSAS, JUAN MANUEL (1793-1877), tyrant of Buenos Aires, was born on the 30th of March 1793, in the city of that name. His father, Leon Ortiz de Rosas, was an owner of cattle runs (*estancias*) and a trader in hides, who took an active part in defeating the English attack on the city in 1807. Juan Rosas received so little education that he had to learn to read and write when he was already a married man and a successful cattle breeder. From a very early age he was left in charge of one of his father's establishments. When he was eighteen he married Maria de la Encarnacion Escurrea. His mother having suspected him of appropriating money, he left his parents, and for some time subsisted by working as a *vaquero* or cowboy, and then as overseer on the estates of other owners; but he accumulated money, and by the help of a loan from a friend he became possessed of a cattle run of his own, Los Cerrillos. The anarchical state of the country since its independence of Spain had favoured the Indians, who had taken the offensive and raided up to within forty miles of Buenos Aires. Rosas obtained leave to arm his cowboys. Under his management Los Cerrillos became a refuge for adventurers, whom he paid and fed well, but from whom he exacted implicit obedience. His followers became a fighting force of acknowledged efficiency, and Rosas took practically the position of an independent ruler whose help was sought by contending political parties. By attending to his own interest only, and by astute intrigue, or savage fighting when necessary, he grew in power from 1820 onwards, and from 1835 to 1852 ruled as dictator (see ARGENTINA). It is probable that he would have continued to govern in Buenos Aires till his death if his ambition had not led him into wars with all his neighbours. He wished to extend the authority of the Republic over all the territory which had belonged to the Spanish viceroyalty of Buenos. This led him directly into wars with Uruguay, Paraguay and Chile, and into "warlike operations" with England and France, with whom he had other causes of quarrel arising out of the complaints of traders and bondholders. His government was overthrown in 1852 by a coalition of his neighbours and the defection of several of his generals, and even members of his own family who lived in fear of his suspicions and violence. He took refuge in England, and lived at Swaythling, near Southampton, till his death on the 14th of March 1877. A portrait taken in 1834 and reproduced by Sir Woodbine Parish in his *Buenos Ayres and Provinces of the Rio de la Plata* (London, 1852) represents Rosas as a fine-looking man of the handsome Spanish type.

See O. Martens, *Ein Caligula unseres Jahrhunderts* (Berlin, 1896), which contains a full bibliography.

ROSCELLINUS (RUCELINUS, or ROUSSELIN) (c. 1050-c. 1122), often called the founder of Nominalism (see SCHOLASTICISM), was born at Compiègne (Compendium). Little is known of his life, and our knowledge of his doctrines is mainly derived from Anselm, Abelard and John of Salisbury. He studied at Soissons and Reims, was afterwards attached to the cathedral of Chartres, and became canon of Compiègne. It seems most probable that Roscellinus was not strictly the first to promulgate nominalistic doctrines; but in his exposition they received more definite expression, and, being applied to the dogma of the Trinity, attracted universal attention. Roscellinus maintained that it

is merely a habit of speech which prevents our speaking of the three persons as three substances or three Gods. If it were otherwise, and the three persons were really one substance or thing (*una res*), we should be forced to admit that the Father and the Holy Spirit became incarnate along with the Son. Roscellinus seems to have put forward this doctrine in perfect good faith, and to have claimed for it at first the authority of Lanfranc and Anselm. In 1092, however, a council convoked by the archbishop of Reims condemned his interpretation, and Roscellinus, who was in danger of being stoned to death by the orthodox populace, recanted his error. He fled to England, but having made himself unpopular by an attack on the doctrines of Anselm, he left the country and repaired to Rome, where he was well received and became reconciled to the Church. He then returned to France, taught at Tours and Loc-menach (Loches) in Brittany (where he had Abelard as a pupil), and finally became canon of Besançon. He is heard of as late as 1121, when he came forward to oppose Abelard's views on the Trinity.

Of the writings of Roscellinus, nothing is preserved except a letter to Abelard, mainly concerned with the doctrine of the Trinity (ed. J. A. Schmeller, Munich, 1850). See F. Picaret, *Roscellin, philosophe et théologien* (1896), and authorities quoted under SCHOLASTICISM.

ROSCHEER, WILHELM GEORG FRIEDRICH (1817-1894), German economist, was born at Hanover on the 21st of October 1817. He studied at Göttingen and Berlin, and obtained a professorship at Göttingen in 1844 and subsequently at Leipzig in 1848. Omitting preparatory indications and undeveloped germs of doctrine, the origin of the "historical" school of political economy may be traced to Roscher. Its fundamental principles are dated, though with some hesitation, and with an unfortunate contrast of the historical with the philosophical method, in his *Grundriss zu Vorlesungen über die Staatswirtschaft nach geschichtlicher Methode* (1843). This short study was afterwards expanded into his great *System der Volkswirtschaft*, published in five volumes between 1854 and 1894, and arranged as follows: vol. i., *Die Grundlagen der Nationalökonomie*, 1854 (trans. by J. J. Lalor, *Principles of Political Economy*, Chicago, 1878); vol. ii., *Die Nationalökonomie des Ackerbaus und der verwandten Urproduktionszweige*, 1859; vol. iii., *Die Nationalökonomie des Handels und Gewerbetreibens*, 1881; vol. iv., *System der Finanzwissenschaft*, 1886; vol. v., *System der Armenpflege und Armenpolitik*, 1894. His *Geschichte der Nationalökonomie in Deutschland* (1874) is a monumental work. He also published in 1842 an excellent commentary on the life and works of Thucydides. He died at Leipzig on the 4th of June 1894.

See T. Roscher, *Zur Geschichte der Familie Roscher in Niedersachsen* (Hanover, 1892); Brasch, *Wilhelm Roscher und die sozialwissenschaftlichen Strömungen der Gegenwart* (Leipzig, 1895).

ROSCIUS GALLUS, QUINTUS (c. 126-62 B.C.), Roman actor, was born, a slave, at Solonium, near Lanuvium. Endowed with a handsome face and manly figure, he studied the delivery and gestures of the most distinguished advocates in the Forum, especially Q. Hortensius, and won universal praise for his grace and elegance on the stage. He especially excelled in comedy. Cicero took lessons from him. The two often engaged in friendly rivalry to try whether the orator or the actor could express a thought or emotion with the greater effect, and Roscius wrote a treatise in which he compared acting and oratory. Q. Lutatius Catulus composed a quatrain in his honour, and the dictator Sulla presented him with a gold ring, the badge of the equestrian order, a remarkable distinction for an actor in Rome, where the profession was held in contempt. Like his contemporary Aesopus, Roscius amassed a large fortune, and he appears to have retired from the stage some time before his death. In 76 B.C. he was sued by C. Fannius Chaerea for 50,000 sesterces (about £400), and was defended by Cicero in a famous speech.

See H. H. Pflüger, *Cicero's Rede pro Q. Roscio Comoedo* (1904).

ROSCOE, SIR HENRY ENFIELD (1833-), English chemist, was born in London on the 7th of January 1833. After

studying at Liverpool High School and University College, London, he went to Heidelberg to work under R. W. Bunsen, of whom he became a lifelong friend. In 1857 he was appointed to the chair of chemistry at Owens College, Manchester, where he remained for thirty years, and from 1885 to 1895 he was M.P. for the south division of Manchester. He served on several royal commissions appointed to consider educational questions, in which he was keenly interested, and from 1896 to 1902 was vice-chancellor of London University. He was knighted in 1884. His scientific work includes a memorable series of researches carried out with Bunsen between 1855 and 1862, in which they laid the foundations of comparative photochemistry. In 1867 he began an elaborate investigation of vanadium and its compounds, and devised a process for preparing it pure in the metallic state, at the same time showing that the substance which had previously passed for the metal was contaminated with oxygen and nitrogen. He was also the author of researches on niobium, tungsten, uranium, perchloric acid, the solubility of ammonia, &c. His publications include, besides several elementary books on chemistry which have had a wide circulation and been translated into many foreign languages, *Lectures on Spectrum Analysis* (1860); *A Treatise on Chemistry* (the first edition of which appeared in 1877-1892); *A New View of Dalton's Atomic Theory*, with Dr A. Harden (1896); and an *Autobiography* (1906). The *Treatise on Chemistry*, written in collaboration with Carl Schorlemmer (1834-1892), who was appointed his private assistant at Manchester in 1859, official assistant in the laboratory in 1861, and professor of organic chemistry in 1874, is a standard work.

ROSCOE, WILLIAM (1753-1831), English historian and miscellaneous writer, was born on the 8th of March 1753 at Liverpool, where his father, who was a market gardener, kept a publichouse known as the Bowling Green at Mount Pleasant. Roscoe was eager in the acquisition of knowledge, and at twelve he left school, having learned all that his schoolmaster could teach. He now assisted his father in the work of the garden, and gave his leisure hours to reading and study. "This mode of life," he says, "gave health and vigour to my body, and amusement and instruction to my mind; and to this day I well remember the delicious sleep which succeeded my labours, from which I was again called at an early hour. If I were now asked whom I consider to be the happiest of the human race, I should answer, those who cultivate the earth by their own hands." At fifteen it was necessary to decide upon a path in life. A month's trial of bookselling sufficed to disgust him, and in 1769 he was articulated to a solicitor. Although a diligent student of law, he did not bid farewell to the Muses, but continued to read the classics, and made that acquaintance with the language and literature of Italy which became the instrument of his distinction in after life. He wrote many verses: his *Mount Pleasant* was composed when he was sixteen, and this and other verses, though now forgotten, won the esteem of good critics. In 1774 he commenced business as an attorney, and as soon as his professional gains warranted he married (1781) Jane, second daughter of William Griffies, a Liverpool tradesman, and had seven sons and three daughters. He had the courage to denounce the African slave trade in his native town, where not a little of the wealth came from this source. He wrote the *Wrongs of Africa* (1787-1788), and entered into a controversy with an ex-Roman Catholic priest, who undertook to prove the "liciteness of the slave trade" from the Bible. Roscoe was also a political pamphleteer, and like many other Liberals of the day hailed the promise of liberty in the French Revolution.

Meanwhile he had steadily pursued his Italian studies, and had made extensive collections relating to the great ruler of Florence. The result was his *Life of Lorenzo de' Medici*, which appeared in 1796, and at once placed him in the front rank of contemporary historians. The work has often been reprinted, and translations in French, German and other languages show that its popularity was not confined to its author's native land. Perhaps the most gratifying testimony was that of Fabroni,

who had intended to translate his own Latin life of Lorenzo, but abandoned the design and induced Gaetano Mecherini to undertake an Italian version of Roscoe. In 1796 Roscoe gave up practice as an attorney, and had some thought of going to the bar, but relinquished the idea after keeping a single term. Between 1793 and 1800 he paid much attention to agriculture, and helped to reclaim Chat Moss, near Manchester. He also succeeded in restoring to good order the affairs of a banking house in which his friend William Clark, then resident in Italy, was a partner. This task led to his introduction to the business, which eventually proved disastrous. His translation of Tansillo's *Nurse* appeared in 1798, and went through several editions. It is dedicated in a sonnet to his wife, who had practised the precepts of the Italian poet.

The Life and Pontificate of Leo the Tenth appeared in 1805, and was a natural sequel to that by which he had made his reputation. The work, whilst it maintained its author's fame, did not, on the whole, meet with so favourable a reception as the *Life of Lorenzo*. It has been frequently reprinted, and the insertion of the Italian translation in the *Index* did not prevent its circulation even in the papal states. Roscoe was elected member of parliament for Liverpool in 1806, but the House of Commons was not a congenial place, and at the dissolution in the following year he declined to be again a candidate. The commercial troubles of 1816 brought into difficulties the banking house with which he was connected, and forced the sale of his collection of books and pictures. It was on this occasion that he wrote the fine "Sonnet on Parting with his Books." Dr S. H. Spiker, the king of Prussia's librarian, gives an interesting account of a visit to Roscoe at this period of trouble. Roscoe said he still desired to write a biography of Erasmus but "wanted both leisure and youth." This project was not executed (Spiker's *Travels through England, &c.*, 1816). After a five years' struggle to discharge the liabilities of the bank, the action of a small number of creditors forced the partners into bankruptcy in 1820. For a time Roscoe was in danger of arrest, but ultimately he received honourable discharge. On the dispersal of his library, the volumes most useful to him were secured by friends and placed in the Liverpool Athenaeum. The sum of £2500 was also invested for his benefit. The independent and sensitive nature of Roscoe made both these operations difficult. Having now resigned commercial pursuits entirely, he found a pleasant task in the arrangement of the great library at Holkham, the property of his friend Coke. In 1822 he issued an appendix of illustrations to his *Lorenzo* and also a *Memoir of Richard Robert Jones of Aberdaron*, a remarkable self-taught linguist. The year 1824 was memorable for the death of his wife and the publication of his edition of the works of Pope, which involved him in a controversy with Bowles. His versatility was shown by the appearance of a folio monograph on the *Monandrian Plants*, which was published in 1828. It appeared first in numbers, and the last part came out after his recovery from a paralytic attack. He died on the 30th of June 1831.

Roscoe's character was a fine one. Under circumstances uncongenial and discouraging he steadfastly maintained the ideal of the intellectual life. Sensitive and conscientious, he sacrificed his possessions to a punctilious sense of duty. He had the courage of unpopular opinions, and, whilst promoting every good object in his native town, did not hesitate to speak out where plain dealing, as in the matter of slavery, was required. He was a sincere friend and exemplary in his domestic relations. Posterity is not likely to endorse the verdict of Horace Walpole, who thought Roscoe "by far the best of our historians," but in spite of newer lights and of some changes of fashion in the world of letters, his books on Lorenzo de' Medici and Leo X. remain important contributions to historical literature.

In addition to the writings already named, Roscoe wrote tracts on penal jurisprudence, and contributed to the *Transactions* of the Royal Society of Literature and of the Linnean Society. The first collected edition of his *Poetical Works* was published in 1857, and

is sadly incomplete, omitting, with other verses known to be from his pen, the *Butterfly's Ball*, a fantasy, which has charmed thousands of children since it appeared in 1807. Other verses are in *Poems for Youth*, by a *Family Circle* (1820).

The *Life* by his son Henry Roscoe (2 vols., London, 1833) contains full details of Roscoe's career, and there are references to him in the *Autobiographical Sketches of De Quincey*, and in Washington Irving's *Sketch Book*. (W. E. A. A.)

ROSCOFF, a maritime town and watering-place of north-western France, in the department of Finistère, on the English Channel, 17½ m. N.N.W. of Morlaix by rail. Pop. (1906) town, 1984; commune, 5054. Roscoff, separated from the Ile de Batz by a narrow channel, has a tidal port used by fishing and coasting vessels. Many of the inhabitants are engaged in the cultivation of early vegetables, to the growth of which the mild climate and fertile soil is eminently favourable. The church of Roscoff (16th century) has a fine Renaissance tower and contains interesting alabaster bas-reliefs. The ruined chapel of St Ninian commemorates the landing at Roscoff in 1548 of Mary Stuart, previous to her betrothal with the dauphin, son of Henry II. In 1746 Charles Edward, the young Pretender, landed at the port after his defeat at Culloden.

ROSCOMMON, WENTWORTH DILLON, 4TH EARL OF (c. 1630-1685), English poet, was born in Ireland about 1630. He was a nephew of Thomas Wentworth, earl of Strafford, and was educated partly under a tutor at his uncle's seat in Yorkshire, partly at Caen in Normandy and partly at Rome. After the Restoration he returned to England, and was well received at court. In 1649 he had succeeded to the earldom of Roscommon, which had been created in 1622 for his great-grandfather, James Dillon; and he was now put in possession by act of parliament of all the lands possessed by his family before the Civil War. As captain of the Gentleman Pensioners he found abundant opportunity to indulge the love of gambling, which appears to have been his only vice. Disputes with the Lord Privy Seal about his Irish estates necessitated his presence in Ireland, where he gave proof of some business capacity. On his return to London he was made master of the horse to the duchess of York. He was twice married, in 1662 to Lady Frances Boyle, widow of Colonel Francis Courtenay, and in 1674 to Isabella Boynton.

His reputation as a didactic writer and critic rests on his blank verse translation of the *Ars Poetica* (1680) and his *Essay on Translated Verse* (1684). The essay contained the first definite enunciation of the principles of "poetic diction," which were to be fully developed in the reign of Queen Anne. Roscommon, who was fastidious in his notions of "dignified writing," was himself a very correct writer, and quite free from the indecencies of his contemporaries. Alexander Pope, who seems to have learnt something from his carefully balanced phrases and the regular cadence of his verse, says that "In all Charles's days, Roscommon only boasts unspotted bays." He saw clearly that a low code of morals was necessarily followed by a corresponding degradation in literature, and he insists that sincerity and sympathy with the subject in hand are essential qualities in the poet. This elevated conception of his art is in itself no small merit. He has, moreover, the distinction of having been the first critic to avow his admiration for *Paradise Lost*. Roscommon formed a small literary society which he hoped to develop into an academy with authority to formulate rules on language and style, but its influence only extended to a limited circle, and the scheme fell through after its promoter's death. He was buried in Westminster Abbey on the 21st of January 1685.

The title passed to his uncle, **Carey Dillon** (1627-1680). In 1746, on the death of James, the 8th earl, it passed to Robert Dillon (d. 1770), a descendant of the first earl. His family became extinct in 1816, and in 1828 Michael James Robert Dillon, another descendant of the 1st earl, established his title to the earldom before the House of Lords. When he died in May 1850 it became extinct.

Roscommon's poems were collected in 1701, and are included in Anderson's and other collections of the British poets. He also translated into French from the English of Dr W. Sherlock, *Traité touchant l'obéissance passive* (1686).

ROSCOMMON, a county of Ireland in the province of Connaught, bounded N.E. by Leitrim, N.W. by Sligo, W. by Mayo, W. and S. by Galway, E. by Longford and E. and S. by Westmeath and King's County. The area is 629,633 acres, or about 985 sq. m. The greater part of the county belongs to the great limestone plain of central Ireland, and is either flat or very slightly undulating. In the north-east, on the Leitrim border, the Braulieve Mountains, consisting of rugged and precipitous ridges with flattened summits, attain an elevation in Cashel Mountain of 1377 ft.; and in the north-west the Curlew Mountains, of similar formation, between Roscommon and Sligo, rise abruptly to a height over 800 ft. In the east the Slievebane range, formed of sandstone, have a similar elevation. The Shannon with its expansions forms nearly the whole eastern boundary of the county, and on the west the Suck from Mayo forms for over 50 m. the boundary with Galway till it unites with the Shannon at Shannon Bridge. The other tributaries of the Shannon within the county are the Arigna, the Feerish and the Boyle. The lakes formed by expansions of the Shannon on the borders of Co. Roscommon are Loughs Allen, Boderg, Boffin, Forbes and Ree. Of the numerous other lakes within the county the most important are Lough Key in the north, very picturesquely situated with finely wooded banks, and Lough Gara (mostly in Co. Sligo) in the north-west.

In this long county one may travel fifty miles across the Carboniferous Limestone plain, with the grey rock cropping out here and there, and long grass-covered esker-ridges forming the only obstacle to the roads. Lough Ree is a typical lake of the plain. Two inliers of Silurian rocks have been thrust up, forming hills between Lough Ree and Lough Boffin. At Boyle, however, higher Old Red Sandstone country is encountered, and farther north the Millstone Grit and Coal-Measure series cap the mountains almost horizontally at Arigna near Lough Allen. The nodules of clay-ironstone here were formerly smelted, and the seams of bituminous coal, mostly on Millstone Grit horizons, are worked successfully on a high level of the mountains.

The subsoil is principally limestone, but there is some light, sandy soil in the south. In the level parts the land when drained and properly cultivated is very fertile, especially in the district known as the plains of Boyle, which includes some of the richest grazing land in Ireland. Along the banks of the Suck and Shannon there is, however, a large extent of bog and marsh. The proportion of tillage to pasture is roughly as one to three. Oats and potatoes are the principal crops, but the acreage devoted to them decreases; the numbers of cattle, sheep, pigs, goats and poultry, on the other hand, are proportionately large and increasing. Communications are afforded by the Midland Great Western railway, the Sligo line of that system crossing the northern part of the county by Boyle, the Athlone and Mayo line passing from S.E. to N.W. by the towns of Roscommon and Castlereagh, and the Athlone and Galway line crossing the southern part.

The population was 116,552 in 1891, and 101,791 in 1901; 97% are Roman Catholics, and nearly the whole population is rural. The chief towns are Boyle, Roscommon, Elphin and Castlereagh; and a small portion of Carrick-on-Shannon, including the railway station, is in this county, the major portion being in Co. Leitrim. The county is divided into ten baronies. Ecclesiastically it belongs to the Protestant dioceses of Elphin and Ardagh (united with Kilmore and Tuam), and to the Roman Catholic dioceses of Tuam, Clonfert, Achonry, Elphin and Ardagh. Assizes are held at Roscommon and quarter sessions at Boyle, Strokestown and Roscommon. The county returns two members to parliament. To the Irish parliament before the Union of 1800 two members were returned for the county, and two each for the boroughs of Boyle, Roscommon and Tulsak.

The district was granted by Henry III. to Richard de Burgo, but remained almost wholly in the possession of the native sept. Until the time of Elizabeth Connaught was included in the two districts of Roscommon and Clare, but in 1570 it

was further subdivided by Sir Henry Sydney, and was assigned its present limits. All the old proprietors were dispossessed at the Cromwellian settlement, except the O'Connor family headed by the O'Connor Don. The most interesting antiquarian remains within the county are the ruins of Crogan, the ancient palace of the kings of Connaught. The principal ancient castles are the old stronghold of the M'Dermotts on Castle Island, Lough Key, the dismantled castle of the M'Donoughs at Ballinafad, and the extensive fortress at Roscommon rebuilt by John d'Ufford, justiciary of Ireland in 1268. There are fragments of a round tower at Oran. The abbey of Boyle is in remarkably good preservation, and exhibits fine specimens of the Norman arch. The other monastic remains within the county, with the exception of the abbey of Roscommon, are of comparatively small importance. The Irish baron Carolan, who died in 1738, is buried by the ruined church of Kilonran, in the extreme north of the county. The bishopric of Elphin was united with Kilmore and Ardagh in 1833, and the former cathedral and episcopal buildings are largely modernized.

ROSCOMMON, a market town and the county town of Co. Roscommon, Ireland, situated on rising ground in a bare plain in the centre of the county, on the Mayo line of the Midland Great Western railway, 18½ m. N.W. by N. from Athlone. Pop. (1901) 1891. It contains the county buildings, and has Protestant and Roman Catholic churches, the latter of which is a fine building completed in 1903. An extensive trade is carried on in agricultural produce and live stock. A castle, dating from 1268, when it was founded by John d'Ufford, justiciary of Ireland, stands, an imposing mass of ruins, but far gone in decay, overlooking the plain. It fell to besiegers in 1566, 1642 and 1652, and was partially burned after the battle of Aughrim in 1691. There are also remains of a Dominican priory of the middle of the 13th century, founded by Felim O'Connor, king of Connaught, and exhibiting fine, though mutilated, details of the style of that period. The name of the town, signifying St Coman's wood, is derived from the saint who founded the monastery of Canons Regular here in the 6th century. The town received charters from Edward I. and James I. Two m. N.E. are small remains of the abbey of Deerane.

ROSCEA, a market town near the north-western border of Co. Tipperary, Ireland, pleasantly situated on undulating ground connecting the Devil's Bit and the Slieve Bloom mountains. Pop. (1901) 2325. It is 77 m. W.S.W. from Dublin on the Ballyboph and Limerick branch of the Great Southern & Western railway. A branch line runs northward to Birr or Parsonstown. Flour-milling and tanning are industries, and monthly cattle fairs are held. There is a branch here of the Trappist Monastery of Mount Mellary in Co. Waterford. The antiquarian remains are of interest. These include portions of an Augustinian abbey, founded by St Cronan, early in the 7th century, which are incorporated into the church. Out of this abbey a diocese grew, to be united with that of Killaloe in the 12th century. Here also was produced the *Book of Dimma*, consisting of the gospels and accompanied by a brass shrine, ornamented with silver and tracery, and preserved in the library of Trinity College, Dublin. A cross and a shrine of St Cronan are in the churchyard. There are also a round tower, 80 ft. in height, but lacking the upper storeys, and a Franciscan friary (1490); while a circular tower, and a square keep (occupied as barracks), mark strongholds, the one built by King John and the other by the Ormondes, and testify to the former importance of the town, which was doubtless accentuated by its physical position in a passway between the neighbouring mountain ranges. Leap Castle, about 4 m. N., is another fortified mansion, which is still inhabited.

ROSE, the name of a distinguished family of German chemists. VALENTINE ROSE the elder was born on the 16th of August 1736 at Neu-Ruppin, and died on the 28th of April 1771 at Berlin, where he was an apothecary and for a short time before his death assessor of the Ober Collegium Medicum. He was the discoverer of "Rose's fusible metal" (see FUSIBLE METAL). His son, VALENTINE ROSE the younger, born on the 31st of

October 1762 at Berlin, was also an apothecary in that city and assessor of the Ober Collegium Medicum from 1797. It was he who in 1800 proved that sulphuric ether contains no sulphur. He died in Berlin on the 10th of August 1807, leaving four sons, one of whom, Heinrich, was a distinguished chemist, and another, Gustav, a crystallographer and mineralogist. HEINRICH ROSE, born at Berlin on the 6th of August 1795, began to learn pharmacy in Danzig, where, during the siege of 1807, he nearly lost his life from typhus. Like his brother he served in the campaign of 1815. During the summer of the following year he studied at Berlin under M. H. Klaproth, a devoted friend of the family, and in the autumn entered a pharmacy at Mitau. In 1819 he went to Stockholm, where he spent a year and a half with J. J. Berzelius, and in 1821 he graduated at Kiel. Returning to Berlin he became a *Privatdozent* in the university in 1822, extraordinary professor of chemistry in 1823 and ordinary professor in 1835, and there he died on the 27th of January 1864. He devoted himself especially to inorganic chemistry and the development of analytical methods, and the results of his work are summed up in the successive issues of his classical work, *Ausführliches Handbuch der analytischen Chemie*, of which he published the first edition at Berlin in 1829, and the sixth, practically a new work in French, at Paris in 1861. He was the discoverer of antimony pentachloride, and mention may also be made of his researches on the influence of the mass-action of water in many reactions, carried out before the investigations of Guldberg and Waage in 1867. GUSTAV ROSE, born at Berlin on the 18th of March 1798, began his career as a mining engineer, but soon turned his attention to theoretical studies. A pupil of Berzelius like his brother, he graduated in 1820 at Berlin University where he became successively *Privatdozent* (1823), extraordinary professor of mineralogy (1826) and ordinary professor (1839). In 1856 he succeeded to the directorship of the Royal Mineralogical Museum at Berlin, and he helped to found the German Geological Society, of which he was president from 1863 until the end of his life. He made many journeys in different parts of Europe for the sake of mineralogical study, and in 1829 with A. von Humboldt and C. G. Ehrenberg (1795-1876), professor of medicine at Berlin, took part in an expedition to the Ural and Altai mountains and the Caspian Sea, which yielded information of primary importance concerning the mineralogy of the Russian Empire. His work covered every branch of mineralogy, including crystallography and the artificial formation of minerals. The science of petrography, according to Gerhard vom Rath, originated with him. He was the first in his own country to use the reflecting goniometer for the measurement of the angles of crystals, and to teach the method of studying rocks by means of microscopic sections. He also devoted special attention to meteorites and to the problem presented by the different structure of the stony matter in them and in the crust of the earth, and just before his death, which took place at Berlin on the 15th of July 1873, he was engaged in investigating the formation of the diamond. In addition to many scientific memoirs he published *Elemente der Kristallographie* (1830); *Mineralogisch-geognostische Reise nach dem Ural, dem Altai und dem Kaspische Meere* (1837) vol. i.; (1842) vol. ii.; *Das Kristallo-chemische Mineral-system* (1852); and *Beschreibung und Eintheilung der Meteoriten* (1863).

ROSE, GEORGE (1744-1818), British politician, was born on the 17th of June 1744, and was educated at Westminster school, afterwards entering the navy, a service which he left in 1762 after he had taken part in some fighting in the West Indies. He then obtained a position in the Civil Service, becoming joint keeper of the records in 1772 and secretary to the board of taxes in 1777. In 1782 he gave up the latter appointment to become one of the secretaries to the treasury under Lord Shelburne, though he did not enter parliament. He left office with his colleagues in April 1783, but in the following December he returned to his former position at the treasury in Pitt's ministry, being henceforward one of this minister's most steadfast supporters. He entered parliament as member for Launceston

early in 1784, and his fidelity and friendship were rewarded by Pitt, who gave him a lucrative post in the court of exchequer; in 1788 he became clerk of the parliaments. In 1801 Rose left office with Pitt, but returned with him to power in 1804, when he was made vice-president of the committee on trade and joint paymaster-general. He resigned these offices a few days after Pitt's death in 1806, but he served as vice-president of the committee on trade and treasurer of the navy under the duke of Portland and Spencer Perceval from 1807 to 1812. He was again treasurer of the navy under Lord Liverpool, and he was still member of parliament for Christchurch, a seat which he had held since 1790, when he died at Cuffnells, in Hampshire, on the 13th of January 1818. Rose was an able and conscientious public servant, although he and his two sons drew a large amount of money from sinecures, a fact referred to by William Cobbett in his "A New Year's Gift to old George Rose." He wrote several books on economic subjects, and his *Diaries and Correspondence*, edited by the Rev. L. V. Harcourt, was published in 1860.

His elder son, Sir George Henry Rose (1771-1855), was in parliament from 1794 to 1813, and again from 1818 to 1844, and in the meantime he was British minister at Munich and at Berlin; in 1818 he succeeded his father as clerk of the parliaments. He was the father of Baron Strathairn (q.v.). The second son was the poet William Stewart Rose (q.v.).

ROSE, HUGH JAMES (1705-1838), English divine, was born at Little Horsted in Sussex on the 9th of June 1795, and was educated at Uckfield school and at Trinity College, Cambridge, where he graduated B.A. in 1817, but missed a fellowship. Taking orders, he was appointed to Buxted, Sussex, in 1819, and to the vicarage of Horsham in 1821. He had already attained some repute as a critic, which was enhanced when, after travelling in Germany, he delivered as select preacher at Cambridge, four addresses against rationalism, published in 1825 as *The State of the Protestant Religion in Germany*. The book was severely criticized in Germany, and in England by E. B. Pusey. In 1827 Rose was collated to the prebend of Middleton; in 1830 he accepted the rectory of Hadleigh, Suffolk, and in 1833 that of Fairstead, Essex, and in 1835 the perpetual curacy of St Thomas's, Southwark. In 1833-1834 he was professor of divinity at Durham, a post which ill-health forced him to resign. In 1836 he became editor of the *Encyclopaedia Metropolitana*, and he projected the *New General Biographical Dictionary*, a scheme carried through by his brother Henry John Rose (1800-1873). He was appointed principal of King's College, London, in October 1836, but he was attacked by influenza, and after two years of ill-health he died at Florence on the 22nd of December 1838. Rose was a high-churchman, who to propagate his views in 1832 founded the *British Magazine* and so came into touch with the leaders of the Oxford movement. Out of a conference at his rectory in Hadleigh came the Association of Friends of the Church, formed by R. H. Froude and Wm. Palmer.

See J. W. Burgon, *Lives of Twelve Good Men* (1891).

ROSE, WILLIAM STEWART (1775-1843), English poet and translator, second son of George Rose (q.v.), was born in 1775. He was educated at Eton College, and in 1796 was returned to parliament for the borough of Christchurch. In 1800 he accepted the Chiltern Hundreds on his appointment as reading clerk of the House of Lords and clerk of the private committees. His first work, *A Naval History of the Late War*, was undertaken at his father's wish, but he only completed one volume. He produced a free version of the *Amadis de Gaul* from the French text of Herberay des Essarts in 1803, followed by a translation of the *Partenopex de Blois* (1807) after Le Grand d'Aussy. With *Partenopex* he printed his ballad of "The Red King," and in 1810 appeared *The Crusade of King Louis and King Edward the Martyr*. In 1814 he made a prolonged journey through Italy and eastern Europe, spending the year 1817 at Venice, where he married a Venetian lady. *The Court and Parliament of Bees*, a translation of the *Animali Parlanti di Casti*, and *Letters from the North of Italy*, addressed to Henry

Hallam, Esq., appeared in 1819. In the same year the publisher Murray offered him £2000 for a translation of Ariosto (T. Moore, *Diary*, 14th of April 1819). He had already written an abridged version of Berni's *rifacimento of the Orlando Innamorato* of Bolardo, and had begun his *Orlando Furioso translated into English Verse* which appeared in two parts in 1823 and 1831. This, which has become the standard English version, is a close rendering in the *ottava rima* of the original. Rose retired from his official position in 1824. He suffered from paralysis in his later years, and at Abbotford, where he was an honoured guest, rooms were specially fitted up on the ground floor for his use. His last works were *An Epistle to the Right Honourable John Hookham Frere* (1834), in verse, and a volume of *Rhymes* (1837) (see *Quarterly Review*, July 1836 and April 1837). He died on the 30th of April 1843.

ROSE (*Rosa*). The rose has for all ages been the favourite flower, and as such it has a place in general literature that no other plant can rival. In most cases the rose of the poets and the rose of the botanist are one and the same in kind, but popular usage has attached the name rose to a variety of plants whose kinship to the true plant no botanist would for a moment admit. In this place we shall employ the word in its strict botanical significance, and in commenting on it treat it solely from the botanical point of view. The rose gives its name to the order Rosaceae, of which it may be considered the type. The genus consists of species varying in number, according to the diverse opinions of botanists of opposite schools, from thirty to one hundred and eighty, or even two hundred and fifty, exclusive of the many hundreds of mere garden varieties. While the lowest estimate is doubtless too low, the highest is enormously too large, but in any case the wide discrepancies above alluded to illustrate very forcibly the extreme variability of the plants, their adaptability to various conditions, and consequently their wide dispersion over the globe, the facility with which they are cultivated, and the readiness with which new varieties are continually being produced in gardens by the art of the hybridizer or the careful selection of the raiser. The species are natives of all parts of the northern hemisphere, but are scantily represented in the tropics unless at considerable elevations.

They are erect or climbing shrubs, never herbs or trees, generally more or less copiously provided with straight or hooked prickles of various shapes and with glandular hairs, as in the sweet-brier or in the moss-rose of gardens. The prickles serve the purpose of enabling the shrub to sustain itself amid other vegetation. The viscid hairs which are especially frequent on the flower stalks or in the neighbourhood of the flower serve to arrest the progress of undesirable visitants, while the perfume emitted by the glands in question may co-operate with the fragrance and colour of the flower to attract those insects whose presence is desirable. The leaves are invariably alternate, provided with stipules, and usually pinnate, the leaflets varying in number from one (as in *R. simplicifolia* or *herberti folia*) to 11 and even 15, the odd leaflets always being at the apex, the others in pairs. The flowers are solitary or in loose cymes (cluster-roses) produced on the ends of the shoots. The flower-stalk expands into a vase- or urn-shaped dilatation, called the receptacle or receptacular tube, which ultimately becomes fleshy and encloses in its cavity the numerous carpels or fruits. From the edge of the urn or "hip" proceed five sepals, often more or less compound like the leaves and overlapping in the bud. Within the sepals are five petals, generally broad or roundish in outline, with a very short stalk or none at all, and of very various shades of white, yellow or red. The very numerous stamens originate slightly above the sepals and petals; each has a slender filament and a small two-celled anther. The inner portion of the receptacular tube whence the stamens spring is thick and fleshy, and is occasionally spoken of as the "disk"; but, as in this case it does not represent any separate organ, it is better to avoid the use of the term. The carpels are very numerous, ultimately hard in texture, covered with hairs, and each provided with a long style and button-like stigma. The carpels are concealed within the receptacular tube and only the stigmas as a rule protrude from its mouth. Each carpel contains one ovule. The so-called fruit is merely the receptacular tube, which, as previously mentioned, becomes fleshy and brightly coloured as an attraction to birds, which devour the hips and thus secure the dispersion of the seed. The dry one-seeded fruits (achenes) are densely packed inside the hip, and are covered with stiff hairs which cling to the bird's beak. The stamens are in whorls, and, according to Payer, they originate in pairs one on each side of the base of

each petal so that there are ten in each row; a second row of ten alternates with the first, a third with the second, and so on. By repeated radial and tangential branching a vast number of stamens are ultimately produced, and when these stamens assume a petaloid aspect we have as a consequence the double flowers which are so much admired. The carpels are much less subject to this petaloid change, and, as it generally happens in the most double of roses that some few at least of the anthers are formed with pollen, the production of seed and the possibility of cross-breeding become intelligible. Under natural circumstances rose flowers do not secrete honey, the attraction for insects being provided by the colour and perfume and the abundance of pollen for food. The stigmas and anthers come to maturity at the same time, and thus, while cross-fertilization by insect agency is doubtless most common, self-fertilization is not prevented.

The large number of species, subspecies, varieties and forms described as British may be included under about a dozen species. Among them may be mentioned *R. spinosissima*, the Scotch rose, much less variable than the others; *R. rubiginosa* (or *R. eglanteria*), the sweet-brier, represented by several varieties; *R. canina*, the dog rose (see fig.), including



Dog Rose (*Rosa canina*) in flower and fruit.

numerous subspecies and varieties; the large-fruited apple rose, *R. pomifera*; and *R. arvensis*, the parent of the Ayshire roses. Cultivated roses are frequently "budded" or worked upon the stems of the brier or *R. canina*, or upon young seedling plants of the same species; and upon stems of an Italian rose called the Manetti, raised in the Milan Botanic Gardens about 1837. Other species, notably *R. polyantha*, also are used for stocks.

Roses have been grown for so many centuries and have been crossed and recrossed so often that it is difficult to refer the cultivated forms to their wild prototypes. The older roses doubtless originated from *R. gallica*, a native of central and southern Europe. *R. centifolia* (the cabbage rose), a native of the Caucasus, contributed its share. A cross between the two species named may have been the source whence originated the Bourbon roses. The yellow-flowered Austrian and Persian brier originated from *R. lutea*, a native of Austria and the East. The monthly or China roses sprang from the Chinese *R. indica*, and these, crossed with others of the *R. centifolia* or *gallica* type, are the source of the "hybrid perpetuals" so commonly grown nowadays, because, in addition to their other attractions, their blooming season is relatively prolonged, and, moreover, is repeated in the autumn. Tea roses and noisettes, it is to be presumed, also acknowledge *R. indica* as one of their progenitors. A magnificent race called "hybrid teas" have been evolved of late years, by crossing the tea roses and hybrid perpetuals. They are much more vigorous in constitution than the true tea roses, while quite as beautiful in blossom and more perpetual in bloom than the hybrid perpetuals. Recently, by crossing the Japanese *R. Wichuraiana* with hybrid perpetuals,

a beautiful and vigorous race of climbers has been produced. The Banksian rose is a Chinese climbing species, with small white or fawn-coloured flowers of great beauty, but rarely seen; the Macartney rose (*R. bracteata*) is also of Chinese origin. Its nearly evergreen deep green leaves and large white flowers are very striking. The Japanese *R. rugosa* is also a remarkable species, notable for its bold rugose foliage, its large white or pink flowers, and its conspicuous globular fruit. *R. damascena* is cultivated in some parts of the Balkans for the purpose of making attar of roses. In Germany the same variety of rose is used, while at Grasse a strain of the Provence rose is cultivated for the same purpose. In India *R. damascena* is grown largely near Ghazipur for the purpose of procuring attar of roses and rose water.

Rose water is chiefly produced in Europe from the Provence or cabbage rose, *R. centifolia*, grown for the purpose at Mitcham and much more abundantly in the south of France. Conserve of roses and infusion of roses, two medicinal preparations retained for their agreeable qualities rather than for any special virtue, are prepared from the petals of *R. gallica*, one variety of which was formerly grown for the purpose near the town of Provins. Conserve of dog rose is made from the ripe hips of the dog rose, *R. canina*. Its only use is in the manufacture of pills.

The rose is so universal a favourite that some portion of the garden must necessarily be devoted to it, if the situation be at all favourable. Many choice roses will not, however, thrive in the vicinity of large towns, since they require a pure air, and do not endure a smoky atmosphere. The best soil for them is a deep rich strong loam free from stagnant moisture. Very light sandy or gravelly soils, or soils which are clayey and badly drained, are not suitable, and both must be greatly improved if rose-growing on them is attempted. Light soils would be improved by a dressing of strong loam in conjunction with cow-dung or nightsoil; the latter, provided it is properly prepared and not too fresh, is indeed the very best manure for roses in all but soils which are naturally very rich. Heavy soils are improved by adding burned earth or gritty refuse, with stable manure and leaf-mould, peat moss litter, &c.; and damp soils must necessarily be drained by trenching. Tea roses may, however, be grown to perfection in a gravel soil, provided it be well manured, cow manure being best. Roses generally require a constant annual supply of manure, and, if this is given as a mulching in autumn, it serves to protect their roots through the winter. They also require liberal supplies of water during the growing season, unless the surface is mulched or top-dressed from time to time with well-rotted manure. Aphides and caterpillars of all kinds may be checked by syringing with dilute tobacco water or some of the many insecticides now provided to facilitate this rather troublesome task.

Some growers prefer roses grown on their own roots, some on the Manetti and others on the brier stock. There is this to be said in favour of their own roots that, if the tops are killed down by accident or by severe weather, the roots will usually throw up new shoots true to their kind, which cannot be looked for if they are worked; though it is sometimes recommended to plant deep in order that the rose itself may learn to do without its foster parent the stock. Heavy soils are improved by adding burned earth or gritty refuse, with stable manure and leaf-mould, peat moss litter, &c.; and damp soils must necessarily be drained by trenching. Tea roses, the choice rose dies, and the stock usurps its place. This is especially true of the Manetti stock, as its foliage is more like that of many cultivated forms than the brier, and therefore more easily overlooked. Where standards or half-standards are required, the brier stock from the hedges is always used. It forms the most reliable stock for dwarfs of all kinds, and especially for tea roses, most of which fall on the Manetti stock.

An open situation, not shaded but sheltered from strong winds, is what the rose prefers. October and November are the best months for planting roses, but if the weather be wet or frosty and the soil sticky, the plants should be placed in a sheltered place and protected by green boughs or matting until suitable conditions prevail. The planting should never be deep, the uppermost layer of roots being about 2 or 3 in. below the general level of the surface, and the soil should always be kept stirred with the hoe during the summer months. In regard to pruning, roses vary considerably, some requiring close cutting and others only thinning out; some again, such as strong growing climbers, may be safely pruned in autumn, and others are better left till spring. Instructions on this point as to the several groups of varieties will be found in most rose catalogues, and may be followed, provided the variety is true to name. It may be laid down as a general rule that the more strongly growing varieties should be less severely cut back than the weakly varieties; and, again, the more tender the variety, the later in the spring should the pruning be done, April being the best month for pruning teas and noisettes. It should be remembered also that no

amount of correct pruning will improve a rose bush that has been badly planted or placed in a quite unsuitable position.

Where dwarf beds of roses are required, a good plan is to peg down to within about 6 in. from the ground the strong one-year-old shoots from the root. In due time blooming shoots break out from nearly every eye, and masses of flowers are secured, while strong young shoots are thrown up from the centre, the plant being on its own roots. Before winter sets in, the old shoots which have thus flowered and exhausted themselves are cut away, and three or four or more of the strongest and best ripened young shoots are reserved for pegging down the following season, which should be done about February. In the meantime after the pruning has been effected, plenty of good manure should have been dug in lightly about the roots. Thus treated, the plants never fail to produce plenty of strong wood for pegging down each succeeding season.

The most troublesome fungoid pest of the rose is undoubtedly the mildew (*Sphaerotheca pannosa*). The young shoots, leaves and flower-buds frequently become covered with a delicate white mycelium, which by means of the suckers it sends into the underlying cells robs its host of considerable amounts of food, and causes the leaves to curl and fall early. The spores are produced in great abundance and carried by animals and the wind to other plants, and so the disease is rapidly spread. Later the mycelium increases and forms a thick velvety coating on the young shoots, and in this the winter state of the fungus is produced. Spraying with potassium sulphide (1 oz. to 2 to 3 gallons of water) is the best means of checking the spread of the disease. The rose rust (*Phragmidium subcorticatum*) appears on both cultivated and wild roses in the spring, bursting through the bark in the form of copious masses of orange powder consisting of the spores of the fungus. These spores infect the leaves, and produce on them in the summer small dots of an orange colour and, later, groups of spores that are able to live through the winter. The last of the spores, are of a dark colour, and it is by these that the disease is started in the spring. It is therefore important that all the affected leaves should be destroyed in the autumn, and the bushes should be sprayed with Bordeaux mixture or ammoniacal copper carbonate in the spring to prevent the infection of the leaves by spores brought from a distance. Many other fungi attack the rose, but perhaps the only other one that merits mention here is *Actinonema Rosae*. This attacks the leaves, forming large dark blotches upon them and frequently causing them to fall prematurely.

A very large number of insect pests are found upon the rose, but the best known and most formidable on account of their great powers of reproduction are the aphides. More than one species is found upon the rose, though *Aphis Rosae* is the commonest. Their attack should be checked by the use of a spray made by boiling 4 oz. quassia chips for an hour or so in a gallon of soft water, straining off the solution and dissolving therein 4 oz. of soft soap while it is still warm, afterwards adding 1 or 2 gallons of soft water according to the age of the rose leaves that are to be sprayed. Any delay in dealing with the pest gives the opportunity for its increase, even a day being sufficient materially to augment their numbers. The larvae of some of the *Tortrix* moths fold the leaves almost as soon as they are developed from the bud and do considerable damage in this way and by devouring the leaves, while several "looper" caterpillars are also found feeding on the foliage. Many species of saw-fly larvae are also known to attack the rose, feeding either upon the leaves or devouring the young shoot. These larvae should be carefully searched for and destroyed whenever found. One of the leaf-cutting bees, *Megachile*, cuts pieces out of the leaves with which to line its nest, materially reducing their effective surface. The bees may be caught in a butterfly net or traced to their nests, which should be destroyed.

For further information see the late Dean Hole's *Book about Roses* (1894); *Book of the Rose*, by Rev. A. Foster Mellis (1905); *Beautiful Roses for Garden and Greenhouse*, by J. Weathers (1902); and *Roses, their History, Development and Cultivation*, by the Rev. J. H. Pemberton (1908).

ROSEBERY, ARCHIBALD PHILIP PRIMROSE, 5TH EARL OF (1847-), British statesman, born in London on the 7th of May 1847, was the grandson and successor to the title of Archibald John Primrose, 4th earl of Rosebery (1783-1868), a representative peer of Scotland, who was in 1828 created a peer of the United Kingdom as Baron Rosebery, and was an active supporter of the Reform Bill. The Scottish earldom was first conferred in 1703 upon the 4th earl's great-grandfather, Archibald Primrose of Dalmeny (1664-1723), a staunch Whig and a commissioner for the Union. The 5th earl's mother was Catherine Lucy Wilhelmina, only daughter of Philip Henry, 4th Earl Stanhope; she was thus a sister of Earl Stanhope, the historian, and a niece of Lady Hester Stanhope, who was the niece of William Pitt. A celebrated beauty, a maid of honour and bridesmaid of Queen Victoria, she married, on the 20th of December 1843, Archibald, Lord Dalmeny (1809-1851),

member for the Stirling Burghs, who became a lord of the admiralty under Melbourne. After his death she became the wife of Harry George Vane, 4th duke of Cleveland, and died in 1901.

The young Lord Dalmeny was educated at Brighton and at Eton, where he had as slightly junior contemporaries Mr A. J. Balfour and Lord Randolph Churchill. He was described by the most brilliant Eton tutor of his day, William Johnson Cory (author of *Ionica*), as a "portentously wise youth, not, however, deficient in fun." He added that Dalmeny "desired the palm without the dust." In 1866 he matriculated at Christ Church, Oxford, but went down in 1868, by the request of the dean, rather than abandon the possession of a small racing stud. In the same year he succeeded to the earldom and to the family estates. In February 1871 he seconded the Address in the House of Lords; a more original effort followed in November 1871, when he delivered a remarkable essay on the Union of Scotland and England at the Edinburgh Philosophical Institution. Three years later he was elected president of the Social Science Congress at Glasgow, where, on the 30th of September, he gave a striking address upon the discovery of means for raising the condition of the working class as the "true leverage of empire." In the meantime he travelled in the south of Europe and in North America. On his return he acquired an English country house called The Durdans, Epsom, which he largely rebuilt and adorned with some of the finest turf portraits of George Stubbs. Following the example, as he declared, of Oliver Cromwell (for whom he showed an admiration in other respects—culminating in 1900 in the erection of a statue outside Westminster Hall, which was not appreciated either by the Irish Nationalist party or by others among his political associates), he took a pride in owning racehorses, and afterwards won the Derby three times, in 1894, 1895 and 1905. He was the first man to enjoy the distinction of winning the Derby while prime minister; but though this was popular enough among many classes, it did not please the Liberal Non-conformists so much, who considered a racehorse a mere gambling-machine. On the 20th of March 1878 Lord Rosebery married Hannah, only child of Baron Meyer Amschel de Rothschild, of Mentmore, Bucks. The newly married couple took a lease of Lansdowne House, which for several years was a salon for the Liberal party and a centre of hospitality for a much wider circle.

Though impeded in his political career by his exclusion from the House of Commons, Lord Rosebery's reputation as a social reformer and orator was steadily growing. In 1878 he was elected Lord Rector of Aberdeen and in 1880 of Edinburgh University, where he gave an eloquent address upon Patriotism. In 1880 he entertained Mr Gladstone at Dalmeny, and during the "Mid Lothian campaign" he had much to do with the stage-management of the demonstrations. As was shown later, he imported into his view of politics a warm sentiment and an imaginative outlook; and he was an enthusiastic student of Lord Beaconsfield's political novels, more particularly of *Sybil*, after the heroine in which he named one of his daughters. In August 1881 he became under-secretary at the Home Office, his immediate chief being Sir William Harcourt. His work was practically confined to the direction of the Scottish department of the Office. A clamour was nevertheless raised in regard to the incompatibility of the under-secretaryship with a position in the House of Lords, and Lord Rosebery resigned the post in June 1883. He and his wife utilized the interval to make a trip round the world, being most warmly received in Australia, and returning by way of India. At the close of 1884 he resumed office as first commissioner of works with a seat in the cabinet, and his adherence carried with it a distinct accession of strength to the Liberal ministry, which was much discredited by the tragedy attached to the fate of Gordon. The attitude of the government on the Afghan question and generally in regard to Russia was held by many to have been perceptibly stiffened owing to Lord Rosebery's influence.

In June 1885 the Liberal administration broke up, but Lord Salisbury's ministry, which succeeded, was beaten early in February 1886, and when Mr Gladstone adopted Home Rule, Lord Rosebery threw in his lot with the old leader, and was made secretary of state for foreign affairs during the brief Liberal ministry which followed. He rather distinguished himself in the Lucia Bay negotiations then being carried on with Germany. If Busch is to be believed, Prince Bismarck's view was that Lord Rosebery had "quite mesmerized" Count Herbert Bismarck; and the latter, from his father's standpoint, conceded too much to Lord Rosebery, who proved himself to be, in Bismarck's language, "very sharp." His views on foreign policy differed materially from those of Granville and Gladstone. His mind was dwelling constantly upon the political legacy of the two Pitts; he was a reader of Sir John Seeley; he had himself visited the colonies; had predicted that a war would not, as was commonly said, disintegrate the empire, but rather the reverse; had magnified the importance of taking colonial opinion; and had always been a convinced advocate of some form of Imperial Federation. He was already taunted with being an Imperialist, but his independent attitude won public approval. Cambridge gave him the degree of LL.D. in 1888; in January 1889 he was elected a member of the first county council of London, and on the 12th of February he was elected chairman of that body by 104 votes to 17. The tact, assiduity and dignity with which he guided the deliberations of the council made him exceedingly popular with its members. In the spring of 1890 he presided over the Co-operative Congress, but with a view to the impending political campaign he found it necessary to resign the chairmanship of the county council in June. In November of this year, however, Lady Rosebery died, and he withdrew for a period from public business. In 1891 he made some brief continental visits, one to Madrid, and in October he saw through the press his little monograph upon *William Pitt*, in the Twelve English Statesmen Series, of which it may be said that it competes in interest with Viscount Morley's *Walpole*. In January 1892, upon a new election, he again for a few months became chairman of the county council. It was already recognized that in him the country possessed not only a public man of exceptionally attractive personality, but one whose literary tastes were combined with a gift for expression which was at once original and fluent. In October the Garter was conferred upon him by Queen Victoria.

Meanwhile, in August, upon the return of Gladstone to power, he was induced with some difficulty (for he was suffering at the time from insomnia) to resume his position as foreign minister. His acceptance was construed as a security against the suspicion of weakness abroad which the Liberal party had incurred by their foreign policy during the 'eighties. He strongly opposed the evacuation of Egypt; he insisted upon the exclusive control by Great Britain of the Upper Nile Valley, and also upon the retention of Uganda. In 1893 the question of Siam came near to causing serious trouble with France, but by the exercise of a combination of firmness and forbearance on Lord Rosebery's part the crisis was averted, and the lines were laid down for preserving Siam, if possible, as a buffer state between the English and French frontiers in Indo-China. In the spring of 1895 he was clear-sighted enough to refuse to join the anti-Japanese League of Russia, France and Germany at the end of the China-Japan War.

Lord Rosebery's personal popularity had been increased at home by his successful intervention in the coal strike of December 1893, and when in March 1894 the resignation of Gladstone was announced, his selection by Queen Victoria for the premiership was welcomed by the public at large and by the majority of his own party. On all hands he was then considered *dignus imperio*—it was only as the new administration went to pieces that people began to add *nisi imperasset*. The conditions he had to face were by no means hopeful. The Liberal majority of 44 was already dwindling away, and the malcontents, who considered that Sir William Harcourt should have been the prime minister, or who were perpetually intriguing against a

leader who did not satisfy their idea of Radicalism, made Lord Rosebery's personal position no easy one. A systematic policy of detraction was pursued by the small section of the Radical party who objected to a peer premier as such, and a great deal of adverse criticism was also aroused by a speech in which the prime minister, taunted for not again bringing forward a Home Rule measure, insisted upon the truism that the conversion of England, the "predominant partner," was a necessary condition of success. The support of the Irish Nationalists was by no means secure. Lord Rosebery's foreign policy, moreover, was too Tory for his Radical followers; he insisted upon "continuity of policy in foreign affairs," which meant carrying on the Conservative policy and not upsetting it. The premier was thought to have shown a restlessness and a rawness at the touch of censure which did not increase his reputation for reserve power or strength, but this was undoubtedly due in large measure to the recrudescence of the insomnia from which he had suffered in 1891. The government effected little. In Mr Asquith's phrase, it was "ploughing the sands." The Parish Councils Act was only passed by compromising with the Opposition. Local Veto and Disestablishment of the Welsh Church were put in the forefront of the party programme, but the government was already to all appearances riding for a fall, when on the 24th of June 1895 it was beaten upon an adverse vote in the Commons in regard to a question of the supply and reserve of small arms ammunition.

The general election which followed after Lord Salisbury had formed his new ministry was remarkable for the undisciplined state of the Liberal party. At the Eighty Club and the Albert Hall Lord Rosebery advised them to concentrate upon the reform of the House of Lords, that assembly being, as he said, a foremost obstacle to the passing of legislation on the lines of the Newcastle programme; but he was unable to suggest in what direction it should be reformed. Sir William Harcourt and Mr John Morley, on the other hand, concentrated respectively upon Local Option and Home Rule. The Liberals were quarrelling among themselves, and the result was an overwhelming defeat. In Opposition Lord Rosebery was now at a serious disadvantage as head of a parliamentary party; for in any case he could not rally them as a loyally followed leader in the House of Commons might have done. But his followers were not all loyal, and his rivals in leadership were themselves in the House of Commons. Added to this there was still in the background the veteran statesman to whom Liberalism owed an unequalled obligation. When the "Armenian atrocities" became a burning question in the country in 1896, and Mr Gladstone himself emerged from his retirement to advocate intervention, Lord Rosebery's difficulties had taken their final form. He declined to support this demand at the risk of a European war, and on the 8th of October 1896 he announced to the Liberal whip, Mr Thomas Ellis, his resignation of the Liberal leadership. On the following day he made a farewell speech at the Empire Theatre, Edinburgh, to over four thousand people, and for some time he held aloof from party politics, "ploughing his furrow alone," as he afterwards phrased it.

In 1898, on the death of Mr Gladstone, he paid a noble and eloquent tribute in the House of Lords to the life and public services of his old leader. He was a pall-bearer at his funeral on the 28th of May, as he had previously been at the burials of Tennyson and Millais. His influence in the country was still a strong one on personal grounds, and he came forward now and again to give expression independently to popular feeling. In the autumn of 1898 he gave valuable support to the attitude taken up by Lord Salisbury upon the Fashoda question. He was indeed bound by consistency to withstand what his own government, by the words of Sir Edward Grey, had declared would be an unfriendly act on the part of France. Again, after Mr Kruger's ultimatum in October 1899, Lord Rosebery spoke upon the necessity of the nation closing its ranks and supporting the government in the prosecution of war in South Africa. After Nicholson's Nek he reiterated the resolution of the country "to see this thing through." Nevertheless, in a letter to Captain

Lambton, an unsuccessful Liberal candidate for Newcastle, in September 1900, he condemned the general conduct of affairs by Lord Salisbury's government, while in several speeches in the House of Lords he strongly urged the necessity of army reform. Since his abandonment of the leadership in 1896, the lack of coherence in the Liberal party had become more and more manifest. The war had brought to the front a pro-Boer section, who seemed gradually to be compromising the whole party, and had apparently succeeded in winning the support of Sir Henry Campbell-Bannerman, the leader in the House of Commons. Lord Rosebery maintained for the most part a sphinx-like seclusion, but in July 1901 he at last came forward strongly as the champion of the Liberal Imperialist section.

In deference to the wishes of supporters such as Mr Asquith, Sir Henry Fowler and Sir Edward Grey he determined to "put his views into the common stock" at a representative meeting of Liberals held at Chesterfield in December 1901. There he advised the Liberal party that "its slate must be cleaned," and, as he subsequently explained, this cleansing must involve the elimination of Home Rule for Ireland. His appeal for "spade work" resulted in the formation of the Liberal League, inside the Liberal Opposition; and what Lord Rosebery himself described as his "definite separation" from Sir Henry Campbell-Bannerman's "tabernacle" took place. This announcement, however, was no sooner made than it was explained away by the supporters of both, and early in 1902 Lord Rosebery spoke at the National Liberal Club in a way which indicated that an understanding might still be arrived at. But though Mr Asquith and Sir Edward Grey adhered to the Liberal League, Sir Henry Campbell-Bannerman retained the loyalty of the majority of the Liberal party, and Lord Spencer threw his weight on the same side; and in a speech at the Liberal League dinner on the 31st of July Lord Rosebery had to admit that their principles had not yet prevailed, and that, until they did, a reconciliation between the two wings of the party would be impossible. In January 1903 he addressed a Liberal meeting at Plymouth, and appeared to be attempting to concentrate Opposition criticism upon the points in the government policy which did not involve the Imperialist difference; and in discussing War Office reform he advocated the appointment of Lord Kitchener as secretary of state for war.

When Mr Chamberlain started his new fiscal programme, combining Tariff Reform with Colonial Preference, Lord Rosebery at first seemed inclined to treat it as non-political, and on the 10th of May 1903 he declared in an address to the Burnley Chamber of Commerce that he was not one of those who regarded Free Trade as part of the Sermon on the Mount. This utterance led to an idea that he was inclined to consider favourably the proposal for a preferential tariff, his earlier enthusiasm for Imperial Federation making his support an interesting political possibility. But this idea was quickly dispelled; on the 22nd he expressed his surprise that anybody should have thought he intended to approve of Mr Chamberlain's plan; he was not prepared to dismiss in advance a proposal for the consolidation of the empire made by the responsible government, but he believed that the objections to a policy of preference were insurmountable. The fact, no doubt, was that Mr Asquith, Lord Rosebery's chief lieutenant in the Liberal League, made himself from the outset a determined champion of free trade in opposition to Mr Chamberlain; and Lord Rosebery quickly came into line with the rest of the Liberal party on this question. On the 12th of June, addressing the Liberal League, he admitted that as a lifelong Imperialist it was with pain and grief that he could not support Mr Chamberlain's scheme, but the empire had been built upon free trade, and he only saw danger to the empire in these new proposals. Speaking at Sheffield on the 13th of October he criticized the scheme in more detail, and, as an Imperialist; warned the country against it, emphasizing his own ideal of the future of the empire—"a strong mother with strong children, each working out his own political and fiscal salvation." His

attitude on the new issue undoubtedly affected public opinion, and helped to draw him closer to the great body of the Liberal party, who saw that their identification with the cause of free trade was doing much to remove the public distrust associated with their support of Home Rule. On the 7th of November at Leicester Lord Rosebery insisted that what the country wanted was not fiscal reform but commercial reform, and he appealed to the free-trade section of the Unionist party to join the Liberals in a united defence,—an appeal incidentally for Liberal unity which was warmly seconded ten days later by Sir Henry Campbell-Bannerman. On the 26th of November Lord Rosebery's speech on the same lines at a meeting in South London resulted in a powerful demonstration in favour of his resuming the Liberal leadership, but he made no public response. On the 10th of June 1904 he addressed a meeting of the Liberal League at the Queen's Hall, London, and sketched a programme of "sane and practical Imperialism"; but he irritated the Home Rulers by again repudiating a parliament in Dublin, and he perplexed the public generally by his adverse criticism on the popular Anglo-French Agreement, which he was the only English statesman to oppose, on the ground of its handing over Morocco to France.

At Glasgow on the 5th of December he again outlined a Liberal programme, this and other speeches all leading to the assumption that his return to active co-operation with the Liberal party in the general election—which could not be long delayed—was fairly certain. Early in 1905 this impression gained such strength and such polite references were made to one another in public by Lord Rosebery and Sir Henry Campbell-Bannerman, that his assumption of office in a Liberal ministry, possibly presided over by Earl Spencer, was confidently anticipated. But these forecasts were ultimately upset, not only by Lord Spencer's illness and his removal from the list of possible Liberal prime ministers, but by Sir Henry Campbell-Bannerman's pronouncement at Stirling in November on the subject of Irish Home Rule. Lord Rosebery had just gone down to Cornwall to make a series of speeches in support of the Liberal programme, now fairly well mapped out as regards those items which represented the strong public opposition to what had been done by the Unionist government. It was believed that an understanding had been come to between his Liberal League henchmen (Mr Asquith, Sir E. Grey and Mr Haldane) and Sir Henry Campbell-Bannerman, and that Lord Rosebery's co-operation was to be secured by the adoption of some formula which would temporarily take Home Rule out of the official programme as a question of practical politics. But to the general surprise and Lord Rosebery's own very evident mortification Sir Henry went a long way in his Stirling speech to nail the Home Rule colour to the mast; he did not indeed propose to introduce a Home Rule Bill, but he declared his determination to proceed in Irish legislation on lines which would lead up to the same result. Lord Rosebery abruptly broke off his campaign, declaring at Bodmin (26th of November) that he would never "fight under that banner." From the moment the apparent recrudescence of the Liberal split over this question seemed to have misled Mr Balfour, who resigned office on the 4th of December, into thinking that difficulties would arise over the formation of a Liberal cabinet; but, whether or not the rumour was correct that a blunder had been made at Stirling and that explanations had ensued which satisfied Mr Asquith and Sir Edward Grey, this anticipation proved unjustified. Lord Rosebery himself, it is true, held aloof; his protest had been publicly made and he adhered to it in the absence of any public withdrawal by Sir Henry Campbell-Bannerman; but he encouraged his Liberal League supporters to be loyal to the new prime minister, and Mr Asquith, Sir E. Grey and Mr Haldane were included in the Liberal cabinet. The overwhelming Liberal and Labour victory at the general election of 1906 began a new era in the fortunes of the party, and Lord Rosebery's individuality once more sank back from any position of prominence in regard to its new programme. He remained outside party politics,

emerging only in 1909, first to attack Mr Lloyd George's budget in the country as a "revolution," and then—to the general surprise—to condemn the House of Lords in debate for rejecting it; and in 1910 (see PARLIAMENT) he appeared once more to be coming to the front, by the resolutions he carried in regard to the remodelling of the Upper Chamber, when the death of King Edward VII. caused a temporary postponement of the constitutional crisis. In September 1910 he acted as head of the special mission sent to the Austrian court by George V. to announce his accession to the throne,—a selection peculiarly appropriate, and cordially welcomed as such, because of his well-known Austrian sympathies. Indeed, in the East European crisis of 1909 Lord Rosebery had taken a somewhat isolated part in vindicating the attitude of Austria and her right to annex Bosnia-Herzegovina, in opposition to the criticisms generally passed in the English press.

After his retirement from active politics Lord Rosebery continually displayed his great qualities as a public speaker by eloquent and witty addresses on miscellaneous subjects. No public man of his time was more fitted to act as unofficial national orator; none more happy in the touches with which he could adorn a social or literary topic and charm a non-political audience; and on occasion he wrote as well as he spoke. His *Pitt* has already been mentioned; his *Appreciations and Addresses* and his *Peel* (containing a remarkable comment on the position of an English prime minister) were published in 1899; his *Napoleon: the Last Phase*—an ingenious, if paradoxical, attempt to justify Napoleon's conduct in exile at St Helena—in 1900; his *Cromwell* in the same year. In 1906 he published an appreciation of his old friend Lord Randolph Churchill, inspired by the publication of Mr Winston Churchill's Life of his father. In its detached yet intimate way, this is a model of the art by which a good judge of men, possessed at the same time of a just historical sense, may, from the point of view of a contemporary on the opposite side in politics, correct the perspective of an official biography written under the limitations of filial obligation, and give tone and value to the picture of an interesting personality.

Lord Rosebery's family consisted of two sons and two daughters. His eldest son, Lord Dalmeny (b. Jan. 1822), who in 1909 married a daughter of Lord Henry Grosvenor, 3rd son of the 1st duke of Westminster, entered parliament in 1906 as Liberal member for Mid Lothian, but retired in 1910; he was well known as a cricketer, captaining the Surrey eleven in 1905 and 1906. The younger son, the Hon. Neil Primrose (b. Dec. 1882), took more actively than his brother to a political career, and in January 1910 was returned as a Liberal for the Wisbech division of Cambridgeshire. The elder daughter, Lady Sybil, in 1903 married Captain Charles Grant; the younger, Lady Margaret, in 1899 married the 1st earl of Crewe.

(H. Ch.)

ROSECRANS, WILLIAM STARKE (1819–1898), American soldier, was born in Kingston, Ohio, on the 6th of September 1819, and graduated in 1842 from the U.S. Military Academy, being appointed to the engineers. After serving (1843–47) as assistant professor at West Point, and in fort construction, he resigned (April 1854) from the army and went into business in Cincinnati. On the outbreak of the Civil War Rosecrans volunteered for service under McClellan and helped raise the Ohio "Home Guards," with which he served in the West Virginia operations of 1861 in the rank of brigadier-general. He was second in command to McClellan during this campaign, and succeeded to the command when that officer was called to Washington. In the latter part of 1861 Rosecrans conducted further operations in the same region with great skill and success, and early in 1862 he was transferred to the West as a major-general of volunteers. He took part in the operations against Corinth, and when General John Pope was ordered to Virginia, Rosecrans took over command of the Army of the Mississippi with which he fought the successful battles of Iuka and Corinth. Soon afterwards he was ordered to replace D. C. Buell in command of the forces, renamed the Army of the Cumberland about the same time.

In December he advanced against General Braxton Bragg, and on the 31st of December to the 3rd of January was fought the bloody and indecisive battle of Stone River (Murfreesboro), after which Bragg withdrew his army to the southward. In 1863 Rosecrans, refusing to advance until the isolation of Vicksburg (farther west) was assured, did not take the offensive until late in June. The operations thus begun were most skillfully conducted, and Bragg was forced back to Chattanooga (*q.v.*), whence he had to retire on being once more outmaneuvered. But Rosecrans sustained a great defeat at the battle of Chickamauga (*q.v.*), and was soon besieged in Chattanooga. He was then relieved from his command. Later he did good service in Missouri, and in March 1865 he was made brevet major-general U.S.A. He resigned in 1867, and in the following year became minister to Mexico. Subsequently he was engaged in many railway and industrial enterprises in that country, as also in California. He was a representative in Congress from California, 1881–85, and register of the treasury, 1885–93. Under an act of Congress he was on the 2nd of March 1889 restored to the rank of brigadier-general, and retired. He died near Redondo, Cal., on the 11th of March 1898. On the 17th of May 1902 his body was reinterred with military honours in the National Cemetery at Arlington, in the presence of President Roosevelt, members of the cabinet and many of his campaigning comrades.

ROSEGER, PETER (1843–), Austrian poet and novelist, known down to 1894 under the pseudonym *Petri Kettefseier*, was born at Alpl near Krieglach in Upper Styria, on the 31st of July 1843, the son of a peasant. Until his seventeenth year he was employed as a farm hand and received no regular school education, though he learnt reading and writing from a retired schoolmaster who lived near. Unfit, owing to physical weakness, for the hard labour of agriculture, he was apprenticed to a journeyman tailor, and on his wanderings employed his leisure hours in educating himself. He soon composed poems and wrote stories. Some of these productions he sent in 1864 to Dr Svoboda, the editor of the *Graz Tagespost*, who, recognizing Rosegger's extraordinary talent, interested himself in the young author, and with the assistance of friends enabled him to study (from 1865–66) at the Handelsakademie of Graz. In 1869, encouraged by Robert Hamerling, Rosegger published his first work, a volume of poems in Styrian dialect, *Züher und Hackbrett*, which immediately established his reputation. As a result, the provincial diet of Styria accorded him a substantial *stipendium* (scholarship) for three years, which enabled him to supplement his studies by foreign travel. He now devoted himself entirely to authorship, and in 1876 founded the monthly periodical *Der Heimgarten*. On the occasion of the centenary of its reorganization the University of Heidelberg conferred upon him, in 1903, the honorary degree of doctor of philosophy.

Rosegger is one of the most fertile authors of recent times. His fresh natural style, sound judgment and his fascinating descriptions of Alpine scenery and the life of its inhabitants have made him one of the most popular authors of Austria and Germany. These characteristics are displayed to great advantage in *Die Schriften des Waldschneiders* (1875), *Aus meinem Handwerkerleben* (1880), *Alpengeschichten* (1896), *Als ich noch jung war* (1895), and in the lovely *Mann und Weib* (1879), while his simple religious mind is shown in *Mein Himmelreich* (1901), *Erdsengen* (1900) and *Das ewige Licht* (1897), and his attachment to friends in *Gute Kameraden* (1893) and *Persönliche Erinnerungen an Robert Hamerling* (1891). Among his other works may be mentioned a volume of poems, *Gedichte* (1891), a popular play, *Am Tage des Gerichts* (1892), two books for boys, *Waldferien* (1887) and *Waldjugend* (1900), and the stories *Das Sünderglöckl* (1904), *Wildlinge* (1906) and *I.N.R.I. Frohe Botschaft eines armen Sünders* (1905), which has also been translated into English. He has also written several works which are autobiographical in character, such as *Waltheimat* (1873) and *Mein Wälder* (1898).

Rosegger's *Ausgewählte Schriften* appeared in thirty volumes (1881–94); a popular edition (1895–1900); his *Schriften in steirischer Mundart* (3 vols., 1894–96). See also A. V. Svoboda, P. K. Rosegger (1886); A. Stern, *Studien zur Literatur der Gegenwart* (1895); and H. Möbius, P. Rosegger (1903).

ROSELLINI, IPPOLITO (1800–1843), Italian Egyptologist, was born at Pisa. He studied under Mezzofanti at Bologna, and

in 1824 became professor of oriental languages at Pisa University. He is best known as the associate of J. F. Champollion (*q.v.*), whose studies he shared and whom he accompanied in his Egyptian explorations (1828). On the death of Champollion the publication of the results of their expedition fell to Rosellini (*Monumenti dell' Egitto e della Nubia*, Florence, 1832-40, 10 vols. fol.).

ROSEMARY, botanically *Rosmarinus*, a Labiate plant, the only representative of the genus and a native of the Mediterranean region. It is a low shrub with linear leaves, dark green above, white beneath, and with margins rolled back on to the under face. The flowers are in small axillary clusters. Each has a two-lipped calyx, from which projects a bluish two-lipped corolla enclosing two stamens, the other two, which are generally present in the family, being deficient. The fruit consists of four smooth nutlets. Botanically the genus is near to *Salvia*, but it differs in the shorter connective to the anther. Rosemary was highly esteemed by the ancients for its aromatic fragrance and medicinal uses. In modern times it is valued mainly as a perfume, for which purpose the oil is obtained by distillation. It doubtless has slight stimulant properties, such as are common to all volatile oils, which may account for the general belief in the efficacy of the plant in promoting the growth of the hair. Rosemary plays no unimportant part in literature and folk-lore, being esteemed as an emblem of remembrance. "There's rosemary, that's for remembrance," says Ophelia. Its use in connexion with funeral ceremonies is not extinct in country places to this day, and it was formerly much valued at wedding festivities. The name "ros marinus" or "ros maris," literally "sea-dew," was probably given in allusion to its native habitat in the neighbourhood of the sea.

ROSENHEIM, a town and watering-place of Germany, in the kingdom of Bavaria, situated at the confluence of the Mangfall and the Inn, 40 m. by rail S.E. of Munich. Pop. (1905) 15,403. It is an interesting town, with many medieval houses. Among its seven churches the Roman Catholic parish church, with a curious cupola and containing numerous old tombs and effigies, and that of the Holy Ghost (15th century), are remarkable. There are a monastery, two convents, several schools and a hospital. Rosenheim is frequented for its saline and sulphur baths, and there are important saltworks, the brine being conveyed from Reichenhall in pipes; it has also machine factories, metalworks and breweries. Cordage is manufactured, and there is a trade in cattle and grain. Although founded in the 12th century Rosenheim did not become a town until 1864.

See Ditterich, *Rosenheim in Oberbayern* (Munich, 1870), and Eid, *Aus Altrosenheim* (Rosenheim, 1906).

ROSENKRANZ, JOHANN KARL FRIEDRICH (1805-1879), German philosopher, was born at Magdeburg on the 23rd of April 1805. He read philosophy at Berlin, Halle and Heidelberg, devoting himself mainly to the doctrines of Hegel and Schleiermacher. After holding the chair of philosophy at Halle for two years, he became, in 1833, professor at the university of Königsberg, where he remained till his death on the 14th of July 1879. In his last years he was quite blind. Throughout his long professorial career, and in all his numerous publications he remained, in spite of occasional deviations on particular points, loyal to the Hegelian tradition as a whole. In the great division of the Hegelian school, he, in company with Michelet and others, formed the "centre," midway between Erdmann and Gabler on the one hand, and the "extreme left" represented by Strauss, Feuerbach and Bruno Bauer.

Of his numerous writings, the following may be mentioned:—1. *Philosophical: Kritik der Schleiermacherschen Glaubenslehre* (1836); *Psychologie oder Wissenschaft vom subjektiven Geist* (1837; 3rd ed., 1863); *Kritische Erläuterungen des Hegelschen Systems* (1840); *Vorlesungen über Schelling* (1842); *System der Wissenschaft* (1850); *Meine Reform der Hegelschen Philosophie* (1852); *Wissenschaft der logischen Idee* (1858-59), with a supplement (*Epilomena*, 1862); *Hegels Naturphilosophie und die Bearbeitung derselben durch Vera* (1868); *Erläuterungen zu Hegels Encyclopädie der philosophischen Wissenschaften* (1871). Two other of his works on Hegel are important, the *Leben Hegels* (1844) and the *Hegel als deutscher*

Nationalphilosoph (1870). Between 1838 and 1840 in conjunction with F. W. Schubert, he published an edition of the works of Kant, to which he appended a history of the Kantian doctrine. 2. *Literary and General: Geschichte der deutschen Poesie im Mittelalter* (1830); *Handbuch einer allgemeinen Geschichte der Poesie* (1832-33); *Die Pädagogik als System* (1848); *Aesthetik des Häßlichen* (1853); *Die Poesie und ihre Geschichte* (1885); *Studien* (1839-47) and *Neue Studien* (1875-78). He published also an autobiography entitled *Von Magdeburg nach Königsberg* (1873), which deals with his life up to the time of his settlement at Königsberg. See Quabücker, *Karl Rosenkranz* (1899), and J. Hutchison Stirling, *The Secret of Hegel*, part 6.

ROSENTHAL, TOBY EDWARD (1848-), American artist, was born at New Haven, Connecticut, on the 15th of March 1848. Removing to San Francisco with his parents in 1855, he there studied painting under Fortunato Ariola. In 1865 he went to Munich, where he was a pupil of the Royal Academy under Strachuber, Raupp and Piloty. Among his more important works are: "Morning Prayers" (Leipzig Museum), "Elaine," "Trial of Constance de Beverley," "Dancing Lesson During the Empire" and "Departure from the Family."

ROSES, WARS OF THE, a name given to a series of civil wars in England during the reigns of Henry VI., Edward IV. and Richard III. Their importance in the general history of England is dealt with elsewhere, and their significance in the history of the art and practice of war is small. They were marked by a ferocity and brutality which are practically unknown in the history of English wars before and since. The honest yeoman of Edward III.'s time had evolved into a professional soldier of fortune, and had been demoralized by the prolonged and dismal Hundred Years' War, at the close of which many thousands of ruffians, whose occupation had gone, had been let loose in England. At the same time the power of feudalism had become concentrated in the hands of a few great lords, who were wealthy enough and powerful enough to become king-makers. The disbanded mercenaries enlisted indifferently on either side, corrupting the ordinary feudal tenantry with the evil habits of the French wars, and pillaged the countryside, with accompaniments of murder and violence, wherever they went. It is true that the sympathies of the people at large were to some extent enlisted: London and, generally, the trading towns being Yorkist, the country people Lancastrian—a division of factions which roughly corresponded to that of the early part of the Great Rebellion, two centuries later, and similarly in a measure indicative of the opposition of hereditary loyalty and desire for sound and effective government. But there was this difference, that in the 15th century the feeling of loyalty was to a great extent focused upon the great lords. Each lord could depend on his own tenantry, and he could, further, pay large bands of retainers. Hence, much as the citizen desired a settlement, the issue was in the hands of the magnates; and as accessions to and defections from one party and the other constantly shifted the balance of power, the war dragged on, becoming more and more brutal with every campaign.

It is from the Wars of the Roses that there originated the deep-rooted dislike of the professional soldier which was for nearly four centuries a conspicuous feature of the English social and governmental system, and it is therefore in their results rather than their incidents that they have affected the evolution of war. They withdrew the English army system from European battlefields precisely at the moment of transition when the regimental and technical organization of armies was becoming a science and seeking models, and the all-powerful English longbow at the moment when the early, scarcely effective firearms were, so to speak, struggling for recognition as army weapons. On the other hand, they destroyed the British military organization. The national army, aloof from the main streams of military progress, remained for 150 years an aggregation of county levies armed with bills and bows. In so far as the king was permitted or able to raise armies, they were small mercenary forces formed, on a basis of unemployed professionals, from pressed men and criminals, and they were

disbanded as soon as the brief occasion for their services had passed.

The first campaign, or rather episode, of these wars¹ began with an armed demand of the Yorkist lords for the dismissal of the Lancastrian element in the king's council, Henry VI. himself being incapable of governing. The Lancastrians, and the king with them, marched out of London to meet them, and the two small armies (3000 Yorkists, 2000 Lancastrians) met at St Albans (May 22, 1455). The encounter ended with the dispersion of the weaker force, and the king fell into the hands of the Yorkists. Four years passed before the next important battle, Blore Heath, was fought (Sept. 23, 1459). In this the earl of Salisbury trapped a Lancastrian army in unfavourable ground near Market Drayton, and destroyed it; but new political combinations rendered the Yorkist victory useless and sent the leaders of the party into exile. They made a fresh attempt in 1460, and, thanks partly to treason in the Lancastrian camp, partly to the generalship of Warwick, won an important success and for the second time seized the king at Northampton (July 10, 1460). Shortly afterwards, after a period of negotiation and threats, there was a fresh conflict. Richard duke of York went north to fight the hostile army which gathered at York and consisted of Lancashire and Midland Royalists, while his son Edward, earl of March, went into the west. The father was ambushed and killed at Wakefield (Dec. 30, 1460), and the Lancastrians, inspired as always by Queen Margaret of Anjou, moved south on London, defeated Warwick at St Albans (Feb. 17, 1461), and regained possession of the king's person. But the young earl of March, now duke of York, having raised an army in the west, defeated the earl of Pembroke (Feb. 2, 1461) at Mortimer's Cross (5 m. W. of Leominster). This was the first battle of the war which was characterized by the massacre of the common folk and beheading of the captive gentlemen—invariable accompaniments of Edward's victories, and conspicuously absent in Warwick's. Edward then pressed on, joined Warwick, and entered London, the army of Margaret retreating before them. The excesses of the northern Lancastrians in their advance produced bitter fruit on the retreat, for men flocked to Edward's standard. Marching north in pursuit, the Yorkists brought their enemy to bay at Towton (q.v.), 3 m. S. of Tadcaster, and utterly destroyed them (March 29, 1461). For three years after Towton the war consisted merely of desultory local struggles of small bodies of Lancastrians against the inevitable. The duke of York had become King Edward IV., and had established himself firmly. But in 1464, in the far north of England, the Red Rose was again in the field. Edward acted with his usual decision. His lieutenant Montagu (Warwick's brother) defeated and slew Sir Ralph Percy at Hedgley Moor, near Wooler (April 25, 1464), and immediately afterwards destroyed another Lancastrian army, with which were both Henry VI. and Queen Margaret, at Hexham (May 8, 1464). The massacres and executions which followed effectively crushed the revolt. For some years thereafter Edward reigned peacefully, but Warwick the king-maker and all the Neville following having turned against him (1470), he was driven into exile. But at a favourable moment he sailed from Flushing with 1500 retainers and Burgundian mercenaries, and eluding the Lancastrian fleet and the coast defence troops, landed at Ravenspur (Spurn Head) in Yorkshire in March 1471. His force was hardly more than a bodyguard; the gates of the towns were shut against him, and the country people fled. But by his personal charm, diplomacy, fair promises and an oath of allegiance to King Henry VI., sworn solemnly at York, he disarmed hostility and, eluding Montagu's army, reached his own estates in the Wakefield district, where many of his old retainers joined him. As

¹ The name, as is well known, comes from the "white rose of York" and the "red rose of Lancaster"; but these badges, though more or less recognized as party distinctions, by no means superseded the private devices of the various great lords, such as the "falcon and letterlock" of Richard duke of York, the "rose in sun" of Edward IV., the "crowned swan" of Margaret, the Vere star, and even the revived "white hart" of Richard II.

he advanced south, a few Yorkist nobles with their following rallied to him, but it was far more the disunion of the Warwick and the real Lancastrian parties than his own strength which enabled him to meet Warwick's forces in a pitched battle. At Barnet, on Easter Eve, April 14, 1471, the decisive engagement was fought. But in the midst of the battle reinforcements coming up under the earl of Oxford to join Warwick came into conflict with their own party, the badge of the Vere star being mistaken for Edward's *Rose-en-seaileil*. From that point all the mutually distrustful elements of Warwick's army fell apart, and Warwick himself, with his brother Montagu, was slain. For the last time the unhappy Henry VI. fell into the hands of his enemies. He was relegated to the Tower, and Edward, disbanding his army, reoccupied the throne. But Margaret of Anjou, his untiring opponent, who had been in France while her cause and Warwick's was being lost, had landed in the west shortly after Barnet, and Edward had to take the field at once. Assembling a fresh army at Windsor, whence he could march to interpose between Margaret and her north Welsh allies, or directly bar her road to London, he marched into the west on the 24th of April. On the 29th he was at Ciuencستر, Margaret, engaged chiefly in recruiting an army, near Bath. Edward hurried on, but Margaret eluded him and marched for Gloucester. At that place the governor refused the Lancastrians admittance, and seeking to cross the Severn out of reach of the Yorkists, they pushed on by forced marches to Tewkesbury. But Edward too knew how to march, and caught them up. The battle of Tewkesbury (May 4, 1471) ended with the destruction of Margaret's force, the captivity of Margaret, the death of her son Edward (who, it is sometimes said, was stabbed by Edward IV. himself after the battle) and the execution of sixteen of the principal Lancastrians.

This was Edward's last battle. The rest of his eventful reign was similar in many ways to that of his contemporary Louis XI., being devoted to the consolidation of his power, by fair means and foul, at the expense of the great feudatories. But the Wars of the Roses were not yet at an end. For fourteen years, except for local outbreaks, the land had peace, and then Richard III.'s crown, struck from his head on Bosworth Field (Aug. 22, 1485), was presented to Henry earl of Richmond, who, as Henry VII., established the kingship on a secure foundation. A last feeble attempt to renew the war, made by an army gathered to uphold the pretender Lambert Simnel, was crushed by Henry VII. at Stoke Field (4 m. S.W. of Newark) on the 16th of June 1487.

ROSETTA (Coptic *Rashit*, Arabic *Rashid*), a town situated at the western or "Rosetta" mouth of the Nile on the west bank. It was called Bolbitine by the Greeks, but according to Herodotus the Bolbitine mouth was artificial, and it was evidently of little importance compared with the Canopic, Sebennytic and Pelusiac mouths. When the other branches and the Alexandria canal silted up, Rosetta prospered like its sister port of Damietta on the eastern branch; the main trade of the overland route to India passed through it until Mehemet Ali cut a new canal joining Alexandria to the Nile. Rosetta is now much decayed. Its population in 1907 was 16,810, almost entirely Mussulman. A railway joins it to Alexandria. The celebrated Rosetta Stone which supplied Champollion with the key for the decipherment of the ancient monuments of Egypt was found near Fort St Julien, 4 m. N. of the town, in 1799, by Boussard, a French officer. It is a basalt stele inscribed in hieroglyphic, demotic and Greek with a decree of the priests assembled at Memphis in favour of Ptolemy V. Epiphanes. It was ceded to the English at the capitulation of Alexandria (1801) and is now in the British Museum. See *EGYPT: II. Ancient Egypt*, section D. "Writing." (F. Ll. G.)

ROSEWOOD, the name given to several distinct kinds of ornamental timber. That, however, so called in the United Kingdom is Brazilian rosewood, the *palissandre* of the French, the finest qualities of which, coming from the provinces of Rio de Janeiro and Bahia, are believed to be the produce principally of *Daiberigia nigra*, a leguminous tree of large dimensions,

called *cabina* and *jacaranda* by the Brazilians. The same name, *jacaranda*, is applied to several species of *Machaerium*, also trees belonging to the natural order Leguminosae; and there can be no doubt that a certain proportion of the rosewood of commerce is drawn from these sources. Rosewood comes to the United Kingdom from Rio de Janeiro, Bahia, Jamaica and Honduras. The heartwood attains large dimensions, but as it begins to decay before the tree arrives at maturity it is always faulty and hollow in the centre. On this account squared logs or planks of rosewood are never seen, the wood being imported in half-round fitches 10 to 20 ft. in length and from 5 to 12 in. in their thickest part. Owing to its irregular form, the wood is sold by weight, and its value varies within wide limits according to the richness of colour. Rosewood has a deep ruddy brown colour, richly streaked and grained with black resinous layers. It takes a fine polish, but, on account of its resinous nature, it is somewhat difficult to work. The wood is very much in demand both by cabinet-makers and pianoforte-makers, by whom it is used both solid and in veneer.

The wood of *Dalbergia latifolia*, a native of the East Indies, used for ornamental furniture and carvings under the name of black wood, is frequently termed East Indian Rosewood. The *Bois de Rose* of the French, the Portuguese *Pao de Rosa*, and the German *Rosenholz* is a Brazilian wood, the produce of *Physalymma floribundum*, called in the United Kingdom tulip wood, and very highly esteemed on account of its beautiful rose colour and grain.

ROSICRUCIANISM. What is known as the Society of Rosicrucians (*Rosenkreuzer*) was really a number of isolated individuals who early in the 17th century held certain views in common (which apparently was their only bond of union); for of a society holding meetings, and having officers, there is no trace. So far as the numerous works are concerned it is evident that the writers who posed as Rosicrucians were moral and religious reformers, and utilized the technicalities of chemistry (alchemy), and the sciences generally, as media through which to make known their opinions, there being a flavour of mysticism or occultism promotive of inquiry and suggestive of hidden meanings discernible or discoverable only by adepts.

The publication of the *Allgemeine und General-Reformation der Gassen weiten Welt* (Cassel, 1614), and the *Pama Fraternalitatis* (Cassel, 1615) by the theologian Johann Valentin Andrea (1586-1654), caused immense excitement throughout Europe, and they not only led to many re-issues, but were followed by numerous pamphlets, favourable and otherwise, whose authors generally knew little, if anything, of the real aims of the original author, and doubtless in not a few cases amused themselves at the expense of the public. It is probable that the first work was circulated in MS. about 1610, for it is said that a reply was written in 1612 (according to Herder), but if so, there was no mention of the cult before that decade. The authors generally favoured Lutheranism as opposed to Roman Catholicism. Others, like John Heydon, admitted they were not Rosicrucians, but under attractive and suggestive titles to their works sought to make Hermeticism and other curious studies more useful and popular, and succeeded, for a time at least.

The curious legend, in which the fabulous origin of the so-called society was enshrined (that a certain Christian Rosenkreuz had discovered the secret wisdom of the East on a pilgrimage in the 15th century), was so improbable, though ingenious, that the genesis of the Rosicrucians was generally overlooked or ignored, but the worthy objects of the fratres were soon discovered and supported by several able men; the result being a mass of literature on the subject, which absorbs some 80 pages of Gardner's *Catalogue Raisonné of Works on the Occult Sciences* (London, 1903).

The influence that Rosicrucianism had in the modernizing of ancient Freemasonry early in the 18th century must have been slight, if any, though it is likely that as the century advanced, and additional ceremonies were grafted on to the first three degrees, Rosicrucian tenets were occasionally introduced into the later rituals. So far, however, as the real foundation ceremonies of Craft

Masonry are concerned, whether before or after the premier Grand Lodge was formed, it is most unlikely that such a society as the Freemasons would adopt anything of a really distinctive character from any other organization.

In *The Muses' Threnodie* by H. Adamson (Perth, 1638) are the lines—

"For what we do despage is riot in grosse,
For we are brethren of the Rosie Crosse;
We have the Mason Word and second sight,
Things for to come we can foretell aright."

Dr Begemann considers that possibly during the decade from 1720 to 1730 a kind of Rosicrucian or Hermetic influence took place in the lodges of London, some additions to the ritual of that period not having been derived from operative masonry; but in the previous century no such influence is traceable. Several modern societies have been formed from time to time (some of which are still flourishing in Great Britain) for the study of Rosicrucianism and allied subjects, but in no sense are they directly derived from the "Brethren of the Rosy Cross" of the 17th century, though keen followers thereof. By far the most important of these is the "Societas Rosicruciana in Anglia," with headquarters in London. The Supreme Magus, Dr William Wyan Westcott, has written its History (1900), with other important works on the subject, and the published *Transactions of the Society* are most valuable.

The Rosicrucians, their Rites and Mysteries, by Hargrave Jennings (three editions, 1870-87); *The Real History of the Rosicrucians, founded on their own Manifestoes and on Facts and Documents collected from the Writings of Initiated Brethren*, by A. E. Waite (1887); and *The Arcane Schools*, by John Yarker (1909), may be consulted with advantage, though not authorized publications of the Society. (W. J. H. *)

ROSIN (a later variant of "resin," *q.v.*) or **COLOPHONY** (*Colophonia resina*, resin from Colophon in Lydia), the resinous constituent of the oleo-resin exuded by various species of pine, known in commerce as crude turpentine. The separation of the oleo-resin into the essential oil-spirit of turpentine and common resin is effected by distillation in large copper stills. The essential oil is carried off at a heat of between 212° and 316° F., leaving fluid resin, which is run off through a tap at the bottom of the still, and purified by passing through a straining wadding. Resin varies in colour, according to the age of the tree whence the turpentine is drawn and the amount of heat applied in distillation, from an opaque almost pitchy black substance through grades of brown and yellow to an almost perfectly transparent colourless glassy mass. The commercial grades are numerous, ranging by letters from A, the darkest, to N, extra pale,—superior to which are W, "window glass," and WW, "water white" varieties, the latter having about three times the value of the common qualities. Resin is a brittle and friable resin, with a faint piny odour; the melting-point varies with different specimens, some being semi-fluid at the temperature of boiling water, while others do not melt till 220° or 250° F. It is soluble in alcohol, ether, benzene and chloroform. Resin consists mainly of abietic acid, and combines with caustic alkalis to form salts (rosinates or pinates) that are known as "rosin soaps." In addition to its extensive use in soap-making, resin is largely employed in making inferior varnishes, sealing-wax and various cements. It is also used for preparing shoemaker's wax, as a flux for soldering metals, for pitching lager beer casks, for rosinning the bows of musical instruments and numerous minor purposes. In pharmacy it forms an ingredient in several plasters and ointments. On a large scale it is treated by destructive distillation for the production of rosin spirit, pineoil and rosin oil. The last enters into the composition of some of the solid lubricating greases, and is also used as an adulterant of other oils.

The chief region of rosin production is the South Atlantic and Eastern Gulf states of the United States. American rosin is obtained from the turpentine of the swamp pine, *Pinus australis*, and of the loblolly pine, *P. Taeda*. The main source of supply in Europe is the "landes" of the departments of Gironde and Landes in France, where the cluster pine, *P. Pinaster*, is extensively cultivated. In the north of Europe rosin is obtained from the Scotch fir, *P. sylvestris*, and throughout European countries local supplies are obtained from other species of pine.

ROSKILDE, or **ROESKILDE**, a town of Denmark in the amt (county) of Kjöbenhavn (Copenhagen), 20 m. by rail W. of Copenhagen, on the great lagoon-like inlet named Roskilde Fjord. Pop. (1901) 8368. It has a small port, and is an important railway junction, from which lines diverge W., S.W. and S. through the island of Zealand. Its interest, however, is historical. It was the capital of the kingdom until 1443, and the residence of the bishops of Zealand until the Reformation. The cathedral, a beautiful church, was consecrated in 1084, but of this early building only foundation walls remain; the present structure of brick was begun in 1215, and enlarged and restored at various later dates. It stands in relation to Danish history somewhat as Westminster Abbey does to English, containing the tombs of most of the Danish kings from Harold I. (987). The most noteworthy architectural details are the Chapel of the Trinity (15th century) and that of Christian IV. (Renaissance, 1617), carved choir-stalls, and an altar-piece of the 16th century. Other old buildings are a church of Our Lady, dating as it stands from 1242, a diocesan library (partly of the 15th century), royal palace (1733) and institute for daughters of noblemen (1670).

ROSMEAD, HERCULES GEORGE ROBERT ROBINSON, 1ST BARON (1824-1897), British colonial administrator, was born on the 10th of December 1824. He was of Irish descent on both sides; his father was Admiral Hercules Robinson, his mother a Miss Wood of Rosmead, County Westmeath, from which he afterwards took his title. Passing from Sandhurst into the 87th Foot, he attained the rank of captain; but in 1846, through the influence of Lord Naas, he obtained a post in the Board of Public Works in Ireland, and subsequently became chief commissioner of fairs and markets. His energy in these positions, notably during the famine of 1848, and the clearness and vigour of his reports, secured for him at the age of thirty the office of president of the island of Montserrat. Subsequently he was governor of St Christopher, from 1855 to 1859, when he was knighted in recognition of his services in introducing coolie labour into the island; of Hong-Kong; of Ceylon (K.C.M.G. in 1860); and in 1872 of New South Wales. It fell to his lot to annex the Fiji Islands to the British Empire, and his services were rewarded in 1875 by promotion to G.C.M.G. In 1870 he was transferred to New Zealand, and in 1880 he succeeded Sir Bartle Frere as high commissioner of South Africa. He arrived in South Africa shortly before the disaster of Majuba, and was one of the commissioners for negotiating a peace which was personally distasteful to him. It left him with the task of conciliating on the one hand a Dutch party elated with victory, and on the other hand a British party almost ready to despair of the British connexion. He was called home in 1883 to advise the government on the terms of the new convention concluded with the Transvaal Boers in February 1884. On his return to South Africa he found that a critical situation had arisen in Bechuanaaland, where Boer commandos had seized large tracts of territory and proclaimed the "republics" of Stella and Goshen. They refused to retire within the limits of the Transvaal as defined by the new convention, and Robinson, alive to the necessity of preserving this country—the main road to the north—for Great Britain, determined on vigorous action. John Mackenzie and later Cecil Rhodes were sent to secure the peaceful submission of the Boers, but without immediate result, partly owing to the attitude of the Cape ministry. Robinson's declaration that the advice of his ministers to patch up a settlement with the filibustering Boers was equivalent to a condonation of crime, led to the expedition of Sir Charles Warren and the annexation of Bechuanaaland early in 1885. The difficulties of Robinson's position were illustrated by the dispute which arose between him and Warren, who declared that the high commissioner's duties to the home government were at times in conflict with the action which, as governor of Cape Colony, he was bound to take on the advice of his ministers in the interests of the colony. Sir Hercules Robinson succeeded in winning the confidence of President Kruger by his fair-mindedness, while he seconded

Rhodes's efforts to unite the British and Dutch parties in Cape Colony. His mind, however, was that of the administrator as distinguished from the statesman, and he was content to settle difficulties as they arose. In 1886 he investigated the charges brought against Sir John Pope-Hennessy, governor of Mauritius, and decreed his suspension pending the decision of the home authorities, who eventually reinstated Pope-Hennessy. In 1887 Robinson was induced by Rhodes to give his consent to the conclusion of a treaty with Lobengula which secured British rights in Matabele and Mashona lands. In May 1889 Robinson retired. In his farewell speech he declared that there was no permanent place in South Africa for direct Imperial rule. This was interpreted to mean that South Africa must ultimately become independent—an idea repugnant to him. He explained in a letter to *The Times* in 1895 that he had referred to the "direct rule of Downing Street over the crown colonies, as contrasted with responsible colonial government." He was made a baronet in 1891. Early in 1895, when he had entered his 71st year and was not in robust health, he yielded to the entreaties of Lord Rosebery's cabinet, and went out again to South Africa, in succession to Sir H. Loch. His second term of office was not fortunate. The Jameson Raid produced a permanent estrangement between him and Cecil Rhodes, and he was out of sympathy with the new colonial secretary, Mr Chamberlain, who had criticized his appointment, and now desired Robinson to take this opportunity of settling the whole question of the position of the Uitlanders in the Transvaal. Robinson answered that the moment was inopportune, and that he must be left to choose his own time. Alarmed at the imminent danger of war, he confined his efforts to inducing the Johannesburgers to lay down their arms on condition that the raiders' lives were spared, not knowing that these terms had already been granted to Jameson. He came home to confer with the government, and was raised to the peerage as Baron Rosmead. He returned to South Africa later in the year, but was compelled by ill-health, in April 1897, to quit his post, and died in London on the 28th of October 1897, being succeeded in the title by his son.

ROSMINI-SERBATI, ANTONIO (1797-1855), Italian philosopher, was born at Rovereto in Italian Tirol on the 25th of March 1797. He belonged to a noble and wealthy family, but at an early age decided to enter the priesthood. After studying at Pavia and Padua, he took orders in 1821. In 1828 he founded a new religious order, the Institute of the Brethren of Charity, known in Italy generally as the Rosminians. The members might be priests or laymen, who devoted themselves to preaching, the education of youth, and works of charity—material, moral and intellectual. They have branches in Italy, England, Ireland, France and America. In London they are attached to the church of St Etheldreda, Ely Place, Holborn, where the English translation of Rosmini's works is edited. His works, *The Five Wounds of the Holy Church* and *The Constitution of Social Justice*, aroused great opposition, especially among the Jesuits, and in 1849 they were placed upon the Index. Rosmini at once declared his submission and retired to Stresa on Lago Maggiore, where he died on the 1st of July 1855. Before his death he had the satisfaction of learning that the works in question were dismissed, that is, proclaimed free from censure by the Congregation of the Index. Twenty years later, the word "dismissed" (*dimitantur*) became the subject of controversy, some maintaining that it amounted to a direct approval, others that it was purely negative and did not imply that the books were free from error. The controversy continued till 1887, when Leo XIII. finally condemned forty of his propositions and forbade their being taught.

In 1848 Rosmini took part in the struggle which had for its object emancipation from Austria, but he was not an initiator of the movement which ended in the freedom and unity of Italy. In fact, while eager for the deliverance of Italy from Austria, his aim was to bring about a confederation of the states of the country, which was to be under the control of the pope.

The most comprehensive view of Rosmini's philosophical standpoint is to be found in his *Sistema filosofico*, in which he set forth the conception of a complete encyclopaedia of the human knowable, synthetically conjoined, according to the order of ideas, in a perfectly harmonious whole. Contemplating the position of recent philosophy from Locke to Hegel, and having his eye directed to the ancient and fundamental problem of the origin, truth and certainty of our knowledge, he wrote: "The philosophy to be restored, in all respects, I think it will be necessary, in part, to return to the teachings of the ancients, and in part to give those teachings the benefit of modern methods" (*Theodicy*, n. 148). He examined and analysed the fact of human knowledge, and obtained the following results: (1) that the notion or idea of being or existence in general enters into, and is presupposed by, all our acquired cognitions, so that, without it, they would be impossible; (2) that this idea is essentially objective, inasmuch as what is seen in it is as distinct from and opposed to the mind that sees it as the light is from the eye that looks at it; (3) that it is essentially true, because "being" and "truth" are convertible terms, and because in the vision of it the mind cannot err, since error could only be committed by a judgment, and here there is no judgment, but a pure intuition affirming nothing and denying nothing; (4) that by the application of this essentially objective and true idea the human being intellectually perceives, first, the animal body individually conjoined with him, and then, on occasion of the sensations produced in him *not by himself*, the causes of those sensations, that is, from the action felt he perceives and understands a being, and therefore that being, which then acts on him, and he thus gets to the external world,—these are the true primitive judgments, containing (a) the subsistence of the particular being (subject), and (b) its essence or species as determined by the quality of the action felt from it (predicate); (5) that reflection, by separating the essence or species from the subsistence, obtains the full specific idea (universalization), and then from this, by leaving aside some of its elements, the abstract specific idea (abstraction); (6) that the mind, having reached this stage of development, can proceed to further and further abstracts, including the first principles of reasoning, the principles of the several sciences, complex ideas, groups of ideas, and so on without end; (7) finally, that the same most universal idea of being, this generator and formal element of all acquired cognitions, cannot itself be acquired, but must be innate in us, implanted by God in our nature. Being, as naturally shining to our mind, must therefore be what men call the light of reason. Hence the name Rosmini gives it of ideal being; and this he laid down as the fundamental principle of all philosophy and as the supreme criterion of truth and certainty. This he derived to be the teaching of St. Augustine, as well as of St. Thomas, of whom he was an ardent admirer and defender.

Of his numerous works, of which a collected edition in 17 volumes was issued at Milan (1842-44), supplemented by *Opere postume* in 5 vols. (Turin, 1859-74), the most important are the *New Essay on the Origin of Ideas* (Eng. trans., 1883); *The Principles of Moral Science* (1831); *The Restoration of Philosophy in Italy* (1836); *The Philosophy of Right* (1841-45). The following have also been translated into English: *A Catholic Catechism*, by W. S. Agar (1849); *The Five Wounds of the Holy Church* (abridged trans. with introd. by H. P. Liddon, 1883); *Maxims of Christian Perfection*, by W. A. Johnson (1889); *Psychology* (Anonymous) (1884-88); *Sketch of Modern Philosophy*, by Lockhart (1882); *The Ruling Principle of Method Applied to Education*, by Mrs W. Grey (Boston, Mass., 1887); *Select Letters*, by D. Gazzola. Rosmini's *Sistema filosofico* has been translated into English by Thos. Davidson (*Rosmini's Philosophical System*, 1882, with a biographical sketch and complete bibliography); see also *Lives* by G. S. Macwater (1885) and G. B. Pagani (1907); C. Werner, *Die Philosophie des Philosophen des Jahrhunderts* (1888); F. X. Kraus, "Antonio Rosmini: sein Leben, seine Schriften," in *Deutsche Rundschau*, liv. lv. (1888); "Church Reformation in Italy" in the *Edinburgh Review*, cxiv. (July 1861); and numerous recent Italian works, for which Baldwin's *Dictionary of Philosophy* or Pagiani's *Catologo Generale* (Milan, 1905) should be consulted.

ROSNY, JOSEPH HENRY, a pseudonym covering the collaboration of the French novelists, Joseph Henri Honoré Boix, born at Brussels in 1836, and his brother Séraphin Justin François Boix, born at Brussels in 1859. The novels of J. H. Rosny are full of scientific knowledge, of astronomy, anthropology, zoology and, above all, sociology. The stories are approached from the point of view of society rather than of the individual, but the characters, strongly individualized and intensely real, are only incidentally typical. The elder Rosny was the sole author of the earlier novels, and began novel-writing as an avowed disciple of Zola. *Nell Horn, membre de l'armée du salut* (1885) is a picture of London life and social reform; *Le Bilatral* (1886) and *Marc Fane* (1888) describe the revolutionary and anarchist parties of Paris; *L'Immolation* (1887) is a brutal story of peasant life; *Le Terme* (1890) is a picture of literary life in Paris; and *Vamirek* (1891), with *Erymak* (1895),

and *Les Profondeurs de Kyamo* (short stories, 1896) and others deal with prehistoric man. M.M. Rosny were among the writers who in 1887 entered a formal protest in the *Figaro* against Zola's *La Terre*, and they were designated by Edmond de Goncourt as original members of his academy. Among their later novels the more famous are: *Daniel Valgaire* (1891), a study in the possibilities of personal sacrifice; *L'Impérieuse Bonté* (1894), an indictment of Parisian charity; *L'Indompté* (1895), the history of a girl medical student in Paris; *Le Serment* (1896, dramatized 1897); *Les Ames perdues* (1899), another anarchist novel; *La Charpente* (1900); *Thérèse Degaudy* (1902); *Le Crime du docteur* (1903); *Le Docteur Haramour* (1904); *Le Millionnaire* (1905); and *Sous le fardeau* (1906).

ROSS, ALEXANDER (1699-1784), Scottish poet, was born on the 13th of April 1699 at Kincardine O'Neil, Aberdeenshire. He was educated at Marischal College, Aberdeen, and became tutor to the children of Sir William Forbes of Craigievar. He became in 1732 schoolmaster of Lochlee, Angus, where the rest of his life was spent. He had long been in the habit of writing verse for his own amusement, when in 1768 he published, at the suggestion of James Beattie, *The Fortunate Shepherdess*. . . . to which is (sic) added a few songs. This is a pastoral narrative poem, written in obvious imitation of Allan Ramsay's *Gentle Shepherd*. Its affectations are chiefly on the surface. The background of shepherd life as known to Ross, and the rather sordid motives of the characters, despite their high-sounding names of Heleneor, Rosalind, &c., are depicted with uncompromising truth. He died at Lochlee, and was buried on the 26th of May 1784.

See *Heleneor, or the Fortunate Shepherdess*, edited by John Longmuir (1866); also H. Walker, *Three Centuries of Scottish Literature* (1893), ii. 28-34. The bulk of Ross's writings remain in MS.

ROSS, GEORGE WILLIAM (1841-), Canadian politician, was born near Nairn, Middlesex county, Ontario, on the 18th of September 1841, the son of James Ross and Ellen M'Kinnon, natives of Ross-shire, Scotland. From 1872-1883 he was a Liberal member of the Federal House; from 1883-99 minister of education in the legislature of the province of Ontario; and from 1899-1905 premier and treasurer of that province. In 1905 his government was defeated, and in 1907 he retired to the Canadian Senate. He was for many years an advocate of total abstinence, and a well-known speaker on imperial questions.

ROSS, SIR HEW DALRYMPLE (1779-1868), British soldier, entered the Royal Military Academy, Woolwich, in 1793, and passed out into the Royal Artillery two years later. With the Royal Horse Artillery he saw active service during the Irish rebellion of 1798, and after eleven years' service was promoted captain and appointed to command "A" troop R.H.A. (afterwards famous as the "Chestnut Troop"). In 1809 the troop landed at Lisbon and at once set out to join Wellington's army, reaching the front two days after Talavera. Ross's guns were attached to the Light Division, and, with Craufurd, took part in the actions on the Coa and the battle of Busaco. When Masséna began his famous retreat from the lines of Torres Vedras, Ross's troop was amongst the foremost in the pursuit; at Redinha and Pombal, at Sabugal and Fuentes d'Onor, the "Chestnuts" earned great distinction, and in December 1811 their commander received a brevet-majority for his services. He was present at Ciudad Rodrigo and Badajoz, at the Salamanca forts and the battle of Salamanca, still attached to the Light Division. In the campaign of Vittoria, Ross's guns were continually with the most advanced troops, and after Vittoria they captured the only piece of artillery that remained to the defeated French. A further brevet-promotion and a good service reward came to Ross for his part in the campaign. At Vera in the Pyrenees Ross's troop was one of the three which played a decisive part in the action, and Vera remains a classical example of the action of horse artillery. "A" troop was engaged at St Pierre and Orthez, and at the conclusion of peace returned to England. It was engaged at Waterloo, and though half its guns were disabled the remainder

took part in the pursuit of the French. Ross received, besides the Peninsular and Waterloo medals, the K.C.B., the Portuguese order of the Tower and Sword and the Russian St Anne. He had commanded the troop for nineteen years when he at last received a regimental lieutenant-colonelcy. As officer commanding Royal Artillery in the Northern District, with delegated command over all the forces of the four northern counties, Sir Hew Ross had for nearly sixteen years to deal with continually threatened civil disorder, and bore himself as well as on the field of battle. From 1840 to 1858, when he retired, he practically directed, in one post or another, all the artillery services of the British army, and when in 1854 the test of war came, the artillery took the field in a far better condition than the rest of Lord Raglan's army. Much of the present efficiency of the "Royal Regiment" is directly traceable to the influence of Sir Hew Ross, to whom it owes the institution of the School of Gunnery at Shoeburyness and the establishment of the Royal Artillery Institution at Woolwich. Major-general in 1841 and lieutenant-general in 1851, he became general in 1854, and died, a field-marshal and G.C.B., in 1868.

See Memoir of the R.A. Institution, 1871; and Duncan, *History of the Royal Regiment of Artillery*.

ROSS, SIR JAMES CLARK (1800-1862), British rear-admiral and Polar explorer, was born in London on the 15th of April 1800. He entered the navy in 1812 under his uncle, Captain (afterwards Sir) John Ross, with whom he accompanied on his first Arctic voyage in search of a North-West passage (1818). Between 1819 and 1827 he returned four times to the same seas in the Arctic expeditions under Parry, and in 1829-33 again served on the same mission under his uncle, and while thus employed determined (1831) the position of the North Magnetic Pole. In 1834 he was promoted captain, and from 1835-38 was employed on the magnetic survey of Great Britain. In 1839-43 he commanded the Antarctic expedition of the "Erebus" and "Terror" (see POLAR REGIONS), and for this service he received a knighthood (1844) and was nominated to the French order of the Legion of Honour. He published a narrative of this expedition under the title of *A Voyage of Discovery and Research to Southern and Antarctic Regions* (1847), and was the author also of various reports on zoological and other matters relating to his earlier voyages. He was elected to the Royal Society in 1848, and in that year made his last expedition, as captain of the "Enterprise," in the first Franklin search expedition. He died at Aylesbury on the 3rd of April 1862.

ROSS, JOHN, or KOESKOOWE (1790-1866), chief of the Cherokee Indian Nation, was of Scotch-Indian descent, and was born among the Cherokees in Georgia in 1790. In 1819-1827 he was president of the Cherokee national committee, in July 1827 he presided over the Cherokee constituent assembly, and under the constitution which it drafted he was principal chief from 1828 until his death. In 1830-31 he applied to the Supreme Court of the United States for an injunction restraining the state of Georgia from executing its laws within the Cherokee territory, but the court dismissed his suit on the ground that it had no jurisdiction. There was a small party among the Cherokees under the leadership of John Ridge, a subchief, who were early disposed to treat with the United States for the removal of their nation west of the Mississippi, and in February 1835, while negotiations with Ridge were progressing at Washington, Ross proposed to cede the Cherokee lands to the United States for \$20,000,000. The United States Senate resolved that \$5,000,000 was sufficient. The treaty negotiated by the Ridge party and the proposal to treat on the basis of a \$5,000,000-payment were both rejected in a full council of the Cherokees held in October 1835. The council authorized Ross to renew negotiations, but before leaving for Washington he was arrested by the Georgia authorities on the ground that he was a white man residing in the Indian country contrary to law. Ross was soon released, but in December of this year a few hundred Cherokees met the United States Indian commissioner at New Echota and concluded with him a treaty of removal. When Ross learned this he called a

council to meet in February 1836, and at this meeting the treaty was declared null and void and a protest against the proceedings at New Echota was signed by more than 12,000 Cherokees. Notwithstanding Ross's opposition, the Senate in the following May ratified the treaty by a vote exceeding by one the necessary two-thirds majority, and in December 1838, Ross, with the last party of Cherokees, left for the West (see GEORGIA). During the Civil War, Ross first urged upon the Cherokee Nation a policy of friendly inactivity; in May 1861, proclaimed a strict neutrality; in October 1861, signed a treaty with the Confederate States; in the summer of 1862 was forced (by Union sympathizers in the Nation) to proclaim neutrality again; soon afterwards went over to the Union lines; and was in Washington treating with the Federal government in February 1863 when the treaty with the Confederate States was abrogated by the Cherokees. He died at Washington on the 1st of August 1866.

See C. C. Royce, "The Cherokee Nation of Indians" in the *Fifth Annual Report of the Bureau of Ethnology* (Washington, 1887), and T. V. Parker, *The Cherokee Indians* (New York, 1907).

ROSS, SIR JOHN (1777-1856), British rear-admiral and Arctic explorer, son of the Rev. Andrew Ross, minister of Inch, Wigtownshire, entered the Royal Navy in 1786, serving in the Mediterranean till 1789, and afterwards in the Channel. In 1808 he acted as captain of the Swedish Fleet, and in 1812 was promoted commander. Six years later he was given the command of an Arctic expedition fitted out by the Admiralty, the first of a new series of attempts to solve the question of a North-West passage. This expedition failed to discover much that was new, and somewhat prejudiced the Arctic reputation of its leader, who attained the rank of captain on his return. But in 1829, through the munificence of Mr (afterwards Sir) Felix Booth, he was able to undertake a second Arctic expedition, which, during an absence of four years, achieved important geographical and scientific results. On his return Captain Ross was the recipient of gold medals from the English and French geographical societies, and of various foreign orders, including a knighthood of the Pole Star of Sweden, and in the following year (1834) received a knighthood and a C.B. at home. In 1850 he undertook a third voyage to the Arctic regions, this time in search of Sir John Franklin, and in the following year he attained flag-rank. His publications include—*Voyage of Discovery for the Purpose of Exploring Baffin's Bay* (1819); *Narrative of a Second Voyage in Search of a North-West Passage, including the Discovery of the North Magnetic Pole* (1835); *Memoirs and Correspondence of Lord De Saumarez* (1838).

ROSS, ROBERT (1766-1814), British major-general, entered the 25th Foot at the age of nineteen, and in 1795 became captain in the 7th Regiment, obtaining a half-pay majority a few months later. As a major of the 20th he served in Holland under the duke of York in 1799. At the action of Krabbendam the regiment greatly distinguished itself, though largely composed of raw militia recruits. Ross was here severely wounded. In 1801 the 20th went to Egypt and took part in the final operations which led to Menou's surrender. In 1803, though lieutenant-colonel only by brevet, Ross succeeded to the command, and at once initiated a severe system of training, in barracks and in the field, in his regiment. The result of this was apparent when under Sir John Stuart's command the regiment proceeded to Naples. The 20th played a decisive part in the brilliant action of Maida, and distinguished itself not less in the subsequent storm of the castle of Scylla. In 1808-9 Ross and the 20th formed part of Anstruther's brigade of Sir John Moore's army in Spain, and though the statement that the 20th, owing to its good discipline, suffered less loss than any other regiment in the retreat on Corunna is incorrect, the regiment was among the best disciplined in the army. Later in 1809 it was sent to Walcheren, where fever soon laid low two-thirds of the men. Ross and his regiment were then sent to Ireland to recover, and here the colonel repeated the course of drill and manoeuvre which had so markedly improved the 20th in Malta. He received a gold medal for Corunna and a sword of honour for Maida (which action had already won him a

gold medal). At the end of 1812 the 20th was again engaged in the Peninsula, and Major-General Ross early in the following year received a brigade command in Cole's division. Scarcely engaged at Vittoria, Ross's brigade played a distinguished part in the operations around Pamplona, and the 20th covered itself with glory at Roncesvalles and Sorrauren. At Orthez Ross was severely wounded at the head of the brigade, which was assaulting the village of St Boës. He was among those who received the thanks of parliament for this battle, and he received the gold medal for Vittoria and the Peninsula gold medal. At the end of the war Ross was sent in command of a brigade to harry the coast of North America, and with 4500 men and three light guns landed in Maryland. At Bladensburg the Americans stood to fight in a strong position, but Ross's men routed them (Aug. 24, 1814). The same evening Washington was entered, and the public buildings having been destroyed, the expedition re-embarked. This short and brilliant campaign excited the admiration of soldiers, critics and public alike, but the commander did not live to receive his reward. A few days later an expedition against Baltimore was undertaken; skirmishing soon began, and one of the first to fall was Ross. A public monument was erected to his memory in St Paul's Cathedral, and others at his residence at Rosstrevor and at Halifax, N.S. His family was granted the name Ross of Bladensburg by royal letters-patent.

See *Gentleman's Magazine*, 1814, ii. 483; Cole, *Peninsula Generals*; Smythe, *History of the 20th Regiment*.

ROSS, a market town in the Ross parliamentary division of Herefordshire, England; 133 m. W. by N. from London and 12 S.E. from Hereford by the Great Western railway. Pop. of urban district (1901) 3303. It occupies a fine position on and about a rocky eminence on the left bank of the river Wye. There are manufactures of machinery and agricultural implements, and trade in the products of the district, such as cider and malt, and several fairs are held annually. The church of St Mary the Virgin stands high, and is surmounted by a lofty spire; it shows good Decorated and Perpendicular work. A beautiful terrace called the Prospect adjoins the churchyard and overlooks the river. The market house, dated 1670, is a picturesque building supported on columns, the upper portion serving as a town hall. There are in the town many memorials of John Kyrle, the Man of Ross, who died here in 1724, and is eulogized by Pope in his third *Moral Epistle* (1732). The Prospect was acquired and laid out by Kyrle, who also planted the fine elm avenues near the church; his house stands opposite the market house, where he disbursed his charities; he erected the church spire, and is buried in the chancel, where his grave remained without a monument until Pope called attention to the omission. Nearly opposite the town is Wilton Castle, which defended the ford in the disturbed reign of Stephen, and suffered in the Civil Wars, being held for the Parliament and burned by the Royalists. The inhabited portion is modern. Four miles below Ross the important ford of Goodrich probably carried traffic in British and Roman times, and a magnificent castle, on a precipice rising sheer above the right bank of the river, commands it. The keep is doubtfully assigned to a date previous to the Conquest; the important position on the Welsh March led to several subsequent additions, especially in the 14th century, and the castle was only dismantled by order of the Parliamentarians after it had strongly resisted their arms on behalf of Charles I. in 1646, being the last to fall of the royal strongholds in this county.

Ross (*Ros*, *Rosse*) was granted to the see of Hereford by Edmund Ironside, but became crown property by an exchange effected in 1550. It derived importance from its situation on the road to South Wales. In 1305, only, it was represented in parliament by two members; but it was never incorporated, and was governed by appointees of the manor court, until the Ross Improvement Act of 1865 established elected commissioners of the borough. Fairs on the days of the Ascension, Corpus Christi, St Margaret and St Andrew were conferred by Henry III., and were in existence in 1888. A market every

Thursday was granted by Stephen and confirmed by Henry III.; Friday is now market day.

ROSS AND CROMARTY, a northern county of Scotland. The mainland portion is bounded N. by Sutherland and Dornoch Firth, E. by the North Sea and Moray Firth, S. by Beaulie Firth and Inverness-shire and W. by the strait of the Minch. The island portion, consisting of as much of the island of Lewis as lies north of a line drawn from Loch Resort to Loch Seafort, is bounded on the W., N. and E. by the Atlantic, and S. by Harris, the southern part of Lewis. Many islands, all but eleven uninhabited, are scattered principally off the west coasts of Lewis and the mainland. The area of the mainland is 1,572,294 acres and of the islands 404,413 acres, giving a total for the county of 1,976,707 acres or 3088.6 sq. m. The inhabited islands belonging to the mainland are all situated off the west coast. They are Gillean (lighthouse) in the parish of Lochalsh, Croulin in Applecross, Horisdale, Dry and Ewe in Gairloch parish, and Martin and Tanera More, of the group of the Summer Isles in the parish of Lochbroom. On the North Sea front the chief indentations are Beaulie Firth and Inner Moray Firth, marking off the Black Isle from Inverness-shire; Cromarty Firth, bounding the districts of Easter Ross and the Black Isle; Moray Firth, separating Easter Ross from Nairn-shire; and Dornoch Firth, dividing north-east Ross from Sutherlandshire. On the Atlantic face—which is a coastline of more than 300 m.—the principal sea lochs and bays, from S. to N., are Loch Duich, Loch Alsh, Loch Carron, Loch Kishorn, Loch Torridon, Loch Shieldaig, Upper Loch Torridon, Gairloch, Loch Ewe, Grunard Bay, Little Loch Broom and Enard Bay. The chief capes are Tarbat Ness on the east coast, and Coygach, Greenstone, Reidh, Red and Hamha Points on the west. Almost all the southern boundary with Inverness-shire is guarded by a rampart of peaks, among them being An Riabhachan (3696), Sgurr na Lapaich (3773), Carn Eige (3877), Mam Soul (3862), Ben Attow (3383), Scour Ouran (3505), famous for its view from the summit, Ben Mohr (3570) and the Saddle (3317). To the north of Glen Torridon occur the masses of the Liatach, with peaks of 3456 and 3358 ft., and Ben Eay with four peaks above 3000 ft. each. On the north-eastern shore of Loch Maree rises Ben Slioch (3217), while the Fannich group contains at least six peaks of more than 3000 ft. The immense isolated bulk of Ben Wyvis (3429), and its subordinate peaks An Socach (3205) and An Cabar (3106), is the most noteworthy feature in the north-east, and the Challich Hills in the north-west with peaks of 3483 and 3474 ft. are equally conspicuous, though less solitary. Only a small fraction of western and southern Ross is under 1000 ft. in height. Easter Ross and the peninsula of the Black Isle are comparatively level. The longest stream is the Orrin, which rises in An Sithean and pursues a course mainly E. by N. to its confluence with the Conon after a run of about 26 m., during a small part of which it forms the boundary with Inverness-shire. At Aultgowrie the stream rushes through a narrow gorge where the drop is considerable enough to make the falls of Orrin. From its source in the mountains in Strathvaich the Blackwater flows S.E. for 19 m. till it joins the Conon, forming soon after it leaves Loch Garve the small but picturesque falls of Rogie. Within a short distance of its exit from Loch Luichart the Conon pours over a series of graceful cascades and rapids and then pursues a winding course of 12 m., mainly E. to the head of Cromarty Firth. The falls of Glomach, in the south-west, are the deepest in the United Kingdom. The stream giving rise to them drains a series of small lochs on the northern flanks of Ben Attow and, in an almost unbroken sheet about 40 ft. broad, effects a sheer leap of 370 ft., and soon afterwards ends its course in the Elchaig. The falls are usually visited from Invershill, 7 m. to the south-west. Twelve miles south by east of Ullapool, on the estate of Braemore, are the falls of Measach, formed by the Droma, a head-stream of the Broom. The cascades, three in number, are close to the gorge of Corriehalloch. The Oyckell, throughout its course, forms the boundary with Sutherlandshire, to which

it properly belongs. The largest and most beautiful of the many freshwater lakes is Loch Maree (*q.v.*), but a few of the others are interesting. In the far north-west, 243 ft. above the sea, lies Loch Skinaskink, a lake of such irregularity of outline that it has a shore-line of 17 m. It contains several islands covered with rich woods affording a shelter to deer, and drains into Enard Bay by the Polly. Lochan Fada (the "long loch"), 1005 ft. above the sea, is $3\frac{1}{2}$ m. in length, has a greatest breadth of $\frac{1}{2}$ m., covers an area of 113 sq. m., and is 248 ft. deep, with a mean depth of 102 ft. Once drained by the Muic, it has been tapped a little farther west by the Fhasaigh, which has lowered the level of the lake sufficiently to behead the Muic. Other lakes are, north of Loch Maree, Loch Fionn (the "white" or "clear" lake), 8 m. long by 1 m. wide, famous for its heronries; towards the centre of the shire, Loch Luichart (5 m. long by from $\frac{1}{2}$ m. to nearly 1 m. wide), fringed with birches and having the shape of a crescent; the mountain-girt Loch Fannich (7 m. long by 1 m. wide); and the wild narrow lochs Monar (4 m. long) and Mullardoch (5 m. long), on the Inverness-shire boundary. Of the straths or valleys the more important run from the centre eastwards, such as Strathconon (12 m.), Strathbran (10 m.), Strathgarve (8 m.), Strathpeffer (6 m.) and Strathcarron (14 m.). Excepting Glen Orrin (13 m.), in the east central district, the longer glens lie in the south and towards the west. In the extreme south Glen Shiel (9 m.) runs between fine mountains to its mouth on Loch Duich. General Wade's road passes down the glen. Farther north are Glen Elchaig (9 m.), Glen Carron (12 m.), in the latter of which the track of the Dingwall & Skye railway is laid, and Glen Torridon (6 m.).

Geology.—The central portion of this county is occupied by the younger highland schists or Dalradian series. These consist of quartzites, mica-schists, garnetiferous mica-schists and gneisses, all with a gentle inclination towards the S.E. On the eastern side of the county the Dalradian schists are covered, conformably by the Old Red Sandstone; the boundary runs southward from Edderton on Dornoch Firth, by Strathpeffer, to the neighbourhood of Beaulieu. These rocks comprise red flags and sandstones, grey bituminous flags and shales. An anticlinal fold with a S.W.-N.E. axis brings up the basal beds of the series about the mouth of Cromarty Firth and exposes once more the schists in the Sutors guarding the entrance to the firth. The western boundary of the younger schist is formed by the great pre-Cambrian dislocation line which traverses the county in a fairly direct course from Elphin on the north by Ullapool to Glencairn. Most of the area west of the line of disturbance is covered by Torridonian Sandstone, mainly dark reddish sandstones, grits and shales, resting unconformably on the ancient Lewisian gneiss with horizontal or slightly inclined bedding. The unconformity is well exposed on the shores of Gairloch, Loch Maree and Loch Torridon. These rocks, which attain a considerable thickness and are divisible into three sub-groups, build up the mountain districts about Applecross, Coigach and elsewhere. Within the Torridonian tract the older, Lewisian gneiss occupies large areas north of Coigach, on the east of Enard Bay, between Gruinard Bay and Loch Maree; between the coasts named Gairloch, on both sides of middle Loch Torridon and at many other spots; smaller patches are to be found. The Lewisian gneiss is everywhere penetrated by basic dikes, generally with a N.W.-S.E. direction; some of these are of great breadth. The Torridonian rocks are succeeded unconformably by a series of Cambrian strata which is confined to a variable but, on the whole, narrow belt lying west of the line of main thrusting. This belt of Cambrian rocks has itself suffered an enormous amount of subordinate thrusting. It is composed of the following subdivisions in ascending order: false-bedded quartzite ("Pipe Rock"), quartzite, fossiliferous sandstone, sand, serpulite grit, Durness dolomite and marble, Durness dolomite and limestone: but these are not always visible at any one spot. So great has been the disturbance in the region of thrusting that in some places, as in the neighbourhood of Loch Kishorn and elsewhere, the rocks have been completely overturned and the ancient gneiss has been piled upon the Torridonian. On the shore of Moray Firth at Rathie a small patch of Kimeridge shale occurs; and beneath the cliffs of Shandwick there is a little Lower Oolite with a thin seam of coal. Glacial striae are found upon the mountains up to a height of 3000 ft., and much boulder clay is found in the valleys and spread over large areas in the eastern districts. Raised beaches occur at 100, 50 and 25 ft. above the present sea-level; they are well seen in Loch Carron. Lewis, on Long Island, is made almost entirely of ancient "Lewisian gneiss," but a little Torridonian occurs about Stornoway.

Climate and Agriculture.—On the west coast the rainfall is excessive, averaging for the year 50-42 in. at Loch Broom and

62 in. at Strome Ferry (autumn and winter being the wettest seasons), but on the east coast the annual is only mean 27 in. The temperature for the year is 46°-5° F. for January 38° F. and for July 57° F. The most fertile tracts lie on the eastern coast, especially in Easter Ross and the Black Isle, where the soil varies from a light sandy gravel to a rich deep loam. Among grain crops oats is that most generally cultivated, but barley and wheat are also raised. Turnips and potatoes are the chief green crops. On the higher grounds there is a large extent of good pasturage which carries heavy flocks of sheep, blackfaced being the principal breed. Most of the horses, principally half-breds between the old garrons (hardy, serviceable, small animals) and Clydesdales, are maintained for the purposes of agriculture. The herds of cattle, mainly native Highland or crosses, are large, many of them supplying the London market. Pigs are reared, though in smaller numbers than formerly, most generally by the crofters. Owing partly to the overcrowding of the island of Lewis and partly to the unkindly nature of the bulk of the soil—which offers no opportunity for cover than patchwork tillage—the number of small holdings is enormous, Sutherlandshire alone amongst Scottish counties showing an even larger proportion of holdings under 5 acres; while the average size of all the holdings throughout the shire does not exceed 20 acres. About 800,000 acres are devoted to deer forests, a greater area than in any other county in Scotland, among the largest being Achnesshallach (50,000 acres), Fannich (20,000), Kinlochluichart (20,000), Braemore (40,000), Inchbae (21,000) and Dundonnell (23,000). At one time the area under moor was remarkably large, if we accept the common derivation of the word "Ross" (as from the Irish *ros*, "the wood"), and there is still a considerable extent of native woodland, principally fir, oak, ash and alder. The fauna is noteworthy. Red and roe deer abound, and foxes and alpine hares are common, while badgers and wild cats are occasionally trapped. Winged game are plentiful, and amongst birds of prey the golden eagle and osprey occur. Waterfowl of all kinds frequent the sea lochs; many rivers and lakes are rich in salmon and trout, and the pearl mussel is found in the bed of the Conon.

Other Industries.—Apart from agriculture, the fisheries are the only considerable industry; the county containing two fishery districts—Stornoway and Cromarty—and portions of two others—Loch Broom (the remainder belonging to Sutherlandshire) and Loch Carron (which includes part of Inverness-shire). Herring, cod and ling form the principal catch, while salmon are taken in large quantities in the bays and at the mouth of rivers. Distilleries are found near Dingwall, Tain and some other places, and there are manufactures, on a very limited scale, of woollens, chemical manures and aerated waters, besides some sandstone quarrying and flour mills. At Muir of Ord, in the parish of Urray, are held great horse, cattle and sheep markets.

The Highland railway entering the county to the north of Beaulieu runs northwards to Dingwall, and then strikes off to the north-east by Invergordon and Tain, where it bends to the west by north, leaving the shire at Culrain, having largely followed the coast throughout. At Muir of Ord it sends off the Black Isle branch and at Dingwall a branch to Strathpeffer, as well as a line to Strome Ferry and Kyle of Lochalsh on the south-western shore. Coaches connect various districts with stations on the Dingwall & Skye railway.

Population and Administration.—The population of the county in 1801 was 78,727, and in 1901 that of the mainland was 47,501, and of the islands 28,949, an aggregate of 76,450 or 25 to the sq. m. Thus Ross and Cromarty, though the third largest in size, is the least populated county in Scotland, excepting Sutherland, Inverness and Argyll. In 1901 there were 12,717 persons who spoke Gaelic only (of whom 9928 belonged to the islands) and 39,392 speaking Gaelic and English (of whom 15,900 were insular). The chief towns and villages are Stornoway (pop. 2854), Dingwall (2485), Fortrose (1322), Tain (2067), Cromarty (1242), Invergordon (1085). Ullapool is a small fishing port near the mouth of Loch Broom. For administrative purposes the county is divided into six districts, namely, Black Isle (pop. 6271), Easter Ross (12,192), Lewis (28,760), Mid Ross (12,953), South-Western Ross (4103) and Western Ross (5394). The county returns one member to parliament, and Cromarty, Dingwall and Tain belong to the Wick group of parliamentary burghs, and Fortrose to the Inverness group. Excepting Cromarty, these are royal burghs, and Dingwall is the county town. Ross and Cromarty forms a sheriffdom with Sutherlandshire, and there are resident sheriffs-substitute at Dingwall and Stornoway, the former also sitting at Tain and Cromarty. The shire is under school-board control, and there are academies at Tain, Dingwall and Fortrose, while several schools earn grants for higher education. The county council gives the "residue" grant

to the committee on secondary education, which subsidizes science and art classes in various schools and higher grade science schools at Dingwall, Tain and Stornoway.

History.—It may be doubted whether the Romans ever effected even a temporary settlement in the area of the modern county. At that period, and for long afterwards, the land was occupied by Gaelic Picts, who, in the 6th and 7th centuries, were converted to Christianity by followers of St Columba. Throughout the next three centuries the natives were continually harassed by Norse pirates, of whose presence tokens have survived in several place-names (Dingwall, Tain, &c.). At this time the country formed part of the great province of Moray, which then extended as far north as Dornoch Firth and the Oykel, and practically comprised the whole of Ross and Cromarty, excepting a comparatively narrow strip on the Atlantic seaboard. When the rule of the Celtic *maormors* or earls ceased in the 12th century, consequent on the plantation of the district with settlers from other parts (including a body of Flemings), by order of David I., who was anxious to break the power of the Celts, the bounds of Moravia were contracted and the earldom of Ross arose. At first Ross proper only included the territory adjoining Moray and Dornoch Firths. The first earl was Malcolm MacBeth, who received the title from Malcolm IV. After his rebellion in 1170 chronic insurrection ensued, which was quelled by Alexander II., who bestowed the earldom on Farquhar Macintaggart (Farquhar, son of the priest), then abbot of Applecross, and in that capacity lord of the western district. William, 4th earl, was present with his clan at the battle of Bannockburn (1314), and almost a century later (1412) the castle of Dingwall, the chief seat on the mainland of Donald, lord of the Isles, was captured after the disastrous fight at Harlaw in Aberdeenshire, which Donald had provoked when his claim to the earldom was rejected. The earldom reverted to the crown in 1424, but James I. soon afterwards restored it to the heiress of the line, the mother of Alexander MacDonald, 3rd lord of the Isles, who thus became 11th earl. In consequence, however, of the treason of John Macdonald, 4th and last lord of the Isles and 12th earl of Ross, the earldom was again vested in the crown (1476). Five years later James III. bestowed it on his second son, James Stewart, whom he also created duke of Ross in 1488. By the 16th century the whole area of the county was occupied by different clans. The Rosses held what is now Easter Ross; the Munroes the small tract around Ben Wyvis, including Dingwall; the Macleods Lewis, and, in the mainland, the district between Loch Maree and Loch Torridon; the MacDonalds of Glengarry, Coygach, and the district between Strome Ferry and Kyle of Lochalsh, and the Mackenzies the remainder. The county of Ross was constituted in 1661, and Cromarty in 1685 and 1698, both being consolidated into the present county in 1880 (see CROMARTY, county). Apart from occasional conflicts between rival clans, the only battles in the shire were those of Invercarroll, at the head of Dornoch Firth, when Montrose was crushed by Colonel Strachan on the 27th of April 1650, and Glenishiel, when the Jacobites, under the earl of Seaforth, aided by Spaniards, were defeated, at the pass of Strachel, near Bridge of Shiel, by General Wightman on the 11th of June 1719.

Antiquities.—The principal relics of antiquity—mainly stone circles, cairns and forts—are found in the eastern district. A vitrified fort crowns the hill of Knockfarrel in the parish of Fofderty, and there is a circular dun near the village of Lochcarroll. Some fine examples of sculptured stones occur, especially those which, according to tradition, mark the burial-place of the three sons of a Danish king who were shipwrecked off the coast of Nigg. The largest and handsomest of these three crosses—the *clach-a-charridh*, or Stone of Lamentation—stands at Shandwick. It is about 9 ft. high and contains representations of the martyrdom of St Andrew and figures of an elephant and dog. It fell during a storm in 1847 and was broken in three pieces. On the top of the cross in Nigg churchyard was two figures with outstretched arms in the act of supplication; the dove descends between them, and below are two dogs. The cross was knocked down by the fall of the belfry in 1725, but has been riveted together. The third stone formerly stood at Cadboll of Hilltown, but was removed for security to the grounds of

Invergordon Castle. Among old castles are those of Lochslin, in the parish of Fearn, said to date from the 13th century, which, though ruinous, possesses two square towers in good preservation; Balone, in the parish of Tarbat, once a stronghold of the earls of Ross; the remains of Dingwall Castle, their original seat; and Eilean Domain in Loch Aish, which was blown up by English warships during the abortive Jacobite rising in 1719.

See R. Bain, *History of the Ancient Province of Ross* (Dingwall, 1899); J. H. Dixon, *Gairloch* (Edinburgh, 1888); F. N. Reid, *The Earls of Ross* (Edinburgh, 1894); W. C. Mackenzie, *History of the Outer Hebrides* (Paisley, 1904).

ROSSANO, a city of Calabria, Italy, in the province of Cosenza, 24 m. N.N.E. from that town direct, with a station 4 m. distant on the line from Metaponto to Reggio. Pop. (1901) 13,354. It is picturesquely situated on a precipitous spur of the mountain mass of Sila overlooking the Gulf of Taranto, the highest part of the town being 975 ft. above sea-level. Rossano is the seat of an archbishop, and in the cathedral is preserved the *Codex Rossanensis*, an uncial MS. of the Gospels of Matthew and Mark in silver characters on purple vellum, with twelve miniatures, of great interest in the history of Byzantine art, belonging to the 6th century A.D. It was brought to Grottaferrata (*q.v.*) for the exhibition of Byzantine art held there in 1905. Marble and alabaster quarries are worked in the neighbourhood.

Mentioned in the Itineraries, Rossano (*Roscianum*) appears under the Latin empire as one of the important fortresses of Calabria. Totila took it in 548. The people showed great attachment to the Byzantine empire. In the 14th century Rossano was made a principality for the great family of De Baux. Passing to the Sforza, and thus to Sigismund of Poland, it was united in 1558 to the crown of Naples by Philip II. of Spain in virtue of a doubtful will by Bona of Poland in favour of Giovanni Lorenzo Pappacoda. Under Isabella of Aragon and Bona of Poland the town had been a centre of literary culture; but under the Spaniards it declined. The crown sold the lordship in 1612 to the Aldobrandini, and from them it passed to the Borghesi and the Caraffa. Rossano is best known as the birthplace of St Nilus the younger, whose life is the most valuable source of information extant in regard to the state of matters in southern Italy in the 10th century. Pope John VII. (705-7) was also a native of the town.

See F. Lenormant, *La Grande-Grece* (1881), vol. i. 339 sqq.

ROSSBACH, a village of Prussian Saxony in the district of Merseburg, 8 m. S.W. of that place and N.W. of Weissenfels, famous as the scene of Frederick the Great's victory over the allied French and the army of the Empire on the 5th of November 1757. For the events preceding the battle see SEVEN YEARS' WAR. The Prussian camp on the morning of the 5th lay between Rossbach (left) and Bedra (right), facing the Allies, who, commanded by the French general, Charles de Rohan, prince de Soubise (1715-1787), and Joseph Frederick William, duke of Saxe-Hildburghausen (1702-1787), General Feldzeugmeister of the Empire, had manoeuvred in the preceding days without giving Frederick an opportunity to bring them to action, and now lay to the westward, with their right near Branderoda and their left at Mûcheln (see sketch). The advanced posts of the Prussians were in the villages immediately west of their camp, those of the Allies on the Schortau hill and the Galgenberg.

The Allies possessed a numerical superiority of two to one in the battle itself, irrespective of detachments,¹ and their advanced post overlooked all parts of Frederick's camp. They had had the best of it in the manoeuvres of the previous days, and the duke of Hildburghausen determined to take the offensive. He had some difficulty, however, in inducing Soubise to risk a battle, and the Allies did not begin to move off their camping-ground until after eleven on the 5th, Soubise's intention being probably to engage as late in the day as possible, with the

¹ V. der Goltz (*Rosbach bei Jena*, 1906 edition) gives 41,000 Allies and 21,600 Prussians as the combatant strengths. Berndt's statistical work, *Zahl im Kriege*, gives the respective forces engaged as Allies 43,000, Prussians 21,000. Other accounts give the Allies' total strength as 64,000 and the Prussians' as 24,000.

idea of gaining what advantages he could in a partial action. The plan was to march the Allied army by Zeuchfeld, round Frederick's left (which was covered by no serious natural obstacle), and to deploy in battle array, facing north, between Reichardtswerben (right) and Pettstädt (left). The duke's proposed battle and the more limited aim of Soubise were equally likely to be attained by taking this position, which threatened to cut off Frederick from the towns on the Saale. This position, equally, could only be gained by marching round the Prussian flank, *i.e.* by a flank march before the enemy. The obvious risk of interference on the exposed flank was provided against by a considerable flank guard, and in fact it was not in the execution of their original design but in hastily modifying it to suit unfounded assumptions that the Allies met with disaster.

Frederick spent the morning watching them from a house-top in Rossbach. The initial stages of their movement convinced him that the Allies were retreating southward towards their magazines, and about noon he went to dinner, leaving Captain von Gaudi on the watch. This officer formed a different impression of the Allies' intentions, for the columns which from time to time became visible in the undulations of the ground were seen to turn eastwards from Zeuchfeld. Gaudi's excited report at first served only to confirm Frederick in his error. But when the king saw for himself that hostile cavalry and infantry were already near Pettstädt, he realized the enemy's intentions. The battle for which he had manoeuvred in vain was offered to him, and he took it without hesitation. Leaving a handful of light troops to oppose the French advanced post (or flank guard) on the Schortau hill, the Prussian army broke camp and moved—half an hour after the king gave the order—to attack the enemy. The latter were marching in the normal order in two main columns, the first line on the left, the second line on the right; farther to the right was a column consisting of the reserve of foot, and between the first and second lines was the reserve artillery on the road. The right-wing cavalry was of course at the head, the left-wing cavalry at the tail of the two main columns. At first the regulation distances were preserved, but when wheeling eastward at Zeuchfeld there was much confusion, part of the reserve infantry getting in between the two main columns and hampering the movements of the reserve artillery, and the rest, on the outer flank of the wheel, being unable to keep up with the over-rapid movement of the wheeling pivot. A weak flank guard was thrown out towards Rossbach. When it was seen that the Prussians were moving, as far as could be judged, eastward, it was presumed that they were about to retreat in order to avoid being taken in flank and rear; and the Allied generals thereupon hurried the march, sending on the leading (right-wing) cavalry towards Reichardtswerben, and calling up part of the left-wing cavalry from the tail of the column, and even the flank-guard cavalry, to take part in the general chase. That Frederick's move meant an attack upon them before they could form up, Soubise and the duke failed to realize. They had taken more than three hours to break camp, and found it difficult to suppose that Frederick's army could move off in one hour at that time. It was obvious moreover, that the Prussians were not deploying for battle on the plain in front of Rossbach and Nahlendorf.

Frederick had no intention either of forming up parallel to the enemy or of retreating. As his army could move as a unit twice as fast as the enemy's, he intended to make a détour, screened by the Janus Hügel and the Pölzen Hügel, and to fall upon them suddenly from the east. If at the moment of contact the Allies had already formed their line of battle facing north, the attack would strike their right flank; if they were still on the move in column eastwards or north-eastwards, the heads of their columns would be crushed before the rest could deploy in the new direction—deployment in those days being a lengthy affair. To this end General von Seydlitz, with every available squadron, hurried eastward from Rossbach, behind the Janus Hügel, to the Pölzen Hügel; Colonel von Moller, with eighteen heavy guns, came into action on the Janus Hügel at 3.15 against the advancing columns of the Allied cavalry; and the infantry followed as fast as possible. When they came under the fire of Moller's guns, the Allied squadrons, which were now north of Reichardtswerben and well ahead of their own infantry, suffered somewhat heavily; but it was usual to employ heavy guns to protect a retreat, and they contented themselves with bringing some field-guns into action. They were, however, amazed when Seydlitz's thirty-eight squadrons suddenly rode down upon the head and right flank of their columns from the Pölzen Hügel *avec une incroyable vitesse*. Gallantly as the leading German regiments deployed to meet him, the result was scarcely in doubt for a moment. Seydlitz threw in his last squadron, and then himself fought like a trooper, receiving a severe wound. The mêlée drifted rapidly southward, past the Allied infantry, and Seydlitz finally rallied his horsemen in a hollow near Tagewerben, ready for fresh service. This first episode was over in half an hour, and by that time the Prussian infantry, in echelon from the left, was descending the Janus Hügel

to meet the already confused and disheartened infantry of the Allies. The latter, as their cavalry had done, managed to deploy some regiments on the head of the column, and the French in particular formed one or two columns of attack—then peculiar to the French army—and rushed forward with the bayonet. But Moller's guns, which had advanced with the infantry, tore gaps in the close masses, and, when it arrived within effective musketry range, the attack died out before the rapid and methodical volleys of the Prussian line. Meanwhile the Allies were trying in vain to form a line of battle. The two main columns had got too close together in the advance from Pettstädt, part of the reserve which had become entangled between the main columns was extricating itself by degrees and endeavouring to catch up with the rest of the reserve column away to the right, and the reserve artillery was useless in the middle of the infantry. The Prussian infantry was still in

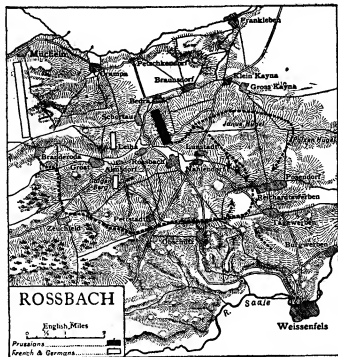

echelon from the left, and the leftmost battalions that had repulsed the French columns were quickly within musket-shot of this helpless mass. A few volleys directed against the head and left flank of the column sufficed to create disorder, and then from the Tagewerben hollow Seydlitz's rallied squadrons charged, wholly unexpectedly, upon its right flank. The Allied infantry thereupon broke and fled. Soubise and the duke, who was wounded, succeeded in keeping one or two regiments together, but the rest scattered over the countryside. The battle had lasted less than an hour and a half, and the last episode of the infantry fight no more than fifteen minutes. Seven Prussian battalions only were engaged, and these expended five to fifteen rounds per man. Seydlitz and Prince Henry of Prussia, the cavalry and the infantry leaders engaged, were both wounded, but the total loss of the king's army was under 550 officers and men as compared with 7700¹ on the part of the Allies. (C. F. A.)

ROSSE, EARL OF, a title borne by the Irish family of Parsons. James Parsons, a native of Leicestershire, who flourished in the 16th century, was the father of Sir William Parsons (c. 1570-1650), one of the lords justices of Ireland. Having crossed to Ireland in early life, William Parsons became surveyor-general in 1602 and obtained land in various parts of the country. In 1620 he was made a baronet; in 1643 he was deprived of his office as lord justice, and he died early in 1650. His great-grandson, Sir Richard Parsons, bart. (c. 1657-1703), was created Baron Oxmantown and Viscount Rosse in 1681, and Richard's son and successor, Richard (d. 1741), was made earl of Rosse in 1718. The titles became extinct when Richard, the 2nd earl, died in August 1764.

Sir William Parsons had two brothers, Sir Lawrence and Sir Fenton Parsons. Sir Lawrence, second baron of the Irish exchequer, left a son, William (d. 1653), who defended Birr Castle, King's County, for over a year against the Irish during

¹ Figures again vary in different authorities. The above figure is that given by Berndt, *Zahl im Kriege*.

the rebellion of 1641, and whose son, Sir Lawrence Parsons (d. 1698), was made a baronet in 1677. This Sir Lawrence was a strong Protestant, and was found guilty of high treason, being attainted and sentenced to death during the brief period of James II.'s ascendancy in Ireland. He was not executed, however, and afterwards he took some part in the struggle against the supporters of James II. His descendant, Lawrence Harman Parsons (1749-1807), was created Baron Oxmantown in 1792, Viscount Oxmantown in 1795, and earl of Rosse in 1806. He died on the 20th of April 1807, and was succeeded by his nephew Lawrence.

Lawrence Parsons, 2nd earl of Rosse (1758-1841), the eldest son of Sir William Parsons, bart. (d. 1791), of Birr Castle, was born on the 21st of May 1758. Educated at Trinity College, Dublin, he entered the Irish parliament as member for the university in 1782, and soon came to the front in debate. A friend and follower of Henry Flood, he has been described as "one of the very, very few honest men in the Irish House of Commons." He favoured some measure of relief to Roman Catholics and also parliamentary reform, a speech which he delivered on this question in 1793 being described by W. E. H. Lecky as "exceedingly valuable to students of Irish history"; but he disliked and opposed the union of the parliaments of Great Britain and Ireland. After this event, however, he represented King's County in the united parliament until 1807, and he was a representative peer for Ireland from 1809 to 1841. He died at Brighton on the 24th of February 1841. Rosse wrote *Observations on the Bequest of Henry Flood to Trinity College, Dublin, with a Defence of the Ancient History of Ireland* (Dublin, 1795). His eldest son was the astronomer William Parsons, 3rd earl of Rosse (see below).

ROSSE, WILLIAM PARSONS, 3RD EARL OF (1800-1867), Irish astronomer and telescope constructor, was born at York on the 17th of June 1800, a son of the 2nd earl (see above). Until his father's death he was known as Lord Oxmantown. Entered at Trinity College, Dublin, in 1818, he proceeded to Magdalen College, Oxford, in 1821, and in the same year he was returned as M.P. for King's County, a seat which he resigned in 1834. He was Irish representative peer from 1845, president of the British Association in 1843, president of the Royal Society from 1849 to 1854, and chancellor of the university of Dublin from 1862. From 1827 he devoted himself to the improvement of reflecting telescopes; in 1839 he mounted a telescope of 3 ft. aperture at his seat, Birr Castle, Parsonstown; and in February 1845 his celebrated 6-foot reflector was finished. Owing to the famine and the disturbed state of the country, which demanded his attention as a large landowner and lieutenant of King's County (from 1831), the instrument remained unused for nearly three years, but since 1848 it has been in constant use, chiefly for observations of nebulae, for which it was particularly suited on account of its immense optical power, nominally 6000. Lord Rosse died at Monkstown on the 31st of October 1867. He had four sons. The eldest, Lawrence Parsons, 4th earl of Rosse, and Baron Oxmantown, born on the 17th of November 1840, succeeded to the title on his father's death, and made many investigations on the heavenly bodies, particularly on the radiation of the moon and related physical questions; the youngest, the Hon. Charles Algernon Parsons, born on the 13th of June 1854, is famous for his commercial development of the steam turbine.

The first constructor of reflecting telescopes on a large scale, William Herschel, never published anything about his methods of casting and polishing specula, and he does not appear to have been very successful beyond specula of 18 in. diameter, his 4-foot speculum ("the 40-foot telescope") having been little used by him (see discussion between Sir J. Herschel and Robinson in *The Athenaeum*, Nos. 821-36, 1845). Lord Rosse had therefore no help towards his brilliant results. His speculum metal is composed of four atoms of copper (126.4 parts) and one of tin (58.9 parts), a brilliant alloy, which resists tarnish better than any other compound tried. Chiefly owing to the brittleness of this material, Lord Rosse's first larger specula were composed of a number of thin plates of speculum metal (sixteen for a 3-foot mirror) soldered on the back of a strong but light framework made of a peculiar kind of brass (2.75 of copper to 1 of zinc), which has the same expansion as his speculum

metal. In Brewster's *Edinburgh Journal of Science* for 1828 he described his machine for polishing the speculum, which in all essential points remained unaltered afterwards. It imitates the motions made in polishing a speculum by hand by giving both a rectilinear and a lateral motion to the polisher, while the speculum revolves slowly; by shifting two eccentric pins the course of the polisher can be varied at will from a straight line to an ellipse of very small eccentricity, and a true parabolic figure can thus be obtained. The speculum lies face upwards in a shallow bath of water (to preserve a uniform temperature), and the polisher fits loosely in a ring, so that the rotation of the speculum makes it revolve also, but more slowly. Both the grinding and polishing tools are grooved, to obtain a uniform distribution of the emery used in the grinding process and of the rouge employed in polishing, as also to provide for the lateral expansion of the pitch with which the polisher is coated. In September 1839 a 3-foot speculum was finished and mounted on an altazimuth stand similar to Herschel's; but, though the definition of the images was good (except that the diffraction at the joints of the speculum caused minute rays in the case of a very bright star), and its peculiar skeleton form allowed the speculum to follow atmospheric changes of temperature very quickly, Lord Rosse decided to cast a solid 3-foot speculum. Hitherto it had been felt as a great difficulty in casting specula that the solidification did not begin at one surface and proceed gradually to the other, the common sand mould allowing the edges to cool first, so that the central parts were subject to great straining when the time of cooling came, and in large castings this generally caused cracking. By forming the bottom of the mould of fine iron sand on edge and closely packed, and the sides of sand, while the top was left open, Lord Rosse overcame this difficulty, and the hoop iron had the further advantage of allowing the gas developed during the cooling to escape, thus preventing the speculum from being full of pores and cavities. This invention secured the success of the casting of a solid 3-foot speculum in 1840, and encouraged Lord Rosse to make a speculum of 6 ft. diameter in 1842. In the beginning of 1845 this great reflector was mounted and ready for work. The instrument has a focal length of 54 ft. and the tube is about 7 ft. in diameter; owing to these large dimensions it cannot be pointed to every part of the heavens, but can only be moved a short distance from the meridian and very little to the north of the zenith; these restrictions have, however, hardly been felt, as there is almost at any moment a sufficient number of objects within its reach.

From 1848 to 1878 it was but with few interruptions employed for observations of nebulae (see NEBULAE); and many previously unknown features in these objects were revealed by it, especially the similarity of the form of the spiral arms of nebulae, and the remarkable "spiral" configuration prevailing in many of the brighter nebulae. A special study was made of the nebula of Orion, and the resulting large drawing gives an extremely good representation of this complicated object. (See TELESCOPE.)

Lord Rosse gave a detailed account of the experiments which step by step had led to the construction of the 3-foot speculum in the *Philosophical Transactions* for 1840. In the same publication for 1844 and 1850 he communicated short descriptions and drawings of some of the more interesting nebulae, and in the volume for 1861 he published a paper "On the Construction of Specula of 6-ft. Aperture, and a Selection from the Observations of Nebulae made with them," with numerous engravings. The accounts of the observations given in these papers, however, were fragmentary; but in 1879-80 a complete account of them was published by the present earl ("Observations of Nebulae and Clusters of Stars made with the 6-foot and 3-foot Reflectors at Birr Castle from 1848 to 1878") in the *Scient. Trans. R. Dublin Soc.* vol. ii. The drawing of the nebula of Orion was published in the *Phil. Trans.* for 1868. See observations in the *Phil. Trans.* (1866), 16, 36, and in the *Monthly Notices of Roy. Astr. Soc.* vol. 20, p. 123.

ROSSELLI, COSIMO (1439-c. 1507), Florentine painter, was born in 1439. At the age of fourteen he became a pupil of Neri di Bicci, and in 1460 he worked as assistant to his cousin Bernardo di Stefano Rosselli. The first work of Cosimo mentioned by Vasari exists in S. Ambrogio, in Florence, over the third altar on the left. It is an "Assumption of the Virgin," a youthful and feeble work. In the same church, on the wall of one of the chapels, is a fresco by Cosimo which Vasari praises highly, especially for a portrait of the young scholar Pico di Mirandola. The scene, a procession bearing a miracle-working chalice, is painted with much vigour and less mannerism than most of this artist's work. A picture painted by Rosselli for the church of the Annunziata, with figures of SS. Barbara, Matthew and the Baptist, is in the Academy of Florence. Rosselli also spent some time in Lucca, where he painted several altar-pieces for various churches. A picture attributed to him, taken from the church of S. Girolamo at Fiesole, is now in the National Gallery of London. It is a large retable, with, in the

centre, St Jerome in the wilderness kneeling before a crucifix, and at the sides standing figures of St Damasus and St Eusebius, St Paolo and St Eustachia; below is a predella with small subjects. Though dry and hard in treatment, the figures are designed with much dignity. The Berlin Gallery possesses three pictures by Rosselli: "The Virgin in Glory," "The Entombment of Christ," and "The Massacre of the Innocents." In 1480 Rosselli, together with the chief painters of Florence, was invited by Sixtus IV. to Rome to assist in the painting of the frescoes in the Sistine Chapel. Three of these were executed by him—"The Destruction of Pharaoh's Army in the Red Sea," "Christ Preaching by the Lake of Tiberias," and "The Last Supper." The last of these is well preserved, but is a mediocre work. Vasari's story about the pope admiring Rosselli's paintings more than those of his abler brother painters has probably little foundation. Rosselli's Sistine frescoes were partly painted by his assistant Piero di Cosimo, who was so called after Cosimo Rosselli. His chief pupil was Fra Bartolommeo. According to Vasari, Rosselli died in 1484, but this is a mistake, as his will exists dated 25th of November 1506 (see Gaye, *Car. ined.* ii. 457 n.).

For an account of Rosselli's Sistine frescoes, see Platner and Bunsen, *Beschreibung der Stadt Rom*, ii. pt. i.; and Rumohr, *Italian. Forschungen*, ii. 265.

ROSSELLINO, ANTONIO (1427-c. 1470), Florentine sculptor, was the son of Matteo di Domenico Gamberelli, and had four brothers, who all practised some branch of the fine arts. Almost nothing is known about the life of Antonio, but many of his works exist, and are full of religious sentiment, and executed with the utmost delicacy of touch and technical skill. The style of Antonio and his brother Bernardo is a development of that of Donatello and Ghiberti; it possesses all the refinement and sweetness of the earlier masters, but is not equal to them in vigour or originality. Antonio's chief work, still in perfect preservation, is the lovely tomb of a young cardinal prince of Portugal, who died in 1459. It occupies one side of a small chapel, also built by Rossellino, on the north of the nave of San Miniato al Monte.¹ The recumbent effigy of the cardinal rests on a handsome sarcophagus, and over it, under the arch which frames the whole, is a beautiful relief of the Madonna between two flying angels. The tomb was begun in 1461 and finished in 1466; Antonio received four hundred and twenty-five gold florins for it. A reproduction of this tomb with slight

church of S. Maria del Monte at Naples, where it still exists. For the same church he also executed some delicate reliefs, which perhaps err in being too pictorial in style, especially in the treatment of the backgrounds. A fine medallion relief by him in marble, originally modelled in terra-cotta, is preserved in the Bargello at Florence (see fig.).

BERNARDO ROSSELLINO (1409-1464), Florentine sculptor, was no less able than his younger brother Antonio. His finest piece of sculpture is the tomb, in the Florentine Santa Croce, of Leonardo Bruni of Arezzo, the historian of Florence, executed in 1443 some years after Bruni's death; the recumbent effigy is of great merit. The inner cathedral pulpit at Prato, circular in form on a tall slender stem, was partly the work of Mino da Fiesole and partly by Bernardo Rossellino. The latter executed the minute reliefs of St Stephen and the Assumption of the Virgin. For his part in the work he received sixty-six gold florins. The South Kensington Museum possesses a relief by Bernardo, signed and dated (1456). It is a fine portrait of the physician Giovanni da S. Miniato. Bernardo's works as an architect were numerous and important, and he was also a skilful military engineer. He restored the church of S. Francis at Assisi, and designed several fine buildings at Civita Vecchia, Orvieto and elsewhere. He also built fortresses and city walls at Spoleto, Orvieto and Civita Castellana. He was largely employed by Nicholas V. and Pius II. for restorations in nearly all the great basilicas of Rome, but little trace of his work remains, owing to the sweeping alterations made during the 17th and 18th centuries. Between the years 1461 and 1464 (when he died while engaged on the Lazzari monument at Pistoia) he occupied the important post of *capo-maestro* to the Florentine duomo. A number of buildings at Pienza, executed for Pius II., are attributed to him; the Vatican registers mention the architect of these as M^o Bernardo di Fiorenza, but this indication is too slight to make it certain that the elder Rossellino is referred to (see Vasari, *ed. Milanesi*, iii. 93 seq.).

See Wilhelm Bode, *Die Italienische Plastik* (Berlin, 1902).

ROSSETTI, CHRISTINA GEORGINA (1830-1894), English poet, was the youngest of the four children of Gabriele Rossetti (see the article on her brother DANTE GABRIEL ROSSETTI). She was born at 38 Charlotte Street, Portland Place, London, on the 5th of December 1830. She enjoyed the advantages and disadvantages of the strange society of Italian exiles and English eccentrics which her father gathered about him, and she shared the studies of her gifted elder brother and sister. As early as 1847 her grandfather, Gaetano Polidori, printed privately a volume of her *Verses*, in which the richness of her vision was already faintly prefigured. In 1850 she contributed to *The Germ* seven pieces, including some of the finest of her lyrics. In her girlhood she had a grave, religious beauty of feature, and sat as a model not only to her brother Gabriel, but to Holman Hunt, to Madox Brown and to Millais. In 1853-54 Christina Rossetti for nearly a year helped her mother to keep a day-school at Frome-Selwood, in Somerset. Early in 1854 the Rossettis returned to London, and the father died. In poverty, in ill-health, in extreme quietness, she was now performing her life-work. She was twice sought in marriage, but each time, from religious scruples (she was a strong high-church Anglican), she refused her suitor; on the former of these occasions she sorrowed greatly, and her suffering is reflected in much of her early song. In 1861 she saw foreign countries for the first time, paying a six weeks' visit to Normandy and Paris. In 1862 she published what was practically her earliest book, *Goblin Market*, and took her place at once among the poets of her age. In this volume, indeed, is still to be found a majority of her finest writings. *The Prince's Progress* followed in 1866. In 1867 she, with her family, moved to 56 Euston Square, which became their home for many years. Christina's prose work *Commonplace* appeared in 1870. In April 1871 her whole life was changed by a terrible affliction, known as "Graves's disease"; for two years her life was in constant danger. She had already composed her book of children's poems, entitled *Sing-Song*, which appeared



Marble Relief by Antonio Rossellino.

alterations, and of course a different effigy, was made by Antonio for the wife of Antonio Piccolomini, duke of Amalfi, in the

¹ Illustrated by Gonnelli, *Mon. Sepol. della Toscana* (Florence, 1819), pl. xxiii.

in 1872. After a long convalescence, she published in 1874 two works of minor importance, *Annus Domini* and *Speaking Likenesses*. The former is the earliest of a series of theological works in prose, of which the second was *Seek and Find* in 1879. In 1881 she published a third collection of poems, *A Pageant*, in which there was evidence of slackening lyrical power. She now gave herself almost entirely to religious disquisition. The most interesting and personal of her prose publications (but it contained verse also) was *Time Flies* (1885)—a sort of symbolic diary or collection of brief homilies. In 1890 the S.P.C.K. published a volume of her religious verse. She collected her poetical writings in 1891. In 1892 she was led to publish a very bulky commentary on the Apocalypse, entitled *The Face of the Deep*. After this she wrote little. Her last years were spent in retirement at 30 Torrington Square, Bloomsbury, which was her home from 1876 to her death. In 1892 her health broke down finally, and she had to endure terrible suffering. From this she was released on the 29th of December 1894. Her *New Poems* were published posthumously in 1896. In spite of her manifest limitations of sympathy and experience, Christina Rossetti takes rank among the foremost poets of her time. In the purity and solidity of her finest lyrics, the glow and music in which she robes her moods of melancholy reverie, her extraordinary mixture of austerity with sweetness and of sanctity of tone with sensuousness of colour, Christina Rossetti, in her best pieces, may challenge comparison with the most admirable of our poets. The union of fixed religious faith with a hold upon physical beauty and the richer parts of nature has been pointed to as the most original feature of her poetry. Hers was a cloistered spirit, timid, nun-like, bowed down by suffering and humility; her character was so retiring as to be almost invisible. All that we really need to know about her, save that she was a great saint, was that she was a great poet. (E. G.)

See the *Poetical Works of C. G. R.*, with Memoir by W. M. Rossetti (1903). Also Edmund Gosse's *Critical Kit-Kats* (1896); an article by Ford Madox Hueffer in the *Fortnightly Review* (March 1904); and another in *The Christian Society* (Oct. 1904). The *Family Letters of Christina Rossetti* were edited by W. M. Rossetti in 1908.

ROSSETTI, DANTE GABRIEL (1828-1882), English poet and painter, whose full baptismal name was Gabriel Charles Dante, was born on the 12th of May 1828, at 38 Charlotte Street, Portland Place, London. He was the first of the two sons and the second of the four children of Gabriele Rossetti (1783-1854), an Italian poet and liberal, who, about 1824, after many vicissitudes connected with the part he played in the Naples reform movement against Ferdinand I., came to England, where he married in 1826 Frances Mary Polidori (d. 1886), sister of Byron's physician, Dr John Polidori, and daughter of a Tuscan, Gaetano Polidori, who had in early youth been Alfieri's secretary and who had married an English lady. In 1831 he became professor of Italian in King's College, London, and afterwards achieved a recognized position as a subtle and original, if eccentric, commentator on Dante. In 1852 he published a volume of Italian religious poems. His family, besides Dante Gabriel, consisted of Maria Francesca (1827-1876), who eventually entered an Anglican sisterhood—she is known to Dante scholars by her valuable *Shadow of Dante*; William Michael (b. 1829), a well-known man of letters who from 1845 to 1894 was in the Inland Revenue Office—he married a daughter of Ford Madox Brown; and Christina (q.v.), the poet. The literary spirit was strongly entrenched here, and the talent which was always distinguished in William Michael rose to the height of rare genius in Dante Gabriel and Christina.

Dante Rossetti's education was begun at a private school in Foley Street, Portland Place, where he remained, however, only nine months, from the autumn of 1835 to the summer of 1836. He next went (in the autumn of 1836) to King's College School, where he remained till the summer of 1843, having reached the fourth class. From early childhood he had displayed a marked propensity for drawing and painting. It had there-

fore from the first been tacitly assumed that his future career would be an artistic one, and he left school early. In Latin, however, he was already fairly proficient for his age; French he knew well; Italian he had spoken from childhood, and he had some German lessons about 1844-45. But, although he learned enough German to be able to translate the *Arme Heinrich* of Hartmann von Aue, and some portions of the *Nibelungenlied*, he afterwards forgot the language almost entirely. His Greek too, such as it had been, he lost. On leaving school he went (1843) to Cary's Art Academy (previously called Sass's), near Bedford Square, and thence obtained admission to the Royal Academy Antique School towards 1846. Of the artistic education of foreign travel Rossetti had very little. But in early life he made a short tour in Belgium, where he was indubitably much impressed and influenced by the works of Van Eyck at Ghent and Memling at Bruges.

[It may be convenient to interpolate here a continuous account of Rossetti's career as a pictorial artist. Being much impressed by some of the early works of Ford Madox Brown exhibited at the Academy (1841), Westminster Hall (1844-45) and the British Institution (1845), he sought from that master of technique technical instruction of a more direct and stringent kind than he had previously submitted to. Brown, ever generous in that way, undertook without a fee the training of Rossetti as a painter, and set him to work upon such rudimentary studies as pickle-pots and other "still-life." The pupil's course of such work was, as might be expected, short; the master's example and that of Millais, together with the uncompromising energy of Holman Hunt, with both of whom Rossetti became intimate about this time, helping and encouraging him. Most of all, perhaps, so far as his temporary impressions were concerned, a picture of Brown's which was shown at the "Free Exhibition," Hyde Park Corner, in the spring of 1848 profoundly affected Rossetti. This was, of course, months before the formation of the Pre-Raphaelite Brotherhood in the autumn of the last-named year, when five painter-students, a sculptor (Thomas Woolner) and a layman (W. M. Rossetti) agreed upon certain principles they desired should obtain in art. None of the five owed the initiative of his views to any of the others or to Brown, whose impulse was purely technical and connected with Rossetti only; neither Millais, Holman Hunt, J. Collinson nor F. G. Stephens needed the help of Madox Brown. The point of Pre-Raphaelite crystallization which had so great though brief an influence upon Rossetti's life and art was found at a chance meeting of Rossetti, Millais and Holman Hunt in Millais's house in Gower Street, where certain prints from early Italian frescoes were studied. The enthusiasm of Rossetti led him to propose the formation of a "Brotherhood" with more or less definite views and much loftier aims than artists generally venture to announce. This took effect; the views of the remaining three men were already known, and in a few days they joined the new society and took their shares in the obloquy which attended the doings of Millais, Hunt and Collinson. Brown, though invited, declined to become a P.-R.B. Rossetti's first effort was by means of "The Girlhood of Mary, Virgin," which in March 1849 was exhibited at Hyde Park Corner. It was a picture which attested the prodigious value of his studies since the previous October, and the native genius of the painter and the sincere passion with which he had accepted the obligations of Pre-Raphaelitism, as they were then, but not for long, understood. Nothing of his producing was more independent than the inception of "The Girlhood of Mary, Virgin"; indeed the design for it was made some half a year before the meeting in Gower Street, though the execution of this work owed not a little to the influence, if not the actual help, of Millais and Hunt. Its mysticism was Rossetti's own, its technique owed something to Brown. On the whole, there can be no doubt that in this work was the first pronouncement of a new view of art, a fresh technique and power rapidly developing itself. Of course, the style of this noteworthy and epoch-marking picture was

jeune, its handling was timid, while its coloration and tonality were dry, not to say thin. Such was Rossetti's advent in art under the Pre-Raphaelite banner. The picture's reception was not encouraging, nor did the next work from his hands induce him to emerge from that proud exclusiveness in which all such minds as his are content to abide. The diverse moods of the other Brothers chose otherwise, but of Rossetti's immediate circle it has been truly said: "It appears that of seven young men and Brethren five have attained eminent positions, four of them being pre-eminent, although for years after the society was formed no single member, whatever his position might be, escaped insult, obloquy and wicked and malicious misrepresentation. The more conspicuous the Brother [*e.g.* Millais], the more outrageously was he attacked." No estimate of Rossetti's genius, his triumph and his life as a whole can be justly based without ample allowance being made for the circumstances which attended his advent as a painter. "Ecce Ancilla Domini!" the smaller picture which is now in the National Gallery of British Art at Millbank, was the one perfect outcome of the original motive of the Pre-Raphaelite Brotherhood by its representative and typical member. It is replete with the mystical mood which then ruled the painter's mind; that mood chose what may be called virginal white and its harmonies as its aptest coloration, and the intense light of morning sufficed for its tonality. It was exhibited at the Portland Gallery in 1850. After these pictures were finished, the outside world saw no more of Rossetti as a painter until it had prepared itself to see modern art from a higher plane than before.

In December 1850 there appeared the first number of *The Germ*, a magazine (which lasted for only four numbers) in which Rossetti had a leading place as the poet in verse and prose. The influence of Robert Browning upon Rossetti was more potent in *The Germ* than in that splendid romance in water-colours called "The Laboratory," where a court lady of the *ancien régime* visits an old poison-monger to obtain from him a fatal potion for her rival in love. This wonderful gem of colour, glowing in lurid and wicked passion and voluptuous suggestion, marked the opening of the artist's second period and signaled his departure from that phase of Pre-Raphaelitism of which "Ecce Ancilla Domini!" was the crowning achievement, and, so far as he was concerned, the artistic *ne plus ultra*. Millais and the other Brothers remained faithful during several years yet to come. Later in 1850, Rossetti produced the original, which is in ink, of the famous "Hesterna Rosa," a gambling scene of men and their mistresses in a tent by lamplight, while pallid dawn gathers force between the trees without. Then came from his hands "Borgia," which, like "The Laboratory," is in water-colours, and, like "Hesterna Rosa," is a sardonic tragedy. "How they met Themselves" came next, and, in illustrating a legend similar to that of the Döppelgänger, affirmed the force, the originality and the tragic passion of Rossetti's genius. Two lovers are walking in a twilight wood, where they are confronted suddenly by their apparitions, portending death. The year 1852 produced "Giotto painting Dante's Portrait," and saw a new development of the painter's mind and mood, dashed with a humour not often to be seen in him. In its somewhat dry coloration it differed from the ardent jewel-like glow and deeper gloom of "Borgia" and its successor and the sumptuous visions of womanhood in later pictures. "Found," Rossetti's sole contribution of the sort which Mr Holman Hunt affected, was begun somewhere about this period; but this piece of pictorial moralizing (the analogue of the poet's own "Jenny"), vigorous and intensely pathetic as it is, was never really finished by its author, being, indeed, far remote from Rossetti's inner self, which was rather over-scornful of didactic art, and thoroughly indispensed towards attempts to ameliorate anybody's condition by means of pictures. Nor did the stringency of naturalistic painting suit his mood or his experience. Nevertheless, what is his in the existing picture remains a masterpiece of poetry with exquisitely finished parts.

Passing a few fine but comparatively unimportant drawings,

such as "Lancelot and Guinevere at the Tomb of Arthur," "Lancelot looking at the Dead Lady of Shalott," "Mariana of the South," "Sir Galahad," "The Blue Closet," and various works owing subjects to the Arthurian cycle of romances, we may note that the artist illustrated by five cuts *Poems by Alfred Tennyson*, on which Millais and Mr Holman Hunt were also engaged, and which was published by Moxon in 1857. As in "Ecce Ancilla Domini!" we had virginal white and morning light employed to strengthen the mystical significance of the design, so in "Borgia" Venetian voluptuousness and sensuous splendours obtained, and in "The Blue Closet" is a very potent and suggestive exercise intended to symbolize the association of colour with music. The last is one of the subtlest of the artist's "inventions," and it shows how he had developed upon "Borgia" an artistic sympathy which is but too likely to be "caviare to the general." "The Wedding of St George" is not so fine; nor was "Lancelot's Dream of the Sangreal." Rossetti's part in the luckless decorations of the Oxford Union¹ (1857-58); nor are "Guinevere and Sir Lancelot," "Galahad in the Chapel" and other Arthurian examples quite worthy of his art. "Bocca Baciata," the super-sensuous portrait of a woman, a work of wonderful fire, and the pictures on the pulpit at Llandaff Cathedral, marked the expiration of the second epoch in Rossetti's art and the beginning of a new, the third, last and most powerful of all the phases of his career. The picture "Dr Johnson at the Mitre," when the "pretty fools" consulted the lexicographer anent Methodism, is a good example of his humour.

In 1861 Rossetti produced several fine designs for stained glass, and in the revival of stained-glass painting as an art he had a larger share than has frequently been ascribed to him. The practice of designing upon a large scale, and employment of masses of splendid though deep-toned colours, had probably something to do with the prodigious development of his powers and the enlargement of his views as regards painting which took effect at this period (1862-63). At this time a striking and highly imaginative triptych, representing three events in the careers of Paolo and Francesca, was produced; it is a great improvement upon an earlier design. There is unprecedented energy in the group of the lovers embracing in the garden-house just as they have paused in reading the fatal romance. The composition of this group, with the circular window behind their figures, is as fine as it was comparatively novel in Rossetti's practice. Its lurid coloration was so thoroughly in harmony with the pathos of the subject that in this respect the work excelled all the painter had previously produced. The same elements, energy, a sympathetic and poetic scheme of colour, and composition of a fine order, combined with far greater force and originality in "The Bride," or "The Beloved," that magnificent illustration of The Song of Solomon. The last named is a life-size group of powerfully coloured and diversely beautiful damsels accompanying their mistress with music and with song on her way to the bridegroom. This picture, as regards its brilliance, finish, the charms of four lovely faces and the splendour of its lighting, occupies a great place in the highest grade of modern art of all the world. It is likewise, so far as the qualities named are concerned, the crowning piece of Rossetti's art, and stands for him much as the "Sacred and Profane Love" of Titian represents that master. Very fine, indeed, but hardly so passionate and virile, is the "Beata Beatrix," now in the National Gallery of British Art with "Ecce Ancilla Domini!" which he produced thirteen years earlier. These works belong to a category of fine and quite original examples, all replete with

¹ In 1857, Rossetti, when in Oxford with William Morris, conceived the design of filling the bays above the gallery in the then new Union debating room (now the library) with paintings from the *Morte d'Arthur*, and he enlisted the co-operation of several of his artistic circle, including Burne-Jones and William Morris, in the work, which was begun in August. Morris's picture was "Sir Palomides watching Tristram and Iseult," Burne-Jones's "Nimue luring Merlin." Unfortunately the walls were too new and not properly prepared for painting; the colour soon began to fade and wear off, and in the course of twenty years or so the pictures became almost indistinguishable.

similar technical qualities, poetry and pathos. The group comprises paintings by which Rossetti is best known, such as "Proserpina in Hades," which is, on the whole, perhaps the most original, if not indeed the most poetical and powerful, of all his output; "Sibylla Palmifera," "Venus Verticordia," "Lilith" (the better of the two versions is now referred to), "Washing Hands," "Monna Vanna," "Il Ramoscello," "Aurea Catena," "La Pia," "Rosa Triplex," "Veronica Veronese," "La Ghirlandata," "Pandora," "The Blessed Damozel," and, last and largest, but not, perhaps, the greatest of his paintings (a distinction for which "The Bride" and "Proserpina" must contend), the famous "Dante's Dream," now in the Walker Art Gallery at Liverpool. Besides these, Rossetti produced a large number of fine things. Nearly the whole of them were exhibited by the Royal Academy and at the Burlington Fine Art Club in 1883, after their author's death.

(F. G. S.)

Meanwhile, the literary side of Rossetti had developed *pari passu* with his achievements as a painter. The goal before the young Rossetti's eyes was to reach through art the forgotten world of old romance—that world of wonder and mystery and spiritual beauty which the old masters knew and could have painted had not lack of science, combined with slavery to monkish traditions of asceticism, crippled their strength. In that great rebellion against the renaissance of classicism which (after working much good and much harm) resulted in 18th-century materialism—in that great movement of man's soul which may be appropriately named "the Renaissance of the Spirit of Wonder in Poetry and Art"—he had become the acknowledged protagonist before ever the Pre-Raphaelite brotherhood was founded, and so he remained down to his last breath. It was by inevitable instinct that Rossetti turned to that mysterious side of nature and man's life which to other painters of his time had been a mere fancy-land, to be visited, if at all, on the wings of sport. For in there is any permanent vitality in the Renaissance of Wonder in modern Europe, if it is really the inevitable expression of the soul of man in a certain stage of civilization (when the sanctions which have made and moulded society are found to be not absolute and eternal, but relative, mundane, ephemeral and subject to the higher sanctions of unseen powers that work behind "the shows of things"), then perhaps one of the first questions to ask in regard to any imaginative painter of the 19th century is, In what relation did he stand to the newly awakened spirit of romance? Had he a genuine and independent sympathy with that temper of wonder and mystery which all over Europe had preceded and now followed the temper of imitation, prosaic acceptance, pseudo-classicism and domestic materialism? or was his apparent sympathy with the temper of wonder, reverence and awe the result of artistic environment dictated to him by other and more powerful and original souls around him?

We do not say that the mere fact of a painter's or a poet's showing but an imperfect sympathy with the Renaissance of Wonder is sufficient to place him below a poet in whom that sympathy is more nearly complete, but we do say that, other things being equal or anything like equal, a painter or poet of this time is to be judged very much by his sympathy with that great movement, which we call the Renaissance of Wonder because the word "romanticism" never did express it even before it had been vulgarized by French poets, dramatists, doctrinaires and literary harlequins. To struggle against the *prim* traditions of the 18th century, the unities of Aristotle, the delineation of types instead of characters, as Chateaubriand, Madame de Staël, Balzac and Hugo struggled, was well. But in studying Rossetti's works we reach the very key of those "high palaces of romance" which the English mind had never, even in the 18th century, wholly forgotten, but whose mystic gates no Frenchman ever yet unlocked. Not all the romantic feeling to be found in all the French romanticists (with their theory that not earnestness but the grotesque is the life-blood of romance) could equal the romantic

spirit expressed in a single picture or drawing of Rossetti's; such, for instance, as Beata Beatrix or Pandora. For, while the French romanticists—inspired by the theories (drawn from English exemplars) of Novalis, Tieck and Herder—cleverly simulated the old romantic feeling, the "beautifully devotional feeling" which Holman Hunt speaks of, Rossetti was steeped in it: he was so full of the old frank childlike wonder and awe which preceded the great renaissance of materialism that he might have lived and worked amidst the old masters. Hence, in point of design, so original is he that to match such ideas as are expressed in "Lilith," "Hesterna Rosa," "Michael Scott's Wooing," the "Sea Spell," &c., we have to turn to the sister art of poetry, where only we can find an equally powerful artistic representation of the idea at the core of the old romanticism—the idea of the evil forces of nature assailing man through his sense of beauty. We must turn, we say, not to art—not even to the old masters themselves—but to the most perfect efflorescence of the poetry of wonder and mystery—to such ballads as the "Demon Lover," to Coleridge's "Christabel" and "Kubla Khan," to Keats's "La Belle Dame sans Merci," for parallels to Rossetti's most characteristic designs. Now, although the idea at the heart of the highest romantic poetry (allied perhaps to that apprehension of the warning of man's soul with the appetites of the flesh which is the basis of the Christian idea) may not belong exclusively to what we call the romantic temper (the Greeks, and also most Asiatic peoples, were more or less familiar with it, as we see in the *Saldman and Absal* of Jami), yet it became peculiarly a romantic note, as is seen from the fact that in the old masters it resulted in that asceticism which is its logical expression and which was once an inseparable incident of all romantic art. But in order to express this stupendous idea as fully as the poets have expressed it, how is it possible to adopt the asceticism of the old masters? This is the question that Rossetti asked himself, and answered by his own progress in art. In all of his pictures, the poorest and the best, is displayed that power which Blake calls vision—the power which, as he finely says, is "surrounded by the daughters of inspiration," the power, that is, of seeing imaginary objects and dramatic actions—physically seeing them as well as mentally—and flashing them upon the imaginations (even upon the corporeal senses) of others.

Mr W. M. Rossetti (in the Preface to the *Collected Works*, 1886) has given an interesting account of his brother's literary nurturing. Shakespeare, Walter Scott, Byron, the Bible were the earliest influences: then Shelley, Mrs Browning, the older English and Scottish ballads, and Dante. Afterwards he preferred Keats to Shelley. By 1847 he was "deep in Robert Browning." Malory's *Morte d'Arthur*, about 1856, engrossed him; Victor Hugo and De Musset, among French poets, were his delight. In his last years he had an enthusiasm for Chatterton. From childhood's days he had loved to compose, but *The Germ* (1850) contained Rossetti's first published prose or verse. In it appeared "The Blessed Damozel," the prose poem "Hand and Soul," six sonnets and four lyrics.

"The Blessed Damozel" was written so early as 1847 or 1848. "Sister Helen" was produced in its original form in 1850 or 1851. His translations from the early Italian poets also began as far back as 1845 or 1846, and may have been mainly completed by 1849. He published a volume of *The Early Italian Poets (Dante and his Circle)* in 1861. In 1856 he contributed to the *Oxford and Cambridge Magazine*, in which among other things the "Burden of Nineveh" appeared. Materials for a volume of original poetry accumulated slowly, and these having been somewhat widely read in manuscript had a very great influence upon contemporary poetic literature long before their appearance in print. He had intended to publish a volume in 1862, but the death of his wife (see below) caused its postponement till 1870. In poetry no less than in art what makes Rossetti so important a figure is the position he took up with regard to the modern revival of the "romantic" spirit. The Renaissance of Wonder culminates

in Rossetti's poetry as it culminates in his painting. The poet who should go beyond Rossetti would pass out of the realm of poetry into pure mysticism, as certain of his sonnets show. Fine as are the sonnets (of which the sonnet sequence, the "House of Life," in the 1881 volume, may be specially mentioned), it is in his romantic ballads that Rossetti (notwithstanding a certain ruggedness of movement) shows his greatest strength. "Sister Helen," "The Blessed Damozel," "Staff and Scrip," "Eden Bower," "Troy Town," "Rose Mary," as representing the modern revival of the true romantic spirit, take a place quite apart from the other poetry of the time.

Rossetti's poetry, and his prose too, is marked by an extraordinary fastidiousness of expression and beauty of diction; the form and colour of his style are alike marvellous in clearness and loveliness of language. But the dominant characteristic, after all, is the underlying idea, the romantic motive. By the revival of the romantic spirit in English poetry we mean something much more than the revival, at the close of the 18th century, of natural language, the change discussed by Wordsworth in his famous Preface, and by Coleridge in his comments thereon—that change of diction and of poetic methods which is commonly supposed to have arisen with Cowper, or, if not with Cowper, with Burns. The truth is that Wordsworth and Coleridge were too near the great changes in question, and they themselves took too active a part in those changes, to hold the historical view of what the changes really were. Important as was the change in poetic methods which they so admirably practised and discussed, important as was the revival of natural language, which then set in, it was not nearly so important as that other revival which had begun earlier and of which it was the outcome—the revival of the romantic spirit, the Renaissance of Wonder, even beneath the weight of 18th-century diction, the first movement of which is certainly English, and neither German nor French in its origin, and can be traced through Chatterton, Macpherson and the Percy Ballads.

As a mere question of methods, a reaction against the poetic diction of Pope and his followers was inevitable. But, in discussing the romantic temper in relation to the overthrow of the bastard classicism and didactic materialism of the 18th century, we must go deeper than mere artistic methods in poetry. When closely examined, it is in method only that the poetry of Cowper is different from the ratiocinative and unromantic poetry of Dryden and Pope and their followers. Pope treated prose subjects in the ratiocinative—that is to say, the prose—temper, but in a highly artificial diction which people agreed to call poetic. Cowper treated prose subjects too—treated them in the same prose temper, but used natural language; a noble thing to do, no doubt. But this was only a part (and by no means the chief part) of the great work achieved by English poetry at the close of last century. That period, to be sure, rendered obsolete the poetic diction of Pope; but it introduced something more precious still—entire freedom from the hard rhetorical materialism imported from France; it gave a new seeing to English eyes, which were opened once more to the mystery and the wonder of the universe and the romance of man's destiny; it revived, in short, the romantic spirit, but the romantic spirit enriched by all the clarity and sanity that the renascence of classicism was able to lend. Of the great movement which substituted for the didactic materialism of the 18th century the new romanticism of the 19th, the leaders were Coleridge and Scott, admirably followed by Byron, Shelley and Keats. Not that Wordsworth was a stranger to the romantic temper. The magnificent image of Time and Death under the yew tree is worthy of any romantic poet that ever lived, yet it cannot be said that he escaped save at moments from the comfortable 18th-century didacticism, or that he was a spiritual writer in the sense that Coleridge, Blake and Shelley were spiritual writers.

Of the true romantic feeling, the ever-present apprehension of the spiritual world and of that struggle of the soul with earthly conditions which we have before spoken of, Rossetti's poetry

is as full as his pictures—so full, indeed, that it was misunderstood by certain critics, who found in the most spiritualistic of poets and painters the founder of a "fleshy school." Although it cannot be said that "The Blessed Damozel" or "Sister Helen" or "Rose Mary" reaches to the height of the masterpieces of Coleridge, the purely romantic temper was with Rossetti a more permanent and even a more natural temper than with any other 19th-century poet, even including the author of "Christabel" himself. As to the other 19th-century poets, though the Ettrick Shepherd in "The Queen's Wake" shows plenty of the true feeling, Hogg's verbosity is too great to allow of really successful work in the field of romantic ballad, where concentrated energy is one of the first requisites. And even Dobell's "Keith of Ravelston" has hardly been used in the fine atmosphere of fairyland. Byron's "footlight bogies" and Shelley's metaphysical abstractions had of course but very little to do with the inner core of romance, and we have only to consider Keats, to whose "La Belle Dame sans Merci" and "Eve of St Mark" Rossetti always acknowledged himself to be deeply indebted. In the famous close of the seventh stanza of the "Ode to a Nightingale"—

"Charmed magic casements opening on the foam
Of perilous seas in faery lands forlorn"—

there is of course the true thrill of the poetry of wonder, and it is expressed with a music, a startling magic, above the highest reaches of Rossetti's poetry. But, without the evidence of Keats's two late poems, "La Belle Dame sans Merci" and the "Eve of St Mark," who could have said that Keats showed more than a passing apprehension of that which is the basis of the romantic temper—the supernatural? In contrasting Keats with Rossetti, it must always be remembered that Keats's power over the poetry of wonder came to him at one flash, and that it was not (as we have said elsewhere) "till late in his brief life that his bark was running full sail for the enchanted isle where the old ballad writers once sang and where now sat the wizard Coleridge alone." Though outside Coleridge's work there had been nothing in the poetry of wonder comparable with Keats's "La Belle Dame sans Merci," the latter had previously in "Lamia" entirely failed in rendering the romantic idea of beauty as a maleficent power. The reader, owing to the atmosphere surrounding the dramatic action being entirely classic, does not believe for a moment in the serpent woman. The classic accessories suggested by Burton's brief narrative hampered Keats where to Rossetti (as we see in "Pandora," "Cassandra" and "Troy Town") they would simply have given birth to romantic ideas. It is perhaps with Coleridge alone that Rossetti can be compared as a worker in the Renaissance of Wonder. Although his apparent lack of rhythmic spontaneity places him below the great master as a singer (for in these miracles of Coleridge's genius poetry ceases to appear as a fine art at all—it is the inspired song of the changeling child "singing, dancing to itself"), in permanence of the romantic feeling, in vitality of belief in the power of the unseen, Rossetti stands alone. Even the finest portions of his historical ballad "The King's Tragedy" are those which deal with the supernatural.

The events of Rossetti's life may be briefly summarized. In the spring of 1860 he married Elizabeth Eleanor Siddall, a milliner's assistant, who, being very beautiful, was constantly painted and drawn by him. From 1856 onwards he had been very intimate with William Morris and Edward Burne-Jones, who had the greatest affection and artistic admiration for him. Mrs Rossetti, whose health was delicate, had one still-born child in 1861, and she died from an overdose of laudanum in February 1862. Rossetti then moved from Blackfriars to 16 Cheyne Walk, Chelsea, where for a short time George Meredith, A. C. Swinburne and W. M. Rossetti lived with him. Mrs Rossetti's own water-colour designs show an extraordinary genius for invention and a rare instinct for colour. Rossetti felt her death so acutely that in the first paroxysm of his grief he insisted upon his poems (then in manuscript) being buried in her coffin. But in 1869 the manuscripts were disinterred, and published in 1870. From this time to his death he

continued to write poems and produce pictures—in the latter relying more and more upon his manipulative skill but exercising less and less his exhaustless faculty of invention.

In 1871 an unsigned article in the *Contemporary Review* (by Robert Buchanan) on the "Fleshly School of Poetry" made a fierce attack on Rossetti's poems from what was intended to be a moral point of view, to which he answered by one on the "Stealthy School of Criticism." The attack was deeply felt by him, and increased his tendency—previously tempered by natural high spirits—towards gloomy brooding. About 1868 the curse of the artistic and poetic temperament, insomnia, attacked him. One of the most distressing effects of this malady is a nervous shrinking from personal contact with any save a few intimate and constantly seen friends. This peculiar kind of nervousness may be aggravated by the use of narcotics, and in his case was aggravated to a very painful degree; at one time he saw scarcely any one save his own family and immediate family connexions and the present writer. He was frequently away with William Morris at Kelmscot, in Oxfordshire. During the time that his second volume of original poetry, *Ballads and Sonnets*, was passing through the press (in 1881) his health began to give way, and he left London for Cumberland. A stay of a few weeks in the Vale of St John, however, did nothing to improve his health, and he returned much shattered. He then went to Birchington-on-Sea, but received no benefit from the change, though affectionately tended by friends like Hall Caine and others already mentioned; and, gradually sinking from a complication of disorders, he died on Sunday the 9th of April 1882.

In all matters of taste Rossetti's influence has been immense. The purely decorative arts (see ARTS AND CRAFTS) he may be said to have rejuvenated directly or indirectly. And he left the deepest impression upon the poetic methods of his time.

One of the most wonderful of Rossetti's endowments, however, was neither of a literary nor an artistic kind: it was that of a rare and most winning personality which attracted towards itself, as if by an unconscious magnetism, the love of all his friends, the love, indeed, of all who knew him. (T. W.-D.)

AUTHORITIES.—See various books by W. M. Rossetti—*Dante Gabriel Rossetti as Designer and Writer* (1889); *Ruskin, Rossetti, Pre-Raphaelitism* (1899); and *Some Reminiscences* (1906); Memoir by W. M. Rossetti prefixed to the *Collected Works*, published in 1886. Lady Burne-Jones's *Memoirs of Edward Burne-Jones* (1904) is full of interesting sidelights. See also F. G. Stephens, *D. G. Rossetti*; "Portolio" monograph (1894); H. C. Marillier, *D. G. Rossetti* (1899 and 1901); W. Sharp, *Dante Gabriel Rossetti: A Record and a Study* (1882); T. Hall Caine, *Recollections of Dante Gabriel Rossetti* (1882); W. Allingham, *Letters of Dante Gabriel Rossetti to William Allingham, 1854-70* (1897). An article by Vernon Lushington in the *Oxford and Cambridge Magazine* (1856) is an early contemporary view worth noting.

ROSSI, LUIGI DE, a 17th-century Italian musical composer, said to have been born at Naples towards the close of the 16th century. Of his life practically nothing is known. An opera of his, *Il Palazzo Incantato*, was given at Rome in 1642; in 1646 he was invited by Cardinal Mazarin to Paris, where he gave his opera *Le Mariage d'Orphée et d'Euridice* (1647), the first Italian opera performed in Paris. A collection of cantatas published in 1646 describes him as musician to Cardinal Antonio Berberini, and G. A. Perti in 1688 speaks of him along with Carissimi and Cesti as "the three greatest lights of our profession." Rossi is noteworthy principally for his chamber-cantatas, which are among the finest that the 17th century produced. A large quantity are in MS. in the British Museum and in Christ Church library, Oxford. *La Gelosia*, printed by F. A. Gevaert in *Les Gloires d'Italie*, is an admirable specimen.

ROSSI, PELLEGRINO LUIGI EDOARDO, Count (1787-1848), Italian economist and statesman, was born at Carrara on the 13th of July 1787. He was educated at Pavia and Bologna, and in 1812 became professor of law at the latter university. In 1815 he gave his support to Joachim Murat, and after his fall escaped to France, whence he proceeded to Geneva. There he began a course of jurisprudence applied to Roman law, the success of which gained him the unusual honour of natural-

ization as a citizen of Geneva. In 1820 he was elected as a deputy to the cantonal council, and was a member of the extraordinary diet of 1832. He was entrusted with the task of drawing up a revised constitution, which was known as the *Pacte Rossi*. This was rejected by a majority of the diet, a result which deeply affected Rossi, and induced him to look with favour on the suggestions of Guizot and the duc de Broglie that he should settle in France. He was appointed in 1833 to the chair of political economy in the Collège de France, vacated by the death of J. B. Say. He was naturalized as a French citizen in 1834, and in the same year became professor of constitutional law in the faculty of law at Paris. In 1836 he was elected a member of the *Académie des sciences politiques et morales*, was raised to the peerage in 1839 and in 1843 became doyen of the faculty of law. In 1845 he was sent to Rome by Guizot to discuss the question of the Jesuits, being finally appointed ambassador of France at Rome. The revolution of 1848 severed his connexion with France, and he remained at Rome and became minister of the interior under Pius IX. He was unpopular, however, owing to his conservative views, and was assassinated on the 15th of November, as he was alighting at the steps of the House of Assembly.

As a statesman, Rossi was a man of signal ability and intrepid character, but it is as an economist that his name will be best remembered. His *Cours d'économie politique* (1838-54) gave in classic form an exposition of the doctrines of Say, Malthus and Ricardo. His other works were *Traité de droit pénal* (1829); *Cours de droit constitutionnel* (1866-67), and *Mélanges d'économie politique, d'histoire et de philosophie* (2 vols., 1857). His widow left a sum of 100,000 francs to the Institut de France, to found in his memory scholarships in political economy or law. Carrara erected a statue to his memory in 1876, and in 1887 the *Société d'économie politique* celebrated his centenary with a notice of his life and works.

See also Le Comte Fleury d'Ideville, *Le Comte Pellegrino Rossi, sa vie, ses œuvres, sa mort* (1887).

ROSSINI, GIOACHINO ANTONIO (1792-1868), Italian musical composer, was born at Pesaro on the 29th of February 1792. His father was town trumpeter and inspector of slaughter-houses, his mother a baker's daughter. The elder Rossini's sympathies for the French became a source of trouble when, after the occupation of the papal state by the French in 1796, the Austrians restored the old régime. He was sent to prison, and his wife took Gioachino to Bologna, earning her living as a *prima donna buffa* at various theatres of the Romagna, where she was ultimately rejoined by her husband. Gioachino remained at Bologna in the care of a pork butcher, while his father played the horn in the bands of the theatres at which his mother sang. The boy had three years' instruction in the hapsichord from Prinetti of Novara, but Prinetti played the scale with two fingers only, combined his profession of a musician with the business of selling liquor, and fell asleep while he stood, so that he was a fit subject for ridicule with his critical pupil. Gioachino was taken from him and apprenticed to a smith. In Angelo Tesi he found a congenial master, and learned to read at sight, to play accompaniments on the piano-forte, and to sing well enough to take solo parts in the church when he was ten years of age. At thirteen he appeared at the theatre of the Commune in Patr's *Camilla*—his only appearance as a public singer (1805). He was also able to play the horn. In 1807 he was admitted to the counterpoint class of Padre P. S. Mattei, and soon after to that of Cavedagni for the 'cello at the Conservatorio of Bologna. He learned to play the 'cello with ease, but the pedantic severity of Mattei's views on counterpoint only served to accentuate the tendency of his genius towards a freer school of composition, and his insight into orchestral resources is to be ascribed rather to knowledge gained by scoring the quartets and symphonies of Haydn and Mozart, than to any prescribed rules for the composition of music. At Bologna he was known as "il Tedeschino" on account of his devotion to Mozart. Through the friendly interposition of the Marquis Cavalli, his first opera, *La Cambiale di Matrimonio*, was produced at Venice when he was a youth of eighteen. But two years before this he had already received the prize at the Conservatorio of Bologna

for his cantata *Il pianto d'armonia per la morte d'Orfeo*. Between 1810 and 1813, at Bologna, Rome, Venice and Milan, Rossini produced operas of which the successes were varying. All memory of them is eclipsed in that of *Tancredi*. The libretto was an arrangement of Voltaire's tragedy by J. A. Rossi. Traces of Paër and Paisiello were undeniably present in fragments of the music. But all critical feeling on the part of the public was drowned in the effect of sweetness and clarity produced by such melodies as "Mi rivedrai, ti riverrò" and "Di tanti palpiti," the former of which became so popular that the Italians would sing it in crowds at the law courts until called upon by the judge to desist. Rossini continued to write operas for Venice and Milan during the next few years, but their reception was tame and in some cases unsatisfactory after the success of *Tancredi*. In 1815 he retired to his home at Bologna, where Barbaja, the impresario of the Naples theatre, who had once been a waiter in a coffee-house and now combined the business of theatrical management with that of farming the public gaming-tables, concluded an agreement with him by which he was to take the musical direction of the Teatro San Carlo and the Teatro Del Fondo at Naples, composing for each of them one opera a year. His payment was to be 200 ducats (about £35 or £175) per month; he was also to receive a share in the gaming-tables amounting to about 1000 ducats (£175 or \$875) per annum. The presence of Zingarelli and Paisiello in Naples was an incentive to intrigue against the success of the youthful composer, but all hostility was made futile by the enthusiasm which greeted the court performance of his *Elisabetta regina d'Inghilterra*, in which Isabella Colbran, who subsequently became the composer's wife, took a leading part. The libretto of this opera by Schmidt was in many of its incidents an anticipation of those presented to the world a few years later in Scott's *Kenilworth*. The opera was the first in which Rossini wrote the ornaments of the airs instead of leaving them to the fancy of the singers, and also the first in which the *recitativo secco* was replaced by a recitative accompanied by a quartet of strings. In *Almaviva*, produced in the beginning of the next year in Rome, the libretto, a version of Beaumarchais' *Barbier de Séville* by Sterbini, was the same as that already used by Paisiello in his *Barbiere*, an opera which had enjoyed European popularity for more than a quarter of a century. The indignation of Paisiello's admirers expressed itself strongly on the production of the new setting, but in the thirteen days devoted to the composition of his *Almaviva*, Rossini had created such a masterpiece of musical comedy that the fame of Paisiello's opera was transferred to his, to which the title of *Il Barbieri di Siviglia* passed as an inalienable heritage. Between 1815 and 1823 Rossini produced twenty operas. Of these *Otello* formed the climax to his reform of serious opera, and offers a suggestive contrast with the treatment of the same subject at a similar point of artistic development by the composer Verdi. In Rossini's time the tragic close was so distasteful to the public of Rome that it was necessary to invent a happy conclusion to *Otello*; and there are still places in Italy in which the Shakespearian end of the story can never be performed without interruption from the audience, who warn Desdemona of Otello's deadly approach. Conditions of stage mechanism in 1817 are illustrated by Rossini's acceptance of the subject of *Cinderella* for a libretto only on the condition that the supernatural element should be omitted. The opera *Cenerentola* is to be ranked with the *Barbiere*. The absence of a similar precaution in the construction of his *Mosè in Egitto* led to disaster in the scene depicting the passage of the Israelites through the Red Sea, when the defects in stage contrivance always raised a laugh, so that the composer was at length compelled to introduce the chorus "Dal tuo stellato Soglio" to divert attention from the dividing waves. In 1821, three years after the production of this work, Rossini married Isabella Colbran. In 1822 he directed his *Cenerentola* in Vienna, where *Zelmira* was also performed. After this he returned to Bologna; but an invitation from Prince Metternich to come to Verona and "assist in the general re-establish-

ment of harmony" was too tempting to be refused, and he arrived at the Congress in time for its opening on the 20th of October 1822. Here he made friends with Chateaubriand and Madame de Lieven. In 1823, at the suggestion of the manager of the King's Theatre, London, he came to England, being much fêted on his way through Paris. In England he was given a generous welcome, which included an introduction to King George IV. and the receipt of £7000 after a residence of five months. In 1824 he became musical director of the Théâtre Italien in Paris at a salary of £800 per annum, and when the agreement came to an end he was rewarded with the offices of chief composer to the king and inspector-general of singing in France, to which was attached the same income. The production of his *Guillaume Tell* in 1829 brought his career as a writer of opera to a close. The libretto was by Étienne Jouy and Hippolyte Bis, but their version was revised by Armand Marrast. The music is remarkable for its freedom from the conventions discovered and utilized by Rossini in his earlier works, and marks a transitional stage in the history of opera. In 1829 he returned to Bologna. His mother had died in 1827, and he was anxious to be with his father. Arrangements for his subsequent return to Paris on a new agreement were upset by the abdication of Charles X. and the July Revolution of 1830. Rossini, who had been considering the subject of *Faust* for a new opera, returned, however, to Paris in the November of that year. Six movements of his *Stabat Mater* were written in 1832 and the rest in 1839, the year of his father's death, and the success of the work bears comparison with his achievements in opera; but his comparative silence during the period from 1832 to 1868 makes his biography appear almost like the narrative of two lives—the life of swift triumph, and the long life of seclusion, of which the biographers give us pictures in stories of the composer's cynical wit, his speculations in fish culture, his mask of humility and indifference. His first wife died in 1845, and political disturbances in the Romagna compelled him to leave Bologna in 1847, the year of his second marriage with Olympe Pelessier, who had sat to Vernet for his picture of "Judith and Holofernes." After living for a time in Florence he settled in Paris in 1855, where his house was a centre of artistic society. He died at his country house at Passy on the 13th of November 1868. He was a foreign associate of the Institute, grand officer of the Legion of Honour, and the recipient of innumerable orders. In his compositions Rossini plagiarized even more freely from himself than from other musicians, and few of his operas are without such admixtures frankly introduced in the form of arias or overtures. A characteristic mannerism in his musical writing earned for him the nickname of "Monsieur Crescendo." His music is associated with the names of the greatest singers in lyrical drama, such as Tamburini, Mario, Rubini, Delle Sedie, Albani, Grisi, Patti and Nilsson.

ROSSLAND, an important city in the Kootenay district of British Columbia, incorporated in 1897. Pop. (1907) 4033. It is situated in a valley 7 m. W. of Trail on the Columbia river and 8 m. N. of the international boundary. It has direct railroad communication with Trail and the Arrow lakes as well as with Northport and Spokane in the state of Washington. Rossland owes its importance to the immense deposits of iron and copper pyrites carrying gold, which occur in the vicinity. The best-known mines are the Le Roy, Centre Star and War Eagle. The city derives its electric light and power service from Bonington Falls on the Kootenay river.

ROSSLAU, a town of Germany, in the duchy of Anhalt, on the right bank of the Elbe, here crossed by two railway bridges, 3 m. by rail N. of Dessau and 35 m. S.E. of Magdeburg. Pop. (1905) 11,027. It has a ducal residence, an old castle, a handsome parish church, and manufactures of machinery, paper, sealing-wax, wire goods, sugar, bricks and chemicals. Rosslau became a town in 1603.

ROSSLYN, EARLS OF. The first earl of Rosslyn was Alexander Wedderburn (see below), who was succeeded by his nephew, James St Clair Erskine (1762-1837), a son of

Wedderburn's sister Janet by her marriage with Sir Henry Erskine (d. 1763), a Scottish baronet and soldier. Entering the army in 1776, James Erskine served in Portugal, in Denmark and in the Netherlands, and became a general in 1814. From 1782 until 1805, when he became a peer, he was a member of parliament; a Tory politician and an associate of the duke of Wellington, he was lord privy seal in 1829-30 and lord president of the council in 1834-35. He inherited the estates of the family of St Clair and took this name in 1789, and he died on the 18th of January 1837. His son, James Alexander (1802-1866), became 3rd earl, and in 1890 the latter's grandson, James Francis Harry (b. 1869), became 5th earl.

ROSSLYN, ALEXANDER WEDDERBURN, 1ST EARL OF (1733-1805), Lord Chancellor of Great Britain, was the eldest son of Peter Wedderburn (a lord of session as Lord Chesterhall), and was born in East Lothian on the 13th of February 1733. He acquired the rudiments of his education at Dalkeith, and in his fourteenth year matriculated at the university of Edinburgh. It was from the first his desire to practise at the English bar, though in deference to his father's wishes he qualified as an advocate at Edinburgh, in 1754, but entered himself at the Inner Temple on the 8th of May 1753, so that he might keep the Easter and Trinity terms in that year. His father was called to the bench in 1755, and for the next three years Wedderburn stuck to his practice in Edinburgh, during which period he employed his oratorical powers in the General Assembly of the Church of Scotland, and passed his evenings in the social and argumentative clubs which abound in Edinburgh. In 1755 the precursor of the later *Edinburgh Review* was started, now chiefly remembered because in its pages Adam Smith criticized the dictionary of Dr Johnson, and because the contents of its two numbers were edited by Wedderburn. The dean of faculty at this time, Lockhart, afterwards Lord Covington, a lawyer notorious for his harsh demeanour, in the autumn of 1757 assailed Wedderburn with more than ordinary insolence. His victim retorted with extraordinary powers of invective, and on being rebuked by the bench declined to retract or apologize, but placed his gown upon the table, and with a low bow left the court for ever. He was called to the English bar at the Inner Temple in 1757. To shake off his native accent and to acquire the graces of oratorical action, he engaged the services of Thomas Sheridan and Charles Macklin. To secure business and to conduct his cases with adequate knowledge, he studied the forms of English law, he solicited William Strahan, the printer, "to get him employed in city causes," and he entered into social intercourse (as is noted in Alexander Carlyle's autobiography) with busy London solicitors. His local connexions and the incidents of his previous career introduced him to the notice of his countrymen Lords Bute and Mansfield. When Lord Bute was prime minister this legal satellite used, says Dr Johnson, to go on errands for him, and it is to Wedderburn's credit that he first suggested to the premier the propriety of granting Johnson a pension. Through the favour of Lord Bute, he was returned to parliament for the Ayr burghs in 1761. In 1763 he became king's counsel and bencher of Lincoln's Inn, and for a short time went the northern circuits, but was more successful in obtaining business in the Court of Chancery. He obtained a considerable addition to his resources (Carlyle puts the amount at £10,000) on his marriage in 1767 to Betty Anne, sole child and heiress of John Dawson of Marly in Yorkshire. When George Grenville, whose principles leaned to Toryism, quarrelled with the court, Wedderburn affected to regard him as his leader in politics. At the dissolution in the spring of 1768 he was returned by Sir Lawrence Dundas for Richmond as a Tory, but in the questions that arose over John Wilkes (*q.v.*) he took the popular side of "Wilkes and liberty," and resigned his seat in May 1769. In the opinion of the people he was now regarded as the embodiment of all legal virtue; his health was toasted at the dinners of the Whigs amid rounds of applause, and, in recompense for the loss of his seat in parliament, he was returned by Lord Clive for his pocket-borough of Bishop's Castle, in Shropshire, in January 1770. During the next session

he acted vigorously in opposition, but his conduct was always viewed with distrust by his new associates, and his attacks on the ministry of Lord North grew less and less animated in proportion to its apparent fixity of tenure. In January 1771 he was offered and accepted the post of solicitor-general. The high road to the woolstack was now open, but his defection from his former path has stamped his character with general infamy. Junius wrote of him, "As for Mr Wedderburn, there is something about him which even treachery cannot trust," and Colonel Barré attacked him in the House of Commons. The new law officer defended his conduct with the assertion that his alliance in politics had been with Mr George Grenville, and that the connexion had been severed on his death. All through the American War he consistently declaimed against the colonies, and he was bitter in his attack on Benjamin Franklin (*q.v.*) before the Privy Council. In June 1778 Wedderburn was promoted to the post of attorney-general, and in the same year he refused the dignity of chief baron of the exchequer because the offer was not accompanied by the promise of a peerage. At the dissolution in 1774 he had been returned for Okehampton in Devonshire, and for Castle Rising in Norfolk, and selected the former constituency; on his promotion as leading law officer of the crown he returned to Bishop's Castle. The coveted peerage was not long delayed. In June 1780 he was created chief justice of the Court of Common Pleas, with the title of Baron Loughborough.

During the existence of the coalition ministry of North and Fox, the great seal was in commission (April to December 1783), and Lord Loughborough held the leading place among the commissioners. For some time after that ministry's fall he was considered the leader of the Whig party in the House of Lords, and had the illness of the king brought about the return of the Whigs to power, the great seal would have been placed in his hands. The king's restoration to health secured Pitt's continuance in office, and disappointed the expectations of the Whigs. In 1792, during the period of the French Revolution, Lord Loughborough seceded from Fox, and on the 28th of January 1793 he received the great seal in the Tory cabinet of Pitt. The resignation of Pitt on the question of Catholic emancipation (1801) put an end to Wedderburn's tenure of the Lord Chancellorship, for, much to his surprise, no place was found for him in Addington's cabinet. His first wife died in 1781 without leaving issue, and he married in the following year Charlotte, youngest daughter of William, Viscount Courtenay; but her only son died in childhood. Lord Loughborough accordingly obtained in 1795 a re-grant of his barony with remainder to his nephew, Sir James St Clair Erskine. His fall in 1801 was softened by the grant of an earldom (he was created earl of Rosslyn 21st April 1801, with remainder to his nephew), and by a pension of £4000 per annum. After this date he rarely appeared in public, but he was a constant figure at all the royal festivities. He attended one of those gatherings at Frogmore, on the 31st of December 1804. On the following day he was seized with an attack of gout in the stomach, and on the 2nd of January 1805 he died at his seat, Baylis, near Salt Hill, Windsor. His remains were buried in St Paul's Cathedral on the 11th of January.

At the bar Wedderburn was the most elegant speaker of his time, and, although his knowledge of the principles and precedents of law was deficient, his skill in marshalling facts and his clearness of diction were marvellous; on the bench his judgments were remarkable for their perspicuity, particularly in the appeal cases to the House of Lords. For cool and sustained declamation he stood unrivalled in parliament, and his readiness in debate was universally acknowledged. In social life, in the company of the wits and writers of his day, his faculties seemed to desert him. He was not only dull, but the cause of dullness in others, and even Alexander Carlyle confesses that in conversation his illustrious countryman was "stiff and pompous." In Wedderburn's character ambition banished all rectitude of principle, but the love of money for money's sake was not among his faults.

See Brougham's *Statesmen of the Reign of George III.*; Foss's *Judges*; Campbell's *Lives of Lord Chancellors*. (W. F. C.)

ROSTREVOR, a watering-place of county Down, Ireland, on Carlingford Lough. See WARRENPOINT.

ROSSWEIN, a town of Germany, in the kingdom of Saxony, situated on the Freiburger Mulde, 46 m. S.E. from Leipzig by the railway via Döbeln to Dresden. Pop. (1905) 9297. It is famous for its technical schools, among which are one for builders, another for furniture-makers, and a third for ironmongers. The industries are considerable, and include woollen and cloth manufactures, dyeing, spinning, and the making of agricultural machinery, cigars, chemicals, bricks and iron goods. Rosswein is an old town, cloth-making being a flourishing industry here in the 14th century.

See C. V. Böhmert, *Die Stadt Rosswein, 1883-94* (Dresden, 1895).

ROSTAND, EDMOND (1869-), French dramatist, was born on the 1st of April 1869, the son of Joseph Eugène Herbert Rostand (b. 1843), a prominent journalist and economist of Marseilles. His first play, a burlesque, *Les romanesques*, was produced on the 21st of May 1894 at the Théâtre Français. He took the motive of his second piece, *La Princesse lointaine* (Théâtre de la Renaissance, 5th April 1895), from the story of the troubadour Rudel and the Lady of Tripoli. The part of Mélissande was created by Sarah Bernhardt, who also was the original Photine of *La Samaritaine* (Théâtre de la Renaissance, 14th April 1897), a Biblical drama in three scenes taken from the gospel story of the woman of Samaria. The production of his "heroic comedy" of *Cyrano de Bergerac* (28th December 1897, Théâtre de la Porte Saint-Martin), with Coquelin in the title-rôle, was a triumph. No such enthusiasm for a drama in verse had been known since the days of Hugo's *Hernani*. The play was quickly translated into English, German, Russian and other European languages. For his hero he had drawn on French 17th-century history; in *L'Aiglon* he chose a subject from Napoleonic legend, suggested probably by Henri Welschinger's *Roi de Rome, 1811-32* (1897), which contained much new information about the unhappy life of the duke of Reichstadt, son of Napoleon I. and Marie Louise, under the surveillance of Metternich at the palace of Schönbrunn. *L'Aiglon*, in six acts and in verse, was produced (15th March 1900) by Sarah Bernhardt at her own theatre, she herself undertaking the part of the duke of Reichstadt. In 1902 Rostand was elected to the French Academy. His *Chantecler*, produced in February 1910, was awaited with an interest (enhanced by considerable delay in the production) hardly equalled by the enthusiasm of its reception. Lucien Guitry was in the title-rôle and Mme. Simone played the part of the pheasant, the play being a fantasy of bird and animal life, and the characters denizens of the farmyard and the woods. Rostand's wife, née Rosemonde Étienne Gérard, published in 1890 *Les Pipeaux*, a volume of verse crowned by the Academy.

See a notice by Henry James in vol. 84, pp. 477 seq. of the *Cornhill Magazine*.

ROSTOCK, a town of Germany, in the grand duchy of Mecklenburg-Schwerin, one of the most important commercial cities on the Baltic. It is situated on the left bank of the estuary of the Warnow, 8 m. from the port of Warnemünde on the Baltic. 177 m. N.W. of Berlin by rail, 80 m. N.E. of Lübeck, and 106 m. S. of Copenhagen. Pop. (1905) 60,700. It consists of three parts—the old town to the east, and the middle and new towns to the west—of which the first retains some of the antique features of a Hanse town, while the last two are for the most part regularly and handsomely built. There are also several suburbs. The town has four gates, one of them dating from the 14th century, and some fine squares, among them the Blücher Platz, with a statue of Blücher, who was born here, and the Neue Markt. Rostock was a fortress of some strength, but the old fortifications have been razed, and their site is occupied by promenades. Rostock has five old churches: St Mary's, dating from 1398 to 1472, one of the most imposing Gothic buildings in Mecklenburg, with two Romanesque towers and containing a magnificent bronze font and a curious clock; St Nicholas's, begun about 1250 and restored in 1450, and again in 1890-94; St Peter's, with a lofty tower over 400 ft. high, built in 1400, which serves as a landmark to ships at sea;

St James's, completed in 1588, and the church of the Holy Rood, begun in 1270. St Mary's church contains a monument marking the original tomb of Hugo Grotius, who died in Rostock in 1645, though his remains were afterwards removed to Delft. Among other interesting buildings are the curious 14th-century Gothic town hall, the façade of which is concealed by a Renaissance addition; the palace of the grand duke of Mecklenburg-Schwerin, built in 1702; the law courts, built in 1878-79; the university buildings, erected in 1867-70; and an assembly hall of the estates of Mecklenburg (Ständehaus), a handsome Gothic building erected in 1889-93.

The university of Rostock was founded in 1418 by Dukes Johann III. and Albrecht V. of Mecklenburg. From 1437 till 1443 it had its seat at Greifswald in consequence of commotions at Rostock; and in 1760 it was again removed, on this occasion to Bützow. The professors appointed by the city, however, still taught at Rostock, so that there were practically two universities in the duchy until 1789, when they were reunited at the original seat. Rostock is the seat of the supreme court for both the duchies of Mecklenburg, and is well equipped with schools, hospitals, and other institutions.

Although the population, commerce and wealth of Rostock have declined since Hanse days, it has a considerable trade, being the chief commercial town of Mecklenburg and owning a considerable fleet. Vessels drawing 16 ft. of water are able to get up to the wharves. By far the most important export is grain, which goes almost entirely to British ports; but wool, flax and cattle are also shipped. The chief imports are coal from Great Britain, herrings from Sweden, petroleum from America, timber, wine and colonial goods. Rostock has an important fair at Whitsuntide, lasting for fourteen days, and also a frequented wool and cattle market. The industries of the town are varied. One of the chief is shipbuilding. Machinery, chemicals, sugar, malt, paper, musical instruments, cotton, straw hats, tobacco, carpets, soap, playing cards, chocolate and dye-stuffs are among the manufactures. The town also contains distilleries, saw-mills, oil-mills, tanneries, breweries and electrical works.

Local historians assert that a village existed on the site of Rostock as early as A.D. 329, but no certain proofs have been traced of any earlier community than that founded here in the 12th century, which is said to have received municipal rights in 1218. The earliest signs of commercial prosperity date from about 1260. For a time Rostock was under the dominion of the kings of Denmark. Soon after returning under the protection of Mecklenburg in the 14th century it joined the Hanseatic League; and was one of the original members of the powerful Wendish Hansa, in which it exercised an influence second only to that of Lübeck. The most prosperous epoch of its commercial history began in the latter half of the 15th century, precisely at the period when its political power began to wane. Rostock, however, never entirely lost the independence which it enjoyed as a Hanse town; and in 1788, as the result of long contentions with the rulers of Mecklenburg, it secured for itself a peculiar and liberal municipal constitution, administered by three burgomasters and three chambers. In 1880 this constitution was somewhat modified, and the city became less like a state within a state. It has belonged to Mecklenburg-Schwerin since 1695; in 1712 it was taken by the Swedes, in 1715 by the Danes and in 1716 by the Russians. The badge of Rostock is the figure 7; and a local rhyme explains that there are 7 doors to St Mary's church, 7 streets from the market-place, 7 gates on the landward side and 7 wharves on the seaward side of the town, 7 turrets on the town-hall, which has 7 bells, and 7 Linden trees in the park.

See Reinhold, *Chronik der Stadt Rostock* (Rostock, 1836); Krabbe, *Die Universität Rostock im 15. und 16. Jahrhundert* (2 vols., Rostock, 1854); Koppmann, *Geschichte der Stadt Rostock* (Rostock, 1887); Volkmann, *Führer durch Rostock* (3rd ed., 1896); *Die Geschichtsquellen der Stadt Rostock* (Rostock, 1885); and the *Beiträge zur Geschichte der Stadt Rostock* (Rostock, 1890).

ROSTOPTSCHIN, COUNT FEODOR VASSILIEVICH (1763-1826), Russian general, was born on the 23rd of March 1763, in the government of Orel. He had great influence with the Tsar Paul, who made him in 1796 adjutant-general, grand-marshal of the court, then minister of the interior. In 1799 he received the title of count. He was disgraced in 1801 for his opposition to the French alliance, but was restored to

favour in 1810, and was shortly afterwards appointed military governor of Moscow. He was therefore charged with its defence against Napoleon, and took every means to rouse the population of the town and district against the invader. He has been generally charged with instigating the burning of Moscow the day after the French had made their entry; it is certain that the prisons were opened by his order, and that he took no means to stop the outbreak. He defended himself against the charge of incendiarism in a pamphlet printed in Paris in 1823, *La Vérité sur l'incendie de Moscou*, but he subsequently made grave admissions. Shortly after the congress of Vienna, to which he had accompanied the Tsar Alexander, he was disgraced. He only returned to Russia in 1825, and died at Moscow on the 12th of February of the next year.

His *Mémoires écrits en dix minutes* were posthumously published at St Petersburg in 1853, his *Œuvres inédites* in Paris in 1894. A partial account of his life was written by his grandson A. de Ségur (Paris, 1872). See also Varnhagen von Ense, *Denkwürdigkeiten*, vol. ix.; G. Tzenoff, *Wer hat Moskau im Jahre 1812 in Brand gesteckt* (Berlin, 1900).

ROSTOV-ON-THE-DON, a seaport of Russia, in the territory of the Don Cossacks, well situated on the high right bank of the Don, 13 m. from its mouth in the Sea of Azov. In 1731 a small fort was erected on an island in the Don, near its mouth. Thirty years later the fortifications were transferred to the site now occupied by Rostov, 5 m. above the head of the first branch of the delta of the Don. The Don, which has here a breadth of 230 to 250 yds., with a hardly perceptible current, offers an excellent roadstead. The navigation, however, is considerably impeded by the shallowness of the river. Dredging operations have but partially remedied this. Moreover, the river is frost-bound for more than one hundred days in the year. The population has grown rapidly; while in 1881 it was 70,700, in 1897 it numbered 119,880, and in 1905 126,375, exclusive of the suburbs; if these, which comprise Nakhichevan (32,582 in 1905) be included, the population is well over 160,000, a figure which is still further swollen in the summer by the influx of about 60,000 men, who find work in connexion with the shipment of grain for export. The permanent population includes 15,000 Jews, 5000 Armenians, with Tatars, Poles, Germans and others. In Nakhichevan there are 20,500 Armenians. Owing to its situation on the navigable river Don and at the junction of three railways, radiating to north-western Russia, Caucasia and the Volga respectively, Rostov has become the chief seaport of south-eastern Russia, being second in importance on the Black Sea to Odessa only. It is the chief centre for the supply of agricultural machinery to the steppe governments of south-eastern Russia. On an average, £3,000,000 to £4,000,000 worth of wheat, about £1,000,000 worth of rye, and over £1,500,000 worth of barley are exported annually, besides oats, flax, linseed, rape seed, oilcake, bran, flour, vegetable oils, raw wool and caviare. The imports average between four and five millions sterling annually, and consist largely of agricultural machinery. There are a shipbuilding yard, flour-mills, tobacco factories, iron works, machinery works, distilleries, soap works, timber mills, bell foundries, paper mills and rope works. Rostov is the chief centre of steam flour-mills for south-eastern Russia and Caucasia. Two fairs, one of which has considerable importance for the whole of south-eastern Russia, are held here yearly. Rostov has excellent fisheries. The town has a cathedral, a fine town hall (1897-99), navigation schools, technical schools, and a good municipal library.

ROSTOV VELIKIY, a town of Russia, in the government of Yaroslavl, 35 m. by rail S.W. of the town of Yaroslavl, near Lake Rostov or Nero. Pop. (1897) 14,342. It has numerous cotton and linen mills. The great fair for which it was formerly famous has lost its importance, but the town remains the centre of a variety of domestic trades—tailoring, the manufacture of leather, and the making of boots and small enamelled ikons (sacred images); it is also famous for its kitchen gardening and the export of pickled and dried vegetables and medical herbs. Fishing is carried on. The restoration of the buildings

(royal palace, archiepiscopal palace, and five churches) of the kreml or citadel was begun in 1901. The other public buildings include six 17th-century churches, a museum and a cathedral, consecrated in 1231 and having its interior walls covered with paintings.

Rostov was founded by Slavs in or before 862, and played so prominent a rôle in the history of that part of Russia that it used to be known as Rostov the Great. From the beginning of the 11th century to the 13th it was the chief town of a territory which included large parts of the present governments of Yaroslavl, Vladimir and Novgorod. After the Mongol invasion of 1239-42 it rapidly declined, and in 1474 it was purchased by Ivan III. and annexed to Moscow. It was repeatedly plundered by Tatars, Lithuanians and Poles in the 15th, 16th and 17th centuries.

ROSTRA¹ ("beaks"), in Roman antiquities, the orators' platform, which originally stood between the comitium and the forum proper, opposite the curia. It is not known when it was erected, but in 338 B.C. it was decorated by Gaius Maenius with the prows of ships captured from the people of Antium (Livy viii. 14). From that time it was called *Rostra*, having previously been known as *templum* (literally "consecrated place"), since it had been consecrated by the augurs (Cicero, *In Vatinius*, s. 24). Some, however, deny the identity of the *templum* and *rostra*. On the platform or hard by were exhibited the statues of famous Romans (Camillus, Caesar), and state documents and memorials (the laws of the Twelve Tables, the treaty with the Latins, the *columna rostrata* of Duilius). Caesar had it pulled down, intending that it should be rebuilt on the west side of the forum, but it was left for Augustus (or Mark Antony) to carry out his plan. The term *Rostra Vetera*, often used by classical authors in connexion with funeral orations, makes it doubtful whether the old platform was entirely demolished, unless the name was simply transferred to the new *rostra* of Augustus. This consisted of a rectangular platform, 78 ft. long, 33 ft. broad and 11 ft. above the level of the forum pavement. It was reached by steps from the back; in front there was a marble balustrade with an opening in the centre where the speaker stood, possibly also intended for a staircase leading down into the forum. In the existing remains the holes in which the beaks of the ships were fastened, arranged in pairs, are visible. Behind these remains, close to the Clivus Capitolinus, a row of light low-arched cells has been found, which, owing to a certain resemblance to the earlier *rostra* as shown on the well-known coin of Lollius Palicanus, has been identified by Boni with the *rostra* removed by Julius Caesar, the other remains being attributed to the time of Domitian (for objections to this theory, see Hülsen and Richter). In the time of Hadrian the side balustrades were decorated with marble slabs, on which were represented in relief the burning of the lists of the citizens who were in arrears to the fisc and the distribution of necessities to the poorer citizens. Thélenat explains the first as Domitian re-assuring a deputation of citizens by burning the denunciatory reports of the *delatores*, and the second (the scene of which he places at the *Rostra Julia*) as the promulgation of the law forbidding the mutilation of children. The erection of the arch of Severus necessitated considerable alterations, the most important of which was a triangular courtyard cut out of the north half of the *rostra*, to allow direct access to it from the side that faced the arch, its breadth being thereby reduced by a third. A later extension of the façade northwards is explained by a long inscription, recording that about the year 470, Ulpius Junius Valentinus, a city prefect, restored the structure (hence called *Rostra Vandaliana*) after a naval victory over the Vandals. A relief on the arch of Constantine represents the emperor speaking from the *rostra*.

The *Rostra Julia* was a platform with a semicircular niche

¹ The Lat. singular *rostrum*, a beak, the beak of a ship, is used in English of a platform, stand or pulpit from which a speaker addresses his audience. It is also used in its original meaning of a beak-like prolongation or process in zoology or botany.

in the centre, in front of the Aedes divi Julii, built by Augustus on the spot where the body of Caesar was cremated. The niche was probably used to support the bier while a funeral *laudatio* was being delivered. The front on either side was decorated with the beaks of ships captured at the battle of Actium.

For results of the excavations see C. Hülsen, *Das Forum Romanum* (Eng. tr. by J. B. Carter, R. me, 1906); see also O. Richter, "Topographie der Stadt Rom" (1901), pp. 81, 93, 356 (iii. Abr. 3, pt. 2 of L. von Müller's *Handbuch der klassischen Altertumswissenschaft*); H. Thedenius, *Le Forum Romanum* (3rd ed. 1904); J. H. Middleton, *Remains of Ancient Rome* (1892); O. Richter, *Rekonstruktion und Geschichte der römischen Rednerbühne* (Berlin, 1884); F. M. Nichols, *The Roman Forum* (1877); also article *ROMA: Archaeology*.

ROTA, COURT OF, one of the departments of the medieval papal organization, existing alongside the Dataria, the Penitentiaria, the two Signaturas (*S. Gratiae* and *S. Justitiae*), and other bureaus. The Rota was the supreme court of Christendom. It consisted of twelve members, three from Rome, two from Spain, one each from Bologna, Ferrara, Venice, Milan, Germany, France, and (alternately) Tuscany or Perugia. It declined in importance when the Signatura Justitiae was set above it as the court of appeal for Italy, and more so as the geographical jurisdiction of the pope was gradually lessened. After the Council of Trent the old arrangements were replaced by the Congregations, permanent committees of cardinals which deal with definite branches of business. The Rota, however, was restored to its functions as supreme court of appeal by Pope Pius X. in 1908 (see *CURIA ROMANA*).

ROTH, JUSTUS LUDWIG ADOLF (1818-1892), German geologist and mineralogist, was born at Hamburg on the 15th of September 1818. In 1867 he was appointed professor of mineralogy at the university of Berlin. He may be regarded as one of the founders of petrographical science. In his published papers he dealt with metamorphism and crystalline schists, discussed the origin of serpentine, and wrote on Vesuvian rocks and on Ponza Island. His separate works included *Der Vesuv und die Umgehung von Neapel* (1857); *Beiträge zur Petrographie der plutonischen Gesteine* (1869-84); *Allgemeine und chemische Geologie* (3 vols., 1879-93); and *Über die Erdkruste* (1882). He died at Berlin on the 1st of April 1892.

ROTHER, RICHARD (1799-1867), Lutheran theologian, was born at Posen on the 28th of January 1799. He studied theology in the universities of Heidelberg and Berlin (1817-20) under Karl Daub (1765-1836), Schleiermacher and Neander, the philosophers and historians Georg Hegel, Friedrich Creuzer (1771-1858) and F. C. Schlosser (1775-1861) exercising a considerable influence in shaping his thought. From 1820 to 1822 he was in the clerical seminary at Wittenberg. In the autumn of 1823 he was appointed chaplain to the Prussian embassy in Rome, of which Baron Bunsen was the head. This post he exchanged in 1828 for a professorship in the Wittenberg theological seminary, of which in 1832 he became also second director and *ephorus*, and hence in 1837 he removed to Heidelberg as professor and director of a new clerical seminary; in 1849 he accepted an invitation to Bonn as professor and university preacher, but in 1854 he returned to Heidelberg as professor of theology, and afterwards became member of the Oberkirchenrath, a position he held until his death on the 20th of August 1867. As a youth Rothe had a bent towards a supernatural mysticism; his chosen authors were those of the romantic school, and Novalis remained throughout his life a special favourite. In Berlin and Wittenberg he came under the influence of Pietism as represented by such men as Rudolf Stier (1800-1862) and Friedrich Tholuck, though Tholuck pronounced him a "very modern Christian." He afterwards confessed that, though he had been a sincere, he was never a happy, Pietist. In Rome, under the broadening influence of classical and ecclesiastical art, he learned to look at Christianity in its human and universalistic aspects, and began to develop his great idea, the inseparable relation of religion and morals. He began then, and particularly after the revolution of July 1830, likewise to give a more definite form to his peculiar view of the relations of church and state. He thus became

out of harmony with the pietistic thought and life of Wittenberg. His removal to Heidelberg and the publication of his first important work, *Die Anfänge der christlichen Kirche und ihrer Verfassung* (1837), coincide with the attainment of the principal theological positions with which his name is associated. During the middle period of his career (1837-61) he led the life of a scholastic recluse. During the last six years of his life he came forward as the advocate of a free theology and of the Protestantenverein.

Rothe was one of the most profound and influential of modern German theologians. Like Schleiermacher he combined with the keenest logical faculty an intensely religious spirit, but his philosophical tendencies were in sympathy rather with Hegel than with Schleiermacher, and theosophic mysticism was more congenial to him than the abstractions of Spinoza, to whom Schleiermacher owed so much. He classed himself among the theosophists, and claimed to be a convinced and happy supernaturalist in a scientific age. His system, though it may seem to contain doubtful or even fantastic elements, is in its general outlines a noble massive whole, constructed by a profound, comprehensive, fearless and logical mind. A peculiarity of his thought was the realistic nature of his spiritualism; his abstractions are not real essences, his spiritual entities are real and corporeal, his truth is actual being. Hence Rothe, unlike Schleiermacher, lays great stress, for instance, on the personality of God, on the reality of the worlds of good and evil spirits, and on the visible second coming of Christ. Hence his religious feeling and theological speculation demanded their realization in a kingdom of God coextensive with man's nature, terrestrial history and human society; and thus his theological system became a *Theologische Ethik*, as he entitled one of his books (3 vols., 1845-1848). It is on this work that Rothe's permanent reputation as a theologian and ethical writer will rest. The first edition remained twelve years out of print before the second (1857-61) appeared. It was the author's purpose to rewrite the whole, but he died when he had completed the first two volumes. The remainder was reprinted from the first edition by Professor Heinrich Holtzmann, with the addition of some notes and emendations left by the author.

The *Theologische Ethik* begins with a general sketch of the author's system of speculative theology in its two divisions, theology proper and cosmology, cosmology falling into the two subdivisions of *Physis* (the world of nature) and *Ethik* (the world of spirit). It is the last section of the work which is occupied by the author. After an analysis of the religious consciousness, which yields the doctrine of an absolute personal and spiritual God, Rothe proceeds to deduce from his idea of God the process and history of creative development, which is eternally proceeding and bringing forth, as its unending purpose, worlds of spirits, partially self-creative and sharing the absolute personality of the Creator. Rothe regards the natural man as the consummation of the development of physical nature, and obtains spirit as the personal attainment, with divine help, of those beings in whom the further creative process of moral development is carried on. His theory leaves the natural man, without hesitation, to be developed by the natural process of animal evolution. The attainment of the higher stage of development is the moral and religious vocation of man; this higher stage is self-determination, the performance of every human function as a voluntary and intelligent agent, or as a person, having as its cosmic effect the subjection of all material to spiritual existences. This personal process of spiritualization is the continuation of the eternal divine work of creation. Thus the moral life and the religious life coincide, and when normal are identical; both have the same aim and are occupied with the same task, the accomplishment of the spiritualization of the world. "Faith," that it may become truth and reality, demands morality as its fulfilment, as the only concrete element in which the idea of fellowship with God is realized; morality, that it may find its perfect unfolding, requires the aid of piety, in the light of which alone it can comprehend its own idea in all its breadth and depth." The process of human development Rothe regards as necessarily taking an abnormal form and passing through the phase of sin. This abnormal condition necessitates a fresh creative act, that of salvation, which prepares for his salvation supernatural revelation was required for the purifying and revivification of the religious consciousness, and the Saviour Himself had to appear in human history as a fresh miraculous creation, born of a woman but not begotten by a man. In consequence of His supernatural birth the Saviour, or the second Adam, was free from original sin. By His own moral and religious development He made possible a relation of perfect fellowship between God and man, which was the new and highest stage of the divine creation of mankind. This stage of development inaugurated by the Saviour is attained by means of His kingdom or the community of salvation, which is both a region and a time, and in the first instance and temporarily only religious—that is, a church. As men reach the full development of their nature, and appropriate the perfection of the Saviour, the separation between

the religious and the moral life will vanish, and the Christian state, as the highest sphere of human life representing all human functions, will displace the church. "In proportion as the Saviour Christianizes the state by means of the church must the progressive completion of the structure of the church prove the cause of its abolition." The decline of the church is therefore not to be deplored, but recognized as the consequence of the independence and completeness of the Christian life. It is the third section of his work—the *Pflichtenlehre*—which is generally most highly valued, and where his full strength as an ethical thinker is displayed, without any mixture of theosophic speculation.

Since Rothe's death several volumes of his sermons and of his lectures (on dogmatics, the history of homiletics) and a collection of brief essays and religious meditations under the title of *Stille Stunden* (Wittenberg, 1872) have been published.

See F. Nippold, *Richard Rothe, ein christliches Lebensbild* (2 vols., Wittenberg, 1873-74); D. Schenkel, "Zur Erinnerung an Dr. R. Rothe," in the *Allgemeine kirchliche Zeitschrift* (1867-68); H. Holtzmann, "Richard Rothe," in the *Jahrbuch des Protestantenvereins* (1869); K. H. W. Schwarz, *Zur Geschichte der neuesten Theologie* (4th ed., Leipzig, 1869, pp. 417-44); Otto Pfeleiderer, *Religionsphilosophie auf geschichtlicher Grundlage* (2nd ed., Berlin, 1884, vol. 1, pp. 611-15); cf. *The Development of Theology in Germany since Kant* (1890); W. Hönig, *Richard Rothe, sein Charakter, Leben und Denken* (1898); Adolf Hausrath, *Richard Rothe und seine Freunde* (1902).

ROTHELIN, JACQUELINE DE ROHAN, MARQUISE DE (c. 1520-1587), daughter of Charles de Rohan and Jeanne de Saint-Séverin. Her husband, François of Orleans-Longueville, marquis de Rothelin, died in 1548, and in watching her son's interests in Neuchâtel she was brought into contact with the reformers in Switzerland. She then embraced Protestantism and turned her chateau at Blandy, in Brié, into a refuge for Huguenots. In 1567 she underwent a term of imprisonment at the Louvre for harbouring Protestants.

ROTHELNBURG-OB-DER-TAUBER, a town of Germany, in the kingdom of Bavaria, 49 m. by rail S.W. of Nuremberg. Pop. (1905) 8,436. It is beautifully situated on an eminence 200 ft. above the Tauber. It is flanked by medieval walls, towers and gates, and its antique appearance has been carefully preserved. Perhaps the most interesting building is the town hall, one part of which dates from 1240 and the other from 1572. The latter is a beautiful Renaissance structure, with a magnificent façade and a delicate spire, and contains a grand hall, the Kaisersaal, in which every Whit Monday a play, *Der Meistertrunk*, which commemorates the capture of the town by Tilly in 1631, is performed. Other buildings are the Gothic church of St James, with curiously carved altars and beautiful stained-glass windows, and containing in the Toppler chapel the tomb of the burgo-master, Heinrich Toppler; the 15th-century church of St Wolfgang; the Franciscan church; and five other churches. The town has many picturesque houses, and possesses a library with some interesting archives. It has manufactures of toys and agricultural machinery, electrical works and breweries.

Rothelnburg-ob-der-Tauber, mentioned in the chronicles in 804 as *Rolinburg*, was probably a residence of the dukes of Franconia. It first appears as a town in 942 and until 1108 was the seat of the counts of Rothelnburg-Komburg; when this line became extinct it passed to the family of Hohenstaufen, one member of which took the title of duke of Rothelnburg. In 1172 it became a free imperial city and it attained the zenith of its prosperity under the famous burgo-master Heinrich Toppler (1350-1408). It took part in the movements in South Germany during the 15th and 16th centuries. In 1631 Rothelnburg was stormed by Tilly, and the cup of wine presented by the burgo-master, which, according to tradition, saved the town from destruction, is annually commemorated in the play mentioned above.

See Bensen, *Beschreibung und Geschichte der Stadt Rothenburg* (Erlangen, 1856); Metz, *Rothenburg in alter und neuer Zeit* (2nd ed., Ansbach, 1881); Schultze, *Rothenburg, ein Städtebild* (Zürich, 1892); and *Das Festspiel zu Rothenburg-ob-der-Tauber* (Munich, 1892); and W. Klein, *Führer durch die Stadt Rothenburg* (Rothenburg, 1888).

ROTHERHAM, THOMAS (1423-1500), archbishop of York, also called THOMAS SCOT, was born at Rotherham on the 24th of

August 1423; he was educated in his native town and seems to have been connected with both the universities of Oxford and Cambridge. Having entered the church he became rector of Ripple, Worcestershire, and later of St Vedast, Foster Lane, London, and it was probably when he was chaplain to John de Vere, earl of Oxford, that he made the acquaintance of Elizabeth Woodville, afterwards the queen of Edward IV. In 1467 Rotherham became keeper of the privy seal to this king; in 1468 he was appointed bishop of Worcester, in 1472 bishop of Lincoln and in 1475 chancellor of England. Several times he went to France on public business; in 1475 at the treaty of Picquigny he received a pension from Louis XI. of France, and in 1480 he was chosen archbishop of York. When Edward IV. died in April 1483 the archbishop remained true to his widow Elizabeth, and consequently lost the chancellorship and was put into prison by Richard III. He was soon set at liberty, and he died in 1500 at Cawood, near York. At Oxford Rotherham built part of Lincoln College and increased its endowment; at Cambridge, where he was chancellor and master of Pembroke Hall, he helped to build the University Library. He founded a college at Rotherham, which was suppressed under Edward VI., and he was responsible for the building of part of the church of All Saints there.

ROTHERHAM, a market-town and municipal borough in the Rotherham parliamentary division of the West Riding of Yorkshire, England, 5 m. N.E. of Sheffield, on the Midland, North-Eastern and Great Central railways. Pop. (1891) 42,001; (1901) 54,349. It lies in the valley of the Don, where that river is joined by the Rother, and has communication by water with the Humber. The Don is crossed by a bridge on which is a small ancient building, formerly a chapel. The parish church of All Saints, occupying the site of a building dating from Anglo-Saxon times, was erected in the reign of Edward IV., and is among the best specimens of Perpendicular in the north of England. The town possesses iron, steel and brass works, railway wagon works, potteries, glass-works, breweries, saw-mills and rope-yards. At the township of Masborough, opposite Rotherham across the Don, works were established in 1746 by Samuel Walker, a successful ironmaster. The municipal borough, incorporated in 1871, is under a mayor, 6 aldermen and 18 councillors. Area, 6,012 acres.

The town was of some importance in Anglo-Saxon times, and at Templeborough, on the S.E. side of Rotherham, there was a Roman fort, but its traces are effaced. In the time of Edward the Confessor, Rotherham possessed a market and a church. During the Civil War it sided with the Parliament. It was taken by the Royalists in 1643, but after the victory of Marston Moor was yielded to a detachment of the Parliamentary forces.

ROTHERS, EARLS OF. The first earl of Rothes was George Leslie, son of Norman Leslie of Rothes in Moray, and of Ballinbreich in Fife. In 1445 he was created Baron Leslie of Leven, and about 1458 earl of Rothes in the peerage of Scotland. His grandson George, the 4th earl (d. 1558), whose father, William, the 3rd earl, was killed at Flodden, was accused, but acquitted in 1546, of complicity in the murder of Cardinal Beaton, in which his brother and his two sons were undoubtedly implicated; he was one of the Scottish commissioners who witnessed the marriage of Mary queen of Scots with Francis, the dauphin of France. His son Andrew, 5th earl of Rothes (d. 1611), took an active part with the lords of the congregation, first against the queen-mother, Mary of Guise, when regent of Scotland, and afterwards against Mary queen of Scots in opposing her marriage with Darnley, and in devising the murder of Rizzio. He was, however, one of the peers who acquitted Bothwell of Darnley's murder; and going over to the side of the queen, he fought for her at Langside. He continued to occupy a position of some prominence in Scottish affairs until his death in 1611. His great-grandson, John, 7th earl of Rothes (1630-1681), held a command in the Royalist army at the battle of Worcester in 1651, and accompanied Charles II. to England at the Restoration, when he became

lord president of the council in Scotland. He was lord treasurer of Scotland from 1663 till 1667, when he was made lord chancellor of Scotland for life. His estates having been sequestered by the parliament in 1651, he received a re-grant in 1663 of the earldom of Rothes, together with the title of Lord Leslie and Ballinbreich, with remainders to his heirs male and female, providing that in every case where a female should succeed to the peerage the name of Leslie should be assumed by her husband. In 1680 the earl was advanced to the dignity of duke of Rothes and marquess of Ballinbreich, but these titles became extinct at his death without a son in the following year. The earldom of Rothes and the other older titles now passed, under the special remainder mentioned above, to his daughter Margaret, whose husband, Charles Hamilton, 5th earl of Haddington, accordingly took the name of Leslie, at the same time making an arrangement by which his own peerage should pass to a younger son in order to keep the two earldoms separate. Margaret's son John, who on her death became 9th earl of Rothes, was vice-admiral of Scotland from 1715 to 1722, and fought with distinction against the Jacobite rebels in 1715; and her grandson, the 10th earl, who sold the estates of Ballinbreich to the Dundas family, was commander-in-chief in Ireland in 1754, and became a general in 1765. The office of sheriff of Fife, which had been an hereditary right of the earls of Rothes since 1540, was sold by the 10th earl under the Heritable Act of 1747. On several subsequent occasions the earldom again passed through the female line, and in 1803 Mary Elizabeth, countess of Rothes in her own right, was succeeded by her grandson, Norman Evelyn Leslie (b. 1877), as 10th earl of Rothes.

See Sir R. Douglas, *The Peerage of Scotland*, edited by Sir J. B. Paul, and G. E. C., *Complete Peerage*.

ROTHESAY, a royal, municipal and police burgh, and the chief town of the county and island of Bute, Scotland. Pop. (1001) 9378. It is situated on a beautiful bay, 40 m. S.W. of Glasgow, with which there is regular communication by railway steamers from Wemyss Bay, Gourcock, Greenock (Prince's Pier) and Craigendoran, as well as by many other steamers from Glasgow and the Clyde ports. It is a popular watering-place, and as the bay is sheltered by low wooded hills and affords excellent anchorage, it is well patronized by yachts. Loch Striven, on the opposite shore of Argyllshire, is known as the "Rothesay weather-glass," its appearance furnishing a certain clue to meteorological conditions. The town is under the jurisdiction of a provost and council. Rothesay has ceased to be a manufacturing centre, fishing being now its chief industry. Owing to its mild and equable climate it is a resort of invalids. There is a tramway to Port Bannatyne, pleasantly situated on the east horn of Kames Bay, and Craigmore, about 1 m. west of Rothesay, is a fashionable suburb. Ardbeg Point, Loch Fad, Loch Ascog and Barone Hill (530 ft.) are all within a mile and a half of the town, and there are numerous excursions by road to other points of interest. The Kyles of Bute are within a short sail of Rothesay. In the centre of the town are the ruins of a castle erected in 1098 either by Magnus Barefoot, king of Norway, or by the Scots as a defence against the Norwegians, with whom during the 13th century, and earlier, there was constant strife. The village which grew up round the castle was made a royal burgh by Robert III., who, in 1398, created his eldest son David duke of Rothesay, a title which became the highest Scottish title of the heir-apparent to the crown of the United Kingdom. During the Commonwealth the castle was garrisoned by Cromwell's troops. It was burned by the followers of Argyll in 1685, and remained neglected till the rubbish was cleared away by the second marquess of Bute in 1816. It was repaired by the third marquess.

ROTHSCHILD, the name of a Jewish family which has acquired an unexampled position from the magnitude of its financial transactions. The original name was Bauer, the founder of the house being **MAYER ANSELM** (1743-1812), the son of Anselm Moses Bauer, a small Jewish merchant of Frankfort-

on-the-Main. His father wished him to become a rabbi, but he set up as a money-lender at the sign of the "Red Shield" (*Rothschild*) in the Frankfort Judengasse. He had already acquired some standing as a banker when his numismatic tastes obtained for him the friendship of William, ninth landgrave and afterwards elector of Hesse-Cassel, who in 1801 made him his agent. In the following year Rothschild negotiated his first great government loan, ten million thalers for the Danish government. When the landgrave was compelled to flee from his capital on the entry of the French, he placed his silver and other bulky treasures in the hands of Rothschild, who, not without considerable risk, took charge of them and buried them, it is said, in a corner of his garden, whence he dug them up as opportunity arose for disposing of them. This he did to such advantage as to be able afterwards to return their value to the elector at 5% interest. He died at Frankfort on the 19th of September 1812, leaving ten children, five sons and five daughters. Branches of the business were established at Vienna, London, Paris and Naples, each being in charge of one of the sons, the chief of the firm always residing at Frankfort. By a system of co-operation and joint counsels, aided by the skilful employment of subordinate agents, they obtained unexampled opportunities of acquiring an accurate knowledge of the condition of the financial market, and practically embraced the whole of Europe within their financial network. The unity of the interests of the several members of the firm has been preserved by the system of intermarriages which has been the general practice of the descendants of the five brothers. Each of the brothers received in 1815 from Austria the privilege of hereditary landowners, and in 1822 they were created barons by the same country. The charge of the Frankfort house devolved on the eldest, **ANSELM MAYER** (1773-1855), born on the 12th of June 1773, who was chosen a member of the royal Prussian privy council of commerce, and, in 1820, Bavarian consul and court banker. The Vienna branch was undertaken by **SOLOMON** (1774-1826), born on the 9th of December 1774, who entered into intimate relations with Prince Metternich, which contributed in no small degree to bring about the connexion of the firm with the allied powers. The third brother, **NATHAN MAYER** (1777-1836), born on the 16th of September 1777, has, however, generally been regarded as the financial genius of the family, and the chief originator of the transactions which have created for the house its unexampled position in the financial world. He went to Manchester about 1800 to act as a purchaser for his father of manufactured goods; but at the end of five years he removed to London. The boldness and skill of his financial transactions, which caused him at first to be regarded as unsafe by the leading banking firms and financial merchants, later awakened their admiration and envy. By the employment of carrier-pigeons and of fast-sailing boats of his own for the transmission of news he was able to utilize to the best advantage his special sources of information, while no one was a greater adept in the art of promoting the rise and fall of the stocks. The colossal influence of the house dates from an operation of his in 1810. In that year Wellington made some drafts which the English government could not meet; these were purchased by Rothschild at a liberal discount, and renewed to the government, which finally redeemed at par. From this time the allied powers negotiated loans to carry on the war against Napoleon chiefly through the house of Rothschild. Rothschild never lost faith in the ultimate overthrow of Napoleon, his all being virtually staked on the issue of the contest. He is said to have been present at the battle of Waterloo. Being able to transmit to London private information of the allied success several hours before it reached the public, he effected an immense profit by the purchase of stock, which had been depressed on the news of Blucher's defeat two days previously. Rothschild was the first to popularize foreign loans in Britain by fixing the rate in sterling money and making the dividends payable in London and not in foreign capitals. Latterly he became the financial agent of nearly every civilized government, although persistently declining contracts for Spain or the American States. He did not confine himself to

operations on a large scale, but on the contrary made it a principle to despise or neglect no feasible opportunity of transacting business, while at the same time his operations gradually extended to every quarter of the globe. He died on the 28th of July 1836, and was succeeded in the management of the London house by his son LIONEL (1808-1879), born on the 22nd of November 1808, whose name is associated with the removal of the civil disabilities of the Jews. He was elected a member for the City of London in 1847, and again in 1849 and 1852, but it was not till 1858 that the joint operation of an act of parliament and a resolution of the House of Commons, allowing the omission from the oath of the words to which as a Jew he conscientiously objected, rendered it possible for him to take his seat. He continued to represent the City of London till 1874. His eldest son, NATHAN (b. 1840), was created a peer as Baron Rothschild in 1885. JACOB (1792-1868), the youngest of the original brothers, was entrusted with the mission of starting the business in Paris after the restoration of the Bourbons, for whom he negotiated large loans. At the Revolution of 1848 he was a heavy loser, and had also to be protected for a time by a special guard. It was by his capital that the earliest railways were constructed in France; the profits he obtained from the speculation were very large. He died on the 15th of November 1868. The Naples branch was superintended by another of the brothers, KARL (1780-1855). It was always the least important of the five, and after the annexation of Naples to Italy in 1860 it was discontinued.

See *Das Haus Rothschild* (1858); Picciotto, *Sketches of Anglo-Jewish History* (1875); Francis, *Chronicles and Characters of the Stock Exchange* (1853); Treskow, *Biographische Notizen über Nathan Meyer Rothschild nebst seinem Testament* (1837); Roqueplan, *Le Baron James de Rothschild* (1868).

ROTHWELL, an urban district in the Normanton parliamentary division of the West Riding of Yorkshire, England, 4 m. S.E. of Leeds. Pop. (1901) 11,702. The church of the Holy Trinity, though largely restored, retains some good Decorated details. Rothwell soon after the Conquest was granted as a dependency of the castle of Pontefract to the Lacy, who erected here a baronial residence of which there are slight remains. Coal and stone are obtained in the neighbourhood, and the town possesses match-works and rope and twine factories in which the majority of the large industrial population is employed.

ROTIFERA (or **ROTATORIA**), a small, in many respects well-defined and somewhat isolated, class of the animal kingdom. Now familiarly known as "wheel animalcules," from the wheel-like motion produced by the fings of cilia which generally occur in the head region, the so-called rotatory organs, they were first discovered by A. Leeuwenhoek, to whom we also owe the discovery of Bacteria and ciliate Infusoria. Leeuwenhoek described *Rotifer vulgaris* in 1702, and he subsequently described *Meliceria ringens* and other species. A great variety of forms were described by other observers, but they were not separated as a class from the unicellular organisms (*Protozoa*) with which they usually occur, until the appearance of C. G. Ehrenberg's monograph, which contained a mass of detail regarding their structure. At the present day few groups of the animal kingdom are so well known to the microscopist, few groups present more interesting affinities to the morphologist, and few multicellular animals such a low physiological condition.

A rotifer may be regarded as typically a hemisphere or half an oblate spheroid or paraboloid with a mouth somewhere on the flat end ("disk" or "corona"), which bears a usually double ciliated ring, the outer zone the "cingulum," and inner the "trochus"; this ring serves both for progression and for bringing up food. The body-wall, cuticulated outside, is formed by a single layer of ill-defined cells, and surrounds the simple body cavity (archicoele), traversed by simple or branched muscular fibres ("mesenchyme") (fig. 1, *m, m*). The mouth opens through a narrow pharynx (*p*) into a chamber which is (as in Crustacea) at once crop and gizzard, the mastax (*ma*), whose thickenings are imbedded in the postero-ventral wall. A slender ciliated gullet (*g*) leads into a large stomach (*st*) whose wall consists of large rigid ciliated cells with usually a pair of simple secretory sacs opening into it; it may open through an intestine or rectum into the cloaca. A pair of coiled nephridial

tubes (*n*) formed of a file of perforated "drain-pipe" cells, with ciliated tag-like "flame" cells (*f*), open into a contractile bladder (*bl*),

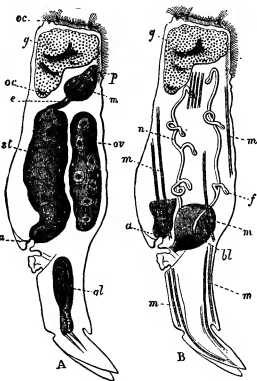

FIG. 1.—*Notommatia naias*. A and B represent the same animal, some of the organs being shown in one figure and some in the other. *oc*, eyes-spots; *g*, nerve ganglion; *p*, pharynx; *ma*, mastax; *st*, oesophagus; *st*, stomach; *a*, anus, opening into the cloaca; *gl*, cement-glands in the foot; *n*, nephridia; *f*, flame-cells; *bl*, bladder; *m, m*, muscles; *ov*, ovary (vitellarium alone seen).

which passes by a slender duct into the cloaca. Into this also opens the genital duct from the single or paired gonad (*ov*). The simple nerve-ganglion or brain (*g*) lies on the anterodorsal side of the pharynx, and by its position determines the orientation of the animal, the cloacal opening lying on the same side, and the course of the gut being "neural." The sense organs are a pair of pigmented eyes (*oc*), and two pairs of antennae, one anterior proximal and near the wreath, the other distal and usually more or less lateral. The sexes are always separate, the males being of very rare occurrence in most cases. In the female the gonad is complex as in flatworms, composed of a germary for the formation of the eggs, and a vitellary, much more conspicuous and alone figured (*ov*), consisting of a definite number of large nucleated cells for the nourishment of the eggs. The apical end of the rotifer usually narrows suddenly beyond the curve of the gut and the cloacal aperture to form the foot of pseudopodium which ends in an organ of attachment, a pair of movable toes, each with the opening of a cement-gland (*gl*) at its tip. Thus for orientation we place the rotifer like the cuttle-fish, head downwards: the ciliated disk is basal or oral, proximal to the rest of the animal, the foot is apical, and the brain and cloacal aperture are anterodorsal. It is in this position that free-swimming forms glide over the substratum of organic debris in which they find their food.

The cuticle may be locally or generally hardened, in the latter case being termed a lorica. Often the head is retractile, and a constriction of flexible cuticle distal to it is termed a neck: in Philodinaceae there are a series of thin flexible rings which permit both distal and proximal ends to be telescoped into the middle; and in *Taphrocampa*, regular constrictions of the whole bodywall give an appearance of metemeric segmentation to the body. In Philodinaceae accessory toes are found, unfurnished with cement-glands and distinguished as spurs.

Corona or Disk.—This typically consists of two concentric zones, the trochus and cingulum, often separated by a groove or gutter which may be finely ciliated; but in several genera of no close affinity, where it is very oblique to the longitudinal axis of the body, it is represented by a general ciliation of the surface (*Taphrocampa*, *Rattulus*, *Copeus*, *Adineta*). We may suppose that primitively the mouth was seated in the centre of a funnel-shaped disk, surrounded by a double wreath. The nearest approach to this is found in *Microadon* (fig. 2, 1) and its allies, the trochus being oval with two median gaps, the cingulum, more delicate, and complete. In Flouculariaceae the trochus is a horseshoe-shaped ridge

deep down in the funnel-shaped disk. The cingulum appears to be represented by the margin, usually produced into long petal-like

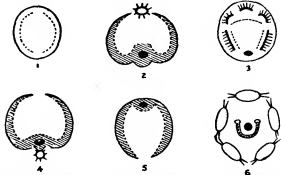

From Camb. Nat. Hist. vol. ii. "Worms," &c., by permission of Macmillan & Co. Ltd.
FIG. 2.—Diagrammatic Views of Disks of Rotifers: cingulum continuous; trochus dotted; groove shaded; mouth black. 1, Simple disk of *Microcodon*; 2, belloloid disk of *Rotifer* and of most Melicertids showing dorsal gap; 3, disk of *Hydatina*, with lobed ridges in the groove, bearing vibratile styles (membranellae); 4, disk of *Melicerta ringens* and *M. confjera*; the star represents the ciliated cup connected by ciliated depressions with the groove; 5, disk of *Conochilus*, like the Belloloid, but with mouth antero-dorsal, the gap postero-ventral; 6, disk of *Stephanoceros*—cingulum broken up into setiferous lobes, groove a naked funnel, trochus a horseshoe-shaped ridge, mouth central.

lobes, fringed with long stiffish setae, which in *Stephanoceros* are vibratile at intervals, seemingly at will. In *Floscularia* they serve to convert the lobed funnel into an efficient casting net or clasp net: in one species (*F. pelagica*) there is an outer girdle of fine cilia for swimming. In *Apusilus* and *Atrochus* (fig. 3, b, d) the cingulum is a mere contractile hood. In most rotifers, on the contrary, the trochus is stronger than the cingulum, often lobed, and with some of its cilia aggregated into vibratile styles homologous with the complates of *Ctenophora* (q.v.) and the membranellae of ciliate Infusoria (q.v.). The trochus forms the powerful currents for locomotion, and for the supply of food material, while the cingulum produces a local current round the upper rim of the corona to bring the food particles direct to the mouth, which is displaced through a postero-ventral gap in the trochus to lie behind the disk, just as occurs in the more specialized Ciliata.

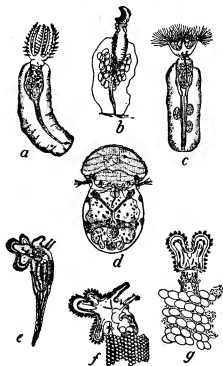

From H. S. Jennings in *American Naturalist*, vol. xxxv., by permission of Ginn & Co.

FIG. 3.—a, *Stephanoceros eichornii* in gelatinous tube; b, *Acylus inquetus* in gelatinous tube, with eggs; c, *Floscularia coronella* in gelatinous tube, with eggs; d, *Apusilus bucinexad*, showing lateral (distal) antennae funnel of mouth hanging into enormous crop, stomach at apical end with gastric glands, anus on postero-ventral surface, large coiled kidneys at proximal end, uniting into fine duct; e, *Melicerta ringens* in tube; f, same, proximal end enlarged, showing a pellet in the cup proximal to the paired lateral antennae; g, *Melicerta jansu*, as it formed of faecal pellets.

rotifer is, as it were, constantly drawn forward into the centre of this vortex ring. There is a dorsal interruption to the disk, in-

volving both trochus and cingulum and groove: in this case the two halves of the disk may be developed in lobes, flower-shaped in *Melicerta ringens*, but often rounded and projecting like kettledrums. These give a strong impression of two crown wheels revolving in the same sense. This appearance puzzled the older observers, who were led thereby to give the name "wheel-bearers" to the group until the true character of ciliary motion was recognized; for a wheel cannot be in organic continuity with the support on which it rotates. In *Conochilus* (fig. 2, 5), a Melicertan, the mouth is displaced towards the antero-dorsal side and the gap is postero-ventral.

In *Melicerta ringens* and *M. confjera* (fig. 2, 4; fig. 3, e, f) there is a glandular ciliated pit between the mouth and the chin into which the overflow water passes by a pair of gutters, and in which fine particles are aggregated into pellets, which the animal deposits as formed on the edge of its tube and so builds it up. *M. jansu* builds up a tube by pellets of its own faeces (fig. 3, g). In most *Plomia* the dorsal gap is not well marked, and the trochus is broken up into a number of lobes, often furnished with vibratile styles, in front and at the sides, but ventrally passing into the uniformly ciliated oral funnel.

Other ciliated organs to be noticed are the proboscis cup of Belloloidae and the toes of *Pedalion*. Besides these Synchaetidae and Notommatidae (fig. 7) possess a pair of avioles, great eversible ciliated pouches a little above the disk, utilized in swimming. The mouth begins as a funnel, continues into a narrow pharynx, which in *Flosculariaceae* is prolonged into a slender tube hanging freely down into the crop: this is followed by the crop-gizzard, also ciliated except behind, where it is hardened into a set of articulated sclerites (trophi) to form the gizzard or mastax. Thus the crop-gizzard has the same combination of structures as we find in the stomach of higher Crustacea, with which we may call it homologous. The trophi are (1) a median incus or anvil (fig. 4), Y-shaped, with the foot (fulcrum) distal and the arms (rami) apical, often independently jointed; (2) with the outer ends of the rami articulate two lateral pieces (mallei), and again composed of a distal longitudinal piece (manubrium) and an apical transverse piece (the uncus), the whole recalling, as the name implies, a single-clawed hammer. For the varieties and modifications of the trophi we simply refer to Hudson's figure above. The relative size of the crop to the trophi varies greatly; it is small where the trophi are well developed and complex, as well as in Belloloidae; but in *Flosculariaceae* it is large, and so it is in *Asplanchnaceae*. Eversible trophi of the forcipate or virgate type, which can be used for nibbling, are common in *Plomia*, notably *Rattulidae*, and are used for attachment to the host in the parasitic *Seisonaceae*, &c. In *Asplanchnaceae* also,

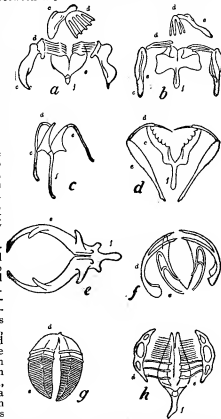

From C. T. Hudson in *Our Journal of Microscopical Science*, vol. xxiv., by permission of J. & A. Churchill.

FIG. 4.—Types of Trophi. a, malleate, with enlarged view of malleus above—the Y-shaped incus consists of a short median fulcrum bearing two large rami, each of which is in contact with a stout malleus consisting of a toothed uncus carried on a long manubrium; b, sub-malleate, with enlarged view of malleus—the manubria are twice as long as the 2- to 5-toothed uncus; c, virgate—mallei rod-like, manubria and fulcrum very long, uncus 1- or 2-toothed; d, forcipate—rami large and used as forceps, mallei rod-like, uncus pointed or evanescent; e, incudate—stout fulcrum, rami forming a forceps, mallei evanescent; f, uncinata—uncus large, 2-toothed, manubria evanescent, incus slender; g, ramate—rami subquadrant, fulcrum rudimentary, manubria evanescent; h, malleo-ramate—mallei fastened by their uncus to the rami, manubria looped, rami large and fulcrum slender.

where the whole crop is strengthened by a framework of bars, the incudate mastax lies in a little postero-ventral pouch which can be everted through the crop and mouth. The stomach is generally large; its wall consists of a layer of very large ciliated cells, which often contain fat globules and yellowish-green or brown particles, and outside these a connective tissue membrane; muscular fibrillae have also been described. Very constantly a pair of simple sack-like glands open into the stomach, and probably represent the hepato-pancreatic glands of other Invertebrates.

Following upon the stomach there is a longer or shorter intestine, which ends in the cloaca. The intestine is lined by ciliated cells. In forms living in a tube the intestine turns round and runs forward, the cloaca being placed so as to debouch over the margin of the tube. The cloaca is often very large; the nephridia and oviducts may open into it, and the eggs lodge there on their way outwards; they are thrown out, as are the faecal masses, by an eversion of the cloaca. *Asplanchna*, *Notommata selboldii*, and certain species of *Ascomorpha* are devoid of intestine or anus, excrementitious matters being ejected through the mouth. The body cavity (archicoele) contains a fluid in which very minute corpuscles have been detected. There is no trace of a true vascular system. The nephridia (fig. 1, B, n) present a very interesting stage of development. They consist of a pair of tubules with an intracellular lumen running up the sides of the body, at times merely sinuous, at others considerably convoluted. From these are given off at irregular intervals short lateral branches, each of which terminates in a flame-cell (f) precisely similar in structure to the flame-cells found in Planarians, Trematodes and Cestodes; here as there the question whether they are open to the body cavity or not must probably be answered in the negative. At the base these tubes open either into a permanent bladder (fig. 1, b) which communicates with the cloaca, or directly into the cloaca. They have the same functions as the contractile vacuole of freshwater Protozoa (g.p.).

Nervous System.—There is a large ganglion lying in close contact with the pharynx, proximal to the crop and on its antero-dorsal side; in Bdelloidacea at least it is united by short connectives with a smaller postero-ventral ganglion to form a nerve collar. From this simple nerve fibres are given off to the body-wall, especially

The sense organs are eyes, antennae, sensory styles and a statocyst in a few species. The eyes are refractive globules set in a cup of red pigment traversed by a nerve fibre, and lie on the proximal side of the body, directly on the postero-dorsal surface of the brain, or at a little distance from it, on the neck, often within the circle on the corona, and usually well within the transparent body. There may be one, a pair, or rarely more, the outer ones being more or less rudimentary. The antennae are short tubular extensions of the body wall, sometimes retractile with a depressed tip from which protrudes a tuft of fine stiff bristles. They are possibly organs of external taste (smell) as well as of touch. Typically there are two pairs—a proximal, more or less approximated on the postero-dorsal surface, and a distal pair, more widely separate. But the proximal pair are often fused into a single median antenna (supplied, however, by two nerves), and in one case at least the distal pair may be similarly fused. Additional paired antennae may occur within the coronal surface, which is the seat of the sensory styles, of less complex structure, which occur in many genera. The statocyst (retro-cerebral organ of *P. Marius de Beauchamp*) is a sac filled with highly refractive granules soluble in dilute acids, and opening by a slender duct (or a pair) to the surface; its function is doubtless that of an organ of equilibrium, and it resembles in its opening to the surface the primitive internal ear of even Vertebrates, for the duct to the surface persists through life in the sharks.

Locomotor Organs.—Most free rotifers swim by the corona, aided by the ciliated auricles when present. In Bdelloidacea this may alternate with a leech-like gait; the corona being withdrawn, the cupped end of the proboscis serves as a sucker for attachment alternately with the adherent foot, so that the animal loops its way along. In two families motile articulated rods occur; in Triarthridae they probably simply expand the dimensions of the body in adaptation to life at the surface; or as a protection against being swallowed by their smaller foes. In *Polyarthra* and *Pteroesa* they are numerous, pinnated (feathered), and are doubtless used for active swimming by jerks; they can be moved up or down by special muscles attached to their bases, which project into the body.

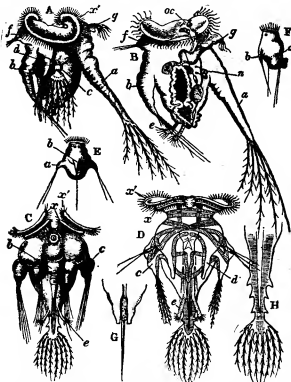

FIG. 5.—*Pedalion mira*. A, lateral surface view of an adult female: a, median ventral appendage; b, median dorsal appendage; c, distal ventro-lateral appendage; d, dorso-lateral appendage; f, dorsal antenna; g, "chin"; x', cephalotroch. B, lateral view, showing viscera: oc, eye-spots; n, nephridia; e, ciliated toes; other letters as above. C, ventral view: x', trochus; x, cingulum; other letters as above. D, ventral view, showing the musculature (cf. text). E, dorsal view of a male: a, lateral appendages; b, dorsal appendage. F, lateral view of a male. G, enlarged view of the antenna f. H, enlarged view of the median ventral appendage. (All after Hudson.)

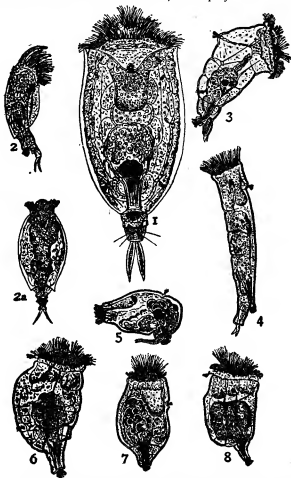

FIG. 6.—Male Rotifers. 1, *Euchlanis deflexa*; 2, lateral; 2a, dorsal views of *Colurus bicuspidatus*; 3, *Nolops brachionus*; 4, *Diglena permollis*; 5, *Gastropus minor*; 6, *Anuraea serrata*; 7, *Ascomorpha parasitia*; 8, *Notholca heptodon*. (Drawn from specimens by F. R. Dixon Nuttall.)

to the ciliated cells of the corona, to the foot, and also to the muscles and sense organs.

In *Pedalion* (fig. 5), a remarkable form discovered by Dr C. J. Hudson in 1871 and found in numbers several times since, these

appendages have acquired a new and quite special development. They are six in number, median, ventral and dorsal, and two unequal lateral pairs. The largest is placed ventrally at some distance distal to the mouth. Its free extremity is a plumose fan-like expansion (fig. 5, Aa and H). It is, in common with others, a hollow process into which run two pairs of broad, coarsely transversely striated muscles. Each pair has a single insertion on the inner wall—the one pair near the free extremity of the limb, the other near its attachment; the bands run up, one of each pair, on each side, and run right round the body forming an incomplete muscular girdle, the ends approximating in the median line. Above this point springs the large median dorsal limb, which terminates in groups of long setae. It presents a single pair of muscles attached along its inner wall which run up and form a muscular girdle round the body in its posterior third. On either side is attached a dorso-lateral and ventro-lateral appendage, each with a fan-like plumose termination consisting of compound hairs or setae, found elsewhere only among arthropods (q.v.); each of these is moved by muscles running upwards towards the neck and arising immediately under the trochal disk, the inferior ventro-lateral pair also presenting muscles which form a girdle in the hind region of the body. It bears a group of long setose hairs the bases of which are connected with the nerve fibre. There are also two pairs of distal antennae. *Pedation* presents a pair of ciliated toes in the posterior region of the body (fig. 5, B, C, and D, e), which it can apparently use as a means of attachment; Dr Hudson states that he has seen it anchored by these and swimming round and round in a circle.

Reproduction Organs.—Rotifera are unisexual, with the sexes dimorphic. The ovary is, as in many Platyhelminthes, duplex; one

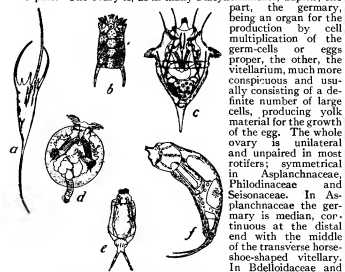

From H. S. Jennings in *American Naturalist*, vol. xxv., by permission of Ginn & Co.

part, the germery, being an organ for the multiplication of the germ-cells or eggs proper, the other, the vitellarium, much more conspicuous and usually consisting of a definite number of large cells, producing yolk material for the growth of the egg. The whole ovary is unisexual and unpaired in most rotifers; symmetrical in Asplanchnaceae, Philodinaceae and Seisonaceae. In Asplanchnaceae the germery is median, continuous at the distal end with the middle of the transverse horse-shoe-shaped vitellary. In Belloidoaceae and Seisonaceae the whole organ is paired, the germery proximal, the vitellary next the cloaca. As a rule, the wall of the ovary is continued into a uterine tube opening into the cloaca, but in Philodinaceae this is absent, and the young are free in the body cavity and escape by perforating the cloacal walls. The male organs are usually a testis, a large seminal bladder and a protrusible penis. The males are unlike the females in most species; only in *Esophora digitata*, *Rhinops vitrea*, *Proales werneckii*, and the Seisonaceae a complete digestive system is present. Frequently the foot is ciliated at the tip, as in the young of the above forms.

The males of rotifers are of relatively rare occurrence, except in the genus *Asplanchna*, where they were first recognized as such by Brightwell in 1841; though those of *Hydatina* had long since been seen and described as a distinct genus. Despite their rare occurrence, the males of over one hundred and twenty species have now been recognized, and we may well believe that all species will be found to present males. This statement may seem to need qualification; for the male of no Belloido has been seen, and there is but a doubtful record of "winter-eggs" in this group. But possibly, as in Seisonaceae, the males resemble the females, and have escaped recognition. It may, however, well be that the capacity for the dry state has physiologically replaced the need for resistant fertilized eggs. Insemination takes place either by the introduction of the penis into the cloaca of the female, or by the puncture of the body-wall of the female by the penis, and the injection of the sperm into

the body cavity, whence the single spermatozoa must make their way to the eggs. The females habitually produce eggs without impregnation, which again habitually develop into females, more rarely into males. These unfertilized eggs develop directly, often in the uterus. In other cases the eggs are liberated earlier and adhere to the foot, or are hatched within the tube (fig. 3, b, c). The impregnated eggs undergo a very partial development in the mother, and these pass into a state of rest, for which they are furnished with a dense shell. They always give rise to parthenogenetic females (see REPRODUCTION). The shell-walled eggs are often termed "summer-eggs," the fertilized ones "winter" or "ephippial" eggs (by parity with the phylophal Entomostraca, q.v.). But the appearance of males seems to be as much associated with those of summer drought as of winter cold. No adequate knowledge of the conditions under which males arise has been established. The phenomenon of seasonal dimorphism is of especial moment for the plankton dwellers. Not only is the appearance of males regular, but the forms of the females at different times of the year may be so distinct as to have led them to be classed as distinct species.

Development.—The egg is holoblastic, but the segmentation is very unequal, recalling that of marine annelids and of molluscs. Gastrulation takes place by epiboly, and the stomodaeum (oral invagination—stomodaeum pharynx) takes place in two stages of the region of the closed blastopore. Unlike the molluscs and annelids, however, the cloacal invagination lies outside this region, and the foot is formed by an elongation of the end of the body between the two apertures. The nerve ganglion is formed by an ingrowth of epiblast, and so are the pedal glands. The body cavity is the primitive blastocoel.

Relationships and Morphology.—Passing over the earlier authors who regarded this group as allied to Infusaria, a view first combated by Dujardin, T. H. Huxley viewed them as equivalent to and on a level with the larvae of Echinoderms, and of such other trochophore larvae as resembled these, a view generally adopted. But it became more and more apparent that the larvae of this category developed mouth, gut and anus by the closure in the middle of such a slit-like blastopore opening into a sack-like stomach as is seen in the larvae of Turbellaria and Nematostoma. The extra-blastopore opening of the cloaca leads to a very different view, which finds negative support in the failure of previous morphologists to adapt the details of development and of the structure of the disk to their identification of "trochus" and "cingulum" with the preoral and postoral wreaths of the trochophore larva. We homologize the rotifer with the Turbellaria (fig. 8, A), and with the preoral or upper part of the trochophore (fig. E, F). Its adhesive foot is paralleled by a cup-shaped ciliated depression, possibly nervous, found in all the larva cited, except some Echinoderms, and which in Asterids and Crinoids actually serves as an organ of attachment. This view obviates the deed for assuming the complicated flexures of the wreath which has to be done on other assumptions (see ROTIFERA, *Encycl. Brit. ed.* 9). Thus *Trochosphera* (fig. 8, D) (which has a male of the same type as *Meliceria*, &c.) is an extremely modified type, and its resemblance to the trochophore larva of *Lepadobryonia* *Polygordius* is only superficial. We may note that it was long shown that the apical organ (at first assumed to be the brain) of these larvae was innervated from an anterior thickening of the circular nerve ring, corresponding with the brain of Rotifers; the nerve cells immediately below the dit are the ordinary bipolar

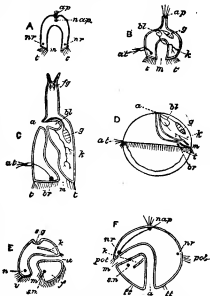

From *Cambridge Natural History*, vol. II., "Worms, &c.," by permission of Macmillan & Co. Ltd.

FIG. 8.—Diagram of morphological relations of Rotifera. A, piliidium larva of nemertine; B, *Asplanchna pusilla* schematized; C, a plomal rotifer; D, trochosphera larva (schematized from Semper); E, veliger larva of mollusc; F, trochophore larva of annelid. a, anus; ap, apical organ, corresponding to foot of rotifers; at, median antenna, united by a nerve to br, brain (letter omitted in B); bl, bladder, receiving ramified kidney in B, C, D; f, foot, and f.g., its cement-gland; g, ovary; k, kidney; m, mouth; n, supra-oesophageal ganglion; nr, nerve ring in section.

ganglion cells below invertebrate sense-organs. Moreover, the body cavity of the Rotifers is a primitive archicoele; the persistent or accrescent cleft between epiblast and hypoblast, traversed by mesenchymal muscular bands. Thus we regard Rotifers as an independent stem branching off at the outset of the rise from the Platode type to higher Invertebrata. The Polyzoa (*q.v.*), which in many ways recall Rotifers, appear to be equally independent.

The following classification of Rotifers is our modification of that of Hudson and Gosse, further altered through considerations put



From H. S. Jennings in *American Naturalist*, vol. xxxv., by permission of Ginn & Co.
 FIG. 9.—a, *Microcodon clavus*, showing corona, lateral antennae and jointed foot; b, *Rhinops vitrea*, corona from below, showing proboviscidiform extension containing eyes; c, *Philodina megalotrocha*; d, head of *Rotifer macroceros*, postero-ventral view, showing lobes of corona, and antero-dorsal median antenna, telescopic with setae; e, *Rotifer (Actinurus) neptunius*, showing head with retracted corona and protruded dorsal proboviscid bearing median antenna, and telescopic foot with toes and spurs; f, *Asplanchnopus myrmelae*, showing horseshoe-shaped ferriarium (left), blind saccate stomach (right), apical bladder, foot, etc.; g, *Asplanchna ebesbornii*—the coiled tube at left is a kidney; h, i, incudate jaws of *Asplanchna brightwellii* and *girodii* chiefly formed of rami, with the rudimentary mallei parallel and external to them; j, *Ascomorpha hyalina*.

forward by C. Wesenberg-Lund, which, however, we do not consider wholly convincing. He notably regards an oblique disk with uniform ciliation as primitive, a view which we cannot adopt.

Classification:—

(A) Disk usually with well-marked strong trochus, ciliated groove and more delicate cingula interrupted by an antero-dorsal median gap, usually more or less bilobed.

(i.) Trophi incudate:

1. Asplanchnaceae; trochus circular; foot absent or minute; trophi incudate; stomach blind; males frequent, not very dissimilar to females. *Asplanchna* Gosse (fig. 9, g-*i*); *Asplanchnopus* Deguerne (fig. 9, f); *Ascomorpha* Perty (fig. 9, j).

(ii.) Trophi malleolaral:

2. Melicertaceae; females tubicolous, usually attached, or forming spherical floating social aggregates; males free swimming. *Melicerta* Schrank (fig. 3, e, f); *Oecistes* Ehrenberg; *Lacunarula* Schweigger; *Conochilus* Ehrenberg, with gap postero-ventral and mouth antero-dorsal (fig. 2, 5).
3. Trochosphaeraceae; female footless; subspherical, the corona bulging into a hemisphere which may equal the hemispherical body; anus apical; male as in Melicertaceae, *Trochosphaera* Semper (fig. 8, D).

4. Ploimodaceae; subconical; corona bilobed; retractile foot absent or ciliated; notile appendages present in two families.
 - (a) Pterodinidae; foot a ciliated cup; cuticle forming flat lorica. *Pterodina* Ehr. (fig. 7, d).
 - (b) Triarthridae; body with a pair of long cervical spines pointing distally and serving for leaping movements or to extend the body and make it too big for small enemies to swallow; *Pedetes* Gosse (no median spines); *Triarthra* Ehr., one postero-ventral spine; *Tetramastix* Zacharias, two unequal median spines.
 - (c) Pedalionidae, foot represented by two styles, sometimes ciliated; body provided with six hollow-jointed muscular fins for swimming and leaping. *Pedalion* Hudson (fig. 5).

(iii.) Trophi ramate:

5. Bdeloidaceae; foot with two toes and accessory spurs or a simple perforated disk; body telescopic at either end with an antero-dorsal proboviscid ending in a ciliate cup and bearing the proximal antenna; corona usually bilobed, very wheel-like. Males if present probably like the females. Germany and ovary paired; oviduct absent; young viviparous. *Rotifer* Schrank (fig. 9, d, e); *Philodina* Ehr. (fig. 9, c); *Callidina* Ehr. (eyeless); *Adineta* Hudson is eyeless with the corona uniformly ciliated, and proboviscid adnate, hooked.

(iv.) Trophi uncinatae:

Flosculariaceae; disk a contractile cup, often lobed, the cingulum of long vibratile cilia, of very long motionless bristles or absent, rarely with an outer zone of fine cilia. Trochus a pair of ridges or horseshoe open in front. Oral funnel produced into a fine tube hanging freely into a pharyngeal cup, containing the uncinatae trophi. Body-wall usually traversed by a network of canals serving by their contraction to expand the disk. Males and larvae with a ciliated pedal cup and a simple ciliated disk.

- (a) Flosculariidae; tubicolous, with a lobed disk, bearing stiff or vibratile setae. *Floscularia* Oken (fig. 3, b); *Stephanoceros* Ehr. (fig. 3, a).
- (b) Acyclidae. Disk entire or tentaculate, not setiferous; *Acyclus* Leidz (fig. 3, c). Foot represented by a button-like disk, carried far from the posterior surface; *Apsilus* Metchnikoff (fig. 3, d); *Astrochus* Wierzecki (fig. 3, c).

(B) Ploimaeae; disk variable, often circular, sometimes with a lobed trochus bearing membranellae (vibratile styles); trophi complete, malleate, submalleate, virgate, or torcipate; anus subapical; foot usually short, and usually bearing two toes which may be much elongated.

Illiciorata, cuticle soft; ciliated exsertile auricles above the disk sometimes present. *Albertia* Dujardin; *Drilophagus* Vejvodsky; *Microcodon* Ehr. (fig. 9, a); *Rhinops* Hudson (fig. 9, b); *Synchaeta* Ehr. (fig. 7, c); *Hydatina* Ehr. has no eye; *Notommata* Ehr. (restricted by Gosse); *Copene* Gosse; *Nolops* Hudson (fig. 6, 3); *Proales* Gosse; *Gastroschia*; *Diplona* Ehr. (fig. 6, 4).

Loricata, cuticle hardened armour-like, often sculptured; *Polyarthra* Ehr.; *Pedetes* Gosse; *Euclanlis* Ehr. (fig. 6, 1); *Anuraea* Ehr. (fig. 7, b); *Notholca* Gosse (fig. 7, a); *Distylis* Eckstein (fig. 7, e); *Rattulus* Ehr. (fig. 7, f); *Colurus* Ehr. (fig. 6, 2); *Taphrocampa* Gosse.

(C) Seisonaceae. Body elongated with a narrow neck above the disk; foot ending in a terminal perforated disk. Trophi virgate exsertile; Germany paired; genito-urinary cloaca opening above the neck in the male, subapically in the female. Gut blind (*Paraseison*), or opening into the cloaca (*Seison*). Males resembling females, common. All known species are parasitic on the Crustacean *Neobia*; *Seison* Claus; *Paraseison* Plate.

Habitat and Habits.—The Rotifera are all aquatic, the majority dwelling in fresh water with Protozoa and Protophyta, as well as Entomostracous Crustacea. This association with Protophyta accounts for their study by many distinguished botanists, such as W. C. Williamson and F. Cohn. Some are moss-dwellers, inhabiting the surface film of water that bathes these plants; such especially are the Bdelioids, with their exceptional capacity for resisting desiccation. Others—the majority—live among weeds, the tubicolous ones mostly upon them. A few are sapropehic, haunting the looser debris that forms the uppermost layer of the bottom ooze of quiet waters; we may cite the aberrant Floscularian *Astrochus*. Widely different are the habits of the plankton forms, which float or swim near the surface, and are often provided with long

cuticular extensions for this purpose (fig. 7, a, b). Asplanchnaceae, plankton, dwellers in small pools, are, however, ovoid, and *Trochosphaera* is spherical and must owe its floating powers to the low density of the liquid in its enormously dilated body-cavity. *Lacinularia racemovata* and *Conochilus* form free floating aggregates, the eggs, as laid, hatching and the young settling among the approximated gelatinous tubes of the parents. Some species only frequent the clearest waters; but the lovely transparent *Hydatina senta* (fig. 2, 3) likes water contaminated by the visits of cattle or the drainings of manure. *Drilophagus* and *Alberitia* are parasitic on the surface or within the gut of Naid Oligochaete worms: *Seisonacea* are ectoparasitic on the Crustacean *Nebalia*, *Proales werneckii* forms galls within the *Conifera Vaucheria*, and *P. parasita* infests the central jelly of the Phytoflagellate *Volvox*; *P. petyromysus* is a frequent commensal in the gill cavity of some Cladoceran Crustacean *Eurycerus lamellatus*.

The geographical distribution is cosmopolitan, as is the case with Protozoa and Protophyta of similar habits. A curious fact is that when a new and striking form is found first in one place it is shortly after collected from widely separated areas. In the case of one genus, *Gastroscitia*, this led to the creation of no less than six generic names.

History and Bibliography.—As rotifers are common in ponds, the first workers with the microscope observed them repeatedly, the first record being that of John Harris in 1696, who found a Bdelloid in a gallipot that had been standing in his window. Loeuvenhoek found and described some tubicolous species; and during the 18th century a fair number of species were observed, figured and described with names. During this time the illusion of a wheel or wheels produced by the ciliary action of the disk had puzzled all observers. C. E. Ehrenberg included the Rotifers in his *Infusionsthierie*, and described and figured with fair precision many of the genera and species. Dujardin gave a less detailed but more accurate account under the name of *Zoophytes Systoides*. The next full work was a valuable compilation by W. C. Williamson (best known as a botanist) in Pritchard's *Infusoria*, in 1861. Much work was done with the gradual introduction of improved methods during the last forty years of the century. The discovery and recognition of the males was made, however, at the close of the fifties. P. H. Gosse collected and described many species, and elucidated the structure of the mastax in 1856. Zoologists of the standing of Huxley, Claus and Leydig added to our knowledge of the anatomy and to the theory of their relations. But the monumental monograph of C. T. Hudson and Gosse containing a new classification, an illustrated description of all the then known species and much information on habits and structure, proved students with an easy access to the domain and stimulated many to work hard at the group. Of these new-comers we may cite C. F. Rousselet, who has found many new species and many unknown males of known species, elucidated habits and faithfully kept record of the publications on the class in the *Journal of the Royal Microscopical Society*. He has moreover elaborated a method for preserving Rotifera for microscopic observation, so that the types of each observer are now as readily available for comparison as the plant-specimens of the botanist's herbarium. C. Zelinka has, in the most detailed and anatomical accounts we possess for several Bdelloidaceae, and was the first to utilize modern methods of microscopic technique on a complete scale.

C. G. Ehrenberg, *Die Infusionsthierie als vollkommenere Organismen* (1838); F. Dujardin, *Histoire naturelle des zoophytes* (1841); T. H. Huxley, "Lacinularia socialis," *Trans. Micr. Soc.* i. (1853); P. H. Gosse, "Manducatory Organs in Class Rotifera," *Phil. Trans.* (1856); W. C. Williamson, "The Rotifera" in A. Pritchard's *History of the Infusoria* (1861); C. T. Hudson and P. H. Gosse, *The Rotifera* (1886), and supplement (1889); Marcus Hartog, "Rotifera," in *Cambridge Natural History*, vol. II., reprinted 1901; H. S. Jennings, *Synopsis of North American Invertebrates*, xviii., "The Rotifera," *Amer. Nat.* xxxv. (1901); C. F. Rousselet, numerous papers in *Journ. Micr. Soc.* and *Journ. Quekett Club*; C. Wesenberger-Lund, "Danmarks Rotifera," in *Vid. Meddel. Nat. For. Kjöbenhavn* (1899); C. Zelinka, "Studien über Rotiferen," in *Zeit. Wiss. Zool.* xlv. (1886), xlvii. (1888), liii. (1891). (M. H.)

ROTORUA, a town of Rotorua county, North Island, New Zealand. It lies in the midst of a remarkable volcanic district generally known as the Hot Spring district, or fancifully as the Wonderland, which covers an area of 660 sq. m. and extends 160 m. from N.E. to S.W. from White Island, an active volcanic cone in the Bay of Plenty to the mountains of Tongariro, Ngaruho and Ruapehu in the interior of the island, S.W. of lake Taupo. Rotorua attracts many visitors on account of the beauty and scientific interest of the locality and the bathing

in its various medicinal springs. It is a scattered township lying on the south-western shore of lake Rotorua, amid hills reaching 2600 ft. in the immediate neighbourhood, and much of the volcanic soil supports a rich growth of forest or "bush."

The springs are principally alkaline, alkaline and siliceous, acidic, or acidic and hepatic (sulphurous). The township includes the Maori village of Ohinemutu, an interesting collection of native dwellings, whose inmates constantly use the numerous rudely excavated baths which are fed by springs varying in temperature from 60° F. to the boiling-point, and are in some cases used for cooking. In the vicinity, on the lake-shore, is the government sanatorium. Two miles south of Rotorua is another native village, Whakarewarewa, where there are geysers as well as hot springs. Four miles from Rotorua, near the centre of the lake, the island of Mokoia rises to 1518 ft. It is partly under grass and partly wooded, and is inhabited by Maoris, by whom it is regarded as holy ground. A short channel connects lake Rotorua with lake Rototoi to the N.E. At the eastern end steep cliffs rise from the water, and luxuriant vegetation covers the hills. Both this lake and the smaller ones to the east, Rototoi and Rotoma, have deeply indented shores, and are set in exquisite scenery. The group is known collectively as the Cold Lakes. The waters of Rotoma are of a particularly vivid blue. To the south of Rototoi is Tikitere, a sombre valley abounding in mud volcanoes, springs and other active volcanic phenomena. Mount Tarawera (16 m. S.E. of Rotorua) is noted for the eruption of June 1886, which changed the outline of several lakes, destroyed the famous Pink and White terraces on the adjoining lake Tarawera, and converted a region of great beauty into a desolate wilderness. A fissure was formed extending nearly 9 m. along the axis of the disturbance, and the mission station of Waitara (8 m. from Rotorua) on the western shore of the lake was overwhelmed. A line of craters is seen to the south-west. The large lakes Okataina, Kahahi and Rerewhakaitu lie respectively N., W. and S.E. of lake Tarawera.

ROTROU, JEAN DE (1609-1650), French tragic poet, was born on the 10th or 20th of August 1609, at Dreux in Normandy. Rotrou studied at Dreux and at Paris, and, though three years younger than Corneille, began play-writing before him. In 1632 he became playwright to the actors of the Hôtel de Bourgogne. With few exceptions, the only events recorded of his life are the successive appearances of his plays and his enrolment in 1635 in the band of five poets who had the duty of turning Richelieu's dramatic ideas into shape. Rotrou's own first piece, *L'Hypocondriaque* (pr. 1631), dedicated to the Comte de Soissons, seigneur of Dreux, appeared when he was only eighteen. In the same year he published a collection of *Œuvres potiques*, including elegies, epistles and religious verse. His second piece, *La Bague de Foubli* (pr. 1635), an adaptation in part from the *Sortija del Olvido* of Lope de Vega, was much more characteristic. It is the first of several plays in which Rotrou endeavoured to naturalize in France the romantic comedy which had flourished in Spain and England instead of the classical tragedy of Seneca and the classical comedy of Terence. Corneille had leanings in the same direction. Rotrou's brilliant but hasty and unequal work showed throughout marks of a stronger adhesion to the Spanish model. In 1634, when he printed *Cleogène et Doristée* (acted 1630), he said he was already the author of thirty pieces; but this applies no doubt to adaptations. *Diane* (acted 1630; pr. 1633), *Les Occasions perdues* (acted 1631; pr. 1635), which won for him the favour of Richelieu, and *L'Heureuse Constance* (acted 1631; pr. 1635), which was praised by Anne of Austria, succeeded each other rapidly, and were all in the Spanish manner. In 1631 Rotrou imitated Plautus in *Les Menchmes* (pr. 1630), and in 1634 Seneca in his *Hercule mourant* (pr. 1636). Comedies and tragi-comedies followed. Documents exist showing the sale of four pieces to Antoine de Sommarille for 750 livres tournois in 1636, and in the next year he sold ten to the same bookseller. He spent much time at Le Mans with his patron, M. de Belin, who was one of the opponents of Corneille in the quarrel of the Cid. It has been generally assumed, partly because of a forged letter long accepted as Corneille's, that Rotrou was his generous defender in this matter. He appears to have been no more than neutral, but is credited with an attempt at reconciliation between the parties in a pamphlet printed in 1637, *L'Incognu et véritable amy de messieurs de Scudéry et Corneille*. M. de Belin died in 1637,

and in 1639 Rotrou bought the post of *lieutenant particulier au bailliage* at Dreux. In the next year he married Marguerite Camus, and settled down as a model magistrate and *père de famille*. Among his pieces written before his marriage were a translation of the *Amphitryon* of Plautus, under the title of *Les Deux Sosies* (1636), *Antigone* (1638), and *Laure Persecuée* (acted 1637; pr. 1639), in the opposite style to these classical pieces. In 1646 Rotrou produced the first of his four masterpieces, *Le Véritable Saint Genest* (acted 1646; pr. 1648), a story of Christian martyrdom containing some amusing by-play, one noble speech and a good deal of dignified action. Rotrou uses with considerable success the device of a play within a play. The actor Genest becomes a real convert while playing the part of a Christian martyr. Incidentally (Act i. Sc. v.) Rotrou pays a noble tribute to the genius of Corneille. *Don Bertrand de Cabrère* (1647) is a tragi-comedy of merit; *Venceslas* (1647; pr. 1648) is considered in France his masterpiece, and has had several modern revivals; *Cosroës* (1649) has an Oriental setting, and is claimed as the only absolutely original piece of Rotrou. These masterpieces follow foreign models, and Rotrou's genius is shown in the skill with which he simplifies the plot and strengthens the situations. *Saint Genest* followed Lope de Vega's *Lo fingido verdadero*; *Venceslas* followed the *No ay ser padre siendo rey* of Francisco de Rojas. In this play Ladislas and his brother both love the princess Cassandra; Ladislas makes his way into her duke and in the darkness kills a man whom he thinks to be the duke of Courland, but who is really his brother Alexandre, the favoured lover. In the early morning he meets the king and is confronted by the duke of Courland. The outline of this incident is in the Spanish play, but there the spectators are aware of the ghastly mistake at the time of the murder. Rotrou shows his dramatic skill by concealing the real facts from the audience until they are revealed to the horror-struck Ladislas himself.

In 1650 the plague broke out at Dreux. Rotrou remained at his post, although urgently desired to save himself by going to Paris; caught the disease, and died in a few hours. He was buried at Dreux on the 28th of June 1650. Rotrou's great fertility (he left thirty-five collected plays besides others lost, strayed or uncollected), and perhaps the uncertainty of dramatic plan shown by his hesitation almost to the last between the classical and the romantic style have injured his work. He has no thoroughly good play, hardly one thoroughly good act. But his situations are often pathetic and noble, and as a tragic poet properly so called he is at his best almost the equal of Corneille and of Racine. His single lines and single phrases have a brilliancy and force not to be found in French drama between Corneille and Hugo.

A complete edition of Rotrou was edited in five volumes by Viollet le Duc in 1822. In 1882 M. de Ronchaud published a handsome edition of six plays—*Saint Genest*, *Venceslas*, *Don Bertrand de Cabrère*, *Antigone*, *Hercule Mourant* and *Cosroës*. *Venceslas* and *Saint Genest* are also to be found in the *Chefs-d'œuvre Tragiques* of the Collection Didot.

Rotrou's brother, Pierre Rotrou de Saudreville, left a memoir of him which is unfortunately lost, but this is cited by the Abbé Brillon (1671-1735) as his authority in a *Notice biographique sur Jean Rotrou*, first printed in 1885 at Chartres under the editorship of L. Merlet. Other good earlier authorities are Nicéron, *Mémoires pour servir à l'histoire des hommes illustres* (1773), vol. xvi. pp. 89-97; and the duke of the Vallière, *Bibl. du théâtre français depuis son origine* (Dreux, 1768), vol. ii. pp. 155-273. Modern works are by J. Jarry, *Essai sur les œuvres dramatiques de Jean Rotrou* (Paris and Lille, 1868); Léonce Person, *Hist. du Venceslas de Rotrou, suivie de notes critiques et biographiques* (1882), in which many legends about Rotrou are discredited; *Hist. du véritable Saint Genest de Rotrou* (1882); *Les Pièces de Pierre Rotrou de Saudreville* (1883); Henri Chardon, *La Vie de Rotrou mieux connue* (1884); and Georg Steffens, *Jean de Rotrou als Nachahmer Lope de Vega's* (Berlin, 1891).

ROTTA, **CHROTTA**, **HROTTA** (Fr. *Cithare*, *rotta*; Ger. *Citharē*, *Rotta*), a medieval stringed instrument derived from the Greek cithara. The rotta possessed, in common with all other forerunners of the violin, the chief structural features of the cithara, i.e. the box sound-chest composed of back

and belly either flat or delicately arched connected by ribs. The rotta represents the first step in the evolution of the cithara, when arms and cross-bar were replaced by a frame joined to the body, the strings being usually restricted to eight or less. Examples of these early rattas abound in miniatures from the 8th to the 12th century or even the 14th, such as Cotton MS. Vespasian A. I. (Brit. Mus.), 700 A.D., and the MS. copy in the Durham Cathedral Library of the Cassiodorus Commentary on the Psalms¹ *manu Bedae*. The most interesting is a real specimen of wood found in an Alamannic tomb of the 4th to the 7th century at Oberflacht² in the Black Forest, and now preserved in the Völker Museum, Berlin.

The next step was the addition of a finger-board and the consequent reduction of the strings to three or four, since each string was now capable of producing several notes. In the Carolingian Bible presented to Charles the Bald³ by Count Vivian of Tours there is a fine example of the rotta at this stage, in which the artist has reproduced the position of the fingers of the left hand stopping the strings, and of the right hand plucking them. The same instrument occurs in a companion Bible, known as the Bible of St Paul because it was preserved in the monastery of that name "without the walls" at Rome. Although these MSS. were executed in the 9th century, they do not represent contemporary scenes, but were inspired by Romano-Christian models, if not actually copied from older MSS. This is the only representation yet found of the finger-board thus applied to the rotta. In the final transition preceding the transformation into the guitar, the rotta appears as a guitar-shaped instrument without neck or head and having a body large enough to allow the hand to pass through left in the hole on each side of the strings. At first this instrument, which developed into the crwth, was twanged with the fingers, but in the 11th century it was played with a bow, the bridge having been slightly raised on feet.

The first (and perhaps also the second) of these transitions was accomplished in the Christian East, where, however, the upper frame of the earliest rotta seems to have been at once discarded in favour of a long neck with frets, for which the tanbur undoubtedly supplied the idea. This evolution is to be traced in the miniatures of a single MS., which supplies examples of all the transitions. The miniatures illustrate the Psalms in the Utrecht Psalter; they were beyond doubt originally designed to accompany a Greek or Syrian cithara. The Utrecht Psalter, executed in the diocese of Reims under Anglo-Saxon influence during the 9th century, is no servile copy, but it owes much of its inspiration and local colour to an unknown Greek or Syrian prototype.

As soon as the neck was added to the guitar-shaped body, the instrument ceased to be a rotta and became a guitar (*g.u.*), or a guitar-fiddle (*g.u.*) if played with the bow. Of the rotta, there were two distinct types, the one derived from the cithara, the rotta proper, and the other derived from the lyre, which survived to the 18th century as the Welsh crwth. Although the various forms of the name came to be applied somewhat indiscriminately in different countries and epochs to both types, yet the structural features of both remained true to their respective archetypes.

The words rotta in England and cythara in Germany seem to have clung more especially to the first of these types, while the forms crwth, crowd, crowth were reserved for the bowed instruments, the earliest of which appeared in the 11th century.⁴

The crwth or crowd, so popular in England during the 14th century, does not seem to have won equal favour in Germany, where at that time the nidel or guitar-fiddle had been popularized by the minnesingers. The crwth derived from the lyre underwent no further development. (K. S.)

ROTTENBURG, a town and episcopal see of Germany, in the kingdom of Württemberg, situated on the left bank of the Neckar, which is here crossed by two bridges connecting the

¹ Both miniatures are reproduced by J. O. Westwood in *Facsimiles* (London, 1868).

² Reproduced in *Jahreshefte d. Würtemb. Altertums Ver. vol. iii.* (Stuttgart, 1846), pl. viii. figs. 10 and 11.

³ See *Facsimile*, by Comte Auguste de Bastard (Paris, 1883).

⁴ The whole case of this much-discussed Psalter, with *résumés* of the principal writings on the subject of facsimiles of the miniatures bearing on the evolution of the cithara, will be found in Kathleen Schlesinger's *Instruments of the Orchestra*, pp. 343-82 and pl. iii., vi. and vii. (London, 1909).

⁵ See Kathleen Schlesinger, *op. cit.*, pp. 334, 338-39 n. and 441-50.

town with the suburb of Ehingen, 7 m. by rail S.W. of Tübingen. Pop. (1905) 7554. It is the seat of a Roman Catholic bishop, and possesses the fine Gothic cathedral of St Martin; several other churches; an old castle now used as a prison; and a building, formerly a Jesuit monastery and now the residence of the bishop. The chief industries are the manufacture of machinery, screws, watches and beer, tanning and the cultivation of fruit and hops. Rottenburg passed into the possession of Austria in 1281 and into that of Württemberg in 1805. Near the town are the remains of the Roman station of *Sumalocenna* or *Salmulocena*.

ROTTERDAM, a city of Holland in the province of South Holland, on both banks of the New Maas, at the confluence of the canalized Rotte, and a junction station $1\frac{1}{2}$ m. by rail S.E. of the Hague. Steam tramways connect it with Schiedam, and with Numansdorp on the south of the island of Beierland, and there is a regular service of steamers by river and canal to Antwerp by way of the South Holland and Zeeland Islands and in every direction. The population of the city was about 20,000 in 1632; 53,212 in 1796; 105,858 in 1860; and 370,017 in 1905. Its shipping facilities have raised Rotterdam to the position of the first commercial city of Holland. By means of the New Waterway (1869-90) to the Hook of Holland it is accessible for the largest ships. The principal quay is the *Boompjes* ("little trees"), forming the river-front on the north side. Although originally situated exclusively on the north or right bank of the Maas, in 1860 Rotterdam was extended to the southern shore by the acquisition of the commune of Feienoord; while in 1886 Delftshaven on the west, and in 1895 Charlois on the south-west and Kralingen on the east, were also incorporated. The river is spanned by a road bridge (1878) and a railway bridge (1877) passing from the *Boompjes* to the North Island, whence they are continued to the farther shore by swing-bridges through which the largest ships can pass to the upper river. These bridges prove useful in breaking up the ice which forms above them in winter. On the south side of the river are numerous large docks and wharves, while the city proper on the north side consists of a labyrinth of basins and canals with tree-bordered quays.

In the centre of the town is the Beursplein, or Exchange Square, with the large general post office (1875), the "Amicitia" club, and the exchange itself (1723). Behind the exchange is the great market-place, built on vaulting over a canal, and containing a bronze statue of Erasmus, who was born in Rotterdam in 1467. The statue is the work of Hendrik de Keyser, and was erected in 1622 (the inscription being added in 1677) to replace an older one. Beyond the market-place is the High Street, which runs along the top of the Maas Dyke. On the west of the city a pretty road planted with trees and grass plots leads from the Zoological Gardens (1857), on the north to the small park overlooking the river. In the park is a statue of the popular poet Hendrik Tollens (d. 1856), a native of the city. Among the churches of Rotterdam are an English church, originally built by the 1st duke of Marlborough, whose arms may be seen with the royal arms over the entrance. The *Groote Kerk*, or *Laurens Kerk* (end of the 15th century), contains a fine brass screen (1715), a celebrated organ with nearly 5000 pipes, and the monuments of Admirals Witte de Witte (d. 1658), Kortenaer (d. 1665), and van Brakel (d. 1690), and other Dutch naval heroes. The lofty tower commands an extensive view. In the New Market adjoining is a fountain adorned with sculptures erected in 1874 to commemorate the jubilee of the restoration of Dutch independence (1813). The museums of the city comprise an ethnographical museum, the maritime museum established by the *Yacht Club* in 1874, and the *Boyma's Museum* (1867) containing pictures, drawings and engravings, as well as the town library. Of the original collection of pictures bequeathed by F. J. O. Boyma in 1847, more than half was destroyed by fire in 1864; but the collection has been enlarged since and is representative of both ancient and modern artists. Close to the museum is a statue of the statesman Gysbert Karel van Hogendorp

(1762-1834), a native of the city. Among the remaining buildings must be mentioned the town hall (17th century; restored 1823), the court-house, the concert-hall of the "Harmonic" club, the record office (1900), the *leeskabinet*, or subscription library and reading-rooms, and the ten-storied *Witte Huis* (1897), which is used for offices and is one of the highest private buildings on the Continent.

The industries comprise the manufacture of tobacco, cigars, margarine, rope, leather, &c., and there are breweries, distilleries and sugar refineries. The gas, electricity (1804) and waterworks (1870) are under municipal control. Shipbuilding yards extend above and below the city, one of the earliest being that of the Netherlands Steamboat Company (1825). It is, however, as a commercial rather than as a manufacturing city that Rotterdam is distinguished, its progress in this respect having been very striking. Between 1850 and 1902 the area of canals and docks in use on both sides of the river increased from 96 to over 300 acres, about £2,000,000 having been spent on the building of docks in the last quarter of the 17th century. Besides its maritime trade Rotterdam has an extensive river traffic, not only with Holland, but also with Belgium and Germany. Its overseas trade is principally with the Dutch colonies, New York, La Plata and the east and west coasts of Africa. The great harbour works on the south side of the river required to accommodate this growing trade were planned by the engineer Stieltjes (d. 1878), who has a monument on the North Island. Besides being easily accessible from the river and connected with the railways, the docks are provided with every facility for coaling and loading or discharging cargoes. The larger passenger steamers of the *Rotterdamsche Lloyd* to Netherlands India and of the Holland-American Steamship Company (the two principal passenger and cargo steamship companies at Rotterdam) have their berths on the south side of the river. In the centre of the river there is accommodation for over thirty vessels at the mooring buoys. The increase in the importance of Rotterdam as a port, apart from the development of the trade of the Netherlands generally, is shown by the fact that whereas in 1846 only 31% of the total trade of the country passed through the port, in 1883 the proportion was 50%; in the same year 43.75% of the total number of vessels engaged in Dutch trade used the port of Rotterdam, whereas in 1850 the proportion was only 35.77%. The average number of all vessels using the port annually during the decade 1897-1906 was 7228 of 11,163,624 tons, but a steady increase was recorded during this period, from 6212 ships of 8,434,032 tons in 1897 to 8570 ships of 14,572,246 tons in 1906.

Rotterdam probably owes its existence to two castles, which existed in feudal times. In 1299 John I., count of Holland, granted to the people of Rotterdam the same rights as were enjoyed by the burghers of Beverwijk, which were identical with those of Haarlem (K. Hegel, *Städte und Gilden*, 1891, Bd. ii.). This privilege marks the origin of the town. In 1489 it was surprised by Francis van Broderode, and in 1572 it was plundered by the Spaniards, who were in possession for four months. It continued to increase in size, various extensions of its boundaries being made, and its trading importance is to a large extent the result of its commercial intercourse with England.

ROTTWEIL, a town of Germany, in the kingdom of Württemberg, lying on a hill on the left bank of the Neckar, 46 m. S.W. of Tübingen by rail. Pop. (1905) 9008. It is partly surrounded by walls, and contains two fine churches, the Gothic *Heilige-Kreuz-kirche*, built in the 14th century and restored in 1840, and the *Capellen-kirche* with a Gothic spire 230 ft. high. It has a mediæval town hall, several schools and a museum of antiquities. Especially noteworthy is the collection of sculptures and pictures of old German art in the chapel of St Lawrence, where there is also a Roman mosaic, found in the vicinity, portraying Orpheus in the centre and, at the sides, Roman chariot-races and gladiators. The industries of the place

embrace the manufacture of powder, locomotives, machinery, cotton, leather and beer. There is also a considerable trade in live stock, agricultural produce and wine.

Rottweil-Alststadt, which lies about 4 m. to the south, was a Roman colony. It has an old church and a Cistercian nunnery founded in 1221 and dissolved in 1838. Near the town is Wilhelmshall, with saline springs. In the 13th century Rottweil became a free imperial city and was subsequently the seat of an imperial court of law, the jurisdiction of which extended over Swabia, the Rhineland and Alsace. The functions of this tribunal came to an end in 1784. In 1803 Rottweil passed into the possession of Württemberg.

See Ruckgaber, *Geschichte der Stadt Rottweil* (3 vols., Rottweil, 1835); and Greiner, *Das ältere Recht der Reichsstadt Rottweil* (Stuttgart, 1900).

ROTUMAH (Rotuma, Rotoum or Grenville), an island of the South Pacific Ocean, in 12° 30' S., 177° E., about 300 m. N. by W. of Fiji, of which British colony it is a dependency. Its area is 14 sq. m., and its extreme elevation 800 ft. It is surrounded by coral reefs, and is richly wooded. Several islets lie round it. The population is about 2200, the natives being Polynesian, though their language has been classified as Melanesian. They are Wesleyans or Roman Catholics. The chief product is copra. A European commissioner resides. Local laws, subject to approval by the legislative council of Fiji, are promulgated by a regulation board, composed of the commissioner, native chiefs of the seven districts into which the island is divided, and two native magistrates. Rotumah was discovered by Captain Edwards of the "Pandora" in 1791, and was annexed by Great Britain in 1881.

ROUAULT, JOACHIM (d. 1478), French soldier, was a member of an old family of Poitou. He attached himself to the dauphin (afterwards Louis XI.) and became his premier squire. He followed Louis in his expedition against the Swiss in 1444, distinguished himself in the war against England in 1448, and received the posts of governor of Blaye and Fronsac and constable of Bordeaux. After taking an important part in the battle of Castillon (1453), which resulted in the defeat and death of John Talbot, 1st earl of Shrewsbury, he fought against John V., count of Armagnac, in 1455, and in the following year made a fruitless expedition into Scotland. He took part in the campaign in Catalonia, and became marshal of France in 1461, and governor of Paris in 1471. In 1471 and 1472 he defended Amiens and Beauvais against the Burgundians. Towards the end of his life he was disgraced by Louis XI., and sentenced to banishment and the confiscation of his property. (M. P. *)

ROUBAIX, a manufacturing town of northern France, in the department of Nord, 6 m. N.E. of Lille on the railway to Ghent. Pop. (1906) 119,955. Roubaix is situated about a mile from the Belgian frontier on the Roubaix Canal, which connects the lower Deule with the Scheldt by way of the Marqz and the Espierre. Tramways connect the town with Lille and with the neighbouring communes of Tourcoing (pop. 62,604), Croix (pop. 16,292) and Watreloes (pop. 14,618), with which it unites to form one great industrial centre. The chief business of Roubaix is the woollen manufacture, but cotton, silk and other materials are also produced. The chief of these are fancy and figured stuffs for garments, velvet and upholstering fabrics. Wool-combing and wool-dressing works, spinning-mills, weaving establishments, dye-houses and printing-works occupy some 50,000 work-people, and four hundred firms act as commission agents for the sale of raw material and the other requisites for the industry. Power is supplied chiefly by steam, less than 5000 out of 28,000 looms being hand-looms. There are breweries, rubber-works, metal foundries and machinery-works in the town. Tomato and grape growing under glass for the winter market is extensively prosecuted. To maintain the high standard of artistic taste which has made the industry of Roubaix a success, schools have been multiplied. By the co-operation of the town and the state the national school of industrial arts was founded in 1883. This is a small university of art,

commerce and industry, the twenty-two courses of which include all the branches of knowledge useful in any of those pursuits. Among the public institutions are the tribunal of commerce and the chamber of commerce, the exchange, a board of trade-arbitration and the establishment (*bureau de conditionnement*) for determining the nature and weight of silk, wool and cotton.

The prosperity of Roubaix had its origin in the first factory franchise granted in 1469 by Charles the Bold, duke of Burgundy, to Peter, lord of Roubaix, a descendant of the royal house of Brittany. In the 18th century Roubaix suffered from the jealousy of Lille of which it was a dependency, and it was not till the 19th century that its industries acquired real importance. The population, which in 1804 was only 8700, had risen in 1861 to 40,000, in 1866 to 65,000, and in 1876 to 83,000.

ROUBILLIAC (more correctly ROUBILLAC), **LOUIS FRANÇOIS** (1605-1762), French sculptor, was born at Lyons and became a pupil of Balthasar of Dresden and of N. Coustou. It is generally stated that he settled in London about 1720, but as he took the second grand prize for sculpture in 1730, while still a pupil of Coustou, it is unlikely that he visited England at an earlier date. The date 1744, as given by Dussieux, is incorrect. He was at once patronized by Walpole and soon became the most popular sculptor in England, superseding the success of the Fleming Rysbrack and even of Scheemakers. He died on the 11th of January 1762, and was buried in the church of St Martin-in-the-Fields. Roubillac was largely employed for portrait statues and busts, and especially for sepulchral monuments. His chief works in Westminster Abbey are the monuments of Handel, Admiral Warren, Marshal Wade, Mrs Nightingale and the duke of Argyll, the last of these being the first work which established Roubillac's fame as a sculptor. The statues of George I., Sir Isaac Newton, and the duke of Somerset at Cambridge, and of George II. erected in Golden Square, London, were also his work. Trinity College, Cambridge, possesses a series of busts of distinguished members of the college by him. Roubillac possessed skill in portraiture and was technically a master, but lived at a time when his art had sunk to a low ebb. His figures are frequently uneasy, devoid of dignity and sculptural breadth, and his draperies treated in a manner more suited to painting than sculpture. There are, however, noteworthy exceptions, his bust of Pope, for example, reaching a high standard. More often, however, his striving after dramatic effect detracts from repose of attitude.

His most celebrated work, the Nightingale monument, in Westminster Abbey, a marvel of technical skill, is saved from being ludicrous by its ghastly and even impressive hideousness. On this the dying wife is represented as sinking in the arms of her husband, who in vain strives to ward off a dart which Death is aiming at her. The lower part of the monument, on which the two portrait figures stand, is shaped like a tomb, out of the opening door of which Death, as a half-veiled skeleton, is bursting forth. The celebrated bust of Shakespeare, known as the Davenport bust, in the possession of the Garrick Club, London, must be attributed to Roubillac. The statue of Shakespeare, a commission from David Garrick, and bequeathed by the actor to the English nation, is in the British Museum, and shows the talent of the sculptor in a flattering light. It is noteworthy that none of his work is recorded in France, the land of his birth and education.

See Le Roy de Sainte-Croix, *Vie et ouvrages de L. F. Roubillac, sculpteur lyonnais (1605-1762)* (Paris, 1882). (An extremely rare work, of which a copy is in the National Art Library, Victoria and Albert Museum, South Kensington, London.) Allan Cunningham, *The Lives of the Most Eminent British Painters, Sculptors, and Architects*, vol. 3, pp. 31-67 (London, 1830)—the fount of information of later biographies. Dutton Cook, *Art in England* ("A Sculptor's Life in the Past Century") (London, 1869); Austin Dobson, *The Magazine of Art*, "Little Roubillac," vol. 17, pp. 202 and 231 (London, 1894). See also J. T. Smith, *Nollekens and his Times* (London, 1829 *passim*). Henry B. Wheatley has also devoted research to the work and life of Roubillac. (M. H. S.)

ROUCHER, JEAN ANTOINE (1745-1794), French poet, the son of a tailor of Montpellier, was born on the 22nd of February 1745. By an epithalamium on Louis XVI. and Marie Antoinette he gained the favour of Turgot, and obtained

a salt-tax collectorship. His poem was entitled *Les Mois*; it appeared in 1779, was praised in MS., damned in print and restored to a just appreciation by the students of literature of the 19th century. It has the drawbacks of merely didactic-descriptive poetry on the great scale, but occasionally displays much grace and spirit. The malicious wit of Rivarol's *mot* on the ill-success of the poem, "C'est le plus beau naufrage du siècle," is not intelligible unless it is said that one of the most elaborate passages describes a shipwreck. Roucher was a disciple of Voltaire, and therefore a friend of the Revolution, but he remained moderate in his opinions. He frequently presided over an anti-Jacobin club, and denounced the tyranny of the popular demagogues in supplements published with the *Journal de Paris* in 1792. He was arrested on the 4th of October 1793, and, accused of being the leader of a conspiracy among the prisoners at Saint Lazare, was sent to the guillotine on the same tumbril with his friend André Chénier on the 25th of July 1794. Roucher translated in 1790 Adam Smith's *Wealth of Nations*. His letters from prison were edited by his son-in-law under the title of *Consolations de ma captivité* (1797), and his death was made the subject of a tragedy in 1834 by his brother Claude Roucher-Deratte, a voluminous writer.

See A. Guilleux, *Pendant la terreur, le poète Roucher, 1745-1794* (1890), founded on the poet's papers by one of his descendants.

ROUÉ, a dissipated debauchee. The word is French, and its original meaning was "broken on the wheel." Breaking on the wheel was a form of execution reserved in France, and some other countries, for crimes of peculiar atrocity. A *roué*, therefore, came by a natural process to be understood to mean a man morally worse than a *pendard* or gallows-bird, who only deserved hanging for common crimes. He was also a leader in wickedness, since the chief of a gang of brigands (for instance) would be broken on the wheel, while his obscure followers were merely hanged. Philip, duke of Orleans, who was regent of France from 1715 to 1723, gave the term the sense of impious and callous debauchee, which it has borne since his time, by habitually applying it to the very bad male company who amused his privacy and his leisure. The *locus classicus* for the origin of this use of the epithet is in the *Mémoires* of Saint-Simon (vol. xii. pp. 441-46, ed. Chéruel and Regnier, Paris, 1873-86).

ROUELLE, GUILLAUME FRANÇOIS (1703-1770), French chemist, was born in 1703 at Mathieu, near Caen. He started as an apothecary, but in 1742 he was appointed experimental demonstrator of chemistry at the Jardin du Roi in Paris, where he was especially influential and popular as a teacher, numbering Lavoisier and J. L. Proust among his pupils. Many stories are told of the vivacity and enthusiasm with which he lectured, of the absent-mindedness which sometimes led him, forgetting that his pupils could not hear what he was saying, to continue his explanations while he was out of the classroom looking for some piece of apparatus, and of the vigorous tirades, generally culminating in the epithet "plagiare," in which he used to indulge against men with whom he disagreed (Höfer, *Hist. de la chimie*, ii. 378). His most important achievement was to define "salts"—a term formerly used in the most loose and indeterminate way—as the compounds formed by the union of acids and bases, and further to distinguish between neutral, basic and acid salts. Other subjects on which he published papers were the inflammation of turpentine and other essential oils by nitric acid, and the methods of embalment practised by the Egyptians. He died at Passy on the 3rd of August 1770. He is known as Rouelle the elder, to distinguish him from his younger brother and assistant, HILAIRE MARIN (1718-1779), who, on his resignation in 1768, succeeded him as demonstrator at the Jardin du Roi.

ROUEN, a city of France, capital of the department of Seine-Inférieure and the ancient capital of the province of Normandy, on the Seine, 87 m. N.W. of Paris by rail. Pop. (1906) 111,402. The old city lies on the north bank of the river in an amphitheatre formed by the hills which border the Seine valley. It is surrounded by boulevards. Outside the ellipse formed by

these lie the suburbs of Martainville, St Hilaire, Beauvoisine, Bouvreuil and Cauchoise; 2½ m. to the east is the industrial town of Darnétal (pop. 6770), and in the level plain on the opposite bank of the Seine is the extensive manufacturing suburb of St Sever with the industrial towns of Sotteville (pop. 18,906) and Petit Quevilly (pop. 14,852) in its immediate neighbourhood. Finally in the centre of the river, north-east of St Sever, is the Ile Lacroix, which also forms part of Rouen. Communication across the Seine is maintained by ferry and by three bridges, including a *pont transbordeur*, or moving platform, slung between two lofty columns and propelled by electricity. Rouen possesses four railway stations. The central point of the old town is the Place de l'Hôtel de Ville, occupied by the church of St Ouen, the hôtel de ville and an equestrian statue of Napoleon I., and traversed by the Rue de la République which leads from it past the cathedral to the Place de la République and the Quai de Paris. Parallel to this street to the west are the Rue Beauvoisine with its southern continuations, the Rue des Carmes and the Rue Grand-Pont, and the wide and handsome Rue Jeanne d'Arc terminating on the Quai de la Bourse. These thoroughfares, which are all within the boulevards, are crossed at right angles by the Rue de la Grosse-Horloge and by the Rue Thiers, running from the Place Cauchoise on the west to the Place de l'Hôtel de Ville, and passing on the left the Jardin Solferino and the museum.

The cathedral was built on the site of a previous cathedral which was destroyed by fire in 1200, and its construction lasted from the beginning of the 13th century, to which period belong the lateral doors of the west portal, to the beginning of the 16th century, when the Tour de Beurre was completed. The spire surmounting the central tower, which is the highest in France (485 ft.), is modern. The western façade, with its profusion of niches, pinnacles and statues, belongs, as a whole, to the Flamboyant style. But the northern tower, the Tour St Romain, is in the main of the 12th century, its upper stage (with its steep, pointed roof) having been added later. The southern tower, the Tour de Beurre, so named because funds for its building were given in return for the permission to eat butter in Lent, is of a type essentially Norman, and consists of a square tower pierced by high mullioned windows and surmounted by a low, octagonal structure, with a balustrade and pinnacles. The juxtaposition of these two towers, so different in character, is the most striking feature of the main façade, which is notable besides for its width. The portals of the transept are each flanked by two towers and decorated with sculpture and statuary. That to the north, the Portail des Libraires, looks upon the Cour des Libraires, once the resort of the booksellers of Rouen. That to the south is known as the Portail de la Calende. The plan of the church comprises a nave with aisles and lateral chapels, a transept and a choir with ambulatory. The most remarkable part of the interior is the Lady Chapel (1302-20) behind the choir with the tombs (1518-25) of Cardinal Georges d'Amboise and his nephew, the statuary of which, including the kneeling statues of the two cardinals, is of the finest Renaissance workmanship. The chapel also contains the tomb (1536-44) of Louis de Brézé, seneschal of Normandy. Behind the cathedral is the archiepiscopal palace, a building of the 14th and 15th centuries.

St Ouen, formerly the church of an abbey dating to the Roman period and reorganized by Archbishop St Ouen in the 7th century, exceeds the cathedral in length as well as in purity of style. In spite of the juxtaposition of the second and third, the Radiant and Flamboyant types of Gothic architecture, the building, as a whole, presents a unity which even the modern façade has failed to mar. It was founded in 1318 in place of a Romanesque church which previously occupied the site and of which the only relic is the chapel in the south transept. The choir alone was constructed in the 14th century. The nave of the church belongs to the 15th century, by the end of which the central tower with its octagonal lantern and four flanking turrets had been erected. The building of the western facade, which is flanked by two towers, was not undertaken till 1846.

The walls of the church are pierced by windows filled with stained glass of the 14th, 15th and 16th centuries and cover more space than is usual even in French Gothic churches. The Portail des Marmousets, the entrance to the south transept, has a projecting porch, behind and above which rises a magnificent rose window. The north façade has no entrance. In the interior, now despoiled of many artistic treasures, there is an organ-case dating from 1630 and a railing of the 18th century surrounding the choir.

The church of St Maclou, behind the cathedral, begun in 1437 and finished early in the 16th century, is a rich example of the Flamboyant style, the characteristics of which are specially displayed in the decoration of the façade and the tracery of the portal with its five arched openings. It is celebrated for carving attributed to Jean Goujon which appears on the western doors and in other parts of the church, and has a handsome organ-loft reached by a graceful open staircase, and stained glass of the 15th and 16th centuries. The spire above the central tower is modern and was finished in 1869. Close by the church is the old parish cemetery called the Aître de St Maclou; it is surrounded by wooden galleries of the Renaissance period, supported on stone pillars on which are sculptures representing a dance of death.

The church of St Vincent, near the Seine, is a building of the 16th century and contains the finest stained-glass windows in Rouen; those at the end of the north aisle, by Engrand and Jean le Prince, artists of Beauvais, are the most noted. The stained glass in the churches of St Patrice (16th century) and St Godard (late 15th century) is inferior only to that of St Vincent. Among the less important ecclesiastical buildings of Rouen are the churches of St Gervais, St Romain, St Laurent, St Vivien, and the tower of St André, a relic of an old church of the 15th and 16th centuries.

The most important secular building in Rouen is the Palais de Justice, once the seat of the exchequer and, later, of the parliament of Normandy. It is in the late Gothic style and consists of a main building flanked by two wings. The left wing, known as the Salle des Procureurs, was erected in 1493 and is remarkable for its lofty barrel-roof of timber. South of the Palais de Justice is the Porte de la Grosse Horloge, an arcade spanning the street and surmounted by a large clock of the 15th century with two dials. The Tour de la Grosse Horloge, which rises beside the arcade, was built in 1389. The tower known as the Tour de Jeanne d'Arc was the scene of her trial, and is all that remains of the castle built by Philip Augustus early in the 13th century. The Porte Guillaume-Lion, opening on to the Quai de Paris, is a handsome gateway built in 1749.

There are numerous old houses in Rouen in the Gothic and Renaissance styles. The Hôtel de Bourgheroulde, the most famous of them, is a stone mansion of the 15th century added to in the reign of Francis I, the façades of which are decorated with bas-reliefs representing scenes from the meeting of the Field of the Cloth of Gold and allegories from the Triumphs of Petrarch. Among more modern buildings are the hôtel de ville of the 18th century, adjoining the north side of the church of St Ouen, the Bourse dating from the same period, and the Musée-Bibliothèque constructed in 1880 and containing rich collections of pictures and ceramics and a library with upwards of 133,000 volumes and many valuable MSS. An important museum of antiquities and a museum of natural history are contained in the old convent of the Visitation. A statue of the composer F. A. Boffeldieu overlooks the Quai de la Bourse, and one of Pierre Corneille stands at the western extremity of the Ile Lacroix; both were natives of the town. At Bonsecours, on a hill on the Seine 2 m. above Rouen, are the modern church, which is a resort of pilgrims, and the monument to Joan of Arc consisting of three small Renaissance buildings with a statue of the heroine in the principal one.

Rouen is the seat of an archbishop, a prefect, a court of appeal and a court of assizes, and headquarters of the 111 army corps; its public institutions also include a tribunal of first instance, tribunals of commerce and of maritime commerce, a council of

trade-arbitration, a chamber of commerce and a branch of the Bank of France. Among its educational establishments are preparatory schools of medicine and pharmacy, and of higher instruction in science and literature, lycées and training-colleges for both sexes, ecclesiastical seminaries, and schools of commerce and industry, of architecture, music and fine arts. All the more important nations have consulates in the city. Rouen is an important centre for trade in wines, spirits, grain and cattle. Grain, wine, coal, timber and petroleum are leading imports. Besides its manufactures it exports plaster, sugar and sand. The principal industries of Rouen and its district are the spinning and weaving of cotton, notably the manufacture of *rouenneries* (cotton fabric woven with dyed yarn), the printing and dyeing of the manufactured material and the spinning of flax, hemp and jute; ship-building and the making of braces, shirts, bodices, boots, shoes and hats is also carried on, and there are distilleries, petroleum-refineries and manufactories of chemicals, soap, machinery, carding-combs and brushes. The port of Rouen comprises the marine docks below the Boieldieu bridge, and the river dock, the timber dock and the petroleum dock above it. There is also a repairing dock. The Seine is tidal beyond Rouen. The port is accessible for ships drawing 191 to 22½ ft. of water, and its quays have a superficial area of about 123 acres. It is served by the lines of the Orleans, the Western and the Northern railway companies, and these, in addition to the waterways connected with the Seine, make Rouen a convenient centre for the distribution of merchandise.

Ratuma or *Ratumacos*, the Celtic name of Rouen, was modified by the Romans into *Rolomagus*, and by the writers of medieval Latin into *Rodomum*, of which the present name is a corruption. Under Caesar and the early emperors the town was the capital of the *Veliocasses*, a people of secondary rank, and it did not attain to any eminence till it was made the centre of *Lugdunensis Secunda* at the close of the 3rd century, and a little later the seat of an archbishop. Rouen owed much to its first bishops—from St Mello, the apostle of the region, who flourished about 260, to St Remigius, who died in 772. The bishops built many churches and their tombs became in turn the origin of new sanctuaries. Under Louis le Débonnaire and his successors, the Normans several times sacked the city, but after the treaty of St Clair-sur-Epte in 912, Rouen became the capital of Normandy and attained still greater prosperity. It was the principal residence of the dukes and was the scene in 949 of a victory gained by Duke Richard I. over Otto the Great, emperor of Germany, Louis d'Outremer, king of France, and Arnold, count of Flanders. In 1087 William the Conqueror, mortally wounded at Mantes, died at Rouen. The succeeding Norman kings of England tended to neglect Rouen in favour of Caen and afterwards of Poitiers, Le Mans and Angers; but its monasteries, local trade and manufactures, and the communal organization which the citizens exacted from their sovereigns during the course of the 12th century maintained an importance which is indicated by the building of several fine churches, notably that of St Ouen. In 1203 Rouen was the scene of the murder of Arthur of Brittany at the hands of King John of England. Ostensibly to avenge the crime, Philip Augustus invaded Normandy and entered the capital unopposed. The union of the province with the crown of France in no way hindered the prosperity of the city, for Philip confirmed its communal privileges and built a new castle. A convention between the merchants of Rouen and those of Paris relating to the navigation of the Seine was followed by treaties with London, with the Hanseatic towns and with Flanders and Champagne. In 1302 the seat of the exchequer or sovereign court, afterwards the parlement, of Normandy was definitely fixed at Rouen, which had previously shared its sessions with other towns. In 1356 Charles the Bad, king of Navarre, a favourite in the city, was arrested within its walls, an event which displeased the inhabitants, who after the disaster at Poitiers supported the cause of Étienne Marcel. The revolt of the Harelle in 1382, caused by the exactions both of the uncles of Charles VI. and of the monks of St Ouen, was followed by heavy punishment. In spite of this a stubborn resistance was offered to Henry V. of England who, after a long siege, occupied the town in 1419. The prosperity of Rouen continued under the English domination, and during this period the greater part of the church of St Ouen was constructed. In 1451 Joan of Arc was tried and burnt in the city. From that year the French began a series of

attempts to recapture the town, but they were unsuccessful till 1449 when Somerset, the English commander, was obliged to surrender the principal fortified places in Normandy. During the close of the 15th century and the first half of the 16th, Rouen was the metropolis of art and taste in France and was one of the first places to reflect the influence of the Renaissance. During the wars of religion the arts declined. In 1562 the town was sacked by the Protestants. This did not prevent the League from gaining so firm a footing there that Henry IV. besieged it unsuccessfully and only obtained entrance after his abjuration. The revocation of the edict of Nantes in 1685 lost Rouen many of its richest and most industrious citizens in the Calvinistic emigration. The town suffered less from the excesses of the French Revolution than from the depredations of bandits who, under the Directory, infested the neighbourhood of the city and were not suppressed till the Consulate. During the Franco-German War the city was occupied by the invaders from December 1870 till July 1871, and had to submit to heavy requisitions.

See A. Chéruel, *Histoire de Rouen pendant l'époque communale* (Rouen, 1843); *Histoire de Rouen sous la domination anglaise au quinzième siècle* (Rouen, 1840); N. Périoux, *Histoire sommaire et chronologique de la ville de Rouen* (Rouen, 1874); C. Enlart, *Rouen* (Paris, 1904).

ROUERGUE (*Ruthenensis pagus*), one of the old provinces of France, was originally inhabited by the *Rutheni*. It was bounded on the N. by Auvergne, on the S. and S.W. by Languedoc, on the E. by Gévaudan and the Cévennes and on the W. by Quercy. It included (1) the county of Rodez, (2) Haute and Basse Marche; and it was divided between the dioceses of Rodez and Vabres (province d'Alby after this province had been separated from that of Bourges in 1678). Administratively it formed first a *sénéchaussée*, dependent on Languedoc (capital Villefranche, in the Basse Marche), and later it was attached to the military governments of Guienne and Gascony. It was then part of the departments of Aveyron and of Tarn-et-Garonne. The county of Rodez, after having been in the possession of the houses of Toulouse and Carlat, fell in the 14th century into that of Armagnac. Jean II. of Armagnac having served Charles V. faithfully during his wars with England, received from him, in 1374, what were called the four "*châtellenies*" with the "*Commun de la paix*," a tax which had been established there to organize resistance against foreigners. Jean V. of Armagnac was deprived of the county for crime and treason against Louis XI., in 1469, but afterwards it was given back to Charles of Armagnac, who died without legitimate issue in 1496. Its possession was then disputed between King Francis I. and the duke of Alençon, who at last compromised (1510); the king ceded the county to his sister Marguerite d'Angoulême, who took it as dowry first to the duke of Alençon, and then to her second husband Henri d'Albret, king of Navarre. The county afterwards passed to Jeanne d'Albret, then to Henri IV., and was joined to the crown lands in 1590.

ROUGE ("red," from Lat. *rubeus*), a French name applied to various colouring substances of a brilliant carmine tint, especially when used as cosmetics. The best of these preparations are such as have for their basis carthamine, obtained from the safflower (*Carthamus tinctorius*). The Chinese prepare a rouge, said to be from safflower, which, spread on the cards on which it is sold, has a brilliant metallic green lustre, but when moistened and applied to the skin assumes a delicate carmine tint. Jeweller's rouge for polishing plate is a fine red iron oxide prepared by calcination from ferrous sulphate (green vitriol).

ROUGET DE LISLE, CLAUDE JOSEPH (1760-1836), French author, was born on the 10th of May 1760, at Lons-le-Saunier (Jura). He entered the army as an engineer, and attained the rank of captain. He was one of those authors whom a single work has made famous. The song which has immortalized him, the *Marseillaise*, was composed at Strassburg, where Rouget de Lisle was quartered in April 1792. He wrote both words and music in a fit of patriotic excitement after a

public dinner. The piece was at first called *Chant de guerre de l'armée du Rhin*, and only received its name of *Marseillaise* from its adoption by the Provençal volunteers whom Barbaroux introduced into Paris, and who were prominent in the storming of the Tuileries. The author was a moderate republican, and was cashiered and thrown into prison; but the counter-revolution set him at liberty. He died at Choisy-le-Roi (Seine et Oise) on the 26th of June 1836. The stirring melody of the *Marseillaise* and its ingenious adaptation to the words serve to disguise the alternate poverty and bombast of the words themselves. Rouget de Lisle wrote a few other songs of the same kind, and in 1825 he published *Chants français*, in which he set to music fifty songs by various authors. His *Essais en vers et en prose* (1797) contains the *Marseillaise*, a prose tale of the sentimental kind called *Adolphe et Monville*, and some occasional poems.

ROUGH CAST (the French equivalent is *crépis*), in architecture, the exterior coating originally given to the walls of common dwellings and outbuildings, but now frequently employed for decorative effect on country houses, especially those built in half timber. It is a composition of small gravel and sand, mixed with strong lime mortar, and is thrown on the walls already covered with two ordinary coats of plaster. Variety can be obtained on the surface of the wall by small pebbles of different colours, and in the Tudor period fragments of glass were sometimes embedded. The central tower of St Alban's cathedral, built with Roman tiles from Verulam, was covered with rough cast believed to be coeval with the building. The rough cast was removed about 1870.

ROUHER, EUGÈNE (1814-1884), French statesman, was born at Riom (Puy de Dôme) on the 30th of November 1814. He practised law in his native place after taking his degree in Paris in 1835, and in 1846 sought election by his fellow-citizens to the Chamber of Deputies as an official candidate of the Guizot ministry. It was only after the revolution of 1848, however, that he became deputy for the department of Puy de Dôme. Re-elected to the Legislative Chamber in 1849 he succeeded Odilon Barrot as minister of justice, with the additional office of keeper of the seals, which he retained with short intervals until January 1852. From the tribune of the Chamber he described the revolution of February as a "catastrophe," and he supported reactionary legislation, notably the bill (May 31, 1850) for the limitation of the suffrage. After the *coup d'état* of December 2, 1851, he was entrusted with the redaction of the new constitution, and on his resignation of office in January became vice-president of the Council of State. After the formal establishment of the Empire, Napoleon III. rewarded him by a grant of £40,000 and the estate of Cirey. In 1855 he became minister of agriculture, commerce and public works, and in 1856 senator. He secured for France an excellent system of railways without making them a state monopoly, and he conducted the complicated negotiations for the treaty of commerce with England which was concluded in January 1860, and subsequently arranged similar treaties with Belgium and Italy. In 1863 he became minister president of the Council of State, and on the death of A. M. Billault minister of state and chief spokesman of the emperor. Before the Corps Législatif. Although the government had a great majority in the Chamber, the opposition counted the redoubtable names of Thiers, Berryer and Jules Favre, and government measures were only passed by frequent resort to the closure. Rouher had to defend Napoleon's foreign adventures as well as the free-trade treaties and the extravagances of Baron Haussmann for which he was directly responsible. After an attempted defence of the foreign policy which had aided the aggrandizement of Prussia at the expense of Austria, Thiers told him in the Chamber that there were "no more blunders left for him to make." He opposed the abortive Liberal concessions of January 1867, announced in a personal letter from Napoleon III. to himself, and resigned with the rest of the cabinet, only to resume office after a short interval as minister of finance. When concessions became inevitable Rouher, the "vice-emperer," resigned

to make way after six months' interval for Emile Ollivier. He still fought for reaction in his new office of president of the Senate. After the fall of the Empire he fled to England, but returned to France a year later to work for the fortunes of the prince imperial. After serious disturbances he was elected member for Ajaccio on the 11th of February 1872, his election being characterized by the prefect of Corsica as a regular conspiracy in favour of the Empire. In the Chamber, where he subsequently represented Riom, he formed the group of the Appel au Peuple. His first speech in the House was the occasion (May 21, 1872) of violent attacks by Audiffret-Pasquier and Gambetta. The death of the prince imperial in 1879 put an end to the serious chances of the Bonapartists, although Rouher sought to secure the recognition of Prince Napoleon, son of the ex-king Jerome, as heir to the imperial honours. Rouher lost his reason after a stroke of paralysis in 1883, and died on the 3rd of February 1884.

For an estimate of Rouher, see *marquis de Castellane, Les Hommes d'état français du XIX. siècle* (1888), and generally the literature dealing with the Second Empire.

ROULERS (Flemish *Roelslaere*), a town of Belgium, in the province of West Flanders, 13 m. N.W. of Courtrai. Pop. (1904) 24,548. It is one of the oldest communes in Belgium, and was famous for its weavers in the 11th and 12th centuries. Its prosperity depends on the cultivation of flax and the manufacture of linen. The church of St Michael is remarkable for its lofty tower. Baldwin VIII., count of Flanders, died here in 1120, and in 1704 the French under Pichegru defeated the Austrians under Clerfayt.

ROULETTE, in mathematics, the locus of a point carried on a curve which rolls on another (fixed) curve. The name appears to have been used by Pascal to denote the cycloid (*g.c.*), which is the simplest roulette, being traced by a point on the circumference of a circle rolling on a straight line. The trochoids and epicycloids (*g.c.*) are also simple roulettes, the latter being traced by a point on a circle which rolls on another circle.

See W. H. Besant, *Roulettes and Glissettes*.

ROULETTE, a gambling game, of French origin. It is one of the two games played in the gambling-rooms at Monte Carlo, and the description here given, and the maximum and minimum stakes mentioned, are to be understood as applying to the game as it is there conducted. It is solely a game of chance, though so-called "systems" are innumerable, and some of them for a short period often appear to give the player an advantage. There is no possible system, however, which will assure success in the long-run, and it is herein that the ingenuity of the game consists. Every systematic method of play must depend upon increased stakes to retrieve past losses; and though a player with an unlimited capital might be practically certain to achieve his end in the course of time, the circumstance that there is always a maximum renders the bank invincible. The roulette table, covered with a green cloth, is made up of precisely corresponding halves with a circular space let into the middle holding the wheel, on either side of which the cloth is divided into spaces marked *passé, pair, manque, impair*, and the black and red diamonds. The wheel is divided into thirty-seven compartments, coloured alternately black and red, numbered from one to thirty-six, the thirty-seventh being zero. *Pair* indicates even numbers, *impair* odd numbers, *manque* includes the numbers from 1 to 18; *passé*, from 19 to 36. The methods of staking are innumerable. The minimum stake is five francs, which must be placed on the table in the form of a five-franc piece, and not in smaller change. *Rouge, noir,*

pair, impair, manque and *passé* are even chances; i.e. a stake put upon any of them is paid in corresponding coin should the player win, the exception being when the little ball which is spun round the wheel falls into zero, in which case the even money chances are put "in prison"—that is to say, laid aside until another spin, when if the bank wins they are lost, if the player wins he is allowed to retrieve his money. The maximum in the case of these chances is 6000 francs. Any one who desires to play *en plein* puts his stake on one of the thirty-seven numbers. If the ball falls into the corresponding number on the wheel, the stake is paid thirty-five times; and as there are thirty-seven numbers on the board, with the advantage already described of imprisoning the even-money chances when zero comes up, it will be seen that there is a steady percentage in favour of the tables and consequently against the player. This percentage is of course greatly increased when, as is often the case, a second zero, called *double-zero*, is used. In some gambling-houses there is even a third one, called Eagle Bird. The maximum stake allowed *en plein* is 180 francs. The next most daring selection is *à cheval*, when the stake is placed on the line separating any two numbers, and if either of them wins the player is paid seventeen times, the highest stake permissible being 360 francs. *Transversale pleine* covers any three numbers in a line, the coin or note being placed on the line dividing any one of the numbers from the neighbouring even-money chance, as, for instance, between 4 and *passé*, or 6 and *manque*. A *transversale simple* covers six numbers, as, for example, where the line between 4 and 7 joins *passé*, or between 6 and 9 joins *manque*; and if any one of these numbers wins, five times the value of the stake is paid, the maximum here being 1200 francs. *En carré* includes four numbers, the coin being placed, for instance, on the cross between 1, 2, 4, 5, or 28, 29, 31, 32; eight times the value of the stake is paid, and the maximum is 760 francs. The dozens and the columns are also indicated on the board, the first dozen of course including 1 to 12. In each of the columns are twelve numbers in different order. A stake placed on either a dozen or a column is paid twice its value, the maximum here being 3000 francs. A stake constantly played is called the *quatre premiers*, which includes zero, 1, 2 and 3, the stake being placed on the line where zero and 1 join *passé*, or where zero and 3 join *manque*. If any one of these four numbers, including zero, wins, the stake is paid eight times; and four times eight being thirty-two, there is a greater advantage to the table than when it loses *en plein* or on certain other chances. Zero can also be played in combination with any one or two of its neighbours; if with one of them the stake is paid seventeen times, if with two of them eleven times. A croupier sits on either side of the wheel; there is also one at each end of the table, their business being to assist the players in staking and recovering their winnings. Behind each of the former pair an official on a high chair supervises the table. The croupier whose duty it is to spin the wheel waits for a time till stakes have been made, and then, exclaiming, "Messieurs, faites votre jeu!" sets the cylinder in motion, throwing the ball in the direction contrary to that in which the wheel revolves. When it is seen that the ball will soon fall at rest in one of the compartments of the cylinder the croupier gives the notice, "Rien ne va plus," after which no stakes can be placed. When the ball finally rests in the compartment, the croupier announces the number and the even-money chances that win, as for instance *rouge, impair* and *manque*. He and his fellows then gather in with a rake all the money that has been lost, after which the winnings are paid and the game proceeds. At the beginning of play each table is supplied with a certain large sum. When the bank loses this and is forced to send for another supply it is said to be "broken."

ROUND (O. Fr. *ronde*, Lat. *rotundus*, the Fr. is the source also of Du. *ronde*; Ger., Swed., Dan. and Nor. *rund*), circular, spherical, globular. As a substantive, the word has several specific applications; thus it is used of the rung of a ladder, of a rounded cross-bar connecting the legs of a chair, of the circuit of the



watch under an officer which patrols the sentries in a fortress, fortified town, camp or other military station, and hence of the beat or customary course of a policeman, a postman, or a tradesman, and of the full course at such a game as golf. Similarly there were old dances called "rounds," in which the dancers stood in a circle or ring. They were popular in the 16th and 17th centuries. Later the name was also applied to country dances where the dancers stood in two lines. For the "round" in music see CANON. A complaint or remonstrance signed by a number of persons is commonly known as a "round robin"; properly such a document should have the signatures arranged in a circle, the idea being that thus the order in which the complainants signed should be unknown. In the 16th century "round robin" was a name of mockery given to the Eucharist.

ROUNDERS, an English ball game, probably dating from the 18th century, but not attaining to any popularity before 1800. It was the immediate ancestor of Baseball (*q.v.*). Up to the year 1889 no special code of rules existed, but the game was played on the green, the field being marked out in a regular pentagon by five bases about 15 or 20 yds. apart, called respectively *home-base* (at which the striker stood), *1st base*, *2nd base*, *3rd base*, and *4th base*. The feeder, or bowler, stood in the middle of the pentagon and tossed the ball, which was softer than a cricket ball, to the striker, who with a round club, often a cricket stump, endeavoured to hit it as far out of the reach of the fielders as possible, a run being scored when the striker made the circuit of the bases without being put out. Almost any number of players could form a side, and the batsman would be retired when a batted ball was caught on the fly or first bounce, or when he was struck by having the ball thrown at him while running between bases. Rounders in its primitive form was more of a romp than a regular game, but it experienced a revival in Scotland and the north of England about the year 1889, when two governing bodies were formed, the National Rounders Association of Liverpool and Vicinity and the Scottish Rounders Association. These, with the later Gloucester Rounders Association, drew up the rules now recognized.

A hard ball similar to that used in baseball was adopted, and the rule by which a runner could be put out by hitting him with a thrown ball abandoned. The bat must not exceed 3½ in. in diameter nor 35 in. in length. The game is similar to baseball, but there are several important differences, the most radical being that the ball may be hit in any direction, as at cricket. The original pentagon has been discarded in favour of an elongated diamond, the home-base being at one end and 1st, 2nd and 3rd bases at the other points, while the 4th base is situated on the line of 3rd base towards home and 17 yds. from the former, the sides of the diamond being 22 yds. in length. The bowler stands in a space marked off in the centre of the diamond and tosses the ball to the batsman, who must hit at every "good" ball, i.e. one that is straight over the home-base and between head and knee. Two bad balls score one for the batsman. If the latter hits the ball he must run to 1st base and then 2nd, and so on round to home again, resting at any base; but he may be put out if the batted ball be caught on the fly or first bounce or the backstop (wicket-keeper in cricket) catch a ball struck at but not hit, or the batsman be touched with a ball while running between bases. Ten players constitute a side and three innings a piece are played, every player batting once in each innings. Each base made counts one. The *backstop* is placed directly behind the batsman, and behind the backstop are placed *1st cover* (right), *longstop* (middle), and *4th cover* (left). The *1st*, *2nd* and *3rd* basemen are stationed at the bases, while behind them in the field are placed the *2nd cover* (right), *centre cover*, and *3rd cover* (left). The bases are designated by light wooden posts. An umpire presides over the game. A variation of rounders is *Fieldball*, invented in 1888, a combination of rounders and cricket, a wicket being placed in front of the backstop, and the four bases arranged in a circle 25 yds. distant from each other. The bat and ball are similar to those used in baseball. Another variation is called *Baseball Rounders*, which was invented in 1889 and is practically the same as baseball.

ROUNDHEAD, a term applied to the adherents of the parliamentary party in England during the great Civil War. Some of the Puritans, but by no means all, wore the hair closely cropped round the head, and there was thus an obvious contrast between them and the men of fashion with their long ringlets. "Roundhead" appears to have been first used as a term of derision towards the end of 1641 when the debates in parlia-

ment on the Bishops Exclusion Bill were causing riots at Westminster. One authority says of the crowd which gathered there: "They had the hair of their heads very few of them longer than their ears, whereupon it came to pass that those who usually with their cries attended at Westminster were by a nickname called Roundheads." John Rushworth (*Historical Collections*) is more precise. According to him the word was first used on the 27th of December 1641 by a disbanded officer named David Hide, who during a riot is reported to have drawn his sword and said he would "cut the throat of those round-headed dogs that bawled against bishops." Clarendon (*History of the Rebellion*, iv. 121) remarks on the matter: "and from those contestations the two terms of 'Roundhead' and 'Cavalier' grew to be received in discourse. . . . they who were looked upon as servants to the king being then called 'Cavaliers,' and the other of the rabble contemned and despised under the name of 'Roundheads.'" Baxter ascribes the origin of the term to a remark made by Queen Henrietta Maria at the trial of Strafford; referring to Pym, she asked who the roundheaded man was. The name remained in use until after the revolution of 1688.

Roundhead was also used during the Civil War as the name of a weapon. This is described as having "an head about a quarter of a yard long, a staffe of two yards long put into their head, twelve iron pikes round about, and one in the end to stop with."

ROUNDMAN SYSTEM (sometimes termed the billet, or ticket, or item system), in the English poor law, a plan by which the parish paid the occupiers of property to employ the applicants for relief at a rate of wages fixed by the parish. It depended not on the services, but on the wants of the applicants, the employer being repaid out of the poor rate all that he advanced in wages beyond a certain sum. According to this plan the parish in general made some agreement with a farmer to sell to him the labour of one or more paupers at a certain price, paying to the pauper out of the parish funds the difference between that price and the allowance which the scale, according to the price of bread and the number of his family, awarded to him. It received the local name of billet or ticket system from the ticket signed by the overseer which the pauper in general carried to the farmer as a warrant for his being employed, and afterwards took back to the overseer, signed by the farmer, as a proof that he had fulfilled the conditions of relief. In other cases the parish contracted with a person to have some work performed for him by the paupers at a given price, the parish paying the paupers. In many places the roundsman system was carried out by means of an auction, all the unemployed men being put up to sale periodically, sometimes monthly or weekly, at prices varying according to the time of year, the old and infirm selling for less than the able-bodied. The roundsman system disappeared on the reform of the poor law in 1834.

ROUND TABLE, THE, in the Arthurian Romance (*q.v.*), the table round which, in order to avoid quarrels as to precedence, King Arthur's knights are seated, and so applied collectively to the knights themselves as the title of a mythical order of chivalry. The origin of the Round Table is obscure. Geoffrey of Monmouth makes no mention of it, and the earliest record is that of Wace, much expanded by his translator, Layamon, who gives a picturesque detailed description of the fight for precedence which took place at Arthur's board on a certain Yuletide day, and the slaughter which ensued. For this slaughter Arthur took summary vengeance, slaying all the kinsfolk of the man who started the fight, and cutting off the noses of his women-folk. For the future avoidance of any such scenes a cunning workman of Cornwall offered to make a table which should seat 1600 knights and more, and at which all should be equal. Arthur accepted this offer, and the result was the Round Table, peace and harmony. Wace does not mention the number of knights.

These versions of the pseudo-chronicles practically ascribe the foundation to Arthur; the romances, however, differ. In these either Merlin made the table for Uther Pendragon,

or it had belonged to Leodegrance, king of Cornwall and father of Guenevere, and was given to Arthur on his marriage with that princess. When the founding of the Round Table is ascribed to Merlin it is generally in close connexion with the Grail legend, forming the last of a series of three, founded in honour of the Trinity—the first being the table of the Last Supper, the second that of the Grail, established by Joseph of Arimathea. The number of knights whom the table will seat varies; it might seat twelve or fifty or a hundred and fifty; nowhere, save in Layamon, do we find a practically unlimited power of accommodation. It is also to be noted that whereas, in the pseudo-chronicles, it is the common table of Arthur's court, designed in the interests of peace and unity, in the romances it is a sign of superiority, only the best and most valiant knights being adjudged worthy of a seat at the Round Table. In fact, it has become the equivalent of an order of knighthood, the members of which form a brotherhood bound by oath to succour each other at need and to refrain from fighting among themselves. The membership is not restricted to the knights of Arthur's immediate court and household, knights who are, in all essentials outsiders, appearing but as passing guests at Arthur's board, such as, e.g., Perceval and Tristan, may be elected knights of the Round Table. In two romances, the prose *Tristan* and the *Parzival*, the place of the Round Table proper is taken, on a journey, by a silken cloth laid on the ground, round which the knights are seated. In the versions more closely connected with the Grail story the name of the chosen knight appears on his seat, and there is one vacant place, the *Siege perilous*, eventually to be filled by the Grail winner.

It is obvious that the tradition has passed through several stages, and has varied in the process. The original source is not easy to determine. Dr Lewis Mott has pointed out that "Round Tables" exist in many parts of Great Britain, the name being often associated with circular trenches, or rings of stones, which were demonstrably employed in connexion with the agricultural festivals held at Pentecost, Midsummer and Michaelmas. However this may be, and it seems probable that Dr Mott is right in his identification, the pseudo-chroniclers and romance writers certainly had in their minds a genuine table, although, probably, one of magical properties. Thus Layamon's table can seat an indefinite number, and yet it can be carried by Arthur when he rides abroad. On closely examining Layamon's version it seems probable that he had in his mind not merely a circular, but a turning table; he gives it as ground for the quarrel that all the knights wished to sit within; at the table the Cornish workman will make none shall be left without, but they shall sit "without and within, man against man." It is difficult to explain this phrasing in any other hypothesis than that Layamon pictured to himself Arthur's hall as open on one side, and that, on a great feast-day, owing to the number of guests, the table extended beyond the covering afforded by the roof. As the feast took place "on mid-winter's day" the annoyance of those who were without would be intelligible. To obviate this the cunning workman devised a circular table, turning on a pivot, with seats affixed, at which the guests sat the one half in turn within, the other without, the hall "man against man." This would make the Round Table analogous to the turning castles which we frequently meet with in romances; and while explaining the peculiarities of Layamon's text, would make it additionally probable that he was dealing with an earlier tradition of folklore character, a tradition which was probably also familiar to Wace, whose version, though much more condensed than Layamon's, is yet in substantial harmony with this latter. This, too, is certain; the fight for precedence at Arthur's board may be paralleled by accounts of precisely similar quarrels in early Irish literature, e.g. the famous tale of *Fled Bricrend* or *Bricriu's Feast* of the Ultonian cycle.

Recent grail researches have made it most probable that that mysterious talisman was originally the vessel of the ritual feast held in honour of a deity of vegetation,—Adonis, or

another; if the Round Table also, as Dr Mott suggests, derives from a similar source, we have a link between these two notable features of Arthurian tradition, and an additional piece of evidence in support of the view that behind the Arthur of romance there lie not only memories of an historic British chieftain, but distinct traces of a mythological and beneficent hero. Incidentally also it would seem that those versions which connect the table more closely with Arthur are the more correct.

See Wace, *Le Roman de Brut*, ed. Leroux de Lincy (1836-38), vol. ii. 74-75; Layamon, *Brut*, ed. Madden, vol. ii. p. 532; A. C. L. Brown, *The Round Table before Wace* (Boston, 1900); Lewis F. Mott, *The Round Table* (Boston, 1905). (J. L. W.)

ROUND TOWERS. A peculiar class of round tower exists throughout Ireland; about one hundred and twenty examples once existed; most of these are ruined, but eighteen or twenty are almost perfect. These towers were built either near or adjoining a church; they are of various dates, from perhaps the 8th to the 13th century; though varying in size and detail, they have many characteristics common to all. They are built with walls slightly battering inwards, so that the tower tapers towards the top. The lower part is formed of solid masonry, the one doorway being raised from 6 to 20 ft. above the ground, and so only accessible by means of a ladder. The towers within are divided into several storeys by two or more floors, usually of wood, but in some cases, as at Keneith, of stone slightly arched. The access from floor to floor was by ladders. The windows, which are always high up, are single lights, mostly arched or with a flat stone lintel. In some of the oldest towers they have triangular tops, formed by two stones leaning together. One peculiarity of the door and window openings in the Irish round towers is that the jambs are frequently set sloping, so that the opening grows narrower towards the top, as in the temples of ancient Egypt. The later examples of these towers, dating from the 12th and 13th centuries, are often decorated with chevron, billet and other Norman enrichments round the jambs and arches. The roof is of stone, usually conical in shape, and some of the later towers are crowned by a circle of battlements. The height of the round towers varies from about 60 to 132 ft.; that at Kilcullen was the highest. The masonry differs according to its date,—the oldest examples being built of almost uncut rubble work, and the later ones of neatly jointed ashlar.

Much has been written as to the use of these towers, and the most conflicting theories as to their origin have been propounded. It is fairly certain, however, that they were constructed by Christian builders, both from the fact that they always are or once were near a church, and also because crosses and other Christian emblems frequently occur among the sculptured decorations of their doors and windows. Their original purpose was probably for places of refuge, for which the solid base and the door high above the ground seem specially adapted. They may also have been watch-towers, and in later times often contained bells. Their circular form was probably for the sake of strength, angles which could be attacked by a battering ram being thus avoided, and also because no quoins or dressed stones were needed, except for the openings—an important point at a time when tools for working stone were scarce and imperfect. Both these reasons may also account for the Norman round towers which are so common at the west end of churches in Norfolk, Suffolk and Essex, though these have little resemblance to those of Ireland except in the use of a circular plan. One example exactly like those of Ireland exists in the Isle of Man, within the precincts of Peel Castle adjacent to the cathedral of St German; it was probably the work of Irish builders. There are also three in Scotland, viz. at Eglishay in Orkney, and at Abernethy and Brechin.

Round towers wider and lower in proportion than those of Ireland appear to have been built by many prehistoric races in different parts of Europe. The towers of this class in Scotland are called "brochs"; they average about 50 ft. high and 30 ft. in internal diameter. Their walls, which are usually about 15 ft. thick at the bottom, are built hollow, of rubble masonry, with series of passages one over the other running all round the tower. As in the Irish towers, the entrance is placed at some distance from the ground; and the whole structure is designed as a stronghold. The brochs

appear to have been the work of a pre-Christian Celtic race. Many objects in bronze and iron and fragments of hand-made pottery have been found in and near these towers, all bearing witness of a very early date. (See Anderson, *Scotland in Pagan Times*, 1883, and *Scotland in Early Christian Times*, 1881.) The *nuraghi* of Sardinia are described in the article on that island. During the 6th century church towers at and near Ravenna were usually built round in plan, and not unlike those of Ireland in their proportions. The finest existing example is that which stands by the church of S. Apollinare in Classe, the old port of the city of Ravenna (see *BASILICA*, fig. 8). It is of brick, divided into nine storeys, with single-light windows below, three-light windows in the upper storeys, and two-lights in the intermediate ones. The most magnificent example of a round tower is the well-known leaning tower of Pisa, begun in the year 1174. It is richly decorated with tiers of open marble arcades, supported on free columns. The circular plan was much used by Moslem races for their minarets. The finest of these is the 13th-century minar of Kutb at Old Delhi, built of limestone with bands of marble. It is richly fluted on plan, and when complete was at least 250 ft. high.

The best account of the Irish round towers is that given by Petrie in his *Ecclesiastical Architecture of Ireland* (Dublin, 1845). See also Keane, *Towers and Temples of Ancient Ireland* (Dublin, 1850); Brash, *Ecclesiastical Architecture of Ireland* (Dublin, 1875); and Stokes, *Early Architecture in Ireland* (Dublin, 1878). (J. H. M.)

ROUS, FRANCIS (1579-1659), English Puritan, was born at Dittisham in Devon in 1579, and educated at Oxford (Broadgates Hall, afterwards Pembroke College) and at Leiden, graduating at the former in January 1596-97, and at the latter thirteen months afterwards. For some years he lived in seclusion in Cornwall and occupied himself with theological studies, producing among other books *The Arte of Happiness* (1610) and *Testis Veritatis*, a reply to Richard Montagu's *Appello Caesarem*. He entered parliament in 1625 as member for Truro, and continued to represent that or some neighbouring west country constituency in such parliaments as were summoned till his death. He obtained many offices under the Commonwealth, among them that of provost of Eton College. At first a Presbyterian, he afterwards joined the Independents. In 1657 he was made a lord of parliament. He died at Acton in January 1658-59. The subjective cast of his piety is reflected in his *Mystical Marriage . . . between a Soule and her Saviour* (1635), but he is best known by his metrical version of the Psalms (1643), which was approved by the Westminster Assembly and (in a revised form) is still used in the Scottish Presbyterian churches.

ROUS, HENRY JOHN (1795-1877), British admiral and sportsman, was born on the 23rd of January 1795, the second son of the 1st earl of Stradbroke. He was educated at Westminster School, and entered the British navy in 1808, serving as a midshipman in the expedition to Flushing. He was afterwards appointed to the "Bacchante," and received a medal for bravery in various actions and expeditions. In 1823 he was made captain, and served in the Indian and New Holland stations from 1823 to 1829. In 1834 he was appointed to the command of the "Pique," a 36-gun frigate, which ran ashore on the coast of Labrador and was much damaged. Rous, however, brought her across the Atlantic with a sprung foremast and without keel, forefoot or rudder, and though the ship was making 23 ins. of water an hour. Rous, always fond of sport, retired from the navy, and became in 1838 a steward of the Jockey Club, a position which he held almost uninterruptedly to his death. In 1855 he was appointed public handicapper. He managed the duke of Bedford's stables at Newmarket for many years, and wrote a work on *The Laws and Practice of Horse Racing* that procured for him the title of "the Blackstone of the Turf." In 1841 he was returned M.P. for Westminster, and in 1846 Sir Robert Peel made him a lord of the admiralty. He died on the 19th of June 1877.

For the naval career of Admiral Rous see O'Byrne, *Naval Biographical Dictionary* (London, 1849). A vivid sketch of him as a turf authority will be found in Day's *Turf Celebrities* (London, 1891).

ROUSSEAU, JACQUES (1636-1693), French painter, a member of a Huguenot family, was born at Paris in 1636. He was remarkable as a painter of decorative landscapes and classic ruins, somewhat in the style of Canaletto, but without his delicacy of touch; he appears also to have been influenced by Nicolas Poussin. While young Rousseau went to Rome, where he spent some years in painting the ancient ruins, together with the surrounding landscapes. He thus formed his style, which was artificial and conventionally decorative. His colouring for the most part is unpleasing, partly owing to his violent treatment of skies with crude blues and orange, and his chiaroscuro usually is much exaggerated. On his return to Paris he soon became distinguished as a painter, and was employed by Louis XIV. to decorate the walls of his palaces at St Germain and Marly. He was soon admitted a member of the French Academy of the Fine Arts, but on the revocation of the edict of Nantes he was obliged to take refuge in Holland, and his name was struck off the Academy roll. From Holland he was invited to England by the duke of Montague, who employed him, together with other French painters, to paint the walls of his palace, Montague House (on the site of which is now the British Museum). Rousseau was also employed to paint architectural subjects and landscapes in the palace of Hampton Court, where many of his decorative panels still exist. He spent the latter part of his life in London, where he died in 1693.

Besides being a painter in oil and fresco Rousseau was an etcher of some ability; many etchings by his hand from the works of the Caracci and from his own designs still exist; they are vigorous, though coarse in execution.

ROUSSEAU, JEAN BAPTISTE (1671-1741), French poet, was born at Paris on the 6th of April 1671; he died at Brussels on the 17th of March 1741. The son of a shoemaker, he was well educated and early gained favour with Boileau, who encouraged him to write. He began with the theatre, for which he had no aptitude. A one-act comedy, *Le Café*, failed in 1694, and he was not much happier with a more ambitious play, *Le Flatteur* (1696), or with the opera of *Vénus et Adonis* (1697). He tried in 1700 another comedy, *Le Capricieux*, which had the same fate. He then went with Tallard as an attaché to London, and, in days when literature still led to high position, seemed likely to achieve success. His misfortunes began with a club squabble at the Café Laurent, which was much frequented by literary men, and where Rousseau indulged in lampoons on his companions. A shower of libellous and sometimes obscene verses was written by or attributed to him, and at last he was turned out of the café. At the same time his poems, as yet only singly printed or in manuscript, acquired him a great reputation, due to the dearth of genuine lyrical poetry between Racine and Chénier. He had in 1701 been made a member of the Académie des inscriptions; he had been offered, though he had not accepted, profitable places in the revenue department; he had become a favourite of the libertine but influential coterie of the Temple; and in 1710 he presented himself as a candidate for the Académie française. Then began the second chapter of an extraordinary history of the animosities of authors. A copy of verses, more offensive than ever, was handed round, and gossip maintained that Rousseau was its author. Legal proceedings of various kinds followed, and Rousseau ascribed the lampoon to Joseph Saurin. In 1712 Rousseau was prosecuted for defamation of character, and, on his non-appearance in court, was condemned *par contumace* to perpetual exile. He spent the rest of his life in foreign countries except for a clandestine visit to Paris in 1738, refusing to accept the permission to return which was offered him in 1716 because it was not accompanied by complete rehabilitation.

Prince Eugène and then other persons of distinction took him under their protection during his exile, and he printed at Soleure the first edition of his poetical works. Voltaire and he met at Brussels

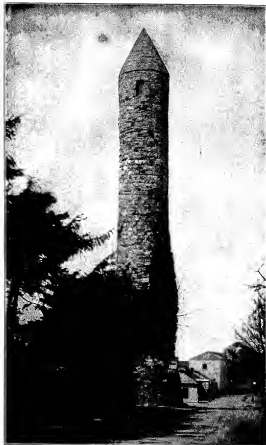

Photo, Valentine.

IRISH ROUND TOWER: CLONDALKIN, CO. DUBLIN.

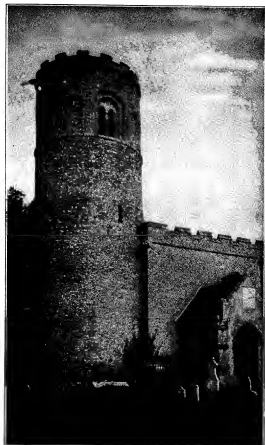

Photo, Mansell & Co.

EAST ANGLIAN ROUND CHURCH-TOWER:
LITTLE SAXHAM.

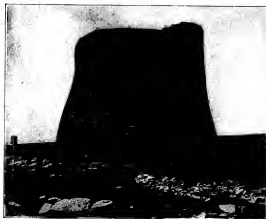

Photo, Valentine.

BROCH: MOUSA, SHETLAND.



Photo by the late Sir Francis Barry, by permission of The Country House.

BROCH: KEISS ROAD, CAITHNESS (INTERIOR,
LOWER PART, EXCAVATED).

in 1722. Voltaire's *Le Pour et le contre* is said to have shocked Rousseau, who expressed his sentiments freely. At any rate the latter had thenceforward no fiercer enemy than Voltaire. His death elicited from Lefranc de Pompignan an ode of real excellence and perhaps better than anything of Rousseau's own work. That work is divided, roughly speaking, into two contrasted divisions. One consists of formal and partly sacred odes and cantatas of the stiffest character, of which perhaps the *Ode à la fortune* is the most famous; the other of brief epigrams, sometimes licentious and always, or almost always, ill-natured. As an epigrammatist Rousseau is only inferior to his friend Alexis Piron. In the former he stands almost alone. The frigidity of conventional diction and the disuse of all really lyrical rhythm which characterize his period do not prevent his odes and cantatas from showing at times true poetical faculty, though cramped, and inadequate to explain his extraordinary vogue. Few writers were so frequently reprinted during the 18th century, but even in his own century La Harpe had arrived at a truer estimate of his real value when he said of his poetry: "Le fond n'est qu'un lieu commun chargé de déclamations et méme d'idées fausses."

Besides the *Soleure* edition mentioned above Rousseau published another issue of his work in London in 1723. The chief edition since is that of J. A. Amar (5 vols., 1820), preceded by a notice of his life. M. A. de Latour published (1869) a useful though not complete edition, with notes and a biographical introduction.

ROUSSEAU, JEAN JACQUES (1712-1778), French philosopher, was born at Geneva on the 28th June 1712. His family had established themselves in that city at the time of the religious wars, but they were of pure French origin. Rousseau's father Isaac was a watchmaker; his mother, Suzanne Bernard, was the daughter of a minister; she died in childbirth, and Rousseau, who was the second son, was brought up in a haphazard fashion, his father being dissipated, violent-tempered and foolish. But he early taught his son to read, and seems to have laid the foundation of the flighty sentimentalism in morals and politics which Rousseau afterwards illustrated with his genius. When the boy was ten years old his father got entangled in a dispute with a fellow-citizen, and being condemned to a short term of imprisonment abandoned Geneva and took refuge at Lyons. The father and son henceforth rarely met. Rousseau was taken charge of by his mother's relations and was committed to the tutorage of M. Lambercier, pastor at Boissy. In 1724 he was removed from this school and taken into the house of his uncle Bernard, by whom he was shortly afterwards apprenticed to a notary. His master, however, found or thought him incapable and sent him back. After a short time (April 25, 1725) he was apprenticed afresh, this time to an engraver. He did not dislike the work, but was or thought himself cruelly treated. In 1728 he ran away, the truancy being by his own account unintentional in the first instance, and due to the fact of the city gates being shut earlier than usual. Then began an extraordinary series of wanderings and adventures, for much of which there is no authority but his own *Confessions*. He first fell in with some proselytizers of the Roman faith at Confignon in Savoy, and by them he was sent to Madame de Warens at Annecy, a young and pretty widow who was herself a convert. Her influence, however, which was to be so great, was not immediately exercised, and he was passed on to Turin, where there was an institution specially devoted to the reception of neophytes. His experiences here were unsatisfactory, but he abjured duly and was rewarded by being presented with twenty francs and sent about his business. He wandered about in Turin for some time, and at last established himself as footman to a Madame de Verceilis. Here occurred the famous incident of the theft of a ribbon, of which he accused a girl fellow-servant. But, though he kept his place by this piece of cowardice, Madame de Verceilis died not long afterwards and he was turned off. He found another place with the Comte de Gouvion, but lost this also through coxcombry. Then he resolved to return to Madame de Warens at Annecy. The chronology of all these events, as narrated by himself, is somewhat obscure, but they seem to have occupied about three years.

Even then Rousseau did not settle at once in the anomalous but to him charming position of domestic lover to this lady, who, nominally a converted Protestant, was in reality, as many

women of her time were, a kind of deist, with a theory of noble sentiment and a practice of libertinism tempered by good nature. It used to be held that in her conjugal relations she was more sinned against than sinning. But modern investigations seem to show that M. de Vuarrens (which is said to be the correct spelling of the name) was an unfortunate husband, and was deserted and robbed by his wife. However, she welcomed Rousseau kindly, thought it necessary to complete his education, and he was sent to the seminarists of St Lazare to be improved in classics, and also to a music master. In one of his incomprehensible freaks he set off for Lyons, and, after abandoning his companion in an epileptic fit, returned to Annecy to find Madame de Warens gone. Then for some months he relapsed into the life of vagabondage, varied by improbable adventures, which (according to his own statement) he so often pursued. Hardly knowing anything of music, he attempted to give lessons and a concert at Lausanne; and he actually taught at Neuchâtel. Then he became, or says he became, secretary to a Greek archimandrite who was travelling in Switzerland to collect subscriptions for the rebuilding of the Holy Sepulchre; then he went to Paris, and, with recommendations from the French ambassador at Soleure, saw something of good society; then he returned on foot through Lyons to Savoy, hearing that Madame de Warens was at Chambéry. This was in 1732, and Rousseau, who for a time had unimportant employments in the service of the Sardinian crown, was shortly installed by Madame de Warens, whom he still called Maman, as *amant en titre* in her singular household, wherein she diverted herself with him, with music and with chemistry. In 1736 Madame de Warens, partly for Rousseau's health, took a country house, Les Charmettes, a short distance from Chambéry. Here in summer, and in the town during winter, Rousseau led a delightful life, which he has delightfully described. In a desultory way he did a good deal of reading, but in 1738 his health again became bad, and he was recommended to go to Montpellier. By his own account this journey to Montpellier was in reality a *voyage à Cythère* in company with a certain Madame de Larnage. This being so, he could hardly complain when on returning he found that his official position in Madame de Warens's household had been taken by a person named Vintzenried. He was, however, less likely than most men to endure the position of second in command, and in 1740 he became tutor at Lyons to the children of M. de Mably, not the well-known writer of that name, but his and Condillac's elder brother. But Rousseau did not like teaching and was a bad teacher, and after a visit to Les Charmettes, finding that his place there was finally occupied, he once more went to Paris in 1741. He was not without recommendations. But a new system of musical notation which he thought he had discovered was unfavourably received by the Académie des sciences, where it was read in August 1742, and he was unable to obtain pupils. Madame Dupin, however, to whose house he had obtained the entry, procured him the honourable if not very lucrative post of secretary to M. de Montaigu, ambassador at Venice. With him he stayed for about eighteen months, and has as usual infinite complaints to make of his employer and some strange stories to tell. At length he threw up his situation and returned to Paris (1745).

Up to this time—that is to say, till his thirty-third year—Rousseau's life, though continuously described by himself, was of the kind called subterranean, and the account of it must be taken with considerable allowances. From this time, however, he is more or less in view; and, though at least two events of his life—his quarrel with Diderot and his death—are subjects of dispute, its general history can be checked and followed with reasonable confidence. On his return to Paris he renewed his relations with the Dupin family and with the literary group of Diderot, to which he had already been introduced by M. de Mably's letters. He had an opera, *Les Muses galantes*, privately represented; he copied music for money, and received from Madame Dupin and her son-in-law M. de Francueil a small but regular salary as secretary. He lived at the Hotel St Quentin for a time, and once more arranged for himself an equivocal

domestic establishment. His mistress, whom towards the close of his life he married after a fashion, was Thérèse le Vasseur, a servant at the inn, whom he first met in 1743. She had little beauty, no education or understanding, and few charms that his friends could discover, besides which she had a detestable mother, who was the bane of Rousseau's life. But he made himself happy with her, and (according to Rousseau's account, the accuracy of which has been questioned) five children were born to them, who were all consigned to the foundling hospital. This disregard of responsibility was partly punished by the use his critics made of it when he became celebrated as a writer on education and a preacher of the domestic affections.¹ Diderot, with whom from 1741 onwards he became more and more familiar, admitted him as a contributor to the *Encyclopédie*. He formed new musical projects, and he was introduced by degrees to many people of rank and influence, among them Madame d'Épinay (*q.v.*), to whom in 1747 he was introduced by her lover M. de Francueil. It was not, however, till 1749 that Rousseau made his mark as a writer. The academy of Dijon offered a prize for an essay on the effect of the progress of civilization on morals. Rousseau took up the subject, developed his famous paradox of the superiority of the savage state, won the prize, and, publishing his essay (*Discours sur les arts et sciences*) next year, became famous. The anecdote as to the origin of this famous essay is voluminous. It is agreed that the idea was suggested when Rousseau went to pay a visit to Diderot, who was in prison at Vincennes for his *Lettre sur les aveugles*. Rousseau says he thought of the paradox on his way down; Morellet and others say that he thought of treating the subject in the ordinary fashion and was laughed at by Diderot, who showed him the advantages of the less obvious treatment. Diderot himself, who in such matters is almost absolutely trustworthy, does not claim the suggestion, but uses words which imply that it was at least partly his. It is very like him. The essay, however, took the artificial and crotchety society of the day by storm. Francueil gave Rousseau a valuable post as cashier in the receiver-general's office. But he resigned it either from conscientiousness, or crotchet, or nervousness at responsibility, or indolence, or more probably from a mixture of all four. He went back to his music-copying, but the salons of the day were determined to have his society, and for a time they had it. In 1752 he brought out at Fontainebleau an operetta, the *Devin du village*, which was successful. He received a hundred louis for it, and he was ordered to come to court next day. This meant the certainty of a pension. But Rousseau's shyness or his perversity (as before, probably both) made him disobey the command. His comedy *Narcisse*, written long before, was also acted, but unsuccessfully. In the same year, however, a letter *Sur la musique française* again had a great vogue.² Finally, for this was an important year

¹ Apart from the fact that there were probably no children at all, the whole bearing of the belief of Rousseau that they were sent by him to the *Enfants trouvés* has been falsified by hostile writers. He was a penniless man of letters, with theories as to state maintenance of children; and Thérèse was a consenting party. Rousseau, however, never saw any of the alleged children; and Mrs Macdonald has shown good cause for believing that their existence was a myth, an imposition on Rousseau's credulity, invented by Thérèse and her mother to make the tie more binding. (H. Ch.)

² Rousseau's influence on French music was greater than might have been expected from his very imperfect education; in truth, he was a musician by natural instinct only, but his feeling for art was very strong, and, though capricious, based upon true perceptions of the good and beautiful. The system of notation (by figures) concerning which he read a paper before the Académie des Sciences, August 22, 1742, was ingenious, but practically worse than useless, and failed to attract attention, though the paper was published in 1743 under the title of *Dissertation sur la musique moderne*. In the famous "guerre des buffons," he took the part of the "buffonists," so named in consequence of their attachment to the Italian "opéra buffa," as opposed to the true French opera; and, in his *Lettre sur la musique française*, published in 1753, he indulged in a violent tirade against French music, which he declared to be so contemptible as to lead to the conclusion "that the French neither have, nor ever will have, any music of their own, or at least that, if they ever do have any, it will be so much the worse for them." This silly libel so enraged the performers at the Opera that they hanged and burned

with him, the Dijon academy, which had founded his fame, announced the subject of "The Origin of Inequality," on which he wrote a discourse which was unsuccessful, but at least equal to the former in merit. During a visit to Geneva in 1754 Rousseau saw his old friend and love Madame de Warens (now reduced in circumstances and having lost all her charms), while after abjuring his abjuration of Protestantism he was enabled to take up his freedom as citizen of Geneva, to which his birth entitled him and of which he was proud. Shortly afterwards, returning to Paris, he accepted a cottage near Montmorency (the celebrated Hermitage) which Madame d'Épinay had fitted up for him, and established himself there in April 1756. He spent little more than a year there, but it was an important year. Here he wrote *La Nouvelle Héloïse*; here he indulged in the passion which that novel partly represents, his love for Madame d'Huodetot, sister-in-law of Madame d'Épinay, a lady young and amiable, but plain, who had a husband and a lover (St Lambert), and whom Rousseau's devotion seems to have partly pleased and partly annoyed. Here too arose the obscure triangular quarrel between Diderot, Rousseau and Frederick Melchior Grimm, which ended Rousseau's sojourn at the Hermitage. The supposition least favourable to Rousseau is that it was due to one of his numerous fits of half-insane petulance and indignation at the obligations which he was nevertheless always ready to incur. That most favourable to him is that he was expected to lend himself in a more or less complaisant manner to assist and cover Madame d'Épinay's adulterous affection for Grimm. At any rate, Rousseau quitted the Hermitage in the winter of 1757-58, and established himself at Montlouis in the neighbourhood.

Hitherto Rousseau's behaviour had frequently made him enemies, but his writings had for the most part made him friends. The quarrel with Madame d'Épinay, with Diderot, and through them with the philosophe party reversed this. In 1758 appeared his *Lettre à D'Alembert contre les spectacles*, written in the winter of the previous year at Montlouis. This was at once an attack on Voltaire, who was giving theatrical representations at Les Délices, on D'Alembert, who had condemned the prejudice against the stage in the *Encyclopédie*, and on one of the favourite amusements of the society of the day. Voltaire's strong point was not forgiveness, and, though Rousseau no doubt exaggerated the efforts of his "enemies," he was certainly henceforward as obnoxious to the philosophe coterie as to the orthodox party. He still, however, had no lack of patrons—he never had—though his perversity made him quarrel with all in turn. The amiable duke and duchess of Luxembourg, who were his neighbours at Montlouis, made his acquaintance, or rather forced theirs upon him, and he was industrious in his literary work—indeed, most of his best books were produced during his stay in the neighbourhood of its author in effigy. Rousseau revenged himself by printing his clever satire entitled *Lettre d'un symphoniste de l'Académie Royale de Musique à ses camarades de l'orchestre*. His *Lettre à M. Burney* is of a very different type, and does full justice to the genius of Gluck. His article on music in the *Encyclopédie* did very superficially with the subject; and his *Dictionnaire de musique* (Geneva, 1767), though admirably written, is not trustworthy, either as a record of facts or as a collection of critical essays. In all these works the imperfection of his musical education is painfully apparent, and his compositions betray an equal lack of knowledge, though his refined taste is as clearly displayed there as is his literary power in the *Lettres* and *Dictionary*. His first opera, *Les Muses galantes*, privately prepared at the house of La Popellinière, attracted very little attention; but *Le Devin du village*, given at Fontainebleau in 1752, and at the Académie in 1753, achieved a great and well-deserved success. Though very unequal, and exceedingly simple both in style and construction, it contains some charming melodies, and is written throughout in the most refined taste. His *Pygmalion* (1775) is a melodrama without singing. Some posthumous fragments of another opera, *Daphnis et Chloé*, were printed in 1780; and in 1781 appeared *Les Consolations des misères de ma vie*, a collection of about one hundred songs and other fugitive pieces of very unequal merit. The popular air known as "Rousseau's Dream" is not contained in this collection, and cannot be traced back farther than J. B. Cramer's collected Variations. M. Castil-Blaze has accused Rousseau of extensive plagiarisms (or worse) in *Le Devin du village* and *Pygmalion*, but apparently without sufficient cause. (W. S. R.)

Montmorency. A letter to Voltaire on his poem about the Lisbon earthquake embittered the dislike between the two, being surreptitiously published. *La Nouvelle Héloïse* appeared in the same year (1760), and it was immensely popular. In 1762 appeared the *Contrat social* at Amsterdam, and *Émile*, which was published both in the Low Countries and at Paris. For the latter the author received 6000 livres, for the *Contrat* 1000.

Julie, ou La Nouvelle Héloïse, is a novel written in letters describing the loves of a man of low position and a girl of rank, her subsequent marriage to a respectable freethinker of her own station, the mental agonies of her lover, and the partial appeasing of the distresses of the lovers by the influence of noble sentiment and the good offices of a philanthropic Englishman. It is too long, the sentiment is overstrained, and severe moralists have accused it of a certain complaisance in dealing with amatory errors; but it is full of pathos and knowledge of the human heart. The *Contrat social*, as its title implies, endeavours to base all government on the consent, direct or implied, of the governed, and indulges in much ingenious argument to get rid of the practical inconveniences of such a suggestion. *Émile*, the second title of which is *De l'Éducation*, is much more of a treatise than of a novel, though a certain amount of narrative interest is kept up throughout.

Rousseau's reputation was now higher than ever, but the term of the comparative prosperity which he had enjoyed for nearly ten years was at hand. The *Contrat social* was obviously anti-monarchic; the *Nouvelle Héloïse* was said to be immoral; the sentimental deism of the "Profession du vicairé Savoyard" in *Émile* irritated equally the philosophe party and the church. On June 11, 1762, *Émile* was condemned by the parlement of Paris, and two days previously Madame de Luxembourg and the prince de Conti gave the author information that he would be arrested if he did not fly. They also furnished him with means of flight, and he made for Yverdon in the territory of Bern, whence he transferred himself to Motiers in Neuchâtel, which then belonged to Prussia. Frederick II. was not indisposed to protect the persecuted when it cost him nothing and might bring him fame, and in Marshal Keith, the governor of Neuchâtel, Rousseau found a true and firm friend. He was, however, unable to be quiet or to practise any of those more or less pious frauds which were customary at the time with the unorthodox. The archbishop of Paris had published a pastoral against him, and Rousseau did not let the year pass without a *Lettre à M. de Beaumont*. The council of Geneva had joined in the condemnation of *Émile*, and Rousseau first solemnly renounced his citizenship, and then, in the *Lettres de la montagne* (1763), attacked the council and the Genevan constitution unsparingly. All this excited public opinion against him, and gradually he grew unpopular in his own neighbourhood. This unpopularity is said on uncertain authority to have culminated in a nocturnal attack on his house. At any rate he thought he was menaced if he was not, and migrated to the Île St Pierre in the Lake of Bièvre, where he once more for a short, and the last, time enjoyed that idyllic existence which he loved. But the Bernese government ordered him to quit its territory. He was for some time uncertain where to go, and thought of Corsica (to join Paoli) and Berlin. But finally David Hume offered him, late in 1765, an asylum in England, and he accepted. He passed through Paris, where his presence was tolerated for a time, and landed in England on January 13, 1766. Thérèse travelled separately, and was entrusted to the charge of James Boswell, who had already made Rousseau's acquaintance. Here he had once more a chance of settling peaceably. Severe English moralists like Johnson thought but ill of him, but the public generally was not unwilling to testify against French intolerance, and regarded his sentimentalism with favour. He was lionized in London to his heart's content and discontent, for it may truly be said of Rousseau that he was equally indignant at neglect and intolerant of attention. When, after not a few displays of his strange humour, he professed himself tired of the capital,

Hume procured him a country abode in the house of Mr Davenport at Wootton in Derbyshire. Here, though the place was bleak and lonely, he might have been happy enough, and he actually employed himself in writing the greater part of his *Confessions*. But his habit of self-tormenting and tormenting others never left him. His own caprices interposed some delay in the conferring of a pension which George III. was induced to grant him, and he took this as a crime of Hume's. The publication of a spiteful letter (really by Horace Walpole, one of whose worst deeds it was) in the name of the king of Prussia made Rousseau believe that plots of the most terrible kind were on foot against him. Finally he quarrelled with Hume because the latter would not acknowledge all his own friends and Rousseau's supposed enemies of the philosophe circle to be rascals. He remained, however, at Wootton during the year and through the winter. In May 1767 he fled to France, addressing letters to the lord chancellor and to General Conway, which can only be described as the letters of a lunatic. He was received in France by the marquis de Mirabeau (father of the great Mirabeau), of whom he soon had enough, then by the prince de Conti at Trye. From this place he again fled and wandered about for some time in a wretched fashion, still writing the *Confessions*, constantly receiving generous help, and always quarrelling with, or at least suspecting, the helpers. In the summer of 1770 he returned to Paris, resumed music-copying, and was on the whole happier than he had been since he had to leave Montlouis. He had by this time married Thérèse le Vasseur, or had at least gone through some form of marriage with her.

Many of the best-known stories of Rousseau's life date from this last time, when he was tolerably accessible to visitors, though clearly half-insane. He finished his *Confessions*, wrote his *Dialogues* (the interest of which is not quite equal to the promise of their curious sub-title, *Rousseau juge de Jean Jacques*), and began his *Réveries du promeneur solitaire*, intended as a sequel and complement to the *Confessions*, and one of the best of all his books. It should be said that besides these, which complete the list of his principal works, he has left a very large number of minor works and a considerable correspondence. During this time he lived in the Rue Platière, which is now named after him. But his suspicions of secret enemies grew stronger rather than weaker, and at the beginning of 1778 he was glad to accept the offer of M. de Girardin, a rich financier, and occupy a cottage at Ermenonville. The country was beautiful; but his old terrors revived, and his woes were complicated by the alleged inclination of Thérèse for one of M. de Girardin's stable-boys. On July 2nd he died in a manner which has been much discussed, suspicions of suicide being circulated at the time by Grimm and others.¹

There is little doubt that for the last ten or fifteen years of his life, if not from the time of his quarrel with Diderot and Madame d'Épinay, Rousseau was not wholly sane—the combined influence of late and unexpected literary fame and of constant solitude and discomfort acting upon his excitable temperament so as to overthrow the balance, never very stable, of his fine and acute but unrobust intellect. He was by no means the only man of letters of his time who had to submit to something like persecution. Fréron on the orthodox side had his share of it, as well as Voltaire, Helvétius, Diderot and Montesquieu on that of the innovators. But Rousseau had not, like Montesquieu, a position which guaranteed him from serious danger; he was not wealthy like Helvétius; he had not the wonderful suppleness and trickiness which even without his wealth would probably have defended Voltaire himself; and he lacked entirely the "bottom" of Fréron and Diderot. When he was molested he could only shriek at his

¹ The local inquiry into the death, on the following day, resulted in a certificate that he died of apoplexy; but the story that he shot himself persisted. In December 1807 Rousseau's coffin in the Panthéon was opened, and M. Berthelot, who examined the skull, found no trace of injury by a bullet; and on the whole there is no reason to doubt the verdict of the original inquiry at Ermenonville.

enemies and suspect his friends. His moral character was undoubtedly weak in other ways than this, but it is fair to remember that but for his astounding *Confessions* the more disgusting parts of it would not have been known, and that these *Confessions* were written, if not under hallucination, at any rate in circumstances entitling the self-condemned criminal to the benefit of considerable doubt. If Rousseau had held his tongue, he might have stood lower as a man of letters; he would pretty certainly have stood higher as a man. He was, moreover, really sinned against, if still more sinning. The conduct of Grimm to him was certainly bad; and, though Walpole was not his personal friend, a worse action than his famous letter, considering the well-known idiosyncrasy of the subject, would be difficult to find. It was his own fault that he saddled himself with the Le Vasseurs, but their conduct was probably, if not certainly, ungrateful in the extreme. Only excuses can be made for him; but the excuses for a man born, as Hume after the quarrel said of him, "without a skin" are numerous and strong.

His peculiar reputation increased after his death. During his life his personal peculiarities and the fact that his opinions were nearly as obnoxious to the one party as to the other worked against him, but it was not so after his death. The men of the Revolution regarded him with something like idolatry, and his literary merits conciliated many who were far from idolizing him as a revolutionist. His style was taken up by Bernardin de Saint Pierre and by Chateaubriand. It was employed for purposes quite different from those to which he had himself applied it, and the reaction triumphed by the very arms which had been most powerful in the hands of the Revolution. Byron's fervid panegyric enlisted on his side all who admired Byron—that is to say, the majority of the younger men and women of Europe between 1820 and 1850—and thus different sides of his tradition were continued for a full century after the publication of his chief books. His religious unorthodoxy was condoned because he never scoffed; his political heresies, after their first effect was over, seemed harmless from the very want of logic and practical spirit in them, while part at least of his literary secret was the common property of almost every one who attempted literature.

In religion Rousseau was undoubtedly what he has been called above—a sentimental deist; but no one who reads him with the smallest attention can fail to see that sentimentalism was the essence, deism the accident of his creed. In his time orthodoxy at once generous and intelligent hardly existed in France. There were ignorant persons who were sincerely orthodox; there were intelligent persons who pretended to be so. But between the time of Massillon and D'Aguesseau and the time of Lamennais and Joseph de Maistre the class of men of whom in England Berkeley, Butler and Johnson were representatives did not exist in France. Little inclined by nature to any but the emotional side of religion, and utterly undisciplined in any other by education, course of life, or the general tendency of public opinion, Rousseau naturally took refuge in the nebulous kind of natural religion which was at once fashionable and convenient. If his practice fell far short even of his own arbitrary standard of morality, as much may be said of persons far more dogmatically orthodox.

In politics, on the other hand, Rousseau was a sincere and, as far as in him lay, a convinced republican. He had no great tincture of learning, he was by no means a profound logician, and he was impulsive and emotional in the extreme—characteristics which in political matters predispose the subject to the preference of equality above all political requisites. He saw that under the French monarchy the actual result was the greatest misery of the greatest number, and he did not look much further. The *Contrat social* is for the political student one of the most curious and interesting books existing. Historically it is null; logically it is full of gaping flaws, practically its manipulations of the *volonté de tous* and the *volonté générale* are clearly insufficient to obviate anarchy. But its mixture of real eloquence and apparent cogency is exactly such as

always carries a multitude with it, if only for a time. Moreover, in some minor branches of politics and economics Rousseau was a real reformer. Visionary as his educational schemes (chiefly promulgated in *Émile*) are in parts, they are admirable in others, and his protest against mothers refusing to nurse their children hit a blot in French life which is not removed yet, and has always been a source of weakness to the nation.

But it is as a literary man pure and simple—that is to say, as an exponent rather than as an originator of ideas—that Rousseau is most noteworthy, and that he has exercised most influence. The first thing noticeable about him is that he defies all customary and mechanical classification. He is not a dramatist—his work as such is insignificant—nor a novelist, for, though his two chief works except the *Confessions* are called novels, *Émile* is one only in name, and *La Nouvelle Héloïse* is as a story diffuse, prosy and awkward to a degree. He was without command of poetic form, and he could only be called a philosopher in an age when the term was used with such meaningless laxity as was customary in the 18th century. If he must be classed, he was before all things a describer—a describer of the passions of the human heart and of the beauties of nature. In the first part of his vocation the novelists of his own youth, such as Marivaux, Richardson and Prévost, may be said to have shown him the way, though he improved greatly upon them; in the second he was almost a creator. In combining the two and expressing the effect of nature on the feelings and of the feelings on the aspect of nature he was absolutely without a forerunner or a model. And, as literature since his time has been chiefly differentiated from literature before it by the colour and tone resulting from this combination, Rousseau may be said to hold, as an influence, a place almost unrivalled in literary history. The defects of all sentimental writing are noticeable in him, but they are palliated by his wonderful feeling, and by the passionate sincerity even of his insincere passages. Some cavils have been made against his French, but none of much weight or importance. And in such passages as the famous "Voilà de la pervenche" of the *Confessions*, as the description of the isle of St Pierre in the *Rêveries*, as some of the letters in the *Nouvelle Héloïse* and others, he had achieved absolute perfection in doing what he intended to do. The reader, as it has been said, may think he might have done something else with advantage, but he can hardly think that he could have done this thing better.

(G. SA.)

BIBLIOGRAPHY.—The dates of most of Rousseau's works published during his lifetime have been given above. The *Confessions* and *Rêveries*, which, read in private, had given much umbrage to persons concerned, and which the author did not intend to be published until the end of the century, appeared in Geneva in 1782. In the same year and the following appeared a complete edition in forty-seven small volumes. There have been many since, the most important of them being that of Musset-Pathay (Paris, 1823). Some unpublished works, chiefly letters, were added by Boscha (Paris, 1858) and Strecheisen Moulton (Paris, 1861). See also the latter's *Rousseau et ses amis* (1865). Works on Rousseau are innumerable. The chief biographies are: in French that of Saint Marc Girardin (1874), in English the *Life* by Viscount Morley. But the materials for his biography are so controversial and so personal—his own *Confessions* and the memoirs of associates whose accuracy and honesty are disputed—that the correct historical view can hardly be said yet to be standardized. Mrs Frederica Macdonald, in her *Jean Jacques Rousseau* (1906), makes out a good case for regarding Mme. d'Épinay's *Memoirs* as coloured, if not actually dictated, by the malevolent attitude of Grimm and Diderot; and her study of the documents undoubtedly qualifies a good many of the assumptions that have been made on the strength of evidence which is at least tainted by contemporary prejudice, and leaves the way open for an interpretation of the facts which would reconcile Rousseau's character as a writer with his actions as a man. Unfortunately for the consistency of historical writing, the view taken of Rousseau's biography affects those of Grimm, Diderot, Mme. d'Épinay and others, and while Mrs Macdonald's researches have done much to suggest a rehabilitation of Rousseau's veracity, they have not definitely been accepted to an extent which would justify the rewriting of these other lives in her sense. See also E. Ritter, *Famille et jeunesse de Rousseau* (1896); A. Houssey, *Les Charmettes* (2nd ed., 1864); J. Grand-Carteret, *Rousseau jugé par les Français d'aujourd'hui* (1890); L. Ducros, *J. J. Rousseau de Genève à l'Hermitage, 1712-57* (1908).

(H. CH.)

ROUSSEAU, PIERRE ÉTIENNE THÉODORE (1812-1867); French painter of the Barbizon school, was born in Paris on the 15th of April 1812, of a bourgeois family which included one or two artists. At first he received a business training, but soon displayed aptitude for painting. Although his father regretted the decision at first, he became reconciled to his son leaving business, and throughout the artist's career (for he survived his son) was a sympathizer with him in all his conflicts with the Salon authorities. Théodore Rousseau shared the difficulties of the romantic painters of 1830 in securing for their pictures a place in the annual Paris exhibition. The whole influence of the classically trained artists was against them, and not until 1848 was Rousseau adequately presented to the public. He had exhibited one or two unimportant works in the Salon of 1831 and 1834, but in 1836 his great work "La Descente des vaches" was rejected by the vote of the classic painters; and from then until after the revolution of 1848 he was persistently refused. He was not without champions in the press, and under the title of "le grand refusé" he became known through the writings of Thoré, the critic who afterwards resided in England and wrote under the name of Bürger. During these years of artistic exile Rousseau produced some of his finest pictures: "The Chestnut Avenue," "The Marsh in the Landes" (now in the Louvre), "Hoar-Frost" (now in America); and in 1851, after the reorganization of the Salon in 1848, he exhibited his masterpiece, "The Edge of the Forest" (also in the Louvre), a picture similar in treatment to, but slightly varied in subject from, the composition called "A Glade in the Forest of Fontainebleau," in the Wallace collection at Hertford House.

Up to this period Rousseau had lived occasionally at Barbizon, but in 1848 he took up his residence in the forest village, and spent most of his remaining days in the vicinity. He was now at the height of his artistic power, and was able to obtain fair sums for his pictures (but only about one-tenth of their value thirty years after his death), and his circle of admirers increased. He was still ignored by the authorities, for while Diaz was made Chevalier of the Legion of Honour in 1851, Rousseau was left undecorated at this time, but was nominated shortly afterwards. At the Exposition Universelle of 1855, where all Rousseau's rejected pictures of the previous twenty years were gathered together, his works were acknowledged to form one of the finest of the many splendid groups there exhibited. But during his lifetime Rousseau never really conquered French taste, and after an unsuccessful sale of his works by auction in 1861, he contemplated leaving Paris for Amsterdam or London, or even New York. Misfortune then overtook him: his wife, who had been a source of constant anxiety for years, became almost hopelessly insane; his aged father looked constantly to him for pecuniary assistance; his patrons were few. Moreover, while he was temporarily absent with his invalid wife, a youth living in his home (a friend of his family) committed suicide in his Barbizon cottage; when he visited the Alps in 1863, making sketches of Mont Blanc, he fell dangerously ill with inflammation of the lungs; and when he returned to Barbizon he suffered from insomnia and became gradually weakened. He was elected president of the fine art jury for the 1867 Exposition. His disappointment at being passed over in the distribution of the higher awards told seriously on his health, and in August he was seized with paralysis. He slightly recovered, but was again attacked several times during the autumn. Finally, in November, he began to sink, and he died, in the presence of his lifelong friend, J. F. Millet, on the 22nd of December 1867.

Rousseau's other friend and neighbour, Jules Dupré, himself an eminent landscape painter of Barbizon, relates the difficulty Rousseau experienced in knowing when his picture was finished, and how he, Dupré, would sometimes take away from the studio some canvas on which Rousseau was labouring too long. Millet, the peasant painter, for whom Rousseau had the highest regard, was much with him during the last years of his life, and at his death Millet took charge of the insane

wife. Rousseau was a good friend to Diaz, teaching him how to paint trees, for up to a certain point in his career Diaz considered he could only paint figures.

Rousseau's pictures are always grave in character, with an air of exquisite melancholy which is powerfully attractive to the lover of landscapes. They are well finished when they profess to be completed pictures, but Rousseau spent so long a time in working up his subjects that his absolutely completed works are comparatively few. He left many canvases with parts of the picture realized in detail and with the remainder somewhat vague; and also a good number of sketches and water-colour drawings. His pen work in monochrome on paper is rare; it is particularly searching in quality. There are a number of fine pictures by him in the Louvre, and the Wallace collection contains one of his most important Barbizon pictures. There is also an example in the Ionides collection at the Victoria and Albert Museum.

AUTHORITIES.—Alfred Sensier, *Souvenirs sur Th. Rousseau*, (Paris, 1872); E. Michel, *Les Artistes célèbres: Th. Rousseau*, (Paris, 1891); J. W. Mallet, *Rousseau and Diaz*, (London, 1890); D. Cross Thomson, *The Barbizon School of Painters: Th. Rousseau*, (London, 1892); Albert Wolf, *La Capitale de l'art: Th. Rousseau*, (Paris, 1886); E. Chesneau, *Peintres romantiques: Th. Rousseau*, (Paris, 1880); P. Burty, *Maitres et petit-maitres: Th. Rousseau*, (Paris, 1877).

(D. C. T.)

ROUSSEAU DE LA ROTTIÈRE, JEAN SIMÉON (b. 1747), French decorative painter, was the youngest son of Jules Antoine Rousseau, "sculpteur du Roi." The territorial addition to his patronymic has never been explained, but it is known to have been in use when he was little more than a boy. He studied at the Académie Royale, where we find him in September 1768 winning the medal given to the best painter of the quarter. He appears with his brother Jules Hugues to have been employed from an early date by his father for the decorative work executed by the family at Versailles. There has been some controversy among the authorities as to the respective shares of father and son in these works, but many of the attributions are fairly determined by dates, Jules Antoine Rousseau having been at work at Versailles for years before the birth of his famous son. The "Bains du Roi," the "Salon de la Méridienne," part of the bedchamber of Madame Adélaïde, and the "Garde-robe of Louis XVI." were among the achievements which there can be little doubt were shared in by Rousseau de la Rottière. His most individual and most famous undertaking was, however, the decoration of the lovely "Boudoir de Madame de Sévilly," now at the Victoria and Albert Museum. This little room, 14 ft. long, 10½ ft. wide and 16 ft. high, was removed from the house in the Rue de Saint Louis, in the Marais. The Seigneur de Sévilly, who was hereditary "Trésorier-général de l'Extraordinaire des guerres" under Louis XVI., married his cousin Anne Marie Louise de Pange, a favourite maid-of-honour of Marie Antoinette, and the story runs that his wife and the queen, desiring to give him a surprise, had the room decorated during his absence from Paris. It was purchased for the museum for 60,000 francs in 1860. The wall paintings of this sumptuous room came from the hand of Rousseau de la Rottière; the overdoor and part of the ceiling were executed by Lagrenée le jeune; the architect was Ledoux; the grey marble figures of aged men on either side of the fireplace were sculptured by Clodion; the mounts of the chimney-piece are apparently from the chisel of Gouthière. The date of the room is assigned to 1781-82, and Jean Siméon's authorship of much of its decoration is rendered certain by his own still existing sketch. The decoration is Pompeian in feeling, and in the main its taste is admirable; the execution is of the highest excellence. The tall narrow panels are painted in medallions with amorini; festoons and bouquets of flowers fill every available space; the shutters are painted with doves and shepherdesses. Lagrenée's pictures in the upper lunettes represent the elements; upon the ceiling is Jupiter enthroned within a deep blue border. The perfection of detail, the unity of the whole composition, the dexterity with which so small a chamber, lofty out of proportion to its length and width,

has been picked out with recessed arches, the tenderness of its scheme of colour, combine to produce an exquisite effect. It is a melancholy reflection that M. de Sévilly, whom his wife and Marie Antoinette combined to surprise with this *chef-d'œuvre*, was guillotined, and that his wife, whose sitting-room it was, was condemned to die with him and with Madame Elisabeth de France, whom they had befriended, but was saved, against her will, by the princess, who made a false declaration as to her condition. She had two subsequent husbands, and lost them both in little more than two years. She herself lived less than five years after her delivery by the fall of Robespierre. There is no information as to Rousseau's later life. The last known mention of him is in 1792.

ROUSSILLON, one of the old provinces of France. It now forms the greater part of the department of Pyrénées Orientales (*q.v.*). It was bounded S. by the Pyrenees, W. by the county of Foix, N. by Languedoc and E. by the Mediterranean. The province derived its name from a small place near Perpignan, the capital, called Ruscinon (Rosclionna, Castel Rossello), where the Gallic chieftains met to consider Hannibal's request for a conference. The district formed part of the Roman province of Gallia Narbonensis from 121 B.C. to A.D. 462, when it was ceded with the rest of Septimania to Theodoric II., king of the Visigoths. His successor, Amalric, on his defeat by Clovis in 531 retired to Spain, leaving a governor in Septimania. In 719 the Saracens crossed the Pyrenees, and Septimania was held by them until their defeat by Pippin in 756. On the invasion of Spain by Charlemagne in 778 he found the borderlands wasted by the Saracenic wars, and the inhabitants hiding among the mountains. He accordingly made grants of land to Visigothic refugees from Spain, and founded several monasteries, round which the people gathered for protection. In 792 the Saracens again invaded France, but were repulsed by Louis, king of Aquitaine, whose rule extended over all Catalonia as far as Barcelona. The different portions of his kingdom in time grew into allodial fiefs, and in 893 Suniaria II. became the first hereditary count of Roussillon. But his rule only extended over the eastern part of what became the later province. The western part, or Cerdagne, was ruled in 900 by Miron as first count, and one of his grandsons, Bernard, was the first hereditary count of the middle portion, or Bésalu. In 1111 Raymond-Bérengrer III., count of Barcelona, inherited the fief of Bésalu, to which was added in 1117 that of Cerdagne; and in 1172 his grandson, Alfonso II., king of Aragon, united Roussillon to his other states on the death of the last count, Gerard II. The counts of Roussillon, Cerdagne and Bésalu were not sufficiently powerful to indulge in any ways of ambition. Their energies had been devoted to furthering the welfare of their people. Under the Aragonese monarchs the progress of the united province still continued, and Collioure, the port of Perpignan, became a centre of Mediterranean trade. But the country was destined to pay the penalty of its position on the frontiers of France and Spain in the long struggle for ascendancy between these two powers. By the treaty of Corbeil (1258) Louis IX. surrendered the sovereignty of Roussillon and the ancient countship of Barcelona to Aragon, and from that time until the 17th century the province ceased to belong to France. James I. of Aragon had wrested the Balearic Isles from the Moors and left them with Roussillon to his son James (1276), with the title of king of Majorca. The consequent disputes of this monarch with his brother Pedro III. of Aragon were not lost sight of by Philip III. of France in his quarrel with the latter about the crown of the Two Sicilies. Philip espoused James's cause and led his army into Spain, but retreating died at Perpignan in 1285. James then became reconciled to his brother, and in 1311 was succeeded by his son Sancho, who founded the cathedral of Perpignan shortly before his death in 1324. His successor James II. refused to do homage to Philip VI. of France for the signory of Montpellier, and applied to Pedro IV. of Aragon for aid. Pedro not only refused it, but on various pretexts declared war against him, and seized Majorca and Roussillon in 1344. The province was now again united to Aragon, and enjoyed peace

until 1462. In this year the disputes between John II. and his son about the crown of Navarre gave Louis XI. of France an excuse to support John against his subjects, who had risen in revolt. Louis turned traitor, and the province having been pawned to him for 300,000 crowns, was occupied by the French troops until 1493, when Charles VIII. restored it to Ferdinand and Isabella. During the war between France and Spain (1496-98) the people suffered equally from the Spanish garrisons and the French invaders. But dislike of the Spaniards was soon effaced in the pride of sharing in the glory of Charles V., and in 1542, when Perpignan was besieged by the dauphin, the Roussillonais remained true to their allegiance. Afterwards the decay of Spain was France's opportunity, and on the revolt of the Catalans against the Castilians in 1641, Louis XIII. espoused the cause of the former, and the treaty of the Pyrenees in 1659 secured Roussillon to the French crown.

BIBLIOGRAPHY.—*Privileges et titres relatifs aux franchises, institutions et propriétés communales du Roussillon et de la Cerdagne depuis le XI^e siècle jusqu'en 1600* (1878); Auguste Brutaillis, *Étude sur la condition des populations rurales du Roussillon au moyen âge* (1891). See also the publications of the *Société agricole, scientifique et littéraire des Pyrénées Orientales* (1834 fol.).

ROUTH, EDWARD JOHN (1831-1907), English mathematician, was born at Quebec on the 20th of January 1831. At the age of eleven he came to England, and after studying under A. de Morgan at University College, London, entered Peterhouse, Cambridge, in 1851. In the mathematical tripos three years later he was senior wrangler, beating J. Clerk Maxwell, who, however, tied with him for the Smith's prize. Elected a fellow of his college, he devoted himself to teaching, and quickly proved himself one of the most successful mathematical "coaches" ever known at Cambridge. In thirty years, of some 700 pupils who passed through his hands 500 became wranglers; and for twenty-two successive years, from 1861 to 1882, the senior wrangler was trained by him. He made considerable contributions to scientific literature, and among his publications were: *An Analytical View of Newton's Principia*, with Lord Brougham (1855); *An Essay on the Stability of a given State of Motion*, which won the Adams' prize in 1877; and treatises on the *Dynamics of Rigid Bodies*, on *Analytical Statics*, and on the *Dynamics of a Particle*. He died at Cambridge on the 7th of June 1907.

ROUTH, MARTIN JOSEPH (1755-1854), English classical scholar, was born at South Elmham, Suffolk, on the 18th of September 1755. He was educated at Queen's College, Oxford, and subsequently elected to a fellowship at Magdalen, of which society he became president in 1791. He died at Oxford on the 22nd of December 1854, and retained his physical and intellectual powers to the last. He was the author of editions of the *Euthydemus* and *Gorgias* of Plato (1784), to which Dindorf declared himself indebted for his first ideas of Greek criticism, and of Bishop Burnet's *History of his Own Time* (2nd ed., 1833) and *History of the Reign of King James the Second* (1852). Routh was also an authority on patristic literature, his *Reliquiae Sacrae* (2nd ed., 1846-48), a collection of the fragments of the Fathers of the 2nd and 3rd centuries, and *Scriptorum ecclesiasticorum opuscula praecipua quaedam* (2nd ed., 1840) being valuable contributions to ecclesiastical knowledge.

See *Gentleman's Magazine*, 1855; J. W. Burgon, *Lives of Twelve Good Men* (1888).

ROUTLEDGE, GEORGE (1812-1888), English publisher, was born at Brampton in Cumberland on the 23rd of September 1812. He gained his earliest experience of business with a bookseller at Carlisle. Proceeding to London in 1833, he started in business for himself as a bookseller in 1836, and as a publisher in 1843, making his first serious success by reprinting the Biblical commentaries of an American writer, Albert Barnes. His fame as a publisher, however, rests chiefly upon the enormous number of cheap books which he issued. A series of shilling volumes called the "Railway Library" was an immense success, including as it did Mrs Harriet Beecher Stowe's *Uncle Tom's Cabin*, and he also published in popular

form some of the writings of Washington Irving, Fenimore Cooper, Bulwer Lytton and Benjamin Disraeli. He also brought out a number of shilling books in "Routledge's Universal Library." Routledge died in London on the 13th of December 1888. After being styled Routledge, Warne & Routledge, his firm changed its name to that of George Routledge & Sons. A branch of the business was established in New York in 1854.

ROUVIER, MAURICE (1842-), French statesman, was born at Aix on the 17th of April 1842, and spent the early years of his manhood in business at Marseilles. He supported Gambetta's candidature there in 1867, and in 1870 he founded an anti-imperial journal, *L'Égalité*. Becoming secretary general of the prefecture of Bouches-du-Rhône in 1870-71, he refused the office of prefect. In July 1871 he was returned to the National Assembly for Marseilles at a by-election, and voted steadily with the Republican party. He became a recognized authority on finance, and repeatedly served on the Budget Commission as reporter or president. At the general elections of 1881 after the fall of the Ferry cabinet he was returned to the chamber on a programme which included the separation of Church and State, a policy of decentralization, and the imposition of an income-tax. He then joined Gambetta's cabinet as minister of commerce and the colonies, and in the 1883-85 cabinet of Jules Ferry he held the same office. He became premier and minister of finance on the 31st of May 1887, with the support of the moderate republican groups, the Radicals holding aloof in support of General Boulanger, who began a violent agitation against the government. Then came the scandal of the decorations in which President Grévy's son-in-law Daniel Wilson figured, and the Rouvier cabinet fell in the attempt to screen the president. Rouvier's opposition in his capacity of president of the Budget Commission was one of the causes of the defeat of the Floquet cabinet in February 1889. In the new Tirard ministry formed to combat the Boulangerist agitation he was minister of finance. This portfolio he retained consecutively in the Freycinet, the Loubet and the Ribot cabinets, 1890-93. His relations with Cornélius Herz and the baron de Reinach compelled his retirement, however, from the Ribot cabinet at the time of the Panama scandals in December 1892. Again, in 1902, he became minister of finance, after nearly ten years in exclusion from office, in the Radical cabinet of M. Combes; and on the fall of the Combes ministry in January 1905 he was invited by the president to form a new ministry. In this cabinet he at first held the ministry of finance. In his initial declaration to the chamber the new premier had declared his intention of continuing the policy of the late cabinet, pledging the new ministry to a policy of conciliation, to the consideration of old age pensions, an income-tax, separation of Church and State. Public attention, however, was chiefly concentrated on foreign policy. During the Combes ministry M. Delcassé had come to a secret understanding with Spain on the Moroccan question, and had established an understanding with England. His policy had aroused German jealousy, which became evident in the asperity with which the question of Morocco was handled in Berlin. At a cabinet meeting on June 5th it is said that M. Rouvier reproached the Foreign Minister with imprudence in the matter of Morocco, and after a heated discussion M. Delcassé gave in his resignation. M. Rouvier himself took the portfolio of foreign affairs at this anxious juncture. He, after critical negotiations, secured on July 8th an agreement with Germany accepting the international conference proposed by the sultan of Morocco on the assurance that Germany would recognize the special nature of the interest of France in maintaining order on the frontier of her Algerian empire. Lengthy discussions resulted in a new convention in September, which contained the programme of the proposed conference, and in December M. Rouvier was able to make a statement of the whole proceedings in the chamber, which received the assent of all parties. M. Rouvier's government did not long survive the presidential election of 1906. The disturbances arising

in connexion with the Separation Law were skillfully handled by M. Clemenceau to discredit the ministry, which gave place to a cabinet under the direction of M. Sarrien.

ROVERETO, the most important industrial town in the southern or Italian-speaking portion of the Austrian province of Tirol, though its population (which in 1900 was 10,180, Italian-speaking and Romanist) is less than that of Trent. It is also the principal town of the administrative district of Rovereto. Built on the left bank of the Adige, in the widest portion of the Val Lagarina (the name given to the Adige valley from Acquaviva, above Rovereto, to the Italian frontier), it is divided into two parts by the Leno torrent. It is on the Brenner railway, by which it is 15 m. S.W. of Trent and 4½ m. N. of Verona. Save in the newer quarter of the town, the streets are narrow and crooked, several being named after the most distinguished native of the place, Antonio Rosmini-Serbati (q.v.). The finest church is that of Santa Maria del Carmine, the old 14th-century church now serving as a sacristy to that built from 1678 to 1750. The church of San Marco dates from the 15th century. The town is dominated by the castle (now used as barracks), which was reconstructed in 1492 by the Venetians, after it had been burnt in 1487 by the count of Tirol. The staple silk industry (which dates from the 16th century) has declined, the number both of *filande* (establishments wherein the cocoons are unwound) and of *filatoje* (those wherein the silk is spun) having diminished.

In 1132 the emperor Lothair found the passage of the gorge above the site of the town barred by a castle, which he took and gave to one of his Teutonic followers, the ancestor of the Castelbarco family. Towards the middle of the 13th century that family obtained by marriage the lands of the Lizzana family (whose castle rises S. of the town), and in 1300 practically founded the town and surrounded it with walls. In 1416 it was taken by the Venetians, who in 1487 successfully resisted, at Calliano, an attempt to take it made by the count of Tirol and the bishop of Trent. In 1509, at the outset of the war of the League of Cambray, the town gave itself voluntarily to the emperor Maximilian, to whom it was ceded formally by Venice in 1517, and next year incorporated with Tirol. South of Rovereto is the village of Marco, near which are certain natural remains (either those of a landslide that occurred in 883, or of a glacial moraine) believed to have been described by Dante (*Inf.* xii. 4-9), who is said to have spent part of the year 1304, during his exile from Florence, in the castle of Lizzana, between Marco and Rovereto. (W. A. B. C.)

ROVIGNO, a seaport of Austria, in Istria, 75 m. S. of Trieste by rail. Pop. (1900) 10,205, mostly Italian. It is situated on the west coast of Istria, and possesses an interesting cathedral, built on the summit of the promontory Monte di Sant' Eufemia. Its campanile, built after the model of the famous campanile in Venice, is crowned with a bronze statue of St Eufemia, the patron saint of the town, whose remains are preserved in the church. It contains a station of the Berlin Aquarium, with a fine collection of the fauna of the Adriatic Sea. In the neighbourhood are vineyards, which produce the best wine in Istria, and olive gardens, while its hazel-nuts are reputed the finest in the world. Rovigno is the principal centre of the Austrian tunny and sardine fishery. The industries, in addition to ship-building and the preservation of fish, include the manufacture of tobacco, cement, macaroni and similar preparations, and flour. There is an active export trade. Its inhabitants are renowned seamen. Rovigno is the ancient *Arupenum* or *Rubinum*, and according to tradition it was originally built on an island, Cissa by name, which disappeared during the earthquakes about 737. Rovigno passed definitively into the hands of the Venetians in 1330, and it remained true to the republic till the treaty of Campo Formio (1797).

ROVIGO, a town of Venetia, Italy, capital of the province of Rovigo. It stands on the low ground between the lower Adige and the lower Po, 50 m. by rail S.W. of Venice and 27 m. S.S.W. of Padua, and on the Adigetto Canal, 17 ft. above sea-level. Pop. (1901) 6038 (town); 10,735 (commune). It is a station

on the line between Bologna and Padua, with branches to Legnago and Chioggia. The architecture of the town bears the stamp both of Venetian and of Ferrarese influence. The cathedral church of Santo Stefano (1606) is of less interest than La Madonna del Soccorso, an octagon with a fine campanile, begun in 1504 by Francesco Zamberlano of Bassano, a pupil of Palladio. The town hall contains a library including some rare early editions, belonging to the Accademia de' Concordi, founded in 1580, and a fair picture gallery enriched with the spoils of the monasteries. The Palazzo Roncali is a fine Renaissance building by Sanmicheli (1555). Two towers of its medieval castle remain. Wool, silk, linen and leather are among the local manufactures.

Rovigo (Neo-Latin *Rhodigium*) appears to be mentioned as Rodigo in 838. It was selected as his residence by the bishop of Adria on the destruction of his city by the Huns. From the 11th to the 14th century the Este family was usually in authority; but the Venetians took the place by siege in 1482 and retained possession of it by the peace of 1484, and though the Este more than once recovered it, the Venetians, returning in 1514, retained possession till the French Revolution. In 1806 the city was made a duchy in favour of General Savary. The Austrians in 1815 created it a royal city. (T. AS.)

ROVUMA, a river in East Africa, forming during the greater part of its course the boundary between German and Portuguese territory. The lower Rovuma is formed by the junction in 11° 25' S., 38° 31' E. of two branches of nearly equal importance, the longer of which, the Lujenda, comes from the south-west, the other, which still bears the name Rovuma, from the west. Its source lies on an undulating plateau, 3000 ft. high, immediately to the east of Lake Nyasa, in 10° 45' S., 35° 40' E., the head-stream flowing first due west before turning south and east. In its eastward course the Rovuma flows near the base of the escarpment of an arid sandstone plateau to the north, from which direction the streams, which have cut themselves deep channels in the plateau edge, have almost all short courses. On the opposite bank the Rovuma receives, besides the Lujenda, the Msinje and Luchulingo, flowing in broad valleys running from south to north. The Lujenda rises in close proximity to Lake Chilwa, in the small Lake Chiuta (1700 ft.), the swamps to the south of this being separated from Chilwa only by a narrow wooded ridge. The stream which issues from Chiuta passes by a swampy valley into the narrow Lake Amaramba, from which the Lujenda finally issues as a stream 80 yds. wide. Lower down it varies greatly in width, containing in many parts long wooded islands which rise above the flood level, and are often inhabited. The river is fordable in many places in the dry season. At its mouth it is about a mile wide. The lower Rovuma, which is often half a mile wide but generally shallow, flows through a swampy valley flanked by plateau escarpments containing several small backwaters of the river. The mouth, which lies in 10° 28' S., 40° 30' E., is entirely in German territory, the boundary near the coast being formed by the parallel of 10° 40'. The length of the Rovuma is about 500 m.

ROW, JOHN (c. 1525-1580), Scottish reformer, was born near Stirling and educated in that town and at St Andrews, where he began to practise as an advocate in the consistorial court. In 1550 he was sent to Rome in the interests of John Hamilton, archbishop of St Andrews, and attracted the notice of the highest authorities, who, when his failing health drove him back to Scotland in 1558, nominated him papal nuncio to inquire into the spread of heresy in that country. That inquiry ultimately led him to change his faith. Much influenced by Knox's preaching, he joined the reformers and in April 1560 was admitted minister of Kennoway in Fife, and in July of the same year minister of the Old or Middle Church at Perth. He was one of the commission of six who drew up the "Confession of Faith" and the "First Book of Discipline," and during the struggle with Queen Mary was often employed on important engagements. He was moderator of the Church Assembly at Edinburgh in July 1567 and at Perth in the follow-

ing December, and again in Edinburgh 1576 and Stirling 1578. Meanwhile he helped to compile the "Second Book of Discipline," and became more than ever opposed to the Episcopal system of church government. He was a considerable scholar and is said to have been the first to teach Hebrew in Scotland. He died at Perth on the 16th of October 1580.

His son JOHN ROW (1568-1646), minister of Carnock, wrote a *Historie of the Kirk of Scotland 1558 to 1637*, which was continued to 1630 by his son, the third John Row (c. 1598-c. 1672), rector of the Perth grammar school and then (appointed by Cromwell) principal of King's College, Aberdeen, who, with his father and grandfather was a famous Hebraist, but left the Church of Scotland to become an Independent minister. This *Historie* was published by the Wodrow Society and by the Maitland Club in 1842.

ROWE, NICHOLAS (1674-1718), English dramatist and miscellaneous writer, son of John Rowe (d. 1692), barrister and serjeant-at-law, was baptized at Little Barford in Bedfordshire on the 30th of June 1674. Nicholas Rowe was educated at Westminster School under Dr Busby. He became in 1688 a King's Scholar, and entered the Middle Temple in 1691. On his father's death he became the master of an independent fortune. His first play, *The Ambitious Stepmother*, the scene of which is laid in Persepolis, was produced in 1700, and was followed in 1702 by *Tamerlane*. In this play the conqueror represented William III., and Louis XIV. is denounced as Bajazet. It was for many years regularly acted on the anniversary of William's landing at Torbay. *The Fair Penitent* (1703), an adaptation of Massinger and Field's *Fatal Downy*, was pronounced by Dr Johnson to be one of the most pleasing tragedies in the language. In it occurs the famous character of Lothario, whose name passed into current use as the equivalent of a rake. Calista is said to have suggested to Samuel Richardson the character of Clarissa Harlowe, as Lothario suggested Lovelace. In 1704 Rowe tried his hand at comedy, producing *The Biter* at Lincoln's Inn Fields. The play is said to have amused no one except the author, and Rowe returned to tragedy in *Ulysses* (1706). *The Royal Convert* (1707) dealt with the persecutions endured by Aribert, son of Hengist and the Christian maiden Ethelinda. *The Tragedy of Jane Shore*, which was played at Drury Lane with Mrs Oldfield in the title rôle in 1714, ran for nineteen nights, and kept the stage longer than any of his other works. *The Tragedy of Lady Jane Grey* followed in 1715. Rowe's friendship with Pope, who speaks affectionately of his vivacity and gaiety of disposition, led to attacks inspired by the publisher Edmund Curll, the best known of these being *The New Rehearsal*, or *Bays the Younger, containing an Examen of Seven of Rowe's Plays*, by Charles Gildon. Rowe acted as under-secretary (1709-11) to the duke of Queensberry when he was principal secretary of state for Scotland. On the accession of George I. he was made a surveyor of customs, and in 1715 he succeeded Nahum Tate as poet laureate. He was also appointed clerk of the council to the prince of Wales, and in 1718 was nominated by Lord Chancellor Parker as clerk of the presentations in Chancery. He died on the 6th of December 1718, and was buried in Westminster Abbey. He was twice married, and his widow received a pension from George I. in 1719 in recognition of her husband's translation of Lucan. This verse translation, or rather paraphrase of the *Pharsalia*, was called by Samuel Johnson "one of the greatest productions in English poetry," and was widely read, running through eight editions between 1718 and 1807.

Rowe was the first modern editor of Shakespeare. It is unfortunate that he based his text (6 vols., 1709) on the corrupt Fourth Folio, a course in which he was followed by later editors. We owe to him the preservation of a number of Shakespearian traditions, collected for him at Stratford by Thomas Betterton. These materials he used with considerable judgment in the memoir prefixed to the *Works*. Moreover, his practical knowledge of the stage suggested technical improvements. He divided the play into acts and scenes on a reasonable method,

noted the entrances and exits of the players, and prefixed a list of the *dramatis personae* to each play. Rowe wrote occasional verses addressed to Godolphin and Halifax, adapted some of the odes of Horace to fit contemporary events, and translated the *Caractères* of La Bruyère and the *Callipædia* of C. Quillet. He also wrote a memoir of Boileau prefixed to a translation of the *Lutrin*.

Rowe's *Works* were printed in 1727, and in 1736, 1747, 1756, 1766 and 1792; his occasional poems are included in Anderson's and other collections of the British poets.

ROWEL (from O. Fr. *rouel* or *roel*, dim. of *roue*, Lat. *rota*, wheel), the name of the small revolving wheel or disk with radiating points forming the termination of a rider's spur. The earliest rowels probably did not revolve but were fixed. They appear on monuments of the 13th century, as in the great seal of Henry III. of England, but the older "prick" spurs remained the standard form till the 14th century (see *SPUR*). In veterinary science, the word is used of a small disk of leather or other material used as a seton.

ROWING (O. Eng. *rōwan*, to row, cf. Lat. *remus*, Gr. *ῥομβός*, oar), the act of driving forward or propelling a boat (*q.v.*) along the surface of the water by means of oars.

History.—The earliest historical records describe battles and voyages in which the ships were propelled by oars. There must, of course, have been from time to time friendly trials of speed between these ancient craft, such as that described by Virgil in the fifth book of the *Aeneid*, but there is no record in classical or even in medieval times of rowing having been indulged in solely as a recreation, or as a means of promoting athletic contest. The absence of any element of competition is sufficient to account for the fact that the boats, the oars, and the method of rowing of the 17th century differed but little from those of the earliest times.

The history of Great Britain abounds in instances of the use of the oar. The ancient Britons propelled themselves in coracles of wickerwork covered with skins, by means of paddles rather than oars, but the Saxons were expert oarsmen, as also were the Danish and Norwegian invaders. It is recorded by William of Malmesbury that Edgar the Peaceable was rowed in state on the river Dee by eight tributary kings, himself acting as coxswain.

During the 11th and 12th centuries, when roads were often impassable, considerable use was made of the various rivers of England for the transmission of both passengers and merchandise; and, until the introduction of coaches, the nobility and gentry who had mansions and watergates on the banks of the Thames relied almost entirely upon their boats and elaborately fitted barges as a means of conveyance from place to place.

This use of boats and barges as a means of conveyance for merchandise and passengers provided a means of livelihood for a class of professional oarsmen known as bargemen or watermen. They were professionals, not in the sense of professional athletes, but because they made their living by rowing and navigating passenger and other craft along and across the Thames. Watermen as a class are mentioned in history as early as the 13th century. The distress occasioned to them by the long frosts is referred to in the chronicles of that period. They are mentioned as having been employed to row the barons and their retinues to Runnymede for the signing of the Magna Carta by King John, and about the same time several of the city companies established barges for the purposes of processions and other pageants upon the Thames. It is stated by Fabian that in 1454 "Sir John Norman, then lord mayor of London, built a noble barge at his own expense and was rowed by watermen with silver oars, attended by such of the city companies as possessed barges, in a splendid manner." The lord mayor's procession by water to Westminster was annual until 1856, the state barge of the lord mayor being a magnificent species of shallow rowed by watermen, while those of the city companies were propelled by a double bank of oars in the fore half, the after part consisting

of a cabin which somewhat resembled that of a gondola. In 1514 and in 1555 acts of parliament were passed for the regulation of watermen and their boats and fares upon the Thames (7 Henry VIII. cap. vii. and 2 and 3 Ph. & Mar. cap. xvi.), and from the terms of these statutes there can be no doubt that there were in the 15th century a considerable body of men who lived by the "trade of Rowing" as it is there called. During the 16th and 17th centuries there were no doubt competitions from time to time between these watermen, but the first actual mention of boat-racing is the record of the establishment in 1715 of Doggett's Coat and Badge. Mr Thomas Doggett, who may fairly be described as the founder of modern boat-racing, was a celebrated comedian. He established a fund to provide an annual prize of a waterman's coat with a large silver badge on the arm. The race was founded in honour of the house of Hanover and to commemorate the anniversary of "King George I.'s happy accession to the throne of Great Britain." The contest was to take place at the beginning of August and on the Thames between six young watermen who were not to have exceeded the time of their apprenticeship by more than twelve months. Although the first race took place in 1715 the names of the winners have only been preserved since 1791. Doggett's Coat and Badge is still an annual event, the conditions as to boats to be used and other details having been slightly modified. It is entirely controlled and managed by the Fishmongers' Company.

The first English regatta (Ital. *regata*)—an entertainment introduced, as the *Annual Register* records, from Venice—of which we have evidence, took place on the Thames off Raenelagh Gardens in 1775. Great public interest seems to have been taken in the spectacular aspect of this pageant, the barges of the lord mayor and the city companies being present, but there is no record of the competing wager boats or of the names of the watermen who took part in the races.

About the years 1800 to 1810 there are instances of matches between watermen for stakes presented by gentlemen who no doubt made wagers upon the result, and from these professional wager matches it was but a short step to sporting matches between the gentlemen themselves. When once the "gentleman amateur," as he was called, appeared, his evolution, from the sportsman who occasionally rowed a match against a friend, or against time, for a wager, to the amateur oarsman of the present day, was not slow. The amateur rowing which began about the year 1800 on the Thames at Westminster has flourished as a branch of athletic sport, and has spread to every quarter of the globe.

Rowing in the United Kingdom.—The earliest rowing clubs in England were small groups of oarsmen who combined to purchase a six-oared or eight-oared boat for the purpose of racing. The club was called by the same name as the ship it possessed, and at the commencement of the 19th century the principal clubs in existence upon the Thames were the "Star," the "Arrow," the "Shark" and the "Siren." The two latter have long since disappeared, but the "Star" and the "Arrow" combined about the year 1818 and founded the Leander Club, an institution which after varying fortunes has for many years been recognized as the premier rowing club of the world.

The earliest contemporary record of boat-racing is the Water Ledger of Westminster School, which commences in the year 1813 with a list of the crew of the six-oared boat "Fly." In 1811 Eton had a ten-oared boat and three boats with eight oars, but there is no existing record of a race until 1817. In 1818 Eton challenged Westminster School to row from Westminster to Kew Bridge against the tide; but the race was stopped by the authorities, and it was not until 1829 that the first contest between the two schools took place. Between 1829 and 1847 there were eight matches between Eton and Westminster. The race was revived for a few years in the sixties, and in the year 1868 the state of the lower tideway was such that the Westminster boys moved their boathouse first to Wandsworth and then to Putney. This arrangement was found to be inconvenient, and shortly afterwards Westminster rowing came to an

end. Eton rowing, on the other hand, has continued to prosper, and for many years it has been the greatest "nursery" of first-class oarsmen. Since 1861 the Eton College Boat Club has never failed to enter a crew at Henley Regatta.

At Oxford the records of periodical races between college boats begin as early as 1815, and those of Cambridge a few years later. The first contest between eight-oared crews representing the two universities took place at Henley-on-Thames in June 1829. The second contest was not until 1836, and was rowed from Westminster to Putney. In 1837 and 1838 the universities were unable to make a match, and in each of those years a race was rowed between Cambridge and the Leander Club, which had thus early become the premier club of the tideway. It was not always easy in the early days of boat-racing for the university boat clubs to agree as to the conditions and time of the match, but on several occasions when the universities had been unable to meet on the tideway they fought their battle whilst competing for the Grand Challenge Cup at Henley Regatta. Since 1856 the Oxford and Cambridge boat race has been an annual event. It is rowed about a week or ten days before Easter from Putney to Mortlake over what is known as the championship course, a distance of $4\frac{1}{2}$ m. The race is rowed with the flood-tide, and occupies as a rule a time varying between 19 and 22 min. The time occupied by a crew in covering this course depends a great deal more upon the conditions of wind and tide than upon the excellence, or the reverse, of the crew. The crew of each university is selected by a president, usually one of the senior members of the last crew, who is elected at the first meeting in the summer term and holds office for a year. Thus the university race comes at the end of his term of office, and he has every opportunity during the summer and autumn of studying the material which will be at his disposal for the formation of a crew in the ensuing spring. The aquatic arrangements at the two universities are very much alike. The university year begins in October. During the winter term the freshmen are instructed in the elements of rowing, while the senior men are engaged in practising for the University (inter-collegiate) Fours, a race which takes place early in November. During the latter portion of the term the president of the University Boat Club is engaged in selecting and coaching the trial eights, two picked crews comprising the bulk of the material available for the formation of the university crew. The trial eight races are rowed in the beginning of December, that of Cambridge on the Ouse at Ely, and that of Oxford on the Thames at Moulford, neither the Cam nor the Isis being wide enough for two crews to race abreast. During the whole of the Easter term the university crews are engaged in practice and training for the University Boat Race. The attention of the remainder of the rowing men at the universities is devoted to training for the bumping races known at Oxford and Cambridge respectively as the *Torpids* and *Lent Races*. Each college is represented in these races, and no oarsman who has rowed in the first boat of his college during the previous summer is qualified to compete. The boats start at fixed distances apart, and each boat endeavours to bump the boat in front of it, and to avoid being bumped by the boat behind. When a bump is effected, the two boats involved draw to the side, and the next night the successful boat starts in front of its victim. Each spring the boats start in the order in which they finished the previous year. The races last for six nights at Oxford and four at Cambridge. In the summer term the important bumping races between the best crews of each college take place. They are known as "The Eights" at Oxford and "The May Races" at Cambridge. To attain the position of "Head of the River" in these races is the summit of a college boat club's ambition.

The great arena of rowing contests is Henley Royal Regatta. It was founded in 1830 at a public meeting held in the town hall at Henley-on-Thames, at which it was decided to raise a subscription and purchase two challenge cups, the Grand Challenge Cup to be rowed for annually in eight-oared boats open to all amateur crews, and the Town Challenge Cup for

four-oared crews residing within 5 m. of Henley. The first regatta was held on the 14th of June 1839, and was a most successful affair, the Grand Challenge Cup being won by the Trinity Boat Club, Cambridge. In 1840 another district race was added, and in 1841 the Stewards Challenge Cup for four oars was added to the programme, open to competition upon the same conditions as the Grand Challenge Cup. There have now for many years been eight events at the regatta, four of which are open to all amateurs, viz. the Grand Challenge Cup for eight oars, the Stewards Challenge Cup for fours, the Silver Goblets for pair oars founded in 1845, and the Diamond Sculls for single scullers founded in 1844. The races for which the entry is restricted are the Ladies Challenge Plate for eight oars (founded 1845) and the Visitors Challenge Cup for four oars (founded 1847), which are open to crews from schools and colleges in the United Kingdom; also the Thames Challenge Cup for eight oars (founded 1868) and Wyfold Challenge Cup for four oars (founded 1855). The rule as to entry for the Thames Cup is that no one who has won the Grand Challenge or Stewards Cup may compete, nor may any one enter for this race and for the Grand or Stewards Cups in the same year. The rule for the Wyfold Cup is the same, except that a competitor may also enter for the Grand Challenge Cup.

The original regatta course was from the upper end of the Temple Island to Henley Bridge, but a change was made in 1886 so as to avoid the corner at the finish. The races now start at the lower end of the island and finish at the upper end of the grounds of Phyllis Court. The course is 1 m. 550 yds. in length and about 110 ft. in width. The races are rowed against the stream, and the time usually occupied by the winning crew of the Grand Challenge Cup is within a few seconds of 7 min. In 1843 took place the famous "seven-oar" victory of Oxford. At the eleventh hour one of the Oxford crew was incapacitated by illness. Their opponents, the Cambridge Subscription Rooms Club, refused to allow them to introduce a substitute, and the Oxford men gained undying fame by winning the Grand Challenge Cup with seven oars. Ten years later (1853) there was a magnificent race between Oxford and Cambridge in the Grand Challenge Cup, the former winning by 18 in. only. In 1862 there was a dead heat in the final heat of the Diamond Sculls between Mr E. D. Brickwood and Mr W. B. Woodgate. In 1878 occurred the memorable contest between Mr T. C. Edwards-Moss and Mr G. W. Lee (U.S.A.) in a heat for the Diamond Sculls which was won on the post by the former. In 1891 the Leander Club, after a dead heat with the Thames R.C., began a series of victories in the Grand Challenge Cup, winning the cup on seven occasions in the next ten years. In 1892 the Diamond Sculls left England for the first time, having been won by Mr J. K. Ooms of Holland. In 1895 a crew representing Cornell University, U.S.A., entered for the Grand Challenge Cup and were drawn in their heat against the Leander Club. Owing to a misunderstanding between the starter and the Leander crew, the latter failed to start, and the Cornell crew rowed on to the finish without offering to return to the start, a proceeding which caused no little comment at the time. On the following day they were defeated by Trinity Hall, Cambridge, the ultimate winners. In 1897 the Grand Challenge Cup was won by 2 ft. by New College, Oxford, in the record time of 6 min. 51 secs., after a desperate race with Leander. The feature of the next ten years was the persistency with which colonial and foreign crews endeavoured to carry off the principal prizes of the regatta, and the invasion culminated in 1906 by the capture of the Grand Challenge Cup by a crew from the Club Nautique de Gand, Belgium. On this occasion the Leander Club was not represented, but in 1907 the Belgians repeated their victory after defeating a strong Leander crew in one of the heats. In 1903 Mr Herbert Steward, the chairman of the regatta committee, published a detailed record of the regatta from its commencement, which gives a complete history of the meeting and an account of every race.

Henley regatta is rowed "in accordance with" the rules of

the Amateur Rowing Association, a body which has control of all other amateur rowing in England. The Henley Stewards and the Amateur Rowing Association (or A.R.A.) are in complete harmony. Their rules are identically the same, but the Stewards being the older body are not subject to the A.R.A., and in the improbable event of a difference occurring they would be entitled to act independently. The A.R.A. was formed in 1882 for the purpose of drawing up a definition of an "amateur," and for the purpose of having a body who could if necessary select a national representative crew to meet any foreign or colonial invaders. It has long since dropped the latter portion of its original programme, and the A.R.A. as at present constituted is an association to which all the principal amateur boat clubs are affiliated. Its objects are to maintain the standard of amateur oarsmanship and to promote the interests of boat racing. It is governed by a committee which occupies in the British rowing world a position not unlike that of the stewards of the Jockey Club in racing matters. The constitution and objects of the A.R.A. are clearly defined in the rules, and their definition of an amateur is so much stricter than that of some other countries that it is advisable to set it out *in extenso*. It is as follows:—

No person shall be considered an amateur oarsman, sculler or coxswain—

- (1) Who has ever rowed or steered in any race for a stake, money or entrance fee;
- (2) Who has ever knowingly rowed or steered with or against a professional for any prize;
- (3) Who has ever taught, pursued or assisted in the practice of athletic exercises of any kind for profit;
- (4) Who has ever been employed in or about boats or in manual labour for money or wages;
- (5) Who is or has been by trade or employment for wages a mechanic, artisan or labourer, or engaged in any menial duty;
- (6) Who is disqualified as an amateur in any other branch of sport.

The rules of the A.R.A. also comprise the "Laws of Boat Racing," which govern the race from start to finish; and the "Rules for Regattas," which deal with a large number of matters such as the definition of the different classes of oarsmen, seniors, juniors and maidens, the making of entries, the powers of regatta committees, &c.

A large number of regattas are held under these rules in all parts of the country during the summer months. There are also several matches and other competitions rowed under special rules, the most important of these being the Wingfield Sculls (founded 1830), or amateur championship of the Thames, rowed in the month of July over the championship course from Putney to Mortlake (4½ m.).

If the number of entries at Henley Regatta, the extension of the sphere of influence of the A.R.A. and the public interest in the Oxford and Cambridge Boat Race, may be taken as tests, rowing has more than held its own among the various competing forms of recreation in the world of British amateur athletic sport.

Rowing in the United States.—The earliest record of a boat race in the United States is that of a contest in light barges in the year 1811 between the "Knicker-bocker" of New York and the "Invincible" of Long Island, in which the former was successful. The evolution from racing in heavy pleasure boats to racing in specially constructed craft proceeded with great rapidity, and by the year 1834 a large number of small clubs in New York had combined, under the title of the Castle Garden Boat Club Association. In 1837 the first regatta took place at Poughkeepsie, the race being between "six-oars" for a prize of \$200. In those days there was no real distinction in America between amateur and professional, and in spite of rules and definitions the distinction between one who is qualified as an amateur and one who is not has remained in America much less certain and precise than in the United Kingdom.

Yale and Harvard Universities became centres of aquatic energy very early in the history of American rowing. The first racing boat at Yale, a six-oar, was bought in 1844, and in the following spring Harvard purchased an eight, and in 1852

a race was rowed between a Harvard crew and three Yale crews at Lake Winnepesaukee, which resulted in a victory for the former. In 1859 Harvard again defeated Yale in a six-oared race, but on the following day at Worcester City Regatta the same crews entered for a prize and Yale defeated Harvard. In 1864 at a college regatta Yale defeated Harvard, but in 1866 Harvard with a very fine crew showed their superiority over all the other colleges. In 1869 Harvard sent a challenge to Oxford and Cambridge to row a four-oared match on the Thames from Putney to Mortlake. It was accepted by the former and the race was rowed on the 27th of August. The race aroused great public interest, and the banks of the river were crowded from end to end of the course. The crews were: *Oxford*, F. Willan (bow), A. C. Yarborough, J. C. Tinné and S. Darbishire (stroke); *Harvard*, J. S. Fay (bow), E. G. Lyman, W. H. Simmons and A. P. Loring (stroke). Harvard led at first, but Oxford eventually rowed them down and won by three lengths.

The trip of the Harvard four to England aroused the rowing enthusiasm of other American universities such as Princeton, Cornell, Columbia and Pennsylvania, and during the next ten years considerable improvement was shown in American rowing. In 1875 no fewer than thirteen university or college crews competed in a race, in which Cornell finished first, Columbia second and Harvard third, the ships used being six-oars without coxswains. In 1876 the eight-oared match over a four-mile course between Harvard and Yale was instituted, and in 1878 a four from Columbia University went to Henley and won the Visitors Challenge Cup. In 1879 and 1880 there were a very large number of inter-collegiate matches and regattas, in several of which Columbia maintained the reputation which they had gained at Henley. In 1881 a Cornell four started at Henley for the Stewards Cup, but were easily beaten. During the next few years there was considerable difference of opinion between universities as to the correct style of stroke, and in 1882 a Yale crew, coached by Mr Davis, did some fine performances, rowing a very fast short stroke in a very long boat. They were, however, eventually beaten by Harvard after an exciting race, in which it is only fair to them to record that the erratic steering of their coxswain contributed in no small degree to their defeat. The next year, 1883, Yale tried an even faster and shorter stroke, but were easily beaten by Harvard, who rowed with great length and steadiness. This year saw the end of the very fast short stroke, and although the "strokes" of the various crews since that day have differed in minor degrees, they settled down to a longer steadier method of rowing which is spoken of in England as the "American style." It differs from that adopted by English oarsmen in that there is an absence of swing and body work, and in that the oarsmen appear to rely almost entirely upon their long slides and hard leg work. In the early "nineties" Cornell was almost always successful at home, and in 1895 they entered for the Grand Challenge Cup at Henley. Owing to a misunderstanding at the start the Leander crew were left at the post in the first heat, but on the next day Cornell suffered defeat at the hands of Trinity Hall. In 1896 Yale entered at Henley under the tuition of Cook, but were somewhat easily beaten by Leander. The result of these two expeditions to Henley was an attempt to introduce the English style of rowing in America. The experiment was not altogether successful. Mr R. C. Lehmann, who had met with considerable success in England as a coach both at Oxford and Cambridge, went to Harvard for two seasons. The attempt to instruct the American oarsmen in the English methods of swing and body work, instead of the American stroke, resulted in their falling short of perfection in either style, and they were beaten by Yale upon each occasion. Mr Lehmann's visit, if it failed to give pace to the crews he coached, resulted, however, in improving the whole spirit of American college rowing. Mutual confidence and friendly rivalry took the place of the atmosphere of suspicion and almost of enmity which had at times existed between Harvard and Yale. In 1895 an Inter-collegiate Rowing Association was formed by

Cornell, Columbia and Pennsylvania to organise contests at Poughkeepsie open to all colleges. In 1899 and 1900 Pennsylvania won, in 1902, 1904 and 1908 Syracuse, and in most other years Cornell. The two annual inter-collegiate regattas are the Harvard-Yale at New London, and that at Poughkeepsie, open to all but not participated in by Harvard and Yale. By way of exception, Harvard rowed at Poughkeepsie in 1896, and in 1897 and 1898 Cornell rowed in two regattas. In 1901 Pennsylvania was just beaten by Leander Club in the race for the Grand Challenge Cup at Henley.

The history of amateur rowing in the United States, other than that of the colleges and universities, is a narrative of continual struggles on the part of the authorities to distinguish between the amateur and the non-amateur. The National Association of Amateur Oarsmen was established in 1872. Many regattas have been held since that date under their rules, but the standard of amateurism which satisfied the N.A.A.O. has never been strict enough to comply with the requirements of the English A.R.A. or the Henley Stewards. In 1883 a Hillsdale four from U.S.A. tendered an entry at Henley, but it was refused by the Stewards, on the ground that the men were not amateurs according to the English definition. In subsequent years several American scullers entered for the Diamond Sculls, and in 1897 they were won by E. H. Ten-Eyck of Wachuset Boat Club, Worcester, U.S.A. In 1898 Ten-Eyck's entry was refused by the Henley Stewards. No little resentment has been caused in America by the reluctance of the English authorities to accept American entries, but their justification lies in the essential difference, not only in letter but in spirit, between the laws and customs of the two countries with regard to the amateur status and amateur sport. In 1904 a crew of the Vesper B.C. of Philadelphia were duly vouched by the N.A.A.O. and their entry accepted by the Henley Stewards. They competed and were beaten, and it afterwards became known that not only had several of the men made money out of the trip, but that two or three of the oarsmen were not qualified to row at Henley. It also appeared that certain members of the N.A.A.O. had, to say the least of it, been extremely careless in giving assurances as to the status of the Vesper crew, and all relations between the N.A.A.O. and the Henley Stewards were abruptly terminated, the Stewards determining that they would not accept foreign entries except from a country where there was a governing body which had control of amateur rowing and which had an agreement with the Stewards by which they definitely pledged themselves not to send competitors to Henley unless they came within the English definition. In 1906 Harvard challenged Cambridge. The race, which attracted an immense concourse of spectators, was rowed from Putney to Mortlake in September. Cambridge led from the start and won by three lengths.

Rowing in other Countries.—During the latter years of the 19th century and during the early years of the present century, rowing increased very greatly in popularity as a branch of athletic sport in every quarter of the globe. It would be impossible here to describe the history or organization of boat clubs and regattas in Australia, in Canada, and in the various countries of Europe. Canadian rowing has always been of a high class. In 1904 L. Scholes, a Canadian sculler, won the Diamond Sculls at Henley, and on several occasions Canadian eights and fours have competed for the Grand Challenge and Stewards Challenge Cups at Henley. In Australia they have a regatta which is called the "Australian Henley," and an inter-university contest for a cup presented by Oxford and Cambridge oarsmen. In Europe international championships have been instituted in the hope of bringing together oarsmen and scullers from all countries. The Belgian oarsmen have by their Henley successes achieved the greatest distinction among continental oarsmen. In Holland the principal rowing clubs have their headquarters at Amsterdam, and several Dutch crews have been seen at Henley. In France there are innumerable rowing clubs which are now governed by the Fédération française, a body which has a strict code of rules, but

which has not adopted quite so strict an amateur definition as that of the English A.R.A. In Germany, also, rowing is very extensively practised under the auspices of the Deutsche Ruderverband; the chief contests between English and German crews of recent years were at the Cork Regatta of 1902 when Leander Club defeated the Berlin Club in the eight-oared race, and at the Henley Regatta of 1907, when a four of the Ludwigshafener Club were defeated in a heat of the Stewards Cup by a Leander crew.

Methods and Style.—The English style is the only one in which the oarsman swings his body to the full extent fore and aft, at the same time making use of his sliding seat. Most of the foreign crews who have competed in England have sacrificed a portion of their swing in order to enable them, as they believe, to make better use of their leg work. There can be no doubt that the English style is in a sense more exhausting to the oarsman, that is to say it enables him to bring more muscle into play and to make full use of his weight and strength, but in spite of recent defeats it is still believed by English oarsmen to be the most effective. The crews of 1906 and 1907 which were defeated by the Belgians were the best that England could at the time produce, but they undoubtedly rowed in a style which fell a long way short of ideal English rowing.

The secret of good rowing is the simultaneous application of leg and body work from end to end of the stroke. The instant the blades are covered the whole weight must be lifted from the stretcher and applied to the oar-handle, and must remain so applied until the hands come in to the chest. In order to ensure that the pressure so applied to the blade shall be as long and as hard as possible, the body must be swung forward to its full extent, and during the stroke the shoulders must always be swinging back faster than the seat, while at the same time the legs are driving hard at the stretcher. The slide and swing should be finished simultaneously. There are many subsidiary rules of style as to the movements of the hands and arms, but they are all of secondary importance and are devised so as to enable the average man to execute the working portion of the stroke effectively and often, without undue exertion to himself. The movements of a crew must be as nearly as possible simultaneous in every particular. There have been many instances of crews which although inferior in style and strength to their opponents have been victorious owing to being "better together."

See the volumes on *Rowing in the Badminton and Isthmian Libraries*; W. E. Sherwood, *Oxford Rowing*; W. B. Woodgate, *Oars and Sculls*; E. D. Brickwood, *Boat Racing*; H. T. Steward, *Henley Royal Regatta*. (C. M. P.)

ROWLAND, HENRY AUGUSTUS (1848-1901), American physicist, was born at Honesdale, Pennsylvania, on the 27th of November 1848. From an early age he exhibited marked scientific tastes and spent all his spare time in electrical and chemical experiments. At the Rensselaer Polytechnic Institute at Troy, N.Y. he graduated in 1870, and he then obtained an engagement on the Western New York railway. But the work there was not to his liking, and after a short time he gave it up for an instructorship in natural science at the university of Wooster, Ohio, which in turn he resigned in order to return to Troy as assistant professor of physics. Finally, in 1876, he became the first occupant of the chair of physics at the Johns Hopkins University, Baltimore, a position which he retained until his premature death on the 16th of April 1901. Rowland was one of the most brilliant men of science that America has produced, and it is curious that at first his merits were not perceived in his own country. In America he was unable even to secure the publication of certain of his scientific papers; but Clerk Maxwell at once saw their excellence, and had them printed in the *Philosophical Magazine*. When the managers of the Johns Hopkins University asked advice in Europe as to whom they should make their professor of physics, he was pointed out in all quarters as the best man for the post. In the interval between his election and the assumption of his duties at Baltimore, he studied physics under Helmholtz at

Berlin, and carried out a well-known research on the effect of an electrically charged body in motion, showing it to give rise to a magnetic field. As soon as he was settled at Baltimore, two important pieces of work engaged his attention. One was a redetermination of the ohm. For this he obtained a value which was substantially different from that ascertained by the committee of the British Association appointed for the purpose, but ultimately he had the satisfaction of seeing his own result accepted as the more correct of the two. The other was a new determination of the mechanical equivalent of heat. In this he used Joule's paddle-wheel method, though with many improvements, the whole apparatus being on a larger scale and the experiments being conducted over a wider range of temperature. He obtained a result distinctly higher than Joule's final figure; and in addition he made many valuable observations on thermometrical questions and on the variation of the specific heat of water, which J. P. Joule had assumed to be the same at all temperatures. In 1882, before the Physical Society of London, he gave a description of the diffraction gratings with which his name is specially associated, and which have been of enormous advantage to astronomical spectroscopy. These gratings consist of pieces of metal or glass ruled by means of a diamond point with a very large number of parallel lines, on the extreme accuracy of which their efficiency depends. For their production, therefore, dividing engines of extraordinary truthness and delicacy must be employed, and in the construction of such machines Rowland's engineering skill brought him conspicuous success. The results of his labours may be found in the elaborate *Photographic Map of the Normal Solar Spectrum* (1888) and the *Table of Solar Wave-Lengths* (1898). In the later years of his life he was engaged in developing a system of multiplex telegraphy.

ROWLANDS, RICHARD (fl. 1560-1620), Anglo-Dutch antiquary, whose real name was Versteegen, was the son of a cooper whose father, Theodore Roland Versteegen, a Dutch emigrant, came to England about 1500. Under the name of Rowlands, Richard went to Christ Church, Oxford, in 1565, where he studied early English history and the Anglo-Saxon language. Leaving the university without a degree, he published in 1576 a work of antiquarian research, translated from the German, entitled *The Post of the World*, describing the great cities of Europe; and soon afterwards he moved to Antwerp, where he resumed the name of Versteegen, and set up in business as a printer and engraver. In 1587 he went to Paris, and in 1595 to Spain, where he studied in the college at Seville, afterwards returning to Antwerp, where he lived so far as is known until his death, the date of which, though certainly later than 1620, is unknown. Rowlands was a zealous Roman Catholic, and in 1587 he published at Antwerp *Theatrum Crudelitatum haereticorum*, in which he criticized the treatment of the Roman Catholics in England under Elizabeth so freely that when a French translation of the book appeared in the following year he was thrown into prison at the instance of the English ambassador in Paris. Many of his writings were published in the name of Versteegen. His works included *A Dialogue on Dying Well* (1603), a translation from the Italian; *Restitution of Decayed Intelligence in Antiquities concerning the English Nation*, dedicated to James I. (1605); *Neder Deytsche Epiogrammen* (1617); *Sundry Successive Regal Governments in England* (1620); *Spiegel der Nederlandsche Elenden* (1621). The verses on the defeat of the Irish rebels under Tyrone, entitled *England's Joy*, by R. R. (1601), is doubtfully attributed to him. Richard Versteegen, author of *Nederlantische Antiquiteiten* (Brussels, 1646), is probably another person, possibly Rowland's son.

See Anthony à Wood, *Athenae Oxonienses*, edited by P. Bliss (4 vols., London, 1813-20); J. W. Burgon, *Life and Times of Sir T. Gresham* (2 vols., London, 1839); W. C. Hazlitt, *Collections and Notes* (London, 1882 and 1887).

ROWLANDS, SAMUEL (c. 1573-1630), English author of pamphlets in prose and verse, which reflect the follies and humours of the lower middle-class life of his time, seems to have had no

contemporary literary reputation; but his work throws considerable light on the social London of his day. Among his works, which include some poems on sacred subjects, are: *The Betraying of Christ* (1598); *The Letting of Humours Blood in the Head-vaine* (epigrams and satires) and *A Merry Meetinge, or 'Tis Merry when Knaves mete* (1600)—the two latter being publicly burnt by order, but republished later under other names—(*Humours Ordinarie* and *The Knave of Clubbes*); *Greene's Ghost haunting Conie-Catchers* (1602), which he pretended to have edited from Greene's papers, but which is largely borrowed from his printed works; *Tis Merrie when Gossips meete* (1602), a dialogue between a Widow, a Wife, a Maid and a Vintner; *Looke to it; for Ile stabbe ye* (1604), in which Death describes the tyrants, careless divines and other evil-doers whom he will destroy; *Hells broke loose* (1605), an account of John of Leyden, and in the same year a *Theatre of Divine Recreation* (not extant), poems founded on the Old Testament; *A Terrible Battell betwene . . . Time and Death* (1606); *Democritus, or Doctor Merry-man his Medicines against Melancholy humors*, reprinted, with alterations, as *Doctor Merrie-man*; and *Diogenes Lanthorne* (1607), in which "Athens" is London; *The Famous History of Guy, Earl of Warwick* (1607), a long romance in Rowlands's favourite six-lined stanza, and one of his hastiest, least successful efforts; *Humors Looking Glasse* (1608); and *Martin Mark-all, Beadle of Bride-well* (1610), a history of roguery containing much information about notable highwaymen and the completest vocabulary of thieves' slang up to that time. Of his later works may be mentioned *Sir Thomas Overbury; or the Poysoned Knights Complaint*, and *The Melancholie Knight* (1615), which suggests a hearing of Beaumont and Fletcher's *Knight of the Burning Pestle*. The last of his humorous studies, *Good News and Bad News*, appeared in 1622, and in 1628 he published a pious volume of prose and verse, entitled *Heavens Glory, Seeke it; Earths vanitie, Flye it; Hells Horror, Fere it*. After this nothing is known of him. Mr Gosse, in his introduction to Rowlands's complete works, edited (1872-80) for the Hunterian Club in Glasgow by Mr S. J. H. Herrtage, sums him up as a "kind of small non-political Defoe, a pamphleteer in verse whose talents were never put into exercise except when their possessor was pressed for means, and a poet of considerable talent without one spark or glimmer of genius."

Mr Gosse's notice is reprinted in his *Seventeenth Century Studies* (1883). A recently discovered poem by Rowlands, *The Bride* (1617), was reprinted at Boston, U.S.A., in 1905 by Mr A. C. Potter.

ROWLANDSON, THOMAS (1756-1827), English caricaturist, was born in Old Jewry, London, in July 1756, the son of a tradesman or city merchant. On leaving school he became a student in the Royal Academy. At the age of sixteen he resided and studied for a time in Paris, and he afterwards made frequent tours on the Continent, enriching his portfolios with numerous jottings of life and character. In 1775 he exhibited at the Royal Academy a drawing of "Delilah visiting Samson in Prison," and in the following years he was represented by various portraits and landscapes. Possessed of much facility of execution and a ready command of the figure, he was spoken of as a promising student; and had he continued his early application he would have made his mark as a painter. But by the death of his aunt, a French lady, he fell heir to a sum of £7000, plunged into the dissipations of the town and was known to sit at the gaming-table for thirty-six hours at a stretch. In time poverty overtook him; and the friendship and example of Gillray and Bunbury seem to have suggested caricature as a means of filling an empty purse. His drawing of Vauxhall, shown in the Royal Academy exhibition of 1784, had been engraved by Pollard, and the print was a success. Rowlandson was largely employed by Rudolph Ackermann, the art publisher, who in 1809-11 issued in his *Poetical Magazine* "The Schoolmaster's Tour"—a series of plates with illustrative verses by Dr William Coombe. They were the most popular of the artist's works. Again engraved by Rowlandson himself in 1812, and issued under the title of the "Tour of Dr Syntax

in Search of the Picturesque," they had attained a fifth edition by 1813, and were followed in 1820 by "Dr Syntax in Search of Consolation," and in 1821 by the "Third Tour of Dr Syntax in Search of a Wife." The same Collaboration of designer, author and publisher appeared in the English "Dance of Death," issued in 1814-16, one of the most admirable of Rowlandson's series, and in the "Dance of Life," 1822. Rowlandson also illustrated Smollett, Goldsmith and Sterne, and his designs will be found in *The Spirit of the Public Journals* (1825), *The English Spy* (1825), and *The Humourist* (1831). He died in London, after a prolonged illness, on the 22nd of April 1827.

Rowlandson's designs were usually executed in outline with the reed-pen, and delicately washed with colour. They were then etched by the artist on the copper, and afterwards aqua-tinted—usually by a professional engraver, the impressions being finally coloured by hand. As a designer he was characterized by the utmost facility and ease of draughtsmanship, and the quality of his art suffered from this haste and over-production. He was a true if not a very refined humorist, dealing less frequently than his fiercer contemporary Gillray with politics, but commonly touching, in a rather gentle spirit, the various aspects and incidents of social life. His most artistic work is to be found among the more careful drawings of his earlier period; but even among the exaggerated caricature of his later time we find hints that this master of the humorous might have attained to the beautiful had he so willed.

See J. Grego, *Rowlandson the Caricaturist, a Selection from his Works, &c.* (2 vols., 1880).

ROWLEY, WILLIAM (c. 1585-c. 1642), English actor and dramatist, collaborator with several of the dramatists of the Elizabethan period, especially with Thomas Middleton. He is not to be identified with "Master Rowley, once a rare scholar of learned Pembroke Hall in Cambridge," whom Francis Meres described in his *Palladis Tamia* as one of the "best for comedy." The only Rowley at Pembroke Hall at the period was Ralph Rowley, afterwards rector of Chelmsford. William Rowley is described as the chief comedian in the Prince of Wales's company, and it was doubtless during the two years' union (1614-16) of these players with the Lady Elizabeth's company that he was brought into contact with Middleton. Rowley joined the King's Servants in 1623, and retired from the stage about four years later. The fact of his marriage is recorded in 1637, and he is supposed to have died about 1642. Four plays attributed to his sole authorship are extant: *A new Wonder, A Woman never Vexed* (printed, 1632); *A Match at Midnight* (1633); *A Tragedie called Alls Lost by Lust* (1633); and *A Shoemaker a Gentleman with the Life and Death of the Cripple that stole the Weathercock at Pawles* (1638). They are distinguished by effectiveness of situation and ingenuity of plot, so that we may conjecture why he was in such request as an associate in play-making, and he had further an experimental knowledge of the coarse comedy likely to please the pit. It is recorded by Langbaine that he "was beloved of those great men Shakespeare, Fletcher and Jonson." The plays he wrote with Middleton are dealt with under that heading. With George Wilkins and John Day he wrote *The Travaillies of the Three English Brothers* (1607); with Thomas Heywood he produced the romantic comedy of *Fortune by Land and Sea* (printed, 1655); he was associated with Thomas Dekker and John Ford in *The Witch of Edmonton*¹ (printed, 1658); *A Cure for a Cuckold* (printed, 1661) and *The Thracian Wonder* (printed, 1661) are assigned to the joint authorship of Webster and Rowley; while Shakespeare's name was unjustifiably coupled with his on the title-page of *The Birth of Merlin: or, The Child hath found his Father* (1662). Rowley also wrote an elegy on Hugh Attwell, the actor, and a satirical pamphlet describing contemporary London, entitled *A Search for Money* (1609).

The dramatist SAMUEL ROWLEY, described without apparent reason by J. P. Collier as William Rowley's brother, was employed

by Henslowe as a reader of plays. He wrote some scriptural plays now lost, with William Borne (or Bird, or Boyle)² and Edward Juby. His only extant pieces are: *When you see me, You know me. Or the famous Chronicle Historie of King Henry the eight, with the birth and vertuous life of Edward Prince of Wales* (1605), of interest because of its possible connexion with the Shakespearian play of *Henry VIII.*, and *The Noble Souldier. Or, A Contract Broken, justly reveng'd* (1634), which was entered, however, in the Stationers' Register as a work of Thomas Dekker, to whom the major share is probably assignable.

ROWLEY REGIS, an urban district in the Kingswinford parliamentary division of Staffordshire, England, on the Stourbridge branch of the Great Western railway, 7 m. W. of Birmingham, Pop. (1901) 34,670. It lies in a hilly district rich in coal and iron, while a hard basaltic intrusion known as Rowley rag is largely quarried. The town is a modern growth out of a village surrounding the church of St Giles, which dates from the 13th century, though rebuilt in 1840. Iron manufactures are extensive; there are also brick and tile works and breweries.

ROWLOCK (pronounced *ru-lock* or *rollock*), a device on the gunwale of a boat in or on which an oar rests, forming a fulcrum for the oar in rowing. The word is a corruption due to "row" of the earlier "oar-lock," O.E. *ārloc*, a lock or enclosed place for an oar. The simplest form of rowlock is a notch, square or rounded, on the gunwale, in which the oar rests; other kinds are formed by two pins or pegs, "thole pins" (thole being ultimately the same word as *Norw. toll*, a young fir-tree), and by a swivel with two horns of metals, pivoted in the gunwale or on an outrigger (see OAR).

ROWTON, MONTAGUE WILLIAM LOWRY-CORRY, BARON (1838-1903), second son of the Right Hon. Henry Corry by his wife Harriet, daughter of the 6th earl of Shaftesbury, was born in London on the 8th of October 1838, educated at Harrow and at Trinity College, Cambridge, and called to the bar in 1863. His father, a son of the 2nd earl of Belmore, represented County Tyrone in parliament continuously for forty-seven years (1826-73), and was a member of Lord Derby's cabinet (1866-68) as vice-president of the council and afterwards as first lord of the Admiralty. Montague Corry was thus brought up in close touch with Conservative party politics; but it is said to have been his winning personality and social accomplishments rather than his political connexions that recommended him to the favourable notice of Disraeli, who in 1866 made Corry his private secretary. From this time till the statesman's death in 1881 Corry maintained his connexion with Disraeli, the relations between the two men being more intimate and confidential than usually subsist between a private secretary and his political chief. When Disraeli resigned office in 1868 Corry declined various offers of public employment in order to be free to continue his services, now given gratuitously, to the Conservative leader; and when the latter returned to power in 1874, Corry resumed his position as official private secretary to the prime minister. He accompanied Disraeli (then earl of Beaconsfield) to the congress of Berlin in 1878, where he acted as one of the secretaries of the special embassy of Great Britain. On the defeat of the Conservatives in 1880, Corry was raised to the peerage with the title of Baron Rowton, of Rowton Castle, Shropshire. He had rendered service of an exceptional order to his chief, and after Beaconsfield's removal to the House of Lords his private secretary became invaluable in keeping him in touch with the rank and file of his party. Lord Rowton was in Algiers when Beaconsfield was stricken with his last illness in the spring of 1881; but returning post-haste across Europe, he was present at the death-bed of his old chief. Beaconsfield (q.v.) bequeathed to Rowton all his correspondence and other papers.

Lord Rowton will long be remembered as the originator of the scheme known as the Rowton Houses. Consulted by Sir

¹ It is usual to minimize Rowley's share in this play. Mr Secombe (*Dict. Nat. Biog.*, s.v. Rowley) says: "Dekker appears to have had the chief share, but Rowley supplied some acceptable buffoonery." J. O. Halliwell-Phillips (*Dict. of Old English Plays*) however, defined it as a tragedy-comedy by William Rowley, adding that he had help from the other two.

² William Borne or Bird engaged to play with the Admiral's Men for three years from 1597. In 1600 he borrowed 30s. from Henslowe to pay for a new play, *Jagurh*, by W. Boyle (probably another name for himself). He helped S. Rowley in *Joshua* (1601), and in additions (1602) to Marlowe's *Dr Faustus*. His connexion with the theatre ceased about 1621.

Edward Guinness (afterwards Lord Iveagh) with regard to the latter's projected gift of £200,000 for endowment of a trust for the improvement of the dwellings of the working classes, Rowton made himself personally familiar with the conditions of the poorest inhabitants of London; and he determined to establish "a poor man's hotel," which should offer better accommodation than the common lodging-houses, at similar prices. In the face of much discouragement and difficulty, the first Rowton House was opened at Vauxhall in December 1802, the cost (£30,000) being defrayed by Lord Rowton, though he was by no means a man of great wealth. In 1804 a company, Rowton Houses (Limited), was incorporated to extend the scheme, a main characteristic of which was that the houses should not be charitable institutions but should be on a paying commercial basis. The scheme proved a gratifying success, and was imitated not only in many of the chief towns of Great Britain, but also in different countries of Europe and in America (see HOUSING). Lord Rowton also devoted himself to the business of the Guinness Trust, of which he was a trustee, and was interested in many philanthropic schemes. Lord Rowton was unmarried, and the title consequently became extinct at his death, which occurred in London on the 9th of November 1903.

ROXANA, or **ROXANE**, daughter of the Bactrian king Oxyartes, and wife of Alexander the Great. After the latter's death she gave birth at Babylon to a son (Alexander IV.), who was accepted by the generals as joint-king with Arrhidæus. Having crossed over to Macedonia, and thrown in her lot with Olympias, mother of Alexander the Great, she was imprisoned by Cassander in the fortress of Amphipolis and put to death (310 or 309 B.C.). The marriage of Alexander and Roxana was the subject of a famous painting by Aëtion.

See Plutarch, *Alexander*, 47, 77; Arrian, *Anab. iv.* 18, vii. 27; *Diod. Sic.* xviii. 3, 38, xix. 11, 52, 105; Strabo xi. p. 517, xvii. p. 794.

ROXBURGH, EARLS AND DUKES OF. **ROBERT KER**, 1st earl of Roxburgh (c. 1570-1650), was the eldest son of William Ker of Cessford (d. 1606) and the grandson of Sir Walter Ker (d. c. 1584), who fought against Mary queen of Scots both at Carberry Hill and at Langside. He was descended from Sir Andrew Ker of Cessford (d. 1526) who fought at Flodden and was killed near Melrose in January 1526 by the Scots of Buccleuch. The deed was avenged when the Kers under Sir Walter killed Sir Walter Scott of Buccleuch in Edinburgh in 1552. Robert Ker was also descended, on the maternal side, from Andrew Ker of Ferniehurst (c. 1471-1545), a celebrated border chieftain. Another famous member of the family was Andrew's grandson, Sir Thomas Ker of Ferniehurst (d. 1586), who, Camden says, was "of an immovable fidelity to the queen of Scots and the king her son." He was the father of Robert Carr, earl of Somerset, the favourite of James I.

After a turbulent life on the border Robert Ker became a Scottish privy councillor in 1599 and was made Lord Roxburgh about the same time; he accompanied King James to London in 1603, and was created earl of Roxburgh in 1616. He was lord privy seal for Scotland from 1637 to 1649, and in the Scottish parliament he showed his sympathy with Charles I.; but he took no part in the Civil War, although he signed the "engagement" for the king's release in 1648. He died at Floors, his residence near Kelso, on the 18th of January 1650. His son Harry, Lord Ker, had died in January 1643; consequently his titles and estates passed by special arrangement to his grandson, **WILLIAM DRUMMOND** (d. 1675), the youngest son of his daughter Jean and her husband John Drummond, 2nd earl of Perth. William took the name of Ker, became 2nd earl of Roxburgh, and married his cousin Lord Ker's daughter Jean.

The second earl's son was **ROBERT**, 3rd earl (c. 1658-1682), whose son was **JOHN**, 1st duke of Roxburgh (c. 1680-1741). John became 5th earl on the death of his brother Robert, the 4th earl, in 1666, and is described by George Lockhart of Carnwath as "perhaps the best accomplished young man of quality in Europe." In 1704 he was made a secretary of state of

Scotland, and he helped to bring about the union with England, being created duke of Roxburgh in 1707 for his services in this connexion. This was the last creation in the Scottish peerage. The duke was a representative peer for Scotland in four parliaments; George I. made him a privy councillor and keeper of the privy seal of Scotland, and he was loyal to the king during the Jacobite rising in 1715. He was again a secretary of state from 1716 to 1725, but he opposed the malt-tax, and in 1725 Sir Robert Walpole procured his dismissal from office. He died on the 24th of February 1741. His only son, **ROBERT** (c. 1700-1755), who had been created Earl Ker of Wakefield in 1722, became 2nd duke, and was succeeded by his son **JOHN**, 3rd duke of Roxburgh (1740-1804), the famous bibliophile. John was betrothed to Christiana, daughter of the duke of Mecklenburg-Strelitz; but when the princess's sister Charlotte was affianced to George III., reasons of state led to the rupture of the engagement, and he died unmarried on the 10th of March 1804. The duke's library, including a unique collection of books from Caxton's press, and three rare volumes of broadside ballads, was sold in 1812, when the Roxburgh Club was founded to commemorate the sale of Valdarfer's edition of Boccaccio. Roxburgh's cousin William, 7th Lord Bellenden (c. 1728-1805), who succeeded to the Scottish titles and estates, died childless in October 1805, and for seven years the titles were dormant. Then in 1812 Sir James INNES, bart. (1736-1823), a descendant of the 1st earl, established his claim to them, and taking the name of Innes-Ker, became 5th duke of Roxburgh. Among the unsuccessful claimants to the Roxburgh dukedom was John Bellenden Ker (c. 1765-1842), famous as a wit and botanist and the author of *Archæology of Popular Phrases and Nursery Rhymes* (1837), whose son was the legal reformer, Charles Henry Bellenden Ker (c. 1785-1871).

The 5th duke's great-grandson, **HENRY JOHN INNES-KER** (b. 1876), became 8th duke in 1892. The duke of Roxburgh sits in the House of Lords as Earl Innes, a peerage of the United Kingdom, which was conferred in 1837 upon James Henry, the 6th duke (1816-1870).

ROXBURGHSHIRE, a Border county of Scotland, bounded W. by Berwickshire, E. and S.E. by Northumberland, S. by Cumberland, S.W. by Dumfriesshire and N.W. by the shires of Selkirk and Mid Lothian. It has an area of 426,060 acres, or 665.7 sq. m. The only low-lying ground in the shire is found in the N. and in the valleys of the larger rivers, and the whole S. is markedly hilly. Though the Cheviots, forming for a considerable distance the natural boundary with England, mostly belong to Northumberland, Catecluch Shin (1742 ft.) and Peel Fell (1964) are Scottish peaks. The chief heights of the mountainous mass constituting the watershed between Teviotdale and Liddesdale are Cauldcluch Head (1996), Greatmoor (1064), Pennygart (1805), Din Fell (1735), Windburgh (1622) and Arnton Fell (1464). In the W. is Crib Law (1369), and in the N., near Melrose, occur the triple Eildons (highest peak, 1385). The county is abundantly watered. The Tweed flows through the N. of the shire for 26 out of its total run of 97 m., though for about 2 m. (near Abbotsford) it is the boundary stream with Selkirkshire, and for 10 m. lower down with Berwickshire (parishes of Earlstoun and Merton). On the right its affluent are the Bowden and the Teviot, and on the left the Allan and the Eden. The Teviot is the principal river lying entirely in Roxburghshire. From its source near Causeway Grain Head on the Dumfriesshire border, it follows mainly a N.E. direction for 37 m. to its confluence with the Tweed at Kelso. Its chief tributaries are, on the right, Allan Water, the Slitrig, Dean Burn, the Rule, the Jed, the Oxnam and the Kale, and, on the left, Borthwick Water and the Ale, both rising in Selkirkshire. The Liddel is the leading stream in the S. Rising near Peel Fell in the Cheviots it flows S.W. to the Esk after a course of 27 m., receiving on the right Hermitage Water, on the left Kershope Burn. The Kershope and Liddel, during part of their run, serve as boundaries with Cumberland. Excepting the Liddel, which drains to the Esk, much the greater portion of the surface is drained, by the Tweed, to the North Sea. The lakes are few

and small, the largest being Yetholm or Primside Loch and Horselaw, both in the parish of Linton among outlying hills of the Cheviots. Teviotdale, Liddesdale, Tweedside and Jedvale are the principal valleys.

Geology.—This county contains a considerable range of sedimentary rocks from the Ordovician to the Carboniferous systems, and with these are associated large tracts of volcanic rocks. The Ordovician and Silurian rocks occupy the N.W. and W. part of the county; they have been thrown into numerous sharp folds. It is on the crests of the anticlines that the strata of the former system appear flanked on either side by those of the latter. The oldest rocks are the mudstones and radiolarian cherts with contemporaneous and intrusive igneous rocks of Arenig age; these are followed by shales and greywackes of Llandovery age and similar rocks of Caradoc age. Then comes the Silurian with the Birkhill shales and massive grits and greywackes of the Gala or Queensberry group with the Hawick rocks; these are all of Llandovery age and they occupy the greater part of the Silurian area. Wenlock and Ludlow rocks are found S. of Hawick rocks from Wisp Hill N.E. by Stobs Castle; other inlying masses occur in the Old Red Sandstone and Carboniferous areas, the largest of these being that which appears in a line some 14 m. in length from near Rickerston in the direction of Hobkirk. Two divisions of the Old Red Sandstone occur; the lower, which consists of subordinate sandstones and conglomerates in sheets of contemporaneous lavas with some tuffs, is confined to the Cheviots; the strata are unconformable upon the upturned Silurian beds. The upper division, which in its turn is unconformable upon the lower, occupies about one-third of the county. It consists of coarse conglomerates at the base followed by sandstones and marls. It is well developed in the N., where volcanic rocks come in; the Trow Craigs of Makerston which cross the Tweed are due to these lavas. It extends from Newtown and Kelso to Kirkcubbin with extensions in the valleys S.W. Carboniferous rocks are represented by the Calcareous sandstone series; in the S.W. in Liddesdale and on the uplands of Carter Fell, Larriston Fell, &c., they are sandstones with shales, some calcareous beds and coal and volcanic beds. In the N.E. corner of the county the outer part of the Berwickshire Carboniferous basin just comes within the boundary. An interesting series of volcanic "necks" belonging to this period is exemplified in Dunain Law, Black Law, Maiden Paps, Ruberslaw and other hills. Glacial deposits are represented by boulder clay and beds and ridges of sand and gravel.

Climate and Industries.—The average annual rainfall is about 37 in. higher in the hilly regions and somewhat lower towards the N. and E. The mean temperature for the year is 48° F., for January 38° F. and for July 60° F. The soil is chiefly loam in the level tracts along the banks of the larger streams, where it is also very fertile. In other districts a mixture of clay and gravel is mostly found, but there is besides a considerable extent of mossy land. Of the area under grain about two-thirds are occupied by oats, the remainder being principally devoted to barley. Among green crops turnips and swedes are most generally cultivated, potatoes covering a comparatively small acreage. In different parts of Tweedside and Jedvale several kinds of fruit are successfully grown. Both in the pastoral and arable localities agriculture is in an advanced condition. The hill country is everywhere covered with a thick green pasturage admirably suited for sheep, which occupy the walks in increasingly large quantities. The herds of cattle are also heavy, horses are kept mostly for farming operations, and pigs are raised in moderate numbers. Fairly large holdings predominate, farms of between 100 and 300 acres being general, and only in Berwickshire is the proportion of farms of more than 1000 acres exceeded. Many districts on the Tweed and Teviot are beautifully wooded, but having regard to the great area once occupied by forest, the acreage under wood is not relatively small.

The county is the principal seat of the tweed and hosiery manufactures in Scotland. Engineering, ironfounding, dyeing and tanning are also carried on at Hawick and Jedburgh, and agricultural implements and machinery, chemical manures and especially fishing tackle are made at Kelso. The salmon fisheries on the Tweed are of considerable value.

The Waverley route of the North British railway runs through the county from near Melrose in the N. to Kershopefoot in the S. At St Boswells branches are sent off to Duns and Reston, and to Jedburgh and Kelso via Roxburgh. The North-Eastern railway, an English company, has a line from Berwick to Kelso, via Coldstream and Carham.

Population and Administration.—The population in 1901 was 48,804, or 73 persons to the sq. m. In 1901 there were 132 persons who spoke Gaelic and English, but none Gaelic only. The principal towns are Hawick (pop. 17,303), Kelso (4008), Jedburgh (3136), Melrose (2195). The county returns a member to parliament, and Hawick belongs to the Border group of parliamentary burghs. Jedburgh, the county town, is a royal burgh, and Hawick, Kelso and Melrose are police

burghs. The shires of Roxburgh, Berwick and Selkirk form a sheriffdom, and a resident sheriff-substitute sits at Jedburgh and Hawick. The county is under school-board jurisdiction, and there are secondary schools at Hawick and Kelso, while the board schools at Jedburgh and Melrose have secondary departments. Most of the "residue" grant is expended in assisting teachers to attend science and art classes at Edinburgh University and Hawick, and in subsidizing science and art and technical classes at Hawick, Kelso and elsewhere.

History and Antiquities.—Among the more important remains of the original inhabitants are the so-called "Druidical" stones and circles at Plenderleath between the Kale and Oxnam; on Hownam Steeple, a few miles to the N.W. (where they are locally known as the Shearers and the Bandster); and at Midshills on the Teviot. The stones on Ninestane Rig, near Hermitage Castle, and on Whisgill are supposed to commemorate the Britons of Strathclyde, under Aidan, were defeated with great slaughter by Ethelfrith, king of Bernicia, at the battle of Degsanstane or Dawstane in 603. There are hill forts in Liddesdale on the Allan, in the parish of Oxnam, and on the most easterly of the three Eildons. This last is said to be the largest example of its kind in Scotland. The fortress was defended by palisades around the three circular terraces which form the hill-top. Within the enclosure there was a town of huts, judging from certain marks that indicate the site of such dwellings, and the relics of early British pottery that have been found, while the fact that springs exist renders the theory of a settlement all the more probable. One of the most important and most mysterious of British remains is the Catrail, or Picts' Work Dyke. In its original condition it is supposed to have consisted of a line of double mounds or ramparts, averaging about 30 ft. in width, with an intervening ditch 6 ft. broad, the slope from the centre of the mound to the middle of the bottom of the trench being 10 ft. Owing to weather and other causes, however, it is now far from perfect and in places has disappeared for miles. Beginning at Torwoodlee, N.W. of Galashiels, it ran S.W. to Yarrow church, whence it turned first S. and then S.E., following a meandering course to Peel Fell in the Cheviots, a distance of 48 miles. Though it must have been difficult to defend so long a line, the bulk of opinion is in favour of its being a defence work. Roman remains are also of exceptional interest. Watling Street crossed the Border N. of Brownhart Law (1664 ft.) in the Cheviots, then took a mainly N.W. direction across the Kale, Oxnam, Jed and Teviot to Newstead, near Melrose, where it is conjectured to have crossed the Tweed and run up Lauderdale into Haddingtonshire. The chief stations were *Ad Fines* on the Cheviots, *Gadonica* (Bonjedward) near Jedfoot and Eildon Hill (? *Trimontium*). Another so-called Roman road is the Wheel Causeway or Causey, a supposed continuation of the Maiden Way which ran from Overburgh in Lancashire to Bewcastle in Cumberland, and so to the Border. It entered Roxburghshire N. of Deadwater and went (roughly) N. as far as Wolflee, whence its direction becomes a matter of surmise. Of Roman camps the principal appear to have been situated at Cappuck, to the S.E. of Jedburgh, and near Newstead, at the base of the Eildons, the alleged site of *Trimontium*. After the retreat of the Romans the country was occupied by the Britons of Strathclyde in the W. and the Bernicians in the E. It was then annexed to Northumbria for over four centuries until it was ceded, along with Lothian, to Scotland in 1018. David I. constituted it a shire, its ancient county town of Roxburgh (see KELS0) forming one of the Court of Four Burghs. The castle of Roxburgh, after changing hands more than once, was captured from the English in 1460 and dismantled. Other towns were repeatedly burned down, and the abbey of Dryburgh, Jedburgh, Kelso and Melrose ultimately ruined in the expedition of the earl of Hertford (the Protector Somerset) in 1544-45. The Border freebooters—of whom the Armstrongs and Elliots were the chief—conducted many a bloody fray on their own account. On the union of the crowns the county gradually settled into what was

comparatively a state of repose, disturbed to some extent during the Covenanted troubles and, to a much slighter degree, by the Jacobite rebellions.

BIBLIOGRAPHY.—Sir George Douglas, *Roxburgh, Selkirk and Peebles* (Edinburgh, 1899); W. S. Crockett, *The Scott Country* (Edinburgh, 1902); Alexander Jeffrey, *The History and Antiquities of Roxburghshire* (4 vols., Edinburgh, 1857-64).

ROXBURY, formerly a city of Norfolk county, Massachusetts, U.S.A., situated between Boston and Dorchester, but since 1868 a part of Boston. It is primarily a residential district. Among its institutions are the Roxbury Latin School, established in 1645,¹ the Fellows Athenaeum (a part of the Roxbury branch of the Boston Public Library), with about 26,000 volumes in 1909, and the New England Hospital for Women and Children (1863), the New England Baptist Hospital (1803), the Woman's Charity Club Hospital (1890), the Roxbury Homeopathic Dispensary (1886), the Roxbury Home for Children and Aged Women (1856), a Home for Aged Couples (1884) and the Massachusetts Home for Intemperate Women (1879). On Mount Bellevue, in West Roxbury (set apart from Roxbury in 1851 and annexed to Boston in 1873), there is an observatory (erected in 1869 by the city of Boston as a stand-pipe for the high service water supply). Among the manufactures of the district are cotton and woollen goods, cordage, carpets, shoes and foundry products. The town of Roxbury (at first usually spelled Rocksbury) was founded in 1630 by some of the Puritan immigrants who came with Governor John Winthrop; the settlers were led by William Pynchon, who in 1636 led a party from here and founded Springfield, Mass. At the home of Rev Thomas Welde (d. 1662), the first minister, Anne Hutchinson (*g.v.*) was held in custody during the winter of 1637-38. Associated as teacher with Welde and his successors, Samuel Danforth and Nehemiah Walter, was John Eliot, the apostle to the Indians, who removed to Roxbury in 1632 and died here in 1690. Roxbury was the home also of Thomas Dudley, of his son Joseph and of his grandson Paul; of Robert Calef (d. 1719), the leader of the opposition to the witchcraft craze; of General Joseph Warren, and of William Eustis (1753-1825), who was U.S. secretary of war (1809-12), minister to the Netherlands (1814-18), and governor of Massachusetts (1823-25); and from 1837 to 1845 Theodore Parker was the pastor of the Unitarian Church of West Roxbury. Of special interest in the old Roxbury burial-ground is the "Ministers' Tomb," containing the remains of John Eliot, and the tomb of the Dudleys. West Roxbury was the scene of the Brook Farm experiment (see BROOK FARM). Roxbury was chartered as a city in 1846.

¹ See F. S. Drake, *The Town of Roxbury, its Memorable Persons and Places* (Boston, 1878 and 1905).

ROY, WILLIAM (1726-1790), a famous British surveyor, military draughtsman, antiquary, &c. In 1746, when an assistant in the office of Colonel Watson, deputy quartermaster-general in North Britain, he began the survey of the mainland of Scotland, the results of which were embodied in what is known as the "duke of Cumberland's map." In 1755 he obtained his commission in the 4th King's Own Foot, and in 1759 gained his lieutenancy and went to serve in Germany in the Seven Years' War. In 1765 he appears as deputy quartermaster-general to the forces, surveyor-general of coasts and engineer-director of military surveys in Great Britain; in 1767 he became F.R.S., in 1781 major-general, in 1783 director of Royal Engineers. Besides his campaigns and observations in Germany, his visits to Ireland (1766) and to Gibraltar (1768) were important. In 1783-84 he conducted observations for determining the relative positions of the French and English royal observatories. His measurement of a base-line for that purpose on Hounslow Heath in 1784, the germ of all subsequent surveys of the United Kingdom, gained him in 1785 the

Copley medal of the Royal Society. Roy's measurements (not fully utilized till 1787, when the Paris and Greenwich observatories were properly connected) form the basis of the topographical survey of Middlesex, Surrey, Kent and Sussex. He was finishing an account of this work for the *Phil. Trans.* when he died on the 1st of July 1790.

Roy's principal book-publication is the *Military Antiquities of the Romans in Britain* (1793). See also notices of him and contributions from him in the records of the War Office and the Royal Engineers, in the *Transactions of the Royal Society of London*, vols. lxvii., lxxv., lxxvii., lxxx., lxxxv., and in the *Gentleman's Magazine*, vols. lv., lx. He is whimsically denounced by Jonathan Oldbuck in *Montbarns in Scott's Antiquary*.

ROYAL FERN, in botany, the common name for the fern *Osmunda regalis*, a native of Britain, where it grows in bogs, marshy woods, &c. It is a handsome plant with bi-pinnate fronds 2 to 6 ft. long and 1 ft. or more broad; the tops of the fronds are fertile, the fertile pinnae being cylindrical and densely covered with the spore-cases, giving the appearance of a dense panicle of flowers, whence the plant is known as the flowering fern. There are various cultivated forms—*cristata* has the ends of the fronds and the pinnae finely crested, and *corymbifera* has curiously forked and crested fronds. Several other species, such as *O. cinnamomea*, *O. Claytoniana*, are known as handsome greenhouse ferns (see also FERNS).

ROYAL SOCIETY, THE, the oldest scientific society in Great Britain, and one of the oldest in Europe. The Royal Society (more fully, The Royal Society of London for Improving Natural Knowledge) is usually considered to have been founded in the year 1660, but a nucleus had in fact been in existence for some years before that date. As early as the year 1645 weekly meetings were held in London of "divers worthy persons, inquisitive into natural philosophy and other parts of human learning, and particularly of what hath been called the *New Philosophy* or *Experimental Philosophy*," and there can be little doubt that this gathering of philosophers is identical with the "Invisible College" of which Boyle speaks in sundry letters written in 1646 and 1647. These weekly meetings, according to Wallis, were first suggested by Theodore Haak, "a German of the Palatinate then resident in London," and they were held sometimes in Dr Goddard's lodgings in Wood Street, sometimes at the Bull-Head Tavern in Cheapside.

Some of these "Philosophers," resident in Oxford about 1648, formed an association there under the title of the Philosophical Society of Oxford, and used to meet, most usually in the rooms of Dr Wilkins, warden of Wadham College. A close inter-communication was maintained between the Oxford and London Philosophers; but ultimately the activity of the society was concentrated in the London meetings, which were held principally at Gresham College.

On November 28, 1660, the first journal book of the society was opened with a "memorandum," from which the following is an extract: "Memorandum that Novemb. 28. 1660. These persons following, according to the usual custom of most of them, mett together at Gresham Colledge to hear Mr Wren's lecture, viz. The Lord Brouncker, Mr Boyle, Mr Bruce, Sir Robert Moray, Sir Paul Neile, Dr Wilkins, Dr Goddard, Dr Petty, Mr Ball, Mr Rooke, Mr Wren, Mr Hill. And after the lecture was ended, they did, according to the usual manner, withdraw for mutual converse. Where amongst other matters that were discoursed of, something was offered about a designe of founding a Colledge for the promoting of Physico-Mathematical Experimental Learning." It was agreed at this meeting that the company should continue to assemble on Wednesdays at three o'clock; an admission fee of ten shillings with a subscription of one shilling a week was instituted; Dr Wilkins was appointed chairman; and a list of forty-one persons judged likely and fit to join the design was drawn up. On the following Wednesday Sir Robert Moray brought word that the king (Charles II.) approved the design of the meetings; a form of obligation was framed, and was signed by all the persons enumerated in the memorandum of the 28th of November and by seventy-three others. On the 12th of December another meeting was held at

¹ This school was founded, primarily through the influence of the Rev. John Eliot, by inhabitants of Roxbury. In 1672 Thomas Bell, one of the original founders, bequeathed to the school all his Roxbury lands. In 1789 the school was incorporated.

which fifty-five was fixed as the number of the society,—persons of the degree of baron, Fellows of the College of Physicians, and public professors of mathematics, physics and natural philosophy of both universities being supernumeraries.

Gresham College was now appointed to be the regular meeting-place of the society. Sir Robert Moray (or Murray) was chosen president (March 6, 1661), and continued from time to time to occupy the chair until the incorporation of the society, when Lord Brouncker was appointed the first president under the charter. In October 1661 the king offered to be entered one of the society, and next year the society was incorporated under its present title. The name "Royal Society" appears to have been first applied to the Philosophers by John Evelyn, in the dedication of his translation of a book by Gabriel Naudé, published in 1661. Evelyn received in that year the thanks of the "philosophic assembly" for the honourable mention he had made of them by the name of "The Royal Society."

The charter of incorporation passed the Great Seal on the 15th of July 1662, to be modified, however, by a second charter in the following year, repeating the incorporating clauses of the first charter, but conferring further privileges on the society. The second charter passed the Great Seal on the 22nd of April 1663, and was followed in 1669 by a third, confirming the powers granted by the second charter, with some modifications of detail, and granting certain lands in Chelsea to the society. The council of the Royal Society met for the first time on the 13th of May 1663, when resolutions were passed that debate concerning those to be admitted should be secret, and that Fellows should pay 1s. a week to defray expenses.

At this early stage of its history the "correspondence" which was actively maintained with continental philosophers formed an important part of the society's labours, and selections from this correspondence furnished the beginnings of the *Philosophical Transactions* (a publication now of world-wide celebrity). At first the publication of the *Transactions* was entirely "the act of the respective secretaries." The first number, consisting of 16 quarto pages, appeared on Monday, March 6, 1664-65, under the title of *Philosophical Transactions: giving some Account of the present undertakings, studies and labours of the Ingenious in many considerable parts of the world*, with a dedication to the Royal Society signed by Henry Oldenburg, the first secretary of the society. It was ordered (1st of March 1664-65) "that the tract be licensed by the Council of the Society, being first reviewed by some of the members of the same." In 1750, 496 numbers, or 46 volumes, had been published. After this date the work was issued under the superintendence of a committee, and the division into numbers disappeared. The society also from its earliest years published, or directed the publication of, separate treatises and books on matters of philosophy; most notable among these being the *Philosophiæ naturalis principia mathematica* Autore Is. Newton. Imprimatur: S. Pepys, Reg. Soc. Proæss. Julii 5, 1686, 4to Londini 1687.

In 1887 the *Philosophical Transactions* was divided into two series, labelled A and B respectively, the former containing papers of a mathematical or physical character, and the latter papers of a biological character. More than 225 quarto volumes have been published. In 1832 appeared the first volume of *Abstracts of papers printed in the Philosophical Transactions from the year 1800*. This publication developed in the course of a few years into the *Proceedings of the Royal Society*, which has been continued up to the present time. It is published now in two series, corresponding to the two series of the *Philosophical Transactions*, and is issued in 8vo form at the rate of about three volumes a year.

It is, however, certain that one of the most important functions of the society from the beginning was the performance of experiments before the members. In the royal warrant of 1663 ordering the mace which the king presented to the society, it is described as "The Royal Society for the improving of Natural Knowledge by experiments"; and during its earlier years the

time of the meetings was principally occupied by the performance and discussion of experiments. The society early exercised the power granted by charter to appoint two "curators of experiments," the first holder of that office being Robert Hooke, who was afterwards elected a secretary of the society.

Another matter to which the society gave attention was the formation of a museum, the nucleus being "the collection of rarities formerly belonging to Mr Hubbard," which, by a resolution of council passed on the 21st of February 1666, was purchased for the sum of £100. This museum, at one time the most famous in London, was presented to the trustees of the British Museum in 1781, upon the removal of the society to Somerset House. A certain number, however, of instruments and models of historical interest have remained in the possession of the society, and some of them, more peculiarly associated with its earlier years, are still preserved at Burlington House. The remainder have been deposited in the Victoria and Albert Museum, South Kensington.

After the Great Fire of London in September 1666 the apartments of the Royal Society in Gresham College were required for the use of the city authorities, and the society were therefore invited by Henry Howard of Norfolk to meet in Arundel House. At the same time he presented them with the library purchased by his grandfather, Thomas earl of Arundel, and thus the foundation was laid of the important collection of scientific works, now exceeding 60,000 volumes, which the society possesses. Of the Arundel MSS. the bulk was sold to the trustees of the British Museum in 1830 for the sum of £3559, the proceeds being devoted to the purchase of scientific books. These MSS. are still kept in the British Museum as a separate collection. The society, however, still possesses a valuable collection of scientific correspondence, official records, and other manuscripts, including the original manuscript, with Newton's autograph corrections, from which the first edition of the *Principia* was printed, and many other original documents of great interest.

Under date December 21, 1671, the journal-book records that "the lord bishop of Sarum proposed for candidate Mr Isaac Newton, professor of the mathematics at Cambridge." Newton was elected a Fellow January 11, 1671-72, and in 1703 he was appointed president, a post which he held till his death in 1727. During his presidency the society moved to Crane Court, their first meeting in the new quarters being held November 8, 1710. In the same year they were appointed visitors and directors of the Royal Observatory at Greenwich, a function which they continued to perform until the accession of William IV., when by the new warrant then issued the president and six of the Fellows of the Royal Astronomical Society were added to the list of visitors.

In 1780, under the presidency of Sir Joseph Banks, the Royal Society removed from Crane Court to the apartments assigned to them by the government in the new Somerset House, where they remained until they removed to Burlington House in 1857. The policy of Sir Joseph Banks was to render the Fellowship more difficult of attainment than it had been; and the measures which he took for this purpose, combined with other circumstances, led to the rise of a faction headed by Dr Horsley. Throughout the years 1783 and 1784 feeling ran exceedingly high, but in the end the president was supported by the majority of the society. An account of the controversy will be found in a tract entitled *An Authentic Narrative of the Dissensions and Debates in the Royal Society*. An important step in pursuance of the same policy was taken in the year 1847, when the number of candidates recommended for election by the council was limited to fifteen, and the election was made annual. This limitation has remained in force up to the present time. Concurrent with the gradual restriction of the Fellowship was the successive establishment of other scientific bodies. The founding of the Linnean Society in 1788 under the auspices of several Fellows of the Royal Society was the first instance of the establishment of a distinct scientific association under royal charter; and this has been followed by the formation of the

large number of societies now active in the promotion of special branches of science.

From the time of its royal founder onwards the Royal Society has constantly been appealed to by the government for advice in connexion with scientific undertakings of national importance. The following are some of the principal matters of this character upon which the society has been consulted by, or which it has successfully urged upon the attention of, the government: the improvement and equipment of the Royal Observatory, Greenwich, in 1710, when it was placed in the sole charge of the society; the change of the calendar in 1752; ventilation of prisons; protection of buildings and ships from lightning; measurement of a degree of latitude; determination of the length of a pendulum vibrating seconds; comparison of the British and French standards of length; the Geodetic Survey in 1784, and the General Trigonometrical Survey begun in 1791; expeditions to observe the transits of Venus in 1761, 1769 (commanded by Captain Cook), 1877 and 1882; the Antarctic expeditions of 1772 (under Captain Cook, whose voyage extended to the circumnavigation of the globe), of 1839 (under Ross), and 1900; observations for determining the density of the earth; Arctic expeditions of 1817 (in search of the North-West Passage), of 1819 (under Parry), of 1827 (Parry and Ross), of 1845 (Franklin), of 1874 (under Nares); numerous expeditions for observing eclipses of the sun; 1822, use of coal-tar in vessels of war; best manner of measuring tonnage of ships; 1823, corrosion of copper sheathing by sea-water; Babbage's calculating machine; lightning-conductors for vessels of war; 1825, supervision of gas-works; 1832, tidal observations; 1835, instruments and tables for testing the strength of wires; magnetic observations in the colonies; 1862, the Great Melbourne telegraph; 1865, pendulum observations in India; 1866, reorganization of the meteorological department; 1868, deep-sea research; 1872, "Challenger" expedition; 1879, prevention of accidents in mines; 1881, pendulum observations; cruise of the "Triton" in Faoe Channel; 1883, borings in delta of Nile; 1884, Bureau des Poids et Mesures; international conference on a prime meridian; 1888, inquiry into lighthouse illuminants; 1890, the investigation of colour-blindness; 1895, examination of the structure of a coral reef by boring; 1896, inquiry into cylinders for compressed gases; the establishment of an International Commission of Oceanography; 1897, determination of the relations between the metric and imperial units of weights and measures; and, more recently, an inquiry into the volcanic eruptions in the West Indies; international seismological investigation; international exploration of the upper atmosphere; measurement of an arc of the meridian across Africa. In recent years also the society, acting at the request of the government, has taken the leading part in investigations, in the course of which important discoveries have been made, in relation to various tropical diseases, beginning with the tsetse-fly disease of cattle in Africa, followed by investigations into malaria, Mediterranean fever and sleeping sickness. The society has standing committees which advise the Indian government on matters connected with scientific inquiry in India and on the observatories of India. The society has taken a leading part in the promotion of the *International Catalogue of Scientific Literature from 1900*, and of the International Association of Academies, which is composed of all the principal scientific academies of the world, meeting regularly to promote international action in questions of scientific interest.

In addition to the occasional services enumerated above, the Royal Society has exercised, and still exercises, a variety of important public functions of a more permanent nature. It still provides seven of the board of visitors of the Royal Observatory at Greenwich, from 1817. From 1882 to 1891 it was the principal scientific Office in 1906 the society nominated the meteorological council, which had the control of that office. The society has the custody of standard copies of the imperial standard yard and pound. The president and council have the control of the National Physical Laboratory, an institution established in 1899 in pursuance of the recommendations of a treasury committee appointed by H.M. government in response to representations from the Royal Society. The society had previously for many years had control of the Kew Observatory, now incorporated with the National Physical Laboratory, and still remains trustee of the Gassiot Fund, a fund established for the reward of the observer of the transit of Venus. The society elects four of the nine members of the managing committee of the Lawes Agricultural Trust, and is officially represented on the governing bodies of a number of important scientific and educational institutions and of the principal public schools.

One of the most important duties which the Royal Society performs on behalf of the government is the administration of the annual grant of £4000 for the promotion of scientific research. This grant originated in a proposal by Lord John Russell in 1849 that at the close of the year the president and council should point out to the first lord of the treasury a limited number of persons to whom the grant of a reward of a sum to defray the cost of experiments might be of essential service. This grant of £1000 afterwards became annual, and was continued until 1876. In that year an additional sum of £4000 for similar purposes was granted, and the two funds of £1000 and £4000 were administered concurrently until

1881, in which year the two were combined in a single annual grant of £4000 under new regulations. Since 1896 parliament has also voted annually a grant of £1000 to be administered by the Royal Society in aid of scientific publications, not only those issued by itself, but also scientific matter published through other channels. One of the most useful of the society's publications is the great catalogue of scientific papers—an index now in twelve quarto volumes—under which names, of all the men of importance in the chief English and foreign scientific serials from the year 1800 to the year 1883. The work was prepared under the direction of the Royal Society. A continuation carrying the catalogue up to the end of the 19th century, and a subject index to the whole catalogue, have also been compiled.

A statement of the trust funds administered by the Royal Society will be found in the *Year Book* published annually, and the origin and history of these funds will be found in the *Record of the Royal Society* (2nd ed. 1901). The income of the society is derived from the annual contributions and composition fees of the Fellows, from rents and from interest on various investments. The balancesheet and an account of the estates and property are published in the *Year Book*. Five medals (the Copley, two Royal, the Davy and the Hughes) are awarded by the society every year; the Rumford and the Darwin medals biennially, the Sylvester triennially and the Buchanan quinquennially. The first of these originated in a bequest by Sir Godfrey Copley (1709), and is awarded "to the living author of such philosophical research, either published or communicated to the society, as may appear to the council to be deserving of that honour"; the author may be an Englishman or a foreigner. The Rumford medal originated in a gift from Count Rumford in 1796 of £1000 3/4 consols for the most important discoveries in heat or light made during the preceding two years. The Royal medals were instituted by George IV., and are awarded annually for the two most important contributions to science published in the British dominions not more than ten years nor less than one year from the date of the award. The Davy medal was founded by the will of Mr John Davy, F.R.S., the brother of Sir Humphry Davy, and is given annually for the most important discovery in chemistry made in Europe or Anglo-America. An enumeration of the awards of each of the medals and the conditions of the awards are published in the *Year Book*. The society also has the award of three research studentships, originally founded in 1802 in memory of J. P. Joule, and the others created out of a bequest to the society by Sir William Mackinnon in 1897.

Under the existing statutes of the Royal Society every candidate for election into the society must be recommended by a certificate in writing signed by six or more Fellows, of whom three at least must sign from personal knowledge. From the candidates so recommended the council annually select fifteen by ballot, and the names so selected are submitted to the society for election by ballot. Princes of the blood, however, and not more than two persons selected by the council on special grounds once in two years, may be elected by a more summary procedure. Foreign members, not exceeding fifty, may be selected by the council from among men of the greatest scientific eminence abroad, and proposed to the society for election. Every Fellow of the society is liable to an admission fee of £10 and an annual payment of £4; but, by aid of a fund established in 1878 for the purpose, the admission fees and £1 of the annual contribution of all the Fellows elected since that date have been remitted. The composition for annual payments is £60.

The anniversary meeting for the election of the council and officers is held on St Andrew's Day. The council for the ensuing year, out of which are chosen the president, treasurer, principal secretary, and assistant-secretaries, is elected by the majority of the existing council and the Fellows who are not members of the existing council. These are nominated by the president and council previously to the anniversary meeting. The session of the society is from November to June; the ordinary meetings are held on Thursdays during the session, at 4.30 p.m. The selection for publication from the papers read before the society is made by the "Committee of Papers," which consists of the members of the council for the time being aided by committees appointed for the purpose. The papers so selected are published either in the *Philosophical Transactions* (410) or the *Proceedings of the Royal Society* (180), and in each of these publications is presented gratis to every Fellow of the society, and to the chief scientific societies throughout the world.

The making and repealing of laws is vested in the council, and in every case the question must be put to the vote on two several days of their meeting.

The text of the charters of the Royal Society is given in the *Record*, and in the same work will be found lists of the presidents, treasurers, secretaries and assistant-secretaries from the foundation to the year 1900. The same work gives a chronological list of all the Fellows, with dates of election, and an alphabetical index. The history of the society and these publications is presented gratis to every Fellow of the society, and to the chief scientific societies throughout the world. The making and repealing of laws is vested in the council, and in every case the question must be put to the vote on two several days of their meeting.

ROYALTY (O. Fr. *realte, reialte, royauté*, from Med. Lat. *regalitas*, the substantive of *regalis*, of or belonging to a king, *rex*), kingly state or personality, hence a royal person, or number of persons of royal birth collectively, a member of a royal family. More particularly "royalty" is used of the rights and attributes of a sovereign, and especially of dues paid to the crown, which belong to the sovereign *jure coronae*, such as dues from gold and silver mines, waifs, estrays, &c. The term is usually applied to the payment made by a publisher to an author on every copy of his book sold; to the payment made to a patentee on each article manufactured under his patent by a licensee (see PATENTS), and to the payment made to the owner of minerals for the right of working, paid on the ton or other weight raised.

ROYAN, a town of W. France, in the department of Charente Inférieure, on the right bank of the Gironde, at its mouth 63 m. below and N.N.W. of Bordeaux. Pop. (1906) 7142. Royan is one of the most frequented bathing resorts on the Atlantic seaboard. The coast is divided into a number of small bays or "conches," forming so many distinct beaches: to the E. of the town is the "Grande Conche" with the municipal casino; to the S. the "Conche de Fonclion," separated from the first-named by a quay which forms a fine terraced esplanade; beyond the fort of Royan follow in succession the conches "du Chay" and "de Robinson," and the most fashionable of all that of Pontallac. The port carries on sardine-fishing and an active coasting trade, but the harbour at high tide is accessible only to vessels drawing from 8 to 10 ft., and at low water is dry. Eugène Pelletan, the author, has a statue in the town, of which he was a benefactor. The lighthouse of Cordouan, 200 ft. in height, rebuilt on the site of an older tower by the architect Louis de Foix in 1584-1610 and added to about the end of the 18th century, stands on a rock $\frac{7}{8}$ m. W.S.W. of Royan.

Royan after passing through many hands came to the family of la Trémouille, in whose favour it was made first a marquise and then a duchy. During the first half of the 17th century it was held by the English. During the wars of religion it was a centre of Calvinism and had to sustain in 1622 an eight days' siege by the troops of Louis XIII. As late as the end of the 18th century it was but a "bourg" of about one thousand inhabitants, noticeable only for its priory, where Brantôme wrote a portion of his *Chronicles*. The prosperity of the place dates from the Restoration, when steamboat communication was established with Bordeaux.

ROYAT, a watering-place of central France, in the department of Puy-de-Dôme, situated at a height of 1475 ft. on the Tiretaine, $\frac{1}{2}$ m. S.W. of Clermont-Ferrand. Pop. (1906) 1451. The thermal springs, situated in the part of Royat known as St Mart, are strongly impregnated with carbonic acid and chloride of sodium and are used in cases of rheumatism, gout, bronchitis, asthma, anaemia, &c. They were known in Roman times, and ruins of ancient baths are still to be seen. The village of Royat proper, a little higher up the valley, has a church of the 11th and 12th centuries fortified with battlements.

ROYER-COLLARD, PIERRE PAUL (1763-1843), French statesman and philosopher, was born on the 21st of June 1763 at Sompuis, near Vitry le Français (Marne), the son of Antoine Royer, a small proprietor. His mother, Angélique Perpétue Collard, was a woman of unusual strength of character and of austere piety. Pierre Paul Royer was sent at twelve to the college of Chaumont of which his uncle, Father Paul Collard, was director. He subsequently followed his uncle to Saint-Omer, where he studied mathematics. At the outbreak of the Revolution, which moved him to passionate sympathy, he was practising at the Parisian bar. He was returned by his section, the Island of Saint Louis, to the Commune, of which he was secretary from 1790 to 1792. After the revolution of the 10th of August in that year he was replaced by J. L. Tallien. His sympathies were now with the Gironde, and after the insurrection of the 12th Prairial (31st of May 1793)

he was in danger of his life. He returned to Sompuis, and was saved from arrest possibly by the protection of Danton and in some degree by the impression made by his mother's courageous piety on the local commissary of the Convention. In 1797 he was returned by his department (Marne) to the Council of the Five Hundred, where he allied himself especially with Camille Jordan. He made one great speech in the council in defence of the principles of religious liberty, but the *coup d'état* of Fructidor (4th of September 1797) drove him again into private life. It was at this period that he developed his legitimist opinions and entered into communication with the comte de Provence (Louis XVIII.). He was the ruling spirit in the small committee formed in Paris to help forward a Restoration independent of the comte d'Artois and his party; but with the establishment of the Consulate he saw the prospects of the monarchy were temporarily hopeless, and the members of the committee resigned. From that time until the Restoration Royer-Collard devoted himself exclusively to the study of philosophy. He derived his opposition to the philosophy of Condillac chiefly from the study of Descartes and his followers, and from his early veneration for the fathers of Port-Royal. He was occupied with the erection of a system which should provide a moral and political education consonant with his view of the needs of France. From 1811 to 1814 he lectured at the Sorbonne. From this time dates his long association with Guizot. Royer-Collard himself was supervisor of the press under the first restoration. From 1815 onwards he sat as deputy for Marne in the chamber. As president of the commission of public instruction from 1815 to 1820 he checked the pretensions of the clerical party, the immediate cause of his retirement being an attempt to infringe the rights of the university of Paris by giving university diplomas, independent of university examinations, to the teaching fraternity of the Christian Brothers. Royer-Collard's acceptance of the Legitimist principle did not prevent a faithful adherence to the social revolution effected in 1789, and he protested in 1815, in 1820, and again under the monarchy of July against laws of exception.

He was the moving spirit of the "Doctrinaires," as they were called, who met at the house of the comte de Ste Aulaire and in the salon of Madame de Staël's daughter, the duchesse de Broglie. The leaders of the party, beside Royer-Collard, were Guizot, P. F. H. de Serre, Camille Jordan and Charles de Rémusat. In 1820 he was excluded from the council of state by a decree signed by his former ally Serre. In 1827 he was elected for seven constituencies, but remained faithful to his native department. Next year he became president of the chamber, and fought against the reactionary policy which precipitated the Revolution of July. It was Royer-Collard who in March 1830 presented the address of the 221. From that time he took no active part in politics, although he retained his seat in the chamber until 1839. He died at his estate of Châteauvieux, near Vitry, on the 2nd of September 1845. He had been a member of the Academy since 1827. Royer-Collard married in 1799 Mlle. de Forges de Châteauvieux. The two daughters who survived to womanhood received an education of the utmost austerity.

Royer-Collard left no considerable writings, but fragments of his philosophical work are included in Jouffroy's translation of the works of Thomas Reid. The standard life of Royer-Collard is by his friend Prosper de Barante, *Vie politique de M. Royer Collard, ses discours et ses écrits* (2 vols., 1861). There are also biographies by M. A. Philippe (1857), by L. Vingtain (1858), by E. Spuller (1895), in *Grands écrivains français*. Cf. E. Faguet, *Politique et morale du XIX^e siècle* (1891); H. Taine, *Les Philosophes français du XIX^e siècle* (1857); L. Schéle, *Les Derniers Jansénistes* (1891); and Lady Blennerhasset, "The Doctrinaires" in the *Cambridge Modern History* (vol. x. chap. ii., 1907). For further references see H. P. Thieme, *Guide bibliographique* (Paris, 1907).

ROYLE, JOHN FORBES (1799-1858), British botanist and teacher of materia medica, was born in Cawnpore in 1799. Entering the service of the East India Company as assistant surgeon, he devoted himself to studying botany and geology, and made large collections among the Himalaya Mountains. He also investigated the medical properties of the plants of

Hindustan and the history of their uses among the native races. The results of these investigations appeared in an essay *On the Antiquity of Hindoo Medicine* (1837). For nearly ten years he held the post of superintendent of the East India Company's botanic garden in the Himalayas at Saharanpur. In 1837 he was appointed to the professorship of materia medica in King's College, London, which he held till 1856. From 1838 onwards he conducted a special department of correspondence, relating to vegetable products, at the East India House, and at the time of his death he had just completed there an extensive and valuable museum of technical products from the East Indies. In 1851 he superintended the Indian department of the Great Exhibition. He died at Acton near London on the 2nd of January 1858.

The work on which his reputation chiefly rests is the *Illustrations of the Botany and other branches of Natural History of the Himalaya Mountains, and of the Flora of Cashmere*, in 2 vols. 4to, begun in 1839. In addition he wrote *An Essay on the Productive Resources of India* (1840), *On the Culture and Commerce of Cotton in India and Elsewhere* (1851) and *The Fibrous Plants of India fitted for Cordage* (1855), together with papers in scientific journals.

ROYSTON, a market town in the Hitchin parliamentary division of Hertfordshire, England, close to the border of Cambridgeshire, 48 m. N. of London by the Cambridge branch of the Great Northern railway. Pop. of urban district (1901) 3517. The church of St John the Baptist is mainly Early English. There are a market house, and institute with library and museum. Beneath a street in the town is a curious example of a hermit's cave, excavated in the chalk, and containing rude carvings of the crucifixion and other sacred subjects. It was discovered in 1742. The town lies on the Roman Ermine Street, at the point where it strikes from the hills across the plain, and its straight course is deflected slightly W. Roman relics have been found, and several barrows and earth-mounds occur on the neighbouring hills. A monastery of Augustinian canons was founded here towards the close of the 12th century, but there are no remains.

ROYTON, an urban district of Lancashire, England, within the parliamentary borough of Oldham, 2 m. N. of Oldham on the Lancashire & Yorkshire railway. Though of early origin, it is, as a town, of wholly modern growth. The cotton manufacture is its chief industry. Pop. (1901) 18,481.

ROZAS, JUAN MARTINEZ DE (1750-1813), the earliest leader in the Chilean struggle for independence, was born at Mendoza in 1750. In early life he was a professor of law, and of theology and philosophy at Santiago. He held the post of acting governor of Concepción at one time, and was also colonel in a militia regiment. In 1808 he became secretary to the last Spanish governor, Francisco Antonio Carrasco, and used his position to prepare the nationalist movement that began in 1809. After resigning his position as secretary, Rozas was mainly responsible for the resignation of the Spanish governor, and the formation of a national Junta on the 18th of September 1810, of which he was the real leader. Under his influence many reforms were initiated, freedom of trade was established, an army was organized and a national congress was called together in July 1811. But at the end of that year divisions began to arise between Rozas' followers from Concepción and the men of Santiago; and a feud broke out between Rozas and José Miguel Carrera (*q.v.*) who had secured control of Santiago. In 1812 Carrera succeeded in securing the banishment of his rival, who retired to Mendoza, where he died on the 3rd of March 1813.

See P. B. Figueroa, *Diccionario biográfico de Chile, 1550-1887* (Santiago, 1888), and J. B. Suarez, *Razgos biográficos de hombres notables de Chile* (Valparaíso, 1886); both giving biographical sketches of prominent characters in Chilean history.

RUBABON (*Rhithabon*), a town of Denbighshire, N. Wales, in the E. parliamentary division, near the Shropshire border, 5 m. S.W. of Wrexham, on the Great Western railway. Pop. (1901) 3248. It is situated on a small tributary of the Dee. The old Gothic church is thought by some to have been founded by Mabon, a brother of Llewelyn (13th c.), and has monuments

to the Wynn family, by Nollekens and Rhysbrac, and to Dr D. Powel (d. 1598), translator into English of Caradoc's (of Llancarfan) *History of Wales*. In the neighbourhood are collieries, engineering works, an iron foundry and chemical works, besides an extensive industry in glazed and other bricks. Near Rubabon is Caerddin (*Caerddin*), an ancient camp (village) surrounded by circular intrenchments, and Wynnstay, with an avenue of fine trees. Anciently the residence of Madoc ab Gruffydd Maelor (founder of Valle Crucis Abbey), it was called Wattstay, from Watt's Dyke, an old rampart on the estate. It was named Wynnstay on its coming into possession of the Wynns (17th c.). Offa's Dyke, near here, is 10 ft. high, and broad enough for two carriages abreast. Not far is Chirk Castle (supposed to have been built in 1013), besieged by Cromwell's artillery: near it, in the Ceiriog valley, the defeat of Henry II. by Owen Gwynedd took place in 1165.

RUBBER, INDIARUBBER or CAOUTCHOUC (a word probably derived from *Cahuca* or *Caucho* the names in Ecuador and Peru respectively for rubber or the tree producing it), the chief constituent of the coagulated milky juice or latex furnished by a number of different trees, shrubs and vines. The latex of the best rubber plants furnishes from 20 to 50% of rubber. The latex is not to be confused with the sap of trees, on the circulation of which their nutrition depends. Though frequently occurring, it is not a universal feature of plant life, and does not appear to be necessary or even directly connected with the nutritive system of plants. Its exact function is not fully understood. Latex, though chiefly secreted in vessels or small sacs which reside in the cortical tissue between the outer bark and the wood is also found in the leaves and sometimes in the roots or bulbs. The trees and plants whose latices furnish caoutchouc in considerable quantity chiefly belong to the natural orders Euphorbiaceae, Urticaceae, Apocynaceae, Asclepiadaceae. The latex is usually obtained from the bark or stem by making an incision reaching almost to the wood when the milky fluid flows more or less readily from the laticiferous vessels. It is, like milk, an emulsion, and when examined with the microscope is seen to consist of numerous globules suspended in a watery fluid. On standing, some latices separate, more or less readily, into an upper layer resembling cream and consisting of the globules, and a lower watery layer. This separation can be rapidly effected with some latices by the use of a centrifugal machine, but this method has not yet been applied to any extent commercially. The globules which furnish the cream gradually pass on standing into solid caoutchouc, a process which is facilitated by rapid stirring, or by the addition of an acid or other chemical agent. If the latex is warmed or an acid, an alkali or astringent plant juice is added to it, "coagulation" usually takes place more or less readily, the caoutchouc separating in solid flakes or curds. The efficacy of heat or of an acid, an alkali or other agent in promoting coagulation depends on the character of the latex, and varies with that obtained from different plants. The watery fluid in which the globules are suspended holds certain proteins, carbohydrates and a small proportion of salts in solution. The latex exhibits a neutral, acid or alkaline reaction depending upon the plant from which it has been obtained.

When exposed to air the latex gradually undergoes putrefactive changes accompanied by coagulation of the caoutchouc. The addition of a small quantity of ammonia or of formalin to some latices usually has the effect of preserving them for a considerable time. The nature of the coagulation is not yet completely understood. It has been compared with that of milk and of blood, which depend essentially on the coagulation or separation in curds of a proteid or albuminous substance, such as takes place when white of egg is warmed. There is, however, reason to believe that the coagulation of latex into rubber is not mainly of this character. The globules in the latex are liquid, and the phenomenon of coagulation would seem to consist in the passage of this liquid into solid caoutchouc through the kind of change known as polymerization or condensation, in which a liquid passes into solid without alteration

of composition or by condensation with the elimination of the elements of water. The effect of chemical agents in producing coagulation are in consonance with what is known of other instances of polymeric or condensation changes, whilst the fact that the collection of globules separated by creaming after thorough washing, and therefore removal of all proteid, is susceptible of solidification into caoutchouc by a merely mechanical act such as churning, strongly supports the view that the character of the change is distinct from that of any alteration which may occur in the proteid constituents of the latex.

The existence of caoutchouc or rubber was first observed soon after the discovery of America. It was noticed that certain Indian tribes of South America played with a ball composed of a resilient and elastic substance, which afterwards was found to possess the power of removing lead pencil marks from paper and came into commerce as "Indian Rubber." It was not until the middle of the 18th century that the trees which yielded caoutchouc were identified, chiefly by French observers. La Condamine ascertained the nature of the tree, now known as *Hevea brasiliensis*, from which the Para rubber of S. America was obtained, whilst a little later Fresneau and Aublet described the Euphorbiaceous trees which furnished the rubber of Guiana.

The methods adopted by the natives in S. America and in Mexico for incising the trees and obtaining the rubber are exceedingly primitive, but survive with little modification at the present day.

Statistics of Rubber Production.—Until recently rubber was obtained almost exclusively from the tropical forests of S. and Central America, E. and W. Africa and Asia, being the produce of naturally occurring trees and vines. The increase in the demand, for which the employment of rubber tires is largely responsible, has given an increased stimulus to the production of "wild" rubber, with the result that trees and vines have been recklessly cut and destroyed, and in some instances vast regions, as in the S. Sudan, have been nearly entirely denuded of rubber vines. This has led to restrictive measures, the vines being tapped under definite regulations as to the manner and time of tapping, and also to requirements as to replanting vines to take the place of those which have been injured or destroyed, certain areas being periodically closed. Such measures, which are now in operation in the French Sudan, the Congo and in German W. and E. Africa, can, however, only be enforced by special administrative machinery and at considerable expense, and this legislative action can only be regarded as temporary and preliminary to the establishment of plantations of rubber trees, which are not only easier to control, but the trees are less liable to injury from careless tapping. In Africa it seems probable that the production of rubber from vines is likely to be entirely superseded in process of time, and replaced by the plantations of trees which are already being established in those districts in which careful experiment has determined the kind of rubber tree best adapted to the locality. The forests of tropical America have suffered similarly, trees having been injured or destroyed and in some cases cut down in order to secure the immediate increase of supply which was called for by a considerable rise in value. The result has been that in the forests of Brazil and Mexico the conservation of rubber trees has received greater attention, whilst new and extensive areas are planted in S. and Central America. The wild rubber of S. and Central America is still the principal source of the rubber supply of the world, and is likely to continue to be so for many years to come. Although the cost of transport from the remote forest regions of some districts is a serious consideration, this is not likely to be operative in reducing production until there has been a considerable and permanent fall in price, by which time new areas in those countries in which planting is now taking place will probably have come into bearing.

The enormous increase in the commercial demand for rubber and the probability of the continuance of this increase in view

of the great variety of purposes to which the material can be applied, has led to great activity in rubber planting in other parts of the world, especially in Ceylon and the Malay Peninsula and Archipelago, where the Para rubber trees (*Hevea brasiliensis*) has been successfully introduced, and numerous plantations, many of which have not been in existence for more than ten or fifteen years, are now contributing to the world's supply. This rubber is known as "Plantation" rubber in contradistinction to the "wild" rubber.

"Plantation" Para rubber from Ceylon and the Malay States has brought prices equal to and often exceeding those of fine Para rubber from Brazil. This is largely due to the improved methods of preparing the rubber practised by the planters of Ceylon and Malaya, which lead to the exclusion of the impurities usually found in "wild" rubber. Para rubber from Brazil generally contains about 15% of water, whilst "plantation" Para is usually nearly dry and contains 1% of water or less. It would appear, however, that the finest "wild" Para rubber as a rule possesses greater tensile strength than the "plantation" rubber. This has been ascribed by some to the presence in "wild" rubber of certain impurities derived either from the latex or introduced during the preparation of the rubber which are thought to enhance the physical properties of the caoutchouc. It is more probable, however, that the superiority of the "wild" Para is principally due to the greater age of the forest trees from which the rubber is obtained, many of which are from thirty to fifty years old. It is well known that the *Hevea* tree usually furnishes very inferior rubber if tapped before it is six or seven years old, and there is evidence to show that the quality of the rubber improves with the age of the tree. The oldest of the plantation trees of Ceylon and Malaya are not much more than twelve years old, whilst it is to be feared that immature trees are often tapped and their latex mixed with that of older trees before coagulation, thus forming inferior rubber. It is therefore to be expected that as time goes on the quality of "plantation" rubber will improve, and there would seem to be no reason why it should not eventually be fully equal to that of the "wild" rubber.

In 1909 the total production of rubber is stated to have been about 70,000 tons, of which more than one-half came from tropical America, about one-third from Africa, whilst the remainder was chiefly of Asiatic origin, including "plantation" rubber from Ceylon and Malaya, which amounted to about 3000 tons.

Chiefly owing to the supplies of "wild" rubber which are still available, comparatively little has been done until recently in establishing plantations either in Africa or in tropical America, but in Asia, including Ceylon, India and Malaya, in which there are relatively few important naturally-occurring rubber plants, there has been for some years great activity in forming plantations of rubber trees introduced mainly from tropical America, and there are now many millions sterling of British capital invested in companies established to form rubber plantations chiefly in Ceylon and Malaya. Each year should therefore show an increase in the production of plantation rubber. No trustworthy estimate of the rate of the increase of production can, however, be formed, as several uncertain economic factors have to be taken into account. Among these are the precise extent of demand, the limit of the inevitable fall in price with largely increased production, the cost of labour as increasing amounts are required, and the effect of changed conditions on the output of "wild" rubber and the competition of the new plantations which are being established in tropical America.

There can be little doubt that with a fall in price further uses for rubber would arise, leading to an increased demand, and among them may be mentioned its utilization as a road material. Difficulties in the supply of labour in the East may hinder the further development of the rubber-planting industry, especially at a period when a reduction in the cost of production may be the chief problem. In 1909 the average cost of producing "plantation" rubber in Ceylon and Malaya



FIG. 11.—PARA RUBBER PLANTATION, CEYLON.



FIG. 12.—PARA RUBBER TREES, TAPPED—CEYLON.
(Soiral and V Systems.)



FIG. 13.—CEARA RUBBER TREE.



FIG. 14.—CASTILLOA RUBBER TREES.



FIG. 15.—*FICUS ELASTICA*.

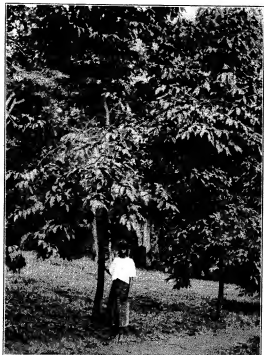

FIG. 16.—*FUNTUMIA ELASTICA*.

From Photographs in the Collections of the Imperial Institute.

may be stated approximately to have been from 10d. to 1s. per lb. The cost of collecting "wild" rubber is less easy to state with any approach to accuracy, since the cost varies in different districts of S. and Central America, but the average cost is stated not to be less than 1s. per lb. In Africa the cost of collection is much less, but the rubber is generally of inferior quality.

The market price of commercial rubber is determined by the current price of "fine Para" from S. America. This is subject to considerable fluctuation, and varied in 1900 to 1908 from 2s. 10d. to 5s. 9d. a lb. As much as 6s. 0d. per lb was given for specially prepared "plantation Para." Towards the latter part of 1904 the price of fine Para reached a high level and then considerably declined, reaching in 1907-8 a lower figure than had been recorded since 1900. At the beginning of 1908 the price gradually rose again to the neighbourhood of 4s. a lb. During 1909, without any serious decline in production, the price rapidly rose, owing to extraordinary causes, to about 10s. a lb., and in the early part of 1910 rose to over 12s. a lb., and subsequently fell to about half this price. Having regard to the present cost of producing "plantation" rubber, and to the probability that, apart from a possible increase in the price of labour, this cost is susceptible of further reduction, it may be concluded that rubber production will continue to be profitable even should a considerable fall in market value take place.

The Principal Rubber Trees, their Cultivation, and the Preparation of Rubber.—Most commercial rubber is derived from natural supplies, from the wild rubber trees of S. and Central America, India and Africa. Each year, however, the output of "plantation" rubber will show a considerable increase, and it is to be expected that ultimately this will form the chief source of supply, unless unforeseen circumstances should arise to interfere with the development of the plantation industry, which has been vigorously started chiefly with European capital in the tropical possessions of Great Britain, France and Germany. The best rubber is now obtained from large trees, of which the following are the more important:—

1. "Para" rubber, which takes the first position in the market, is derived from species of *Hevea*, principally *Hevea brasiliensis*, of which there are enormous forests in the valleys of the Amazon and its tributaries, and also in Peru, Bolivia, Venezuela and Guiana. In Brazil alone it is stated that the rubber area amounts to at least one million sq. m. The tree has been recently planted with great success especially in Ceylon and Malaya (Plate figs. 11 and 12).

2. " Ceara " or Maniçobá rubber is derived from species of *Manihot*, chiefly *Manihot Glaziovii*, a native of S. America especially abundant in Brazil, and successfully introduced into other countries (Plate fig. 13). The latex of this tree flows less freely than that of *Hevea brasiliensis*, and the collection of large quantities of the latex is attended with considerable difficulty. The latex is therefore usually allowed to coagulate on the tree, as it slowly exudes from the incision. On this account it is often exported in strings or "scrap" and not usually in biscuits or balls. Partly for this reason and partly because pieces of wood and dirt are apt to be included with the scrap, the market value of Ceara rubber is usually less than that of Para. The plantations of *Manihot* established in E. Africa, Ceylon and S. India have, however, begun to furnish a better quality of Ceara rubber, which is often prepared in biscuit form. Other species of *Manihot* are also under trial, and some give promise of good results, especially *M. dichotoma* and *M. heptaphylla*.

3. The "Ule" rubber of Central America and British Honduras originates from *Castilloa elastica*. In S. America its natural occurrence appears to be limited to west of the Andes, but the tree is abundant in Mexico, Guatemala and Nicaragua. The rubber comes into commerce in thick strips or sheets or as "scrap." The rubber is usually dark in colour and is often contaminated with proteid impurities derived from the latex. Ule rubber is generally inferior in strength to Para and commands a lower price. The *Castilloa* tree has been experimentally planted in Ceylon, the West Indies and other countries (Plate fig. 14).

Other trees occurring in S. America which furnish rubber of secondary commercial importance are *Hancornia speciosa*, yielding the Mangabeira rubber of Brazil, and species of *Sapium* furnishing the Colombian rubber and much of the rubber of Guiana (derived from *Sapium Jenmanni*), which is scarcely inferior to the rubber of Para.

4. "Rambong" or Assam rubber is the produce of *Ficus elastica*, commonly known as the indiarubber tree and cultivated in Europe as an ornamental plant. This tree, indigenous to Asia, attains large

dimensions in India, Ceylon and the Malay Archipelago (Plate fig. 15). It furnishes most of the rubber of India, Sumatra and Java. Although intrinsically of excellent quality, Rambong rubber, owing to the careless method of collection practised by the natives which leads to the inclusion of much impurity, usually fetches a lower price than Para. The tree has been introduced into W. Africa and Egypt, but has not proved very successful in Africa as a rubber producer.

5. "Lagos" rubber is the produce of the African rubber tree *Funtumia elastica*, which is indigenous to Africa from Uganda to W. Africa (Plate fig. 16). It is known as the silk rubber tree, probably on account of the silky hairs which are attached to the seeds. The latex, which is usually coagulated by standing or by heating, is obtained from incisions in the bark of the tree. The latex is of good quality, though, owing to the method of preparation, the product is often impure and discoloured, and consequently usually brings a lower price than the best rubbers of commerce.

6. Besides the trees described above, a number of climbing plants or vines belonging to the Apocynaceae secrete a latex which furnishes rubber of good quality. These vines are less satisfactory than trees as rubber producers, owing to the readiness with which they are injured and destroyed by careless tapping, and to the difficulty of incising in a suitable manner. The vines distributed over enormous areas of forest. Of these vines the most important are the species of *Landolphia* which occur throughout tropical Africa, including the Sudan, Congo, Mozambique and Madagascar, the principal of which are *Landolphia owarensis* and *L. Heudelottii*, common throughout W. Africa, and *L. Kirkii* and *L. Dawei* in E. Africa. The rubber is obtained by incising the stems of the vines and coagulating the latex by exposure, by admixture with acid vegetable juices or by heating. *Landolphia* rubber is usually roughly prepared and in consequence commands a low price. The vines of species of *Citandra* and *Carpodinus* in W. Africa also furnish good rubber, as do the *Forsteronia gracilis* of British Guiana and *Forsteronia floribunda* of Jamaica. Vines resembling *Landolphias* are widely distributed in Asia. Among these are species of *Willughbeia* and *Leucotis*, from which much of the rubber exported from Borneo is derived; *Parmeria glandulifera*, common in Siam and Borneo, and *Urecoia esculenta* and *Cryptosegia grandiflora*, both common in Burma.

Among other sources from which rubber is commercially obtained may be mentioned the Guayule plant (*Parthenium argentatum*) of Mexico, and the "Ecanda" plant of Portuguese W. Africa, from the tuberous roots of which rubber is extracted by the natives. The "Ecanda" plant has been named *Raphionacme utilis*. The root rubber prepared by the natives of the Congo and the S. Sudan is extracted partly from the roots of *Landolphia* or from the rhizomes of *Landolphia thollonii* or *Carpodinus lanceolatus*. It is obtained by incising the roots or rhizomes, the latex having been separated the rubber, and machines have now been devised for this purpose.

Little is at present known of the large rubber tree of Tonkin (*Blechnodea tonkinensis*), the latex of which is stated to furnish excellent rubber.

SOURCES OF COMMERCIAL RUBBER

1. PARA RUBBER is so named from the Para province of Brazil, from the principal town of which, also known as Para, most of the rubber is shipped. This rubber is obtained chiefly from *Hevea brasiliensis*, Mill. Arg., a large euphorbiaceous tree upwards of 60 ft. in height, and having trifoliate leaves, the leaflets being lanceolate and tapering at both ends (fig. 1). The trunk reaches about 8 ft. in circumference. The flowers are usually pale green. The fruit is a capsule containing three seeds rather larger than cobnuts, having a brown smooth surface figured with black patches. The seeds readily lose their vitality, and on this account need special care in transport. They should be loosely packed in dry soil or charcoal. These seeds have been examined at the Imperial Institute, and the kernels have been found to contain nearly half their weight (48%) of an oil resembling linseed oil and applicable for the same purposes. The residue or "cake" left after expression of the oil is apparently nutritious and may prove to be of value for feeding animals. There is present in the seeds an enzyme which rapidly decomposes the oil if the seeds are crushed and kept, setting free a fatty acid and glycerin. As the seeds are very abundant, they will probably be utilized commercially as soon as the demand for planting has subsided.

In Brazil the trees are found in different districts, but flourish best on rich alluvial clay slopes by the side of rivers, where there is a certain amount of drainage, and the temperature reaches from 89° F. to 94° F. at noon and is never cooler than 73° F. at night, while rain falls during about six months and the soil and atmosphere are moist throughout the year. The genus *Hevea* was formerly called *Siphonia*, and the tree named Pao de Xerringa by the Portuguese, from the use by the Omapua Indians of squirts or syringes made from a piece of pipe inserted in a hollow flask-shaped piece of rubber. The trees are not generally tapped until they are ten to fifteen years old, as young trees yield inferior rubber. If carefully conducted, tapping does not injure the tree. The latex is collected in the so-called dry season between June and February. The trees are tapped in the early morning when the latex is most readily obtained.

To obtain the latex, deep incisions are made near the base of the tree extending up the trunk. Small shallow cups are placed below the



FIG. 1.—*Hevea brasiliensis*.

incisions to receive the milk, each cup being attached by sticking a piece of soft clay to the tree and pressing the cup against it. The latex, of which each tree yields only about 6 oz. in three days, has a strong ammoniacal odour, which rapidly disappears, and in consequence of the loss of ammonia the latex will not keep for longer than a day unchanged; hence when it has to be carried to a distance from the place of collection, 3% of ammonia solution is added. The latex usually furnished about 30% of rubber.

To obtain the rubber, the latex is usually treated in the following manner. A piece of wood about 3 ft. long, with a flattened end forming a kind of paddle, is dipped in the milk, or this is poured over it as evenly as possible. The milk is then carefully dried by turning the mould round and round in the smoke produced by burning wood mixed with certain oily palm nuts; those of *Alseodes excelsa* are considered best, the smoke being confined within certain limits by the narrowness of the neck of the pot in which the nuts are heated. The cressote and other products from the smoke no doubt act antiseptically and prevent to a large extent the subsequent putrefaction of the proteids retained by the coagulated rubber. Each layer of rubber is allowed to become firm before forming another; a practised hand can make 5 or 6 lb in an hour. In some districts a stout stick is substituted for the paddle, on which the rubber as it coagulates is wound cylindrically. The rubber thus prepared is the finest that can be obtained. The cakes when completed are, in order to remove them from the mould, slit open with a sharp knife, which is kept wet, and are hung up to dry. The flat rounded cakes of rubber made in this manner are known in the London market as "biscuits." They retain about 15% of moisture. The scrapings from the tree, which contain fragments of wood, are mixed with the residues of the collecting pots and the refuse of the vessels employed, and are made up into large rounded balls, which form the inferior commercial quality called "negrohead," and often contain 25 or 35% of impurity. The yield of rubber varies, but it is stated on an average to be 10 lb of rubber per tree, and if carefully tapped one tree will yield this amount for many years in succession.

Plantations of Hevea brasiliensis.—*Hevea brasiliensis* was introduced to Ceylon and Singapore from seedlings raised at Kew from Brazilian seed, specially collected by Mr H. A. Wickham in S. America. The seedlings rapidly developed and in most places in which they were planted grew into large trees which furnished satisfactory latex when tapped in their sixth or seventh year. Ever since plantations of *Hevea* have been made on an increasing scale in the Straits Settlements, the Federated Malay States and in Ceylon, and at the present time rubber plantations form the principal industry in these colonies. Successful plantations of *Hevea* have also been established in Java, Sumatra and Borneo. Many of these plantations have not yet reached the productive stage—that is, the sixth or seventh year. A large number of plantations in British Malaya and Ceylon are now actively exporting increasing quantities of rubber. *Hevea* seedlings were also introduced into India, but did not apparently succeed except in Burma and S. India.

It may be estimated that between one and two million acres of land in the different countries referred to have been already

appropriated for rubber plantations. Plantations are also being formed in British, French and German possessions in W. Africa and in the Congo, also in the tropical portions of Australia. In certain districts of British W. Africa the *Hevea* which has been planted promises well, especially in the Gold Coast, where good yields of latex are stated to have been obtained.

It may be useful to summarize here the experience which has been gained in the formation of plantations of *Hevea* and in the production of rubber.

Hevea brasiliensis as a rule flourishes to the greatest extent at low altitudes on rich soil capable of retaining moisture. The nature of the soil appears, however, to be of secondary importance, provided that it is able to hold moisture and that climatic conditions of high and even temperature with considerable rainfall and absence of wind are satisfied. Although the tree is sensitive to such conditions, it appears to possess a certain capacity of adaptation which should be borne in mind. Generally a low altitude is desirable, but good results have been obtained in Ceylon in sheltered positions at elevations of 3000 ft. and over, although at higher altitudes the growth of these trees appears to be slower. In many plantations besides catch crops (cassava, sesame, ground-nuts, &c.) other crops, such as tea, coffee, cocoa and tobacco, are grown with rubber. It is improbable, except in the early stages of the rubber tree, that this procedure will succeed; the rubber will ultimately dominate the position to the detriment and ultimate extinction of the other crop, whilst the growth of the rubber tree will be retarded. A partial exception may perhaps be made in the case of cocoa, when the two plants are placed not too closely in about equal numbers. In these circumstances it appears that satisfactory results may be obtained from both crops, at any rate for a certain number of years.

The experience of planters in general is in favour of the complete removal of weeds from a rubber plantation. This practice, which involves periodical weeding, adds considerably to the cost of maintaining plantations, and, although justified so far by results, possesses several other disadvantages. During the tropical rain the soil is liable, to a greater or less extent, to denudation, which becomes very serious when the land slopes; and in any case, the soil is apt to become impoverished by the loss of its soluble constituents. These disadvantages are at their maximum when the rubber trees are quite young. At a later stage the shade of the large trees compensates to a considerable extent for the absence of cover on the ground. Another disadvantage of uncovered soil in a plantation of young rubber trees is that the ground under the heat of a tropical sun rapidly loses its moisture. For this reason proposals have been made to plant in the place of weeds low-growing leguminous plants, the growth of which will not only prevent impoverishment and loss of soil during the rains and conserve moisture in the heat, but will also have the effect of enriching the soil in nitrogenous constituents through the power leguminous plants possess of absorbing nitrogen from the air through nodules on their roots. Among the plants which are being tried for this purpose are various species of *Crotalaria*, passion-flower, and the well-known sensitive plant of the East. The success of the method cannot yet be judged, but the experiment is one which deserves very full trial.

One of the most important subjects in connexion with rubber plantations is the method to be adopted in tapping the trees for latex. The native methods in vogue in Brazil and Mexico are primitive and often injurious to the tree. At present it cannot be said that finality has been reached on the subject of the best method, giving a good return of latex with a minimum of damage to the tree. A method at once more largely adopted was to make a series of V-shaped incisions on four sides of the tree to a height of about 6 ft. from the base—that is, within the reach of an ordinary man without the need for ladder or scaffolding; the latex obtained from the upper part of the tree is said to furnish less rubber and of poor quality.

The latex is collected in cups placed at the apex of each V. Other systems are the herring-bone plan of a vertical channel

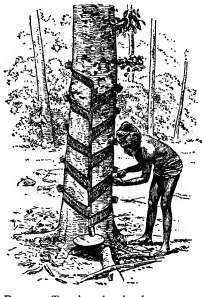

FIG. 2.—Tapping, herring-bone system

with lateral connecting channels about 1 ft. apart at an angle of about 45°, the latex being collected in cups placed at the base of the vertical channels (fig. 2); the spiral system, in which a series of spiral grooves are cut all round the trunk, by which means virtually the entire area of the trunk is tapped. In some instances a combination of these methods is employed. The V-system is the oldest, but is being largely superseded by the herring-bone; the spiral system is more recent and is still on trial.

Instead of the axe or large knives which frequently inflicted serious damage to the trees, special small knives and prickers are now employed so constructed as to avoid injury to the tree through making a larger incision than is necessary, and without penetrating into the wood below the laticiferous layer. It is possible to tap or prick trees daily for a number of years without apparent injury, but the practice of tapping on alternate days appears to be safer and to afford equally satisfactory if not better results. The yield of latex is at first small, but increases with successive tapplings, which appear to stimulate the local production of latex, and finally reaches a maximum.

When the bark has been removed a period of from three to four years must elapse before it is so fully renewed as to render fresh incisions possible. In the case of a tree from seven to ten years old, tapping is so arranged that by the time the last incisions on the original growth are made, the new growths on other portions are at least four years old, and ready for new incisions to be made. Too frequent tapping leads to the production of latex poor in caoutchouc, whilst tapping of trees before they are six or seven years old, and from 20-25 in. in circumference, produces inferior rubber. As a rule, an annual yield of more than 1-2 lb. of rubber per tree must not be looked for on recent plantations, although much higher yields of 10 to 15 lb. are now per tree are recorded from S. America, and it is therefore probable that with greater experience as to the best methods of tapping and with older trees considerably larger yields may be expected from plantations in the future. An average of 150 trees to the acre (20×15 ft.) and a yield of 1½ lb. of rubber per annum per tree at 2s. 6d. per lb. gives the result of £28, 2s. 6d. per acre. The cost of production may be assumed to be about 1s. per lb. to which has to be added the expense of transport. The cost of clearing forest land and planting with rubber in Ceylon is estimated at about 100 Rs. per acre in the first year, and from 20-30 Rs. per acre in subsequent years until the sixth year, when the plantation would begin to be productive.

The point of next importance is the coagulation of the latex so as to produce rubber in the form and of the quality required by the manufacturer. The primitive methods of coagulation and curing practised in S. America undoubtedly are susceptible of considerable improvement, and certainly waste can be reduced to a minimum. It is, however, important to remember that rough as these native methods are they result in the production of rubber which commands the highest price. As the removal of the impurities of the latex is one of the essential points to be aimed at, it was thought that the use of a centrifugal machine to separate the caoutchouc as a cream from the watery part of the latex would prove to be a satisfactory process. This method is said to answer well with the latex of *Castilloa*, but it appears to be inapplicable to the latex of *Hevea*, which does not cream readily when centrifuged.

The plan usually adopted is to collect the latex in rectangular tanks or casks. It is then coagulated by the addition of an acid liquid, acetic acid or lime juice being generally employed, and the mixture allowed to stand. The coagulated rubber separates as a mass of spongy caoutchouc. If the coagulation has been effected in shallow dishes, the rubber is obtained in a thin cake of similar shape known as a "biscuit."

The rubber thus formed is washed and dried. The coagulated rubber separated from the watery fluid is cut up into small pieces and passed through the grooved rollers of the washing machine, from which it issues in sheets, long crinkled ribbons or "crêpe," which are then dried in hot air chambers or in a vacuum dryer, by which means the water is dissipated at a lower temperature. In order to prevent decomposition of any proteid impurity which may remain incorporated with the rubber, the freshly coagulated rubber is sometimes cured in the smoke of burning wood or a small quantity of an antiseptic such as creosote is added during coagulation.

Plantation rubber comes into commerce in the form of the crinkled ribbons known as crêpe, in sheets or biscuits, and sometimes in large blocks made by compressing the crêpe rubber. Block rubber is considered to possess certain advantages in securing a constant proportion of water, and in being satisfactory for transport. The best condition and form in which to export rubber cannot be regarded as settled. The probabilities are that in the end the production of a rubber as nearly as possible free from water and impurities and of constant composition will be the best meeting the requirements of the modern manufacturer. The need for scrupulous cleanliness in the preparation of rubber is now recognized, and the arrangements of a rubber factory in Ceylon or Malaya are comparable with those of the modern dairy.

In the present transition stage of rubber production it is necessary for the manufacturer in Europe to wash all rubber. He receives

both the wild rubber containing variable quantities of impurity and the purer plantation rubber, the latter, however, in much smaller amount. The fact that at present washing machinery exists in all European factories and that most of the rubber received needs washing, leads to the greater purity of plantation rubber, except for special purposes, being generally discounted by the manufacturer. As soon as the output of plantation rubber of constant composition has reached such large dimensions it is probable that the manufacturer will be able to dispense with washing. This will operate to the advantage of plantation rubber and against the wild rubber, so long as the latter is not exported in a purer condition.

So far the *Hevea* plantations in Ceylon and the East have not been seriously troubled by insect or fungoid pests, and those which have occurred have succumbed to proper treatment. The most serious trouble has been occasioned in the Malay States by a white thread-like fungus (*Fomes semiotus*) which attacks the roots of the *Hevea* tree and eventually kills it. The development of this fungus is greatly promoted by the presence of decaying stumps and many plantations to remove all old wood and to extract stumps of old trees, which in the first instance it was considered unnecessary to remove.

2. *Manihot Glaziovii* belonging to the Euphorbiaceae is the tree of N.E. Brazil which furnishes Ceara or Maniçoba rubber (fig. 3).

It is closely related to the Manioc, cassava or tapioca plant (*Manihot utilisissima*) which it resembles when young and exhibits a similar tuberous root system. The tree grows well on dry and rocky soil without rain for a considerable period of the year, and flourishes at high altitudes up to about 4000 ft. It is therefore adapted for conditions which are usual in the tropics. The tree grows about 30 ft. high, with a rounded head of foliage, and greyish-green 3 to 7-lobed palmate leaves, somewhat resembling the leaves of the castor-oil plant in shape and size.

The seeds (fig. 3), which are abundant and retain their vitality well, have a hard thick coat. The seeds take a year to germinate, unless the edges near the end bearing the caruncular projecting are rasped off. Cuttings, if they have a single bud, strike readily.

The trees are tapped when they are about five years old. The mode of collecting the rubber is as follows. After brushing away the loose stones and dirt from the root of the tree by means of a handful of twigs, the collector lays down large leaves for the latex to drip upon. He then slices off the outer layer of the bark to the height of 4 or 5 ft. The latex, which exudes slowly and in many tortuous courses, some of it ultimately falling on the ground, is allowed to remain on the tree for several days, until it becomes dry and solid, when it is pulled off in strings, which are either rolled up into balls or put into bags in loose masses, in which form it enters commerce under the name of Ceara "scrap." Ceara rubber is also exported in the form of lumps and cakes. The annual yield of rubber is rather more than 1 lb. per tree. The latex coagulates readily, especially if churned or if diluted with water, when a purer rubber is obtained.

Manihot tree has been widely introduced into other countries, and appears to succeed wherever the rainfall is not excessive. In Ceylon and in some parts of India, especially in Madras, it has succeeded well. In W. Africa the tree flourishes, but it is under trial as a rubber producer. The *Manihot* tree also promises well in E. Africa, Nyasaland and the Mozambique. The pure Ceara rubber, as for example the "biscuits" prepared in Ceylon, is of excellent quality, scarcely if at all inferior to Para. That derived from Brazil, however, is generally inferior, being mixed with wood and dirt. The cultivation and collection of the rubber being troublesome, it is unlikely to be attended to in those countries in which the tree is 5 ft.

3. The source of "Ule" rubber exported from Central America, and of the "Cauchó" rubber of Peru is *Castilloa elastica*, Cerv., a lofty tree, N. O. Urticaceae, with a trunk 3 ft. or more in diameter, and large hairy oblong lanceolate leaves often 18 in. long and 7 in. wide (fig. 4). The tree grows most abundantly in a sporadic manner



FIG. 3.—*Manihot Glaziovii*. 1, branch with flowers; 2, fruit; 3, seed.

in the dense moist forests of the basin of the Rio San Juan, where the rain falls for nine months in the year. It prefers rich fertile soil on the banks of watercourses, but does not flourish in swamps. It is found also in Costa Rica, Guatemala, Honduras, Mexico, Cuba and Hayti, and in Panama with another species of *Castilloa*, and on the W. coast of S. America down to the slopes of Chimborazo; the Cordilleras of the Andes separating the *Castilloas* from the *Heveas* of Brazil.

In Nicaragua the latex is collected in April, when the old leaves begin to fall and the new ones are appearing, during which time the latex is richest.

The tree is tapped either in the same manner as the *Hevea*, or by encircling the tree with a simple spiral cut at an inclination of 45° , or by two parallel spirals if the tree be large. At the bottom of the spiral an iron spout about 4 in. long is driven into the tree, and the milk is received in iron pails. A tree 20 to 30 ft. high to its first branches, and about 4 ft. in diameter, is expected to yield annually 20 gallons of milk, each gallon giving about 2 lb of rubber. In the evening the milk is strained through a wire sieve and transferred to barrels. The milk, which is acid, is coagulated by the addition of the alkaline juice of the "achete" plant, or of another plant called "coasso." The strained juice of either of these plants, obtained by bruising the moistened herb and subsequent expression, is added to the milk in the proportion of about 1 pint to the gallon.

In British Honduras an alkaline decoction prepared from the Moon plant (*Caloniclyton speciosum*) is used for the same purpose. If these plants are not procurable, two parts of water are added to one of the milk, and the mixture allowed to stand for twelve hours. The coagulum is next flattened out by a wooden or iron roller to get rid of the cavities containing watery liquid, and the sheets are then hung up for fourteen days to dry, when they weigh about 2 lb. The sheets being usually $\frac{1}{4}$ to $\frac{1}{2}$ in. thick and 20 in. in diameter. When coagulated in water, the mass is placed in vats in the ground and allowed to dry, this taking place in about a fortnight. It is then rolled into balls. That which dries on the incisions in the tree is called "bola" or "burucha," and is said to be highly prized in New York. The loss of Nicaragua rubber in drying is estimated at 15%. It is exported chiefly from San Juan del Norte, or Grey Town, and the larger proportion goes to the United States. The *Castilloa* tree appears to be suitable for cultivation only in districts where the Para rubber would grow equally well. The tree is ready for tapping at about the same age as *Hevea* and the average yield of rubber is about the same. Since the latex "creams" readily the rubber can be separated from the latex by centrifugalizing, and its quality and market value thus enhanced. Much of the native *Castilloa* rubber is of inferior quality. The tree has been introduced into S. India, Ceylon and the W. Indies, where it has succeeded well, especially in Trinidad and Tobago. It is also under trial in E. and W. Africa and Nyasaland. Several other species of *Castilloa* than *C. elastica* are known to furnish rubber, but little has been recorded as to their advantages.

4. *Funtumia elastica* (formerly known as *Kickia* or *Kivia elastica*) is the W. African (Ire or Irai or Lagos) rubber tree, which belongs to the Apocynaceae, a natural order which includes the *Landolphia* vines as well as other rubber producers. It is a large forest tree of upright habit extending to 60 or 70 ft. in height and 3 to 4 ft. in diameter. The bright green, glabrous leaves are broad and oblong, about 6 in. in length (see fig. 5). The flowers are yellow, and the seeds enclosed in a pod are long and thin with numerous long silky fibres attached to them, which enable the seeds to be readily carried by the wind. The trees are common throughout the central regions of E. and W. Africa (from Uganda to Sierra Leone). The botanical name is taken from a W. African native name for a rubber tree—"Funtum."

Many of the trees in the accessible forests of W. Africa have been destroyed by over-tapping and felling. Plantations of *Funtumia* have been established in several districts, including the Gold Coast and S. Nigeria. The trees are tapped on the "herring-bone" plan and the milk collected in vessels at the base. This is then poured into the hollowed-out trunk of a tree, where it is allowed to stand covered with palm leaves for about a fortnight. The watery portion of the latex soaks into the trunk, and the soft spongy rubber which remains is kneaded and pressed into lumps or balls.

In some districts the collected milk is heated alone or diluted with water, to coagulate the rubber, but if heated alone an inferior rubber is apt to result owing to overheating.

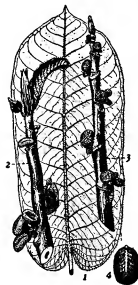

FIG. 4.—*Castilloa elastica*. 1, leaf; 2, twig with male flowers; 3, twig with female flowers; 4, seed; 4, nat. size.

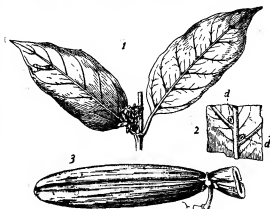

FIG. 5.—*Funtumia elastica* (Lagos rubber). 1, twig with flowers; 2, part of under side of leaf showing stomata at *d d* (about nat. size); 3, fruit (about $\frac{1}{3}$ nat. size).

The *Funtumia* latex can also be coagulated by the astringent infusion of *Bauhinia* leaves or by exposing it in shallow dishes, when the liquid "creams." The yield of rubber is stated as a rule to be less than that of Para. The rubber, if properly prepared, is of excellent quality, and the tree deserves further attention, especially in those regions of W. Africa which are unsuited to *Hevea*. *Funtumia africana* furnishes a very inferior rubber, which is highly resinous.

5. *Ficus elastica* is the tree which produces Rambong or Assam rubber. It is well known in Europe as a small ornamental tree, but in the tropics it attains very large dimensions, and develops a system of branching roots which act as buttresses to the large trunk (see fig. 6). It is a native of India, Burma and the Malay Archipelago, and is most abundant in those regions in which the climate is distinctly humid, and subject to this condition the tree flourishes at high altitudes. In Assam and in upper Burma there are extensive forests of *Ficus elastica*, but to a large extent the trees have been damaged by careless tapping. Large plantations have been formed by the Government of India both in Assam and Bengal, but most of the rubber exported is still obtained from the forest trees. It has been found that although the tree grows well in many different countries and different localities, it only furnishes a satisfactory yield of rubber in mountainous districts, such as those of Assam and certain parts of Ceylon and Java. The trees are tapped when about ten years old, and as a rule annually furnish from 5-10 lb of rubber per tree. The latex flows fairly well, but is usually allowed to dry on the tree.

The rubber, if of good quality, sells at prices only slightly inferior to that of Para. When the plantations of *Ficus* in India are in full bearing it is possible that this tree may attract more attention, since the plantation rubber is likely to be of superior quality owing to the greater care taken in its preparation. It seems at present doubtful, however, whether the establishment of plantations of *Ficus* will be profitable under ordinary conditions in India.

In addition to the trees described above there are numerous plants of some importance as rubber producers. Among these may be mentioned the *Landolphia* vines, which are still the chief source of African rubber. The vines grow upon forest trees, and these stems are periodically tapped. There are numerous species of these climbing plants, of which the most important as furnishing good rubber are *Landolphia owariensis* (see fig. 7), which occurs throughout

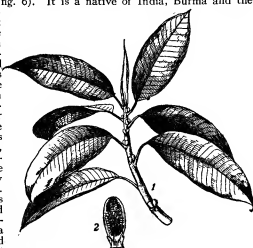

FIG. 6.—*Ficus elastica*. 1, twig; 2, section of inflorescence.

W. Africa and the Sudan, *Landolphia Heudelotii* of W. Africa, and *Landolphia Kirkii* and *L. Dawei*, which are found in the forests



Fig. 7.—*Landolphia cwiariensis*. 1, twig with flowers; 2, fruit.

of E. Africa. Other species of *Landolphia*, including *Landolphia florida*, abundant in both E. and W. Africa, furnish rubber of inferior quality.

Among other shrubs and vines which yield rubber of fair quality may be mentioned *Willughbeia edulis* and *Urceola elastica* and *Parameria glandulifera*, which occur in Burma and Malaya.

The *Sapiums* of Colombia and Guiana are large trees resembling *Hevea*, and certain species furnish good rubber, especially the *Sapium Jenmanii* of Guiana. Most of the native *Sapiums* have been destroyed by reckless tapping, and the merits of this genus have been somewhat overlooked and deserve reinvestigation. The same applies to certain species of *Hevea*, other than *H. brasiliensis*, which are known to produce good rubber in tropical America.

Pernambuco or Mangabeira rubber is obtained from *Hancornia speciosa*, Gom., an apocynaceous tree common on the S. American plateau in Brazil from Pernambuco to Rio de Janeiro, at a height of 3000 to 5000 ft. above the sea. It is about the size of an ordinary apple tree, with small leaves like the willow, and a drooping habit like a weeping birch, and has an edible fruit like a yellow plum called "mangaba," for which, rather than for the rubber, the tree is cultivated in some districts. Only a small quantity of this rubber comes to England, and it is not much valued, being a "wet" rubber. It is produced in "biscuits" or "sheets." The caoutchouc is collected in the following manner: about eight oblique cuts are made all round the trunk, but only through the bark, and a tin cup is fastened at the bottom of each incision by a means of a piece of soft clay. The cups when full are poured into a larger vessel, and solution of alum is added to coagulate the latex. In two or three minutes coagulation takes place, and the rubber is then exposed to the air on sticks, and allowed to drain for eight days. About thirty days afterwards it is sent to market. Pernambuco rubber, as is the case with most rubbers coagulated by saline solutions, contains a large quantity of water. The tree has been planted in other countries, but has so far not received much attention. It will grow on a dry sandy soil, dislikes much moisture, and needs no shade.

Forsteronia gracilis of Guiana is a climbing plant which also belongs to the Apocynaceae. Like the *Forsteronia floribunda* of Jamaica it yields rubber of good quality. *Ficus Vogelii* of W. Africa yields rubber of variable quality. The production of rubber by this tree merits further investigation, as it grows readily in nearly every district of W. Africa and the Sudan.

Specimens of the best known and of many of the lesser known rubbers are included in the Colonial and Indian Collections and Sample Rooms of the Imperial Institute, and many of the authentic specimens have been chemically and technically examined in the Scientific and Technical Department of the Institute and commercially valued. Reports on many of the lesser known rubbers have been published in the *Bulletin of the Imperial Institute*.

Chemistry of Rubber.

Rubber is chiefly composed of the soft, solid, elastic substance known as caoutchouc. It is usually assumed that this substance is present as such in the latex. The globules in the latex, however, consist more probably of a distinct liquid substance which readily changes into the solid caoutchouc. The coagulation of the latex often originates with the "curding" of the proteids present, and this alteration in the proteid leads to the solidification of the globules into caoutchouc. The latter, however, is probably a distinct effect. Under certain conditions, as when latex is allowed to stand or is centrifuged, a cream is obtained consisting of the liquid globules, which may be washed from the proteid without change, but either by mechanical agitation or by the addition of acid or other chemical agent, the liquid gradually solidifies to a mass of solid caoutchouc. The phenomenon therefore resembles the change known to the chemist as polymerization, by which through molecular aggregation a liquid may pass into a solid without change in its empirical composition. The effect may, however, also be due to chemical change known as condensation, and be accompanied by the elimination of the elements of water. So far the chemical nature of the liquid globules of the latex is unknown, and the exact character of the change into solid caoutchouc remains to be determined. The watery liquid known as rubber milk or latex is an emulsion consisting chiefly of a weak watery solution of proteids, carbohydrates and salts holding the liquid globules in suspension. In connexion with the production of rubber the most important factor is the proportion of caoutchouc it contains. In a good rubber this ranges from 70-90% and over. The proportion and nature of the proteids or albuminous materials varies considerably in different latices. The proteids should be as far as possible removed during the preparation of the rubber, as these substances are chiefly responsible for the objectionable smell and colour of "native" rubbers, and their presence leads to subsequent change in the commercial material. All crude rubber contains more or less proteid, and in the opinion of some technical experts its presence even affords strength to the material, but this cannot be accepted as proved. The dissolved salts (potassium, sodium, ammonium, calcium, magnesium, &c.) of the latex are generally nearly entirely absent from the well-prepared rubber. Of considerable importance to the value of the rubber is the absence of the resinous constituents which are present in greater or smaller proportion in all latices. The presence of more than a small percentage of resin in the latex leads to the production of rubber containing much resin, which seriously depreciates its commercial value for most purposes. The percentage of resin in a good rubber should be as small as possible, and should in any case be less than 10%. There is no feasible method at present known of preventing the inclusion of the resin of the latex with the rubber during coagulation, and although the separation of the resin from the solid caoutchouc by means of solvents is possible, it is not practicable or profitable commercially. A complete examination of a series of different latices has shown that, in many cases, e.g. *Hevea* and *Castilleja*, the resin is present in large proportion in the latex derived from young trees, and diminishes in amount as the trees age. This is one reason why young trees should not be tapped. The composition of latex and of typical rubbers is given below:—

RUBBERS

Para Latex (Ceylon).	Rubber (Ceylon).	Carra Rubber (Ceylon).	Castilleja Rubber (Ceylon).	Flow Elastic (Bengal).	<i>Landolphia</i> Kirkii (Africa).
Water. 57.15	Caoutchouc 76.25	76.25	86	86	86
Caoutchouc 42.29	Resin 2.56	10.04	12.12	11.8	6.9
Proteids 2.28	Proteids 1.75	8.05	0.87	0.8	0.3
Sugars 0.3	Salts 0.15	2.48	0.77	0.8	7.7
Ash (salts) 0.41	Moisture 0.85	3.20	0.52	0.8	..

The chemical analysis of crude rubber is an important guide to its value. At present, however, the methods of analysis usually employed are not sufficiently delicate to afford all the necessary information as to the intrinsic value of the higher grades of rubber, and do not go much beyond the exclusion of inferior rubber. The tests of the physical properties of crude rubber usually applied to determine its value in the market are also very rough and cannot be relied upon. The development of the rubber industry has now reached a stage at which more exact methods of determining the chemical composition and physical properties (strength and elasticity) of rubber are required. At present the caoutchouc present in crude rubber is usually estimated indirectly, and it is possible that what generally passes as caoutchouc may be in some instances a mixture of similar chemical substances, which if separated would be found to differ to those physical properties on which the technical value of rubber depends.

It is already certain that some commercial rubbers contain a variable proportion of a substance of the nature of caoutchouc, but having different properties.

True caoutchouc, the principal constituent of all rubbers, is probably essentially one and the same substance, from whatever botanical source it may have been derived. It is an elastic solid, almost transparent in thin sheets, composed entirely of carbon and hydrogen, the empirical composition of which is represented by

the formula $C_{15}H_{24}$. It thus possesses the same composition as the hydrocarbon of gutta-percha and as that of oil of turpentine and other terpenes which are the chief components of essential oils. The properties of caoutchouc clearly show, however, that its actual molecular structure is considerably more complex than is represented by the empirical formula, and that it is to be regarded as the polymer of a terpene or similar hydrocarbon and composed of a cluster of at least ten or twenty molecules of the formula $C_{15}H_{24}$.

When solid caoutchouc is strongly heated it breaks down, without change in its ultimate composition, into a number of simpler liquid hydrocarbons of the terpene class (dipentene, di-isoprene, isoprene, &c.), of which one, isoprene ($C_{15}H_{24}$), is of simpler structure than oil of turpentine ($C_{15}H_{24}$), from which it can also be obtained by the action of an intense heat.

When this volatile liquid hydrocarbon (isoprene) is allowed to stand for some time in a closed bottle, it gradually passes into a substance having the principal properties of natural caoutchouc. The same change of isoprene into caoutchouc may also be effected by the action of certain chemical agents. It may therefore be said that caoutchouc has been already artificially or synthetically prepared, and the possibility of producing synthetic rubber cheaply on a commercial scale remains the only problem. At present the change of isoprene into caoutchouc is mainly of scientific interest in indicating possibilities with regard to the conversion of the liquid globules of the latex into rubber and to the formation of rubber by plants. The exact chemical nature of caoutchouc is, however, not determined, and recent researches point to the view that its molecular structure may even be somewhat different from that of the terpenes.

The exact manner in which isoprene passes into caoutchouc is also not understood. These problems are, however, certain to be solved in the near future, and then probably caoutchouc may be formed in other ways than from isoprene.

The question as to whether synthetic rubber will ever be produced cheaply on a commercial scale is therefore the important one for those who are largely interested in the rubber-planting industry. No definite answer can be given to this question at the present time. Its settlement will depend in part on the cost of producing rubber plants, which from their poor view it is to the interest of planters to reduce as far as possible. There are many substances produced by plants which can be synthetically prepared by chemical means, but, as with quinine, the process involved is too costly to enable the synthetic product to compete with the natural product.

The chief properties of caoutchouc and its employment for technical purposes may now be considered.

Caoutchouc is not dissolved by water or alcohol, and is not affected except by the strongest acids. Alkalis have little effect on it under ordinary circumstances, although prolonged contact with ammonia results in a partial change. The best solvents for rubber are carbon bisulphide, benzene, and mineral naphtha, carbon tetrachloride and chloroform. These liquids, either alone or mixed, are employed in making the rubber solutions used for technical purposes. Vegetable and other oils rapidly penetrate caoutchouc and lead to deterioration of its properties. Sulphur when warmed with caoutchouc combines with it, and on this fact the vulcanization of rubber depends, and also the production, with an excess of sulphur, of the hard black material known as vulcanite or ebonite.

Caoutchouc is a soft elastic resilient solid. In this respect it differs from gutta-percha, which, like caoutchouc, is derived from the latex of certain trees, but whose technical value of caoutchouc chiefly depends on the extent to which it is capable of being stretched without breaking, and the extent to which it at once returns to its original dimensions. Caoutchouc is a bad conductor of heat and electricity, and alone or mixed with other materials is employed as an electrical insulator.

When caoutchouc is heated slightly above the temperature of boiling water it becomes softer and loses much of its elasticity, which, however, it recovers on cooling. At about 150° – 200° C. caoutchouc melts, forming a viscous liquid which does not solidify on cooling. This viscous liquid is present in small proportion in some commercial rubbers owing to overheating during their preparation. It appears to be the principal cause of stickiness or the "tacky" condition of some rubbers, which considerably depreciates their commercial value. There is some evidence that "tackiness" may be induced by a kind of fermentation which takes place in crude rubber.

At higher temperatures the viscous liquid suffers decomposition with the formation of various liquid hydrocarbons, principally members of the terpene series. Similar products are also formed by heating gutta-percha which closely resembles caoutchouc in its chemical structure.

Rubber slowly absorbs oxygen when exposed to air and light, the absorption of oxygen being accompanied by a gradual change in the characteristic properties of rubber, and ultimately to the production of a hard, inelastic, brittle substance containing oxygen. Ozone at once attacks rubber, rapidly destroying it. If ozone is passed into a solution of rubber in chloroform the caoutchouc combines with a molecule of ozone forming a compound of the empirical composition $C_{15}H_{24}O_3$. When this compound is acted on

by water, hydrogen peroxide and levulinic aldehyde are formed, the aldehyde being subsequently oxidized by the hydrogen peroxide, forming levulinic acid. The hydrocarbon of gutta-percha yields similar results and is therefore closely related to caoutchouc.

The study of the action of ozone on caoutchouc has thrown new light on the complex question of the chemical structure of this substance, and discloses relationships with the sugars and other carbohydrates from certain of which levulinic acid is obtained by oxidation.

Caoutchouc, like other "unsaturated" molecules, forms compounds with chlorine, bromine, iodine and sulphur.

Commercial Treatment of Rubber.

In the industrial working of indiarubber, the various impurities present in the crude "wild" rubber (bark, dirt and the principal impurities derived from the latex, except resin) are removed by the following process: The lumps of crude caoutchouc are first softened by the prolonged action of hot water, and then cut into slices by means of a sharp knife—generally by hand, as thus any large stones or other foreign substances can be removed. The softened slices are now repeatedly passed between grooved rollers, known



FIG. 8.—Roller of Washing Machine.

as washing rollers (fig. 8), a supply of hot or cold water being made to flow over them. Solid impurities speedily become crushed, and are carried away by the water, while the rubber takes the form of an irregular sheet perforated by numerous holes. The loss on washing ranges from 10–15% with "fine Para" to 40% with other "wild" rubbers. In the future this washing of "wild" rubber may be conducted in the factories, thus furnishing the manufacturer with rubber which, like "plantation" rubber, need not be subjected to this process in the factory. The washed product contains in its pores a notable proportion of water, which is removed by hanging the rubber for some days in a warm room. It is now ready either for incorporation with sulphur and other materials, or for agglomeration into solid masses by means of the masticating machine—an apparatus which consists of a strong cylindrical cast-iron casing, inside which there revolves a metal cylinder with a fluted or corrugated surface. Some of the rubber having been placed in the annular space between the inner cylinder and the outer casing, the former is made to revolve; and the continued kneading action to which the rubber is subjected works it into a solid mass, something like a gigantic sausage. Before commencing the mastication it is generally necessary to warm the apparatus by means of steam; but as the operation proceeds the heat produced requires to be moderated by streams of cold water flowing through channels provided for the purpose. The inner cylinder is generally placed somewhat eccentrically in the outer casing, in order to render the kneading more perfect than would otherwise be the case.

The so masticated rubber is cut into rectangular blocks, it is first softened by heat, and then forced into iron boxes or moulds. The blocks are cut into thin sheets by means of a sharp knife, which is caused to move to and fro about two thousand times per minute, the knife being kept moistened with water, and the block fed up to it by mechanical means. Cut sheets are largely used for the fabrication of certain classes of rubber goods—these being made by cementing the sheets together with a solution of rubber in naphtha or benzol. Most articles made of cut sheet rubber would, however, be of very limited utility were they not hardened or vulcanized by the action of sulphur or some compound of that element. After vulcanization, rubber is no longer softened by a moderate heat, a temperature of 160° C. scarcely affecting it, nor is it rendered rigid by cold, and the ordinary solvents fail to dissolve it. It must, however, be distinctly understood that it is not the mere admixture but the actual combination of sulphur with indiarubber that causes vulcanization. If an article made of cut sheet be immersed for a few minutes in a bath of melted sulphur, maintained at a temperature of 120° C., the rubber absorbs about one-tenth of its weight of that element, and, although somewhat yellowish in colour from the presence of free sulphur, it is still unvulcanized, and unaltered as regards general properties. If, however, it be now subjected for an hour or so to a temperature of 140° C., a combination occurs, and vulcanized caoutchouc is the result. When a manufactured article has been saturated with sulphur in the melted sulphur bath, the heat necessary for vulcanization may be obtained either by high-pressure steam, by heated glycerin, or by immersion in a sulphur bath heated to about 140° C. In this last case absorption of the sulphur and its intimate combination with the rubber occur simultaneously. Cut sheets, or articles made from them, may be

saturated by being laid in powdered sulphur maintained for some hours at about 110° C. Sheets sulphured in this way can be made up into articles and joined together either by warming the parts to be united, or by means of indiarubber solution; after which the true vulcanization, or "curing," as it is termed, can be brought about in the usual way.

Another method of vulcanizing articles made from cut sheet rubber consists in exposing them to the action of chloride of sulphur. Either they are placed in a leaden cupboard into which the vapour is introduced, or they are dipped for a few seconds in a mixture of one part of chloride of sulphur and forty parts of carbon disulphide or purified light petroleum. Vulcanization takes place in this instance without the action of heat; but it is usual to subject the goods for a short time to a temperature of 40° C. after their removal from the solution, in order to drive off the liquid which has been absorbed, and to ensure a sufficient action of the chloride of sulphur. Treatment with a warm alkaline solution is afterwards advisable, in order to remove traces of hydrochloric acid generated during the process. Another very excellent method of vulcanizing cut sheet goods consists in placing them in a solution of the polysulphides of calcium at a temperature of 140° C. Rubber employed for the manufacture of cut sheets is often coloured by such pigments as vermilion, oxide of chromium, ultramarine, ormin, antimony, lamp black, or oxide of zinc, incorporation being effected either by means of the masticator or by a pair of rollers heated internally by steam, and so geared as to move in contrary directions at unequal

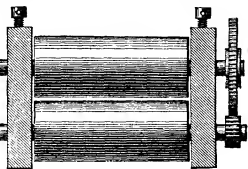

FIG. 9.—The Mixing Rollers.

speed (fig. 9). Most of the rubber now manufactured is not combined with sulphur when in the form of sheets, but is mechanically incorporated with about one-tenth of its weight of that substance by means of the mixing rollers—any required pigment or other matter, such as whitening or barium sulphate, being added. The mixed rubber thus obtained is readily softened by heat, and can be very easily worked into any desired form or rolled into sheets by an apparatus known as the calendaring machine. Vulcanization is then ensured by exposure for half an hour or more to a temperature of 135°–150° C., usually in closed iron vessels into which high-pressure steam is admitted (fig. 10). Tubes are generally made up

around mandrels, and allowed throughout the curing to remain imbedded in pulverized French chalk, which affords a useful support for many articles that tend to lose their shape during the process. Of late years a considerable amount of seamless tubing has been made, much in the same way as lead piping, by mixing the mixed rubber through a die, and curing as above. The calendared sheets are generally cured between folds of wet cloth, the markings of

rubber and frictioned canvas, as also are the so-called insertion sheets, in which layers of rubber alternate with canvas or even wire gauze. Indiarubber stereotypes are now extensively made use of as hand stamps, and attempts have been made to introduce them for press and machine printing. A plaster cast of the type is, when dry, saturated with shellac varnish and redried. Rubber mixed in the usual way with about 10% of sulphur is now softened by heat, forced into the mould, and retained there by pressure during the operation of curing, which is usually effected in an iron box heated over a gas burner to 140° C.

The ordinary macintosh or waterproof cloth is prepared by spreading on the textile fabric layer after layer of indiarubber paste or solution made with benzol or coal-naphtha. If cotton or linen is used, it is usual to incorporate stiburith with the paste, in order to effect vulcanization by steam heat; but, when silk or wool is employed, no sulphur is added to the paste, the dried coating of rubber being merely brought into momentary contact with the mixture of chloride of sulphur and carbon disulphide already mentioned. Double texture goods are made by uniting the rubber surfaces of two pieces of the coated material. Air goods, such as cushions, beds, gas bags, and so forth, are made of textile fabrics which have been coated with mixed rubber either by the spreading process, as above described, or by means of heated rollers, the curing then effected by steam heat. The manufacture of overshoes and fishing boots is an analogous process, only the canvas base is more thickly coated with a highly pigmented rubber of low quality. The articles are first fashioned by joining the soft material; they are then varnished, and afterwards cured in ovens heated to about 135° C. The fine vulcanized "spread sheets" are made by spreading layers of indiarubber solution, already charged with the requisite proportion of sulphur, on a textile base previously prepared with a mixture of paste, glue and treacle. Vulcanization is then effected by steam heat, and the preparation on the cloth being softened by water, the sheet of rubber is readily removed. The required thickness of the spread sheet is very often secured by the rubber-faced surfaces of two cloths being united before curing. The threads used in making elastic webbing are usually cut from spread sheets. The manufacture of springs, valves and washers does not require any very special notice, these articles being generally fashioned out of mixed rubber, and vulcanized either in moulds or in powdered French chalk. Rollers are made to adhere to their metal spindles by the intervention of a layer of ebonite, and after vulcanization they are turned. In order to make spongy or porous rubber, some material is incorporated which will give off gas or vapour at the vulcanizing temperature,—such as carbonate of ammonia, crystallized alum, and finely ground damp sawdust. Uncombined sulphur is introduced, and often leads to the decay of vulcanized goods, but an excess of sulphur is generally required in order to ensure perfect vulcanization. Sometimes the excess is partially removed by boiling the finished goods with a solution of caustic soda, or some other solvent of sulphur. In other cases the injurious effects of free sulphur are obviated by using instead of it a metallic sulphide,—generally the orange sulphide of antimony; but, for the best results, it is necessary that this should contain from 20 to 30 % of uncombined sulphur.

It will thus be seen that for nearly all practical purposes, including tires, vulcanized rubber mixed with mineral matter is employed. Such articles contain varying proportions of rubber (12–60%), about 1–2 % of combined sulphur, and from 25–70 % of mineral matter. Vulcanized rubber is also now largely used as an electrical insulator for the construction of cables, &c., instead of gutta-percha.

When the vulcanization of rubber is carried too far, from the presence of a very large proportion of sulphur and an unduly long action of heat, the caoutchouc becomes hard, brittle, and black. Rubber hardened by over-vulcanization is largely manufactured under the name of ebonite or vulcanite. It is usually made by incorporating about 40 % of sulphur with purified Borneo rubber by means of the usual mixing rollers, shaping the required articles out of the mass thus obtained, and heating for six, eight or ten hours to from 135° to 150°. Ebonite takes a fine polish, and is valuable to the electrician on account of its insulating properties, and the chemist and photographer because vessels of ebonite are unaffected by most chemical reagents. A kind of vulcanite which contains a large proportion of vermilion or other mineral pigment is used, under the name of dental rubber, for making artificial gums and supports for artificial teeth.

LITERATURE.—Henri Jumelle, *Les Plantes à caoutchouc et à gutta* (Paris, 1903); Dr O. Warburg, *Les Plantes à caoutchouc et leur culture* (Paris, 1902; French translation by J. Vilbouchevitch); Herbert Wright, *The Caoutchouc Industry of the West Indies and Rubber in the East; the official account of the Ceylon Rubber Exhibition, 1906*, edited by J. C. Willis, M. Kelway Bamber and E. B. Denham (Colombo, 1906); Yves Henry, *Le Caoutchouc dans l'Afrique occidentale française* (Paris, 1906); E. de Wildeman and L. Genill, *Lianes caoutchoucifères de l'Etat Indépendant du Congo* (Brussels, 1904); C. O. Weber, *The Chemistry of Indiarubber* (London, 1902); Selected papers from the *Kew Bulletin*, iii. "Rubber" (London, 1906); *Kew Bulletin*, 1906–9; *Bulletin of the Imperial Institute*, 1903–9. (W. R. D.)

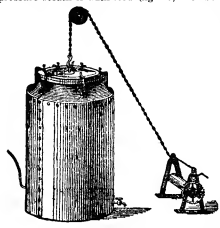

FIG. 10.—A Vulcanizer.

and hollow articles, such as playing balls, or articles which are vulcanized in iron or brass moulds, tinned inside and very slightly greased. Before it is put in, the article is roughly put together, and the expansion of the included air forces the rubber into contact with the internal surface of the mould, or a little carbonate of ammonia is enclosed. Belting intended for driving machinery is built up of canvas which has been thoroughly frictioned with the soft mixed rubber, and is cured by placing it in a kind of press kept by means of steam at a dry heat of about 140° C. Packing for the stuffing boxes of steam engines is similarly prepared from strips of

RUBBLE, broken stone, of irregular size and shape. This word is closely connected in derivation with "rubbish," which was formerly also applied to what we now call "rubble." The earlier Middle English form was *robeuz* or *robovus*. It would appear that the original is an O. Fr. *robel*. *Roba* (older form *robba*) is found in Italian in the sense of refuse, trash. *Robba* is explained by Florio as a gown, or mantle, robe, wealth, goods, trash. The original sense was "spoil." Thus, "robe," "rob," "rubbish" and "rubble" are all cognate.

"Rubble-work" is a name applied to several species of masonry (*q.v.*). One kind, where the stones are loosely thrown together in a wall between boards and grouted with mortar almost like concrete, is called in Italian *muraaglia di getto* and in French *bocage*. Work executed with large stones put together without any attempt at courses is also called rubble.

RUBELLITE, a red variety of tourmaline (*q.v.*) used as a gem-stone. It generally occurs crystallized on the walls of cavities in coarse granitic rocks, where it is often associated with a pink lithia-mica (lepidolite). The most valued kinds are deep red; the colour being probably due to the presence of manganese. Some of the finest rubellite is found in Siberia, whence it is sometimes called siberite, or passes under the misleading name of "Siberian ruby." The mills at Ekaterinburg, where it is cut and polished, draw most of their supplies from the Ural Mountains—chiefly from Mursinka, Sarapulskaya and Shaitanka, near Ekaterinburg—but specimens are occasionally found at Nerchinsk in Transbaikalia. Burma is famous for rubellite, but little was known as to the conditions of its occurrence there until after the British annexation, when the old workings were visited and described by C. Barrington Brown and by F. Noetling. The pits which yield rubellite are dug in alluvial deposits in the Mông-long valley, some miles to the S.E. of Mogok, the centre of the ruby country. It was here that the Chinese obtained the rubellite so much valued in China for buttons of the caps of mandarins of certain rank. In the British Museum there is a remarkable specimen of crystallized rubellite of large size and fine form, but of poor colour, which was presented by the king of Ava to Colonel Michael Symes on the occasion of his mission in 1795. Very fine rubellite is found in the United States, notably at Mount mica, near Paris, Oxford Co., Maine, where the crystals are often red at one end and green at the other. Mount Rubellite, near Hebron, and Mount Apatite at Auburn, are other localities in the same state from which fine specimens are obtained. Chesterfield and Goshen, Mass., also yield red tourmaline, frequently associated with green in the same crystal. Pink tourmaline also occurs, with lepidolite and kunzite, in San Diego Co., California. In Europe rubellite occurs sparingly at a few localities, as at San Piero in Elba and at Penig in Saxony; but the mineral is rarely if ever fit for the lapidary. (F. W. R.)*

RUBENS, PETER PAUL (1577-1640), Flemish painter, was born at Siegen, in Westphalia, on the 29th of June 1577. His father, Johannes Rubens, a druggist, although of humble descent was a man of learning, and councillor and alderman in his native town (1562). A Roman Catholic by birth, he became a zealous upholder of the Reformation, and we find him spoken of as *le plus docte Calviniste qui fust pour lors us Bas Pays*. After the plundering of the Antwerp churches in 1566, the magistrates were called upon for a justification. While openly they declared themselves devoted sons of the church, a list of the followers of the Reformed creed, headed by the name of Anthony Van Stralen, the burgomaster, got into the hands of the duke of Alva. This was a sentence of death for the magistrates, and Johannes Rubens lost no time in quitting Spanish soil, ultimately settling at Cologne (October 1568) with his wife and four children.

In his new residence he became legal adviser to Anne of Saxony, the second wife of the prince of Orange, William the Silent. Before long it was discovered that their relations were not purely of a business kind. Thrown into the dungeons of Dillenburg, Rubens lingered there for many months, his wife, Maria Pypelincx, never relaxing her endeavours to get the

undutiful husband restored to freedom. Two years elapsed before the prisoner was released, and then only to be confined to the small town of Siegen. Here he lived with his family from 1573 to 1578, and here Maria Pypelincx gave birth to Philip, afterwards town-clerk of Antwerp, and Peter Paul. A year after (May 1578) the Antwerp lawyer got leave to return to Cologne, where he died on the 18th of March 1587, after having, it is said, returned to Roman Catholicism.

Rubens went to Antwerp with his mother when he was scarcely ten years of age. He was an excellent Latin scholar, and also proficient in French, Italian, Spanish, English, German and Dutch. Part of his boyhood he spent as a page in the household of the countess of Laalaing, in Brussels; but tradition adds that his mother allowed him to follow his proper vocation, choosing as his master Tobias Verhaecht. Not the slightest trace of this first master's influence can be detected in Rubens's works. Not so with Adam Van Noort, to whom the young man was next apprenticed. Van Noort, whose aspect of energy is well known through Van Dyck's beautiful etching, was the highly esteemed master of numerous painters—among them Van Balen, Sebastian Vranck, and Jordaens, later his son-in-law.

Rubens remained with Van Noort for the usual period of four years, thereafter studying under Otto Vaenius or Van Veen, a gentleman by birth, a most distinguished Latin scholar and a painter of very high repute. He was a native of Leiden, and only recently settled in Antwerp. Though Rubens never adopted his style of painting, the tastes of master and pupil had much in common, and some pictures by Otto Vaenius can be pointed out as having inspired Rubens at a more advanced period. For example, the "Magdalene anointing Christ's Feet," painted for the cathedral at Malaga, and now at the Hermitage in St Petersburg, closely resembles in composition the very important work of Otto Vaenius in the church at Bergues near Dunkirk.

In 1598, Adam Van Noort acting as dean of the Antwerp guild of painters, Rubens was officially recognized as "master"—that is, was allowed to work independently and receive pupils. His style at this early period may be judged from the by no means satisfactory "Holy Trinity" at Antwerp Museum, which already shows his bold, vigorous handling, and the "Portrait of a Youth" in the Munich Pinakothek.

From 1600 to the latter part of 1608 Rubens belonged to the household of Vincenzo Gonzaga, duke of Mantua. The duke, who spent some time at Venice in July 1600, had his attention drawn by one of his courtiers to Rubens's genius, and immediately induced him to enter his service. The influence of the master's stay at Mantua was of extreme importance, and cannot be too constantly kept in view in the study of his later works.

Sent to Rome in 1601, to take copies from Raphael for his master, he was also commissioned to paint several pictures for the church of Santa Croce, by the archduke Albrecht of Austria, sovereign of the Spanish Netherlands, and once, when he was a cardinal, the titular of that sec. A copy of "Mercury and Psyche" after Raphael is preserved in the museum at Pesth. The religious paintings—"The Invention of the Cross," "The Crowning with Thorns" and "The Crucifixion"—are to be found in the hospital at Grasse in Provence (Alpes Maritimes).

At the beginning of 1603, "The Fleming," as he was termed at Mantua, was sent to Spain with a variety of presents for Philip III. and his minister the duke of Lerma, and thus had opportunity to spend a whole year at Madrid and become acquainted with some of Titian's masterpieces. Of his own works, known to belong to the same period, in the Madrid Gallery, are "Heraclitus" and "Democritus." Of Rubens's abilities so far back as 1604 we get a more complete idea from an immense picture now in the Antwerp Gallery, the "Baptism of Our Lord," originally painted for the Jesuits at Mantua. Here it may be seen to what degree Italian surroundings had influenced the household painter of Vincenzo Gonzaga. Vigorous to the extreme in design, he reminds us of Michelangelo as much as any of the degenerate masters of the Roman school

while in decorative skill he seems to be descended from Titian and in colouring from Giulio Romano. Equally with this picture, "The Transfiguration," now in the museum at Nancy, and the portraits of "Vincenzo and his Consort, kneeling before the Trinity," in the library at Mantua, claim a large share of attention.

Two years later we meet a very large altar-piece of "The Circumcision" at St Ambrogio at Genoa, the "Virgin in a Glory of Angels," and two groups of Saints, painted on the wall, at both sides of the high altar in the church of Santa Maria in Valicella in Rome. These works remind us of a saying of Baglione, who was acquainted with Rubens in Italy: *Apprese egli buon gusto, e diede in una maniera buona Italiana.*

While employed at Rome in 1608, Rubens received most alarming news as to the state of his mother's health. The duke of Mantua was then absent from Italy, but the dutiful son, without awaiting his return, at once set out for the Netherlands. When he arrived in Antwerp, Maria Pypelincx was no more. However strong his wish might now be to return to Italy, his purpose was overruled by the express desire of his sovereigns, Albrecht and Isabella, to see him take up a permanent residence in the Belgian provinces. On the 3rd of August 1609 Rubens was named painter in ordinary to their Highnesses, with a salary of 500 livres, and "the rights, honours, privileges, exemptions," &c., belonging to persons of the royal household, not to speak of the gift of a gold chain. Not least in importance for the painter was his complete exemption from all the regulations of the guild of St Luke, entitling him to engage any pupils or fellow-workers without being obliged to have them enrolled—a favour which has been of considerable trouble to the historians of Flemish art.

Although so recently returned to his native land, Rubens seems to have been, with one accord, accepted by his countrymen as the head of their school, and the municipality was foremost in giving him the means of proving his acquirements. The first in date among the numerous repetitions of the "Adoration of the Magi" is a picture in the Madrid Gallery, measuring 12 ft. by 17, and containing no fewer than eight-and-twenty life-size figures, many in gorgeous attire, warriors in steel armour, horsemen, slaves, camels, &c. This picture, painted in Antwerp, at the town's expense, in 1609, had scarcely remained three years in the town hall when it went to Spain as a present to Don Rodrigo Calderon, count of Oliva. The painter has represented himself among the horsemen, bare-headed, and wearing his gold chain. From a letter written in May 1611 we know that more than a hundred young men were desirous to become his pupils, and that many had, "for several years," been waiting with other masters until he could admit them to his studio.

Apart from the success of his works, another powerful motive had helped to detain the master in Antwerp—his marriage with Isabella Brant (October 1609). Many pictures have made us familiar with the graceful young woman who was for seventeen years to share the master's destinies. We meet her at the Hague, St Petersburg, Berlin, Florence, at Grosvenor House, but more especially at Munich, where Rubens and his wife are depicted at full length on the same canvas. "His wife is very handsome," observes Sir Joshua Reynolds, "and has an agreeable countenance;" but the picture, he adds, "is rather hard in manner." This, it must be noted, is the case with all those pictures known to have immediately followed Rubens's return, when he was still dependent on the assistance of painters trained by others than himself. Even in the "Raising of the Cross," now in the Antwerp cathedral, and painted for the church of St Walburga in 1610, the dryness in outline is very striking.

According to the taste still at that time prevailing, the picture is tripartite, but the wings only serve to develop the central composition, and add to the general effect. In Witdoeck's beautiful engraving the partitions even disappear. Thus, from the first, we see Rubens quite determined upon having his own way, and it is recorded that, when he painted

the "Descent from the Cross," "St Christopher," the subject chosen by the Arquebusiers, was altered so as to bring the artistic expressions into better accordance with his views. Although the subject was frequently repeated by the great painter, this first "Descent from the Cross" has not ceased to be looked upon as his masterpiece. Begun in 1611, the celebrated work was placed in 1614, and certainly no more striking evidence could be given of the rapid growth of the author's abilities. Rubens received 2400 florins for this picture. In many respects, Italian influence remains conspicuous in the "Descent from the Cross." Rubens had seen Ricciarelli's fresco at the Trinita de' Monti, and was also acquainted with the grandiose picture of Barocci in the cathedral of Perugia, and no one conversant with these works can mistake their influence. But in Rubens's strength of personality could not be overpowered by reminiscence; and in type, as well as in colouring, the "Descent from the Cross" may be termed thoroughly Flemish and Rubenesque.

If Sir Dudley Carleton could speak of Antwerp in 1616 as *Magna civitas, magna solitudo*, there was no place nevertheless which could give a wider scope to artistic enterprise. Spain and the United Provinces were for a time at peace; almost all the churches had been stripped of their adornments; monastic orders were powerful and richly endowed, guilds and corporations eager to show the fervour of their Catholic faith, now that the "monster of heresy" seemed for ever quelled. Gothic churches began to be decorated according to the new fashion adopted in Italy. Altars magnified to monuments, sometimes reaching the full height of the vaulted roof, displayed, between their twisted columns, pictures of a size hitherto unknown. No master seemed better fitted to be associated with this kind of painting than Rubens. The temple erected by the reverend fathers in Antwerp was almost entirely the painter's work, and if he did not, as we often find asserted, design the front, he certainly was the inspirer of the whole building. Hitherto no Fleming had undertaken to paint ceilings with foreshortened figures, and blend the religious with the decorative art after the style of those buildings which are met with in Italy, and owe their decorations to masters like Titian, Veronese and Tintoretto. No fewer than forty ceiling-panels were composed by Rubens, and painted under his direction in the space of two years. All were destroyed by fire in 1718. Sketches in water-colour were taken some time before the disaster by de Wit, and from these were made the etchings by Du Pont which alone enable us to form a judgment of the grandiose undertaking. In the Madrid Gallery we find a general view of the church in all its splendour. The present church of St Charles in Antwerp is, externally, with some alteration, the building here alluded to.

Rubens delighted in undertakings of the vastest kind. "The large size of a picture," he writes to W. Trumbull in 1621, "gives us painters more courage to represent our ideas with the utmost freedom and semblance of reality. . . . I confess myself to be, by a natural instinct, better fitted to execute works of the largest size." The correctness of this appreciation he was very soon called upon to demonstrate most strikingly by a series of twenty-four pictures, illustrating the life of Marie de Médicis, queen-mother of France. The gallery at the Luxembourg Palace, which these paintings once adorned, has long since disappeared, and the complete work is not exhibited in the Louvre. Drawings, it seems, had been asked from Quentin Varin, the French master who incited Poussin to become a painter, but Rubens was ultimately preferred. This preference may in some degree be ascribed to his former connexion with the court at Mantua, Marie de Médicis and the duchess of Gonzaga being sisters. From the cradle to the day of her reconciliation with Louis XIII., we follow Marie de Médicis after the manner in which it was customary in those days to consider personages of superior rank. The Fates for her have spun the silken and golden thread; Juno watches over her birth and entrusts her to the town of Florence; Minerva, the Graces and Apollo take charge of her education; Love

exhibits her image to the king, and Neptune conveys her across the seas; Justice, Health and Plenty endow her son; Prudence and Generosity are at her sides during the regency; and, when she resigns the helm of the state to the prince, Justice, Strength, Religion and Fidelity hold the oars. The sketches of all these paintings—now in the Munich Gallery—were painted in Antwerp, a numerous staff of distinguished collaborators being entrusted with the final execution. But the master himself spent much time in Paris, retouching the whole work, which was completed within less than four years. On the 13th of May 1625, Rubens writes from Paris to his friend Peiresc that both the queen and her son are highly satisfied with his paintings, and that Louis XIII. came on purpose to the Luxembourg, "where he never has set foot since the palace was begun sixteen or eighteen years ago." We also gather from this letter that the picture representing the "Felicity of the Regency" was painted to replace another, the "Departure of the Queen," which had caused some offence. Richelieu gave himself some trouble to get part of the work, intended to represent the life of Henry IV., bestowed upon Cavalier d'Arpina, but did not succeed in his endeavours. The queen's exile, however, prevented the undertaking from going beyond a few sketches, and two or three panels, one of which, the "Triumph of Henry IV.," now in the Uffizi Gallery, is one of the noblest works of Rubens or of any master.

On the 11th of May 1625, Rubens was present at the nuptials of Henrietta Maria at Notre Dame in Paris, when the scaffolding on which he stood gave way, and he tells us he was just able to catch an adjoining tribune.

No painter in Europe could now pretend to equal Rubens either in talent or in renown. Month after month productions of amazing size left the Antwerp studio; and to those unacquainted with the master's pictures magnificent engravings by Vorsterman, Pontius and others had conveyed singularly striking interpretations. "Whatever work of his I may require," writes Moretus, the celebrated Antwerp printer, "I have to ask him six months before, so as that he may think of it at leisure, and do the work on Sundays or holidays; no week days of his could I pretend to get under a hundred florins."

Of the numerous creations of his brush, none, perhaps, will more thoroughly disclose to us Rubens's comprehension of religious decorative art than the "Assumption of the Virgin" at the high altar of Antwerp cathedral, finished in 1625. It is, of twenty repetitions of this subject, the only example still preserved at the place for which it was intended. In spirit we are here reminded of Titian's "Assunta" in the cathedral at Verona, but Rubens's proves perhaps a higher conception of the subject. The work is seen a considerable way off, and every outline is bathed in light, so that the Virgin is elevated to dazzling glory with a power of ascension scarcely, if ever, attained by any master.

Although able to rely so greatly on his power as a colourist, Rubens is not a mere decorator. He penetrates into the spirit of his subjects more deeply than, at first sight, seems consistent with his prodigious facility in execution. The "Massacre of the Innocents," in the Munich Gallery, is a composition that can leave no person unmoved—mothers defending their children with nails and teeth. When St Francis attempts to shelter the universe from the Saviour's wrath (Brussels Gallery), Rubens recalls to our memory that most dramatic passage of the *Iliad* when Hecuba, from the walls of Troy, entreats her son Hector to spare his life. Rubens was a man of his time; his studies of Italian art in no way led him back to the Quattrocentisti nor the Raffaelschi; their power was at an end. The influence of Michelangelo, Titian, Tintoretto, more especially Barocci, Polidoro, and even Parmigiano, is no less visible with him than with those masters who, like Spranger, C. Schwartz and Goltzius, stood high in public estimation immediately before his advent.

In the midst of the rarest activity as a painter, Rubens was now called upon to give proofs of a very different kind

of ability. The truce concluded between Spain and the Netherlands in 1609 ended in 1621; Archduke Albrecht died the same year. His widow sincerely wished to prolong the arrangement, still hoping to see the United Provinces return to the Spanish dominion, and in her eyes Rubens was the fittest person to bring about this conclusion. The painter's comings and goings, however, did not remain unheeded, for the French ambassador writes from Brussels in 1624—"Rubens is here to take the likeness of the prince of Poland, by order of the infantina. I am persuaded he will succeed better in this than in his negotiations for the truce." But, if Rubens was to fail in his efforts to bring about an arrangement with the Netherlands, other events enabled him to render great service to the state.

Rubens and Buckingham met in Paris in 1625; a correspondence of some importance had been going on between the painter and the Brussels court, and before long it was proposed that he should endeavour to bring about a final arrangement between the Crowns of England and Spain. The infantina willingly consented, and King Philip, who much objected to the interference of an artist, gave way on hearing, through his aunt, that the negotiator on the English side, Sir Balthasar Gerbier—a Fleming by birth—was likewise a painter. Rubens and Gerbier very soon met in Holland. Matters went on very well, and Rubens volunteered to go to Spain and lay before the council the result of his negotiations (1628). Nine months were thus spent at Madrid; they rank among the most important in Rubens's career. He had brought with him eight pictures of various sizes and subjects as presents from the infantina, and he was also commissioned to paint several portraits of the king and royal family. An equestrian picture of Philip IV., destroyed by fire in last century, became the subject of a poem by Lope de Vega, and the description enables us to identify the composition with that of a painting now in the Palazzo Pitti, ascribed to Velazquez.

Through a letter to Peiresc we hear of the familiar intercourse kept up between the painter and the king. Philip delighted to see Rubens at work in the studio prepared for him in the palace, where he not only left many original pictures, but copied for his own pleasure and profit the best of Titian's. An artistic event of some importance connected with the sojourn in Spain is the meeting of Rubens and Velazquez, to the delight, and, it may be added, advantage of both.

Great as was the king's admiration of Rubens as a painter, it seems to have been scarcely above the value attached to his political services. He now commissioned the painter to go to London as bearer of his views to Charles I., and Rubens, honoured with the title of secretary of the king's privy council in the Netherlands, started at once on his new mission. Although he stopped but four days in Antwerp, he arrived in London just as peace had been concluded with France. Received by Charles with genuine pleasure, he very soon was able to ingratiate himself so far as to induce the king to pledge his royal word to take part in no undertakings against Spain so long as the negotiations remained uncompleted, and all the subsequent endeavours of France, Venice and the States found the king immovable in this resolution. The tardiness of the Spanish court in sending a regular ambassador involved the unfortunate painter in distressing anxieties, and the tone of his despatches is very bitter. But he speaks with the greatest admiration of England and the English, regretting that he should only have come to know the country so late. His popularity must have been very great, for on the 23rd of September 1629 the university of Cambridge conferred upon him the honorary degree of master of arts, and on the 21st of February 1630 he was knighted, the king presenting him with the sword used at the ceremony, which is still preserved by the descendants of the artist.

Although, it seems, less actively employed as an artist in England than in Spain, Rubens, besides his sketches for the decoration of the Banqueting Hall at Whitehall, painted the admirable picture of "The Blessings of Peace" now in the

National Gallery. There is no reason to doubt, with Smith, that "His Majesty sat to him for his portrait, yet it is not a little remarkable that no notice occurs in any of the royal catalogues, or the writers of the period, of the existence of such a portrait." While in England, Rubens very narrowly escaped drowning while going to Greenwich in a boat. The fact is reported by Lord Dorchester in a letter to Sir Isaac Wake (Sainsbury, cxvi.). At the beginning of March the painter's mission came to a close.

Rubens was now fifty-three years of age; he had been four years a widower, and before the end of the year (December 1630) he entered into a second marriage with a beautiful girl of sixteen, named Helena Fourment. She was an admirable model, and none of her husband's works may be more justly termed masterpieces than those in which she is represented (Munich, St Petersburg, Blenheim, Liechtenstein, the Louvre, &c.).

Although the long months of absence could not be termed blanks in Rubens's artistic career, his return was followed by an almost incredible activity. Inspired more than ever by the glorious works of Titian, he now produced some of his best paintings. Brightness in colouring, breadth of touch and pictorial conception, are specially striking in those works we know to have been painted in the latter part of his lifetime. Could anything give a higher idea of Rubens's genius than, for example, the "Feast of Venus," the portrait of "Helena Fourment ready to enter the Bath," or the "St Ildefonso"? This last picture—now, as well as the two others just alluded to, in the Vienna Gallery—was painted for the church of the convent of St Jacques, in Brussels. On the wings are represented the archdukes in royal attire, under the protection of their patron saints. The presence of these figures has led to some mistake regarding the date of the production, but it has been proved beyond doubt, through a document published by Mr Castan (1884), that the "St Ildefonso" (at Vienna—there is another resembling it at St Petersburg) belongs to the series of works executed after the journeys to Spain and England. Archduke Albrecht had been dead ten years. The picture was engraved by Witdoeck in 1638.

Isabella died in 1633, and we know that to the end Rubens remained in high favour with her, alike as an artist and as a political agent. The painter was even one of the gentlemen she deputed to meet Marie de Médicis at the frontier in 1631, after her escape from France.

Spain and the Netherlands went to war again, the king never ceasing to look upon the Dutch as rebels, and much trouble and suspicion came upon the great artist. As to the real nature of his communications with Frederick Henry of Orange, whom he is known to have interviewed, nothing as yet has been discovered.

Ferdinand of Austria, the cardinal-infant of Spain, was called to the government of the Netherlands on the death of his aunt. He was the king's younger brother, and arrived at Antwerp in May 1635. The streets had been decorated with triumphal arches and "spectacula," arranged by Rubens, and certainly never equalled by any other works of the kind.¹ Several of the paintings detached from the arches were offered as presents to the new governor-general, a scarcely known fact, which accounts for the presence of many of these works in public galleries (Vienna, Dresden, Brussels, &c.). Rubens was at the time laid up with gout, but Prince Ferdinand was desirous of expressing his satisfaction, and called upon the painter, remaining a long time at his house. Rubens and Ferdinand had met at Madrid, and only a short time elapsed before the painter was confirmed in his official standing—a matter of small importance, if we consider that the last years of his life were almost exclusively employed in working much more for the king than for his brother. About a hundred and twenty

¹ Many sketches of the arches are still preserved in the museums in Antwerp, St Petersburg, Cambridge, Windsor, &c. All the compositions were etched under the direction of Rubens by his pupil J. Van Thulden and published under the title of *Pompa introitus honori serenissimi Principis Ferdinandi Austriaci S. R. E. card. a. S. P. Q. Antwerp. decreta et ordinata.*

paintings of considerable size left Antwerp for Madrid in 1637, 1638 and 1639; they were intended to decorate the pavilion erected at the Pardo, and known under the name of Torre de la Parada. Another series had been begun, when Ferdinand wrote to Madrid that the painter was no more, and Jordaens would finish the work. Rubens breathed his last on the 30th of May 1640.

More fortunate than many artists, Rubens left the world in the midst of his glory. Not the remotest trace of approaching old age, nor the slightest falling of mind or skill, can be detected even in his latest works, such as the "Martyrdom of St Peter" at Cologne, the "Martyrdom of St Thomas" at Prague, or the "Judgment of Paris" at Madrid, where his young wife appears for the last time.

Rubens has little of the Italian grace and refinement; he was a Fleming throughout, notwithstanding his frequent recollections of those Italian masters whom he most admired, and who themselves have little, if anything, in common with Raphael. But it must be borne in mind how completely his predecessors were frozen into stiffness through italianization, and how necessary it was to bring back the Flemish school to life and nature. Critics have spoken of Rubens's historical improprieties. Of course nobody could suppose that his classical learning did not go far enough to know that the heroines of the Old Testament or of Roman history were not dressed out as ladies of his time; but in this respect he only follows the example of Titian, Paolo Veronese, and many others. In no other school do we find these animated hunts of lions, tigers, and even the hippopotamus and the crocodile, which may be reckoned among the finest specimens of art, and here again are life and nature displayed with the utmost power. "His horses are perfect in their kind," says Reynolds; his dogs are of the strong Flemish breed, and his landscapes the most charming pictures of Brabant scenery, in the midst of which lay his seat of Steen. As a portrait painter, although less refined than Van Dyck, he shows that eminent master the way; and his pure fancy subjects, as the "Garden of Love" (Madrid and Dresden) and the "Village Feast" (Louvre), have never been equalled.

For nearly one hundred years the Flemish school may be said to have been but a reflection of the Rubenesque principles. Although Jordaens and Erasmus Quellin lived till 1678, the school might be termed a body without soul.

Some etchings have been ascribed to Rubens, but except a head of 1639, the only copy of which is in the Print Room at the British Museum, and a beautiful figure of St Catherine, we can admit none of the other plates said to proceed from Rubens as authentic. Rubens nevertheless exercised an immense influence on the art of engraving. Under his direct guidance Soutman, Vorsterman, Pontius, Witdoeck, the two Bolswerts, Peter de Jode, N. Lauwers, and many others of less note, left an immense number of beautiful plates, reproducing the most celebrated of his paintings. To give an idea of what his influence was capable of accomplishing, pictorially speaking, it might be sufficient to notice the transformation undergone by the Antwerp school of engraving under Rubens; even the modern school of engraving, in more than one respect, is a continuation of the style first practised in Antwerp (see LINE ENGRAVING). His influence is scarcely less apparent in sculpture, and the celebrated Luke Fayd'herbe was his pupil.

Never did the Flemish school find a second Rubens. None of his four sons became a painter, nor did any of his three daughters marry an artist. According to Rubens's will, his drawings were to belong to that one of his sons who might become a painter, or in the event of one of his daughters marrying a celebrated artist, they were to be her portion. The valuable collection of engraving under Rubens, even the modern school of engraving, in more than one respect, is a continuation of the style first practised in Antwerp (see LINE ENGRAVING). His influence is scarcely less apparent in sculpture, and the celebrated Luke Fayd'herbe was his pupil.

Never did the Flemish school find a second Rubens. None of his four sons became a painter, nor did any of his three daughters marry an artist. According to Rubens's will, his drawings were to belong to that one of his sons who might become a painter, or in the event of one of his daughters marrying a celebrated artist, they were to be her portion. The valuable collection of engraving under Rubens, even the modern school of engraving, in more than one respect, is a continuation of the style first practised in Antwerp (see LINE ENGRAVING). His influence is scarcely less apparent in sculpture, and the celebrated Luke Fayd'herbe was his pupil.

Never did the Flemish school find a second Rubens. None of his four sons became a painter, nor did any of his three daughters marry an artist. According to Rubens's will, his drawings were to belong to that one of his sons who might become a painter, or in the event of one of his daughters marrying a celebrated artist, they were to be her portion. The valuable collection of engraving under Rubens, even the modern school of engraving, in more than one respect, is a continuation of the style first practised in Antwerp (see LINE ENGRAVING). His influence is scarcely less apparent in sculpture, and the celebrated Luke Fayd'herbe was his pupil.

1877); J. Smith, *Catalogue raisonné of the Works of the most eminent Dutch and Flemish Painters*, pt. ii. (London, 1830); Waagen, *Peter Paul Rubens* (translated from the German by R. Noel; edited by Mrs Jameson, London, 1840); H. Hymans, *Histoire de la gravure dans l'école de Rubens* (Brussels, 1879); C. G. Voorhelm Schneevoght, *Catalogue des estampes gravées d'après Rubens* (Haarlem, 1873); Max Rooses, *Rubens, sa vie et ses œuvres* (Antwerp, 1893); R. A. M. Stevenson, *P. P. Rubens* (Portfolio Monograph; London, 1898); Emile Michel, *Rubens; his Life, his Work and his Time* (London, 1899); H. Knackfuss, *Rubens* (London, 1904); and E. Dillon, *Rubens* (London, 1909).

RUBIACEAE, in botany, a large natural order of seed plants, belonging to the series Rubiales of the subclass Sympetalae (Gamopetalae) of Dicotyledons, and containing about 350 genera with about 4500 species. It is mainly a tropical family of trees, shrubs and herbs, but some of the tribes, especially Galieae, to which the British representatives belong and which contains only herbs, are more strongly developed in temperate regions; some species of *Galium* reach the Arctic zone and are found at high elevations on mountains in the tropics.

The most striking characteristic of the family are the opposite-decussate, generally entire, stipulate leaves. The stipules are varied in form; they generally stand between the petioles of a pair of leaves (interpetiolar). The two stipules of adjacent leaves are usually united, and in the Galieae, as well shown in the British species, are enlarged and leaf-like, forming with the two leaves an apparent whorl; by fusion or branching of the stipules the number of leaves in the whorl varies from four to eight or more. The flowers are rarely solitary, terminal or axillary, as in *Gardenia*; generally they are arranged in cymes or panicles or crowded into heads, and are often showy; in British members of the family they are very small, but may be conspicuous from their numbers, as in lady's bedstraw (*Galium verum*). The flowers are hermaphrodite and regular with parts in fours or fives; the four or five sepals, petals and stamens are placed above the ovary, which consists of two carpels, contains one to indefinite anatropous ovules in each of the two chambers, and is crowned by a simple style ending in a head or in two lobes. The sepals are often small, sometimes reduced to a narrow ring encircling the top of the ovary or altogether absent. The united petals form a corolla which varies widely in form in the different genera; it is often funnel- or salver-shaped, the honey, which is secreted by a disk round the base of the style, being at the bottom of a longer or shorter tube, in which case the flowers are adapted for pollination by Lepidoptera or bees, as in *Gardenia*, *Mussaenda*, *Gaeltarda*, &c.; in other cases it is bell-shaped or, as in *Galium*, rotate, with a short tube and sharply spreading segments; the honey is in these cases freely exposed or only slightly concealed and the flowers are pollinated by flies. The stamens are attached to the corolla-tube and alternate in position with its segments; the flowers are often dimorphic (or heterostyled) with short-styled and long-styled forms as in *Ipecacuanha* (see fig.).

The fruit also varies widely in form and is dry or fleshy. When dry it forms a capsule with septical or loculicidal dehiscence, or is a schizocarp separating when dry into two one-seeded mericarps which, as in the British cleavers (*Galium Aparine*), sometimes bear hooked appendages which aid their dispersal.

Some genera show a remarkable association with ants. Thus *Myrmecodia*, *Hymenophyllum* are epiphytic plants, in which the base of the stem forms a large tuber, which is attached to the support by numerous adventitious roots. The substance of the tuber is penetrated by numerous cork-lined cavities communicating by galleries, which are inhabited by ants. There is no evidence that the presence of the ants is of any service to the plant.

The order is divided into a large number of tribes based on the number of ovules in each ovary-chamber, the character of the fruit seed and ovule, and the aestivation of the corolla. These may be arranged in three families as follows:—

Cinchoneae, often woody plants with scale-like stipules, and numerous ovules in each ovary-chamber; the fruit is generally a capsule. To this belong *Cinchona* (*q.v.*), a genus of large trees with handsome flowers containing about forty species in the Andes of South America—it is well known as the source of Peruvian bark. An allied genus, *Banisteria* (*q.v.*), from tropical America, is cultivated for its flowers. The species of *Uncaria* climb by means of hooks which are modified inflorescence-axes.

Mussaenda, Gardenia (*q.v.*), and other genera are characterized by having a fleshy fruit.

Coffeae, often woody or shrubby plants with scale-like stipules; each ovary-chamber contains only one ovule. *Coffea* (*q.v.*), a genus of shrubs with about twenty-five species in the Old World tropics, includes the coffee plant (*C. arabica* and *C. liberica*); the fruit is a two-seeded drupe, the seed is the "coffee-bean." The thickened root of *Urugoa Ipecacuanha* yields ipecacuanha (*q.v.*).

Stellateae, here succulent plants with leaf-like stipules; each ovary-chamber contains one ovule only. Includes the four British genera *Rubia*, one species of which, *R. tinctorum*, is madder; *Galium*, including *G. verum* (lady's bedstraw), *G. Aparine* (goose-grass or

cleavers), and other British species; *Asperula*, including *A. odorata* (woodruff) and *Sherardia*.

The order is closely allied to Caprifoliaceae, the chief distinction being the absence of stipules in the latter.

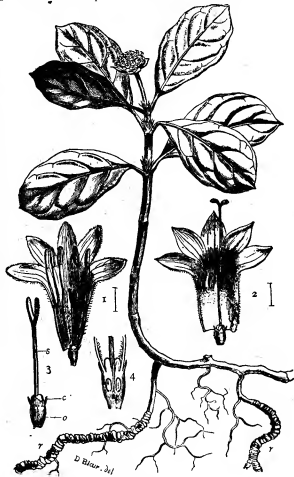

Ipecacuanha Plant.

RUBICON, a small stream of ancient Italy, which flowed into the Adriatic between Ariminum and Caesena, and formed the boundary between Italy and the province of Cisalpine Gaul. Hence Caesar's crossing of it in 49 B.C. was tantamount to a declaration of war against Rome as represented by Pompey and the Senate. The historic importance of this event gave rise to the phrase "crossing the Rubicon" for a step which definitely commits a person to a given course of action. There has been much controversy as to the identification of the stream; it appears that its upper course is represented by that of the Pisciatello (called Rubigone in the 11th or 12th century and now Rugeone or Urgone), and its lower portion by the Fiumicino, which the Urgone once joined. The point was marked by a station on the Via Aemilia below their confluence, 12 m. N.W. of Ariminum, bearing the name *ad Confluentes*; and here is still preserved a three-arched bridge, larger than is necessary for the water carried by the present Fiumicino.

RUBIDIUM [symbol Rb, atomic weight 85.45 ($O=16$)] a metallic element belonging to the group of the alkali metals. It is found in the minerals lepidolite, petalite and in various specimens of mica and of carnallite, and in some mineral waters. It also occurs in tea, cocoa, coffee, tobacco and in the ashes of beetroot. It was discovered by R. Bunsen and Kirchhoff (*Ann.*, 1860, 113, p. 337), in the spectroscopic examination of the residues obtained on evaporation of water from a mineral spring at Dürkheim, being characterized by two distinctive red lines. The best source of rubidium salts is the residue left after extracting lithium salts from lepidolite, the method of separation being based on the different solubilities of the platino-chlorides of potassium, rubidium and caesium

in water (R. Bunsen, *Ann.*, 1862, 122, p. 351). A somewhat similar process based on the varying solubilities of the corresponding alums has also been devised by Redtenbacher (*Jour. prak. Chem.*, 1865, 95, p. 148). The metal is prepared by distilling the carbonate with carbon (an explosive compound similar to that obtained from potassium and carbon monoxide is liable to be formed simultaneously); by reducing the hydroxide with aluminium: $4\text{RbOH} + 2\text{Al} = \text{Rb}_2\text{O} \cdot \text{Al}_2\text{O}_3 + 2\text{Rb} + 2\text{H}_2$ (N. Beketoff, *Ber.*, 1888, 21, p. 424, ref.); by reducing the carbonate (C. Winckler, *Ber.*, 1890, 23, p. 51) or the hydroxide with magnesium (H. Erdmann and P. Köthner, *Ann.*, 1899, 294, p. 55); and by heating the fused chloride with calcium in an exhausted glass tube at 400–500° C. (L. Hackspill, *Comptes rendus*, 1905, 141, p. 101). The metal was first obtained electrolytically in 1910 by electrolyzing the fused hydroxide in a nickel vessel, with an iron wire cathode and iron cylinder anode; the product on cooling being opened under pyridine cooled by a freezing mixture (G. von Hevesy, *Zeit. anorg. Chem.*, 1910, 67, p. 242). It is a silvery white metal which melts at 38.5° C. and has a specific gravity of 1.52. It oxidizes rapidly on exposure to air, and decomposes cold water very rapidly. It closely resembles caesium and potassium in its general properties. The rubidium salts are generally colourless, mostly soluble in water and isomorphous with the corresponding potassium salts.

Rubidium hydride, RbH, was obtained in the form of colourless needles by H. Moissan (*Comptes rendus*, 1903, 136, p. 587) from the direct combination of its constituent elements. It rapidly dissociates when heated in vacuo to 300° C. The existence of the compound RbO appears to be doubtful; the results of Erdmann and Köthner (*loc. cit.*) pointing to the formation of Rb_2O by the direct union of the metal with dry oxygen. E. Rengade (*Comptes rendus*, 1907, 144, p. 920), by partially oxidizing the metal in a current of dry oxygen and removing excess of metal by distillation in vacuo, has obtained oxides of composition Rb_2O_3 (yellowish white), Rb_2O_4 (black) and Rb_2O_5 (yellow). Rubidium hydroxide, RbOH, is a colourless solid which is formed by the action of rubidium on water, or the addition of water to a saturated solution of rubidium sulphate. It is readily soluble in water, the solution being very alkaline and caustic. It melts at 301°. Evaporation of the aqueous solution at 15° C. deposits a crystalline hydrated hydroxide of composition $\text{RbOH} \cdot 2\text{H}_2\text{O}$ (R. de Forcrand, *Comptes rendus*, 1909, 149, p. 1341). Rubidium chloride, RbCl, is formed on burning rubidium in chlorine, or on dissolving the hydroxide in aqueous hydrochloric acid. It crystallizes in colourless cubes and volatilizes when heated very strongly. It is soluble in water and combines with metallic chlorides to form double salts. It combines also with iodine chloride and bromine and with bromine chloride and with bromine (H. L. Wells and H. L. Wheeler, *Amer. Jour. Sci.*, 1891 (3), 43, p. 475).

Rubidium sulphate, Rb_2SO_4 , is formed by the action of sulphuric acid on the carbonate or hydroxide of the metal, or by the action of milk of lime on rubidium alum, the excess of lime being precipitated by rubidium carbonate and the solution neutralized by sulphuric acid. It forms large colourless hexagonal crystals. Several sulphides of the metal have been described by W. Biltz and E. Wilke-Dörft (*Zeit. anorg. Chem.*, 1906, 48, p. 297). The normal sulphide, $\text{Rb}_2\text{S} \cdot 4\text{H}_2\text{O}$, is colourless, and when heated in aqueous solution with the requisite amount of sulphur is transformed into the yellow tetrasulphide, $\text{Rb}_2\text{S}_4 \cdot 2\text{H}_2\text{O}$. A pentasulphide, Rb_2S_5 , which crystallizes in red prisms melting at 223° C., is also obtained by the direct union of sulphur and the solution. When heated in a current of hydrogen it is transformed into the colourless disulphide, whilst if the heating be carried out in a current of nitrogen it yields the trisulphide, $\text{Rb}_2\text{S}_3 \cdot \text{H}_2\text{O}$. These sulphides are much less hygroscopic than the corresponding caesium compounds. Rubidium nitrate, RbNO_3 , obtained by the action of nitric acid on the carbonate, crystallizes in needles or prisms and when strongly heated is transformed into a mixture of nitrite and oxide. Rubidium ammonium, RbNH_2 , was prepared by H. Moissan (*Comptes rendus*, 1903, 136, p. 1177) by the action of liquid ammonia on rubidium. The product combines with acetylene to form rubidium acetylide acetylene, $\text{Rb}_2\text{C}_2\text{H}_2$, which on heating in vacuo loses acetylene and leaves a residue of rubidium carbide Rb_2C_2 (liq. p. 1217). Rubidium carbonate, Rb_2CO_3 , formed by the addition of ammonium carbonate to rubidium hydroxide, is a crystalline mass which melts in its water of crystallization when heated.

The atomic weight of rubidium was determined by R. Bunsen (*Pogg. Ann.*, 1861, 113, p. 339), Picard (*Zeit. anal. Chem.*, 1862, 1, p. 519) and Godeffroy (*Ann.*, 1876, 181, p. 185), the methods being based on the conversion of rubidium halides into the corresponding silver salt, and the values obtained vary from 85.40 to 85.50. The

determination of E. H. Archibald (*Jour. Chem. Soc.*, 1904, 85, p. 776) from the analysis of the chloride and bromide gives the mean value as 85.485 (O = 16).

RUBINSTEIN, ANTON GRIGOROVICH (1829–1894),

Russian pianist, born of Jewish parentage on the 25th of November 1829 at Wechwotynetz, in Podolia, was the son of a pencil manufacturer who migrated to Moscow. The Rubinstein family, at the dictate of Anton's grandfather Roman Rubinstein, had all been baptized at the time of the ukase against the Jews issued in 1830 by the Tsar Nicholas. Anton was then one year old. Besides his mother he had but one teacher, the piano master Alexander Villoing, of whom he declared at the end of his own career that he had never met a better. In July 1838 Rubinstein appeared in the theatre of the Petrowski Park at Moscow; and in the year following he went to Paris after Villoing, and in 1840 played before Liszt. For some time after this Rubinstein travelled in Holland, Germany and Scandinavia, and reached England in 1842, where on the 20th of May he made his first appearance at a Choral Fund concert. In 1845, after a brief visit to Moscow in 1843, he went with his family (including his brother Nikolaus) to Berlin in order to complete his musical education. Dehn was their master, and Mendelssohn, whom Rubinstein had met previously in London, their best friend. The sudden death of Rubinstein's father necessitated the withdrawal of his mother and Nikolaus to Moscow, while Anton, on Dehn's advice, went to Vienna to seek a livelihood. Hence, after more hard study for nearly two years, he went with the flautist Heindl, and later alone, on a concert tour in Hungary; and the outbreak of the revolution in Vienna preventing his return there, he went via Berlin to St Petersburg, where the Grand Duchess Hélène appointed him Kammervirtuos. About this time an unfortunate error of the police nearly caused his expatriation to Siberia, from which he was saved by his patroness. During the next eight years Rubinstein spent most of his time in St Petersburg studying, playing and composing. His opera *Dmitri Donskoi* was produced there in 1851, and *Toms der Narr* in 1853. *Die Sibirischen Jäger*, written about the same time, was not produced. On the advice of his patroness and Count Wilhorsi he visited Hamburg and Leipzig, and arrived for the second time in London in 1857, when at a Philharmonic concert he introduced his own concerto in G. In the following year he was in London again, having in the meantime been appointed Concert Director of the Royal Russian Musical Society. In 1862, in collaboration with Carl Schuberth, he founded the St Petersburg Conservatorium, of which he was director until 1867. In 1868 he travelled in Germany, France and England, and remained for some time in Vienna, where he introduced a large number of his own compositions. Thence he went to America in 1872 and 1873, when he returned to Russia, and after a short rest set off once more on concert tours. In this manner the rest of his life was spent, until in 1885 he began a series of historical recitals of immense interest, which he gave in most of the chief European capitals. He died on the 20th of November 1894.

In addition to the works already named, Rubinstein left compositions in almost every known form. Among other of his operas are *Die Kinder der Heide*, *Feramos (Lalla Roukh)*, *Nero*, *Der Dämon* and *Die Makkaber*, this last perhaps more frequently played than all the others, of which the chief defect is their lack of dramatic point. On the subject of oratorio Rubinstein held original views, though his attempt to realize them in *Moses* and *Christus* was not completely successful, while his efforts in Berlin and London to found a Sacred Theatre failed entirely. Nevertheless he himself regarded the *Christus* as his greatest achievement. The most familiar of his five symphonies are the "Ocean" and the "Dramatic." He wrote scores on scores of pianoforte works, from complex concertos to the most commonplace *salonstücke*; abundance of concerted chamber-music, and a number of songs and duets, which enjoyed some popularity. He also published several books, including his *Reminiscences* and *Die geistliche Oper*.

Rubinstein's fame as one of the greatest of pianists will live in history. His technique bore comparison with that of Liszt; he possessed a power for interpreting the most different kinds of music which has not been surpassed.

His brother NIKOLAUS (1835-1881) was also a remarkable pianist, and a marvellous teacher of music. He founded the conservatorium of music at Moscow.

See Bernhard Vogel, *Anton Rubinstein, Biographischer Abriss* (Leipzig, 1888); Alexander MacArthur, *Anton Rubinstein, a Biographical Sketch* (Edinburgh, 1889); Eugen Zabel, *Anton Rubinstein, Ein Künstlerleben* (Leipzig, 1892); Anton von Halten, *Anton Rubinstein* (Utrecht, 1886); Cuthbert H. Cronk, *The Works of Anton Rubinstein* (London, 1900).

RUBRIC (Fr. *rubrique*, Lat. *rubrica*, *ruber*, red), in its earliest and original sense, red earth or ochre, ruddle, and hence applied to words written or printed in red lettering, in MSS. or printed books, such as chapter headings, paragraphs, initial letters, &c., thus marking in a distinctive manner that to which attention is to be drawn. The term was also applied to the passages so marked, and more especially to the directions or rules as to the conduct of divine service in liturgical books. This is the chief current usage of the term (see LITURGY).

RUBRUQUIS (or **RUBROQUIS**), **WILLIAM OF** (c. 1215-1270; fl. 1253-55), Franciscan friar, one of the chief medieval travellers and travel-writers. Nothing is known of him save what can be gathered from his own narrative, and from Roger Bacon, his contemporary and brother Franciscan. The name of Rubruquis ("Frater Willielmi de Rubruquis") is found in the imperfect MS. printed by Hakluyt in his collection, and followed in his English translation, as well as in the completer issue of the English by Purchas. Writers of the 16th, 17th and 18th centuries have called the traveller *Risbroucke* and *Rysbrokius* (*Rysbroek* and *Ruysbroek* in the *Biographie universelle* and *Nouv. biog. générale*)—an error founded on the identification of his name of origin with Ruysbroeck in Brabant (a few miles south of Brussels) and perhaps promoted by the fame of John of Ruysbroeck or Rysbroeck (1294-1381), a Belgian mystic, whose treatises have been reprinted as late as 1848. It is only within the last twenty years that attention has been called to the fact that Rubrouck is the name of a village and commune in old (medieval) French Flanders, belonging to the canton of Cassel in the department du Nord, and lying some 8½ m. N.E. of St. Omer. In the library of the latter city many medieval documents exist referring expressly to de Rubroucks¹ of the 12th and 13th centuries. It may be fairly assumed that Friar William came from this place;² thus Hakluyt's conclusion is justified, as expressed in the title he gives to Lord Lumley's MS. printed by him, now in the British Museum, MSS. Reg., 14 C. xiii. fol. 225 r-36 r. (*Itinerarium fratris Willielmi de Rubruquis de ordine fratrum Minorum, Galli, Anno gratie 1253, ad partes Orientales*).

Friar William went to Tartary under orders from Louis IX. (St. Louis). That king, at an earlier date, viz. December 1248, when in Cyprus, had been visited by alleged envoys from Elchigaday (Ilchikadai, Ilchikadai), who commanded the Mongol hosts in Armenia and Persia. The king then despatched a return mission consisting of Friar Andrew of Longjumeau or Lonjumeil and other ecclesiastics, who carried presents and letters for both Ilchikadai and the Great Khan. They reached the court of the latter in the winter of 1249-50, when there was no actual khan on the throne; and they returned, along with Tatar envoys, bearing a letter to Louis from the Mongol regent-mother which was couched in terms so arrogant that the king repented sorely of having sent such a mission ("Il roi se

repenti fort quant il y envoya," Joinville, *Histoire de Saint Louis*, pp. 148-49, in Paris edition of 1858 by F. Michel, Paulin Paris and F. Didot). These returned envoys reached the king when he was at Caesarea, therefore between March 1251 and May 1252. But not long after the king, hearing that the Tatar prince Sartak, son of Batu, was a "baptized Christian," felt moved to open communication with him, and for this purpose deputed Friar William of Rubrouck. The former rebuff had made the king chary of sending formal embassies, and Friar William on every occasion, beginning with a sermon delivered in St. Sophia's on Palm Sunday (i.e. April 13th) 1253, disclaimed that character.

Various histories of St. Louis, and other documents, give particulars of the despatch of the mission of Friar Andrew from Cyprus, but none mention that of Friar William; and the first dates given by the latter are those of his sermon at Constantinople, and of his entrance into the Black Sea (May 7th, 1253). He must therefore have received his commission at Acre, where the king was residing from May 1252 to the 29th of June 1253; but he had travelled by way of Constantinople, as has just been indicated, and there received letters to some of the Tatar chiefs from the emperor, who was at this time Baldwin de Courtenay, the last of the Latin dynasty.

The narrative of the journey is everywhere full of life and interest. The vast conquests of Jenghiz Khan were still in nominal dependence on his successors, at this time represented by Mangu Khan, reigning on the Mongolian steppes, but practically these conquests were splitting up into several great monarchies. Of these the Ulus of Juji, the eldest son of Jenghiz, formed the most westerly, and its ruler was Batu Khan, established on the Volga. Sartak is known in the history of the Mongols as Batu's eldest son, and was appointed his successor, though he died immediately after his father (1256). The story of Sartak's Christianity seems to have had some foundation; it was currently believed among Asiatic Christians, and it is alleged by Armenian writers that he had been brought up and baptized among the Russians. Pope Innocent IV. (August 29, 1254) refers with enthusiasm to Sartak's baptism, of which he had just heard from a priest whom the khan had sent as envoy to the papal court.

Rubrouck and his party landed at Soldaia, or Sudak, on the Crimean coast, then a centre of intercourse between the Mediterranean world and what is now S. Russia. Equipped with horses and carts for the steppe, they travelled successively to the courts (i.e. the nomad camps) of Scacatai (Kadan?), Sartak and Batu, thus crossing the Don and arriving at the Volga: of both these rivers Friar William gives vivid and interesting sketches. Batu kept the travellers for some time in suspense, and then referred them to the Great Khan himself, an order involving the enormous journey to Mongolia. The actual travelling of the party from the Crimea to the khan's court near Karakorum cannot have been, on a rough calculation, less than 5000 m., and the return journey to Lajazzo in Cilicia would be longer by 500 to 700 m. The chief dates to be gathered from the narrative are as follows: the envoys embark on the "Euxine," May 7th, 1253; reach Soldaia, May 21st; set out thence, June 1st; reach the camp of Sartak, July 31st; begin the journey from the camp of Batu E. across the steppes, September 16th; turn S.E., November 1st; reach the Talas river, November 8th; leave Caliac³ (S. of Lake Balkash), November 30th; reach the camp of the Great Khan, December 27th; leave the camp of the Great Khan on or about July 10th, 1254; reach camp of Batu again, September 16th; leave Batu's camp at Sarai, November 1st; arrive at the Iron Gate (Derbent), November 13th; Christmas spent at Nakhshivan or Nakhichevan (under Ararat); reach Antioch (from Lajazzo, Laves, or Ayas, of Cilicia, via Cyprus), June 29th, 1255; reach Tripoli, August 15th.

¹ A detailed notice of such documents was published by M. E. Coussemaker of Lille. See remarks by M. d'Arveaz in *Bull. de la Soc. de Géog.*, 2nd vol. for 1868, pp. 569-70.

² The county of Flanders was at this time a fief of the French crown (see Natalis de Wailly, *Notes on Joinville*, p. 576). William's mother-tongue may have been Flemish. From his representation to Mangu Khan (p. 361) that certain "Teutonic" who had been carried away as slaves by a Tatar chief were "nostrae lingue," Dr Franz Max Schmidt inclines to think this certain.

³ Caliac, where Rubrouck halted twelve days, is undoubtedly the Kayalik of the historians of the Mongols, the position of which is somewhat indefinite. The narrative of Rubrouck shows that it must have been near the modern Kopal.

The camp of *Atu* was first reached near the northernmost point of his summer marches, therefore about Ukek or Uveyk, near Saratov (see Marco Polo, Paris ed. of 1824, p. 3). Before the camp was left they had marched with its five weeks down the Volga. The point of departure would lie on that river somewhere between 48° and 50° N. The route taken lay E. by a line running N. of the Caspian and Aral basins; then from about 70° E. to the basin of the Talas river; thence across the passes of the Kirghiz Ala-tau and S. of the Balkash Lake to the Ala-kul and the Barutala Lake (Ebi-nor). From this the travellers struck N. across the Barluk, or the Orkchok Mountains, and thence, passing S. of the modern Kobdo, to the valley of the Jabkan river, whence they emerged on the plain of Mongolia, coming upon the Great Khan's camp at a spot ten days' journey from Karakorum and bearing in the main S. from that place, with the Khangai Mountains between.

This route is of course not thus defined in the narrative, but is a deduction from the facts stated therein. The key to the whole is the description given of that central portion intervening between the basin of the Talas and Lake Ala-kul, which enables the topography of that region, including the passage of the Ili, the plain S. of the Balkash, and the Ala-kul itself, to be identified past question.¹

The return journey, being made in summer, after retraversing the Jabkan valley,² lay apparently farther to the N., and passed N. of the Balkash, probably with a fairly straight course, to the mouths of the Volga. Thence the party travelled S. by Derbent, and so by Shamakhi to the Araxes, Nakhshivan, Erzingan, Sivas and Iconium, to Lajazzo, Layas, or Ayas, where they embarked for Cyprus and Syria. St Louis had returned to France a year before.

We have alluded to Roger Bacon's mention of Friar William. Indeed, in the geographical section of the *Opus Majus* (c. 1262) he cites the traveller repeatedly and copiously, describing him as 'frater Wilhelmus quem dominus rex Francie misit ad Tartaros, Armenios, et quos perlustravit regiones orientis et aquilonis et loca in medio his annexa, et scripsit haec praedicta illustri regi; quem librum diligenter vidi et cum ejus auctoritate contuli' (see *Opus Majus*, Oxford edition of 1897, i. 353-66). Add to this (William's own incidental particulars as to his being—like his precursor, Friar John de Plano Carpini—a very heavy man (*ponderosus valde*), and we know no more of his personality, except the abundant indications of character afforded by the story itself. These point for us an honest, pious, stout-hearted, acute and most intelligent observer, keen in the acquisition of knowledge, the author of one of the best narratives of travel in existence. His language indeed is dog-Latin of the most un-Ciceronian quality; but it is in his hands a pithy and transparent medium of expression. In spite of all the difficulties of communication, and of the badness of his *turgenianus* or dragoman,³ he gathered a mass of particulars, wonderfully true or near the truth, not only as to Asiatic nature, geography, ethnography and manners, but as to religion and language. Of his geography a good example occurs in his account of the Caspian (eagerly caught up by Roger Bacon), which is perfectly accurate, except that he places the hill country occupied by the Mulahids, or Assassins, on the E. instead of the S. shore. He explicitly corrects the allegation of Isidore that it is a gulf of the ocean: 'non est verum quod dicit Vidorius, quod sussum enim tangit oceanum, sed undique circumdatur terra' (265).⁴ Of his interest and acumen in matters of language we may cite examples. The language of the Pascatir (or Bashkirs) and of the Hungarians is the same as he had

learned from Dominicans who had been among them (274).⁵ The language of the Ruthenians, Poles, Bohemians and Slavonians is one, and is the same with that of the Vandals, or Wends (275). In the town of Equius (immediately beyond the Ili, perhaps Aspara)⁶ the people were Mahomedans speaking Persian, though so far remote from Persia (281). The Uighurs (or Yugurs) of the country about Cailac (see note above) had formed a language and character of their own, and in that language and character the Nestorians of that tract used to perform their office and write their books (281-82). The Uighurs are those among whom are found the fountain and root of the Turkish and Comanian tongue (289). Their character has been adopted by the Mongols. In using it they begin writing from the top and write downwards, whilst line follows line from left to right (286). The Nestorians say their service, and have their holy books, in Syriac, but know nothing of the language, just as some of our monks sing the mass without knowing Latin (293). The Tibet people write as we do, and their letters have a strong resemblance to ours. The Tangut people write from right to left like the Arabs, and their lines advance upwards (329). The great money of Cathay is of cotton paper, a palm in length and breadth, and on this they print lines like those of Mangu Khan's seal:—"imprimunt lineas sicut est sigillum Mangu"—a remarkable expression. They write with a painter's pencil and combine in one character several letters, forming one expression:—"faciunt in una figura plures literas comprehendentes unum dictamen."—a still more remarkable utterance, showing an approximate apprehension of the nature of Chinese writing (329).

Yet this sagacious observer is denounced as an untruthful blunderer by Isaac Jacob Schmidt (a man of useful learning, of a kind rare in his day, but narrow, wrong-headed, and in general unacumen and candour inferior to the majority of his countrymen) simply because Rubruck's evidence as to the Turkish dialect of the Uighurs traversed a pet heresy, long since exploded, which Schmidt entertained, viz. that the Uighurs were by race and language Tibetan.⁷ Léon Cahun (*Introduction à l'histoire de l'Asie*, pp. 353-55, 384-86, 392) also shows a strange perversity in depreciating Rubruck; all this detraction may be contrasted with Oscar Peschel's admirably fair judgment (*Geschichte der Erdkunde*, p. 165, &c.). At the same time, Rubruck may be considered inferior as a politician and diplomatist to Carpini; and the latter's remarkable work has in its turn suffered from undiscriminating eulogy of his successor's (*Itinéraires*, p. 10). It might have been made to strike a balance in the judgment of these two great pioneers in the *Dawn of Modern Geography*, ii. 375-81.

The narrative of Rubruck, after Roger Bacon's copious use of it, seems to have dropped out of sight, though five MSS. are still known to exist: the chief of these are (1) Corp. Chr. Coll., Cambridge, No. 66, fols. 67 v.-110 v. of about 1320; (2) No. 181 of the same library, fols. 321-98, of about 1270-90; (3) Leiden Univ. Libr., No. 77 (formerly 104), fols. 160 r.-190 r. of about 1290. It has no place in the famous collections of the 14th century, nor in the earlier attention to the 13th-century intercourse of Latin Christendom with Tartary. It first appeared imperfectly in Hakluyt (1598 and 1599), as we have mentioned. But it was not till 1839 that any proper edition of the text was published. In that year the *Recueil de Voyages de la Paris Geographical Society*, vol. iv., contained an edition of the Latin text, and a collation of the MSS. put forth by M. d'Avezac, with the assistance of two young scholars, since of high distinction, viz. Francisque Michel and Thomas Wright. But there is no commentary on the subject-matter, such as M. d'Avezac attached to his edition of Friar John de Plano Carpini in the same volume. Something has been done to supply this deficiency by the two editions in the Hakluyt Society's publications, (1) *William of Rubruck's John of Pian de Carpine*, trans. and edited by William W. Rockhill (London, 1900); (2) *Texts and Versions of . . . Carpini and . . . Rubruckus . . .* edited by C. Raymond Beazley (London, 1903). Richthofen in his *China*, i. 602-4, has briefly but justly noticed Rubruck. A French version, with some notes, issued at Paris in 1877, in the *Bibliothèque orientale Elzévirienne* hardly deserves mention. Dr Franz Max Schmidt's admirable monograph, *Über Rubruk's Reise* (Berlin, 1885), has been separately

¹ See details in *Cathay and the Way Thither*, pp. cxxi-cxxiv, and Schuyler's *Turkistan*, i. 402-5. Mr Schuyler points out the true identification of Rubruck's river with the Ili, instead of the Chu, which is a much smaller stream; and other amendments have been derived from Dr F. M. Schmidt (see below).

² This meaning may be put on Rubruck's words: "Our going was in winter, our return in summer, and that by a way lying very much farther north, only that for a space of fifteen days' journey in going and coming we followed a certain river between mountains, and on these there was no grass to be found except close to the river." The position of the Chagan Taktor or upper Jabkan seems to suit these facts best; but Mr Schuyler refers them to the upper Irtilsh, and Dr F. M. Schmidt to the Uiliungur.

³ Ego enim percepit postea, quando incepti aliquantum intelligere idioma, quod quando dicebam unum ipse totum aliud dicebat, secundum quod ei occurrebat. Tum videtur periculum loquendi per ipsum, elegi magis tacere" (248-49).

⁴ The page references in the text are to d'Avezac's edition of the Latin (see below).

⁵ The Bashkirs now speak a Turkish dialect; but they are of Finnish race, and it is quite possible that they then spoke a language akin to Magyar. There is no doubt that the Mussulman historians of that age identified the Hungarians and the Bashkirs (e.g. see extracts from Juvaini and Keshid in *Asp. to D'Oshes*, *Asiatic Hist. des Indes*, i. 520-21). The Bashkirs are also constantly coupled with the *Majir* by Abulghazi. See Fr. tr. by Desmaisons, pp. 19, 140, 180, 189.

⁶ *Asp = Equus*. Aspara is often mentioned by the historians of Timur and his successors; its exact place is uncertain, but it lay somewhere on the Ili frontier. Dr F. M. Schmidt thinks this identification impossible; but one of his reasons—viz. that Equus was only one day from Cailac—appears to be a misapprehension of the text.

⁷ See *Forschungen im Gebiete . . . der Völker Mittel-Asiens* (St Petersburg, 1824), pp. 90-93.

printed from vol. xx. of the *Zeitschrift* of the Berlin Geographical Society. See also d'Ohsson, *Histoire des Mongols* (1852), vol. ii. pp. 283-309; Bretschneider, *Mediaeval Researches from Eastern Asiatic Sources* (1888), i. 204-5, 262-63, 299, 301, 305-8, 311, 318, 327, 334; ii. 25, 38, 41-42, 70-71, 83-86, 91, 116, 120; Beazley, *Dawn of Modern Geography*, ii. 266, 278-79, 281, 298-99, 303, 320-82, 421, 449-52; iii. 17-18, 31-32, 46, 69, 84-85, 88, 98, 101, 105, 188, 230-37, 544.

RUBY (Lat. *rubens*, red), the most valued of all gem-stones, a red transparent variety of corundum, or crystallized alumina. It is sometimes termed "oriental ruby" to distinguish it from the spinel ruby, which is a stone of inferior hardness, density and value (see SPINEL). When the word ruby is used without any qualifying prefix, it is always the true or so-called oriental stone that is meant in modern nomenclature. Ancient writers, relying chiefly on colour, classed together under a common name several brilliant red stones, such as the ruby, spinel and garnet: thus the *δύραξ* of Theophrastus and the *Carbunculus* of Pliny were names which seem to have been applied to several distinct minerals. Although the word ruby is used in the English translation of the Old Testament it is improbable that the true ruby was known to the ancient Hebrews.

The ruby crystallizes in the hexagonal system (see CORUNDUM). The crystals have no true cleavage, but tend to break along certain gliding planes. The colour of ruby varies from deep cochineal to pale rose-red, in some cases with a tinge of purple, the most valued tint being that called by experts pigeon's-blood colour. On exposure to a high temperature, the ruby becomes green, but regains its original colour on cooling. The red colour of ruby may be due to chromium. When a ruby of the most esteemed tint is examined with the dichroscope, one image is generally seen to be carmine and the other aurora-red, the red colour inclining to orange. This test serves to distinguish the true ruby from spinel and from garnet, since these minerals, being cubic, are not dichroic. Another means of distinction is afforded by the specific gravity of ruby (about 4), which is higher than that of spinel and garnet, whilst the superior hardness of the ruby (about 9) furnishes yet another test. The high refractivity of ruby is also characteristic, the mean ordinary index being 1.77 and the extraordinary 1.76. When cut and polished the ruby is therefore a brilliant stone, but having weak dispersive power it lacks fire. Subjected to radiant discharge in a Crookes tube, the ruby, like other forms of corundum, phosphoresces with a vivid red glow.

The oriental ruby is a mineral of very limited distribution. Its most famous localities are in Upper Burma, but until the British annexation of the country in 1886 the mines were so jealously guarded that little was known as to the conditions under which the mineral occurred. Soon after the annexation, the ruby districts were officially visited, and reported on, by Mr C. Barrington Brown, and specimens from the mines were exhaustively studied by Professor J. W. Judd. The principal district is situated in the neighbourhood of Mogok, 90 m. N.N.E. of Mandalay. The ruby occurs in bands of a crystalline limestone, associated with granitic and gneissose rocks, some of which are highly basic; and it is from the anorthite, or lime-felspar, and the associated minerals in the pyroxenogneisses, that the corundum, spinel and calcite, may, according to Judd, have been derived. Probably the felspar is first altered to scapolite, and this on decomposition would yield calcium carbonate and hydrous aluminium silicates, from which the anhydrous alumina might ultimately be separated. The limestone contains (in addition to the ruby) spinel, garnet, graphite, wollastonite, scapolite, felspar, mica, pyrrhotite and other minerals. The ruby, like other kinds of corundum, suffers alteration under certain conditions, and passes by hydration into gibbsite and diasporite, which by further alteration and union with silica, &c., may yield margarite, vermiculite, chlorite and other hydrous silicates.

The Burmese rubies are not generally worked in the limestone matrix, but are mostly found loose in detrital matter, which is clayey and sandy in character and yellowish-brown

in colour, and is known locally as "byon." Some of the deposits occur in limestone caverns, where they may, like cave-earth, represent the insoluble residue of the limestone. Workings in the cave-deposits are called "loodwins" (crooked mines). In the alluvium of the valleys, the ruby-pits are known as "twinolones" (round pits), whilst workings in the ruby-earth on the hillsides are termed "hmyadwins" (water mines). The byon contains, with the ruby, other coloured corundums and spinels. Burmese rubies are found also in crystalline limestone in the hills near Sagyin, about 20 m. N. of Mandalay, and it is of mineralogical interest to note that the limestone here contains chondrodite.

Rubies are found in Siam, at several localities in the provinces of Chantabun and Krati; and Professor H. Louis has described their occurrence at Moug Klung in this region. The rubies are found with sapphires and spinels, in gravels, resting in some cases on basic igneous rocks. The Siam rubies are generally of dark colour, often inclining to a deep reddish brown. Rubies occur, with sapphires and other minerals, in the gem-gravels of Ceylon, but are not usually of such good colour as the Burmese stones. A cloudy variety, which, when cut with a convex surface, exhibits a luminous star, is known as star-ruby (see ASTERIAS). In peninsular India rubies are rarely found, though they have been reported from the corundum deposits of Madras and Mysore. The ruby is known, however, to occur in a micaceous limestone at Jagdalak, near Kabul in Afghanistan.

Rubies, generally of pale colour, are found with the sapphires of Montana, especially at Yogo Gulch near Utica. In the corundum deposits of N. Carolina ruby is occasionally met with, especially at Cowee Creek, Macon county, where it occurs in crystals of tabular, rhombohedral and prismatic habit. These crystals, sometimes of fine colour, are found in gravels resting on a soft rock called saprolite, which results from the weathering of certain basic igneous rocks; and it is notable that the ruby crystals are associated with the variety of garnet termed rhodolite, as described by Professor Judd and W. E. Hidden. Australia has occasionally yielded rubies, but mostly of small size and inferior quality. In New South Wales and in Victoria they have been found in drift gravels, and a magenta-coloured turbid variety from Victoria has been described under the name of barklyrite.

Rubies have been produced artificially with much success. At one time it was the practice to fuse together small fragments of the natural stone; and gems cut from such material were known as reconstructed rubies. This process has given way to Professor A. Verneuil's method of forming artificial ruby from purified ammonia-alum with a certain proportion of chrome-alum. The finely powdered material is caused to fall periodically into an oxyhydrogen flame, the heat of which decomposes the alum, and the alumina thus set free forms liquid drops which collect and solidify as a pear-shaped mass. When of the characteristic pigeon's-blood colour, the synthetic ruby contains about 2.5% of chromic oxide. The manufactured ruby possesses the physical characters of corundum, but may generally be distinguished by microscopic bubbles and striae. The manufacture is carried out commercially. (For other processes, see GEM, ARTIFICIAL.)

It should be noted that several minerals known popularly as rubies have no relation to the true red corundum. Thus, "Cape rubies" from the South African diamond mines, "Australian rubies" from South Australia, and "Arizona rubies" are merely fine garnets; "Siberian ruby" is red tourmaline (see RUBELLITE), and "Balas ruby" is spinel (*q.v.*). Ruby silver is a name applied to light red silver ore, or proustite; ruby copper is merely cuprite, in brilliant crystals; and ruby-blende is a clear red variety of zinc sulphide.

BIBLIOGRAPHY.—For the Burma ruby, see "The Rubies of Burma and Associated Minerals: their mode of occurrence, origin and metamorphoses," by C. Barrington Brown and Professor J. W. Judd, *Phil. Trans.*, 1897, 187, p. 151. For the ruby of Siam, see "The Ruby and Sapphire Deposits of Moug Klung, Siam," by H. Louis, *Mineralog. Mag.*, 1894, 10, p. 267. For synthetic ruby,

see G. F. Herbert Smith, *Mineralog. Mag.*, 1908, 15, p. 153; and J. Boyer, *La Synthèse des pierres précieuses* (Paris, 1909).
(F. W. R. *)

RUBY MINES, a district in the Mandalay division of Upper Burma, lying along the Irrawaddy river between the Bhamo district on the N., the Shan States on the E., Mandalay district on the S. and Katha on the W. Including the Shan state of Mongmit, which is temporarily administered as part of the district, the total area is 5476 sq. m.; pop. (1901) 87,694. The district geographically forms part of the Shan plateau, and is to a great extent a mass of hills with a general N. and S. direction. It contains considerable numbers of Kachins (13,300) and Palaungs (16,400). The annual rainfall at Mogok averages 98 in. The administrative headquarters are at Mogok, which is also the centre of the ruby-mining industry. It stands in the centre of a valley 4000 ft. above sea-level, and is reached by a cart-road from Thabeikkyin, 61 m. distant, on the Irrawaddy. The Ruby Mines Company employs about 44 Europeans and Eurasians in its works, which are situated at the north end of the town. The company has constructed a dam across the Yeni stream and set up an electric installation of about 450 horse-power, which works pumps and the washing machinery. The mines were worked under Burmese rule, but were discontinued on account of the small profit. Now they seem to be established on a sound financial basis. The system adopted is to excavate large open pits, from which the ruby-earth or *byon* is removed *en masse* and washed and crushed by machinery. Spinel and sapphires are found with the rubies. In 1904, the produce of rubies alone was 200,000 carats, valued at £80,000, most of which were sent to London for sale. In addition, some mining is carried on by natives, working under a licence which does not permit the use of machinery. The district contains 994 sq. m. of reserved forests.

RÜCKERT, JOHANN MICHAEL FRIEDRICH (1788–1866), German poet, was born at Schweinfurt on the 16th of May 1788, the eldest son of a lawyer. He was educated at the gymnasium of his native place and at the universities of Würzburg and Heidelberg. For some time (1816–17) he worked on the editorial staff of the *Morgenblatt* at Stuttgart. Nearly the whole of the year 1818 he spent in Rome, and afterwards he lived for several years at Coburg. He was appointed a professor of Oriental languages at the university of Erlangen in 1826, and in 1841 he was called to a similar position in Berlin, where he was also made a privy councillor. In 1849 he resigned his professorship at Berlin, and went to live on his estate Neuses near Coburg. He died on the 31st of January 1866. When Rückert began his literary career, Germany was engaged in her life-and-death struggle with Napoleon; and in his first volume, *Deutsche Gedichte*, published in 1814 under the pseudonym "Freimund Raimar," he gave, particularly in the powerful "Geharnischte Sonette," vigorous expression to the prevailing sentiment of his countrymen. In 1815–18 appeared *Napoleon, eine politische Komödie in drei Stücken* (only two parts were published), and in 1817 *Der Kranz der Zeit*. He issued a collection of poems, *Östliche Rosen*, in 1822; and in 1834–38 his *Gesammelte Gedichte* were published in six volumes, a selection from which has passed through many editions. Rückert, who was master of thirty languages, made his mark chiefly as a translator of Oriental poetry and as a writer of poems conceived in the spirit of Oriental masters. Much attention was attracted by a translation of Hari's *Makamen* (1826), *Nal und Damajanti*, an Indian tale (1828), *Rostem und Sohrab, eine Heldengeschichte* (1838), and *Hamasa, oder die ältesten arabischen Volkslieder* (1846). Among his original writings dealing with Oriental subjects are *Morgenländische Sagen und Geschichten* (1837), *Erbauliches und Beschauliches aus dem Morgenland* (1836–38), and *Brahmanische Erzählungen* (1839). The most elaborate of his works is *Die Weisheit des Brahmanen*, published in six volumes in 1836–39. This last and the *Liebesfrühling* (1844), a cycle of love-songs, are the best known of all Rückert's productions. In 1843–45 he issued the dramas *Saul und David* (1843), *Herodes der Grosse* (1844),

Kaiser Heinrich IV. (1845) and *Christoforo Colombo* (1845), all of which are greatly inferior to the work to which he owes his place in German literature. At the time of the Danish war in 1864 he wrote *Ein Tausend Kampfkrieger für Schleswig-Holstein*, which, although published anonymously, produced a considerable impression. After his death many poetical translations and original poems were found among his papers, and several collections of them were published. Rückert had a splendour of imagination which made Oriental poetry congenial to him, and he has seldom been surpassed in rhythmic skill and metrical ingenuity. There are hardly any lyrical forms which are not represented among his works, and in all of them he wrote with equal ease and grace.

A complete edition of Rückert's poetical works appeared in 12 vols. in 1868–69. Subsequent editions have been edited by L. Laistner (1896), C. Beyer (1896), G. Ellinger (1897). See B. Fortlage, *F. Rückert und seine Werke* (1867); C. Beyer, *Friedrich Rückert, ein biographisches Denkmal* (1868), *Neue Mitteilungen über Rückert* (1873), and *Nachgelassene Gedichte Rückerts aus neue Beiträge zu dessen Leben und Schriften* (1874); R. Bosberger, *Rückert-Studien* (1878); P. de Lagarde, *Erinnerungen an F. Rückert* (1886); F. Muncker, *Friedrich Rückert* (1890); G. Voigt, *Rückerts Gedankensylrik* (1891).

RÜDAGI (d. 954). Farid-eddin Mahommed 'Abdallah, the first great literary genius of modern Persia, was born in Rüdag, a village in Transoxiana, about 870–900. Most of his biographers assert that he was totally blind, but the accurate knowledge of colours shown in his poems makes this very doubtful. The fame of his accomplishments reached the ear of the Sāmānid Nasr II. bin Ahmad, the ruler of Khorāsān and Transoxiana (913–42), who invited the poet to his court. Rüdagi became his daily companion, rose to the highest honours and amassed great wealth. In spite of various predecessors, he well deserves the title of "father of Persian literature," "the Adam or Sultan of poets," since he was the first who impressed upon every form of epic, lyric and didactic poetry its peculiar stamp and its individual character. He is also said to have been the founder of the "diwān"—that is, the typical form of the complete collection of a poet's lyrical compositions in a more or less alphabetical order which prevails to the present day among all Mahommedan writers. Of the 1,300,000 verses attributed to him, there remain only 52 kasidas, ghazals and rubā'is; of his epic masterpieces we have nothing beyond a few stray lines in native dictionaries. But the most serious loss is that of his translation of Ibn Mokaffa's Arabic version of the old Indian fable book *Kalilah and Dimnah*, which he put into Persian verse at the request of his royal patron. Numerous fragments, however, are preserved in the Persian lexicon of Asadi of Tus (ed. P. Horn, Göttingen, 1897). In his kasidas, all devoted to the praise of his sovereign and friend, Rüdagi has left us unequalled models of a refined and delicate taste, very different from the often bombastic compositions of later Persian encomiasts. His didactic odes and epigrams express in well-measured lines a sort of Epicurean philosophy of human life and human happiness; more charming still are the purely lyrical pieces in glorification of love and wine. Rüdagi survived his royal friend, and died poor and forgotten by the world.

There is a complete edition of all the extant poems of Rüdagi, in Persian text and metrical German translation, together with a biographical account, based on forty-six Persian MSS., in Dr H. Ethé's "Rüdagi der Sāmānidendichter" (*Göttinger Nachrichten*, 1873, pp. 663–742); see also his "Neupersische Literatur" in Geiger's *Grundriss der iranischen Philologie* (ii.); P. Horn, *Gesch. der persischen Literatur* (1901), p. 73; E. G. Browne, *Literary History of Persia*, i. (1902); C. J. Pickering, "A Persian Chaucer" in *National Review* (May 1890).

RUDD, or RED-EYE (*Leuciscus erythrophthalmus*), a fish of the Cyprinid family, spread over Europe, N. and S. of the Alps, also found in Asia Minor, and common in localities where there are still waters with muddy bottom. The rudd and the roach are very similar and frequently confused by anglers; the former differs principally in the more posterior dorsal fin, which is situated exactly opposite the space between the ventral and anal fins. It is a fine fish, but little esteemed for food,

and rarely exceeds 12 in. in length and 2 lb in weight. It feeds on small freshwater animals and soft vegetable matter, and spawns in April or May. It readily crosses with the white bream, and more rarely with the roach and bleak.

RUDDER (O.E. *Rother*, i.e. rower), that part of the steering apparatus of a ship which is fastened to the stern outside, and on which the water acts directly. The word may be found to be used as if it were synonymous with "helm." But the helm (A.S. *Hilf*, a handle) is the handle by which the rudder is worked. The tiller, which is perhaps derived from a provincial English name for the handle of a spade, has the same meaning as the helm. In the earliest times a single oar, at the stern, was used to row the vessel round. In later times oars with large blades were fixed on the sides near the stern. In Greek and Roman vessels two sets were sometimes employed, so that if the pitching of the ship lifted the after pair out of the water, the foremost pair could still act. As these ancient ships were, at least in some cases, sharp at both ends and could sail either way, steer (or steering) oars were fixed both fore and aft. The steer oar in this form passed through a ring on the side and was supported on a crutch, and was turned by a helm, or tiller. Norse and mediæval vessels had, as far as we can judge, one steer oar only placed on the right side near the stern—hence the name "starboard," i.e. steerside, for the right side of the ship looking forward. In the case of small vessels the steer oar possesses an advantage over the rudder, for it can bring the stern round quickly. Therefore it is still used in whaling boats and rowing boats which have to work against wind and tide, and in surf when the rudder will not act. It is not possible to assign any date for the displacement of the side rudder by the stern rudder. They were certainly used together, and the second displaced the first in the course of the 14th century when experience had shown that the rudder was more effective at the stern than at the side. The rudder of a wooden ship when fully developed was composed of four pieces. The first or main piece was hung on to the stern post of the ship. Its upper portion was known as the rudder head, and was at first an oval shaft which passed into the ship through the rudder port, and to which the helm was fixed. A canvas bag called a rudder coat covered the opening to exclude the water. In later days Sir R. Seppings introduced the cylindrical form in order to prevent the water from coming into the round rudder port. Three back pieces were fastened to the main piece longitudinally. The whole were fastened together by iron bands called pintle straps, which had at the forward end a pin or pintle, which fitted into braces, i.e. fixed rings on the stern post, so that the rudder hung on hinges. The lower part of the main piece was bevelled, and so was the stern post, so as to allow the rudder to swing freely. A projecting piece called a shock or wood-lock was fixed in the head outside the ship in order to prevent the rudder from being lifted by the water out of its hinges. A small vessel can be steered by the helm or tiller, but in a larger it is necessary to apply a mechanical leverage. This was secured by carrying ropes, or in later times chains, to the sides of the ship, and then through blocks to the upper deck, round a barrel which is worked by the wheel. The principle of the rudder cannot alter, but the means employed to work it have been altered by the introduction of the screw, and by the increased size of ships. A single screw is placed in an open space before the stern post. As the opening thus created prevents the water from flowing directly on to the rudder, a screw steamer is sometimes difficult to steer. In order to make the rudder more manageable, it has been balanced, i.e. pivoted, on a shaft placed at about a third of its length from the foremost edge. In a double screw there is no opening, but the balanced rudder is still used, and the ship can be turned by reversing one of the screws. The need for more power to work the helm has led to the introduction of steam, and hydraulic steering apparatus which can be set in motion by a small wheel.

See Burney's *Falconer's Dictionary* (London, 1830); Torr's *Ancient Ships* (Cambridge, 1894); Nares, *Seamanship* (Portsmouth, 1882).

RUDDIMAN, THOMAS (1674–1757), Scottish classical scholar, was born in October 1674, at Raggal, Banffshire, where his father was a farmer. He was educated at Aberdeen University, and through the influence of Dr Archibald Pitcairne he was made assistant in the Advocates' Library, Edinburgh. His chief writings at this period were editions of Florence Wilson's *De Animi Tranquillitate Dialogus* (1707), and the *Cantici Solomonis Paraphrasis Poetica* (1709) of Arthur Johnston (1587–1641), editor of the *Deliciae Poetarum Scotorum*. On the death of Dr Pitcairne he edited his friend's Latin verses, and arranged for the sale of his valuable library to Peter the Great of Russia. In 1714 he published *Rudiments of the Latin Tongue*, which was long used in Scottish schools. In 1715 he edited, with notes and annotations, the works of George Buchanan in two volumes folio. As Ruddiman was a Jacobite, the liberal views of Buchanan seemed to him to call for frequent censure. A society of scholars was formed in Edinburgh to "vindicate that incomparably learned and pious author from the calumnies of Mr Thomas Ruddiman"; but Ruddiman's remains the standard edition, though George Logan, John Love, John Man and others attacked him with great vehemence. He founded (1715) a successful printing business, and in 1728 was appointed printer to the university. He acquired the *Caledonian Mercury* in 1729, and in 1730 was appointed keeper of the Advocates' Library, resigning in 1752. He died in Edinburgh, on the 10th of January 1757.

Besides the works mentioned, the following writings of Ruddiman deserve notice: An edition of Gavin Douglas's *Aeneid* of Virgil (1710); the editing and completion of Anderson's *Selectus Diplomatum et Numismatum Scotiae Thesaurus* (1739); *Catalogue of the Advocates' Library* (1733–42); and a famous edition of Livy (1751). He also helped Joseph Ames with the *Typographical Antiquities*. Ruddiman was for many years the representative scholar of Scotland. Writing in 1766, Dr Johnson, after reproving Boswell for some bad Latin, significantly adds—"Ruddiman is dead." When Boswell proposed to write Ruddiman's life, "I should take pleasure in helping you to do honour to him," said Johnson.

See Chalmers's *Life of Ruddiman* (1794); *Scots Magazine*, January 7, 1757.

RUDE, FRANÇOIS (1784–1855), French sculptor, was born at Dijon on the 4th of June 1784. Till the age of sixteen he worked at his father's trade as a stove-maker, but in 1809 he went up to Paris from the Dijon school of art, and became a pupil of Castellier, obtaining the Grand Prix in 1812. After the second restoration of the Bourbons he retired to Brussels, where he got some work under the architect Van der Straeten, who employed him to execute nine bas-reliefs in the palace of Tervuren. At Brussels Rude married Sophie Fremiet, the daughter of a Bonapartist compatriot to whom he had many obligations, but gladly availed himself of an opportunity to return to Paris, where in 1827 a statue of the Virgin for St Gervais and a "Mercury fastening his Sandals" (now in the Louvre) obtained much attention. His great success dates, however, from 1833, when he received the cross of the Legion of Honour for his statue of a "Neapolitan Fisher Boy playing with a Tortoise," which also procured for him the important commission for all the ornament and one group in the Arc de l'Étoile. This group, the "Départ des volontaires de 1792," a work full of energy and fire, immortalizes the name of Rude. Amongst other productions we may mention the statue of the mathematician Gaspard Monge (1848), Jeanne d'Arc, in the gardens of the Luxembourg (1852), a Calvary in bronze for the high altar of St Vincent de Paul (1855), as well as "Hebe and the Eagle of Jupiter," "Love Triumphant" and "Christ on the Cross," all of which appeared at the Salon of 1857 after his death. He died suddenly on the 3rd of November 1855.

See also A. G. Hamerton, *Modern Frenchmen, five biographies* (1878); Carl Adolf Rosenberg, *François Rude* (1884); Louis Gonse, *Les Chefs d'œuvre des musées de France* (Paris, 1900); L. de Fourcaud, *François Rude, sculpteur* (Paris, 1904).

RUDERAL (Lat. *rudus*, rubbish), a botanical term for plants growing on rubbish heaps or in waste places.

RÜDESHEIM, a town of Germany in the Prussian Rhine province on the right bank of the Rhine, 19 m. S.W. of

Wiesbaden by the main line from Frankfurt-on-Main to Cologne. Pop. (1905) 4773. Its situation, at the lower end of the famous vineyard district of the Rheingau, opposite Bingen and just above the romantic gorge of the Rhine, renders it a popular tourist centre. Behind the town rises the majestic Niederwald (985 ft.), on the crest of which stands the national monument, "Germania," commemorating the war of 1870-71. Rüdeshcim has some interesting towers. The Brömserburg, or Niederburg, a massive structure built in the 13th century, formerly belonging to the archbishops of Mainz; the Boosenburg, or Oberburg, which was rebuilt in 1868, with the exception of the keep; the Adlerturn, a relic of the fortifications of the town; and the Vorderburg, the remains of an old castle. The Gothic church of St James has some interesting paintings and monuments, and there is also a Protestant church. The town has electrical works, but its industries are mainly concerned with the preparation of wine, the best kinds being Rudesheimer Berg, Hinterhaus and Rottland.

See J. P. Schmelzels, *Rüdeshcim im Rheingau* (Rüdeshcim, 1881); and Heiderlinden, *Rüdeshcim und seine Umgebung* (Rüdeshcim, 1888).

RUDINĪ, ANTONIO STARABBA, MARQUIS DI (1830-1908). Italian statesman, was born at Paleimo on the 6th of April 1830. In 1859 he joined the revolutionary committee which paved the way for Garibaldi's triumphs in the following year; then after spending a short time at Turin as attaché to the Italian foreign office he was elected mayor of Palermo. In 1866 he displayed considerable personal courage and energy in quelling an insurrection of separatist and reactionary tendencies. The prestige thus acquired led to his appointment as prefect of Palermo, and while occupying that position he put down brigandage throughout the province; in 1868 he was prefect of Naples. In October 1869 he became minister of the interior in the Menabrea cabinet, but he fell with that cabinet a few months later, and although elected member of parliament for Canicatti held no important position until, upon the death of Minghetti in 1886, he became leader of the Right. Early in 1891 he succeeded Crispi as premier and minister of foreign affairs by forming a coalition cabinet with a part of the Left under Nicotera; his administration proved vacillating, but it initiated the economies by which Italian finances were put on a sound basis and also renewed the Triple Alliance. He was overthrown in May 1892 by a vote of the Chamber and succeeded by Giolitti. Upon the return of his rival, Crispi, to power in December 1893, he resumed political activity, allying himself with the Radical leader, Cavallotti. The crisis consequent upon the disaster of Adowa (1st March 1896) enabled RudinĪ to return to power as premier and minister of the interior in a cabinet formed by the veteran Conservative, General Ricotti. He concluded peace with Abyssinia, but endangered relations with Great Britain by the unauthorized publication of confidential diplomatic correspondence in a Green-book on Abyssinian affairs. To satisfy the anti-colonial party he ceded Kassala to Great Britain, provoking thereby much indignation in Italy. His internal policy was marked by continual yielding to Radical pressure and by persecution of Crispi. By dissolving the Chamber early in 1897 and favouring Radical candidates in the general election, he paved the way for the outbreak of May 1898, the suppression of which entailed considerable bloodshed and necessitated a state of siege at Milan, Naples, Florence and Leghorn. Indignation at the results of his policy led to his overthrow in June 1898. During his second term of office he thrice modified his cabinet (July 1896, December 1897, and May 1898) without strengthening his political position. In many respects RudinĪ, though leader of the Right and nominally a Conservative politician, proved a dissolving element in the Italian Conservative ranks. By his alliance with the Liberals under Nicotera in 1891, and by his understanding with the Radicals under Cavallotti in 1894-98; by abandoning his Conservative colleague, General Ricotti, to whom he owed the premiership in 1896; and by his vacillating action after his fall from power, he divided and demoralized a constitutional party which, with greater

sincerity and less reliance upon political cleverness, he might have welded into a solid parliamentary organization. At the same time he was a thorough gentleman and *grand seigneur*. One of the largest and wealthiest landowners in Sicily, he managed his estates on liberal lines, and was never troubled by agrarian disturbances. The marquis, who had not been in office since 1898, died on the 6th of August 1908, leaving a son, Carlo, who married a daughter of Mr Henry Labouchere.

RUDOK, a small town on the Ladakh frontier of Tibet, through which all the trade of Tibet passes to Leh, and at which is maintained the Chinese outpost that for many years persistently interfered with European exploration. Rudok is picturesquely situated on the side of a hill standing isolated in the plain near the E. end of Lake Pangong, across which the official boundary between Tibet and Kashmir runs. The houses are built in tiers, whitewashed and walled in. At the top of the hill are a large palace and several monasteries painted red. About a mile away from the foot of the hill is another monastery. Rudok is about 13,300 ft. above sea-level, and the greatest altitude on the route connecting it with Lhasa at the pass of Mariom la (the water-parting between the Brahmaputra and the Sutlej) is 15,500 ft. The winter climate of Rudok and of all the towns of the Tsangpo basin, owing to the intense dryness of the air and the light fall of snow, seems to be bracing and exhilarating rather than severe. The thermometer never approaches the minimum record of Puetra (in the same latitude and at half the absolute elevation), according to the observations of native surveyors.

RUDOLF (otherwise known as BASSO NOROK and GALLOP), a large lake of E. equatorial Africa, forming the centre of an inland drainage system, occupying the S. of the Abyssinian highlands and a portion of the great equatorial plateau. The lake itself lies towards the N. of the great East African rift valley, between the parallels of 2° 26' and 5° N., while the meridian of 36° E. is slightly W. of the centre of the northern wider part, the narrower southern portion bending to 36½° E. The length along the curved axis is 185 m., the maximum width 37, and the area roughly 3500 sq. m. Its altitude is 1250 ft. Towards the S. it seems to be deep, but it is comparatively shallow in the N. Its water is brackish, but drinkable. The country bordering the lake on almost every side is sterile and forbidding. The S. end, for some 50 m. on the W. and for a longer distance on the E., is shut in by high cliffs—the escarpments of a rugged lava-strewn country, which shows abundant signs of volcanic activity, great changes having been reported since 1889. In particular, the great volcano of Lubburua (Teleki's volcano) at the S. end of the lake is said to have been destroyed between 1889 and 1897 by a sudden explosion. The highest point of the S.E. side of the lake is Mount Kulal, 7812 ft., while the culminating height within the basin of the lake is Mount Sil, 9280 ft., which lies about 20 m. S. of Lubburua. Further N., on the W. side, sandy plains alternate with lines of low hills, the immediate shores (on which the water appears to have encroached in very modern times) being marked by spits of sand, which in places cut off lagoons from the main body of the lake. These are the haunt of great numbers of water-birds. In 3° 8' N. the dry bed of the Turkwell—in its upper course a large river descending the slopes of Mount Elgon—approaches the lake. Near the N. end mountains again approach the shores, the most prominent being Mount Lubbur (5200 ft.), an extinct volcano with a well-preserved crater. At the extreme N.W. corner a bay some 35 m. long (Sanderson Gulf) is almost separated from the rest of the lake by two long points of land. On the E. side, open arid plains, with few trees, occupy most of the N. country. One hill, in 3° 20' N., has a height of 3470 ft., and at the N.E. end, separating the lake from Lake Stefanie, is a hilly country, the highest point between the lakes being 3524 ft. Immediately N. of these hills rises the Hummurr Range, with one peak exceeding 7000 ft. Near the S. end is the volcanic island of Elmolo, 10 m. long, and there are a few small islets. Just N. of 4° N. is a small volcanic

island with highest point 2100 ft. At the N. end of the lake a level swampy plain is traversed by various arms of the lake and by the Nianam river. This river has been shown to be identical with the Omo, the course of which was long one of the most debated questions of African geography. Its northernmost feeders rise on the high plateau S. of the Blue Nile, in 9° 10' N., and being swollen by other streams from the E. and W., soon form a large river. During its lower course it makes two considerable bends to the W. before finally entering the lake as a deep stream a quarter of a mile wide. Lake Rudolf (previously known on the east coast by report) was discovered in 1888 by Count Samuel Teleki and Lieutenant Ludwig von Höhnel. It was subsequently visited by Dr Donaldson Smith, Vittorio Bottego, H. S. H. Cavendish, H. H. Austin, and others, and by 1905 its shores and the neighbouring country had become fairly well known. In 1907, by an agreement between the powers concerned, the N.E. end of the lake, into which the Omo debouches, was assigned to Abyssinia, the rest of the lake to Great Britain.

AUTHORITIES.—*Geographical Journal* (September 1896, April 1898, August 1899, May 1904); the last-named issue contains a map by Captain P. Maud, R.E.; Ludwig von Höhnel, *Discovery of Lakes Rudolf and Stefania* (London, 1894); A. Donaldson Smith, *Through Unknown African Countries* (London, 1897); A. H. Neumann, *Elephant-Hunting in East Equatorial Africa* (London, 1898); L. Vannutelli and C. Citerni, *L'Ohio* (Milan, 1899); M. S. Welby, *Twixt Sirdar and Menelik* (London, 1901); H. H. Austin, *Among Swamps and Giants in Equatorial Africa* (1902); C. H. Stigand, *To Abyssinia through an Unknown Land* (1910).

(E. HE.)

RUDOLPH I. (1218–1291), German king, son of Albert IV. count of Habsburg, and Hedwig, daughter of Ulrich count of Kyburg, was born at Limburg on the 1st of May 1218. At his father's death in 1239 Rudolph inherited the family estates in Alsace, and in 1245 he married Gertrude, daughter of Burkhard III. count of Hohenberg. He paid frequent visits to the court of his godfather the emperor Frederick II., and his loyalty to Frederick and to his son Conrad IV. was richly rewarded by grants of land, but in 1254 was excommunicated by Pope Innocent IV. The disorder in Germany after the fall of the Hohenstaufen afforded an opportunity for Rudolph to increase his possessions. His wife was an heiress; and on the death of his childless uncle, Hartmann VI. count of Kyburg, in 1264, he seized his valuable estates. Successful feuds with the bishops of Strassburg and Basel further augmented his wealth and his reputation; rights over various tracts of land were purchased from abbots and others; and he was also the possessor of large estates in the regions now known as Switzerland and Alsace.

These various sources of wealth and influence had rendered Rudolph the most powerful prince in S.W. Germany when, in the autumn of 1273, the princes met to elect a king. His election at Frankfurt on the 29th of September 1273 was largely due to the efforts of his brother-in-law, Frederick III. of Hohenzollern, burgrave of Nuremberg. The support of Albert duke of Saxe-Lauenburg, and of Louis II. count palatine of the Rhine and duke of upper Bavaria, had been purchased by betrothing them to two of Rudolph's daughters; so that Ottakar II. king of Bohemia, a candidate for the throne, was almost alone in his opposition. Rudolph was crowned at Aix-la-Chapelle on the 24th of October 1273, and the feast which followed has been described by Schiller in *Der Graf von Hapsburg*. To win the approbation of the pope Rudolph renounced all imperial rights in Rome, the papal territory and Sicily, and promised to lead a new crusade; and Pope Gregory X., in spite of Ottakar's protests, not only recognized Rudolph himself, but persuaded Alphonso X. king of Castile, who had been chosen German king in 1257, to do the same. In November 1274 it was decided by the diet at Nuremberg that all crown estates seized since the death of the emperor Frederick II. must be restored, and that Ottakar of Bohemia must answer to the diet for not recognizing the new king. Ottakar refused to appear or to restore the provinces of Austria, Styria, Carinthia and Carniola which he had seized. He was

placed under the ban; and in June 1276 war was declared against him. Having detached Henry I. duke of lower Bavaria from his side, Rudolph compelled the Bohemian king to cede the four provinces in November 1276. Ottakar was then invested with Bohemia by Rudolph, and his son Wenceslaus was betrothed to a daughter of the German king, who made a triumphal entry into Vienna. Ottakar, however, raised questions about the execution of the treaty, made an alliance with some Polish chiefs and procured the support of several German princes, including his former ally, Henry of lower Bavaria. To meet this combination Rudolph entered into alliance with Ladislaus IV. king of Hungary, and gave additional privileges to the citizens of Vienna. On the 26th of August 1278 the rival armies met on the banks of the river March near Dürnkrut, and Ottakar was defeated and killed. Moravia was subdued and its government entrusted to Rudolph's representatives, while Wenceslaus was again betrothed to one of his daughters.

Rudolph's attention was next turned to his new possessions in Austria and the adjacent countries. He spent several years in establishing his authority there, but found some difficulty in making these provinces hereditary in his family. At length the hostility of the princes was overcome, and in December 1282 Rudolph invested his sons Albert and Rudolph with the duchies of Austria and Styria at Augsburg, and so laid the foundations of the greatness of the house of Habsburg.

Turning to the west he compelled Philip I. count of upper Burgundy to cede some districts to him in 1281, forced the citizens of Berne to pay the tribute which they had previously refused, and in 1280 marched against Philip's successor, Otto IV., and compelled him to do homage. In 1281 his first wife died, and on the 5th of February 1284 he married Isabella, daughter of Hugh IV. duke of Burgundy. Rudolph was not very successful in restoring internal peace to Germany. Orders were indeed issued for the establishment of landpeaces in Bavaria, Franconia and Swabia, and afterwards for the whole of Germany; but the king lacked the power, or the determination, to enforce them, although in December 1289 he led an expedition into Thuringia where he destroyed a number of robber-castles. In 1291 he attempted to secure the election of his son Albert as German king; but the princes refused on the pretext of their inability to support two kings, but perhaps because they feared the increasing power of the Habsburgs. Rudolph died at Spire on the 15th of July 1291 and was buried in the cathedral of that city. He had a large family, but only one of his sons, Albert, afterwards the German king Albert I., survived him. Rudolph was a tall man with pale face and prominent nose. He possessed many excellent qualities, bravery, piety and generosity; but his reign is memorable rather in the history of the house of Habsburg than in that of the kingdom of Germany.

BIBLIOGRAPHY.—The original authorities relating to the time and life of Rudolph are found in the *Monumenta Germaniae historica, Scriptores*. Band xvii. (Hanover and Berlin, 1826, fol.). The following should also be consulted: *Acta imperii selecta, Urkunden deutscher Könige und Kaiser*, edited by J. F. Böhmner (Innsbruck, 1870); *Acta imperii inedita seculi XIII et XIV, Urkunden und Briefe zur Geschichte des Kaiserreichs*, edited by E. Winkelmann (Innsbruck, 1885); *Aktenstücke zur Geschichte des deutschen Reiches unter den Königen Rudolf I. und Albrecht I.*, edited by F. Kaltenbrunner (Vienna, 1889); M. Gerbert, *Codex epistolaris Rudolfus I.* (Sanblas, 1772); F. J. Bodmann, *Codex epistolaris Rudolfus I. Romanorum regis* (Leipzig, 1866).

The best modern authorities are K. Hagen, *Deutsche Geschichte von Rudolf von Habsburg bis auf die neueste Zeit* (Frankfurt, 1854–57); O. Lorenz, *Geschichte Rudolfs von Habsburg und Adolfs von Nassau* (Vienna, 1863–67); Th. Lindner, *Deutsche Geschichte unter den Habsburgern und Luxemburgern* (Stuttgart, 1888–93); A. Huber, *Rudolf von Habsburg vor seiner Thronbesteigung* (Vienna, 1873); J. Hirn, *Rudolf von Habsburg* (Vienna, 1874); H. von Zeissberg, *Ueber das Rechtsverfahren Rudolf von Habsburg gegen Ottakar von Böhmen* (Vienna, 1882); H. Otto, *Die Beziehungen Rudolfs von Habsburg zu Papst Gregor X.* (Göttingen, 1893); A. Bussone, *Der Krieg von 1278 und der Schicksal der Habsburger* (Vienna, 1880); and O. Redlich, *Rudolf von Habsburg* (Innsbruck, 1903).

RUDOLPH II. (1552–1612), Roman emperor, son of the emperor Maximilian II. by his wife Maria, daughter of the emperor Charles V., was born in Vienna on the 18th of July 1552. In 1563 he was sent to Spain, where his natural abilities were improved by a good education, but he lacked the frank and tolerant spirit of his father, resembling rather his uncle Philip II. of Spain. In 1572 he was crowned king of Hungary, three years later king of Bohemia; and in October 1575 he was chosen king of the Romans, or German king, at Regensburg, becoming emperor on his father's death in October 1576. The importance of Rudolph's reign is negative rather than positive, consisting more in what he did not do than in what he did; although it is questionable whether any ruler could have prevented the religious struggles of Germany and the Thirty Years' War.

The more active part of the emperor's life was the period from his accession to about 1597. During that time he attended the infrequent imperial diets, and took an interest in the struggle in the Netherlands and the defence of the empire against the Turks. He was at times suspicious of the papal policy, while his relations with Spain were somewhat inharmonious. As a convinced Roman Catholic he forwarded the progress of the counter-reformation, and in general the tolerant policy of Maximilian II. was reversed. Political as well as religious privileges were attacked; the administration was conducted by Germans; and the result was a considerable amount of discontent which became very pronounced about the opening of the 17th century. Concurrently with the growth of this unrest Rudolph had become increasingly subject to attacks of depression and eccentricity, which were so serious as to amount almost to insanity. In 1604, after a war with Turkey had been in progress since 1593, many of the Hungarians rebelled against Rudolph and chose Stephen Bocskay as their prince. By this time the members of the Habsburg family were thoroughly alarmed at the indifference or incompetence of the emperor; and their anxieties were not diminished by the knowledge that he was in feeble health, was unmarried, and had refused to take any steps towards securing the election of a successor. In April 1606 they declared Rudolph incapable of ruling, and recognized one of his younger brothers, the archduke Matthias, afterwards emperor, as their head; and in the following June Matthias, having already with the emperor's reluctant consent taken the conduct of affairs into his own hands, made peace by granting extensive concessions to the rebellious Hungarians, and concluded a treaty with the sultan in November of the same year. Then shaking off his lethargy Rudolph prepared to renew the war with the Turks; a move which Matthias met by throwing himself upon the support of the national party in Hungary. Matthias also found adherents in other parts of his brother's dominions, with the result that in June 1608 the emperor was compelled to cede to him the kingdom of Hungary together with the government of Austria and Moravia. Rudolph now sought the aid of the princes of the empire, and even of the Protestants; but he had met with no success in this direction when trouble arose in Bohemia. Having at first rejected the demand of the Bohemians for greater religious liberty, the emperor was soon obliged to yield to superior force, and in 1609 he acceded to the popular wishes by issuing the Letter of Majesty (*Majestätsbrief*), and then made similar concessions to his subjects in Silesia and elsewhere. A short reconciliation with Matthias was followed by further disorder in Bohemia, which was invaded by Rudolph's cousin, the archduke Leopold (1586–1632). The Bohemians invoked the aid of Matthias, who gathered an army; and in 1611 the emperor, practically a prisoner at Prague, was again forced to cede a kingdom to his brother. Rudolph died at Prague, his usual place of residence, on the 20th of January 1612, and was succeeded as emperor by Matthias.

Rudolph was a clever and cultured man, greatly interested in chemistry, alchemy, astronomy and astrology; he was a patron of Tycho Brahe and Kepler, and was himself something

of a scholar and an artist. He was the greatest collector of his age, his agents ransacking Europe to fill his museums with rare works of art. His education at the Spanish court and an hereditary tendency to insanity, however, made him haughty, suspicious and consequently very unpopular, while even in his best days the temper of his mind was that of a recluse rather than of a ruler.

The sources for the life and times of Rudolph II. are somewhat scanty, as many of the official documents of the reign, which were kept at Prague and not at Vienna, were destroyed, probably during the Thirty Years' War. The best authorities, however, are: *Rudolphi II. epistolae ineditae*, edited by B. Comte de Pace (Vienna, 1771); M. Ritter, *Quellenbeiträge zur Geschichte des Kaisers Rudolf II.* (Munich, 1872); and *Deutsche Geschichte im Zeitalter der Gegenreformation und des dreissigjährigen Krieges* (Stuttgart, 1887 fol.); L. von Ranke, *Zur deutschen Geschichte: Vom Religionsfrieden bis zum 30-jährigen Kriege* (Leipzig, 1868); A. Gindely, *Rudolf II. und seine Zeit* (Prague, 1862–68); F. Stieve, *Die Verhandlungen über die Nachfolge Kaiser Rudolfs II.* (Munich, 1880); in the *Allgemeine Deutsche Biographie*, Band xxix. (Leipzig, 1889); and *Der Ursprung des dreissigjährigen Krieges* (Munich, 1878); F. von Bezold, *Kaiser Rudolf II. und die heilige Liga* (Munich, 1886); J. Jansson, *Geschichte des Deutschen Volkes seit dem Ausgang des Mittelalters* (Freiburg, 1878 fol.), of which there is an English translation by M. A. Mitchell and A. M. Christie (London, 1896 fol.); and H. Moritz, *Die Wahl Rudolfs II.* (Marburg, 1895).

RUDOLPH, or **RAOUL** (d. 936), king of the Franks and duke of Burgundy, was a son of Richard duke of Burgundy, and was probably a member of the Carolingian family. He became duke of Burgundy on his father's death in 921, and having married Emma, daughter of Robert duke of the Franks, assisted his father-in-law to drive the Frankish king, Charles III. (the Simple), from his throne. Robert then became king of the Franks, and when he was killed in battle in June 923 he was succeeded by Rudolph, who was crowned at Soissons in the following month. Giving Burgundy to his brother-in-law Gisibert of Vergi (d. 956), the new king was fully occupied in resisting the attacks of the Normans, and in combating the partisans of Charles the Simple; but his enterprises were mainly unsuccessful, and his authority was not generally recognized. But when engaged in a struggle with his brother-in-law, Herbert II. count of Vermandois, over the possession of the county of Laon, Rudolph experienced happier fortunes. At Limoges a great victory was gained over the Normans, whose duke, William I., did homage to him in 933; invasions of Aquitaine led to his recognition as king by the powerful lords of that district; and Herbert of Vermandois was defeated and put to flight. In 935 peace was made between these rivals; and on the 14th of January 936 Rudolph died at Auxerre, leaving no sons.

See W. Lippert, *König Rudolf von Frankreich* (Leipzig, 1886).

RUDOLPH (d. 1080), German king, and duke of Swabia, opponent of the emperor Henry IV., was a son of Kuno count of Rheinfelden, who possessed estates in both Burgundy and Swabia. He received the duchy of Swabia from Agnes, regent and mother of the young king, Henry IV., in 1057, and two years later married the king's sister Matilda (1045–1060), and was made administrator of the kingdom of Burgundy, or Arles. Differences soon arose between the king and his brother-in-law, whose loyalty was suspected during the Saxon War of 1073. When Henry was excommunicated and deposed by pope Gregory VII., the princes met at Forchheim, and elected Rudolph as German king. He renounced the right of investiture, disclaimed any intention of making the crown hereditary in his family, and was crowned at Mainz on the 27th of March 1077. He found no support in Swabia, but, uniting with the Saxons, won two victories over Henry's troops, and, in 1080, was recognized by the pope. On the 15th of October 1080, Rudolph was severely wounded at Hohenmölsen, and died the next day. He was buried at Merseburg, where his beautiful bronze tomb is still to be seen.

See O. Grund, *Die Wahl Rudolfs von Rheinfelden zum Gegenkönig* (Leipzig, 1880).

RUDOLPH, or **RAOUL**, known as **RUDOLPH GLABER** (*Rudolph the Bald*) (d. c. 1050), French chronicler, was born in

Burgundy about 985, and was in turn an inmate of the monasteries of St Leger at Champeaux and St Bénigne at Dijon, afterwards entering the famous abbey of Cluny, and becoming a monk at St Germain at Auxerre before 1039. He also appears to have visited Italy. His *Historiarum sui temporis libri VII*, dedicated to St Odilon, abbot of Cluny, purports to be a universal history from 900 to 1044; but is an irregular narration of events in France and Burgundy. Rudolph was a strong believer in the approaching end of the world.

The *Historiarum* was first printed in 1596, and published by A. Duchesne in the *Historiae Francorum Scriptores*, tome iv. (Paris, 1639-49). Extracts are printed in the *Monumenta Germaniae historica*, Band vii.; but perhaps the best edition of the work is the one edited by M. Prou in the *Collection de textes pour servir à l'étude et à l'enseignement de l'histoire* (Paris, 1886). Rudolph also wrote a *Vita S. Gultelmi, abbatis S. Benigni*, published by J. Mabillon in the *Acta Sanctorum*, tome vi. (Paris, 1668). See A. Molinier, *Les Sources de l'histoire de France*, tome ii. (Paris, 1902); and A. Potthast, *Bibliotheca historica* (Berlin, 1896).

RUDOLSTADT, a town of Germany, capital of the principality of Schwarzburg-Rudolstadt, and the chief residence of the prince, lies on the left bank of the Saale, 18 m. S.W. of Jena, by the railway Grossheringen-Saalfeld, in one of the most beautiful districts of Thuringia. Pop. (1905) 12,494. The picturesque town is a favourite tourist resort. Besides containing the government buildings of the little principality, Rudolstadt is well provided with schools and other institutions, including a library of 65,000 volumes. The residence of the prince is the Heidecksburg, a palace on an eminence 200 ft. above the Saale, which was rebuilt after a fire in 1735, and contains a picture gallery, a magnificent banquetting hall and a library. The Ludwigsburg, another palace in the town, built in 1742, accommodates the natural history collections belonging to the prince. The principal church dates from the end of the 15th century and contains tombs and effigies of many former princes. In the Anger, a public park between the town and the river, is the theatre. The Rudolstadt—a handsome hydro-pathic establishment with a richly decorated interior—lying amidst extensive grounds, is also noticeable. Various memorials in and near the town commemorate the visits of Schiller to the neighbourhood in 1787 and 1788. The industries of the place include the manufacture of porcelain, chocolate and dyestuffs, wool-spinning and bell-founding.

The name of Rudolstadt occurs in an inventory of the possessions of the abbey of Hersfeld in the year 800. After passing into the possession of the German kings and then of the rulers of Orlamünde and of Weimar, it came into the hands of the counts of Schwarzburg in 1335. Its civic rights were confirmed in 1404, and since 1599 it has been the residence of the ruling house of Schwarzburg-Rudolstadt.

See Renovanz, *Chronik von Rudolstadt* (Rudolstadt, 1860); Anemüller, *Geschichtsbilder aus der Vergangenheit Rudolstadts* (Rudolstadt, 1888); and Woelfl, *Rudolstadt* (2nd ed., Leipzig, 1890).

RUDRA (probably from the root *rud*, "to howl," hence "the howler"), in Hindu Vedic mythology, a storm god, and father of the Maruts who are frequently called Rudriyas. He shoots tempests at the earth, but is not essentially a malevolent deity, being invoked as a protector of cattle. In the Atharvaveda he is lord of life and death, and in later Hinduism one of the Hindu trinity, the god Siva.

See A. A. Macdonell, *Vedic Mythology* (Strassburg, 1897); Sir William Muir, *Original Sanskrit Texts*, iv. 299-420.

RUE (Fr. *rue*, Lat. *ruta*, from Gr. *ῥύρον*, the Peloponnesian word for the plant known as *ῥύρον*), the name of a woody or bushy herb, belonging to the genus *Ruta*, especially *Ruta graveolens*, the "common rue," a plant with bluish green spatted leaves and greenish yellow flowers. It has a strong pungent smell and the leaves have a bitter taste. The plant was much used in medieval and later medicine as a stimulative and irritant drug. It was commonly supposed to be much used by witches. From its association with "rue," sorrow, repentance (O. Eng. *hréow*, from *hréowan*, to be sorry

for, cf. Ger. *reuen*), the plant was also known as "herb of grace," and was taken as the symbol of repentance.

RUEDA, LOPE DE (1510?-1565?), Spanish dramatist, was born early in the 16th century at Seville, where, according to Cervantes, he worked as a metal-beater. His name first occurs in 1554 as acting at Benavente, and between 1558 and 1561 he was manager of a strolling company which visited Segovia, Seville, Toledo, Madrid, Valencia and Córdoba. In the last-named city Rueda fell ill, and on the 21st of March 1565 made a will which he was too exhausted to sign; he probably died shortly afterwards, and it is said by Cervantes to have been buried in Córdoba cathedral. He was twice married; first to a disreputable actress named Mariana, who became the mistress of the duke de Medinaceli; and second to Rafaela Angela, who bore him a daughter. His works were issued posthumously in 1567 by Timoneda, who toned down certain passages in the texts. Rueda's more ambitious plays are mostly adapted from the Italian; in *Eufemia* he draws on Boccaccio, in *Medora* he utilizes Giancarli's *Zingara*, in *Armelina* he combines Raineri's *Attilia* with Cecchi's *Servigiola*, and in *Los Engañados* he uses *Gl'Innamati*, a comedy produced by the *Intronati*, a literary society at Siena. These follow the original so closely that they give no idea of Rueda's talent; but in his *pasos* or prose interludes he displays an abundance of riotous humour, great knowledge of low life, and a most happy gift of dialogue. His predecessors mostly wrote for courtly audiences or for the study; Rueda with his strollers created a taste for the drama which he was able to gratify, and he is admitted both by Cervantes and Lope de Vega to be the true founder of the national theatre.

His works have been reprinted by the marquis de la Fuensanta del Valle in the *Colección de libros raros ó curiosos*, vols. xxiii. and xxiv.

RUEIL, a town of N. France, in the department of Seine-et-Oise, at the W. foot of Mt Valérien, 6 m. W. of Paris by tramway. Pop. (1906) 10,439. Rueil has a church rebuilt under Napoleon III. in exact imitation of a previous church in the Renaissance style, and containing the tombs of the Empress Josephine and her daughter Hortense de Beauharnais. In the 17th century Richelieu built a château which no longer exists. Rueil has important photographic works and manufactures of lime and cement, &c. Close to the town is the château of Malmaison, a building of the 18th century famous as the residence of the empress Josephine. It was afterwards occupied by Maria Christina, queen of Spain, and by the empress Eugénie. In 1900 the owner, Daniel Osiris, presented it and the park to the nation; the apartments have been as far as possible restored to the condition in which they were when inhabited by Josephine and Napoleon.

RUFF, a bird so called from the very beautiful and remarkable frill of elongated feathers that, just before the breeding-season, grow thickly round the neck of the male, who is considerably larger than the female, known as the reeve. In many respects this species, the *Tringa pugnax* of Linnaeus and the *Machetes pugnax* of modern ornithologists, is one of the most singular in existence. The best account is that given in 1813 by G. Montagu (*Suppl. Orn. Dictionary*), who seems to have been struck by the peculiarities of the species, and, to investigate them, visited the fens of Lincolnshire, possibly excited thereto by the example of T. Pennant, whose information, collected there in 1760, was of a kind to provoke further inquiry, while Daniel (*Rural Sports*, iii. p. 234) had added some other particulars, and subsequently G. Graves in 1816 repeated in the same district the experience of his predecessors. Since that time the great changes produced by the drainage of the fen-country have banished this species from nearly the whole of it, so that R. Lubbock (*Obs. Fauna of Norfolk*, pp. 68-73) and H. Stevenson (*Birds of Norfolk*, ii. pp. 261-271) can alone be cited as modern witnesses of its habits in England, while the trade of netting or snaring ruffs and fattening them for the table has for many years practically ceased.

The cock bird, when, to use the fenman's expression, he has

not "his show on," and the hen at all seasons, offer no very remarkable deviation from ordinary sandpipers; outwardly¹ there is nothing, except the unequal size of the two sexes, to rouse suspicion of any abnormal peculiarity. But when spring comes all is changed. In a surprisingly short time the feathers clothing the face of the male are shed, and their place is taken by *papillae* or small cruncles of bright yellow or pale pink. From each side of his head sprouts a tuft of stiff curled feathers, while the feathers of the throat change colour, and beneath and around it sprouts the frill or ruff already mentioned as giving the bird his name. The feathers which form this remarkable adornment are, like those of the "ear-tufts," stiff and incurved at the end, but much longer—measuring more than 2 in. They are closely arrayed, capable of depression or elevation, and form a shield to the front of the breast impervious to the bill of a rival.² More extraordinary than this, from one point of view, is the great variety of coloration that obtains in these temporary outgrowths. Considering the really few colours that the birds exhibit, the variation is something marvellous, so that fifty examples may be compared without finding a very close resemblance between any two of



Ruff.

them, while the individual variation is increased by the "ear-tufts," which generally differ in colour from the frill. The colours range from deep black to pure white, passing through chestnut or bay, and many tints of brown or ashy-grey, while often the feathers are more or less closely barred with some darker shade, and the black is very frequently glossed with violet, blue or green—or, in addition, spangled with white grey or gold-colour. The white, on the other hand, is not rarely freckled, streaked, or barred with grey, rufous-brown or black. In some examples the barring is most regularly concentric, in others more or less broken-up or undulating, and the latter may be said of the streaks. It was ascertained by Montagu, and has since been confirmed by A. D. Bartlett, that every ruff assumes tufts and frill exactly the same in colour and markings as those he wore in the preceding season; and thus, polymorphic as is the male as a species, as an individual he is unchangeable. The white frill is said to be the rarest, and birds exhibiting it have white necks even in winter.

That all this wonderful "show" is the consequence of the polygamous habit of the ruff can scarcely be doubted. No

¹ Internally there is a great difference in the form of the posterior margin of the sternum, as long ago remarked by Nitzsch.

² This "ruff" has been compared to that of Elizabethan or Jacobean costume, but it is essentially different, since that was open in front and widest and most projecting behind, whereas the bird's decorative apparel is most developed in front and at the sides and scarcely exists behind.

other species of Limicoline bird has, so far as is known, any tendency to it. Indeed, in many species of *Limicolae*, as the dotterel, the godwits (*g.r.*), phalaropes and perhaps some others, the female is larger and more brightly coloured than the male, who in such cases seems to take upon himself some at least of the domestic duties. Both Montagu and Graves, to say nothing of other writers, state that the ruffs, in England, were far more numerous than the reeves; and their testimony can hardly be doubted; though in Germany J. F. Naumann (*Vög. Deutschlands*, vii. p. 544) considers that this is only the case in the earlier part of the season, and that later the females greatly outnumber the males. By no one have the ruff's characteristics been more happily described than by J. Wolley, in a communication to W. C. Hewitson (*Eggs of Brit. Birds*, 3d ed., p. 346), as follows:—

"The ruff, like other fine gentlemen, takes much more trouble with his courtship than with his duties as a husband. Whilst the reeves are sitting on their eggs, scattered about the swamps, he is to be seen far away flitting about in flocks, and on the ground dancing and sparring with his companions. Before they are confined to their nests, it is wonderful with what devotion the females are attended by their gay followers, who seem to be each trying to be more attentive than the rest. Nothing can be more expressive of humility and ardent love than some of the actions of the ruff. He throws himself prostrate on the ground, with every feather on his body standing up and quivering; but he seems as if he were afraid of coming too near his mistress. If she flies off, he starts up in an instant to arrive before her at the next place of alighting, and all his actions are full of life and spirit. But none of his spirit is expended in care for his family. He never comes to see after an enemy. In the [Lapland] marshes, a reeve now and then flies near with a scarcely audible *ka-ka-kuk*; but she seems a dull bird, and makes no noisy attack on an invader."

The breeding-grounds of the ruff extend from Great Britain across N. Europe and Asia; but the birds become less numerous towards the E. They winter in India, reaching even Ceylon, and Africa as far as the Cape of Good Hope. The ruff also occasionally visits Iceland, and there are several well-authenticated records of its occurrence on the E. coast of the United States, while an example is stated (*Ibis*, 1875, p. 332) to have been received from the N. of S. America. (A. N.)

RUFFIAN (Fr. *ruffian*, It. *ruffiano*), a brutal, violent person, a swaggering, low bully. The etymology is obscure, but the word has been connected with "ruffler," a bully, swaggerer, one who "ruffles" (*M. Du. roffeln, to pander*). An early derivation, quoted in Du Cange, derives it from Lat. *rufus*, red, as the hair of the *meretricies*, with whom the *ruffiani* were generally associated, was red or gold, as contrasted with the black hair of sober matrons.

RUFFO, FABRIZIO (1744-1827), Neapolitan cardinal and politician, was born at San Lucido in Calabria on the 16th of September 1744. His father, Litterio Ruffo, was duke of Baranello, and his mother, Giustiniana, was of the family of Colonna. Fabrizio owed his education to his uncle, the cardinal Thomas Ruffo, then dean of the Sacred College. In early life he secured the favour of Giovanni Angelo Braschi di Cesera, who in 1775 became Pope Pius VI. Ruffo was placed by the pope among the *chierici di camera*—the clerks who formed the papal civil and financial service. He was later promoted to be treasurer-general, a post which carried with it the ministry of war. Ruffo's conduct in office was diversely judged. Colletta, the historian of Naples, speaks of him as corrupt, and Jomini repeats the charge. Ruffo's biographer, Sachinelli, says that he incurred hostility by restricting the feudal powers of some of the landowners in the papal states. In 1791 he was removed from the treasuryship, but was created cardinal on the 29th of September, though he was not in orders. He never became a priest. Ruffo went to Naples, where he was named administrator of the royal domain of Caserta, and received the abbey of S. Sophia in Benevento in commendam. When in December 1798 the French troops advanced on Naples, Ruffo fled to Palermo with the royal family. He was chosen to head a royalist movement in Calabria, where his family, though impoverished by debt, exercised large feudal powers. He was named vicar-general on the 25th of January 1700. On the 8th of February he landed at

La Cortona with a small following, and began to raise the so-called "army of the faith" in association with Fra Diavolo and other brigand leaders. Ruffo had no difficulty in upsetting the republican government established by the French, and by June had advanced to Naples (see NAPLES and NELSON). The campaign has given rise to much controversy. Ruffo appears to have lost favour with the king by showing a tendency to spare the republicans. He resigned his vicar-generalship to the prince of Cassero, and during the second French conquest and the reigns of Joseph Bonaparte and Murat he lived quietly in Naples. Some notice was taken of him by Napoleon, but he never held an important post. After the restoration of the Bourbons he was received into favour. During the revolutionary troubles of 1822 he was consulted by the king, and was even in office for a very short time as a "loyalist" minister. He died on the 13th of December 1827.

The account of Ruffo given in Colletta's *History of Naples* (English translation, Edinburgh, 1860) must be taken with caution. Colletta was a violent liberal partisan, who wrote in exile, and largely from memory. He has been corrected by the Duca de Lauria, *Intorno a Ruffo e alla sua vita* (Napoli, 1877). Ruffo's own side of the question is stated in *Memorie Storiche sulla vita del Cardinale Fabrizio Ruffo*, by Domenico Sacchinelli (Naples, 1836). See also *Fabrizio Ruffo: Revolution and Gegen-Revolution von Neapel*, by Baron von Helfert (Vienna, 1882).

RUFUJI, a large river of German East Africa, entering the sea by a considerable delta, between $7^{\circ} 45'$ and $8^{\circ} 13'$ S. Its upper basin, which extends from N. to S. through over 300 m., is drained by three main branches, which unite to form the lower Rufuji. Of the three upper branches, the two southern, the Luvegu and the Ulanga, though shorter than the northernmost (the Ruaha), carry a greater volume of water, as they come from a more rainy region, and by their junction in $8^{\circ} 35'$ S., $37^{\circ} 25'$ E., the Rufuji proper may be said to be formed.

The Luvegu rises $10^{\circ} 50'$ S., $35^{\circ} 50'$ E., and flows N.E. in a wooded valley, generally narrow, and bordered by a broken country in great part uninhabited and covered with thin forest. In its lower course it is a large stream—100 to 150 yds. wide.

The Ulanga is formed by a number of streams descending from the outer escarpment of the high plateau which runs N.E. from the head of Lake Nyasa and in Uhehe becomes broken up in ranges of mountains. The most important head-stream, the Ruhudye, rises in about $9^{\circ} 30'$ S., $34^{\circ} 40'$ E. As a whole, the Ulanga valley is broad, level and swampy, the river running in a very winding course and sending off many diverging arms. It is navigable throughout the greater part of its course, having even in the dry season a general depth of 3 to 12 ft., with a width of 40 to 120 yds. In April and May nearly all the streams overflow their banks and cover a great part of the plain.

Just below the junction of the Luvegu and Ulanga, the Rufuji flows through a narrow pass by the Shuguli falls, and continues N.E. in a fairly straight course to the junction of the Ruaha, in $7^{\circ} 55'$ S., $37^{\circ} 52'$ E. The most remote branches of the Ruaha rise N. of Lake Nyasa in the Livingstone mountains. The united stream makes a wide sweep to the N. of the Uhehe mountains, from which it receives various tributaries, finally flowing S.E. and E. to the Rufuji. A little below the junction the Rufuji is broken by the Pangani falls, but is thence navigable by small steamers to its delta. In this part of its course the river receives no large tributaries but sends out divergent channels. The country on either side is a generally level plain, inundated, on the south, in the rains, and the river varies in width from 100 to 400 yds., with an average current of 3 m. an hour. The main mouth of the river is that known as Simba Uranga, the bar of which can be crossed by ocean vessels at high water, but all the branches are very shallow as the apex of the delta is approached. Much of the delta is suited for rice-growing.

RUFINUS, TYRANNIUS, presbyter and theologian, was born at or near Aquileia at the head of the Adriatic, probably between 340 and 345. In early manhood he entered the cloister as a catechumen, receiving baptism about 370. About the same time a visit of Jerome to Aquileia led to a close friendship between the two, and shortly after Jerome's departure for the East Rufinus also was drawn thither (in 372 or 373) by his interest in its theology and monasticism. He first settled in Egypt, hearing the lectures of Didymus, the Origenistic head of the catechetical school at Alexandria, and also cultivating friendly relations with Macarius the elder and other ascetics in the desert. In Egypt, if not even before leaving Italy, he

had become intimately acquainted with Melania, a wealthy and devout Roman widow; and when she removed to Palestine, taking with her a number of clergy and monks on whom the persecutions of the Arian Valens had borne heavily, Rufinus (about 378) followed her. While his patroness lived in a convent of her own in Jerusalem, Rufinus, at her expense, gathered together a number of monks in a monastery on the Mount of Olives, devoting himself at the same time to the study of Greek theology. This combination of the contemplative life and the life of learning had already developed in the Egyptian monasteries. When Jerome came to Bethlehem in 386, the friendship formed at Aquileia was renewed. Another of the intimates of Rufinus was John, bishop of Jerusalem, and formerly a Nitrian monk, by whom he was ordained to the priesthood in 390. In 394, in consequence of the attack upon the doctrines of Origen made by Epiphanius of Salamis during a visit to Jerusalem, a fierce quarrel broke out, which found Rufinus and Jerome on different sides; and, though three years afterwards a formal reconciliation was brought about between Jerome and John, the breach between Jerome and Rufinus remained unhealed.

In the autumn of 397 Rufinus embarked for Rome, where, finding that the theological controversies of the East were exciting much interest and curiosity, he published a Latin translation of the *Apology* of Pamphilus for Origen, and also (398–99) a somewhat free rendering of the *περί ἀρχῶν* (or *De Principiis*) of that author himself. In the preface to the latter work he referred to Jerome as an admirer of Origen, and as having already translated some of his works with modifications of ambiguous doctrinal expressions. This allusion annoyed Jerome, who was exceedingly sensitive as to his reputation for orthodoxy, and the consequence was a bitter pamphlet war, very wonderful to the modern onlooker, who finds it difficult to see anything discreditable in the accusation against a biblical scholar that he had once thought well of Origen, or in the countercharge against a translator that he had avowedly exercised editorial functions as well. At the instigation of Theophilus of Alexandria, Anastasius (pope 398–402) summoned Rufinus from Aquileia to Rome to vindicate his orthodoxy; but he excused himself from a personal attendance in a written *Apologia pro fide sua*. The pope in his reply expressly condemned Origen, but left the question of Rufinus's orthodoxy to his own conscience. He was, however, regarded with suspicion in orthodox circles (cf. the *Decretum Gelasii*, § 20) in spite of his services to Christian literature. In 408 we find Rufinus at the monastery of Pinetum (in the Campagna?); thence he was driven by the arrival of Alaric to Sicily, being accompanied by Melania in his flight. In Sicily he was engaged in translating the *Homilies* of Origen when he died in 410.

The original works of Rufinus are—(1) *De Adulatione Librorum Origenis*—an appendix to his translation of the *Apology* of Pamphilus, and intended to show that many of the features in Origen's teaching which were then held to be objectionable arose from interpolations and falsifications of the genuine text; (2) *De Benedictominibus XII Patriarcharum Libri II*—an exposition of Gen. xlix.; (3) *Apologia s. Inveictarum in Hieronymum Libri II*; (4) *Apologia pro Fide Sua ad Anastasium Pontificem*; (5) *Historia Eremistica*—consisting of the lives of thirty-three monks of the Nitrian desert; (6) *Expositio Symboli*, a commentary on the creed of Aquileia comparing it with that of Rome, which is valuable for its evidence as to church teaching in the 4th century. The *Historia Ecclesiastica Libri XI* of Rufinus consist partly of a free translation of Eusebius (10 books in 6) and partly of a continuation (bks. x. and xi.) down to the death of Theodosius the Great. The other translations of Rufinus are—(1) the *Institutio Monachorum* and some of the *Homilies* of Basil; (2) the *Apology* of Pamphilus, referred to above; (3) *Origen's Principia*; (4) Origen's *Homilies* (Gen.—Kings, also Cant. and Rom.); (5) *Opuscula* of Gregory of Nazianzus; (6) the *Sententiae* of Sixtus, an unknown Greek philosopher; (7) the *Sententiae* of Evagrius; (8) the *Clementine Recognitions* (the only form in which that work is now extant); (9) the *Canon Paschalis* of Anatolius Alexandrinus. We can hardly overestimate the influence which Rufinus exerted on Western theologians by thus putting the great Greek fathers into the Latin tongue. D. Vallarsi's uncompleted edition of Rufinus (vol. i. fol., Verona, 1745) contains the *De Benedictominibus*, the *Apologies*, the

¹ On this work see Dom Butler in *Texts and Studies*, vi. i. pp. 10 ff.

Expositio Symboli, the Historia Eremitica and the two original books of the *Hist. Ecd.* See also Migne, *Patrol.* (vol. xxi. of the Latin series). For the translations, see the various editions of Origen, Eusebius, &c.

See W. H. Freemantle in *Dict. Chr. Biog.* iv. 555-60; A. Ebert, *Allg. Gesch. d. Litt. d. Mittelalters im Abendlande*, i. 321-27 (Leipzig, 1889); G. Krüger in *Hauck-Herzog's Real-encycl. für prot. Theol.*, where there is a full bibliography.

RUFUS, GAIVS VALGIUS, Latin poet, friend of Horace and Maecenas, and consul in 12 B.C. He was known as a writer of elegies and epigrams, and his contemporaries believed him capable of great things in epic. The author of the panegyric on Messalla declares Rufus to be the only poet fitted to be the great man's Homer. Rufus did not, however, confine himself to poetry. He discussed grammatical questions by correspondence, translated the rhetorical manual of his teacher Apollodorus of Pergamum, and began a treatise on medicinal plants, dedicated to Augustus. Horace addressed to him the ninth ode of the second book.

Fragments in R. Weichert, *Poetorum Latinorum Vitae et Carminum Reliquiae* (1830); R. Unger, *De C. Valgii Rufi Poematis* (1848); O. Ribbeck, *Geschichte der römischen Dichtung* (1889), ii.; M. Schanz, *Geschichte der römischen Literatur* (1899), ii. 1; Teuffel, *Hist. of Roman Literature* (Eng. trans., 1900), 241.

RUFUS, LUCIVS VARIUS (c. 74-14 B.C.), Roman poet of the Augustan age. He was the friend of Virgil, after whose death he and Plotius Tucca prepared the *Aeneid* for publication, and of Horace, for whom he and Virgil obtained an introduction to Maecenas. Horace speaks of him as a master of epic and the only poet capable of celebrating the achievements of Vipsanius Agrippa (*Odes*, i. 6); Virgil (under the name of Lycidas, *Ecl.* ix. 35) regrets that he had hitherto produced nothing comparable to the work of Varius or Helvius Cinna. From Macrobius (*Saturnalia*, vi. 1, 30; 2, 19) we learn that Varius composed an epic poem *De Morte*, some lines of which are quoted as having been imitated or appropriated by Virgil; Horace (*Sat.* i. 10, 43) probably alludes to another epic, and, according to the scholiast on *Epistles*, i. 16, 27-29, these three lines are taken bodily from a panegyric of Varius on Augustus. But his most famous literary production was the tragedy *Thyestes*, which Quintilian (*Inst. Orat.* x. 1, 98) declares fit to rank with any of the Greek tragedies. The didascalica (which is preserved in a Paris MS.) informs us that it was produced at the games celebrated (29 B.C.) by Augustus in honour of the victory at Actium, and that Varius received a present of a million sesterces from the emperor.

Fragments in E. Bährens, *Frag. Poetorum Romanorum* (1886); monographs by A. Weichert (1836) and R. Unger (1870, 1878, 1898); M. Schanz, *Geschichte der römischen Literatur* (1899), ii. 1; Teuffel, *Hist. of Roman Literature* (Eng. trans., 1900), 223.

RUG, a term of Scandinavian origin (cf. Swed. *rugg*, rough hair; Norw. dial. *rugga*, rough), and probably connected with "rough" and "rag," originally for a kind of coarse woollen material, like frieze; hence it is used of a piece of thick material used as a wrap or covering for the knees or body in travelling or in bed, and especially for a thick mat or small-sized carpet laid on the floor (see CARPET).

RUGBY, a market town in the Rugby parliamentary division of Warwickshire, England, finely situated on a tableland rising from the S. bank of the Avon, near the Oxford Canal. Pop. of urban district (1901), 16,830. It is an important junction on the London & North-Western railway, by which it is 8½ m. N.W. from London; it is served also by the Great Central railway and by a branch of the Midland railway from Leicester.

The boys' school, ranking as one of the most famous public schools in England, was founded and endowed under the will (1567) of Laurence Sheriff, a merchant grocer and servant to Queen Elizabeth, and a native either of Rugby or of the neighbouring village of Brownsover. The endowment consisted of the parsonage of Brownsover, Sheriff's mansion house in Rugby, and one-third (8 acres) of his estate in Middlesex, near the Foundling Hospital, London, which, being let on building leases, gradually increased to about £5000 a year. The full

endowment was obtained in 1653. The school originally stood opposite the parish church, and was removed to its present site on the S. side of the town between 1740 and 1750. In 1809 it was rebuilt from designs by Henry Hakewill (1777-1830); the chapel, dedicated to St Lawrence, was added in 1820. At the tercentenary of the school in 1867 subscriptions were set on foot for founding scholarships, building additional schoolrooms, rebuilding or enlarging the chapel and other objects. The chapel was rebuilt and reconsecrated in 1872, and further additions were made in 1898. A swimming bath was erected in 1876; the Temple observatory, containing a fine equatorial refractor by Alvan Clark, was built in 1877, and the Temple reading-room with the art museum in 1878. The workshops underneath the gymnasium were opened in 1880, and a new big school and class-rooms were erected in 1885. From about 70 to 1777 the numbers attending the school have increased to nearly 600. A great impulse was given to the progress of the school during the headmastership of Thomas Arnold, 1827-42. Among Arnold's successors were Archibald Campbell Tait and Frederick Temple, both afterwards archbishops of Canterbury.

The parish church of St Andrew was rebuilt from designs by W. Butterfield and reconsecrated in 1879. A tower and spire were added in 1895. An aisle commemorates John Moultrie (1799-1874), rector, widely known as the "poet pastor." The church of Holy Trinity is by Sir G. G. Scott, and the Roman Catholic church of St Marie by A. W. Pugin. Trade is mainly agricultural; there is a large cattle market, and several fairs are held annually.

The early history of Rugby is obscure, but a settlement of the Danes is presumed from the name, and from the neighbouring tract of Dunsmore Heath (Danesmoor). Rugby was originally a hamlet of the adjoining parish of Clifton-on-Dunsmore, and is separately treated of as such in Domesday Book. Ernauld de Bosco (Ernauld de Bois), lord of the manor of Clifton, seems to have erected the first chapel in Rugby, in the reign of Stephen, about 1140. It was afterwards granted by him, with certain lands, to endow the abbey of St Mary, Leicester, which grant was confirmed by his successors and by royal charter of Henry II. In the second year of King John (1200) a suit took place between Henry de Rokeby, lord of the manor of Rugby, and Paul, abbot of St Mary, Leicester, which resulted in the former obtaining possession of the advowson of Rugby, on condition of homage and service to the abbot of Leicester. By virtue of this agreement the chapel was converted into a parish church and the vicarage into a rectory.

RUGE, ARNOLD (1802-1880), German philosopher and political writer, was born at Bergen, in the island of Rügen, on the 13th of September 1802. He studied at Halle, Jena and Heidelberg, and became an adherent of the party which sought to create a free and united Germany. For his zeal he was confined for five years in the fortress of Kolberg, where he studied Plato and the Greek poets. On his release in 1830 he published *Schill und die Seinen*, a tragedy, and a translation of *Oedipus in Colonus*. Ruge settled in Halle, where in 1837 with E. T. Echtermeyer he founded the *Halle'sche Jahrbücher für deutsche Kunst und Wissenschaft*. In this periodical he discussed the questions of the time from the point of view of the Hegelian philosophy. The *Jahrbücher* was detested by the orthodox party in Prussia; and was finally suppressed by the Saxon government in 1843. In Paris Ruge tried to act with Karl Marx as co-editor of the *Deutsch-Französische Jahrbücher*, but had little sympathy with Marx's socialistic theories, and soon left him. In the revolutionary movement of 1848 he organized the Extreme Left in the Frankfurt parliament, and for some time he lived in Berlin as the editor of the *Die Reform*. The Prussian government intervened and Ruge soon afterwards left for Paris, hoping, through his friend Alexandre Ledru-Rollin, to establish relations between German and French republicans; but in 1849 both Ledru-Rollin and Ruge had to take refuge in London. Here, in company with Giuseppe Mazzini and other advanced politicians, they formed a "European Democratic Committee." From this Ruge soon withdrew, and in 1850 went to Brighton, where he supported himself by teaching and writing. In 1866 and 1870 he vigorously

supported Prussia against Austria, and Germany against France. In his last years he received from the German government a pension of 1000 marks. He died on the 31st of December 1880.

Ruge was a leader in religious and political liberalism, but did not produce any work of enduring importance. In 1846-48 his *Gesammelte Schriften* were published in ten volumes. After this time he wrote, among other books, *Unser System, Revolutionsnoellen, Die Loge des Humanismus, und Aus früherer Zeit* (his memoirs). He also wrote many poems, and several dramas and romances, and translated into German various English works, including the *Letters of Junius* and Buckle's *History of Civilization*. His *Letters and Diary* (1825-80) were published by Paul Nerlich (Berlin, 1885-87). See A. W. Bolin's *L. Feuerbach*, pp. 127-52 (Stuttgart, 1891).

RUGELEY, a market town in the Lichfield parliamentary division of Staffordshire, England, in the Trent valley. Pop. of urban district (1901), 4447. The London & North-Western railway has stations on the main line (Trent Valley, 124½ m. N.W. from London), and at the town, on a branch line to Walsall. The Grand Trunk canal here follows the Trent. To the S.W. lie the hills of Cannock Chase. The church of St Augustine is modern; of the parish church of the 14th century only the tower and chancel remain. The municipal offices, market hall and assembly-room are contained in one building (1870). A grammar school was founded in 1611. There are ironfoundries, corn-mills and tanneries; and the parish includes several collieries.

RÜGEN, an island of Germany, in the Baltic, immediately opposite Stralsund, 1½ m. off the north-west coast of Pomerania in Prussia, from which it is separated by the narrow Strelasund, or Bodden. Its shape is exceedingly irregular, and its coastline is broken by numerous bays and peninsulas, sometimes of considerable size. The general name is applied by the natives only to the roughly triangular main trunk of the island, while the larger peninsulas, the landward extremities of which taper to narrow necks of land, are considered to be as distinct from Rügen as the various adjacent smaller islands which are also included for statistical purposes under the name. The chief peninsulas are those of Jasmund and Wittow on the north, and Mönchgut, at one time the property of the monastery of Eldena, on the south-east; and the chief neighbouring islands are Ummanz and Hiddensee, both off the north-west coast. Rügen is the largest island in Germany. Its greatest length from N. to S. is 32 m.; its greatest breadth is 25½ m.; and its area is 377 sq. m. The surface gradually rises towards the west to Rugard (335 ft.)—the "eye of Rügen"—near Bergen, but the highest point is the Hertaburg (505 ft.) in Jasmund. Erratic blocks are scattered throughout the island, and the roads are made with granite. Though much of Rügen is flat and sandy, the fine beech woods which cover a great part of it, and the bold northern coast scenery combine with the convenient sea-bathing offered by the various villages around the coast to attract large numbers of visitors. The most beautiful and attractive part of the island is the peninsula of Jasmund, which terminates to the north in the Stubbenkammer (Slavonic for "rock steps"), a sheer chalk cliff, the summit of which, the Königstuhl, is 420 ft. above the sea. The east of Jasmund is clothed with an extensive beech wood called the Stubbenitz, in which lies the Borg, or Herta Lake. Connected with Jasmund by the narrow isthmus of Schabe to the west is the peninsula of Wittow, the most fertile part of the island. At its north-west extremity rises the height of Arcona, with a lighthouse.

A ferry connects the island with Stralsund, and from the landing-stage at Altefähr a railway traverses the island, passing the capital Bergen to Sassnitz, on the north-east coast. Hence a regular steamboat service connects with Trelleborg in Sweden, thus affording direct communication between Berlin and Stockholm. The other chief places are Garz, Sagard, Ginstg and Putbus, the last being the old capital of a barony of the princes of Putbus. Sassnitz, Göhren, Sellin and Lauterbach-Putbus are among the favourite bathing resorts. Schoritz was the birthplace of the patriot and poet, Ernst Moritz Arndt.

Ecclesiastically Rügen is divided into 75 parishes, in which the pastoral succession is said to be almost hereditary. The inhabitants are distinguished from those of the mainland by peculiarities of dialect, costume and habits; and even the various peninsulas differ from each other in these particulars. The peninsula of Mönchgut has best preserved its peculiarities; but there, too, primitive simplicity is yielding to the influence of the annual stream of summer visitors. The inhabitants raise some cattle, and Rügen has long been famous for its geese; but the only really considerable industry is fishing,—the herring-fishery being especially important. Rügen, with the neighbouring islands, forms a governmental department, with a population (1905) of 47,023.

The original Germanic inhabitants of Rügen were dispossessed by Slavs; and there are still various relics of the long reign of paganism that ensued. In the Stubbenitz and elsewhere Huns' or giants' graves are common; and near the Hertha Lake are the ruins of an ancient edifice which some have sought to identify with the shrine of the heathen deity Hertha or Nerthus, referred to by Tacitus. On Arcona in Wittow are the remains of an ancient fortress, enclosing a temple which was destroyed in 1168 by the Danish king Waldemar I., who he made himself master of the island. Rügen was ruled then by a succession of native princes, under Danish supremacy, until 1218. After being for a century and a half in the possession of a branch of the ruling family in Pomerania, it was finally united with that duchy in 1478, and passed with it into the possession of Sweden in 1648. With the rest of Western Pomerania Rügen has belonged to Prussia since 1815.

See Fock, *Rügensch-pommersche Geschichten* (6 vols., Leipzig, 1861-72); R. Baier, *Die Insel Rügen nach ihrer archäologischen Bedeutung* (Stralsund, 1886); R. Credner, *Rügen. Eine Inselstudie* (Stuttgart, 1893); Edwin Müller, *Die Insel Rügen* (17th ed., Berlin, 1900); Schuster, *Führer durch die Insel Rügen* (7th ed., Stettin, 1901); Boll, *Die Insel Rügen* (Schwerin, 1858?); O. Wendler, *Geschichte Rügens seit der ältesten Zeit* (Bergen, 1895); A. Haas, *Rügensche Sagen und Märchen* (Greifswald, 1891); U. John, *Volksagen aus Rügen* (Stettin, 1886); and E. M. Arndt, *Fairy Tales from the Isle of Rügen* (London, 1896).

RUHLA, a town of Germany, partly in the duchy of Saxe-Weimar and partly in that of Saxe-Coburg-Gotha. Pop. (1905) 7017. It stretches along the valley of the Erb in the Thuringian forest 8 m. S. of Eisenach, and attracts a number of visitors owing to its beautiful natural surroundings and its mineral springs. Its staple industry is the making of wooden and meerscham pipes; it has also electrical works, and some small manufactures. Ruhla, which is known locally as *Die Ruhla*, was famous in the middle ages for its armourers, and subsequently for its cutlers.

See Ziegler, *Das Thüringerwaldthor Ruhla* (Dresden, 1876).

RUHNKEN, DAVID (1723-1798), one of the most illustrious scholars of the Netherlands, was of German origin, having been born in Pomerania in 1723. His parents had him educated for the church, but after two years at the university of Wittenberg he determined to live the life of a scholar. At Wittenberg Ruhnken lived in close intimacy with the two most distinguished professors, Ritter and Berger. To them he owed a thorough grounding in ancient history and Roman antiquities and literature; and from them he learned a pure and vivid Latin style. At Wittenberg, too, Ruhnken derived valuable mental training from study in mathematics and Roman law. Probably nothing would have severed him from his surroundings there but a desire which daily grew upon him to explore the inmost recesses of Greek literature. Neither at Wittenberg nor at any other German university was Greek in that age seriously studied. It was taught in the main to students in divinity for the sake of the Greek Testament and the early fathers of the church. F. A. Wolf is the real creator of Greek scholarship in modern Germany, and Porson's gibe that "the Germans in Greek are sadly to seek" was barbed with truth. It is significant of the state of Hellenic studies in Germany in 1743 that their leading exponents were Gesner and Ernesti. Ruhnken was well advised by his friends at Wittenberg to seek the university of Leiden, where, stimulated by the influence of Bentley, the great scholar Tiberius Hemsterhuis had founded the only real school of Greek learning which had existed on the Continent since the days of Joseph Scaliger and Isaac Casaubon.

Perhaps no two men of letters ever lived in closer friendship than Hemsterhuis and Ruhnken during the twenty-three years which passed from Ruhnken's arrival in the Netherlands in 1743 to the death of Hemsterhuis in 1766. A few years made it clear that Ruhnken and Valckenauer were the two pupils of the great master on whom his inheritance must devolve. As his reputation spread, many efforts were made to attract Ruhnken back to Germany, but after settling in Leiden, he only left the country once, when he spent a year in Paris, ransacking the public libraries (1755). For work achieved, this year of Ruhnken may compare even with the famous year which Ritschl spent in Italy. In 1757 Ruhnken was appointed lecturer in Greek, to assist Hemsterhuis, and in 1761 he succeeded Oudendorp, with the title of "ordinary professor of history and eloquence," but practically as Latin professor. This promotion drew on him the enmity of some native Dutchmen, who deemed themselves (not without some show of reason) to possess stronger claims for a chair of Latin. The only defence made by Ruhnken was to publish works on Latin literature which eclipsed and silenced his rivals. In 1766 Valckenauer succeeded Hemsterhuis in the Greek chair. The intimacy between the two colleagues was only broken by Valckenauer's death in 1785, and stood without strain the test of common candidature for the office (an important one at Leiden) of university librarian, in which Ruhnken was successful. Ruhnken's later years were clouded by severe domestic misfortune, and by the political commotions which, after the outbreak of the war with England in 1780, troubled the Netherlands without ceasing, and threatened to extinguish the university of Leiden. He died in 1798.

Personally, Ruhnken was as far as possible removed from being a recluse or a pedant. He had a well-knit and even handsome frame, attractive manners (though sometimes tinged with irony), and a nature simple and healthy, and open to impressions from all sides. Fond of society, he cared little to what rank his associates belonged, if they were genuine men in whom he might find something to learn. His biographer even says of him in his early days that he knew how to sacrifice to the Sirens without proving traitor to the Muses. Life in the open air had a great attraction for him; he was fond of sport, and would sometimes devote to it two or three days in the week. In his bearing towards other scholars Ruhnken was generous and dignified, distributing literary aid with a free hand, and meeting onslaughts for the most part with a smile. In the records of learning he occupies an important position. He forms a principal link in the chain which connects Bentley with the modern scholarship of the Continent. The spirit and the aims of Hemsterhuis, the great reviver of Continental learning, were committed to his trust, and were faithfully maintained. He greatly widened the circle of those who valued taste and precision in classical scholarship. He powerfully aided the emancipation of Greek studies from theology; nor must it be forgotten that he first in modern times dared to think of rescuing Plato from the hands of the professed philosophers—men presumptuous enough to interpret the ancient sage with little or no knowledge of the language in which he wrote.

Ruhnken's principal works are editions of (1) *Timaeus's Lexicon of Platonic Words*, (2) Thales and other Greek commentators on Roman law, (3) *Rutilius Lupus* and other grammarians, (4) *Velleius Paterculus*, (5) the works of Muretus. He also occupied himself much with the history of Greek literature, particularly the oratorical literature, with the Homeric hymns, the scholia on Plato and the Greek and Roman grammarians and rhetoricians. A discovery famous in its time was that in the text of the work of Apsines on rhetoric a large piece of a work by Longinus was embedded. Modern views of the writings attributed to Longinus have lessened the interest of this discovery without lessening its merit. The biography of Ruhnken was written by his great pupil, Wyttenbach, soon after his death. (J. S. R.)

RUHR, a river of Germany, an important right-bank tributary of the lower Rhine. It rises on the north side of the Winterberg in the Sauerland, at a height of about 2000 ft. above the sea. It first takes a northerly and north-westerly course, and in a deep and well-wooded valley winds past the romantically

situated town of Arnsberg. Shortly after reaching Neheim it bends to the south-west, courses through the mining district around Hagen, and receives from the left the waters of the Lenne. Hence in a tortuous course it works its way past Witten, Steele, Kettwig and Mülheim, and, after a course of 142 m., discharges itself into the Rhine at Ruhrort. From this place the Ruhr canal connects it with Duisburg. The river is navigable from Witten downwards (43 m.), by the aid of eleven locks; but navigation is often greatly impeded through dearth of water.

RUHRORT, a town of Germany, in the Prussian Rhine province, situated at the junction of the Ruhr and the Rhine, in the midst of a productive coal district, 15 m. N. of Düsseldorf and 12 E. of Crefeld by rail. Ruhrort has the largest river harbour in Europe, with quays extending nearly 5 m. along the river, and it is the principal shipping port for the coal of the Westphalian coalfield, which is despatched in the fleet of steam-tugs and barges belonging to the port. The coal is sent principally to South Germany and the Netherlands. Grain and timber are also exported and iron ore is imported. In 1905 the port was entered and cleared by over 27,000 vessels of 7,418,065 tons. The industries of the town include large iron and steel works, ship-building yards and tanneries. Ruhrort has three Evangelical and three Roman Catholic churches, and several schools and public institutions.

Ruhrort is first mentioned in 1379, and obtained civic rights in 1551. Having been in the possession of the counts of La Marck, it passed into that of Brandenburg in 1614. In 1905 it was united with Duisburg and Meiderich to form a single municipality, the joint population being 41,416.

See *Geschichte der Stadt Ruhrort* (Ruhrort, 1882).

RUIZ, JUAN (c. 1283-c. 1350), Spanish poet, was born probably at Alcalá de Henares, and became arch-priest of Hita. Though he draws his physical portrait in the *Libro de buen amor*, he gives no exact biographical details. It may be inferred from his writings that he was not an exemplary priest, and one of the manuscript copies of his poems states that he was imprisoned by order of Gil Albornoz, archbishop of Toledo. It is not known whether he was sentenced for his irregularities of conduct, or on account of his satirical reflections on his ecclesiastical superiors. Nor is it possible to fix the precise date of his imprisonment. Albornoz nominally occupied the see of Toledo from 1337 to 1368, but he fell into disgrace in 1351 and fled to Avignon. A consideration of these circumstances points to the probable conclusion that Ruiz was in prison from 1337 to 1350, but this is conjecture. What seems established is that he finished the *Libro de buen amor* in 1343 while in gaol, and that he was no longer arch-priest of Hita in January 1351; it is assumed that he died shortly before the latter date.

Ruiz is by far the most eminent poet of medieval Spain. His natural gifts were supplemented by his varied culture; he clearly had a considerable knowledge of colloquial (and perhaps of literary) Arabic; his classical reading was apparently not extensive, but he knew by heart the *Disticha* of Dionysius Cato, and admits his indebtedness to Ovid and to the *De Amore* ascribed to Pamphilus; his references to Blanchefleur, to Tristan and to Yseult, indicate an acquaintance with French literature, and he utilizes the *fabliaux* with remarkable deftness; lastly, he adapts fables and apologies from Aesop, from Pedro Alfonso's *Disciplina clericalis*, and from medieval bestiaries. All these heterogeneous materials are fused in the substance of his versified autobiography, into which he intercalates devout songs, parodies of epic or forensic formulae, and lyrical digressions on every aspect of life. Ruiz, in fact, offers a complete picture of picaresque society in Spain during the first half of the 14th century, and his impartial irony lends a deeper tone to his rich colouring. He knows the weaknesses of both clergy and laity, and he dwells with equal complacency on the amorous adventures of great ladies, on the perverse intrigues arranged by demure nuns behind their convent walls, and on the simpler instinctive animalism of country lasses and Moorish dancing-girls. In addition to the faculty of genial observation Ruiz has the gift of creating characters and presenting types of human nature: from his Don Furón is derived

the hungry gentleman in *Lazarillo de Tormes*, in Don Melón and Doña Endrina he anticipates Calisto and Melibea in the *Celestina*, and Celestina herself is developed from Ruiz' *Traconventos*. Moreover, Ruiz was justly proud of his metrical innovations. The *Libro de buen amor* is mainly written in the *cuaderna via* modelled on the French alexandrine, but he imparts to the measure a variety and rapidity previously unknown in Spanish, and he experiments by introducing internal rhymes or by shortening the fourth line into an octosyllabic verse; or he boldly recasts the form of the stanza, extending it to six or seven lines with alternate verses of eight and five syllables. But his technical skill never sinks to triviality. All his writing bears the stamp of a unique personality, and, if he never attempts a sublime flight, he conveys with contagious force his enthusiasm for life under any conditions—in town, country, vagabondage or gaol.

His influence is visible in *El Corbacho*, the work of another jovial gofiard, Alphonso Martinez de Toledo, arch-priest of Talavera, who wrote more than half a century before the *Libro de buen amor* was imitated by the author of the *Celestina*. Ruiz is mentioned with respect by Santillana, and that his reputation extended beyond Spain is proved by the surviving fragments of a Portuguese version of the *Libro de buen amor*. By some strange accident he was neglected, and apparently forgotten, till 1790, when an expurgated edition of his poems was published by Tomás Antonio Sanchez; from that date his fame has steadily increased, and by the unanimous verdict of all competent judges he is now ranked as the greatest Spanish poet of his century.

An accurate edition of his works was published by M. Jean Ducamin at Toulouse in 1901, and he is the subject of Sr. D. Julio Puyol y Alonso's critical study, *El Arcipreste de Hita* (Madrid, 1906).

RUKWA (sometimes also Rikwa and Hukwa), a shallow lake in German East Africa, lying 2650 ft. above the sea in a N.W. continuation of the rift-valley which contains Lake Nyasa. The sides of the valley here run in steep parallel walls 30 to 40 m. apart, from S.E. to N.W., leaving between them a level plain extending from about 7½° to 8½° S. This whole area was probably once covered by the lake, but this has shrunk so that the permanent water occupies only a space of 30 m. by 12 at the S. immediately under the E. escarpment. In the rains it extends some 40 m. farther N., and the north of the plain is likewise then covered with water to a depth of about 4 ft. The rest of the plain is a bare expanse intensely heated by the sun in the dry season, and forming a tract of foul mud near the lake shores. But in 1903-4 the level of the lake rose so that the waters covered the whole depression. The lake has two large feeders, one coming from the W., the other from the S.E. The W. feeder, the Saisi, or Momba, rises in 8° 50' S., 31° 30' E., and traverses a winding valley cut out of the high plateau between lakes Nyasa and Tanganyika. It enters the lake on its N.W. side. The other chief feeder, the Songwe, rises in 9° 8' S., 33° 30' E. on the same plateau as the Saisi and flows N.W., entering Rukwa at its S. end. The Songwe is joined about 50 m. about its mouth by the Rupa, whose head-waters are in the high-lying land N.E. of Rukwa. The maximum depth of the lake is about 10½ ft. Its water is very brackish and of a milky colour from the mud stirred up by the wind. It contains great quantities of fish. First seen from the north by Joseph Thomson in 1880, it was visited by Dr Kaiser, a German, in 1882, and has since been thoroughly explored by various British and German travellers.

See "Begleitworte zu der Karte der Gebiete am südlichen Tanganyika- und Rukwa-See," by Paul Sprigade, in *Mitteil. v. Forsch. u. Gelehrten a. d. deutschen Schutzgebiete* (Berlin, 1904), with map on the scale of 1:500,000.

RULHIÈRE (or RULHIÈRES), **CLAUDE CARLOMAN DE** (1735-1791), French poet and historian, was born at Bondy, near Paris, on the 12th of June 1735. He became aide-de-camp to Marshal Richelieu, whom he followed through the Hanoverian campaign of 1757 and to his government at Bordeaux in 1758; and at twenty-five he was sent to St Petersburg as secretary of legation. Here he actually saw the revolution which seated

Catherine II. on the throne, and thus obtained the facts of *Anecdotes sur la révolution de Russie en 1762*. Catherine made repeated efforts to secure the destruction of the MS, which remained unpublished until after the empress's death. Rulhière became secretary to the comte de Provence (afterwards Louis XVIII.) in 1773, and he was admitted to the Academy in 1787. The later years of his life were spent chiefly in Paris, where he held an appointment in the Foreign Office and went much into society; but he visited Germany and Poland in 1776. His unfinished *Histoire de l'anarchie de Pologne* (4 vols., 1807) was published posthumously under the editorship of P. C. F. Daunou. The only important historical work which he published during his lifetime was his *Eclaircissements historiques sur les causes de la révocation de l'édit de Nantes . . .* (2 vols., 1788), undertaken in view of the restoration to the Protestants of their civil rights. Rulhière died at Bondy on the 30th of January 1791.

His short sketch of the Russian revolution is justly ranked among the masterpieces of the kind in French. Of the larger *Poland* Carlyle, as justly, complains that its allowance of fact is too small in proportion to its bulk. The author was also a fertile writer of *vers de société*, short satires, epigrams, &c., and he had a considerable reputation among the witty and ill-natured group also containing Nicolas Chamfort, Antoine de Rivarol, Louis René de Champenetz, &c. On the other hand he has the credit of caring for J. J. Rousseau in his morose old age, until Rousseau as usual quarrelled with him.

Rulhière's works were edited, with a notice by P. R. Anguis, in 1819 (Paris, 6 vols. 8vo). The *Russian Revolution* may be found in the *Chefs-d'œuvre historiques* of the Collection Didot, and the *Poland*, with title altered to *Révolutions de Pologne*, in the same collection. See also a notice by Eugène Assol prefixed to an edition (1890) of Rulhière's *Anecdotes sur le Maréchal de Richelieu; Sainte-Beuve, Causeries du lundi* (vol. iv.).

RULLUS, PUBLIUS SERVIUS, Roman tribune of the people in 64 B.C., well known as the proposer of one of the most far-reaching agrarian laws brought forward in Roman history. This law provided for the establishment of a commission of ten, empowered to purchase land in Italy for distribution amongst the poorer citizens and for the foundation of colonies. Its professed object was to clear Rome of the large number of pauper citizens, who formed a standing menace to peace. The members of the commission were to be invested with powers so extensive that Cicero spoke of them as ten "kings." They were to be elected for five years by seventeen of the tribes chosen by lot from the thirty-five; the imperium was to be conferred upon them by the *lex curiata*, together with judicial powers and the rank of praetor. Only those were eligible who personally gave in their names, a clause obviously intended to exclude Pompey, who was at the time absent in the East. In fact, the commission as a whole was intended to act as a counterpoise to his power. The only land available for the purposes of the bill was the Ager Campanus and the Ager Stellatis, where 5000 citizens were to be settled at once, but as these were utterly insufficient, other lands were to be acquired by purchase. The necessary money was to be found by the sale of all the public property in Italy which had been ordered to be sold by resolutions of the senate (in 81, or subsequently), but which the fear of unpopularity had deterred the consuls from selling; by the sale of lands, &c., in the provinces which had become public property since 88, and even of the domains acquired during the Mithradatic war. A special article, the object of which was to pacify those who had received grants of land from Sulla, declared such possessions to be private property, for which compensation was to be paid in case of surrender. The revenues of the provinces which were now being organized by Pompey, and the booty and money taken or received by generals during war were also to be applied to this purpose. The places to which colonies were to be sent were not specified (with the exception mentioned above), so that the commissioners would be able to sell wherever they pleased, and it was left to them to decide what was public or private property.

Cicero delivered four speeches against the bill, of which three are still extant, although the first is mutilated at the beginning. The second is the most important for the history of the bill; nothing is known of the fourth. Very little enthusiasm was shown in the matter by the people, who preferred the distribution of doles in the city to the prospect of distant allotments. One of the tribunes even threatened to put his veto on the bill, which was withdrawn before the voting took place. The whole affair was obviously a political move, probably engineered by Caesar, his object being to make the democratic leaders the rulers of the state. Although Caesar could hardly have expected the bill to pass, the aristocratic party would be saddled with the odium of rejecting a popular measure, and the people themselves would be more ready to welcome a proposal by Caesar himself, an expectation fulfilled by the passing of the *lex Julia* in 50, whereby Caesar at least partly succeeded where Rullus had failed.

See the orations of Cicero *De lege agraria*, with the introduction of G. Long's edition, and the same author's *Decline of the Roman Republic*, iii. p. 241; Mommsen, *Hist. of Rome*, bk. v. ch. 5; art. AGRARIAN LAWS.

RUM, or **ROUM** (Arab. *ar-Rûm*), a very indefinite term in use among Mahomedans at different dates for Europeans generally and for the Byzantine empire in particular; at one time even for the Seljuk empire in Asia Minor, and now for Greeks inhabiting Ottoman territory. When the Arabs met the Byzantine Greeks, these called themselves *Ῥωμαῖοι*, or Romans, a reminiscence of the Roman conquest and of the founding of the new Rome at Byzantium. The Arabs, therefore, called them "the Rûm" as a race-name (already in Kor. xxx. 1), their territory "the land of the Rûm," and the Mediterranean "the Sea of the Rûm." The original ancient Greeks they called "Yûnân" (Ionians), the ancient Romans, "Rûm" and sometimes "Latînyûn" (Latins). Later, inasmuch as Muslim contact with the Byzantine Greeks was in Asia Minor, the term Rûm became fixed there geographically and remained even after the conquest by the Seljuk Turks, so that their territory was called the land of the Seljuks of Rûm. But as the Mediterranean was "the Sea of the Rûm," so all peoples on its N. coast were called sweepingly, "the Rûm." In Spain any Christian slave-girl who had embraced Islâm was named Rûmîya, and we find the crew of a Genoese vessel being called Romans by a Muslim traveller. The crusades introduced the Franks (*Ifranja*), and later Arabic writers recognize them and their civilization on the N. shore of the Mediterranean W. from Rome; so Ibn Khaldûn in the latter part of the 14th century. But Rûmî is still used in Morocco for a Christian or European in general, instead of the now elsewhere commoner *Ifranji*. (D. B. MA.)

RUM (according to Skeat, a corruption of Malay *brum* or *bram*; the adjective "rum," i.e. "queer," being a distinct word, in Gipsy *rom*), a potable spirit distilled chiefly from fermented cane-sugar. It is mainly the produce of the West Indian Islands, notably Jamaica, and of Demerara. There are two kinds of Jamaica rum, namely, "common" or "clean" rum, and "flavoured" or "German" rum. The latter is used almost entirely for purposes of blending with lighter types of spirit. Compared with other potable spirits such as whisky and brandy, the Jamaica rums are distinguished by their very high proportion of secondary products, particularly of the compound esters. Among the latter butyric "ether" (ethyl butyrate) predominates. The Demerara rums are of a lighter character. Rum has a deep brown colour imparted by caramel or by storage in sherry casks, or, most generally, by both. "Tafia" is an inferior quality of rum produced in the French colonies. "Negro" rum, which is the lowest quality of all, and into the wash for which the *débris* of the sugar-cane enters, is consumed locally by the coloured workers. The spirit prepared from beet-sugar molasses cannot be regarded as rum, for, unless it is highly rectified, it possesses a disagreeable odour and taste. Fictitious rum is, however, sometimes prepared from highly rectified beet spirit and rum "essence"—a mixture of artificial esters (ethyl butyrate, &c.), birch bark oil and so on. Highly rectified

beet spirit is also occasionally used for blending with genuine rum, particularly with the "flavoured" or "German" rum. The latter name originated in the fact that this kind of rum was exported very largely to Germany for the purpose of blending. The general composition of various kinds of rum is manifest from the annexed table. The consumption of rum in the United Kingdom has fallen off considerably of late years, concurrently with the general tendency of the public towards lighter and "drier" alcoholic beverages (see SPIRITS).

COMPOSITION OF DIFFERENT VARIETIES OF RUM

(Analyses by W. Collingwood Williams; cf. *J. Soc. Chem. Ind.* 1907, p. 498.)

Description.	Alcohol per cent by vol.	Total Acid.	Volatile Acid.	Esters.	Higher Alcohols.	Fur-fural.	Aldehydes.
1. Jamaica Rums—							
A. "Common Class"							
Average	70.1	78.5	61	366.5	08.5	4.5	15.3
Maximum	82.1	155	146	1058	150	11.5	30.0
Minimum	68.6	30	21	88	46	1.0	5.0
B. "Flavoured"							
Average	77.3	102.5	95.5	768.5	107	5.2	20.7
Maximum	80.0	145	137	1204	144	12.0	37.5
Minimum	66.1	45	30	167	80	2.7	13.0
2. Demerara Rums		71.30	112.8	430.9	66	0.6	2.7

RUMANIA, or **ROUMANIA** [*România*], a kingdom of south-eastern Europe, situated to the north-east of the Balkan Peninsula,¹ and on the Black Sea. Pop. (1010, estimate) 6,850,000; area, about 50,720 sq. m., or about 6500 sq. m. less than the combined areas of England and Wales. Rumania begins on the seaward side with a band of territory called the Dobrujda (*q.v.*); and broadens westward into the form of a blunted crescent, its northern horn being called Moldavia, its southern Walachia.

Physical Features.—Along the inner edge of this crescent run the Carpathian Mountains, also called, towards their western extremity, the Transylvanian Mountains (q.v.) or Transylvanian Alps; and the frontier which marks off Rumania from Hungary is drawn along their crests. The eastern boundary is formed by the river Pruthi (*Prutis*), between Moldavia and Russia; farther south by the Kilia mouth of the Danube (*Dunarea*), between the Dobrujda and Russia, and by the Black Sea. In the extreme south-east, an irregular line, traced from Ianiâc, 10 m. S. of Mangalia, on the coast, as far as the Danube at Siliâtria, 85 m. inland, separates the Dobrujda from Bulgaria. Otherwise, the Danube constitutes the whole southern frontier; its right bank being Bulgarian for 290 m., and Servian, in the extreme west, for 50 m. The Danube (q.v.) enters Rumania through the Vercoiora or Kazan ² Pass. It here resembles a long lake, overshadowed by precipitous mountains, which vary from 1000 to 2000 ft. in height, and are covered by birches and pines. In this neighbourhood the channel contracts to about 116 yds. in width, with a depth of 30 fathoms. At the eastern end of the pass are the celebrated Iron Gates, a rapid so named by the Turks, not from the surrounding heights, which here descend gradually to the river, but from the number of submerged rocks in the waterway. As it flows eastward from the frontier, the Danube gains in breadth and volume. Islands are frequent; the banks recede and become lower until, at 50 m., they stand almost level with the water. Henceforward, for 290 m., the Rumanian shore is a desolate fen-country, varied only by a few hills, by cities, and by lagoons often 15 m. long. East of Bucharest, a chain of lagoons and partially drained marshes stretches inland for 45 m. At Siliâtria the river bends N.N.E. for 110 m. with the Dobrujda on its right, and a barren plain, called the Baragan Steppe, on its left. It here encloses two large swampy islands, the upper being 57 m., the lower 43 m. long. Both have an average breadth of 10 m. Beyond Galatz, the river again turns eastward, branching out, near Tulcea, into three great waterways, which wind through out a low-lying alluvial delta to the sea. The northern estuary is named the Kilia Mouth; the central, the Sulina; the southern, the St George's. Between Vercoiora and the Sulina Mouth, the Danube traverses 540 m. Its current is rapid, and supplies the motive

¹ In 1904, in a lecture read before the Rumanian Geographical Society, M. A. Sturdza showed that Rumania should not be included in the Balkan Peninsula, where it is placed by many writers and cartographers. This view was accepted by the Society, and a copy of the lecture was forwarded to all similar associations in Europe. See A. Sturdza, *La Roumanie n'appartient pas à la péninsule balkanique* (Bucharest, 1904).

² I.e. Cauldron.

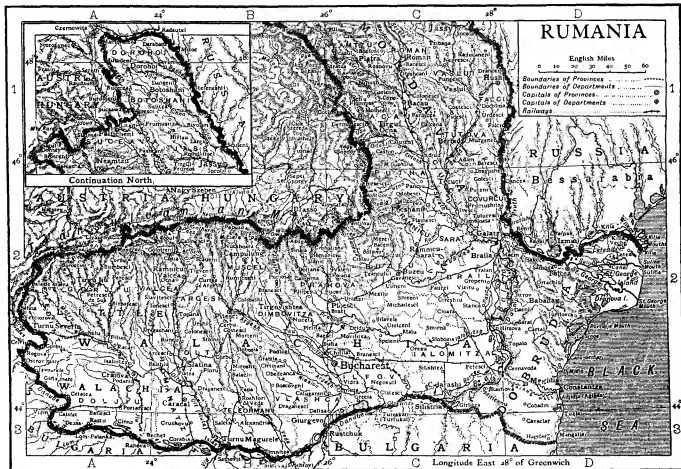

power for thousands of floating watermills, which lie moored in the shallows. It is fed by many tributaries, which rise in the Carpathians as mountain torrents, growing broad and sluggish as they flow south-eastward through the central Rumanian plain. In Walachia, it is joined by the Jiu (or Sychl) opposite Rahova; by the Olt (ancient Aluta) at Turnu Magurele; by the united streams of the Dimbovitza (*Dambowitza*) and Arghesh (*Arges*) at Oltenitza; by the Jalomitza (*Jalomitza*) opposite Hirsowa. The Olt pierces the Carpathians, by way of the Rothenthurm Pass, and forms the boundary of Little (i.e. western) Walachia, or Oltland. The Sereth (*Siretu* or *Sereu*) flows for about 340 m. from its Transylvanian source through Moldavia, and meets the Danube near Galatz, after receiving the Moldova, Bistritza (*Bistritza*), Trotosh (*Trotosh*), Milcovi, Putna, Râmnicu and Buzeu on the west; and the Bérilad (*Bérilad*) on the east. The Milcovî was the former boundary between Walachia and Moldavia. The Pruth rises on the northern limit of Moldavia, forms the eastern frontier for 330 m., and falls into the Danube 10 m. E. of Galatz. Its chief Rumanian tributaries are the Basheu (*Basheu*) and Jijia, rivers of the north. The Dobrudja (g.v.) or Dobrogea covers about 2900 sq. m. between the Black Sea and the lower reaches of the Danube. Its high crystalline rocks, covered with sedimentary formations, descend abruptly towards the delta, but more gradually towards the south, where the Bulgarian steppes encroach upon Rumanian soil. The few small rivers which drain the hills generally flow seaward, but those of the delta and steppes belong to the Danubian system. The coast is a low-lying region of sandhills, meres and marshes with one lagoon, 42 m. long, connected by a short stream with the St George Mouth. Its outlet on the sea is named the Portidje Mouth (*Gura portidjei*) of the Danube. North of this, the lagoon is called Lake Kazim; while its southern half, shut off by three long islands, is the Blue Lake (*Sînoe Oséro*, in Bulgarian).

Apart from the Dobrudja, the whole of Rumania is included in the northern basin of the lower Danube. It consists of a single inclined plane stretching upwards, with a north-westerly direction, from the left bank of the river to the summits of the Carpathians. It is divided into three zones—steppe, forest and alpine. The first begins beyond the mud-flats and reed-beds which line the water's edge, and is a vast monotonous lowland, sloping so gently as to seem almost level. The surface is a yellow clay, with patches of brown or dark grey, outliers of the Russian "black earth." Cereals, chiefly maize, with green crops and fields of gourds, alternate with fallow land overgrown with coarse grasses, weeds and stunted shrubs. Among

the scanty trees, willows and poplars are commonest. The second zone extends over the foothills and lower ridges of the Carpathians. This region, called by Rumanians "the district of vines," is the most fertile portion of the country. In it grow most fruits and flowers which thrive in a temperate climate. Oaks, elms, firs, ashes and beeches are the principal forest trees. The third zone covers the higher mountains on their southern and eastern sides, whose violently contorted strata leave many transverse valleys, though usually inclining laterally towards the south-east. The birch and larch woods of this zone give way to pine forests as the altitude increases; and the pines to mosses, lichens and alpine plants, just below the jagged iron-grey peaks, many of which attain altitudes of 6000 to 8000 ft.

Geology.—The axis of the Transylvanian Alps consists of sericite schists and other similar rocks; and these are followed on the south by Jurassic, Cretaceous and Early Tertiary beds. The Jurassic and Cretaceous beds are ordinary marine sediments, but from the Cenomanian to the Oligocene the deposits are of the peculiar facies known in the Alps and Carpathians as Flysch. Farther north, the Flysch forms practically the whole of the Rumanian flank of the Carpathians. Along the foot of the Carpathians lies a broad trough of Miocene salt-bearing beds, and in this trough the strata are sometimes horizontal and sometimes strongly folded. Outside the band of Miocene beds the Sarmanian, Pontian and Levantine series, often concealed by Quaternary deposits, cover the great part of the Danube plain. Even the Pontian beds are sometimes folded. In the Dobrudja crystalline rocks, presumably of ancient date, rise through the Tertiary and recent deposits and form the hills which lie between the Danube and the Black Sea.¹

Climate.—The Rumanian climate alternates between extreme cold in winter, when the thermometer may fall to -20° Fahrenheit and extreme heat in summer, when it may rise to 100° in the shade. Autumn is the mildest season; spring lasts only for a few weeks. Spring at Bucharest has a mean temperature of 53° ; summer,

¹ See L. Teisseyre and L. Mrazec, *Aperçu géologique sur les formations salifères et les gisements de sel en Roumanie*, *Moniteur des intérêts pétroliers roumains* (1902), pp. 3-51; S. Stefanescu, *Étude sur les terrains tertiaires de Roumanie* (1897); J. Bergeron, "Observations relatives à la structure de la haute vallée de la Jalomitza (Roumanie) et des Carpathes roumaines," *Bull. Soc. Géol. France*, ser. 4, vol. iv. (1904), pp. 54-77.

72°5'; autumn, 65°; winter, 27°5'. For about 155 days in each year, Rumania suffers from the bitter north-east wind (*crivels*) which sweeps over south Russia; while a scorching west or south-west wind (*austră*) blows for about 126 days. Little snow falls in the plains, but among the mountains it may lie for five months. The frosts are severe, the Danube being often icebound for three months. The rainfall, which is heaviest in summer, averages about 15-20 in.

Fauna.—In its fauna, Walachia has far more affinity to the lands lying south of the Danube than to Transylvania, although several species of *Claudilia*, once regarded as exclusively Transylvanian, are found south of the Carpathians. Moldavia and the Baragan Steppe resemble the Russian prairies in their variety of molluscs and the lower kinds of mammals. Over 40 species of freshwater mussels (Unionidae) have been observed in the Rumanian rivers. The lakes of the Dobruja likewise abound in molluscs; parent forms, in many cases, of species which reappear, greatly modified, in the Black Sea. Insect life is somewhat less remarkable; but besides a distinctive genus of Orthoptera (*Jagotia Hostipera*), there are several kinds of beetles (Curculionidae) said to be peculiar to Rumania. Birds are very numerous, including no fewer than 4 varieties of crows, 5 of warblers, 7 of woodpeckers, 8 of buntings, 4 of falcons, and 5 of eagles; while among the hosts of waterfowl which people the marshes of the Danube are 9 varieties of ducks, and 4 of rails. Roe-deer, foxes and wolves find shelter in the forests, where bears are not uncommon; and chamois frequent the loftiest and most inaccessible peaks.

Minerals.—The mineral wealth of Rumania lies chiefly in the mountains. Petroleum, salt, lignite and brown coal are largely worked. Deposits of rock-salt, of value to government monopolists, stretch from the department of Suceava in northern Moldavia to that of Gorjui in Walachia, and are mined in the departments of Bacau, Prahova and Râmnicul Sărat. The presence of petroleum, indicated by many ancient workings in the shape of shallow hand-dug wells, can be traced continuously at the foot of the Transylvanian Alps, from Turnu Severin into Bukovina. Rumanians claim for their product a higher percentage of pure oil than is found in the American, Galician and Caucasian wells; and, although American competition nearly destroyed this industry between 1873 and 1895, improved methods and legislation favouring the introduction of foreign capital enabled it to recover. At the beginning of the 20th century, the Rumanian petroleum deposits were among the most important in the world. The industry is carried on by private producers as well as by the state, the American Standard Oil Company being largely interested. The total output, coming chiefly from the departments of Bacau, Buzeu, Dimbovitza and Prahova, was 250,000 metric tons in 1900, 615,000 in 1905, and 1,300,000 in 1909. Associated with petroleum is ozokerite, converted by the peasantry into candles. Lignite is used as fuel on the railways. The chief anthracite beds, those in the Gorjui department, are leased until 1974 to an English capitalist, who has the right to construct railways. Extensive coalfields exist in the Dobruja, and the Dimbovitza, Mehedinți, Muscel, Prahova and Vâlcea departments. Iron, copper, lead, mercury, cinnabar, cobalt, nickel, sulphur, arsenic and china clay also occur. Among the mountains, gold was perhaps worked under Trajan; who first appointed a *Procurator Metallorum*, or overseer of mines, for Dacia; certainly in the 14th century, when immigrant Saxon miners established a considerable trade with Ragusa, in Dalmatia. Under the Turks, gold-washing was carried on by gipsy slaves, but it has long been abandoned as unprofitable. Until 1896 building materials were chiefly imported; but after that year many quarries were opened to develop the native resources of limestone, sandstone, serpentine, red, yellow and green granite, and marbles of all colours, including the white marble from Dorna in Suceava, said by Rumanians to rival that of Carrara in Italy. Clear amber is found beside the Buzeu and its affluents, with brown and grey clouded amber, and a blue fluorescent variety, of considerable value.

Rumania has long been noted for its mineral springs. Ruins of a Roman bath exist near Curtea de Argesh. In the Vâlcea department, besides many other iodine, sulphur and mud baths, which are situated upon the Danube, are the famous sulphur springs and Govora, the state-supported spas of the finest Carpathian scenery. Most famous of all is Sinaia (*s.n.*), the summer residence of the Court; while important springs exist at Lake Sarat, near Braila; at Slanic, in the Prahova department, where flooded and abandoned salt-mines are fitted up as baths; at the Tekir Ghiol mere, near Constantza; and at Baltazesti (*Balțetești*), in the Neamtzu (*Neamțu*) department, a favourite resort of invalids from many parts of eastern Europe.

Agriculture.—That, in 1900, Rumania ranked third, after the United States and Russia, among the grain-growing countries of the world, is due partly to the fertile soil, whose chemical constituents are the same as in the "black earth" region of Russia, though even

richer in nitrates; partly also to the improved methods and appliances introduced in the last quarter of the 19th century. The frail wooden ploughs with a lance-headed share that only scratched the surface soil, were then superseded by iron ploughs; steam threshers replaced the oxen which trod out the corn, and modern implements were widely adopted. Vast harvests of wheat and maize ripen on the plains and lower hills. Apart from cereals, the principal crops are beans, potatoes, beetroot and tobacco. Among the wine-producing countries of Europe, Rumania stood fifth in 1900, despite the ravages of *phylloxera*, old-fashioned culture, lack of storage and other drawbacks. The red wines of Moldavia, especially the brand known as *Piscul Cerbului*, resemble Bordeaux. The best white wines came from Cotnar in the Jassy department, but here *phylloxera* ruined the vineyards. Golden Cotnar was akin to Tokay. To combat the *phylloxera*, the government ordered the destruction of all infected vines, distributed immune American stocks and established schools of viticulture. On the upland fruit farms, although apples, pears, medlars, cherries, plums, peaches, apricots and quinces thrive, the chief attention is given to damsons, from which is extracted a mild spirit (*tsuica*), highly esteemed throughout Rumania. This industry began to decline after 1860, but revived with the establishment of government schools of fruit-culture in many villages. Further instruction was given at various horticultural institutes in the towns, notably the Botanic Gardens and Institute of Bucharest, where the experiments in planting figs, almonds, hops and cotton yielded favourable results. Tobacco is largely cultivated, under state supervision.

There are three breeds of Rumanian oxen, besides the peculiar black buffaloes, with horns lying almost flat along their necks. Cattle are cleared near the railways and the mountain farms, successfully in the meat-markets of Austria, Germany and Holland. The southern Dobruja and the Baragan Steppe, with the mountain pastures of Argeh, Buzeu, Dimbovitza, Muscel and Prahova, are occupied by large sheep-runs; 1200 farms were created in the Baragan by the Land Act of 1889. In winter the flocks are driven from the highlands to the plains. Cheeses of ewe's milk, packed in sheepskins or bark, are in great demand. Swine and pork are largely exported to Russia and Austria-Hungary. Besides the Moldavian and Servian breeds, thousands of so-called "swamp" and "rural" piglets are reared on the islands of the Danube. Silk-worm-rearing is an important agricultural industry, but has almost abandoned, when, in 1891, the government established mulberry nurseries, and distributed silkworms free of charge. Silk-worm-rearing is taught in the monasteries and agricultural schools, especially in the College of Agriculture and Sylviculture, at Ferestru, near Bucharest. Similar measures were adopted to check the decline of bee-keeping, and a model apiary was founded in 1890, under government control.

Forests.—The forests of Rumania were long either neglected or exploited in the most reckless fashion. Large tracts of woodland were cleared near the railways and the mountain farms, for grazing and gathering firewood destroyed the aftergrowth. Nevertheless, in 1910 there were 2,760,000 acres under forests, chiefly in the mountains of north-western Moldavia. More than 1,000,000 acres are state property. Under King Charles, an ardent forester, the wholesale destruction of timber was arrested, and new plantations met with success. Lumber is floated down the rivers of the Carpathian watershed to the Danube, and so exported to Turkey and Bulgaria; casks, shaped planks and petroleum drums go chiefly to Austria and Russia. Wood-carving is taught in many schools, and a special school of forestry exists at Branesi in the Ilfov department.

Estates in the hands of the nobles are liable to state control, under the Forests Act of 1886.

Land Tenure.—The Rumanian system of land tenure dates from 1864, when most of the land was held in large estates, owned privately, or by the state or by monasteries. There was also a small class of peasant proprietors, called *mocheneni* in Walachia, *reșchii* in Moldavia, living and working in family communities; but the great mass of the peasantry cultivated the lands of the large proprietors, giving a certain number of days' work to their manorial lord, in addition to a tithe of the raw produce. They received in return a portion of the manorial property, the number of animals they owned, and had also rights of grazing and of collecting fuel in the forests. In 1864, under the government of Prince Cuza, a new law was promulgated, conferring on each peasant family freehold property in lots varying from 7½ to 15 acres, according to the number of oxen that they owned. The man with no cattle received the minimum; the owner of 2 oxen got 10 acres, and the possessor of 4 received 12½ to 15 acres. The price of the land, which was calculated on the basis of the value of the forced labour to which the landlord had been entitled, was about £1, 16s. per acre, paid to the landlord by the state as compensation, and subsequently recovered from the peasants in fifteen annual instalments. In the first distribution, which took place almost immediately after the law was passed, 280,000 families in Walachia and about 127,000 in Moldavia became freeholders, holding nearly 4 million acres or one-third of the cultivated area of the country. These peasant plots were all declared inalienable for thirty years. The law of emancipation, although passed with the best of motives, did not to any great

¹The relative importance of Rumania was afterwards lessened by the development of wheat-culture in Canada, Argentina and elsewhere.

extent benefit the peasantry. The limited size of their farms, and the necessity for buying wood and paying for pasturage, both of which were formerly free, prevented them from obtaining complete independence of the large proprietors, on whose estates they still had to work for payment in money or kind, while their improvidence soon got them into the hands of Jewish money-lenders, who, fortunately for the peasants, were by law unable to become proprietors of the soil. In 1866 and 1872 laws were passed for still further improving the position of these small proprietors; and in 1879 a measure was carried for allotting lands to 48,000 recently married couples, and for restoring to many peasant families lands which had been alienated.

By the Land Act of 1889, the state domains, amounting to nearly one-third of the total area of Rumania (originally the property of the church and the convents, confiscated by Prince Cuza in 1866), were distributed among the peasantry. The land was divided into lots of 12½, 25 and 37½ acres. Peasants having no land might purchase the smaller lots on very easy terms. Those who already held less than 1½ acres might purchase up to that amount. When a change of residence became necessary to enable the peasant to take up the new allotment, the state advanced £6 to each family to defray expenses. The price to be paid for the land differed in different districts, and was to be paid to the state in small annual instalments. If any land remained after satisfying the wants of the peasants, it was to be sold by public auction in lots of 50 to 62½ acres. All lots in both cases were declared inalienable for thirty years. The sale of the larger lots gave rise to so many abuses that in 1896 a law was passed abolishing their further sale. As a result of these measures the majority of Rumanians are peasant proprietors; but the smallness of the holdings renders scientific farming difficult except by co-operation, and many proprietors can only live by working for the owners of large estates. Thus, though the average value of agricultural land increased by 60% between 1870 and 1900, the position of the peasantry is far from satisfactory, and the resultant discontent was the chief cause of the agrarian rising in 1907.

Fisheries.—Among European freshwater fishing-grounds, the Danube is only surpassed by the Volga; the most valuable fish being sturgeon and sterlet, mostly netted in the St George mouth; carp, often weighing 50 lb; pike, perch, tench and eels. By an act of 1895, the closing of the fisheries to the landowners, and the fisheries, which are either farmed by private companies or directly administered, were set in order. The coarse-grained grey Rumanian caviare is forwarded to Berlin, and there blended with Russian caviare. Flounders and mullet are caught in the Black Sea, and there are oyster-beds in the delta and on the Dobruja littoral. The principal markets for Rumanian fish are Turkey, Russia and Austria-Hungary. Fish of inferior quality is imported, chiefly from Russia.

Manufactures and Commerce.—The native mines, fields and forests provide raw material for most of the few factories which exist. These include petroleum refineries, iron foundries, distilleries, flour mills, sugar refineries, sawmills, paper mills, chemical works, glass works, soap and candle works, &c. A law passed in 1887 provided that any one undertaking to found an industrial establishment with a capital of at least £2000, or employing at least 25 workmen (of whom two-thirds should be Rumanians), should be granted 12 acres of state land, exemption for a term of years from all direct taxes, freedom from customs dues for machinery and raw material imported, exemption from road taxes, reduction in cost of carriage of materials on the state railways, and preferential rights to the supply of important articles to the state.

The following table shows the value of Rumanian imports and exports for five years:—

Year.	Imports.	Exports.
1904	£12,455,000	£10,475,000
1905	13,510,000	18,284,000
1906	16,885,000	19,654,000
1907	17,220,000	22,157,000
1908	16,563,000	15,158,000

The principal imports are metals and machinery (£15,510,000 in 1908), textiles, silk, wool, hair and hides. Grain (£11,297,000 in 1908), petroleum (£1,543,000) and timber (£1,099,000) are by far the most important exports; the remainder consisting of live-stock, animal products, fruit, vegetables and mineral waters. In 1908 the chief consumers of Rumanian goods were (in order) Belgium, Great Britain and Italy; the chief exporters to Rumania were Germany, Austria-Hungary, Great Britain and France. The wide fluctuations in Rumanian commerce are largely due to the dependence of the country on the grain harvest.

Finance.—The state revenue is derived from customs; from public works and public land; from indirect taxes in the shape of stamp, inheritance, beer, spirit, petroleum and other duties; from direct taxes on land and buildings, with road-tolls, licences for the sale of alcoholic liquors, registration fees; from the tobacco, salt, match, playing-card and cigarette-paper monopolies; and from the postal, telegraphic and telephonic services. The chief items of expenditure are interest on the national debt, and the cost of defence, public works and education.

The following table shows the estimated revenue and expenditure for five years:—

Year.	Revenue.	Expenditure.
1906-7	£9,557,000	£9,509,000
1907-8	10,099,000	9,977,000
1908-9	16,440,000	16,202,000
1909-10	17,427,000	17,146,000
1910-11	18,443,000	18,443,000

The great increase after 1907-8 is due to the inclusion of railway receipts and expenditure, with some other items not previously enumerated.

In May 1905 the outstanding public debt, which amounted to about £54,000,000, mainly placed in Germany and bearing interest at an average rate of 5%, was converted into a uniform 4% stock. Besides this reduction of interest, the state secured an extension of fourteen years in each of the various periods allotted for repayment of the component loans. But a considerable increase in the total debt was involved, because a bonus of 10½% in new 4% stock, issued at par, was offered to induce bondholders to convert a whole, to cover the bonus, an additional 4% loan was raised at 90-70, amounting to £4,000,000, redeemable in 1941. At the beginning of the fiscal year 1909-10 (March 31st, O.S.) the total outstanding debt was £58,367,000, and the debt charges for the year were estimated at £3,517,080.

Banks and Currency.—Apart from the General Bank of Rumania (capital £200,000), which is owned by a syndicate mainly of Germans, the largest credit establishments belong to the state. They include the National Bank (capital and reserves in 1910, £1,560,000), founded in 1880; the Agricultural Loan Bank, founded in 1894; the Rural and Urban Land Credit Institutes, which lend money on agricultural and rural lands respectively; the Credit Societies, Rurals, which buy and sell real estate in small lots; savings banks at the principal towns; and the Deposit and Trust Fund, which takes charge of estates left vacant through intestacy, surplus departmental and communal funds, securities given by contractors for public works, &c.

After the Crimean War, a bimetallic currency was adopted, with the *leu* (franc) of 100 *bani* (centimes) as the unit of value. But after 1878 the Russian silver rouble was rated so highly as to drive the native coins out of circulation; and in 1889 Rumania joined the Latin Monetary Union and adopted a gold standard. Besides the silver pieces worth 1, 2 and 5 *leu*, gold coins of 5, 10 and 20 *leu* are used. Silver is legal tender only up to 50 *leu*. All taxes and customs dues must be paid in gold, and, owing to the small quantities issued from the Rumanian mint, foreign gold is current, especially French 20-franc pieces (equal at par to 20 *leu*), Turkish gold *lire* (22-70), Old Russian Imperials (20-60) and English sovereigns of (25-22). Besides bronze coins of less value than ½ *leu*, nickel pieces worth 5, 10 and 20 *bani* were authorized by a law of 1900. The French decimal system is in use for weights and measures, together with Turkish standards. On the railways and in post offices the Gregorian calendar is employed; elsewhere the Julian system is used.

Chief Towns.—The chief towns, with their estimated population in 1910, are Bucharest, the capital (300,000); Jassy, the capital of Moldavia (80,000); Galatz (66,000), Braila (60,000), Ploesti (50,000), Craiova (46,000), Botoshani (34,000), Bérland (25,000), Peshani (25,000), Tulcea (20,000). Constantza (16,000), Giurgevo (15,000). Other towns which, like the foregoing, are described in separate articles are Alexandria, Babadag, Bacau, Buzeu, Calafat, Calarasi, Câmpulung, Caracal, Curtea de Argesh, Dorohoi, Dragashani, Falticeni, Hushi, Mangalia, Neamtzu, Oltenitza, Piatra, Pitesti, Râmnic, Râmnicu Vâlcea, Roman, Sinaia, Sulina, Tirgu Jiu, Tirgu Ocni, Urzicoviste, Tecuci, Turmu Magurele, Turmu Severin and Vaslui.

Communications.—Until the 19th century, traffic was carried on in Rumania chiefly by means of ox-wagons, over the roughest of roads. After 1830, however, many highways were opened, these being usually excellent among the mountains but deteriorating as they descend into the lowlands, where stone is dear. Highways are maintained by the state, department or commune, according to their size and importance. In 1869, the first Rumanian railway was opened, between Bucharest and Giurgevo, its port. Other lines followed rapidly; some built by private enterprise, others by the state, which by 1888 had bought the entire system. The centres in one main line, carried southwards from Sucezava in Bukovina through the whole length of Moldavia, and turning westwards through Walachia to meet the Hungarian frontier at Vercoiora. Branch lines extend, on one side, up the lateral valleys of the Carpathians, and, on the other, to Jassy and the principal Danubian ports. A direct line connects Jassy with Galatz; another traverses the Dobruja from Constantza to Cernavoda, where it crosses the Danube and proceeds north-west to join the main line. The double bridge of Cernavoda, with the viaducts leading to it, stretches for 12½ m. across the river and surrounding marshes. The junctions at Sucezava and Vercoiora, where the Rumanian system meets the Hungarian through the Gyimes, Rothenthurm and Vulkan Passes; the Russian by lines from Jassy and Galatz to Kishinev in Bessarabia; the Bulgarian and Servian by means of numerous

ferries. Rumania has no canals, and the canalization of its rivers is impeded by drought and floods. The Pruth and Sereth are navigable for a short distance by small sailing craft; the conservancy of the Danube (*g.v.*) is controlled by a European commission, which sits at Galatz. Besides river services, the state maintains lines of sea-going ships from Constantza to Constantinople and the Aegean islands, and from Braila to Rotterdam. In 1908 the ports of Rumania were entered by 32,888 vessels of 9,269,000 tons, of which 30,504 of 6,529,000 tons belonged to the river (Danubian) trade. The merchant navy of Rumania comprised about 495 vessels of 145,000 tons, including 88 steamers.

Population.—The population of Rumania numbered 5,912,520 in 1899, and about 6,850,000 in 1910. Fully 6,000,000 of these were Rumans or Vlachs (*g.v.*). The population of foreign descent comprises many Jews, Armenians, gipsies, Greeks, Germans, Turks, Tatars and Magyars, Servians and Bulgarians. The Jews increase more rapidly than any of these peoples except the Armenians. They usually congregate in the larger towns, though in northern Moldavia there are a few purely Jewish villages, recalling those of Poland.

The bitter feeling against them in Rumania is not so much due to religious fanaticism as to the fear that if given political and other rights they will gradually possess themselves of the whole soil. In many towns in northern Moldavia the Jews are in a majority, and their total numbers in Rumania are about 300,000, *i.e.* about one-twentieth of the entire population, a larger ratio than exists in any other country in the world. In many places they have the monopoly of the wine and spirit shops, and retail trade generally; and as they are always willing to advance money on usury, and are more intelligent and better educated than the ordinary peasant, there is little doubt that in a country where the large landowners are proverbially extravagant, and the peasant proprietors needy, the soil would soon fall into the hands of the Jews were it not for the stringent laws which prevent them from owning land outside the towns. When in addition it is considered that the Moldavian Jews, who are mostly of Polish and Russian origin, speak a foreign language, wear a distinguishing dress and keep themselves aloof from their neighbours, the antipathy in which they are held by the Rumanians generally may be understood.

The gipsies, who are mostly converts to the Orthodox Church, still, as a rule, cling to their vagabond existence, though their skill at all handicrafts finds them ready employment in the towns. During their centuries of slavery, they were organized into castes, as musicians, metal workers, masons, &c.; but after about 1850 the bonds of caste were gradually relaxed and gipsies began to intermarry with Rumans. The Greeks form a floating population of merchants and small traders, anxious to amass a fortune and return home. German and Austrian business men visit the country in large numbers, and colonies of German farmers flourish among the mountains of Little Walachia. In central Moldavia there is a large population of Magyar descent, and the Servian and Bulgarian elements are strong near the Danube. The interior of the Dobruddja is occupied largely by Turks and Bulgarians, with Tatars, Russians and Armenians, but here the Ruman steadily gains ground at the expense of the alien. At Megidia, a flourishing town of about 10,000 inhabitants, which sprang up after 1860 between Cernavoda and Constantza, the Tatars predominate. Russians of the Lipovan sect live in exile in Bucharest and other cities, earning a livelihood as cab-drivers, and wearing the long coats and round caps of their countrymen.

National Characteristics.—Two dissimilar types are noticeable among the Rumans. One is fair-haired, florid and blue-eyed; the other, more frequent among the Carpathians, is dark, resembling the southern Italians. Both alike are hardy, though rarely tall; both, when of the peasant class, frugal and inured to toil amid the rigours of their native climate. Proud of their race and country, they acquired, with their independence, an ardent sense of nationality; and they look forward to the day which will reunite them to their kinsmen in Transylvania and Bessarabia. They have been taught, originally in the interests of Transylvanian Roman Catholicism,

to regard themselves as true descendants of the Romans. The peasants retain their distinctive dress, long discarded, except on festivals and at court, by the wealthier classes. Men wear a long linen tunic, leather belt, white woollen trousers and leather gaiters, above Turkish slippers or sandals. The lowlanders' head-dress is generally a high cylindrical cap of rough cloth or felt, while the mountaineers prefer a small round straw hat. Sundays and holidays bring out a sleeveless jacket, embroidered in red and gold; and both sexes wear sheepskins in cold weather. The linen dresses of women are fastened by a long sash or girdle, wound many times round the waist: the holiday attire being a white gown covered with embroideries, one or more brightly coloured aprons and necklaces of beads or coins. The standard of comfort is lowest along the Danube and in parts of the Dobruddja. As the land becomes higher, the dwellings improve; but, despite the presence of a doctor in each commune, disease is everywhere rife. Many villages are wholly built of timber and thatch, especially amongst the Carpathians, the floors being frequently raised on piles, several feet above the ground. The inner walls are often hung with hand-woven tapestries, which harmonize well with the smoke-blackened rafters, the primitive loom and the huge Dutch stove characteristic of a prosperous Rumanian farm. Many pagan beliefs linger on in the country, where vampires, witches and the evil eye are dreaded by all. The peasants reassure themselves by the use of charms and spells, and by a strict observance of the forms which their creed prescribes. A cross guards every well or spring; every home has its *ibons* or sacred pictures. Church festivals and fasts are kept with equal care. For months together a Ruman will subsist on vegetables and *mamaliga*, the maize porridge that forms his staple diet. Beef and mutton are rarely touched, and in some districts pork is only eaten on St. Iliry's day (the 20th of December, O.S.). Veal is the one kind of meat generally consumed. Wine and plum-spirit, or the more powerful brandy distilled from grain, are drunk in great quantities by the townsfolk, more sparingly by countrymen; Rumans generally being more sober than the western Europeans. The ceremonies which accompany a wedding preserve the tradition of marriage by capture; a peasant bride must enter her new home carrying bread and salt, and in parts of Walachia a flower is painted on the outer wall of cottages in which there is a girl old enough to marry. Young men swear eternal brotherhood; girls, eternal sisterhood; and the Church ratifies their choice in a service at which the feet of the pair are chained together. This relationship is morally and legally regarded as not less binding than kinship by birth. The dead are borne to the grave with uncovered faces, and a Rumanian funeral is a scene of much barbaric display. All classes delight in music and dancing. Women hold spinning-parties at which the leader begins a ballad, and each in turn contributes a verse. A number of satirical folk-tales (largely of Turkish origin) are current at the expense of Jew, gipsy or parish priest. The Rumanian folk-songs, sung and often improvised by the villagers, or by a wandering guitar-player (*cobzar*), are of exceptional interest and beauty (see *Literature*, below). The national dances and music closely resemble those of the Southern Slavs (see MONTENEGRO and BULGARIA).

Constitution.—In 1866, Prince Charles of Hohenzollern-Sigmaringen was chosen prince of Rumania by a constituent assembly elected under universal suffrage. This body at the same time drew up a constitution, which remains in force, though modified in 1879 and 1884. In 1881, Prince Charles was proclaimed king. As he proved childless, the succession was accepted by his brother, Prince Leopold, on behalf of his son William; and in 1888 William renounced his claim in favour of Ferdinand his younger brother. Thus the monarchy became hereditary in the family of Hohenzollern-Sigmaringen. No woman may ascend the throne; and, in default of a male heir, the representatives of the people can choose a king among the royal families of western Europe.

Parliament consists of a senate, elected for eight years, and

a chamber of deputies, elected for four years. Senators must be forty years old and possess an income of 9400 lei (£376). They are chosen by two colleges of electors; one composed of citizens with an income of £80; the other, of citizens with incomes varying from £32 to £80. The heir-apparent, the two archbishops, the six bishops and the rectors of both universities, sit *ex officio* in the senate. For the chamber of deputies, all citizen taxpayers of full age may vote, being organized for the purpose into three colleges. All persons with an income of £50 vote in the first; all residents in an urban commune who pay taxes amounting to sixteen shillings yearly, with those who have been through the primary course of education, and all members of the liberal professions, retired officers and state pensioners, vote in the second. The third college is formed of the remaining taxpayers. Those who can read and write vote directly, the rest indirectly. Every fifty indirect electors choose a delegate, who votes along with the direct electors. The naturalization of Jews and Moslems is hedged about by many technical difficulties, and requires a separate vote of the legislature in every individual case. Deputies must be not less than twenty-five years of age. Both senators and deputies receive 20 lei for each day of actual attendance, and travel free on the railways. The king may temporarily veto any measure passed by parliament. Executive power is vested in a council under the presidency of a prime minister, and representing the ministers of foreign affairs; justice; the interior; religion and education; war; finance; agriculture, trade, industry and public domains; and public works. Entire liberty of speech, assembly and the press is guaranteed by the constitution, by which also the titles and privileges of the boiars or nobles were abolished.

For purposes of local government, Rumania is divided into 32 departments, each controlled by a prefect, and subdivided into sub-prefectures and communes. The sub-prefectures (*plăși*) correspond with the French *arrondissements*. Prefects and sub-prefects are appointed by the state, but the chief civil officers are elected. Very heavy *actio* duties provide the means of municipal administration.

Law and Justice.—Until the 17th century justice was administered according to custom and precedent, or, in ecclesiastical cases, by the rules of an ill-defined canon law. The first change was introduced by Matthew Bassaraba, prince of Walachia (1633-54), and by Basil the Wolf, prince of Moldavia (1634-53). Basil drew up a criminal code, on the principle of "an eye for an eye." Thus, a man guilty of arson was burned alive. No idea of equality before the law as yet existed: nobles might only be beheaded or banished. Bassaraba, besides reforming the canon law, issued a similar criminal code, with a number of civil enactments, based on Roman law, and regulating testament, guardianship, &c. The next great advance began with the Russian protectorate over Rumania (1828-56), when magistrates were made irremovable, and new tribunals created, including a petty court in each rural commune. But nothing was yet done to modify the relative positions of noble and serf. The growth of the present system dates from the union of Moldavia and Walachia in 1859. The main provisions of Rumanian law are drawn from the codes of western powers, especially the *Code Napoléon*. Besides the communal courts, there are quarter-session or circuit courts, where simple cases are decided. An appeal from these lies to the departmental courts, which sit in every capital of a department, and in which sessions are held, at stated times, for the trial by jury of serious offences. Any appeal from the departmental courts is brought before the appeal courts of Bucharest, Craiova, Galatz or Jassy; and thence, if necessary, to the supreme tribunal, or court of cassation (*Curtea de Casatie*), which sits in Bucharest.

Defence.—At the accession of Prince Charles, the Rumanian army consisted of raw levies, led by adventurers from any country, provided with no uniform, and, in many cases, armed only with pikes or sabres. Under Prince Charles universal and compulsory service was introduced. The present system, in which his reforms culminated, rests upon a law of 1891, modified in 1900 and 1908.

By this law the forces are divided into three sections. The first is composed of men between the ages of 21 and 30, enrolled in the field army and its reserves. Every citizen capable of bearing arms must serve from his 30th to his 36th year in the second section, or territorial militia, which musters in spring for shooting-practice and in the autumn for field manoeuvres. In the militia are included soldiers who have served their time in the ranks, and recruits chosen by lot from the yearly contingent of conscripts but not immediately summoned for duty in the field army. Finally, every citizen between the ages of 36 and 46 belongs to the third section, called the *Gloata (Landsturm)*, which can only be called upon for

home service in war. In time of peace the field army consists of four complete army corps, with headquarters at Craiova, Bucharest, Jassy and Galatz; besides an independent brigade in the Dobrujda, and a separate cavalry division with headquarters at Bucharest. Its peace strength in 1909-10 was 4415 officers, 89,227 non-commissioned officers and men and 18,920 horses. The infantry was armed with the Mannlicher magazine rifle (model 1893); the cavalry with the Mannlicher carbine, the horse and field artillery with Krupp quick-firing guns. On a war footing the field army would contain 225,000 combatants. It was estimated that the militia should ultimately furnish an additional force of 100,000 men, but up to 1910 this branch of the service was not completely organized. The arrangements for mobilization are otherwise very complete, and the field army is maintained in a high state of efficiency. The war budget for 1909-10 was £2,271,300.

The fortifications designed in 1882 by the Belgian engineer, General Brialmont, and completed at a cost of more than £4,000,000, form the keystone of the national defences. They consist of the Sereth Line, an entrenchment extending over a front of 45 m. from Galatz to Focshani, and intended to cover an army of defence against invaders from the north-east, and of the outworks which make Bucharest the largest fortified camp in the world, except Paris. All these fortifications, including the additional works at Galatz and Focshani, are strongly armed with Krupp and Gruson guns.

The Rumanian navy is divided into two squadrons: one for the Danube, and the other for the Black Sea, with headquarters at Constanza. In 1909-10 the fleet comprised one cruiser, seven gunboats, eight torpedo-boats, six coastguard vessels, a training-ship, a despatch-boat, a ship for the mining service and numerous vessels for naval police. The state possesses a floating dock and a marine arsenal at Galatz.

Religion.—The State Church of Rumania, which is governed by a Holy Synod, professes the Orthodox Oriental creed. Its independence was formally recognized by the oecumenical patriarch of Constantinople, in 1865. The Rumanian church had claimed its independence and autonomy under the Turkish suzerainty, and Phanariote hospodars Greeks were generally elected as bishops, and the influence of the Greek patriarch at Constantinople came to be more and more felt. In 1864 it declared itself independent of all foreign prelates. In 1872 a law was passed by which the bishops were elected by the senate, the chamber of deputies, and the synod sitting as an assembly (the only other occasion on which provision is made for such an assembly is in the event of the throne becoming vacant without any apparent heir). It was subsequently decided to consecrate the holy oil in Rumania instead of procuring it from Russia or Constantinople; but the Greek patriarch protested. Secret negotiations were entered into which came to a successful issue. The patriarch feared on the one hand that the growing influence of the Russian Church would give a colour of Slavism to the whole church, and that a Russian might eventually be appointed oecumenical patriarch at Constantinople, while the Rumanians hoped by means of the independence of their church to deprive the Russians of all excuse for interfering in their internal affairs under the pretext of religion. The Rumanians, although obtaining complete independence, agreed to recognize the patriarch at Constantinople as the chief dignitary of the Orthodox Church.

The metropolitan archbishop of Bucharest, officially styled metropolitan primate of Rumania, presides over the Holy Synod; the other members being the metropolitan of Jassy (primate of Moldavia), the six bishops of Râmnicu Vâlcea, Roman, Hushi, Buzeu, Curtea de Argesh and the Lower Danube (Galatz); together with eight bishops in *partibus*, their coadjutors. Metropolitans and bishops are elected by the senate and deputies, sitting together. In Hungary there are a uniate metropolitan and three bishops belonging to the Rumanian church. The secular clergy, many of whom are of noble rank, and only regular clergy (*kalugari*) are eligible for high preferment. Although many convents had been closed and utilized for secular purposes, there were in 1910 no less than 168, including nunneries. The older convents are usually built in places difficult of access and are strongly fortified; for in troublous times they served as refuges for the peasants or rallying-places for demoralized troops. The sequestration of the monastic estates, which in 1864 covered nearly one-third of Rumania, was due to flagrant abuses. Many estates were held by alien foundations, such as the convents of Mount Athos and Jerusalem; while the revenues of many more were spent abroad by the patriarch of Constantinople. Religious liberty is accorded to all churches, Jews, Moslems, Roman Catholics, Protestants, Armenians and Lipovans having their own places of worship.

Education.—Primary education is free and compulsory, "where schools are available," for children between seven and eleven years of age. At the close of the 19th century, however, the accommodation was insufficient, the attendance limited in consequence, and the percentage of illiterates high; reaching 88.5% in some of the rural communes. Great improvements were effected between 1900 and 1907, the number of schools increasing from 3643 to 14,465, and the pupils from 1,000,000 to 3,000,000. The state contributes to the maintenance of elementary schools, for the Vlachs in Macedonia, Bulgaria and Transylvania.

Secondary and higher education are also free. There are gymnasiums, or grammar schools of four classes, roughly corresponding with the German sub-gymnasiums; and lycées of eight classes, which answer to the German gymnasiums. Up to the fourth class all pupils are taught alike in the lycées; in the fifth, however, they are divided into a literary or "humanist" section, and a scientific or "realist" section. The four upper classes are taught French and German; English and Italian being added for the realists. Greek and Latin for the humanists. Technical instruction is given in the agricultural schools; in various arts and crafts institutions, such as those of Bucharest and Jassy; in the veterinary and engineering colleges of Bucharest; in numerous commercial schools, and in schools of domestic economy for girls. In 1909-10 there were four ecclesiastical seminaries, seven training schools for teachers and eight military schools. The cost of education is largely borne by the communes, as well as by the state. At Bucharest and Jassy there are universities with faculties of law, philosophy, science and medicine and theology.

Antiquities.—The history of primitive civilization in Rumania can be traced back to the Neolithic Age; numerous remains of this period have been found at Vodastra in the Romanzi department. Roman rule left a deep imprint on the country. The following Roman towns have been identified: (1) in the Dobruja, Cius (Hirsova), Troëmis (Igitza), Arrubium (Machin), Viodunum (Isackha), Istrus (Karaharman), Tropaeum (Adam Klissi), Kallatis (Mangalia), Tomi (Constanza); (2) in Moldavia, Dinogetia (Tigina); (3) in Walachia, Drobetae (Turnu Severin), Malva (Celeiu), Castra Nova (Craiova), Romula (Resca), Sorium (Roshiori de Vede), Pelendava (Brădeci), Adicava (Jenuseshit), Rusidava (Dragasani), Castra Trajana (Râmnicul-Alcei), Arutela (Bivolari), Pons Vetus (Caineni), Komidava (Petrossa), Ravenna (Buzeu). A celebrated railway road encircled the Dobruja hills and skirted the Bulgarian shore of the Danube. It was linked by a ferry at Celeiu to two lesser roads; one striking northwards into Transylvania, up the Olt valley, the other bending westwards until it reached the Jiu, and there diverging southwards to Turnu Severin, and northwards to the Vulcan Pass. The plains near the Olt and Jiu estuaries are rich in Roman remains, notably in the towns of Caracal, Grodjidob and Islaz. Ruins and inscriptions may be seen at Resca, a temple at Slaveni, villas and a statue of the emperor Commodus (A.D. 161-92) at Celeiu. All these lie within a radius of 60 m. Two ramparts, known as Trajan's Wall, can be discerned, one on either side of the railway from Cernavoda to Constanza; and there were bridges over the Danube at Turnu Severin and Turnu Magurele. The *Tropaeum Trajani*, or Adam Klissi monument (found near Rassoava in the Dobruja and removed to Bucharest museum), is a round stone structure of 100 ft. circumference and 40 ft. high, carved in low relief with scenes representing Trajan's conquest of Dacia. (See G. Tocilescu, *Das Monument von Adam Klissi*, Vienna, 1895.) Few monuments were left by the barbarian invaders who ravaged Rumania from the 3rd century to the 14th save some vestiges of Gothic culture at Buzeu, and at Petrossa, close by. The celebrated treasure of Petrossa (commonly written Petrossa), preserved in Bucharest museum, consists of embossed and jewelled gold plate, and probably dates from the 6th century (see PLATE). Medieval tapestries, with ecclesiastical vestments, ornaments and some fine pieces of early woodwork, are also preserved in Bucharest museum. The attempt to create a national style of architecture, based on Greek and Byzantine models, began under Stephen the Great of Moldavia (1457-1504), lasting until the 17th century, when it was arrested, first by political disorders, and, later, by the commercial development which caused a demand for cheap and rapid building. Its chief accomplishment is the cathedral of Curtea de Argesh (*q.v.*). Painting and sculpture, like modern Rumanian architecture, are still in their infancy.

BIBLIOGRAPHY.—A list of the numerous statistical and other official publications issued at Bucharest in Rumanian or French is given yearly in *Annual statistique de Roumanie*. The final results of the census of 1899 were published by the ministry of agriculture in 1905, with introduction by Dr L. Colescu. See also G. J. Lahovari, *Marele dicționar geografic al României* (vols. 1-5, Bucharest, 1899-1902); A. de Gubernatis, *La Roumanie et les Roumains* (Florence, 1898); E. de Martonne, *La Valachie, essai de géographie géographique*; J. Samuelson, *Rumania, Past and Present* (London, 1882); G. Beuger, *Rumania in 1900* (trans. from the German by A. H. Keane (London, 1901)); A. Bellessort, *La Roumanie contemporaine* (Paris, 1905); L. Colescu, *Progrès économiques... réalisés sous le règne de Sa Majesté le Roi Carol I.* (Bucharest, 1907); G. D. Creanga, *Grundbesitzverteilung und Bauernfrage in Rumänien* (Leipzig, 1907); C. Baicoianu, *Histoire de la politique douanière de la Roumanie de 1870-1903* (2 vols., Bucharest, 1904). (X.)

ISTORY

(1) *Introduction.*—The earliest record of the lands which constitute the kingdom of Rumania begins with the period immediately preceding their conquest by the Romans. *Dacia.* For information upon this period, and upon the subsequent centuries of Roman or Byzantine rule, see

DACIA. From the 6th to the 12th century, wave after wave of barbarian conquerors, Goths, Tatars, Slavs and others, passed over the country, and, according to one school of historians, almost obliterated its original Daco-Roman population; the modern Vlachs, on this theory, representing a later body of immigrants from Transdanubian territory. According to others, the ancient inhabitants were, at worst, only submerged for a time, and their direct descendants are the Rumanians of to-day. Each of these conflicting views is supported by strong evidence; and the whole controversy, too large and too obscure for discussion here, is considered under the heading VLACHS.

Towards the close of the 13th century, Walachia and Moldavia were occupied by a mixed population, composed partly of Vlachs, but mainly of Slavs and Tatars; in Great Walachia,¹ also called Muntenia, the Petchenegs and Cumanians predominated. Rumanian historians have striven, by piecing together the stray fragments of evidence which survive, to prove that their Vlach ancestors had not, as sometimes alleged, been reduced to a scattered community of nomadic shepherds, dwelling among the Carpathians as the serfs of their more powerful neighbours. The researches of Hasdeu, Xenopol and other historians tend to show the existence of a highly organized Vlach society in Transylvania, Oltland and certain districts of Hungary and Moldavia; of a settled commonalty, agricultural rather than pastoral; and of a hereditary feudal nobility, bound to pay tribute and render military service to the Hungarian crown, but enjoying many privileges, which were defined by a distinct customary law (*jus valachicum*). Although the characteristic titles of *voivode*, *knes* and *ban* (all implying military as well as civil authority) are of Slavonic origin, and perhaps derived from the practice of the later Bulgarian (or Bulgaro-Vlachian) empire, the growth of Vlach feudal institutions is attributed to German influences, which permeated through Hungarian channels into the Vlach world, and transformed the primitive tribal chiefs into a feudal aristocracy of *boiars* or *boyards* (nobles).

With the 13th century, at latest, begins the authentic political history of the Vlachs in Rumania, but it is not the history of a united people. The two principalities of Walachia and Moldavia developed separately, and each has its own separate annals. About the year 1774 it first becomes possible to trace the progress of these Danubian Principalities in a single narrative, owing to the uniform system of administration adopted by the Turkish authorities, and the rapid contemporary growth of a national consciousness among the Vlachs. At last, in 1859, the two principalities were finally united under the name of Rumania. The subjoined history of the country is arranged under the four headings: *Walachia, Moldavia, the Danubian Principalities and Rumania*, in order to emphasize this historical development.

(2) *Walachia.*—Tradition, as embodied in a native chronicle of the 16th century, entitled the *History of the Rumun Land since the arrival of the Rumans (Istoria țerei Românească de la cîndău a descălicăta Românil)*, gives a precise account of the founding of the Danubian state by Radu Negru, or Rudolf the Black (otherwise known as Negru Voda, the Black Prince), voivode of the Rumanians of Fogaras in Transylvania, who in 1290 descended with a numerous people into the Transalpine plain and established his capital first at Câmpulung and then at Curtea de Argesh. Radu dies in 1310, and is succeeded by a series of voivodes whose names and dates are duly given; but this early chapter of Walachian history has been rudely handled by critical historians. A considerable body of Vlachs doubtless emigrated from Hungary at this time, and founded in Walachia a principality dependent

¹ i.e. Walachia east of the Olt, not to be confused with the *Μεγάλη Βλαχία* in southern Macedonia (see BALKAN PENINSULA).

² In later Rumanian history there arose a class who obtained their rank by merit or favour, and did not necessarily bequeath it to their heirs. But the hereditary aristocracy also survived, and feudalism remained characteristic of Rumanian society up to 1860.

on the Hungarian crown; but material is lacking for a detailed description of the movement.

In 1330 the voivode John Bassaraba¹ or Bazarab the Great (1310-38) succeeded in inflicting a crushing defeat on his

Hungarian Supremacy. suzerain King Charles I. of Hungary, and for fourteen years Walachia enjoyed complete independence. Louis the Great (1342-82) succeeded for a while in restoring the Hungarian supremacy, but in 1367 the voivode Vlad or Vladislav inflicted another severe defeat on the Hungarians, and succeeded for a time in ousting the Magyar governor of Turnu Severin, and thus incorporating Oltland in his own dominions. Subsequently, in order to retain a hold on the loyalty of the Walachian voivode, the king of Hungary invested him with the title of duke of Fogaras and Omlas, Ruman districts in Transylvania.

Under the voivode Mircea (1386-1418), whose prowess is still celebrated in the national folk-songs, Walachia played for a while a more ambitious part. This prince during the earlier part of his reign sought a counterpoise to Hungarian influence in close alliance with King Ladislaus V. of Poland. He added to his other titles that of "count of Severin, despot of the Dobruđa, and lord of Silistria," and both Vidin and Sistora appear in his possession. A Walachian contingent, apparently Mircea's, aided the Serbian tsar Lazar in his vain endeavour to resist the Turks at Kossovo (1389); later he allied himself with his former enemy Sigismund of Hungary against the Turkish sultan Bayezid I., who inflicted a crushing defeat on the allied armies at Nikopolis in 1396. Bayezid subsequently invaded and laid waste a large part of Walachia, but the voivode succeeded in inflicting considerable loss on the retiring Turks, and the capture of Bayezid by Timur in 1402 gave the country a reprieve. In the internecine struggle that followed amongst the sons of Bayezid, Mircea espoused the cause of Musa; but, though he thus obtained for a while considerable influence in the Turkish councils, this policy eventually drew on him the vengeance of the sultan Mahomet I., who succeeded in reducing him to a tributary position.

During the succeeding period the Walachian princes appear alternately as the allies of Hungary or the creatures of the Turk. In the later battle of Kossovo of 1448, between the Hungarians, led by Hunyadi János and the sultan Murad II., the Walachian contingent treacherously surrendered to the Turks; but this did not hinder the victorious sultan from massacring the prisoners and adding to the tribute a yearly contribution of 3000 javelins and 4000 shields. In 1453 Constantinople fell; in 1454 Hunyadi died; and a year later the sultan invaded Walachia to set up Vlad IV. (1455-62), the son of a former voivode. The father of this Vlad had himself been notorious for his ferocity, but his son, during his Turkish sojourn, had improved on his father's example. He was known in Walachia as *Dracul*, or the Devil, and has left a name in history as Vlad the Impaler. The stories of his ferocious savagery exceed belief. He is said to have feasted amongst his impaled victims. When the sultan Mahomet, infuriated at the impalement of his envoy, the pasha of Vidin, who had been charged with Vlad's deposition, invaded Walachia in person with an immense host, he is said to have found at one spot a forest of pales on which were the bodies of men, women and children. The voivode Radu (1462-75) was substituted for this monster by Turkish influence, and constrained to pay a tribute of 12,000 ducats; but Vlad returned to the throne in 1476-77.

The shifting policy of the Walachian princes at this time is well described in a letter of the Hungarian king Matthias Corvinus (1458-90) to Casimir of Poland. "The voivodes," he writes, "of Walachia and Moldavia fawn alternately upon the Turks, the Tatars, the Poles and the Hungarians, that among so many masters their perfidy may remain unpunished." The

¹A. Sturdza gives a genealogical table, showing that Radu belonged to the great native dynasty of Bassarab (*quæ*) or Bassaraba, which continued, though not in unbroken succession, to rule in Walachia until 1658, and in Moldavia until 1669.

prevalent laxity of marriage, the frequency of divorce, and the fact that illegitimate children could succeed as well as those born in lawful wedlock, by multiplying the candidates for the voivodeship and preventing any regular system of succession, contributed much to the internal confusion of the country. The elections, though often controlled by the Turkish Divan, were still constitutionally in the hands of the boiars, who were split up into various factions, each with its own pretender to the throne. The princes followed one another in rapid succession, and usually met with violent ends. A large part of the population led a pastoral life, and at the time of Verantius's visit to Walachia in the early part of the 16th century, the towns and villages were built of wood and wattle and daub. Tirgovishta alone, at this time the capital of the country, was a considerable town, with two stone castles.

A temporary improvement took place under Neagoe Bassaraba (1512-21). Neagoe was a great builder of monasteries; he founded the cathedrals of Curtea de Arghesh (*q.v.*) and Tirgovishta, and adorned Mount Athos with his pious works. He transferred the direct allegiance of the Walachian Church from the patriarchate of Ohrida in Macedonia to that of Constantinople. On his death, however, the brief period of comparative prosperity which his architectural works attest was tragically interrupted, and it seemed for a time that Walachia was doomed to sink into a Turkish pashalic. The Turkish commander, Mahmud Bey, became treacherously possessed of Neagoe's young son and successor, and, sending him a prisoner to Stambul, proceeded to nominate Turkish governors in the towns and villages of Walachia. The Walachians resisted desperately, elected Radu, a kinsman of Neagoe, voivode, and succeeded with Hungarian help in defeating Mahmud Bey at Grumatz in 1522. The conflict was prolonged with varying fortunes until in 1524 the dogged opposition of the Walachians triumphed in the sultan's recognition of Radu.

But the battle of Mohacs in 1526 decided the long preponderance of Turkish control. The unfortunate province served as a transit route for Turkish expeditions against Hungary and Transylvania, and was exhausted by continual requisitions. Turkish settlers were gradually making good their footing on Walachian soil, and mosques were rising in the towns and villages. The voivode Alexander, who succeeded in 1591, and like his predecessors had bought his post of the Divan, carried the oppression still further by introducing a janissary guard and farming out his possessions to his Turkish supporters. Meanwhile the Turkish governors on the Bulgarian bank never ceased to ravage the country, and again it seemed as if Walachia must share the fate of the Balkan States and succumb to the direct government of the Ottoman.

In the depth of the national distress the choice of the people fell on Michael, the son of Petrusko, ban of Craiova, the first dignitary of the realm, who had fled to Transylvania to escape Alexander's machinations. Supported at Constantinople by two influential personages, Sigismund Báthory, prince of Transylvania (1581-98 and 1601-2), and the English ambassador, Edward Barton, and aided by a loan of 200,000 florins, Michael succeeded in procuring from the Divan the deposition of his enemy and his own nomination.

The genius of Michael "the Brave" (1593-1601) secured Walachia for a time a place in universal history. The moment for action was favourable. The emperor Rudolph II. had gained some successes over the Turks, and Sigismund Báthory had been driven by Turkish extortions to throw off the allegiance to the sultan. But the first obstacle to be dealt with was the presence of the enemy within the walls. By previous concert with the Moldavian voivode Aaron, on the 13th of November 1594, the Turkish guards and settlers in the two principalities were massacred at a given signal. Michael followed up these "Walachian Vespers" by an actual invasion of Turkish territory, and, aided by Sigismund Báthory, succeeded in carrying by assault Rustchuk, Silistria and other places on the right bank of the lower Danube. A simultaneous invasion of Walachia by a large Turkish and Tatar host was successfully defeated;

Turkish oppressions.

Revolutions with Hungary and the Turks.

Michael the Brave.

the Tatar khan withdrew with the loss of his bravest followers, and, in the great victory of Mantin on the Danube (1595), the Turkish army was annihilated, and its leader, Mustafa, slain. The sultan now sent Sinan Pasha, "the Renegade," to invade Walachia with 100,000 men. Michael withdrew to the mountains before this overwhelming force, but, being joined by Báthory with a Transylvanian contingent, the voivode resumed the offensive, stormed Bucharest, where Sinan had entrenched a Turkish detachment, and, pursuing the main body of his forces to the Danube, overtook the rearguard and cut it to pieces, capturing enormous booty. Sinan Pasha returned to Constantinople to die, it is said, of vexation; and in 1597, the sultan, weary of a disastrous contest, sent Michael a red flag in token of reconciliation, reinvested him for life in an office of which he had been unable to deprive him, and granted the succession to his son.

In 1590, on the abdication of Sigismund Báthory in Transylvania, Michael, in league with the imperialist forces, and in connivance with the Saxon burghers, attacked and defeated his successor Andreas Báthory near Hermannstadt, and, seizing himself the reins of government, secured his proclamation as prince of Transylvania. The emperor consented to appoint him his viceroy (*locum tenens per Transylvaniam*), and the sultan ratified his election. As prince of Transylvania he summoned diets in 1590 and 1600, and, having expelled the voivode of Moldavia, united under his sceptre three principalities. The partiality that he showed for the Ruman and Szekler parts of the population alienated, however, the Transylvanian Saxons, who preferred the direct government of the emperor. The imperial commissioner General Basta lent his support to the disaffected party, and Michael was driven out of Transylvania by a successful revolt, while a Polish army invaded Walachia from the Moldavian side. Michael's coolness and resource, however, never deserted him. He resolved to appeal to the emperor, rode to Prague, won over Rudolph by his singular address, and, richly supplied with funds, reappeared in Transylvania as imperial governor. In conjunction with Basta he defeated the superior Transylvanian forces at Gorosló, expelling Sigismund Báthory, who had again aspired to the crown, and taking one hundred and fifty flags and forty-five cannon. But at the moment of his returning prosperity Basta, who had quarrelled with him about the supreme command of the imperial forces, procured his murder on the 10th of August 1601. Not only had Michael succeeded in rolling back for a time the tide of Turkish conquest, but for the first and last time in modern history he united what once had been Trajan's Dacia, in its widest extent, and with it the whole Ruman race north of the Danube, under a single sceptre.

Michael's wife Florika and his son Nicholas were carried off into Tatar captivity, and Șerban or Șerban, of the Bassaraba family, was raised to the voivodeship of Walachia by imperialist influences, while Sigismund resumed the government of Transylvania. On his deposition by the Porte in 1610, there followed a succession of princes who, though still for the most part of Ruman origin, bought their appointment at Stambul. Walachian contingents were continually employed by the Turks in their Polish wars, and the settlement of Greeks in an official or mercantile capacity in the principality provoked grave discontent, which on one occasion took the form of a massacre.

The reign of the voivode Matthias Bassaraba (1633-54) was an interval of comparative prosperity. Matthias repulsed his powerful rival, Basil the Wolf, the voivode of Moldavia and his Tatar and Cossack allies. His last days were embittered, however, by an outbreak of military anarchy. His illegitimate son and successor, Constantine Șerban (1654-58), was the last of the Bassaraba dynasty to rule over Walachia; and on his death the Turkish yoke again weighed heavier on his country. The old capital, Irgovishta, was considered by the Divan to be too near the Transylvanian frontier, and the voivodes were accordingly compelled to transfer their residence to Bucharest, which was finally made the seat of government in 1698.

The mechanical skill of the Walachians was found useful by the Turks, who employed them as carpenters and pontonniers: and during the siege of Vienna in 1683 the Walachian contingent, which, under the voivode Șerban Cantacuzene, had been forced to co-operate with the Turks, was entrusted with the construction of the two bridges over the Danube above and below Vienna. The Walachian as well as the Moldavian prince, who had been also forced to bring his contingent, maintained a secret system of communication with the besieged, which was continued by Șerban after his return to Walachia. The emperor granted him a diploma creating him count of the empire and recognizing his descent from the imperial house of Cantacuzene, Șerban meanwhile collecting his forces for an open breach with the Porte. His prudence, however, perpetually postponed the occasion, and Walachia enjoyed peace to his death in 1688. This peaceful state of the country gave the voivode leisure to promote its internal culture, and in the year of his death he had the satisfaction of seeing the first part of a Walachian Bible issue from the first printing-press of the country, which he had established at Bucharest. He had also caused to be compiled a history of Walachia, and had called to the country many teachers of the Greek language, whose business it was to instruct the sons of the boiars in grammar, rhetoric and philosophy.

Immediately on Șerban's death the boiars, to prevent the Porte from handing over the office to the Greek adventurer who bid the highest, proceeded to elect his sister's son Constantine Brancovan. The Turkish envoy then in Bucharest was persuaded to invest Brancovan with the *caflan*, or robe of office, in token of Turkish approval, and the patriarch of Constantinople, who was also present, and the archbishop of Walachia, Theodosius, consecrated him together at the high altar of the cathedral, where he took the coronation oath to devote his whole strength to the good of his country and received the boiars' oath of submission. Brancovan, it is true, found it expedient to devote his predecessor's treasure to purchasing the confirmation of his title from the Divan, but the account of his coronation ceremony remains an interesting landmark in the constitutional history of the country. In his relations with the Habsburg power he displayed the same caution as the voivode Șerban. In spite of defeats inflicted on the Turks by the imperial troops at Pozharevts, Nish and Vidin, in 1689, it was only by an exercise of force that they secured winter quarters in Walachia; and though, after the battle of Poltava in 1709, Brancovan concluded a secret treaty with the tsar Peter the Great, he avoided giving open effect to it. The tranquillity which he thus obtained was employed by Brancovan as by his predecessor in furthering the internal well-being of the country, with what success is best apparent from the description of Walachia left by the Florentine Del Chiaro, who visited the country in 1709 and spent seven years there. He describes the stoneless Walachian plain, with its rich pastures, its crops of maize and millet, and woods so symmetrically planted and carefully kept by Brancovan's orders that hiding in them was out of the question. Butter and honey were exported to supply the sultan's kitchen at Stambul; wax and cattle to Venice; and the red and white wine of Walachia, notably that of Pitesci, to Transylvania. The Walachian horses were in demand among the Turks and Poles. Near Ribnik and elsewhere were salt-mines which supplied all the wants of the Transdanubian provinces of Turkey; there were considerable copper mines at Maidan; and iron was worked near Irgovishta. The gipsy community was bound to bring fifteen pounds weight of gold from the washings of the Arghesh. Many of the boiars were wealthy, but the common people were so ground down with taxation that "of their ancient Roman valour only the name remained." To avoid the extortion of their rulers numbers had emigrated to Transylvania and even to the Turkish provinces. The principal Walachian city was Bucharest, containing a population of about 50,000; but, except for two large *hans* or merchants' halls built by Brancovan and his

Șerban
Cantacuzene.Constantine
Brancovan.Del
Chiaro's
description
of
Walachia.

predecessor, and the recently erected palace, which had a marble staircase and a fine garden, the houses were of wood. The dress of the men was thoroughly Turkish except for their lamb-skin caps, that of the women half Greek, half Turkish. The houses were scrupulously clean and strewn with sweet herbs. Del Chiaro notices the great imitative capacity of the race, both artistic and mechanical. A Walachian in Venice had copied several of the pictures there with great skill; the copper-plates and wood engravings for the new press were executed by native hands. The Walachians imitated every kind of Turkish and European manufacture; and, though the boiars imported finer glass from Venice and Bohemia, a glass manufactory had been established near Tirgovishteia which produced a better quality than the Polish. From the Bucharest press, besides a variety of ecclesiastical books, there were issued in the Ruman tongue a translation of a French work entitled *The Maxims of the Orientals* and *The Romance of Alexander the Great*. In 1700 Brancovan had a map of the country made and a copperplate engraving of it executed at Padua.

The prosperity of Walachia, however, under its "Golden Bey," as Brancovan was known at Stambul, only increased the Turkish exactions; and, although all demands were punctually met, the sultan finally resolved on the removal of his too prosperous vassal. Brancovan was accused of secret correspondence with the emperor, the tsar, the king of Poland and the Venetian republic, of betraying the Porte's secrets, of preferring Tirgovishteia to Bucharest as a residence, of acquiring lands and palaces in Transylvania, of keeping agents at Venice and Vienna, in both of which cities he had invested large sums, and of striking gold coins with his effigy.¹ An envoy arrived at Bucharest on the 4th of April 1714, and proclaimed Brancovan *mauil*, i.e. deposed. He was conducted to Constantinople and beheaded, together with his four sons. A scion of the rival Cantacuzenian family was elected by the pasha's orders, and he, after exhausting the principality for the benefit of the Divan, was in turn deposed and executed in 1716.

From this period onwards the Porte introduced a new system with regard to its Walachian vassals. The line of national princes ceased. The office of voivode or hospodar was sold to the highest bidder at Stambul, to be farmed out from a purely mercenary point of view. The princes who now succeeded one another in rapid succession were mostly Greeks from the Phanar quarter of Constantinople who had served the palace in the quality of dragoman (interpreter), or held some other court appointment. They were nominated by imperial firman without a shadow of free election, and were deposed and transferred from one principality to another, executed or reappointed, like so many pashas. Like pashas they rarely held their office more than three years, it being the natural policy of the Porte to multiply such lucrative nominations. The same hospodar was often reappointed again and again as he succeeded in raising the sum necessary to buy back his title. Constantine Mavrocordat was in this way hospodar of Walachia at six different times, and paid on one occasion as much as a million lion-dollars (£40,000) for the office. The princes thus imposed on the country were generally men of intelligence and culture. Nicholas Mavrocordat, the first of the series, was himself the author of a Greek work on duties, and maintained at his court Demeter Prokopios of Moschopolis in Macedonia, who wrote a review of Greek literature during the 17th and beginning of the 18th centuries. Constantine Mavrocordat was the author of really liberal reforms. He introduced an *urbarium* or land law, limiting to 24 the days of *angaria*, or forced labour, owed yearly by the peasants to their feudal lord. In 1747 he decreed the abolition of serfdom, but this enactment was not carried

into effect. But the rule of the Phanariotes could not but be productive of grinding oppression, and it was rendered doubly hateful by the swarms of Greek adventurers who accompanied them. Numbers of the peasantry emigrated, and the population rapidly diminished. In 1745 the number of tax-paying families, which a few years before had amounted to 147,000, had sunk to 70,000. Yet the taxes were continually on the increase, and the hospodar Scarlat Ghica (1758-61), though he tried to win some popularity by the removal of Turkish settlers and the abolition of the *vakarîr* or tax on cattle and horses, which was peculiarly hateful to the peasantry, raised the total amount of taxation to 25,000,000 lion-dollars, about £1,000,000. The Turks meantime maintained their grip on the country by holding on the Walachian bank of the Danube the fortresses of Giurgevo, Turnu Severin and Orsova, with the surrounding districts.

But the tide of Ottoman dominion was ebbing fast. Already, by the peace of Passarowitz Pozharevats in 1718, the banat of Craiova had been ceded to the emperor, though by the peace of Belgrade in 1739 it was recovered by the Porte for its Walachian vassal. In 1769 the Russian general Romanzov occupied the principality, the bishops and clergy took an oath of fidelity to the empress Catherine, and a deputation of boiars followed. The liberties of the country were guaranteed, taxation reformed and in 1772 the negotiations at Fokshani between Russia and the Porte broke down because the empress's representatives insisted on the sultan's recognition of the independence of Walachia and Moldavia under a European guarantee. Turkish rule was, however, definitely restored by the treaty of Kutchuk Kainardji, in 1774; and as from this period onwards Walachian history is closely connected with that of Moldavia, it may be convenient before continuing this review to turn to the earlier history of the sister principality.

(3) *Moldavia*.—According to the native traditional account, as first given by the Moldavian chroniclers of the 16th, 17th and 18th centuries, Dragosh the son of Bogdan, the founder of the Moldavian principality, emigrated with his followers from the Hungarian district of Marmaros in the northern Carpathians. The dates assigned to this event vary from 1299, given by Urechia, to 1342, given by the monastic chronicle of Putna. The story is related with various fabulous accompaniments. From the aurochs (*aimbru*), in pursuit of which Dragosh first arrived on the banks of the Moldova, is derived the ox-head of the Moldavian national arms, and from his favourite hound who perished in the waters the name of the river. From the Hungarian and Russian sources, which are somewhat more precise, the date of the arrival of Dragosh, who is confused with the historical Bogdan Voda (1349-1365), appears to have been 1349, and his departure from Marmaros was carried out in defiance of his Hungarian suzerain.

These legendary accounts seem to show that the Moldavian voivodate was founded, like that of Walachia, by Vlach immigrants from Hungary, during the first half of the 14th century. Its original strength lay probably in the compact Ruman settlements among the eastern Carpathians, first mentioned by Nicetas of Chonae, about 1164. The Moldavian lowlands were still held by a variety of Tatar tribes, who were only expelled after 1350, by the united efforts of Andrew Laszkovich, voivode of Transylvania, and Bogdan Voda, the first independent prince of Moldavia. Coins bearing the name of Bogdan are still extant; and there is an inscription over his tomb at the monastery of Radautzi, in Bukovina, placed there by Stephen the Great of Moldavia (1457-1504).

In the agreement arrived at between Louis of Hungary and the emperor Charles IV, in 1372, the voivodate of Moldavia was recognized as a dependency of the crown of St Stephen. The overlordship over the country was, however, contested by the king of Poland, and their rival claims were a continual source of dispute between the two kingdoms. In 1412 a remarkable agreement was arrived at between Sigismund, in his quality of king of Hungary, and King Ladislaus II. of Poland, by which both parties

¹ One of these, with the legend "CONSTANTINVS BASSARABA DE BRANCOVANVS D.G. VOYVODA ET PRINCEPS VALACHIE TRANSILVANIE," and having on the reverse the crowned shield of Walachia containing a raven holding a cross in its beak between a moon and a star, is engraved by Del Chiaro. They were of 2, 3 and 10 ducats weight.

consented to postpone the question of suzerainship in Moldavia. Should, however, the Turks invade the country, the Polish and Hungarian forces were to unite in expelling them, the voivode was to be deposed, and the Moldavian territories divided between the allies. During the first half of the 15th century Polish influence was preponderant, and it was customary for the voivodes of Moldavia to do homage to the king of Poland at his cities of Kameniec or Snyatin.

In 1456 the voivode Peter, alarmed at the progress of the Turks, who were now dominant in Servia and Walachia, offered the sultan Mahomet II. a yearly tribute of 2000 ducats.

Stephen the Great.

On his deposition, however, in 1457 by Stephen, known as "the Great," Moldavia became a power formidable alike to Turk, Pole and Hungarian. Throughout the long reign of this voivode, which lasted forty-six years, from 1458 to 1504, his courage and resources never failed. In the early part of his reign he appears, in agreement with the Turkish sultan and the king of Poland, turning out the Hungarian vassal, the ferocious Vlad, from the Walachian throne, and annexing the coast cities of Kilia and Cetatea Alba or Byelgorod, the Turkish Akkerman. These cities he refused to cede to the sultan, and, about this period, he entered into negotiations with Venice and the shah of Persia, in the vain hope of organizing a world-wide coalition against the Turks. In the autumn of 1474 the sultan Mahomet entered Moldavia at the head of an army estimated by the Polish historian Diugosz at 120,000 men. The voivode Stephen withdrew into the interior at the approach of this overwhelming host, but on the 17th of January 1475, turned to bay at Rahova (Podul Inalt, near Vaslui) and gained a complete victory over the Turks. Four pashas were among the slain; over a hundred banners fell into the Moldavian hands; and only a few survivors succeeded in reaching the Danube. In 1476 Mahomet again invaded Moldavia, but, though successful in the open field, the Turks were sorely harassed by Stephen's guerilla onslaughts, and, being thinned by pestilence, were again constrained to retire. In 1484 the same tactics proved successful against an invasion of Bayezid II. Three years later a Polish invasion of Moldavia under John Albert with 80,000 men ended in disaster, and shortly afterwards the voivode Stephen, aided by a Turkish and Tatar contingent, laid waste the Polish territories to the upper waters of the Vistula, and succeeded in annexing for a time the Polish province of Pokutia, between the Carpathians and the Dniester.

Exclusive of this temporary acquisition, the Moldavian territory at this period extended from the river Milcovu, which formed the boundary of Walachia, to the Dniester. It included the Carpathian region of Bukovina, literally "the beechwood," where lay Sereth and Suciava (Suczawa), the earliest residences of the voivodes, the maritime district of Budaaz (the later Bessarabia), with Kilia, Byelgorod and the left bank of the lower Danube from Galatz to the Sulina mouth. The government, civil and ecclesiastical, was practically the same as that described in the case of Walachia, the officials bearing for the most part Slavonic titles derived from the practice of the Bulgaro-Vlachian tsardom. The church was Orthodox Oriental, and depended from the patriarch of Ochrida.

In official documents the language used was Slavonic, the style of a Moldavian ruler being *Nachalnik i Voievoda Moldolasi*, prince and duke (=Ger. *Fürst* and *Herzog*) of the Moldovlachs. The election of the voivodes, though in the hands of the boiars, was strictly regulated by hereditary principles, and Cantemir describes the extinction of the house of Dragosh in the 16th century as one of the unsettling causes that most contributed to the ruin of the country. The Moldavian army was reckoned 40,000 strong, and the cavalry were especially formidable. Verantius of Sebenico, an eye-witness of the state of Moldavia at the beginning of the 16th century, mentions three towns of the interior provided with stone walls—Suciava, Chotim (Khotin) and Ncamtzu; the people were barbarous, but more warlike than the Walachians and more tenacious of their national costume, punishing with death any who adopted the Turkish.

In 1504 Stephen the Great died, and was succeeded by his son, Bogdan III. "the One-eyed." At feud with Poland about Pokutia, despairing of efficacious support from hard-pressed Hungary, the new voivode saw no hope of safety except in a dependent alliance with the advancing Ottoman power, which already hemmed Moldavia in on the Walachian and Crimean sides. In 1513 he agreed to pay an annual tribute to the sultan Selim in return for the sultan's guarantee to preserve the national constitution and religion of Moldavia, to which country the Turks now gave the name of Kara Bogdan, from their first vassal. The terms of Moldavian submission were further regulated by a firman signed by the sultan Suleiman at Budapest in 1520 by which the yearly present or *bachshish*, as the tribute was euphoniously called, was fixed at 4000 ducats, 40 horses and 25 falcons, and the voivode was bound at need to supply the Turkish army with a contingent of 1000 men. The Turks pursued much the same policy as in Walachia. The tribute was gradually increased. A hold was obtained on the country by the occupation of various fortresses on Moldavian soil with the surrounding territory—in 1538 Cetatea Alba, in 1592 Bender, in 1702 Chotim (Khotin). Already by the middle of the 16th century the yoke was so heavy that the voivode Elias (1546-51) became Mahomedan to avoid the sultan's anger.

At this period occurs a curious interlude in Moldavian history. In 1561 the adventurer and impostor Jacob Basilicus succeeded with Hungarian help in turning out the voivode Alexander Lapusheanu (1552-61 and 1563-68) and seizing on the reins of government. A Greek by birth, adopted son of Jacob Heraklides, despot of Paros, Samos and other Aegean islands, acquainted with Greek and Latin literature, and master of most European languages; appearing alternately as a student of astronomy at Wittenberg, whither he had been invited by Count Mansfeld, as a correspondent of Melanchthon, and as a writer of historical works which he dedicated to Philip II. of Spain, Basilicus, finding that his Aegean sovereignty was of little practical value beyond the crowning of poet laureates, fixed his roving ambition on a more substantial dominion. He published an astounding pedigree, in which, starting from "Hercules Triptolemus," he wound his way through the royal Servian line to the kinship of Moldavian voivodes, and, having won the emperor Ferdinand to his financial and military support, succeeded, though at the head of only 1600 cavalry, in routing by a bold dash the vastly superior forces of the voivode, and even in purchasing the Turkish confirmation of his usurped title. He assumed the style of *Βασιλεὺς Μολδαβίας*, and eluded the Turkish stipulation that he should dismiss his foreign guards. In Moldavia he appeared as a moral reformer, endeavouring to put down the prevalent vices of bigamy and divorce. He erected a school, placed it under a German master, and collected children from every part of the country to be maintained and educated at his expense. He also busied himself with the collection of a library. But his taxes—a ducat for each family—were considered heavy; his orthodoxy was suspected, his foreign counsellors detested. In 1563 the people rose, massacred the Hungarian guards, the foreign settlers, and finally Jacob himself.

The expelled voivode Alexander was now restored by the Porte, the schools were destroyed, and the country relapsed into its normal state of barbarism under Bogdan IV. (1568-72). Bogdan's successor, John the Terrible (1572-74), was provoked by the Porte's demand for 120,000 ducats as tribute instead of 60,000 as heretofore to rise against the oppressor; but after gaining three victories he was finally defeated and slain (1574), and the country was left more than ever at the mercy of the Ottoman. Voivodes were now created and deposed in rapid succession by the Divan, but the victories of Michael the Brave in Walachia infused a more independent spirit into the Moldavians. The Moldavian dominion was now disputed by the Transylvanians and Poles, but in 1600 Michael succeeded in annexing it to his "Great Dacia" realm. On Michael's murder the Poles under Zamoyiski again

Moldavian
tributary
to the
Turks.

Jacob
Basilicus.

Moldavia
circa
1500.

asserted their supremacy, but in 1618 the Porte once more recovered its dominion and set up successively two creatures of its own as voivodes—Gratiani, an Italian who had been court jeweller, and a Greek custom-house official, Alexander.

As in Walachia at a somewhat later date, the Phanariote régime seemed now thoroughly established in Moldavia,

it became the rule that every three years the voivode should procure his confirmation by a large bakshesh, and every year by a smaller one. But Prince Basil the Wolf (Vasilie Lupul), an Albanian, who succeeded in 1634, showed great ability, and for twenty years maintained his position on the Moldavian throne. He introduced several internal reforms, codified the written and unwritten laws of the country, established a printing press, Greek monastic schools, and also a Latin school. He brought the Moldavian Church into more direct relation with the patriarch of Constantinople, but also showed considerable favour to the Latins, allowing them to erect churches at Suciava, Jassy and Galatz. The last voivode of the Bassaraba family, Elias Voda, reigned from 1667 to 1669.

During the wars between Sobieski, king of Poland (1674-96), and the Turks, Moldavia found itself between hammer and anvil, and suffered terribly from Tatar devastations. The voivode Duka was forced like his Walachian contemporary to supply a contingent for the siege of Vienna in 1683. After Sobieski's death in 1696, the hopes of Moldavia turned to the advancing Muscovite power. In 1711 the voivode

Demetrius Cantemir. Demetrius Cantemir, rendered desperate by the

Turkish exactions, concluded an agreement with the tsar Peter the Great by which Moldavia was to become a protected and vassal state of Russia, with the enjoyment of its traditional liberties, the voivodship to be hereditary in the family of Cantemir. On the approach of the Russian army the prince issued a proclamation containing the terms of the Russian protectorate and calling on the boiars and people to aid their Orthodox deliverers. But the long Turkish terrorism had done its work, and at the approach of a Turkish and Tatar host the greater part of the Moldavians deserted their voivode. The Russian campaign was unsuccessful, and all that Peter could offer Cantemir and the boiars who had stood by him was an asylum on Russian soil.

In his Russian exile Cantemir composed in a fair Latin style his *Descriptio Moldaviae*, the counterpart, as far as Moldavia is concerned, to Del Chiaro's contemporary description of Walachia. The capital of the country was now Jassy, to which city Stephen the Great had transferred his court from Suciava, the earlier residence of the voivodes. It had at this time forty churches—some of stone, some of wood. Fifty years before it had contained 12,000 houses, but Tatar devastations had reduced it to a third of its former size. The most important commercial emporium was the Danubian port of Galatz, which was frequented by vessels from the whole of the Levant from Trebizond to Barbary. The cargoes which they here took in consisted of Moldavian timber (oak, deal and cornel), grain, butter, honey and wax, salt and nitre. Kilia, at the north mouth of the Danube, was also frequented by trading vessels, including Venetian and Ragusan. Moldavian wine was exported to Poland, Russia, Transylvania, and Hungary; that of Cotnar was in Cantemir's opinion superior to Tokay. The excellence of the Moldavian horses is attested by a Turkish proverb; and annual droves of as many as 40,000 Moldavian oxen were sent across Poland to Danzig. Moldavia proper was divided into the upper country or *Terra de sus*, and the lower country, or *Terra de jos*. Bessarabia had been detached from the rest of the principality and placed under the direct control of the military authorities. It was divided into four provinces: that of Budzak, inhabited by the Nogai Tatars; that of Cetatea Alba, the Greek Monkastron, a strongly fortified place; and those of Ismaila and Kilia. The voivodes owed their nomination entirely to the Porte, and the great officers of the realm were appointed at their discretion. These were the

Great Logothete (*Marele Logofetu*) or chancellor; the governor of Lower Moldavia—*Vorniculul de l'erra de jos*; the governor of Upper Moldavia—*Vorniculul de l'erra de sus*; the *Halman* or commander-in-chief; the high chamberlain—*Marele Postelnicu*; the great *Spathar*, or sword-bearer; the great cup-bearer—*Marele Paharnicu*; and the treasurer, or *Vistiernicu*, who together formed the prince's council and were known as *Boiari de Sstatu*. Below these were a number of subordinate officers who acted as their assessors and were known as boiars of the Divan (*Boiari de Divanu*). The high court of justice was formed by the prince, metropolitan and boiars: the *Boiari de Sstatu* decided on the verdict; the metropolitan declared the law; and the prince pronounced sentence. The boiars were able to try minor cases in their own residences, but subject to the right of appeal to the prince's tribunal. Of the character of the Moldavian people Cantemir does not give a very favourable account. Their best points were their hospitality and, in Lower Moldavia, their valour. They cared little for letters, and were generally indolent, and their prejudice against mercantile pursuits left the commerce of the country in the hands of Armenians, Jews, Greeks and Turks. The pure-blood Ruman population, noble and plebeian, inhabited the cities and towns or larger villages; the peasantry were mostly of Little Russian and Hungarian race, and were in a servile condition. There was a considerable gipsy population, almost every boiar having several Zingar families in his possession; these were mostly smiths.

From this period onwards the character of the Ottoman domination in Moldavia is in every respect analogous to that of Walachia. The office of voivode or hospodar was farmed out by the Porte to a succession of wealthy Greeks from the Phanar quarter of Constantinople. All formality of election by the boiars was now dispensed with, and the princes received their *caftan* of office at Constantinople, where they were consecrated by the Greek patriarch. The system favoured Turkish extortion in two ways: the presence of the voivode's family connexions at Stambul gave the Porte so many hostages for his obedience; on the other hand the princes themselves could not rely on any support due to family influence in Moldavia itself. They were thus mere puppets of the Divan, and could be deposed and shifted with the same facility as so many pashas—an object of Turkish policy, as each change was a pretext for a new levy of bakshesh. The chief families that shared the office during this period were those of Mavrocordato, Ghica, Callimachi, Ypsilanti and Murusi. Although from the very conditions of their creation they regarded the country as a field for exploitations, they were themselves often men of education and ability, and unquestionably made some praiseworthy attempts to promote the general culture and well-being of their subjects. In this respect, even the Phanariote régime was preferable to mere pasha rule, while it had the further consequence of preserving intact the national form of administration and the historic offices of Moldavia. Gregory Ghica (1774-77), who himself spoke French and Italian, founded a school or "gymnasium" at Jassy, where Greek, Latin and theology were taught in a fashion. He encouraged the settlement of German Protestant colonists in the country, some of whom set up as watchmakers in Jassy, where they were further allowed to build an evangelical church. J. L. Carra, a Swiss who had been tutor to Prince Ghica's children, and who published in 1781 an account of the actual state of the principalities, speaks of some of the boiars as possessing a taste for French literature and even for the works of Voltaire, a tendency actively combated by the patriarch of Constantinople.

The Russo-Turkish War, which ended in the peace of Kutchuk Kalnadjik (1774), was fatal to the integrity of Moldavian territory. The house of Austria, which had already annexed Galicia in 1772, profited by the situation to arrange with both contending parties for the peaceful cession of Bukovina to the Habsburg monarchy. This richly wooded Moldavian province, containing Suciava

Continuation of Phanariote régime.

Cantemir's description of Moldavia.

Cession of Bukovina.

(Suczawa), the earliest seat of the voivodes, and Cernautil or Czernovitz, was in 1774 occupied by Habsburg troops with Russian connivance, and in 1777 Baron Thugut procured its formal cession from the sultan.

(4) *The Danubian Principalities: 1774-1859.*—By the treaty of Kutchuk Kainardji Russia consented to hand back the principalities to the sultan, but by Article xvi. *Kutchuk Kainardji* several stipulations were made in favour of the Walachians and Moldavians. The people of the principalities were to enjoy all the privileges that they had possessed under Mahomet IV.; they were to be freed from tribute for two years, as some compensation for the ruinous effects of the last war; they were to pay a moderate tribute; the agents of Walachia and Moldavia at Constantinople were to enjoy the rights of national representatives, and the Russian minister at the Porte should on occasion watch over the interests of the principalities. The stipulations of the treaty, though deficient in precision (the Walachians, for instance, had no authentic record of the privileges enjoyed under Mahomet IV.), formed the basis of future liberties in both principalities; but for the moment all reforms were postponed.

The treaty was hardly concluded when it was violated by the Porte, which refused to recognize the right of the Walachian boiars to elect their voivode, and nominated Alexander Ypsilanti, a creature of its own. In 1777 Constantine Murusi was made voivode of Moldavia in the same high-handed fashion. The Divan seemed intent on restoring the old system of government in its entirety, but in 1783 the Russian representative extracted from the sultan a decree (*hattisherif*) defining more precisely the liberties of the principalities and fixing the amount of the annual tribute—for Walachia 610 purses exclusive of various "presents" amounting to 130,000 piasters, and for Moldavia 135 purses and further gifts to the extent of 115,000 piasters. By the peace of Jassy in 1792 the Dniester was recognized as the Russian frontier, and the privileges of the principalities as specified in the *hattisherif* confirmed. In defiance of treaties, however, the Porte continued to change the hospodars almost yearly and to exact extraordinary installation presents. The revolt of Pasvan Oglu in Bulgaria was the cause of great injury to Walachia. The rebels ravaged Little Walachia in 1801-2, and their ravages were succeeded by those of the Turkish troops, who now swarmed over the country. Exaction followed exaction, and in 1802 Russia resolved to assert her treaty rights in favour of the oppressed inhabitants of the principalities. On the accession of Constantine Ypsilanti (1802-6) in Walachia, and of Alexander Murusi (1802-6) in Moldavia, the Porte was constrained to issue a new *hattisherif* by which every prince

Russian was to hold his office for at least seven years, unless the **protec-** Porte satisfied the Russian minister that there were good and sufficient grounds for his deposition. This clause of the *hattisherif* was not enforced. All irregular contributions were to cease, and all citizens, with the exception of the boiars and clergy, were to pay their share of the tribute. The Turkish troops then employed in the principalities were to be paid off, and one year's tribute remitted for the purpose. The boiars were to be responsible for the maintenance of schools, hospitals and roads; they and the prince together for the militia. The number of Turkish merchants resident in the country was limited. Finally, the hospodars were to be amenable to representations made to them by the Russian envoy at Constantinople, to whom was entrusted the task of watching over the Walachian and Moldavian liberties. This, it will be seen, was a veiled Russian protectorate.

In 1804 the Serbs under Karageorge rose against the Turkish dominion, and were secretly aided by the Walachian voivode Ypsilanti. The Porte, instigated by Napoleon's ambassador Sebastiani, resolved on Ypsilanti's deposition, but the hospodar succeeded in escaping to St Petersburg. In the war that now ensued between the Russians and the Turks, the Russians were for a time successful, and even demanded that the Russian territory should extend to the Danube. They occupied the principalities from 1806 to 1812. In 1808 they formed a

governing committee consisting of the metropolitan, another bishop, and four or five boiars under the presidency of General Kuskov. The seat of the president was at Jassy, and General Engelhart was appointed as vice-president at Bucharest. By the peace of Bucharest, however, in 1812, the principalities were restored to the sultan under the former conditions, with the exception of Bessarabia, which was ceded to the tsar. The Pruth thus became the Russian boundary.

The growing solidarity between the two Ruman principalities received a striking illustration in 1816, when the Walachian and Moldavian hospodars published together a code applicable to both countries, and which had been elaborated by a joint commission. The Greek movement was now beginning to assume a practical shape. About 1780 Riga Velestinul, a Hellenized Vlach from Macedonia who is also known by the purely Greek name of Rigas Pheroes, had founded in Bucharest a patriotic and revolutionary association known as the Society of Friends (*étairia tôn φίλων*) which gradually attained great influence. In 1810 Ignatius, the metropolitan of Walachia, founded a Greek literary society in Bucharest which soon developed into a political association, and many similar bodies were formed throughout the Greek world, and finally united into one powerful secret society, the Hetairia. Some of the members even cherished the fantastic hope of restoring the ancient Byzantine empire. In 1821 Alexander Ypsilanti, a son of the voivode, and an aide-de-camp of the tsar Alexander I., entered Moldavia at the head of the Hetaerists, and, representing that he had the support of the tsar, prevailed on the hospodar Michael Sutzto to aid him in invading the Ottoman dominions. To secure Walachian help, Ypsilanti advanced on Bucharest, but the prince, Theodore Vladimirescu, who represented the national Ruman reaction against the Phanariotes, repulsed his overtures with the remark "that his business was not to march against the Turks, but to clear the country of Phanariotes." Vladimirescu was slain by a Greek revolutionary agent, but Ypsilanti rashly continuing his enterprise after he had been repudiated by the Russian emperor, his forces were finally crushed by the Turks at Dragashani, in Walachia, and at Skuleni, in Moldavia; and the result of his revolt was a Turkish occupation of the principalities. In 1822 the Turkish troops, who had committed great excesses, were withdrawn on the combined representations of Russia, Austria and Great Britain. The country, however, was again ravaged by the retiring troops, quarters of Jassy and Bucharest burnt, and the complete evacuation delayed till 1824, when the British government again remonstrated with the Porte (see EASTERN QUESTION; GREECE; YPSILANTI; ALEXANDER).

By the convention of Akkerman between the Russians and the Turks in 1826 the privileges of the principalities were once more confirmed, and they were again ratified in 1829, under Russian guarantee, by the peace of Adrianople. **Peace of** By this peace all the towns on the left bank of the **Adria-** Danube were restored to the principalities, and the **nople,** **1829.**

The Porte undertook to refrain from fortifying any position on the Walachian side of the river. A Russian army occupied the country until the Porte fulfilled its promises. The principalities were to enjoy commercial freedom, and the right of establishing a quarantine cordon along the Danube or elsewhere. The internal constitution of the countries was to be regulated by an "Organic Law," which was drawn up by assemblies of bishops and boiars at Jassy and Bucharest, acting, however, under Russian control. The Organic Law thus elaborated was by no means of a liberal character, and amongst other abuses maintained the feudal privileges of the boiars. It was ratified by the Porte in 1834, and the Russian army of occupation thereupon withdrew. The newly elected hospodars, Alexander Ghica (1834-42) and George Bibescu (1842-48) in Walachia, and Michael Sturdza (1834-40) in Moldavia, ruled in accordance with the Organic Law. Their reigns were marked by the social, financial and political predominance of Russia, which had steadily increased since 1711. The treaty of 1774 had given Russia a firm foothold in Rumanian politics. This

The
"Hetaer-
ists"
move-
ment.

Peace of
Adria-
nople,
1829.

had been strengthened by the *kattisherif* of 1802; while the treaties of 1812, 1826 and 1829 had respectively yielded up Bessarabia, the Sulina mouth of the Danube and the St George mouth to the tsar. From 1834 to 1848 the Russian consul at Bucharest was all-powerful.

The revolutionary movement of 1848 extended from the Rumanians of Hungary and Transylvania to their kinsmen of the Transalpine regions. Here its real object was the overthrow of Russian influence. In Moldavia the agitation was mostly confined to the bojars, and the hospodar Michael Sturdza succeeded in arresting the ringleaders. In Walachia, however, the outbreak took a more violent form. The people assembled at Bucharest, and demanded a constitution. Prince Bibescu, after setting his signature to the constitution submitted to him, fled to Transylvania, and a provisional government was formed. The Turks, however, urged thereto by Russian diplomacy, crossed the Danube, and a joint Russo-Turkish dictatorship restored the Organic Law. By the Balta-Liman convention of 1849 the two governments agreed to the appointment of Barbu Stirbeiu (Stirbey) as prince of Walachia, and Gregory Ghica for Moldavia.

On the entry of the Russian troops into the principalities in 1853, the hospodars fled to Vienna, leaving the government in the hands of their ministers. During the Danubian campaign that now ensued great suffering was inflicted on the inhabitants, but in 1854 the cabinet of Vienna induced the Russians to withdraw. Austrian troops occupied the principalities, and the hospodars returned to their posts. One important consequence of the revolution had been the banishment of many rising politicians to western Europe, where they were brought into contact with a higher type of civilization. The practice initiated by the more liberal Phanariotes of sending Rumanian students to the French, German and Italian universities tended in the same direction. Statesmen such as I. C. Bratianu, D. A. Sturdza, S. I. Ghica, D. Ghica and Lascar Catargiu (whose biographies are given under separate headings) received their political training abroad, and returned to educate their countrymen. To this fact the surprisingly rapid progress of Rumania, as compared with the Balkan States, may very largely be attributed.

By the treaty of Paris in 1856 the principalities with their existing privileges were placed under the collective guarantee of the contracting Powers, while remaining under the suzerainty of the Porte—the Porte on its part engaging to respect the complete independence of their internal administration. A strip of southern Bessarabia was returned to Moldavia, so as to push back the Russian frontier from the Danube mouth. The existing laws and statutes of both principalities were to be revised by a European Commission, sitting at Bucharest, and their work was to be assisted by a Divan or national council which the Porte was to convoke for the purpose in each of the two provinces, and in which all classes of Walachian and Moldavian society were to be represented. The European commission, arriving at its conclusions, was to take into consideration the opinion expressed by the representative councils; the Powers were to come to terms with the Porte as to the recommendations of the commission; and the final result was to be embodied in a *kattisherif* of the sultan, which was to lay down the definitive organization of the two principalities. In 1857 the commission arrived, and the representative councils of the two peoples were convoked. On their meeting in September

they at once proceeded to vote with unanimity the union of the two principalities into a single state under the name of Romania (Rumania), to be governed by a foreign prince elected from one of the reigning dynasties of Europe, and having a single representative assembly. The Powers decided to undo the work of national union. By the convention concluded by the European congress at Paris in 1858, it was decided that the principalities should continue as heretofore to be governed each by its own prince. Walachia and Moldavia were to have separate assemblies, but a central

commission was to be established at Fokshani for the preparation of laws of common interest, which were afterwards to be submitted to the respective assemblies. In accordance with this convention the deputies of Moldavia and Walachia met in separate assemblies at Bucharest and Jassy, but the choice of both fell unanimously on Prince Alexander John Cuza (January 1859).

(5) *Rumania*.—Thus the union of the Rumanian nation was accomplished. A new conference met in Paris to discuss the situation, and in 1861 the election of Prince Cuza was ratified by the Powers and the Porte. The two assemblies and the central commission were preserved till 1862, when a single assembly met at Bucharest and a single ministry was formed for the two countries. The central commission was at the same time abolished, and a council of state charged with preparing bills substituted for it. In May 1864, owing to difficulties between the government and the general assembly, the assembly was dissolved, and a statute was submitted to universal suffrage giving greater authority to the prince, and creating two chambers (of senators and of deputies). The franchise was now extended to all citizens, a cumulative voting power being reserved, however, for property, and the peasantry were emancipated from forced labour. Up to this point the prince had ruled wisely; he had founded the universities of Bucharest and Jassy; his reforms had swept away the last vestiges of feudalism and created a class of peasant freeholders. But the closing years of his reign were marked by an attempt to concentrate all power in his own hands. He strove to realize his democratic ideals by despotic methods. His very reforms alienated the goodwill of all classes; of the nobles, by the abolition of forced labour; of the clergy, by the confiscation of monastic estates; of the masses, by the introduction of a tobacco monopoly and the inevitable collapse of the inflated hopes to which his agrarian reforms had given rise. His own dissolute conduct increased his unpopularity, and at last the leading statesmen in both provinces, who had long believed that the national welfare demanded the election of a foreign prince, conspired to dethrone him. In February 1866 he was compelled to abdicate; and a council of regency was formed under the presidency of Prince Ion Ghica. The count of Flanders, brother to the king of the Belgians, was proclaimed hospodar of the united provinces, but declined the proffered honour.

Meanwhile a conference of the Powers assembled at Paris and decided by a majority of four to three that the new hospodar should be a native of the country. The principalities, however, determined to elect Prince Charles, the second son of Prince Charles Antony of Hohenzollern-Sigmaringen. On a referendum, 685,969 electors voted in his favour, against 224 dissentients. Prince Charles was an officer in the Prussian army, twenty-seven years of age, and was related to the French imperial family as well as to the royal house of Prussia: his nomination obtained not only the tacit consent and approval of his friend and kinsman King William of Prussia, but also the warm and more open support of Napoleon III. The king of Prussia, however, had agreed that the new hospodar should be a native of the principalities, and could not therefore openly approve of Prince Charles's election. Acting on the advice of Bismarck, the prince asked for a short leave of absence, resigned his commission in the Prussian army on crossing the frontier, and hastened down the Danube to Rumania, under a feigned name and with a false passport. On the 20th of May he landed at Turnu Severin, where he was enthusiastically welcomed. He reached Bucharest on the 22nd, and on the same day, in the presence of the provisional government, took the oaths to respect the laws of the country and to maintain its rights and the integrity of its territory. In October Prince Charles proceeded to Constantinople and was cordially received by his suzerain, the sultan, who bestowed on him the firman of investiture, admitted the principle of hereditary succession in his family, and allowed him the right of maintaining an army of 30,000

Movement of 1848.

Russian and Austrian occupation, 1853-54.

Treaty of Paris, 1856.

Union of the principalities.

Prince Cuza, 1859-66.

Election of Prince Charles, 1866.

men. Rumania was to remain part of the Ottoman empire within the limits fixed by the capitulations and the treaty of Paris.

The first Rumanian ministry formed under the new prince was composed of the leading statesmen of all political parties,

Foreign and domestic politics, 1866-70. care being taken that the two provinces should be equally represented. A new constitution was unanimously passed by the chamber on the 11th of July.

It provided for an Upper and Lower House of Representatives, and conferred on the prince the right of an absolute and unconditional veto on all legislation. Other reforms were urgently needed. There was an empty treasury, and the floating debt amounted to £7,000,000; maladministration was rampant in every department of the state; the national guard was mutinous, while the small army of regulars was badly organized and inefficient. The existence of famine and cholera added to the difficulties of the government, and in March 1867 the Lower House, by a majority of three, passed the laconic resolution, "The chamber inflicts a vote of blame on the government." As the result of this vote M. Kretzulescu, a Moderate Conservative, was called to the head of affairs, and I. C. Bratianu entered the government as minister of the interior. The new ministry, of which Bratianu was the leading spirit, showed considerable energy: a concession was granted for the construction of the first Rumanian railway, from Bucharest to Giurgevo, and the reorganization of the army was undertaken. Among other less judicious measures, a decree was passed ostensibly directed against all vagabond foreigners, but really aimed at the Jews, large numbers of whom, including many respected landowners and men of business, were imprisoned, or expelled, from Jassy, Bacau and other parts of Moldavia. This harsh treatment created intense indignation abroad, especially in France and Great Britain; and the emperor Napoleon wrote personally to Prince Charles, protesting against the persecution. The country could not afford to lose the goodwill of the emperor of the French, at that time one of the most powerful factors in Europe—in July 1869 Bratianu, although immensely popular, found it necessary to resign office, and with him fell the rest of the cabinet.

On the 15th of September 1869, Prince Charles married Princess Elizabeth of Wied, afterwards celebrated under her literary name of *Carmen Sylva*.¹ In the same year the army was reorganized, and a rural police created. Every able-bodied citizen was rendered liable to give three days' work yearly towards the construction of roads, or to pay a small tax as an equivalent. An important railway concession, which subsequently caused grave political complications, was granted to the German contractors Strausberg and Offenheim.

Much excitement was aroused in Rumania by the outbreak of the war between Prussia and France. The sympathies of the Rumanians were entirely on the side of the French, whom they regarded as a kindred Latin race, while those of the prince were naturally with his native country. The excitement culminated in a revolutionary outbreak at Ploesti, where a hot-headed deputy, Candianu Popescu, after the mob had stormed the militia barracks, issued a proclamation deposing Prince Charles and appointing General Golescu regent. Owing to the loyalty of the regular army the insurrection was speedily quelled. But the feeling in the country was strong against the German sovereign, who seriously thought of abdicating when a jury acquitted the accused rebels. On the 7th of December he wrote confidentially to the sovereigns whose representatives had signed the treaty of Paris, suggesting that the future of Rumania should be regulated by a European congress.

A few days subsequently the prince learned that the German railway contractor Strausberg was unwilling or unable to pay the coupons of the railway bonds due on the 1st of January 1871, which were mostly held by influential people in Germany. This threw the responsibility of payment on Rumania, and was a severe blow to the prince,

¹For biographical details, see CHARLES, king of Rumania; and ELIZABETH, queen of Rumania.

through whose instrumentality the loan had been placed. Matters were brought to a crisis by the Prussian government threatening to force the Rumanian government to provide for the unpaid coupons. The country was financially in no condition to comply. Bitter indignation prevailed against everything German, and culminated in an attack on the German colony in Bucharest on the 22nd of March 1871. On the following morning the prince summoned the members of the council of regency of 1866, and informed them of his intention to place the government in their hands. Lascar Catargiu and General Golescu, the only two members present, as well as Dimitrie Sturdza and other influential persons, declined to accept the responsibility. Catargiu offered to unite the different sections of the Conservative party in order to deal with the crisis. The prince accepted his offer. The elections took place early in May 1871, and the government, to which all the most respectable elements in the country had rallied, obtained a large majority. When parliament met in May the prince had a most enthusiastic reception. The anti-German feeling in the country had greatly subsided, in consequence of the crushing defeat of France; and in January 1872 the chambers passed a law by which Rumania undertook to pay the railway coupons. The German syndicate was satisfied, and the railway crisis ended.

Catargiu's ministry was the tenth that had held office in the five years since the prince's arrival, but it was the first one that was stable. In March 1875 the budget for 1876, amounting to £4,000,000, nearly double in amount that of the year 1866, was passed without difficulty, and on the 28th of the month the parliamentary session closed. It was the first occasion in Rumania that the same chamber had sat for the whole constitutional period of four years, and also the first time that the same ministry had opened and closed the same parliament.

Only the fall of the Catargiu ministry saved the country from revolution. The leading Liberals had promoted a conspiracy for the arrest and expulsion of the prince, and the formation of a provisional government under General Dabija. The prospect of a return to power put an end to these machinations. Catargiu's ministry was succeeded by an administration under General Florescu, known as the "cabinet of the generals," and, a month later, by the so-called "ministry of conciliation" under M. Jepureanu. A commission of the chambers drew up an indictment against Catargiu and his late colleagues, accusing them of violating the constitution and the public liberties, squandering the state revenues, and other abuse of power. Unable to stem the tide of popular passion, which was crying for the impeachment of Catargiu, Jepureanu resigned office, and Bratianu formed a new Liberal cabinet, destined to guide the country through many eventful years.

But the re-opening of the Eastern Question was destined to bring to a climax the great struggle of Rumania for existence and independence, and temporarily to throw into the shade all domestic questions. The insurrection in Bulgaria, with its accompanying horrors, followed by the deposition of sultan Murad and the succession of the sultan Abdul Hamid, contributed to indicate the near approach of a Russo-Turkish war. Russia had shown symptoms of anger against Rumania for not having taken up a decided attitude in the approaching struggle, and the Russian ambassador Ignatiev had some months previously threatened that his government would seize Rumania as a pledge as soon as the Turks occupied Servia and Montenegro. Prince Charles decided to send a mission, composed of Bratianu and Colonel Slaniceanu (the minister of war), to the imperial headquarters at Livadia. They were well received by the emperor (October 1876), but in spite of mixed threats and cajoleries on the part of Gorchakov, Ignatiev and others, Bratianu returned without having definitively committed his country to active measures.

On the 14th of November six Russian army corps were mobilized to form the army of the south under the grand duke

The Catargiu ministry, 1871-75.

The Russo-Turkish War of 1877-78.

Nicholas. A few days later two secret envoys arrived at Bucharest, the one M. de Nelidov, to negotiate on the part of the Russian government for the passage of their army through Rumania, the other Ali Bey, to arrange on behalf of the sultan a combination with Rumania against Russia. Prince Charles cleverly temporized with both powers. Negotiations with Russia were continued, and Bratianu was sent to Constantinople to put pressure upon Turkey to secure certain rights and privileges which would practically have made Rumania independent, except that it would still have paid a fixed tribute; but the conference of the powers assembled at that capital came to a definite end on the 10th of January 1877, when the Turkish government declined every proposal of the conference. Meanwhile the Porte, in issuing Midhat Pasha's famous scheme of reforms, had greatly irritated Rumanian politicians by including their country in the same category as the other privileged provinces, and designating its inhabitants as Ottoman subjects. A secret convention was signed between Russia and Rumania on the 16th of April, by which Rumania allowed free passage to the Russian armies, the tsar engaging in return to maintain its political rights and to protect its integrity, while all matters of detail connected with the passage of the Russian troops were to be regulated by a special treaty. On the 23rd of April Russia declared war against Turkey, and the grand duke Nicholas issued a proclamation to the Rumanian nation, announcing his intention of entering their territory in the hope of finding the same welcome as in former wars. The Rumanian government made a platonc protest against the crossing of the frontier, and the Rumanian troops fell back as the Russians advanced; provisions and stores of all kinds were supplied to the invading army against cash payments in gold, and the railways and telegraphs were freely placed at its disposal. The Rumanian chambers were assembled on the 26th of April, and the convention with Russia was sanctioned. The Ottoman government immediately broke off diplomatic relations with Rumania, and on the 11th of May the chambers passed a resolution that a state of war existed with Turkey. (For a detailed account of the subsequent campaign, in which Prince Charles and the Rumanian army contributed greatly to the success of the Russian arms, see *RUSO-TURKISH WARS, and PLEVNA*.) The fall of Plevna left the Russian army free to march on Constantinople, and on the 31st of January 1878 the preliminaries of peace were signed at Adrianople. They stipulated that Rumania should be independent and receive an increase of territory.

Peace between Russia and Turkey was signed at San Stefano on the 3rd of March. On the 29th of January the Rumanian agent at St Petersburg was officially informed of the intention of the Russian government to regain possession of the Rumanian portion of Bessarabia, *i.e.* that portion which was ceded to Moldavia by Russia after the Crimean War. Rumania was to be indemnified at the expense of Turkey by the delta of the Danube and the Dobrudja as far as Constantza. The motive assigned was that this territory had not been ceded to Rumania, but to Moldavia, and had been separated from Russia by the almost obsolete treaty of Paris (1856). But the proposed exchange of territory aroused the most bitter indignation at Bucharest. Bratianu and Cogălniceanu were sent to Berlin to endeavour to prevail on the representatives of the Powers there assembled in June 1878 to veto the cession of Bessarabia to Russia; but the Rumanian delegates were not permitted to attend the sittings of the congress until the Powers had decided in favour of the Russian claim. The treaty of Berlin in dealing with Rumania decided to recognize its independence, subject to two conditions: First (Art. xlv.), that the principality should restore to the emperor of Russia that portion of the Bessarabian territory detached from Russia by the treaty of Paris in 1856, bounded on the west by the mid-channel of the Pruth, and on the south by the mid-channel of the Kilia branch and the Staryi Stambul mouth. Second (Art. xlv.), that absolute freedom of worship should be granted to all persons in Rumania;

that no religious beliefs should be a bar to the enjoyment of any political rights; and, further, that the subjects of all the powers should be treated in Rumania on a footing of perfect equality. Article xlv. declared that the islands forming the delta of the Danube, the Isle of Serpents, and the province of Dobrudja, as far as a line starting from the east of Silistria and terminating on the Black Sea south of Mangalia, should be added to Rumania. Other articles defined the international position of Rumania, while Article liii. decreed that it should have a representative on the European commission of the Danube. Bratianu wrote with some truth that the Great Powers by sacrificing Rumania were able to obtain more concessions for themselves from Russia, and Lord Beaconsfield was constrained to admit that "in politics ingratitude is often the reward of the greatest services." The Rumanians submitted reluctantly to the retrocession of Bessarabia; and the Dobrudja was occupied by Rumanian troops on the 26th of November 1878.

But Article xlv. of the treaty of Berlin caused tremendous agitation throughout the country, and almost provoked a revolution. Article vii. of the constitution of 1866 laid **2. The Jewish question.** down that "only Christians can become citizens of Rumania"—in other words, all Jews were excluded from the rights of citizenship; and as no foreigner could own land in Rumania outside the towns, no Jew could become a country proprietor. Public opinion in Rumania rendered it almost impossible for any government to carry out the wishes of the Berlin tribunal. To do so involved a change in the constitution, which could only be effected by a specially elected constituent assembly. This body met on the 3rd of June, and sat through the entire summer. The irritation of the powers at the unexpected delay was so great that Great Britain proposed a collective note on the subject, to be executed by the Austrian cabinet; while Prince Bismarck threatened, if the Berlin proposition were not carried out, to refer to the suzerain power at Constantinople. At last, however, on the 18th of October, Article vii. was repealed, and it thus became possible for Rumanian Jews to become naturalized and to hold land. It was further decided to admit to naturalization the 883 Jewish soldiers who had served in the war; but with all other Jews individual naturalization was required, and this was hedged about by so many difficulties, a special vote of the legislature being required, with a two-thirds majority in each individual case, that although the compromise thus effected was accepted by the powers, the actual result was that, from 1880 to 1884, out of 385 persons who were naturalized in Rumania, only 71 were Rumanian Jews. As the process of naturalization has never been accelerated, the 300,000 Jews said to inhabit Rumania are still regarded as foreigners; and although liable to military service and to the payment of taxes, are unable to own rural land or possess electoral or other civil rights.

Italy was the first of the Powers to notify its recognition of Rumanian independence (December 1870); but Bismarck succeeded in prevailing on the Western Powers not **3. Establishment of the Rumanian kingdom.** to give official recognition until Rumania should have purchased the railways from their German owners. This unpopular measure caused some delay; but Great Britain, France and Germany formally recognized the independence of the country on the 20th of February 1880. Early in 1881 it was generally felt that the time had arrived for Rumania to be created a kingdom. On the 13th of March the tsar Alexander II. was assassinated, and the Rumanian opposition chose this occasion to accuse the Liberal government of aiming at republican and anti-dynastic ideals. To refute this charge, the ministry proposed the elevation of the Rumanian principality into the kingdom of Rumania. The prince accepted the resolution; within ten days the new kingdom was recognized by all the Great Powers, and the coronation took place at Bucharest on the 22nd of May 1881. The royal crown was constructed of steel made from Turkish cannon captured at Plevna.

Rumania was now comparatively, but not entirely, free from fears of serious foreign complications. Austria and Russia alike resented the decision to fortify Bucharest and the Sereth line, adopted by the Rumanian government in 1882. Relations with Russia had remained strained ever since the war. The delimitation of the Dobruđa frontier was still unsettled, and owing to Russian opposition was not finally disposed of till 1884. Expenses incurred during the war led to much controversy, especially when the Russian government claimed the return of £120,000 advanced to enable the Rumanians to mobilize, and considered by them as a free gift. A compromise was made, both parties withdrawing their claims, in April 1882.

Relations with Austria-Hungary were also on a very unpleasant footing. There were two principal subjects of discord—the navigation of the Danube (*q.v.*) and the "national question," *i.e.* the status of the Vlach communities outside Rumania, and especially in Transylvania and Macedonia (see VLACHS and MACEDONIA). The Danube question became acute in 1881, 1883 and 1890; the national question is a more permanent source of trouble, affecting Austria-Hungary, Greece, Turkey and Bulgaria. King Charles, who naturally favoured the ally of Germany, and Bratianu, who regarded Russian policy with suspicion, endeavoured to promote a better understanding with Austria-Hungary. But there was a strong anti-German party in the country, especially among the old boiars and the peasantry. Community of creed, ancient traditional influence, the entire absence of Russian merchants, and the consequent avoidance of many small commercial rivalries, contributed to bring about a sort of passive preference for Russia, while the bitter disputes that had occurred with Germany on the question of railway finance had left a very hostile feeling.

In March 1883 the government decided to introduce various important changes into the constitution. Three electoral colleges were formed instead of four; a considerable addition was made to the numbers of the senate and chamber; trial by jury was established for press offences, except those committed against the royal family and the sovereigns of foreign states; these were to be tried by the ordinary tribunals without jury. A bill was passed endowing the crown with state lands, giving an annual rent of £24,000 in addition to the civil list fixed in 1866 at £40,000; another measure granted free passes on the railways and an allowance of £1 daily during the sitting of parliament to all senators and deputies. The revision of the constitution had estranged the two heads of the Liberal party, I. C. Bratianu, who was mainly responsible for the new measures, and C. A. Rosetti, who unsuccessfully advocated reforms of a far more democratic character. These two had been united by a most intimate friendship. One had never acted without the other. Rosetti was said to be the soul whilst Bratianu was the voice of the same personality. Henceforward Bratianu had sole control of the Liberal government. The revising chambers having fulfilled their special mandate, were dissolved in September 1884, and a new parliament assembled in November, the government, as usual, obtaining a large majority in both houses.

Since 1876 Bratianu had exercised an almost dictatorial power, and anything like a powerful parliamentary opposition had ceased to exist. But he had been too long in power; the numerous state departments were exclusively filled with his nominees; and some pecuniary scandals, in which the minister of war and other high officials were implicated, helped to augment his fast-growing unpopularity. New parties were formed in opposition, and the National Liberal and Liberal-Conservative parties combined to attack him. The first of these maintained that the government should be essentially Rumanian, and, while maintaining friendly relations with foreign Powers, should in no wise allow them to interfere with internal affairs. They also advocated reduction of expenditure and the inde-

pendence of the magistracy. The Liberal-Conservatives held generally the same views, but had as their ideal of foreign policy a guaranteed neutrality. Another party which now attracted considerable attention was that of the Junimists, or Young Conservatives. The name was taken from the Junimea, a literary society formed in Jassy in 1874 by P. Carp, T. Rosetti, and Maiorescu, and transformed into a political association in 1881. Their programme for home affairs involved the amelioration of the position of the peasantry and artisan classes, whose progress they considered had been overlooked, the irremovability of the magistracy, and a revision of the communal law in the sense of decentralization. In financial matters they advocated the introduction of a gold standard and the removal of the agio on gold, also the introduction of foreign capital to develop industries in the country; and as regards foreign policy, they were strong advocates of intimate and friendly relations with Austria-Hungary. Elections for a new chamber took place in February 1888, and the whole of the leaders of the opposition were elected, including Dimitrie Bratianu, the premier's brother, and Lascar Catargiu. I. C. Bratianu definitely retired on the 4th of April, after having held the premiership for twelve eventful years. Had he continued much longer in office it is probable that there would have been a revolutionary movement against the dynasty. During the previous parliament a Conservative manifesto, signed by Catargiu, D. Bratianu and other leaders of the opposition, openly threatened that if the ministers were not removed before the general election, the responsibility would be thrown, "not on those who served the crown, but on him who bore it"; and the name of Prince George Bibescu had been openly mentioned as a possible successor.

In the new chamber elected in October 1888 only five members of Bratianu's party retained their seats. The most prominent statesman in the new Conservative-Junimist administration was P. Carp, who in the spring of 1889 succeeded in passing a bill which authorized the distribution of state lands among the peasantry. Despite this admirable measure, he was unable to retain office, and three changes of ministry followed. The Conservative-Junimist parliament nevertheless restored tranquility to the country. On the 22nd of May 1891, the 25th anniversary of the king's accession was celebrated with great enthusiasm. Meanwhile the gold standard had been introduced (1889), and the financial situation was regarded as satisfactory. In December 1891 a stable cabinet was at last formed by Lascar Catargiu. The new ministry during their four years' tenure of office passed several useful measures through parliament. The state credit was improved by the conversion of the public debt; the sale of the state lands to the peasantry was actively continued; a law was passed making irremovable the judges of the court of appeal and the presidents of tribunals, and other important judicial reforms were carried out; a mining law was passed with the object of introducing foreign capital; and the commercial marine was developed by the formation of a state ocean service of passenger and cargo steamers. Great reforms, which had been unsuccessfully attempted by former governments, were made in the service of public instruction and in the organization of the clergy. In 1893 and 1894 commercial and extradition treaties and a trade-mark convention were made with Great Britain, Austria-Hungary and Germany. Meanwhile the Liberal opposition was being reorganized. On the death of I. C. Bratianu, in 1891, his brother Dimitrie was proclaimed chief of the united Liberal party, but he also died in June 1892, and the veteran statesman Dimitrie Sturdza was recognized as the head of the Liberals. In 1894 he started a very violent agitation in favour of the Rumanians in Hungary. Another popular opposition cry was "Rumania for the Rumanians." The new mining law, among other concessions, gave foreigners the right to lease lands for long periods for the working of petroleum, and this was denounced by the opposition as being hostile to national interests, and also as being against the spirit of the constitution,

The Conservative-Junimist conflict, 1888-95.

which prohibited foreigners from holding lands. The bill was carried by the government in April 1895, as well as another important measure favouring the construction of local railways by private contractors. The Liberal opposition protested, retired from the chamber, and took no further part in legislative proceedings. The Liberal party had been out of office for eight years, the Conservative-Junimist coalition had practically carried out its complete programme, and legislation was at a deadlock owing to the abstention of the Liberal opposition. As the electorate showed itself in favour of a change of ministry, Catargiu resigned, and a new Liberal government was formed by D. Sturdza.

The advent to power of a statesman who had recently been making such violent attacks on the Hungarian government caused some anxiety in Austria-Hungary. When once office was obtained, it was to the interest of the new government that the agitation should subside.

The official opening by the emperor of Austria of the new channel through the Iron Gates of the Danube, on the 27th of September 1896, was the means of bringing about a great improvement in the relations between the two countries. It led to an exchange of visits between the emperor and King Charles, who also visited the tsar Nicholas II. in August 1898. The visit was the symbol of a reconciliation between the Rumanians and the Russians, the relations between whom had been the reverse of cordial since 1878. As regards home politics, the overwhelming majority of the Liberal party at the elections of 1895, instead of being a source of strength, proved the very reverse. It caused the party to split up into factions—Sturdzists, Aurelianists and Flevists, so called after the names of their respective chiefs. Sturdza himself soon had to retire. The head of the Orthodox Church, the metropolitan Gennadius, had for some years past, as head of the philanthropic establishments founded by the princess Brancovan, desired to obtain the entire management of these wealthy foundations, and had made violent attacks on the two administrators, Prince George Bibescu and Prince Stirbei, both members of the Brancovan family. In the quarrel that ensued the prelate was openly accused of simony, of heresy, and other matters more suitable for a criminal court. After a public trial before the Holy Synod, he was found guilty of certain canonical offences, and sentenced to be deposed. The same night, he was seized by the police, and removed by force to a neighbouring monastery. This harsh treatment of the head of the Church led to an attack on Sturdza. On the 3rd of December 1896, the president of the council, M. Aurelian, was called on to reconstitute a Liberal cabinet, with the principal object of calming public opinion by the settlement of this question. Aurelian then appealed to the patriotic sentiments of the Conservative party to help to solve the difficulty, and with the aid of Lascar Catargiu and Tache Ionescu the following decision was reached: the Holy Synod was to reverse its judgment, and the metropolitan was to be restored to his ecclesiastical rank; but, after holding it for a few days, he was voluntarily to resign and to receive as compensation a handsome pension. Calm was thus restored, but Aurelian and his colleagues were not inclined to hand over their portfolios to Sturdza and his partisans. The struggle terminated in the success of Sturdza, who in April 1897 returned to power and remained president of the council until 1899. Few of the important measures promised in the Liberal programme were passed, one for the reform of public instruction being the most noteworthy. Sturdza's government, which had risen to power mainly on the national question, was also destined to fall on it. A popular agitation was raised on the subject of certain subsidies made by the Rumanians for the support of the Rumanian schools at Kronstadt in Transylvania, and Sturdza was accused of too great subservience to the Hungarian government. The agitation culminated in street riots at Bucharest. On the same evening that Sturdza tendered his resignation to the king (April 1899) the veteran Conservative statesman Lascar Catargiu suddenly died.

The Conservatives, led by G. G. Cantacuzene, returned to

office with an overwhelming majority. They were immediately confronted by an acute economic crisis. The financial position of the country had hitherto on the surface been very satisfactory. The public debt, mostly placed in Germany, amounted to about £51,000,000. The interest had been regularly paid. But the facility with which money had always been borrowed gave rise to great extravagance. Expenses which ought to have been defrayed out of the ordinary budget, such as the erection of magnificent public offices at Bucharest, were frequently defrayed out of the loans; and the custom had arisen when money was scarce of issuing treasury bonds. When the Conservatives came into office they found that the payment of 2½ millions of these bonds would shortly become due, and there were no resources in the treasury to meet them. Owing to the Transvaal War and other causes, the money market was most unfavourable, especially in Germany; and there was an almost entire failure of the harvest. The value of cereals exported in 1898 was about 9 millions sterling, in 1899 only 3½ millions. The government managed to extricate itself from its immediate difficulties in the autumn of 1899, by raising a loan of £7,000,000 in Berlin, but on very stringent terms. Besides paying a much higher rate of interest than heretofore, it bound itself not to contract any further loans until this one was paid. The Conservatives were united in wishing to meet the financial crisis by a moderate reduction of expenditure and a large increase of taxation, while the Liberal opposition advocated the permanent reduction of the annual expenditure of £800,000, which would necessitate the raising of £200,000 only by fresh taxation. The Conservative programme was naturally unpopular; Carp and the Junimists were unwilling to co-operate with the government, and, on the 26th of February 1901, D. Sturdza again became premier.

His administration lasted until the 31st of December 1904, and averted the impending bankruptcy of Rumania by a policy of strict retrenchment. In 1904 Sturdza was able to exceed the proposed limit of annual expenditure, £8,740,000, owing to a great increase in the value of the tobacco monopoly. Even a recurrence of agricultural depression during the same year left the national credit intact. Another financial reform was undertaken by the Conservatives, who returned to power on the 4th of January 1905, with G. G. Cantacuzene as prime minister, and in May floated the conversion loan, already described.

The chief causes of the agrarian insurrection in March 1907 have been outlined above (under *Land Tenure*). But an additional cause was the harsh treatment of the Agrarian peasants on the state and communal lands leased to Jewish middlemen. At first an attack on the Jews alone, the rising soon became a *jacquerie* directed against all the large landowners. Numerous towns and villages were sacked and partly burned, and 140,000 soldiers were employed to suppress the revolt. On the 24th of March the Cantacuzene ministry resigned and was succeeded by a Liberal government under the leadership of D. Sturdza, who completed the restoration of order by strong military measures and afterwards initiated remedial legislation. He abolished the system by which public lands were leased to middlemen, reduced the land tax on small holdings, and granted new facilities for obtaining credit to the peasants. After a general election in June 1907, Sturdza remained in office with an overwhelming majority. To meet the cost of agrarian reform, and of the reorganization of the army (1908), he introduced various fiscal changes, notably an alteration in the budget system, by which the total revenue and expenditure were shown for the first time (see *Finance*, above).

Rumania was little affected by the political changes in the Balkan Peninsula (1908-10) coincident with the Turkish revolution, the annexation of Bosnia and Herzegovina by the Dual Monarchy, the proclamation of Bulgarian independence and the erection of Montenegro into a kingdom. South of the Danube its chief political interest centred in the Kutzo-Vlach communities in Macedonia, which were the object of a Panhellenic

The financial crisis of 1899. 1901.

Financial reform, 1901-5.

Agrarian rising of 1907.

Rumania and the Macedonian question.

propaganda most offensive to Rumanian nationalism. An *trade* of the sultan Abdul Hamid had in 1906 recognized the existence of the Kutzo-Vlachs as a religious body (*millet*), forming an integral part of the Rumanian Church. This decision was regarded by the Greeks as a blow to their own interests, and Greek, revolutionary bands were accused of persecuting the Kutzo-Vlachs. (See also MACEDONIA.) Even before 1906 there was keen rivalry between Greece and Rumania, and the "Macedonian question" was the underlying cause of the disputes which, arising ostensibly from quite trivial causes, led temporarily to the rupture of diplomatic relations between Greece and Rumania in 1905, 1906 and 1910.

BIBLIOGRAPHY.—No scientific history of Rumania was published up to the 20th century, but the task of collecting and editing original documents was partially carried out by the Rumanian Academy and by private students, especially after 1880. The so-called *Chronicle of Hurul* is a modern forgery, and up to the 14th century the only valid authorities are Slavonic, Hungarian and Byzantine chroniclers. Thereafter a great mass of material is available. It is partly incorporated in the yearly *Annales* of the Academy, 2nd series, from 1880; and in the 30 volumes of E. de Hurmuzaki's *Documente privitoare la istoria Românilor* (Bucharest, 1876, &c.). Other important original documents, or works containing such documents, are Verantius's 16th-century *De situ Transylvaniae, Moldaviae, et Transalpiniae*, in Kovachich's *Scriptores rerum Hungaricarum minores* (Budapest, 1798); G. Urechia's late 16th-century *Chronique de Moldavie*, ed. J. Picot (Paris, 1878); Rumanian text in Old Slavonic characters, with French translation and notes of great value; the 17th-century *Opere Complete* of Miron Costiu, ed. V. A. Urechia (Bucharest, 1886); A. M. del Chiaro, *Istoria delle moderne rivoluzioni della Valachia con la descrizione del paese* (Venice, 1878); the early 18th-century *Operele principului D. Cantemir*, issued by the Academy (Bucharest, 1872, &c.); N. Iorga, *Acte și fragmente cu privire la istoria Românilor* (Bucharest, 1895-97); M. Kogălniceanu, *Cronicele Românilor* (Bucharest, 1872-74); J. L. Carra, *Histoire de Moldavie et de Valachie, avec une dissertation sur l'état actuel de ces deux Provinces* (Jassy, 1777); A. M. Blanc de Lanautte, *Mémoire sur l'état ancien et actuel de la Moldavie, présenté à S.A.S. le prince A. Ypsilanti en 1787* (Bucharest, 1902); D. A. Sturdza, *Acte și documente relative la istoria renașterii Românilor* (Bucharest, 1903, &c.); *ibid.*, *Acte și documente relative la istoria Bizanșiană* (Bucharest, 1903, &c.). On the Phanariote period see P. Eliade, *De l'influence française sur l'esprit public en Roumanie. Les origines. Étude sur l'état de la société roumaine à l'époque des régnes phanariotes* (Paris, 1898). For a general history of Rumania, see V. A. Urechia, *Istoria Românilor* (Bucharest, 1891, &c., 8 vols.); A. D. Xenopol, *Istoria Românilor din Dacia Traiană* (Jassy, 1888-93, 6 vols.—abridged French edition entitled *Histoire des Roumains*, 2 vols., Paris, 1896); and F. Negulescu, *Histoire du droit et des institutions de la Roumanie* (Paris, 1898). Sketches of Rumanian history are given in A. Sturdza, *La terre et les races roumaines* (Paris, 1905); and W. Miller, *The Balkans* (London, 1896). For a comprehensive bibliography of Rumanian history, see N. Iorga's introduction to vol. x of the Hurmuzaki collection; vol. xiii of the *Annales*; *Bibliografia Românească veche 1508-1830*, by C. Bianu and H. Hodos (Bucharest, 1903, &c.); and D. Onciul, *Originile principatelor române* (Bucharest, 1898). (H. TR. X.)

LANGUAGE

Rumanian¹ is, geographically, an isolated eastern member of the group of Romance languages (*q.v.*), being severed from all the rest by countries in which the predominant speech is Slavonic or Magyar. It represents the original rustic Latin of the Roman provincials in Moesia and Dacia, as modified by centuries of alien rule. Structurally, its Latin characteristics have been well preserved; but its vocabulary has undergone great changes, becoming so far Slavonized that the ratio of words of Slavonic origin to words of Latin origin is approximately as three to two; large numbers of loan-words have also been added from Turkish, Greek, Magyar and other sources. It is noteworthy, however, that where Latin words have survived they are sometimes purer than in the Romance languages of the West.

¹I.e. the so-called Daco-Rumanian, spoken by the vast majority of Rumanians over the whole of Rumania, in Transylvania, Bukovina, the Banat, Bessarabia, and some districts of Servia and Bulgaria bordering on the Danube. The two most important dialects are the Istro-Rumanian, spoken in part of Istria but rapidly becoming extinct, and the Macedo-Rumanian, spoken by the Kutzo-Vlachs (see VLACHS). The Istro-Rumanian forms, as it were, a link—now completely severed—between the Romance of the East and the Romance of the West. In the Macedo-Rumanian there are no Magyar loan-words, but there is a large Albanian element, and Greek loan-words are more numerous than Slavonic.

(e.g. Lat. *domina* is better represented by Rum. *domnă*, "lady," than by Ital. *donna*, Span. *doña*, Port. *dona*, Fr. *dame*). Some words indeed—such as *laudare*, to praise, *ducere*, to lead—retain unaltered the forms under which they were used by Virgil and Cicero. A feature of the language which distinguishes it from all other members of the group, and appears to be of even higher antiquity than the word-forms above mentioned, is the retention of a suffix article—e.g. *frate*, brother, *fratele*, the brother; *zi*, day, *ziua*, the day. This usage seems to have survived from the pre-Roman period. A similar suffix article is retained in Albanian, which almost certainly represents the original language of the Thracio-Ilyrian tribes (see ALBANIA); and these tribes belonged to the same ethnical and linguistic group as the Daco-Moesians represented by the Vlachs.

Rumanian orthography remained in a transitional state throughout the 19th century. The Latin alphabet is used, with special signs to represent sounds borrowed from Slavonic, &c. All the unaccented vowels except *e* are pronounced as in Italian; *e* has the same phonetic value as in Old Slavonic (=French *ê*) and is often similarly pretonized (=ye in *yet*), notably at the beginning of all words except neologisms. The accented vowels *ê* and *ô* are pronounced as *ea* and *oa* (*pétra*, rock, = *peatra*; *mórtē*, death, = *moarte*); they are written in full, as diphthongs, at the end of a word and sometimes in other positions. The sound of the Slavonic **ѣ** (a guttural *y*) is represented by *â*, *è* or *ô*, though these letters occur as frequently in words of Latin origin (e.g. *cină* = *quando*) as in those derived from Slavonic; **ѣ** is represented by *î* or *î*, having the nasal sound of *un* in French; *î* and *û* at the end of a word are mute or short. Of the consonants, *e* followed by *e* or *i* = *ch* (as in *church*), otherwise *k*; *q* or *ç* resembles the English *j*; *g* is hard before *e* and *i*, otherwise *ç*; *g* is guttural, as *ch* in *sch*; *j* is pronounced as in French, as in Russian **ж** (Slav. III, *zh*); *sh* for *r* (Slav. II), as *ts* or *tz*; *w* is wanting. The remaining consonants have the same phonetic values as in English.

Rumanian is highly inflected. It possesses two regular substantive declensions and six cases, the vocative being in common use. The large class of heterogeneous nouns which are masculine in the singular and feminine in the plural constitute what is sometimes called the neuter declension. There are three regular conjugations (as in Italian) (as in Latin), adding the tensing of the present infinitive in *a*, *e*, or *i*; e.g. (1) *arare*, to plough, of *crede* or *credere*, to believe, (3) *dormi* or *dormire*, to sleep. Verbs ending in *g*, however, are sometimes classed as a fourth conjugation. The second form of the present infinitive (*arare*, *credere*, *dormire*) is used as a noun. The so-called "simple perfect" (*perfectul simplu*) has often the force of an aorist. Compound tenses are formed by the addition of certain particles and of the auxiliary verbs—*ave*, to have, *a fi*, to be, and *a voi*, to will. For the passive voice, *a fi* is used, with the past participle of the required verb. All tenses of reflexive verbs except the imperative and present participle are formed by prefixing the pronoun which indicates the object to the verb, in the dative or genitive case (abbreviated as the verb may require; but in the reflexive imperative and present participle the verb precedes the pronoun; e.g. *a propune*, to propose, *a și propune*, to propose to oneself, but *propune* *și*, propose to yourself.

The accentuation of Rumanian, though complex, is governed by certain broad principles, except in the case of neologisms, many of which have been borrowed from French and Italian without change of accent. Nouns retain the accent of the nominative singular in all cases and in both numbers (e.g. *copilă*, girl, vocative plur. *copilelor*), except when a diminutive or augmentative suffix is added; the accent then shifts to the suffix. The language is very rich in diminutive and augmentative forms; e.g. the name *Ian* or *Ioan* (John), has the diminutives *Ioniță*, *Ionița*, *Ionașcu*, *Ianache*, *Ienăchel*, &c. In verbs—apart from a few exceptional tenses—the accent falls on the first syllable of the inflectional suffix, e.g. *ești dorm*, I sleep, but *ești dormisem*, I had slept. For the sake of euphony, a vowel is frequently interpolated between two consonants; e.g. in masculine nouns terminating in a consonant, an interpolated *u* precedes *l* to form the suffix article (*om*, man, *om-u-l*, the man).

BIBLIOGRAPHY.—(1) Dictionaries: A. de Ciăcă, *Dictionnaire d'Étymologie daco-roumaine* (2 vols., Frankfurt, 1870-79), valuable for non-Latin elements; B. P. Hășdeu, *Étymologium magnum Romaniae* (Bucharest, Academia Română, 1887, &c.); F. Damé, *Dictionnaire roumain-français* (Paris, 1896); S. Țăncăscu, *Étymologisches Wörterbuch der Rumänischen Sprache* (Heidelberg, 1905, &c.); I. A. Candrea-Hecht and O. Denusianu, *Dictionnaire général al limbii române* (Bucharest, 1909, &c.); I. Dalamerta, *Dictionar Macedoromân* (Bucharest, Academia Română, 1906). (2) Grammars, &c.: T. Cipariu, *Grammatica limbii române* (Bucharest, 1870-77); I. Nădejde, *Grammatica limbii române* (Bucharest, 1884), id., *Istoria limbii și literaturii române* (Jassy, 1886); B. P. Hășdeu, *Cuvențe*

² Apart from certain instances in which the Latin form has been artificially restored in comparatively modern times. (See under LITERATURE.)

din bătrâni (Bucharest, 1878-79); L. Şăineanu, *Istoria filologiei române* (Bucharest, 1895), id., *Influenţa orientală asupra limbii şi culturii române* (3 vols., Bucharest, 1900); S. C. Măndrescu, *Elemente unghereşti în limba română* (Bucharest, 1892); S. Puscariu, "Studii istoromâne" in *Annalele de la Academia Română*, ser. 2, vol. xviii.; T. Gartner, *Darstellung der rumänischen Sprache* (Halle, 1904); G. Weigand, *Praktische Grammatik der rumänischen Sprache* (Leipzig, 1903). Important studies on the separate dialects of Moldavia, Walachia, the Dobruja, Bessarabia, Bukovina, the Banat, Macedonia, Istria, &c., have been published by G. Weigand, either in book form or in the *Leipzig Jahresbericht des Instituts für rumänische Sprache*, which he edited from its foundation in 1894. (X.)

LITERATURE

The intellectual development of Rumania has never until modern times been affected by Latin culture, but it has been profoundly influenced first by Slavonic literature, then by the Greek or Byzantine literature, and last, by the Western, notably French and Italian novels. The history of Rumanian literature can be divided into three distinct periods: the Slavonic, from the beginnings of Rumanian literature in the middle of the 16th century down to 1710; the Greek, from 1710-1830, corresponding with the era of Phanariote rule; and the modern period, from 1830 to the present. The change from Slavonic to Rumanian was very gradual. Slavonic had been the language of the Church from the early middle ages, and was therefore hallowed in the eyes of the people and the clergy; through the political connexion with the Slavonic kingdoms of the south, Bulgaria and Servia, it had also been the language of the chancelleries and of the court. Even when the Rumanian language at last supplanted the Slavonic, it did not emancipate itself from the original; the new was merely a translation from the old, and at the beginning it was as literal as possible. We have therefore in the first period a medieval literature transplanted to Rumania and consisting of translations from the Slavonic. The reason of the change from Slavonic into Rumanian is to be sought in the influence the Reformation had among the Rumanian inhabitants of Transylvania.

The second period is marked by a complete waning of Slavonic influence, through the literary activity of the Greek hospodars. The Slavonic kingdoms of the south had lost their independence; they had ceased to produce anything worth having, whilst the Greeks brought with them the old literature from Byzantium and thus drove out the last remnants of Slavonic. They also treated Rumanian as an uncouth and barbarian language, and imposed upon the Church their own Greek language, Greek literature and Greek culture. This literature may be taken to represent the period of the Renaissance in the West; but when the yoke of the Phanariotes was shaken off, the link that connected Rumanian literature with Greek was also broken, and under modern influences began the romantic movement which has dominated Rumanian literature since 1830.

Much of the Rumanian literature of the first two periods has been preserved only in MSS.; few of these have been investigated, and a still smaller number have been compared with their original. The Rumanian Academy keeps jealous watch over the treasures it has accumulated, and few have had access to the riches entombed in its archives; nor has any private or public collection been catalogued. An exhaustive history of Rumanian literature is, for the time being, a pious wish.

First Period: c. 1550-1710.—Rumanian literature begins, like all modern European literature, with translations from the Bible. The oldest of these are direct translations from Slavonic texts, following the original word for word, even in its grammatical construction. The first impetus towards the printing of the Rumanian translations came from the princes and judges in Transylvania. It is under their orders and often at their expense that the first Slavonic printing-presses were established in places like Kronstadt (Brashov) Orastia, Sasz-Shebes and Belgrad (Alba Julia, in Transylvania) where Slavonic and Rumanian books appeared. The foremost printer and translator was a certain Diakonous Koresei, of Greek origin, who had emigrated to Walachia and thence to Transylvania. He was assisted in his work by the "popes" (parish priests) of those places where he worked. The very first

book published in Rumanian is the Gospels printed in Kronstadt between 1560 and 1561. An absolutely identical Slavonic text of the Gospels appeared in the same year, or one year earlier, which no doubt was the original for the Rumanian translation. Following up the list of publications of the books of the Bible in chronological order, we find Diakonous Koresei immediately afterwards—

The Bible.

The date has not yet been definitely ascertained—printing a Rumanian translation of the Acts of the Apostles; in 1577 he printed at Sasz-Shebes a Psalter in both Slavonic and Rumanian; the Rumanian follows the Slavonic verse for verse. A MS. Psalter more recently discovered shows close affinity to this edition, and, in spite of the opinions held by some critics, must be considered as a copy of it made about 1585; it even reproduces the printer's errors of Koresei's edition. To the 16th century belong also the first attempts to translate the historical books of the Old Testament which appeared in Orastia in 1582, under the title *Palia*. The example thus set could not fail to react upon the Rumanians in Walachia, with whom the Transylvanians stood in close commercial and political connexion. The Slavonic language still reigned supreme in the Church; yet once the example had been set in Transylvania, and the influence of the Slavonic nations had begun to slacken, it was inevitable that the Rumanian language should sooner or later come to its own. It was in Transylvania that the first complete Rumanian translation of the New Testament appeared (Belgrad, 1648). This translation was based upon the Slavonic original, but the text had been verified and corrected, by comparison with a Calvinistic translation, and had been collated with the Greek. The chief author of this translation, which may be termed classical, seems to have been a certain Hieromonach Sylvestre who lived in Walachia and who had undertaken, at the request of the Hetman-gor of Transylvania (1613-29), a translation of the whole Bible. Upon this version, no doubt, are based the editions of Iordache Cantacuzene (Bucharest, 1682), and that of Şerban Greceanu (1693), in which for the first time the Greek text is printed side by side with the Rumanian; and the edition of Anthon the Iberian (1703). In these may also be traced a few reminiscences of the older version by Koresei, of which a copy, made by Radu Gramatik (1574), and once the property of Peter Cercei, is now in the British Museum. Sylvestre also prepared a new edition of the Psalter as part of the Bible (Belgrad, 1651), verifying the text by reference to the Hebrew and Greek originals. The first edition of the complete Bible was published (1688) by order of Prince Ioan Şerban Cantacuzene, by Radu Greceanu, assisted by his brother Şerban and by Metrofan the bishop of Buzeu. This may be considered as the supreme monument of Rumanian literature in Walachia in the 17th century. No other Rumanian translation approaches it in style and diction, although the authors, as they own, utilized the older translations, and for the New Testament and the Psalter they utilized Sylvestre's work. At least a hundred years had to pass ere a new edition of the whole Bible was undertaken, nor was the Bible used for private reading, except such passages as were included in the lessons read in church. These were translated independently by Dositeiu under the title of *Psirmir* (Jassy, 1683), and were almost the last work that came from his prolific pen. As far back as 1600 Dositeiu had made a new translation of the Psalter from the Slavonic and printed it in both languages (Jassy, 1680). Upon this translation he based the rhymed Psalter at which he had worked from 1660-73, when it appeared in Unieiv. This is the first example of rhymed psalms in Rumanian, the author following the Polish rhymed version of Jan Kohanowski. Albert Molnar had translated a French rhymed Psalter in Hungarian (1607) and this served as the basis for a literal translation made by Viski (1697). About the same time Theodor Korbea attempted to versify the Psalter and dedicated his work to Peter the Great of Russia. A new translation of the Psalter from Slavonic, with a commentary, the first of its kind, was made in 1697 by Alexander Dascalul (Alexander Preceptor Polonus). All these last-mentioned Psalters are still in MS.

Turning from the Bible to homilies and the liturgy, we find the ancient collections of homilies in Rumania to be due to the same proselytizing movement. Almost the first book printed in Rumania by Koresei, in the course of the year 1577, was the *Homilies*. Foro Miklaus, c. 1570, seems to have been a translation from some Calvinistic compilation of homilies, one for every Sunday in the year. A Slavonic original sent by the metropolitan Serafim of Walachia served as the basis for a second collection of homilies known as *Evangeliu îndădătoare* (1580). It differs from the former in language and tendency and proves that Koresei was only a translator and printer. The first collection of homilies, henceforth known as *Cazani*, appeared in Dligopole, i.e. Câmpulung, in Walachia, in 1642. It was compiled by a certain Melchisedec and contained thirteen homilies. Very voluminous is the second collection, *Evangeliu îndădătoare ilicului*, translated from the Russian by Sylvestre (Govora, 1643). One year later appeared the first book printed in Moldavia, the collection of homilies *Carte românească de îndădătoare* (Jassy, 1643). It is a volume of 1000 folio pages, of which the first half is absolutely identical with Sylvestre's collection. A similar unacknowledged loan was made by Meletie the Macedonian, compiler of the homilies which appeared at Deal in 1644. Of special interest

is the next publication of homilies *Cheea înteleșului*, "the Key of understanding," by the Walachian metropolitan Varlaam, translated from the Russian and printed at Bucharest in 1678. This, the first book printed in Bucharest, begins the long series of editions which have issued from the press of the "Mitropolie" in Bucharest. From this press originated also the no less important presses at Buzeu and Râmnicu Vâlcea, where in the following two centuries almost all the books for the Church service were printed. Two or three more collections may be mentioned here—one called *Sierii de aur*, "the Golden treasury," by Ioan de Vinți (Șas-Szeshes, 1688), probably from some Hungarian Calvinistic collection of obituary sermons; and the "Pearl," *Mărgăritare*, an anthology made from the Greek homilies of St. Chrysostom, Epiphanius, Anastasius Sinaita, &c., and translated from the Greek by the brothers Radu and Serban Greceanu. The only collection of original sermons is the *Didahii* delivered by the metropolitan Anthim the Iberian (*g. n.*), the scholar, artist, translator, printer and great linguist, who was the first to issue books in Arabic and even in Georgian from his printing-presses in Bucharest. The *Didahii* were published at Bucharest in 1888.

The Rumanian language was not yet introduced into the Church. All the service books were in Slavonic, but during this period most of them were translated, and some of them printed, although not yet officially used. The burial service seems to have been the first to be translated. Two *Evhologia* appeared during the second half of the 17th century, one by the bishop Dositheu (Jassy, 1679-80), which remained almost unknown, and the other based upon the Slavonic, by Ioan de Vinți (Belgrad, 1689). This *Măltăvnic* (prayer-book) has been the basis of all subsequent editions of the Rumanian Prayer-book. The Liturgy proper was also translated by bishop Dositheu in 1679, but a translation from the Greek, by Jeremia Kakavela (Jassy, 1697), was the one adopted in the churches. Passing over the numerous editions of the Akathist and Katavassari, some partly in Rumanian, we may mention the *Ceaslov* (Book of Hours), said to have been printed for the first time in Transylvania in 1694, but certainly printed or reprinted by the metropolitan Anthim (Tîrgovishteia, 1715). In 1694 Alexander Dascalul translated, and the bishops Mitrofan of Buseu and Kesarie of Râmnicu Vâlcea printed (among other church books) the twelve volumes of the *Mineu* in Slavonic with Rumanian rubrics, and short lives of the saints, as well as the *Triod* and the *Anthologia*.

In addition to the activity of the Reformers in Transylvania, there was also a Roman Catholic propaganda in Rumania, and the Orthodox Church found it necessary to convocate a synod in Jassy for the purpose of formulating anew its own dogmatic standpoint. It was held in 1642 under the presidency of Peter of Moglia, and a copy of the Orthodox creed was drawn up. An answer to the Lutheran Catechism of Heidelberg (translated into Rumanian and printed at Fogaras in 1648) was also prepared by Bishop Varlaam. R. Greceanu translated the formulary from Greek into Rumanian under the title *Pravoslavnici mărturisire* (Bucharest, 1692). Of a more decided polemical character is the *Lumina* of Maxim of Peloponnesus, translated from the Greek (Bucharest, 1699).

Of far greater interest is the literature of maxims, and lives of saints, real or apocryphal, intended to teach by example. Such are the maxims in the *Floarea darurilor*, translated from the *Ethical literature* Greek (Sneagov, 1700), and going back to the Italian *Fiore de virtù*, or the *Indăptării creștinii*, "Christian teachings" of Filippus (1700); the short moral guide, *Cărare de viață*, by Ioan de Vinți (Belgrad, 1688), translated from some Hungarian original; the *Măntuirea păcătoșilor*, or "Salvation of sinners," translated from the Greek by a certain Cozma in 1682, which is a storehouse of medieval exempla; and above all the *Mirror of Kings*, ascribed to Prince Neagoe Bassaraba, written originally in Slavonic (or Greek, if the prince be really the author), translated (c. 1650) into Rumanian. This exceeds all the other publications of its class in purity of language and excellence of style. Of the lives of saints, the *Prolog*, translated from the Slavonic at the beginning of the 17th century (MS.), and the *Viețile Sfinților*, by Dositheu (2 vols., Jassy, 1682), are the most important. In the latter, which is his greatest work, he omits to refer to some Greek texts, but also Slavonic legends and other legends of saints. He includes a goodly number of the apocryphal legends of only Greek text. To this kind of literature belongs also the *Lăsaikon*, i. e. the *Historia Lausiaca* of Palladius, differing, however, in some points from the original. The legends of the saints of the Pecherskaya in Kiev were translated by Alexander Dascalul. All these are still in MS.

The first law-books were also compiled during this period. The Slavonic *Nomokanon*, which rests on Greek legislation and embodies the canonical and civil law, had previously been used in Rumania. In 1640 there appeared in Govora the first canonical law-book, which was at the same time the first Rumanian book printed in Wallachia. This *Pravilă* (code) was probably the work of the historian Moxa or Moxaleu. In 1652 Evstratie the Logofet (logothete) also translated a *Pravilă* from the Greek, which remains in MS. In 1646 appeared the *Pravilă aleasă*, or "Selected Code," compiled, no doubt, by Evstratie and published with the authority of the then reigning Prince Vasile Lupul (Basil the Wolf), hence known as the Code of Vasile. In 1652 there appeared in Bucharest

a complete code of laws, translated from the Greek and Slavonic and adapted to local needs under the direction of the prince of Wallachia, Matthias Bassaraba. The *Indreptarea legii*, in which *Pravilă* of Vasile was incorporated without acknowledgment, remained the recognized code almost down to 1866. It embraces the canonical as well as the civil law. The chief authors were Uriil Năsturel and Danil M. Panoneanu.

The earliest historical works are short annals, written originally in Slavonic by monks in the monasteries of Moldavia and Wallachia. In 1620 Moxa translated from the Slavonic a short history of the world down to 1498. Two other antivalachic histories were translated from Greek and Slavonic chronographs. One by Pavel Danovici contains the history of the world told in the style of the Byzantine chroniclers; it includes the legend of Troy, the history of Pope Sylvester and the description of the various church councils; and it concludes at the year 1636. The second is the *Hronograf* of Dorotheus of Monemabasa, translated by a certain Ion Buhureăzu. Both are still in MS. The Old Slavonic annals were later on translated and new notes were added, each subsequent writer annexing the work of his predecessor, and prefixing his name to the entire compilation. Ancient Rumanian historiography is thus difficult to unravel. In Moldavia, where the influence of Poland had been great and Western writings were accessible, we find the best chroniclers. The writers are often actors in the dramas which they describe, and often also the victims. A history of Moldavia from the earliest times to 1594 is ascribed to Nestor or to his son, Gregorie Ureche, or to Simon Dascalul. It was continued by the Evstratie mentioned above, and probably also by Missail Călugărul. The most important author whose writings rank as classical is Miron Costin, who either took up the thread where it was left by Simon and Ureche and wrote the history of Moldavia from 1594-1662, or continued the history from where (probably) Evstratie had left it (c. 1630-62). Nicolae Costin (d. 1718), son of Miron, completed the history at both ends. He starts from the creation and endeavours to fill up the lacuna from 1662 to his own time, 1714. It is doubtful, however, whether the portion from 1662-1701 is his work or whether another compiler had filled up that section. *Ascutite* Uricariul, 1715, brings to a close the *corpus* of Moldavian Chronicles.

The same uncertainty holds good also for Wallachia. The beginnings are the work of an anonymous author, whose chronicle, continued by a certain Constantin Capitanul, describes the history of Wallachia from Radu Negru (i. e. Rudolph the Black), c. 1290-1688. An addition to this Chronicle from the time of the Roman Conquest to Attila is ascribed to Tudosie Vestemianul, twice metropolitan of Wallachia (1669-73, 1677-1703). The Chronicle of Capitanul was further continued by Radu Greceanu to 1707, and by Radu Popescu to 1720. Two other works remain still to be mentioned—a comprehensive history of both principalities by an anonymous author, probably the Spatar Milescu, who finished his eventful life as ambassador of Russia to China (still in MS.), and the *Hronical Moldo-Vahilor* of Prince Demetrius Cantemir (see CANTEMIR), more an apology for the Roman origin of the Rumanians than a true history. Cantemir wrote the original in Latin and translated it into Rumanian in 1710. His style shows an immense superiority to that of the previous historians. Of poetry there is scarcely a trace during the whole period under review except some rhymed Psalters and a few rhymed dedications to patrons.

Second Period: 1710-1830.—The Phanariote period has been described as one of total decay; the political degradation of Rumania was thought to be reflected in its spiritual life. But the facts do not warrant this opinion. The few who had taken the trouble to study Rumanian literature paid not the slightest attention to the vast MS. material accumulated during the years of the Phanariote dominion, and out of sheer ignorance and political bias condemned this period as sterile. Another influence was far more potent than the conduct of the Greek princes, though some of them were real benefactors of the people. In Transylvania one section of the Rumanian population had accepted the spiritual rule of the pope; they became now Greek-Catholic, instead of Greek Orthodox. Rome took good care

Influence of Roman Catholicism.

to educate the priesthood far above the status of the Orthodox priests, and continued an extensive proselytizing activity. So long as the Rumanians were spiritually united with the other Orthodox nations, and so long as they used the Slavonic or Cyrillic alphabet, they would practically be cut off from the Latin West. If, however, they could be induced to discard the old Slavonic alphabet and substitute for it the Latin, and could be brought to recognize their national and ethnical unity with ancient Rome, it was hoped that then they would be more easily induced to enter into the unity of faith. Thus a great change was wrought towards the end of the 18th and in the

first half of the 19th century in the whole current of Rumanian literature. It suited the promoters of that movement to pretend that they started a new era. But the Latin or Transylvanian movement wrought great havoc in Rumanian literature and caused the greatest confusion in the language. Only now are some authors beginning to free themselves from the evil influence.

By the end of the 17th century Rumanian had become the authorized language of the Church, and the Rumanian translation of the Gospels (printed 1693) had become the Authorized Version. Most of the liturgical books officially adopted and revised in this case are still used for church services. Such are the *Creosolov*, revised by Bishop Kliment of Râmnicu Vâlcea (1745), the *Evhologion* (1764), the *Kabavator* (1753). The monumental publication of the *Mineiu*, in 12 folio volumes, by Bishops Kesarie and Filaret of Râmnicu Vâlcea (1776-80), is equal in importance if it be not superior to the no less monumental publication of the *Litae of Saints*, also in 12 huge folio volumes, published under the direction and with the assistance of the metropolitan Veniamin of Moldavia. The latter was translated from the Russian, appeared in Neamtzu (1809-12), and was reprinted in Bucharest (1835-36). In beauty, richness and lucidity of language, and in dignity of style, these two books resemble the Bible of 1688.

Slavonic having entirely disappeared from the sources of literature, writers and translators turned to Greek originals and for more than a century were busy translating into Rumanian the most important works of the older Fathers of the Church. Some of these translations were printed much later; thus the *Hexameron* of Basil the Great (and of Epiphanius) translated in the middle of the 18th century, was printed at Bucharest in 1827. The *Scala Coeli* of Joh. Klimakus, the *Treasury* of St. Damascenus (MS. 1747 by a certain Mihailcea), the homilies of Cyril of Alexandria, and those of Ephraem the Syrian, were printed at Neamtzu in 1818. The *Panoplia* of Euthymius Zygabenus (1775) and the *Commentary* of Theophylact were printed by Veniamin (Jassy, 1805). The homilies of Theodor Studite (MS. 1712) were edited by Bishop Filaret and published at Râmnicu Vâlcea in 1784; a translation of Gregory of Nazianzen appeared at Bucharest in 1727. The great polemical work of Simeon of Thessalonica, the Greek original of which was published by Dostitheu (Jassy, 1683), had been translated into Rumanian long before it was printed (Bucharest, 1756). The *Lafsaikon*, mentioned above, was printed at Bucharest in 1754. All these translations are written in good Rumanian. One can see how a language not originally suited for abstract problems and theological dialectics was slowly but surely improved and made capable of expressing profound and subtle ideas.

In Transylvania, with the conversion to Greek-Catholicism of Bishop Athanasius in 1701, the Greek Orthodox had to place themselves down to 1850 under the protection of the Serbian metropolitan of Karlovatz. No writer of any consequence arose among them. The "United" fared better, and many a gifted young Rumanian was sent to Rome and helped from Vienna to obtain a serious education and occasionally also temporal promotion. With a view probably to counteract the literary activity in Rumania, the bishops P. P. Aaron and Ioan Bobb were indefatigable in the translation of Latin writers. First and foremost a new translation of the whole Bible was undertaken by Samuel Klain. It appeared in Blah (1793-95). It falls short of the older version of 1688; it was modernized in its language, and no doubt a careful examination would reveal differences in the translation of those passages in which the Catholic tradition differs from the Eastern. Bobb translated Thomas à Kempis's *Imitatio Christi* (Blah, 1812); he wrote a *Theologic morală* (*ibid.*, 1801) and adapted the Rumanian service-books to the new order of things. Popular catechisms and various histories of the Church were then written. Mention may be made of a few more moral treatises such as the *Ușa pocăinței*, "Gate of Penitence" (Kronstadt, 1812); *Oginda omului dinăuntru*, "The Mirror of the Inner Man"; or *Pilde filosofesti*, "Philosophical Saws and Maxims" (Tirgovishta, 1715). Of greater importance was the collection of fables with their "moral" translated and modified from the Serbian of Obrenovich—*Fabule moralicești*, by Tzikindal (Budapest, 1814). These are heavy and follow the original too literally. Tzikindal (d. 1818) and his contemporaries in Hungary had lost contact with the Rumanian literature in Walachia and Moldavia, and the same was the case with the other writers of their school. Radovici or Dinu din Golești, an enlightened Walachian boyar, who was one of the first Rumanians to describe a journey in Western Europe, is also the author of a collection of maxims and parables, *Aduinare de pilde bisericesti și filosofesti* (Budapest, 1824); he left a larger collection in MS. partly edited by Zane in his *Proverbele Românilor*, vols. xi.-xvi.

After 1727 Rumanian was recognized as the language of the law-courts, and through the mediation of Bukovin by Austria (1774) and of Bessarabia by Russia (1812), codes for the civil and political administration of those provinces were drawn up in Rumanian, either in accordance with the established law of the land or in consonance with the laws of Austria and Russia.

Such legal codes reflect the German or Russian original. They were however, of importance as they served as models (to some extent) for the new legislative code compiled in Moldavia under Prince Cahimach; this was originally published in Greek (1816), and afterwards translated into Rumanian with the assistance of G. Asaki (Jassy, 1833). The Walachian civil laws and local usages were collected and arranged under the direction of Prince Ipsilanti (1780) in Greek and Rumanian, and under Prince Caragea the other code was published (1817), which remained in force until 1859, when the "Organic Law" changed the whole trend of legislation. One more collection, an abstract from the Greek *Basilica*, published by Donici (Jassy, 1814), must be mentioned, for through it the legal terminology of the modern codes was more or less fixed.

The last and probably the best writer of Rumanian history in the Phanariote period is Neculcea. He wrote a history of Moldavia in his own time, but for the period before 1684 his work is more or less an abstract from older writers. The original part covers the period from 1684-1743, and to some extent an autobiography of a very adventurous life. Neculcea adds to his chronicle a collection of historical legends, many of them still found in the ballads of Moldavia. Among other historians might be mentioned N. Roset, the continuator of Neculcea. Enaki (Janache) Cogălniceanu wrote a history of the period 1730-1774, and followed the example of Greek writers by introducing rhymes into it. He was also the author of some political satires and other poems on G. Ghica, M. Logodjan and Ivan Cuza. The historians of the time under pressure of political exigencies did not scruple to invent treaties between the Porte and the Rumanian principalities. A series of such spurious collections of treaties were submitted to the Powers for ratification; in them imaginary rights and privileges alleged to have been granted by the Turks were described, and the Rumanian representatives asked that after the peace negotiations of 1774 they should be sanctioned afresh. In Walachia there was not a single historian of importance in the first half of the 18th century. In the second we have the chronicle of Dionisie Eclesiaru (1764-1815), a simple-minded and uncritical writer who describes contemporary events. The ancestor of a great family of poets and writers, I. Vacarescu described the history of the Ottoman empire from the beginning to 1791, interpolating doggerel verses. Alexander Beldiman describes in a rhymed epic, *Eteria* (1821), the first battles between the Greeks and the Turks in Moldavia. It is a bitter satire upon the Greeks. Similar in intention is another rhymed chronicle known under the name of *Zilot* (c. 1825).

Whilst a political and national revival was taking place in Moldavia and Walachia, towards the beginning of the 19th century, the Latin movement on in Transylvania, where the Latin and religious tendencies got the upper hand. Three historians had been partly educated in Rome under the protection of Prince Borgia and the influence of the Jesuit Minotto and the College of the Propaganda; they were Samuel Klain, Petru Maior and George Sincal. To Klain's initiative can be traced most of the work of the three. Unfortunately his writings, with a few exceptions, are still in MS. He is the author of the first history of the Rumanians in Dacia written according to the standards of Western science. It seems to have described the wars between the Romans and the Dacians, and to have been continued down to 1795; a history of the Rumanian Church also formed part of the book. P. Maior published an almost identical history (Budapest, 1812), and it is probable that he had made use of Klain's composition. In both the tendency is the same—to trace the modern Rumanians directly from the ancient Romans, and to prove their continuity in these countries from the time of Trajan to this day. Political and religious aims were combined in this new theory. A conflict was raging between the Hungarians and Rumanians, and history was required to furnish proofs of the greater antiquity of the Rumanians in Transylvania. George Sincal (1753-1816), who was an intimate friend of Klain and collaborated in most of his works, succeeded him as revisor at the printing office in Budapest. Sincal worked for nearly forty years at his monumental *History* of Rumania, which the Hungarian censor did not allow to be printed on account of its nationalist and anti-Magyar tendencies. It remained until 1853-54, when it was printed at the expense of Prince Gr. Ghica. The edition of 1886 is only a reprint, though both the original MS. and a better copy had meanwhile been discovered.

These books had no immediate influence in Walachia and Moldavia, where fiction and the drama had developed under the influence, first, of Greek and then to an increasing extent of French, Italian and German models. It was towards the end of the 18th century that Rumanian literature began to emancipate itself, very slowly of course, and to start on a career of its own in poetry and *belles lettres*. Curiously enough, the first novel to be translated was the "Ethiopic History" of Bishop Heliodorus. The *Odyssey* and *Iliad* were then translated into prose, and the *Arabian Nights*, after undergoing an extraordinary change in the middle of the 18th century, appear in Rumanian literature at the middle of the 18th century under the name of *Halima*. The Glykiss, a Greek printing firm in Venice, published many popular books in Rumanian which found their way into the principalities. The epic of Vincenzo Cornaro was translated into prose alternating

History.

Imaginative literature.

with verse, first under the name of *Erotocrit* and then slightly changed as *Filerot* & *Antusa*. Anton Fann printed it as his own composition. *Kritii și Andronius* (Jassy, 1794) is almost the last novel or story translated direct from the Greek. The young men of Walachia had come into contact with Western literature, which they were anxious to transplant to their own country. Some had been sent to Paris for their education, such as Poteca, Marcovici, the Voinescu, Morou and others, who developed an almost feverish activity in translation. Most of the writers of Florian, Marmontel, Le Sage, Montesquieu and others were rapidly translated into Rumanian. The picaresque novel *Lasarillo de Tormes* also found its translator, and Robinson in 1839, *Paul and Virginia* in 1831. Campe's German *Arabian Crusoe* (1816) and his *Discovery of America* were translated by Draghici (1835). G. Asaki and Alexander Beidiman in Moldavia developed a similar activity. Beidiman copied a number of ancient chronicles, wrote a satire on the Greeks, and translated and adapted a number of French tragedies and dramas, in verse and prose.

Nowhere has the theatre played a more important rôle in the history of a civilization than in Walachia and Moldavia, more in the former than in the latter. It formed the rallying-ground for the new generation which chafed under the tyranny of a Greek court. A certain Aristia, of Greek origin, but soon acclimated to his surroundings as teacher at the high school in Bucharest, was the first to adapt foreign dramas for the Rumanian stage. These were first performed in Greek and afterwards translated into Rumanian. The plays produced on the Rumanian stage included most of the dramas of Molière, some of Corneille, Kotzebue and Metastasio, whose *Achille in Sciro* was the first drama translated into Rumanian (by Iordache Slatineau, printed at Sibiu in 1797). Schiller was also translated, and a few plays of Shakespeare (*Hamlet*, &c.) found a French version. Victor Hugo's *Angelo* and *Maria Tudor* were translated by Constantin Negruțin. Those who kept in touch with the old literature—men such as Beidiman, Marcovici and Negruțin—were able even in their metrical translations to do justice to the originals and at the same time not to distort the character of the Rumanian language. Among such translators was Skavinschi, who came originally from Transylvania to Jassy, and translated Reginald's *Democrit* into verse.

The lyrical and epic poetry of the time follows somewhat the same lines, but with certain notable differences. The individuality of the authors is more marked, and they advanced much sooner from translations to independent poetry. In Transylvania, which awoke to a new life towards the end of the 18th century, produced some of the most popular poets. Among them were Vasile Aaron (1770-1822) and Ion Barak (1779-1848). Aaron wrote the *Passion*, in 10,000 verses (1802; often reprinted); the lyrical romances of *Pirani și Tisbe* (1808) and *Sofronim și Hăriti* (1821); and the humorous *Leon și Dorolăa*, a satire on bad women and on drunken husbands, now a chapbook. Barak wrote *Răsipirea Ierusalimului* (1821), "The Destruction of Jerusalem," almost as long as Aaron's *Passion*; and he versified a Magyar folksong, *Arghei și Elena*, which has also become a chapbook, and has been interpreted as a political poem with a hidden meaning. He also translated the *Arabian Nights* from the German. In Walachia a certain Ion Budai Deleanu, a man of great learning, author of a hitherto unpublished Rumanian dictionary of great value, wrote a satirical epos in which gypsies play the chief part. It is called *Tiganiada* (1812) and consists of 12 songs and of many thousand verses. The author displays a profound knowledge of the life and the customs of the gypsies, and of Western literature from the *Batrachomyomachia* to the *Pucelle* of Voltaire.

The love-songs of the time are marked by imitations of the Neo-Greek lyric diatribes and rhapsodies, which through the teaching of the princes of Walachia were considered as the fountainhead of poetical inspiration. But a closer acquaintance with the West led to greater independence in poetical composition. In the three generations of the Vacarescu one can follow this process of rapid evolution. Ianahe Vacarescu, author of the first native Rumanian grammar on independent lines, was also the first who tried his hand at poetry, following Greek examples. He then studied Italian, French and German poetry, and made translations from Voltaire and Goethe. His son Alecu (b. 1795) followed his example. Both were overshadowed by the grand old Ion Barak, who was more than any other man both the representative of an epoch fast vanishing and the harbinger of the new spirit that was stirring young Rumania. The collected poems of I. Vacarescu were published in 1848; but among them were some of the poems of Ianahe and Alecu, which were confused with his own work. In this volume, *Colecție din poezie domnului mare logofet I. Vacarescu*, there are odes, hymns, patriotic poems, ballads, lyrical and didactic poems, some of them among the most beautiful in the language. A contemporary of his earlier period, Paris Mulumleau (1794-1837), wrote his *Rose* in 1820, under Greek influence, but afterwards passed under the spell of Maizer and Trilckind, whose Latin propaganda he was one of the first to advocate in Rumania. In his *Caractere* (Bucharest, 1828) Latin forms are common. One more poet, and a real one, is Vasile Cârlova (1809-1831), whose *Ruins of Tirovishet* sufficed to place him among the foremost Rumanian poets of the 19th century.

In Moldavia a similar development took place, translations leading up to independent production. The most prominent figure is that of the scholar and linguist Constantin Konaki (1777-1849), who might be termed the Rumanian Longfellow for the facility and felicity of his translations from Western poetry and for his short poems, easily set to music and very popular. His *Alcătuiri și Îlălmăciri* appeared in 1858. Constantin Negruțin, who was at first influenced by the Russian poets, notably Pushkin, successfully translated poems of Victor Hugo, and rivalled Konaki in his dexterity and fidelity to the original.

Third Period: 1830-.—The agitation for the transliteration of the alphabet, the elimination of all non-Latin words from the language and the ostracism of the old literature, completely crippled all literary activity, first in Transylvania and then in Rumania. The Latin movement was first brought into Walachia by a certain George Lazar from across the mountains. Lazar was appointed teacher at the St Sava school of Bucharest, where he spread the new doctrine of the Latin origin of the Rumanians; Latinizing tendencies were, however, not yet imported into the language. Of his pupils there was one whose influence became decisive: Ion Eliade (Heliade), afterwards also known as I. E. Radulescu (1802-1872), a man of immense activity, of great power of initiative and of still greater imagination. He it was who ushered in the new epoch, and for close upon forty years he stood at the head of almost every literary undertaking.

There were two periods in his life—the latter the exact opposite and negation of the former. Up to 1848 he was closely connected with politics, the theatre and the school—he was the successor to Lazar; he wrote grammars, and the introductions to his grammars are models of lucidity, combined with a wide historical view. He was the founder of the first political and literary review, and he had a genius for discovering talent, and the merit of assisting it. Through his reviews he trained the middle-class to read and to take an active interest in literary problems. Through his *Curier de ambu șeze* (1837-43) he disseminated translations from political and other works, thus paving the way for the political change of 1848. About this time he turned to philology, and fell under the spell of the Transylvanian school. Slowly he developed his theories about language and writing, and he ended as a fanatic wedded to extraordinary views. He was a prolific writer and translator of dramas and novels from French and Italian, the latter appearing mostly in his periodical. The number of his publications is legion.

All the prominent Rumanians of that period were politicians; they strove to obtain the emancipation of the country from Turkish dominion, and, later on, the union of Walachia and Moldavia. Everything was placed at the service of this national aspiration, which is the keynote of the poems of Bolintineanu (1826-1873). He also was discovered by Radulescu, who published his first and best known poem, "The Dying Virgin." In 1848 he was exiled, together with the other leaders of the revolution, and he spent the next nine years in travels in the East. There he gathered the materials for his lyrical poems "Macedonele" and "Florie Bosorului." Returning in 1857 to Walachia, he occupied high administrative posts, and he wrote a number of historical novels (*Trăian, Mircea, Ștefan*, &c.), dramas (*Lăpușneanu, Mîineea, Mihail*, &c.), and satirical poems (*La Cămin*), and his best philosophical novel *Elena*. These mostly patriotic compositions were, as a rule less felicitous than his political satires (*Nemesis, Menade*, &c.). His peculiar strength lay in the historical ballad, which he was the first to introduce into Rumanian poetry, and in the vivid portraiture of Oriental scenery and emotions. He died in a lunatic asylum forgotten by all, and even his writings have, save in one early edition, not been published without unwarranted alterations by the editor Șion.

A contemporary of Bolintineanu was Grigorie Alexandrescu (1812-1885), also a pupil of Eliade. Imperfect in his rhyme and rhythm, his poetry is of a didactic nature, and his best poems are rhymed fables, many of which are thinly disguised political satires. He also translated the *Alexis Alexandrescu* (1834) and *Mérope* (1847) of Voltaire. Among his contemporaries may be mentioned G. Crețeanu (1829-1887) and A. Șileanu (1834-1857), who left some weak poems of a sentimental and patriotic character. A Deprațianu (1835-1865), whose language shows traces of the new Latinizing school; and Nicolae Nicoleanu (1833-1871), whose powerful poems, full of deep and often mystical reflections, lead on from Alexandrescu to Eminescu, all three being the poets of pessimism. In the earlier period, in the heavy and simplicity of his lyrical poems—not yet published in complete form. Like Serbănescu, Vasile Alecsandri (1821-1890), the greatest of Rumanian lyrical poets (see ALECSANDRI), was a Moldavian. In France, under the influence of Béranger and the romantic school, he was led to turn to popular

poetry for inspiration. He collected Rumanian popular songs and ballads (*Doine*, 1844) (*Lăcrămiore*, 1853). In *Pasteluri* (1867) he introduced admirable pictures of popular life into Rumanian poetry. In *Legende* (1871) and *Ostași noștri* (1877) he strikes the patriotic note. His fame rests on his lyrical poetry alone, which retains some of the charm of popular poetry. Aleksandri is less successful in his dramas, most of which are adaptations from French originals; the only merit of his novels is that amidst the phonetic and philological turmoil he kept to the purer language of the people.

From Aleksandri there is a natural transition to his great rival, who was also his superior in depth of thought and in mastery of form and language, the great poet of pessimism, Mihail Eminescu. Eminescu (p.v.). Mention may also be made of Matilde Cugler Poni (b. 1853), who published some admirable short poems in the Rumanian reviews (*Poesii*, 1888). Veronica Micile (1853-1889) belongs to the same circle of gifted Moldavian women (*Poesii*, 1887). But all these men or women disappear with the appearance of Eminescu, who, like Bolintineanu, started a new school of poetry and left a deep and growing influence upon the new generation. His best follower, though possessing originality of his own, is A. Vlahuță (b. 1859). G. Coșbuc, who has risen more recently to fame, is the poet of the unfortunate Rumanian peasant, emancipated only in name and on paper, and a prey to greedy landowners and to a medieval administration. The poets of this school drew their inspiration from popular poetry, and all of them were sons of the lower middle class or of peasants, who by dint of heavy work and great hardship were able to rise above the narrow social conditions in which they were born.

Somewhat different has been the development of the Rumanian prose writers. They suffered in consequence of the philological confusion brought about by Eliade and his assistants, mostly men who after 1848 immigrated from Transylvania and brought with them their own prejudices and narrow intolerance. Too great influence was accorded to them, and the result was that for a long time scarcely a single Rumanian novelist or historian has been mentioned by name. Only Ștefan Odobleja undertook the edition of the ancient Walachian chronicles, and had done in them admirable prose writers, that he ventured on a continuous history (1851-52) of the Rumanians under Michael the Brave, written not as a didactic treatise but as a poem in prose—full of colour and of energy. A. Odobescu, the friend and literary executor of Bălcescu, was a consummate scholar of ancient and medieval antiquities, and wrote a history of ancient art. His *Pseudokrynetikos* is an unsurpassed model of elegant writing and of fine irony. What Aleksandri was for verse, Odobescu was for prose. He also created the Rumanian novel by his *Scelme Vodii* (1858) and *Doamna Kizjna* (1860). The first novel describing human nature in everyday life is the *Ciocii vechi și noi* (1863) of Niolae Filimon (1819-1865). In Moldavia where the knowledge of the old chronicles were not so acutely felt, we find the vigorous writings of Mihail Coșbuc—one of the leading spirits of the 19th century, the greatest mind and the real founder of Rumania. Coșbucianu published various reviews, some of a political, others of a more literary character, such as the *Dacia literară* (1840) and *Arhiva românească* (1845-46); he has also the great merit of having published for the first time a collection of the Moldavian chronicles. G. Asaki (1788-1871), a second Eliade, helped to inaugurate a literary reform in Moldavia; but the result was disappointing, until the literary society known as the Junimea was started, in the 'seventies, by Titu Maiorescu (b. 1839), who was then a professor at Jassy. Titu Maiorescu put a stop to the prevailing Latinism, and turned the current of Rumanian literature into a more healthy channel, by the publication of his *Critice* (1874).

Ion Ghica, a contemporary of the revolutionaries of 1848, gathered his recollections of the agitated times into two volumes, *Amintiri* (1890) and *Scrisori către V. Alexandri* (1887), which besides their historical value have become a model of Rumanian prose. Among writers of fiction three names stand out prominently: Ion Slavici (b. 1848) describes the life of the people, notably of the Transylvanian peasants, in short stories, *Nuvela din popor*. Barbu Ștefănescu de la Vrancea (b. 1858), also wrote short popular stories characterized by a wealth of imagery and richness of language; but the characters are all mostly unreal and exaggerated. The best known collections are *Săltâncii* (1885) and *Trubadurii* (1887). Ioan Caragiale (b. 1852), the most popular Rumanian dramatist of modern times, who has brought on the stage living types of the lower and middle classes, and has skillfully portrayed the effect of modern veneer on old customs, is also the author of the powerful short novel *Faclia de paște*. Dobrogeanu Ghera (b. 1853) has in his *Studii critice* (1890 sqq.) been a ruthless but none the less judicious critic.

Curiously enough, there is not a single novel in the Rumanian literature with a sustained plot; none which presents a study of the development of human character amid the multifarious vicissitudes of life. The reason for this is the lack of a profound and long-established civilization; or it may be found in the unstable and

fickle character of the people. Whatever the cause may be, while Rumanian poetry could well compare with that of any Western nation, in the domain of prose writing, and of novels in particular, one must look to the future to fill up the gap now existing.

There existed in Rumania another set of literary monuments at least as old as any of the books hitherto enumerated, but which appealed to a wider circle. Rumanian folk-literature contains both popular written books and oral songs, ballads, &c. It is advisable to group the material in three sections: (1) the romantic and secular literature; (2) the religious literature;—both of these being written—and (3) the modern collections of ballads, songs, tales, &c.

To the first belong the oldest books, such as the *History of Alexander the Great*, which was known in Rumania in the 17th century. It is mostly, though a Sloveno-Greek text and of the utmost interest for the study of this cycle of legends. The first printed copy appeared in 1794, and has been reprinted in innumerable editions. Next comes the legend of Constantine, of his town and his exploits—a remarkable collection of purely Byzantine legends. In addition to these there is the history of St Sylvester and the conversion of Constantine, &c., all still in MS. The *History of Barlaam and Ioasaf* (see BARLAAM and JOSAPHAT) may also be mentioned here, if it appealed to the people not so much for its religious interest as for the romantic career of the hero. The parables and apologues contained in the legends were incorporated into the *Teachings of Prince Neagoe*, and were also circulated separately; they are found in many old MSS. Udriște (Uriil) Năsturel translated the *History* from the Slavonic in 1640. One of its episodes, the farewell song of the prince departing into the forest, has since become one of the most widespread popular songs. Of similar oriental origin is the *Dream of Mamer*, the interpretation of which goes back to the *Panchatantra*, and must have reached Rumania early in the 18th century, probably in Slavonic. The history of *Syntaxis and the Seven Masters* is also become a popular book. It was translated from the Greek version. To the same cycle of oriental tales belongs the *Halima*, already described, which G. Gorjaneu printed (3 vols., 1835-37) as his own work. The *History of Arkib and Anadam*, printed by Anton Pann from an old MSS., is the now famous Old Testament apocryphon of Akvrius the Wise, mentioned in Tobit and found in many languages. In Rumanian it rests on an older Greek-Slavonic text, and owes its great popularity to the wise and witty proverbs it contains.

Esop, whose wonderful biography (by Planudes) agrees in many points with the Greek version, is also one of the Italian popular books. The history of *Bertoldo*, which, though of Italian origin, reached Rumania through a Greek translation, belongs to the same cycle of rustic wisdom and cunning, and is the last representative of an old series of legends clustering round the figures of Solomon and Ashmodai, or Solomon and Markolph. These books are of course anonymous, most of them being translations and adaptations. One man, however, stands out prominently in this section of romantic and secular folk-literature. This was Anton Pann, who was born in 1797 at Silviden, of Bulgarian parentage, and who came to Rumania in 1826. Carried away by the Russians in his early youth, he settled in Rumania, learned Church music, and became one of its best exponents, married four times, had an adventurous life, but lived among the people for whom he wrote and composed his tunes. In about twenty years he published no less than fifty books, all of them still popular. Besides his edition of the Rumanian Church service-books with musical notation, he published a series of tales, proverbs and songs either from older texts or from oral information; and he made the first collection of popular songs, *Spițaiul amorului*, 'The Hospital of Love' (1829-53), with tunes either composed by himself or obtained from the tipsy musicians who alone performed them. Of his numerous writings two or three are of the greatest interest to folklore. His *Poesiaea vorbii* (first ed. 1 vol., 1847; 2nd ed. 3 vols., 1851-53) is a large collection of proverbs ingeniously connected with one another and leading up to or starting from a popular tale exemplifying the proverb. The *Fabule și istorioare* (2 vols., 1839-41) is a collection of short popular stories in rhyme; *Seastorea la țară* (1852-53) is a description of the Rumanian *Spyntabule*, for which the peasants gather in one of their houses on a winter's night, the girls and women spinning, and the young men telling tales, proverbs, riddles, singing songs, &c. Pann also collected the jokes of the Turkish jester, Nasreddin, under the title of *Năsdărăndă lui Nastratin Hoșea* (1853), also in rhyme. He also published a collection of Christmas carols, set to music by himself; these are still sung by boys on Christmas night.

Far larger than the secular is the religious popular literature; it comprises many apocryphal tales from the Old and the New Testaments, and not a few of the heretical tales circulated by the various sects of Asia Minor and Thracia, which were carried into Rumania through the medium of Slavonic. A brief enumeration of the

Popular literature:
Folklore,
Ballads,
Tales.

chief tales must suffice. Only a few of them have hitherto been published. They exist in numerous MSS, which testify to their great popularity; in the popular songs one finds many traces of their influence upon the people's imagination. They include the *History of Adam and Eve*, the *Legend of the Cross*, the *Apocalypse of Abraham*, the *History of the Sibyl*, the *Legends of Solomon*; numerous New Testament apocryphal tales, starting with legends of St. John the Baptist; a very remarkable version of the *Gospel of Nicodemus*; and the *Epistle of Pilete*. Printed in tens of thousands of copies are certain apocryphal legends dealing with eschatological problems. The ancient *Apocalypse of Peter* appears here under the name of Paul, then there is an *Apocalypse of the Virgin Mary*, who, like Peter, is carried by the Archangel through the torments of Hell and the bliss of Paradise, and through whose intervention sufferers are granted pardon on certain days of the year. Combined with these is the *Sunday Epistle*, sent from Heaven, enjoining strict observance, not only of Sunday, but also of Friday and Wednesday, as holy days. Most of these texts date in their Rumanian form from the 16th and 17th centuries; the *Sunday Epistle* is well known in connexion with the Flagellants. In the same pamphlet as the *Sunday Epistle* was published the legend of St. Sisoë and sometimes that of Avestitza,—the former saved the children of his sister from the attacks of the devil, who had devoured them and had to restore them alive; the latter is the female child-stealing demon, who is prevented by an angel from carrying out her evil design. In both cases the repetition of the legend and the recitation of a string of mystical names serve, like some other tales, apocryphal and otherwise, as amulets, sufficient to protect from the devil. Upon the recitation of some of these texts are many popular charms and incantations. Therein lies the importance of this written literature, for it gives us the clue to much that now lives in the mouths of the people, and is by some considered to be of immemorial antiquity. A number of astrological calendars and prognostics are among the best known and most widely circulated popular books, and the lives of St. Alexius, Xcnophan, &c. have become chapbooks.

The whole of this popular literature belongs to what may be called the cycle of the Balkan nations, in every one of which exact parallels are to be found. Not that there was any direct, deliberate borrowing by one nation from the other, but all of them seem to have stood for a long time under identical psychological influences and to have developed on similar lines. The superstitions of one are often found to be those of the others, and in such a form that they could not have been taken over independently from a third source; they show too much family likeness. Thus also the popular songs of Rumania, the "doine," the "hora," the "cântece," "colinde," "legende," i.e. the love songs, the heroic ballads, legends, songs at the ring-dance, hymns and carols, though distinct with a charm of their own, find their counterparts in many a song, ballad, &c. of the Balkan nations. The heroes are often the same: Serbs, Bulgars and Rumanians sing the heroic deeds of Balu, Vlahs and recite the legend of the Monastery of Iteesh, or the ballad of Iorovan found in the Malaysian Bilyiny. One of the first to collect these treasures of Rumania was V. Alessandri (1852-1866), who, however, retained only their poetical beauty and did not reproduce them with that strict accuracy which modern study of folklore demands. A. M. Marienescu collected those of Transylvania (1859); S. F. Marian, those of the Bukovina (1873); T. T. Burada, those of the Dobruja (1880); but the most complete collection is that of G. Dem. Teodorescu, *Poesii populare române* (Bucharest, 1888). The collection of fairy tales started later than that of the ballads. The first collection is the German translation of tales heard by the Brothers Grimm (1845). One of the most important collections, now universally considered as classical from every point of view, are the successive publications of P. Ispirescu. The collected tales of the Moldavian Ion Creanga (1837-89) appeared in his *Opere complete* (1908). Excellent collections are those of D. Stancescu, *Basme* (1885-1893), I. G. Sghiera, *Basme* (1886), *Frâncu și Căndrea* (1888). Kutzov-Vlach tales and folkloric will be found in G. Weigand, *Die Aromunen*, vol. II. The only review devoted to the study of folklore is the *Șașatoare*, founded in 1892.

In recent times a kind of stagnation seems to have overtaken Rumania, and although attempts have been made to place the intellectual life of the nation on a sounder basis, the work of transition from the past to the present has hitherto absorbed more energy than appears necessary. Whatever the causes may have been, the fact remains, that now there is a great dearth of talent and great poverty in output.

BIBLIOGRAPHY.—M. Gaster, *Chrestomathie roumaine* (2 vols., Leipzig, 1891); id., *Literatura populară română* (Bucharest, 1883); id., "Geschichte der rumänischen Litteratur," in Gröber, *Grundriss der romanischen Philologie*, II, pp. 264-428; L. Șăineanu, *Autorii români moderni* (Bucharest, 1891). (M. G.)

RUMELIA, or **ROUMELIA** (Turkish *Rumili*, "the land of the Romans," i.e. the East Roman or Byzantine empire), a name commonly used, from the 15th century onwards, to denote that part of the Balkan Peninsula which was subject to Turkey.

More precisely it was the country bounded N. by Bulgaria, W. by Albania and S. by the Morea, or in other words the ancient provinces, including Constantinople and Salonica, of Thrace and Macedonia. The name was ultimately applied more especially to a province composed of central Albania and western Macedonia, having Monastir for its chief town. Owing to administrative changes effected between 1870 and 1875, the name ceased to correspond with any political division. Eastern Rumelia was constituted an autonomous province of the Turkish empire by the Berlin treaty of 1878; but on the 18th of September 1885, after a bloodless revolution, it was united with Bulgaria (*q.v.*).

RUMFORD, BENJAMIN THOMPSON, COUNT (1753-1814), British-American man of science, philanthropist and administrator, was born at Woburn, in Massachusetts, on the 26th of March 1753. The Thompson family had been settled in New England since the middle of the previous century, and belonged to the class of moderately wealthy farmers. His father died while he was very young, and his mother speedily married a second time. But he seems to have been well cared for, and he was at the age of fourteen sufficiently advanced "in algebra, geometry, astronomy, and even the higher mathematics," to calculate a solar eclipse within four seconds of accuracy. In 1766 he was apprenticed to a storekeeper at Salem, in New England, and while in that employment occupied himself in chemical and mechanical experiments, as well as in engraving, in which he attained to some proficiency. The outbreak of the American War put a stop to the trade of his master, and he thereupon left Salem and went to Boston, where he engaged himself as assistant in another store. He was at that period between seventeen and eighteen years old, and at nineteen, he says, "I married, or rather I was married." His wife was the widow of Colonel Benjamin Rolfe, and the daughter of Timothy Walker, "a highly respectable minister, and one of the first settlers at Rumford," now called Concord, in New Hampshire. His wife was possessed of considerable property, and was his senior by fourteen years.

This marriage was the foundation of his success. Soon after it he became acquainted with Governor Wentworth of New Hampshire, who conferred on him the majority of a local regiment of militia. He speedily became the object of distrust among the friends of the American cause, and it was considered prudent that he should seek an early opportunity of leaving the country. On the evacuation of Boston by the royal troops, therefore, in 1776, he was selected by Governor Wentworth to carry despatches to England. On his arrival in London Lord George Germain, secretary of state, appointed him to a clerkship in his office. Within a few months he was advanced to the post of secretary of the province of Georgia, and in about four years he was made under-secretary of state. His official duties, however, did not interfere with the prosecution of scientific pursuits, and in 1779 he was elected a fellow of the Royal Society. Among the subjects to which he especially directed his attention were the explosive force of gunpowder, the construction of firearms, and a system of signalling at sea. In connexion with the last, he made a cruise in the Channel fleet, on board the "Victory," as a volunteer under the command of Admiral Sir Charles Hardy. On the resignation of Lord North's administration, of which Lord George Germain was one of the least popular members, he left the civil service, and was nominated to a cavalry command in the revolted provinces of America. But the War of Independence was practically at an end, and in 1783 he finally quitted active service, with the rank and half-pay of a lieutenant-colonel. He now formed the design of joining the Austrian army, for the purpose of campaigning against the Turks, and so crossed over from Dover to Calais with Gibbon, who, writing to his friend Lord Sheffield, calls his fellow-passenger "Mr Secretary-Colonel-Admiral-Philosopher Thompson." At Strassburg he was introduced to Prince Maximilian, afterwards elector of Bavaria, and was by him invited to enter the civil and military service of that state. Having obtained the leave of the British

government to accept the prince's offer, he received the honour of knighthood from George III., and during eleven years he remained at Munich as minister of war, minister of police, and grand chamberlain to the elector. His political and courtly employments, however, did not absorb all his time, and he contributed during his stay in Bavaria a number of papers to the *Philosophical Transactions*. But that he was sufficiently alert as the principal adviser of the elector the results of his labours in that capacity amply prove. He reorganized the Bavarian army; he immensely improved the condition of the industrial classes throughout the country by providing them with work and instructing them in the practice of domestic economy; and he did much to suppress mendicity. The multitude of beggars in Bavaria had long been a public nuisance and danger. In one day he caused no fewer than 2600 of these outcasts and depredaters in Munich and its suburbs alone to be arrested by military patrols, and transferred by them to an industrial establishment which he had prepared for their reception. In this institution they were both housed and fed, and they not only supported themselves by their labours but earned a surplus for the benefit of the electoral revenues. The principle on which their treatment proceeded is stated by him in the following memorable words: "To make vicious and abandoned people happy," he says, "it has generally been supposed necessary first to make them virtuous. But why not reverse this order? Why not make them first happy, and then virtuous?"

In 1791 he was created a count of the Holy Roman Empire, and chose his title of Rumford from the name as it then was of the American township to which his wife's family belonged. In 1795 he visited England, one incident of his journey being the loss of all his private papers, including the materials for an autobiography, which were contained in a box stolen from off his postchaise in St Paul's Churchyard. During his residence in London he applied himself to the discovery of methods for curing smoky chimneys and the contrivance of improvements in the construction of fireplaces. But he was quickly recalled to Bavaria, Munich being threatened at once by an Austrian and a French army. The elector fled from his capital, and it was entirely owing to Rumford that a hostile occupation of the city was prevented. It was now proposed that he should be accredited as Bavarian ambassador in London; but the circumstance that he was a British subject presented an insurmountable obstacle. He, however, again came to England, and remained there in a private station for several years.

In 1798 he presented to the Royal Society his "Enquiry concerning the Source of Heat which is excited by Friction," in which he combated the current view that heat was a material substance, and regarded it as a mode of motion. In 1799 he, in conjunction with Sir Joseph Banks, projected the establishment of the Royal Institution. It received its charter of incorporation from George III. in 1800, and Rumford himself selected Sir Humphry Davy as scientific lecturer there. Until 1804 he lived at the Royal Institution in Albemarle Street, London, or at a house which he rented at Brompton, and he then established himself in Paris, marrying (his first wife having died in 1792) as his second wife the wealthy widow of Lavoisier, the celebrated chemist. With this lady he led an extremely uncomfortable life, till at last they agreed to separate. He took up his residence at Auteuil, where he died suddenly on the 21st of August 1814, in the sixty-second year of his age.

Rumford was the founder and the first recipient of the Rumford medal of the Royal Society. He was also the founder of the Rumford medal of the American Academy of Arts and Sciences, and of the Rumford professorship in Harvard University. His complete works with a memoir by G. E. Ellis were published by the American Academy of Arts and Sciences in 1870-75.

RŪMĪ, (1207-1273). Mahommed b. Mahommed b. Husain albakhi, better known as Maulānā Jalāl-uddīn Rūmī (or simply Jalāl-uddīn, or Jalāl-eddīn), the greatest Sūfī poet of Persia, was born on the 30th of September 1207 (604 A.H. 6th of Rabī' I.) at Balkh, in Khorāsān, where his family had resided from time immemorial. He claimed descent from the caliph Abūbekr,

and from the Khwārizm-Shāh Sultān 'Alā-uddīn b. Tukush (1109-1220), whose only daughter, Malika-i-Jahān, had been married to Jalāl-uddīn's grandfather. Her son, Mahommed, commonly called Bahā-uddīn Walad, was famous for his learning and piety, but being afraid of the sultan's jealousy, he emigrated to Asia Minor in 1212. After residing for some time at Malatya and afterwards at Erzīngān in Armenia, Bahā-uddīn was called to Lāranda in Asia Minor, as principal of the local college. Here young Jalāl-uddīn grew up, and in 1226 married Jauhar Khātūn, the daughter of Lālā Sharaf-uddīn of Samarkand. Finally, Bahā-uddīn was invited to Iconium by 'Alā-uddīn Kaikubād (1219-1236), the sultan of Asia Minor; or, as it is commonly called in the East, Rūm—whence Jalāl-uddīn's surname (*takhalūs*) Rūmī.

After Bahā-uddīn's death in 1231, Jalāl-uddīn went to Aleppo and Damascus for a short time to study, but, dissatisfied with the exact sciences, he returned to Iconium, where he became by and by professor of four separate colleges, and devoted himself to the study of mystic theology. His first spiritual instructor was Sayyid Burhān-uddīn Husaini of Tirmidh, one of his father's disciples, and, later on, the wandering Sūfī Shams-uddīn of Tabriz, who soon acquired a most powerful influence over Jalāl-uddīn. Shams-uddīn's aggressive character roused the people of Iconium against him, and during a riot in which Jalāl-uddīn's eldest son, 'Alā-uddīn, was killed, he was arrested and probably executed; at least he was no more seen. In remembrance of these victims of popular wrath Jalāl-uddīn founded the order of the Maulawī (in Turkish Mevlevī) dervishes, famous for their piety as well as for their peculiar garb of mourning, their music and their mystic dance (*samā*), which is the outward representation of the circling movement of the spheres, and the inward symbol of the circling movement of the soul caused by the vibrations of a Sūfī's fervent love to God. The establishment of this order, which still possesses numerous cloisters throughout the Turkish empire, and the leadership of which has been kept in Jalāl-uddīn's family in Iconium uninterruptedly for the last six hundred years, gave a new stimulus to his zeal and poetical inspiration. Most of his matchless odes were composed in honour of the Maulawī dervishes, and even his *opus magnum*, the *Mathnawī* (*Mesnevī*), or, as it is usually called, *The Spiritual Mathnawī* (*mathnawī-i-ma'navī*), in six books or *daftar*s, with 30,000 to 40,000 double-rhymed verses, can be traced to the same source. The idea of this immense collection of ethical and moral precepts was first suggested to the poet by his favourite disciple Hasan, better known as Husām-uddīn, who in 1258 became Jalāl-uddīn's chief assistant. Jalāl-uddīn dictated to him, with a short interruption, the whole work during the remaining years of his life. Soon after its completion Jalāl-uddīn died, on the 17th of December 1273 (672 A.H. 5th of Jomādā II.). His first successor in the rectorship of the Maulawī fraternity was Husām-uddīn himself, after whose death in 1284 Jalāl-uddīn's younger and only surviving son, Shaikh Bahāuddīn Ahmed, commonly called Sultān Walad, and favourably known as author of the mystical mathnawī *Rabābnāma*, or the Book of the Guitār (died 1312), was duly installed as grand-master of the order.

Jalāl-uddīn's life is fully described in Shams-uddīn Ahmed Afākī's *Manākhil-ul-'arīfīn* (written between A.D. 1318 and 1353), the most important portions of which have been translated by J. W. Rehausen in the preface to his English metrical version of *The Mesnevī, Book the First* (London, 1881); there is also an abridged translation of the *Mathnawī*, with introduction on Sūfism, by E. H. Whinfield (2nd ed., 1898). Complete editions have been printed in Bombay, Lucknow, Tabriz, Constantinople and in Bulaq (with a Turkish translation, 1268 A.H.), at the end of which a seventh *daftar* is added, the genuineness of which is refuted by a remark of Jalāl-uddīn himself in one of the Bodelean copies of the poem, Ouseley, 294 (f. 328a seq.). A revised edition was made by 'Abd-ullatif (1204 and 1032 A.H.), and the same author's commentary on the *Mathnawī*, *Lata'if-us-samā' nawā*, and his glossary, *Lata'if-ul-lughā*, have been lithographed in Cawnpore (1876) and Lucknow (1877) respectively, the latter under the title *Farhang-i-mathnawī*. For the other numerous commentaries and for further biographical and literary particulars of Jalāl-uddīn, see Rieu's *Cat. of the Persian MSS*

of the Brit. Mus., vol. ii. p. 584 seq.; A. Sprenger's *Oudh Cat.*, p. 489; Sir Gore Ouseley, *Notices of Persian Poets*, p. 112 seq.; H. Été, in *Morgenländische Studien* (Leipzig, 1870), p. 95 seq., and in Geiger and Kuhn's *Grundriss der iranischen Philologie* (Stuttgart, 1896-1904), vol. ii. pp. 287-292. Selections from Jalāl-uddin's diwan (often styled *Diwān-i-Shams-i-Tabrīz*) are translated in German verse by V. von Rosenzweig (Vienna, 1838); into English by R. A. Nicholson (2nd ed., 1898) and W. Hastie (1903). (H. E.)

RUMINANTIA, a term employed by Cuvier to include all the existing artiodactyle ruminating ungulate mammals now classed under the groups Pecora, Tylopoda and Tragulina. By Professor Max Weber it is employed as a collective designation for these groups, together with the extinct Anthracotheroidea and Dichobunioidea; but its use seems best restricted to a general term rather than a definite systematic group. (See ARTIODACTYLA, PECORA, TYLOPODA.)

RÜMKER, CARL LUDWIG CHRISTIAN (1788-1862), German astronomer, was born in Mecklenburg on the 28th of May 1788. He served in the British navy from 1807 until 1817, and was director of the school of navigation at Hamburg from 1819 till 1820. In 1821 he went to New South Wales as astronomer at the observatory built at Parramatta by Sir Thomas Brisbane. He returned to Europe in 1830 and took charge of the observatory at Hamburg. His chief work was concerned with the cataloguing of stars: a preliminary catalogue of the stars of the S. hemisphere was published in 1832 at Hamburg, and in 1846-52 he published his great catalogue of 12,000 stars. In 1857 he went to reside at Lisbon, where he died on the 21st of December 1862.

His son, **GEORGE FRIEDRICH WILHELM** (1832-1900), born on the 31st of December 1832, at Hamburg, was astronomer at the observatory at Durham, England, from 1853 to 1856. He then became assistant at the Hamburg observatory, and in 1862 was appointed director of the same institution. From 1884 he was the Hamburg delegate for the International Earth Measurement. He died on the 3rd of March 1900.

RUNCIMAN, ALEXANDER (1736-1785), Scottish historical painter, was born in Edinburgh in 1736. He studied at Foulis's Academy, Glasgow, and at the age of thirty proceeded to Rome, where he spent five years. It was at this time that he became acquainted with Fuseli. The painter's earliest efforts had been in landscape; he soon, however, turned to historical and imaginative subjects, exhibiting his "Nausicaa at Play with her Maidens" in 1767 at the Free Society of British Artists, Edinburgh. On his return from Italy, after a brief residence in London, where in 1772 he exhibited in the Royal Academy, he settled in Edinburgh, and was appointed master of the Trustees' Academy. He was patronized by Sir James Clerk, whose hall at Penicuik House he decorated with a series of subjects from Ossian. He also executed various religious paintings and an altar-piece in the Cowgate Episcopal Church, Edinburgh, and easel pictures of "Cymon and Iphigenia," "Sigismunda weeping over the Heart of Tancred," and "Agrrippina landing with the Ashes of Germanicus." He died in Edinburgh on the 4th of October 1785. His works, while they show high intention and considerable imagination, are frequently defective in form and extravagant in gesture. His younger brother, **JOHN RUNCIMAN** (1744-1766), who accompanied him to Rome, and died at Naples in 1766, was an artist of great promise. His "Flight into Egypt," in the National Gallery of Scotland, is remarkable for the precision of its execution and the mellow richness of its colouring.

RUNCORN, a market town and river-port in the Northwich parliamentary division of Cheshire, England, on the S. of the estuary of the Mersey 16 m. above Liverpool. Pop. of urban district (1901) 16,401. It is served by the London & North-Western railway, and has extensive communications by canal. The modern prosperity of the town dates from the completion in 1773 of the Bridgewater Canal, which here descends into the Mersey by a flight of locks. Runcorn is a sub-port of Manchester, with which it is connected by the Manchester Ship Canal, and has extensive wharfage and warehouse accommodation. The chief exports are coal, salt and pitch; but

there is also a large traffic in potters' materials. A transporter bridge between Runcorn and Widnes, with a suspended car worked by electricity to convey passengers and vehicles (the first bridge of the kind in England) was constructed in 1902. The town possesses shipbuilding yards, iron foundries, rope works, tanneries, and soap and alkali works.

Owing to the Mersey being here fordable at low water, Runcorn was in early times of considerable military importance. On a rock which formerly jutted into the Mersey Æthelfleda erected a castle in 916, but of the building there are now no remains; while the rock was removed to further the cutting of the ship canal. Æthelfleda is also said to have founded a town, but it is not noticed in Domesday. The ferry is noticed in a charter in the 12th century.

RUNDALÉ (apparently from "to run" and "dale," valley, originally something separated off, cf. "deal"), the name of a form of occupation of land, somewhat resembling the English "common field" system. The land is divided into discontinuous plots, and cultivated and occupied by a number of tenants to whom it is leased jointly. The system was common in Ireland, especially in the western counties. In Scotland, where the system also existed, it was termed "run-rig" (from "run," and "rig" or "ridge").

RUNEBERG, JOHAN LUDVIG (1804-1877), Swedish poet, son of a sea-captain, was born at Jakobstad, in Finland, on the 5th of February 1804. He was brought up by an uncle at Uléåborg, and entered the university of Åbo in the autumn term of 1822. In 1823 he broke off his studies to act as tutor in two quiet Finnish villages, Saarijärvi and Ruovesi, where he gained a thorough knowledge of the popular life and poetry, and on his return to Åbo he began to contribute verses to the local newspapers. In the spring of 1827 he received the degree of doctor of philosophy. The university had been removed after the great fire of 1827 to Helsingfors, where Runeberg became, in 1830, amanuensis to the council of the university. In the same year he published at Helsingfors his first volume of *Dikter* (Poems), and a collection of *Serbiska folksånger* (Serbian folksongs) translated into Swedish. In 1831 his verse romance of Finnish life, *Grafven i Perrho* (The Grave in Perrho), received the small gold medal of the Swedish Academy, and the poet married Fredrika Charlotta Tengström, daughter of the archbishop of Finland. In the same year he was appointed university lecturer on Roman literature. In 1832 he published his beautiful little idyll, *Elgskytterne* (The Elk-Hunters); and in 1833 a second collection of lyrical poems. He founded in 1832 the *Helsingfors Morgonblad*, a paper which dealt chiefly with aesthetic and literary questions, and exercised great influence both in Sweden and Finland. In it appeared many of his own poems and tales. His comedy, *Friaren från Landet* (The Country Lover, 1834), was not a success, but in 1836 he published *Hanna*, a charming idyll of Finnish country life, written in hexameters. In 1837 Runeberg accepted the chair of Latin at Borgå College, and resided in that little town for the rest of his life.

He was now recognized in his remote Finland retirement as second only to Tegnér among the poets of Sweden. In 1841 he published *Nadeschda*, a romance of modern Russian life, and *Julqvällen* (Christmas Eve), another idyll of Finnish life. The third volume of his *Dikter* bears the date 1843, and the noble cycle of unrhymed verse romances called *Kung Fjalor*, the setting of which is taken from old Scandinavian legend, was published in 1844. Finally, in 1848, he achieved a great popular success by his splendid series of poems on the war of independence in 1808, when Swedes and Finns fought side by side. The series bears the name of *Fänrik Sids Sägner* (Ensign Steel's Stories); a second series appeared in 1860. From 1847 to 1850 the poet was rector of Borgå College, a post which he resigned to take the only journey out of Finland which he ever accomplished, a visit to Sweden in 1851. In 1854 he collected his prose essays into a volume entitled *Smärre Berättelser*. In the same year he was made president of a committee for the preparation of a national Psalter, which

issued, in 1857, a psalm-book largely contributed by Runeberg for public use. He once more attempted comedy in his *Kan ej* (Can't) in 1862, and tragedy, with infinitely more success, in his stately *Kungarne på Salamis* (The Kings at Salamis) in 1863. Runeberg died at Borgå on the 6th of May 1877. His writings were collected by C. R. Nyblom in six volumes in 1870, and his posthumous writings in three volumes (1878-79).

The poems of Runeberg show the influence of the Greeks and of Goethe upon his mind; but he possesses a great originality. It is hardly possible to over-estimate the value of his patriotic poems as a link between the Swedish and Finnish nations. He has remained one of the most popular Swedish poets, although his whole life was spent in Finland.

An account of his life and works by C. R. Nyblom is prefixed to the *Samlade Skrifter* of 1870. For a minute criticism of Runeberg's principal poems, with translations, see Gosse's *Studies in the Literature of Northern Europe* (1879). A selection of his lyrical pieces was published in an English translation by Messrs Magnusson & Palmer in 1878. There are also monographs on Runeberg by Dietrichson and Langcken (Stockholm, 1864), by Cygnæus (Helsingfors, 1873), by Ljunggren (Lund, 1882-83), and Pechner (Stuttgart, 1881).

RUNES, RUNIC LANGUAGE AND INSCRIPTIONS. The art of writing with an alphabet appears to have been introduced into Germanic Europe in the Iron Age. Something hieratic and mysterious was involved in the idea of letters as used to convey thought, and from the earliest recorded times they were called *runes*, from the Gothic *runa* (*rūn*, in Icelandic), which originally means a secret thing, a mystery, and was later used to describe a letter of the ancient language (see ALPHABET and SCANDINAVIAN LANGUAGES). The Iron Age is supposed to have existed from *circa* 200 to *circa* 650, and it is to the close of this epoch that the beginning of the writing on Scandinavian memorials is attributed. There are runes which have been discovered in England, and some also on the Germanic mainland of Europe, but it is in the Scandinavian peninsula that the vast majority of inscribed monuments have been discovered. The custom of erecting runic monuments, *i.e.* stones engraved with more or less literary statements, over the bodies of the dead, was practised first, there can be no doubt, in Norway and Sweden, then spread to Denmark and over the whole North of Europe. It is remarkable, however, that two of the three runic alphabets from which our knowledge of the whole range of rune-literature is founded, were discovered outside Scandinavia. These three alphabets exist, the first on a thin gold *bractea* found in 1774 at Vadtstena, in Sweden; the second on a bracelet, dug up at Charnoy, in Burgundy; the third on a knife, found in the Thames in 1857, and now in the British Museum. There are two principal runic alphabets, the older consisting of 24 letters, and beginning with *f*; the later of 16 letters. During the last century before the introduction of Christianity, the larger alphabet was increased by 3 letters.

The oldest runes which have been examined are those found on the Thorsbjerg Shield-buckle, which is at present in the Kiel Museum; here the writing, which runs from right to left in straight lines, is of the fourth or fifth century. Other invaluable sources of runic knowledge are the diadem of Straarur, the Vimose comb and the brooch of Himlingöje, which was found in the Vier Fen. Still greater importance has the Golden Horn, discovered at Gellehuus, near Tondern, in 1734; this monument was stolen by thieves and melted down, but fortunately not until a careful copy of it had been made, which is now in the Museum at Copenhagen. It is not until the 6th century that the runic stones begin. The most ancient are believed to be those of Einang, of Tune, of Strand, of Varnum, of Tanum and of Berga. Perhaps a little later are the stones at Vaanga, Skärkind, Skaalång, Torvik, Bö and others, too numerous to mention, but all, as seems likely, erected between 550 and 600. On the famous Tune-stone, the name of the author of the inscription is preserved, "I Wiwar made these runes," and this is not an isolated instance. The original direction of the runic writing was from left to right, like Latin, but quite early the reverse method was introduced. A union

of these forms produced more complicated systems, in which much was left to the individual taste.

From the earliest times uninscribed memorial stones in Scandinavia, *bautasteinar*, were raised to preserve the memory of the dead, and these certainly partook of a more or less religious and sacrificial character. It is evident that, during the Iron Age, stones continued to be erected which had no inscriptions, after the runic alphabets had been invented, and that at first the runes were added only in cases of great importance or solemnity. These runic stones were as a rule posed on the top of the grave, or by the side of it, on mounds, of which only one example survives, that of the stone of Einang, in Norway. But runic stones were not infrequently placed in the grave itself. These were smaller than those erected outside the grave, and they did not lend themselves to lengthy or elaborate inscriptions. The majority of graves containing such small rune-stones, bearing merely the name of the deceased or a magical sentence, have been found in Norway. But the antiquity of most of these is questioned, that of Vatn, which is the oldest, being now placed no earlier than the 8th century. The very important stone of Valdbý, which is the oldest Norwegian monument employing the shorter alphabet, is attributed by Wimmer to heathen times, indeed, but to a date no earlier than the second half of the 9th century. It is supposed that the most ancient of the runic stones of Sweden, those respectively of Vånga, Skärkind and Kinnevad, must have come from the interior of graves, but there is no certain proof of this. The latest criticism tends to the belief that when runes were first inscribed on Scandinavian monuments, they were placed both upon and inside graves, but that after the runic letters had been used for about a century, the latter custom tended to exclude the former. About the year 800 both customs began to invade Denmark, the practice of placing the rune-stones inside, however, soon getting the upper hand. It is a curious fact that in Iceland not a single rune-stone which can be referred back to heathen times is known to exist; the Icelandic rune-stones all date from a period well advanced in the middle ages. It was the old theory that the ancient stones had mouldered away under stress of weather, but that is abandoned, and it is now supposed that the aristocratic exiles from Norway, who settled in Iceland, had not yet adopted in their old home the practice of inscribed monuments to their dead. There were *bautasteinar* in Iceland, as we know, but there is no evidence that these bore runes upon them.

It is in Denmark that the runic inscriptions exist which possess the highest literary interest. These are all attributed to the beginning of the 9th century. The Kallerup Stone was discovered in 1826 at the village of Højetostrup, a Danish mile E. of Roskilde; it has been lifted and placed in its original position. This monument contains a statement in old Danish, to the effect that it marks the grave of Hornbora, son of Swidi. The Stone of Snoldelev was discovered in 1768, not far from the spot where the Kallerup Stone was found; it is now in the Archaeological Museum at Copenhagen; this has a long and important inscription in a form of old Scandinavian, allied to the classical Icelandic. The Stone of Helnaes was found on the islet of that name in 1860, and is now at Copenhagen. The other most famous runic monuments are those of Flemlöse, Öra, Nörenaerå, Glarendrup, Frygevaelde and Rönninge, of all of which Wimmer has published full analytical descriptions.

These inscriptions are of remarkable value as historical documents, from a period of which no other definite records remain in existence. From a literary point of view, they represent what Germanic language was up to the point at which Ulfilas created a new alphabet for his version of the Bible, by adapting to the runic alphabets a number of Greek letters. It was an error, now exploded, to suppose that the *notae impressae*, which Tacitus describes in his *Germania*, were written runes; these were simply signs, or mystic marks, which had no linguistic significance. These are described in the staves of the *Edda* as having been revealed to mankind by the god Odin,

and they were of a hieratic character. The suggestion is that the written runes were introduced from the south of Europe by a Phœnician agency, and that they were copied from Greek or Roman coins which had found their way to Scandinavia. In several of the sagas it is recorded that runes were inscribed on round pieces of wood, called *kefli*, or runic sticks. It has been suggested that the Eddic poems were preserved in this way, but the only authority for this is that the *Somatorrek* is said to have been taken down on a *kefli*. In Christian times runes came to be regarded as an archaic curiosity, and were engraved on sticks, chairs and spoons; a loto stick with runes on it is preserved in the Bodleian library. In the *Fornsgögur* runes are mentioned as carved on the blade of an oar. Even cases occur in which the normal Latin alphabet was called *rúnamál* or a language of Runes. A runic letter was called a *rúnastafur* in Icelandic.

AUTHORITIES.—Ludwig F. A. Wimmer, *Runeskriftens oprindelse og udvikling i Norden* (Copenhagen, 1874); L. F. A. Wimmer, *Die Runenschrift* (Berlin, 1887); J. Taylor, *Greeks and the Goths: a Study on the Runes* (London, 1879); G. Stephens, *The Old-Northern Runic Monuments of Scandinavia and England* (Copenhagen, 1879); Bugge, *Tolkning af runeindskrifter på Rökstenen i Östergötland* (Stockholm, 1878); Cleasby and Vigfússon, *Icelandic-English Dictionary* (Oxford, 1874); Wilhelm Grimm, *Ueber deutsche Runen* (Göttingen, 1821); Olsen, *Runerne i den oldnordiske Litteratur* (Christiania, 1891). (E. G.)

RUNG, a short round bar or stick used as a cross-bar or rail in a chair, and particularly as one of the steps or rounds of a ladder. In Scottish the word retains the original meaning of a staff or stick, especially a short thick cudgel. The O.E. *hrung* is used only of a bar or rail in a wagon; the word also occurs in O.Du. *ronge*, beam of a plough, Ger. *Runge*, pin, bolt.

RUNNIMEDE, or **RUNNYMEDE**, a meadow on the S. bank of the river Thames, England, in the county of Surrey and the parish of Egham. It is celebrated in connexion with the signature of Magna Carta (*q.m.*) by King John on the 15th of June 1215. It has been disputed whether the ceremony took place actually in the meadow or on Magna Carta or Charter Island lying off it. The charter itself indicates Runnimede by name, but this may have included the island, which is the traditional site and was in 1217 the meeting-place of Henry III. and Louis (afterwards Louis VIII.) of France.

RUNNING, the most primitive form of athletic exercise considered as a sport. Athletic apparatus of every kind has been improved in modern times, but the spiked running-shoe may be said to represent the sole advantage enjoyed by the modern runner over his Olympic prototype. As an athletic sport running has been in vogue from the earliest times, and the simple foot-race (*δρόμος*), run straight away from starting-point to goal, or once over the course of the stadion (a little over 200 yds.), formed an event in the Greek *pentathlon*, or quintuple games (see GAMES, CLASSICAL). It was diversified with the race once over the course and return, and the *δίαυλος*, a long run many times (often as many as twelve, *i.e.* about 2½ m.) up and down the stadion. There was also the *δρόμος ἄσπιδων*, a short race for warriors, who wore full armour and carried sword and shield, which has been imitated by the modern military race in full marching order. Except in the warriors' race the Greek runners were naked, save occasionally for a pair of light shoes. No records of the times made by the runners in the Greek races have been handed down. It may be inferred that the contests were very severe, since the ancient Olympic chronicles preserve the memory of several runners, of whom Ladas was the most conspicuous, who fell dead at the completion of the long course, and were buried in state with their brows encircled by the victor's chaplet. In ancient Italy running was practised in circus exhibitions, as described by Virgil (*Aen.* v. 286 seq.).

In the middle ages the best runners were oftenest found among the couriers maintained by potentates and municipalities, those of Tartary, England, Scotland, Italy and the Basque country having enjoyed the greatest reputation, while the Peichs, or Persian couriers of the Turkish sultans, often

ran from Constantinople to Adrianople and back, a distance of about 220 m., in two days and nights. Many couriers carried silver beads in their mouths to obviate thirst. Couriers (*syce*) who run before the carriages of their masters are still in use in the East. In the districts of India not traversed by railways, dak runners are still employed to carry the mails from village to village, many wearing bells about their necks to frighten away the tigers. The runners of the American Indians were famous, and extraordinary tales are told of their swiftness and endurance.

In all parts of Great Britain, running at short distances, as well as steeplechases and cross-country runs, has been popular for many centuries, each district and period having its champions, some of whom achieved national reputation. During the Puritan rule and that of Charles II. athletic sports all but died out in England, only to be revived with renewed vigour in the early part of the 19th century, when the public schools and universities began to pay more attention to them. A significant event in the history of running was the institution of the famous "Crick Run" (cross-country) at Rugby in 1837. The establishment of the Cambridge University sports (1857), the Oxford sports (1860), and the British championship meetings (1866) placed athletics upon a formal and recognized basis. Records made thereafter received the stamp of authenticity, those made in former years being doubtful on account of lax measurements and timing. In the United States and Canada authentic records date from the institution of the American Championships in 1876. The National Association of Amateur Athletes of America was formed in 1880.

Running at the present day is divided into sprinting (distances up to one-quarter of a mile), middle-distance running (from one-quarter of a mile to 1000 yds.) and long-distance running (over 1000 yds.).

Sprinting consists of running over short distances with a full and continuous burst of speed, the chief distances being 100 yds., 220 yds. and quarter-mile. Distances up to and including 220 yds. are in America called *dashes*. The course for sprinting races, when run in the open air, is marked off in lanes for the individual runners by means of cords stretched upon short iron rods. Starting in sprints has now become very expert. The old method of dropping a handkerchief was the worst possible way to give the starting signal, since the muscles react most slowly to impressions of sight, less so to those of touch, and most quickly to those of sound, a difference of $\frac{1}{8}$ of a second in reaction amounting to over one foot in a run of 100 yds. All modern foot-races are therefore started by the pistol; the runners wait for the signal in a crouching attitude, with the fingers of both hands resting on the ground on each side of the body, from which position they spring upwards and forwards at the sound of the pistol. The crouching start was found to be much quicker in getting off the mark than the upright attitude formerly adopted, and by 1892 had been adopted by all first-class sprinters in America, and a year or two later in Great Britain. Another advantage is that the runner is steadier on the mark, and since its adoption the prescribed penalty of being placed one yard behind the mark for starting before the pistol-shot has been very seldom enforced, and the risky experiment of "beating the pistol," *i.e.* letting the body fall forward in the hope that the shot would come before the feet had to be moved, has practically disappeared.

The improvement in training and the adoption of the crouching start have resulted in the continued reduction of sprinting records. "Even time," or 10 secs., is still considered a fine performance for the hundred yards, but has been repeatedly beaten both in England and America. A. F. Duffey, who, like C. A. Bradley and J. W. Morton, won the English championship in four successive years, shares with D. J. Kelly the record, 9½ secs., for 100 yds.; and J. W. Morton, a Scot, as well as J. H. Hempton and W. T. Macpherson of New Zealand, are credited with 9½ secs. The excellence of American runners in the sprints is probably accounted for partly by temperament influenced by climate; but the American practice of running

short races of from 50 to 75 yds. during the numerous indoor meetings held in winter-time offers excellent training in starting and getting rapidly into full stride.

The best time for the eighth mile (220 yds.), a distance often run in America, is 21½ secs., made in 1896 on a straightaway track by B. J. Wefers.

The quarter-mile (440 yds.) is almost always run on a curved track, and hence a quick start is important, for should the runner who has the advantage of the inside position allow himself to be outrun in the distance to the first turn, one of his opponents is likely to cut in and deprive him of it, while on the other hand a runner on the outside must actually outrun the inside man in order to be on even terms after the turn. The element of strategy, unknown in straight sprints, thus enters into the quarter. Speed is, of course, the chief requisite for a quarter-miler, but a certain amount of staying power is also necessary. The standard time for the quarter is 50 secs., which means an average speed of 11.3 secs. for each 100 yds. round the course. That of M.W. Long of Columbia University, who made the record, 47 secs., in 1900, was on that occasion 10.68 secs. for each hundred yards.

The system of "relay races," usually run by four men each going a quarter of the distance, is a popular variety. The favourite distance is a mile, each man running a quarter at the top speed. This method of racing was introduced in the United States about the year 1890 on the model of the Massachusetts firemen's "bean-pot" races, and has since become very popular there. The old method was for the men running the second quarter of the course to wait on the mark for the first relay men to arrive, and then, snatching small flags from their hands, to continue the race, handing over the flags to the third relay upon completing their quarter. The flags, being cumbersome, were afterwards abandoned, and the new runners are now required only to touch the persons of the preceding contestants. The 1 m. record, 3 min. 21½ secs., was made in 1898 by B. J. Wefers, M. W. Long, T. E. Burke and H. S. Lyons of the New York Athletic Club.

Middle-Distance Running.—The chief middle distances are 600 yds., 660 yds., 880 yds. (half-mile) and 1000 yds., but of these the half-mile is the only one commonly recognized in championship sports. Endurance is more important at these distances, though speed is essential, and the element of strategy increases. An element unknown to sprinting enters into middle- and long-distance runs, namely that of pace-making; even when the real race is between two individuals at least one runner on each side takes part in the contest, in order to "make the pace" for his principal. Emilio Lunghi (U.S.A.) holds the half-mile world's record of 1 min. 52½ secs., made in 1909. J. F. K. Cross of Oxford University ran the half-mile at Oxford in 1888 in 1 min. 54½ secs. The record for 1000 yds., 2 min. 13 secs., was made by L. E. Myers (U.S.A.). The distance of three-quarters of a mile is seldom run now at large meetings.

Long-Distance Running.—This includes all flat races of 1 m. or more, as well as steeplechasing, hare-and-hounds, and other forms of cross-country running. Great Britain has always been the home of long-distance running, different forms of cross-country racing having been popular all over the kingdom for centuries. In England at the championship meeting the distance events on the flat are the 1 m., 4 m. and 10 m. races, and in the inter-university sports the 1 m. and 3 m.; in America the distances are 1 m., 2 m. and 5 m.; but any and all of these distances are often included in important British and American programmes. Hard daily training is necessary for a distance runner. Good pace-making and strategy in general are of great importance. The runner must learn to "run to the watch," i.e. to cover the different portions of the distance in a certain time, in order to be placed most advantageously for the finish. The mile race requires speed as well as stamina. Most champion milers are capable of doing the half under 2 min. The record for the mile, made in 1886 at Lillie Bridge by W. G. George, as a professional, is 4 min., 12½ secs.; the amateur record is 4 min.

15½ secs., made by T. P. Conneff in America, J. Binks, holding the British amateur record with 4 min. 16½ secs., made at Stamford Bridge in 1902. The longer-distance races require more stamina than speed, and a careful husbanding of strength.

The following table gives the records (up to 1908) for the distance runs on the flat, longer than 1 m.:—

Distance.	Name.	Time.	Date.	Place.
		h. m. s.		
2 miles	A. Shrubbs	9 9½	1904	Glasgow
3 "	A. Shrubbs	14 17½	1903	Stamford Bridge
4 "	A. Shrubbs	19 23½	1904	Glasgow
5 "	A. Shrubbs	24 33	1904	Stamford Bridge
10 "	A. Shrubbs	50 40½	1904	Glasgow
15 "	F. Appleby	1 20 4½	1902	Stamford Bridge
20 "	G. Crossland	1 51 54	1894	Stamford Bridge
30 "	J. A. Squires	3 17 36½	1885	Balham
40 "	J. E. Dixon	4 46 54	1884	Birmingham
50 "	J. E. Dixon	6 18 26½	1885	Balham.

In addition to the records for the above-mentioned distances, Shrubbs held in 1908 the records for 6, 7, 8, 9 and 11 m., and also for the greatest distance covered in 1 h., namely, 11 m. 13½ yds. He won the 4 m. and the 10 m. British championship 1901-4 inclusive, and the 1 m. championship 1903 and 1904; also the French 1 m. and 3 m. championship 1902-4 inclusive. Shrubbs was moreover a first-rate cross-country runner also; he won the British 10 m. cross-country championship 1901-4 inclusive, and the international 8 m. cross-country championship 1902-4. In 1863 a full-blooded Seneca Indian, L. Bennet, known as "Deerfoot," ran 12 m. in 1 h. 2 m. 2½ secs.

Real *cross-country running* is a fast jog over hill and dale. It may take the form of a race from the gymnasium or clubhouse across the fields to a given spot and back again, passing certain objects or buildings; of a practice run behind the coach preparatory to a long-distance race on the track; or of a paper-chase, or hare-and-hounds, the "hares," two or three in number, starting a few minutes before the "hounds," and leaving a trail of scraps of paper dropped from bags, which must be followed by the "hounds." In Great Britain the standard distance is 10 m., but in America it is somewhat less, the distance for the intercollegiate championship race being 6½ m.

Steeplechasing was originally only a cross-country run over a course plentifully provided with natural obstacles, such as brooks, ditches, fences and hedges; but at the present day the steeplechase takes place in the inner enclosure of an athletic field and the obstacles are artificial. They are placed about 70 or 80 yds. apart, and consist of hurdles, a stone wall about 3 ft. high and 2 or 3 ft. broad, and a water-jump, a ditch about 6 ft. broad filled with water and guarded by a wall or fence covered with thick furze or other thick shrubbery. Steeplechase courses differ widely, but the usual distance both in Great Britain and America is 2 m. The time necessary to cover this distance varies according to the difficulties of the course, but a few seconds under 11 min. is considered very fast time.

Team-racing is a favourite form of distance running, each team consisting of 10 men and the distance usually 4 m., the standard of the modern Olympic Games. Different systems of scoring are in vogue, but the usual one allows the winner ten points, the second to arrive nine, and so on, the tenth arrival scoring one. The team aggregating the highest number of points wins.

Among modern distance events the *Marathon Run* of about 40 kilometres (24 m. 1500 yds.) is the most important. It was introduced in the first revived Olympic Games at Athens in 1896 (see ATHLETIC SPORTS) in memory of the famous Greek runner who was said to have brought the news of the battle of Marathon in Athens, dropping dead when his task was finished.

RUODLIEB, a romance in Latin verse by an unknown German poet who flourished about 1030; he was almost certainly a monk of the Bavarian abbey of Tegernsee. The poem is one of the earliest German romances of knightly adventure, and its vivid picture of feudal manners gives it a certain value as an historical document. The poet was probably an eye-witness of the episode (ll. 4231-5221) which represents the meeting of the emperor Henry II. with Robert of France on the banks

of the Maas in 1023. *Ruodlieb* was left unfinished, and furthermore the MS. was cut up and used for binding books, so that the fragments were only gradually discovered (from 1807 onwards) and pieced together. The framework of the story is borrowed from a popular *märchen* of the youth who takes service away from home, and is paid in wise saws instead of current coin. He receives at the same time a loaf, with instructions not to cut it until he is once more at home. This contains the coins. The proverbs, usually three in number, were increased in *Ruodlieb* to twelve, each of which was the starting-point of an episode by which the hero was made to appreciate its value.

For examples of the three- proverb tale see W. Bottrell, *Traditions and Hearthside Stories* (Penzance, 2nd series, 1873); Cuthbert Bede, *The White Wife*... (London, 1868); K. V. K. Jilling, *Erin* (Stuttgart and Tübingen, 1849), and others in the French romance of the *Saint Graal*, in the *Gesta Romanorum* (the three proverbs bought by Domitian) and the old French *Du des trois pommes*. The best edition of *Ruodlieb* is by F. Seiler (Halle, 1882). There is a modern version by M. Heine (Leipzig, 1897), and a full analysis of the contents is given by R. Koegel, *Gesch. d. deutschen Lit. bis zum Ausgange des Mittelalters* (Strassburg, 1894-97, ii. pp. 342-412).

RUPAR, a town of British India, in Umballa district of the Punjab, on the left bank of the river Sutlej, 43 m. N. of Umballa, 1120 ft. above sea-level. Pop. (1901) 8888. It was the scene of Ranjit Singh's visit to Lord William Bentinck when governor-general in 1831. Here are the head works of the Sirhind canal. Rupar has manufactures of cotton twill and hardware. Hindu and Mahomedan fairs are held.

RUPEE (Hindustani *rupiya*, from Sanskrit *rupya*), the standard coin of the monetary system in India. A silver coin of 175 grains Troy, called *tanka*, approximating to the rupee, was struck by the Mahomedan rulers of Delhi in the 13th century; but the rupee itself, of 179 grains, was introduced by Sher Shah in 1542. The English at first followed various indigenous standards; but since 1835 the rupee has uniformly weighed 180 grains, containing 165 grains of pure silver. The weight of the rupee (one *tola*) is also the unit upon which the Indian standard of weights is based. Down to about 1873 the gold value of the rupee was 2s., and ten rupees were thus equal to £1; but after 1873, owing to the depreciation of silver, the rupee at one time sank as low in value as 1s. In order to provide a remedy the government of India decided in 1893 to close the mints, and in 1899 to make the rupee legal tender at fifteen to £1. This policy proved successful, and since 1899 the exchange value of the rupee has practically remained at 1s. 4d. Therefore a lakh of rupees, which before 1873 was worth £10,000, is now only worth £6666, and a crore of rupees, which was formerly a million sterling, now only amounts to £666,666. The rupee is divided into sixteen annas, now worth rd. each, and the anna is subdivided into 12 pies. (See INDIA, and MONEY.)

RUPERT (HRODBERT), ST., according to the *Gesta Sancti Hrodberti*, which dates from the 9th century, was a kinsman of the Merovingian house, and bishop of Worms under Childbert III. (695-711). At the invitation of Th. duke of Bavaria, Theodo II., Rupert went to Regensburg (Ratisbon), where he began his apostolate. He founded the church of St Peter near the Wallerse, and subsequently, at Salzburg, the church of St Peter, together with a monastery and a dwelling for the clerks, as well as a convent for women "in superiori castro Iuvavensium." He died and was buried at Salzburg. He is regarded as the apostle of the Bavarians, not that the land was up to that time altogether heathen, but because of his services in the promotion and consolidation of its Christianity.

See *Bibliotheca hagiographica Latina* (Brussels, 1899), n. 7390-7403; W. Levison, "Die älteste Lebensbeschreibung Ruperts von Salzburg" in *Neues Archiv für ältere deutsche Geschichtskunde*, xviii. 283 seq.; Hauck, *Kirchengeschichte Deutschlands* (3rd ed.), i. 372 seq. (H. DE.)

RUPERT, PRINCE, COUNT PALATINE OF THE RHINE AND DUKE OF BAVARIA (1619-1682), third son of the elector palatine and "winter king" of Bohemia, Frederick V., and of Elizabeth,

daughter of James I. of England, was born at Prague on the 17th of December 1619. A year later his father was defeated at the battle of the Weisser-Berg, near Prague, and driven from Bohemia. After many wanderings the family took refuge in Holland, where Rupert's boyhood was spent. In 1633 the boy was present at the siege of Rheinberg in the suite of the Prince of Orange, and in 1635 he served in this prince's bodyguard. In 1636 he paid his first visit to England, was entered as an undergraduate, though only nominally, at St John's College, Oxford, and was named as the governor of a proposed English colony in Madagascar. But this scheme did not mature, and Charles sent his nephew back to Holland, having, however, formed a high opinion of his energy, talent and resolution. In 1637 he was again serving in the wars, and in 1638, after displaying conspicuous bravery, he was taken prisoner by the imperialists at the action of Vlotho (17th October) and held in a not very strict captivity for three years. In 1641 he was released, and, rejoining his mother in Holland, was summoned to England to the assistance of his uncle, for the Great Rebellion was about to break out.

In July 1642 he landed at Tynemouth. Charles at once made him general of the horse and independent of Lord Lindsey, the nominal commander of the whole army. From this point until the close of the first Civil War in 1646 Prince Rupert is the dominant figure of the war. His battles and campaigns are described in the article GREAT REBELLION. He was distinctively a cavalry leader, and it was not until the battle of Marston Moor in 1644 that the Royalist cavalry was beaten. The prince's strategy was bold as well as skilful, and was shown both in the Royalist movements of 1644 which he proposed, and in the two far-ranging expeditions which he carried out for the relief of Newark and of York. In November 1644, in spite of the defeat at Marston Moor, he was appointed general of the king's army. But this appointment, though welcome to the army, was obnoxious to the king's counsellors, who resented the prince's independence of their control, to some of the nobility over whose titles to consideration he had ridden roughshod, and to some of the officers whose indiscipline and rapacity were likely to be repressed with a heavy hand. These dissensions culminated, after the prince's surrender of Bristol to Fairfax, in a complete break with Charles, who dismissed him from all his offices and bade Rupert and his younger brother Maurice seek their fortunes beyond the seas.

Rupert's character had been tempered by these years of responsible command. By 1645, although the parliamentary party accused him not merely of barbarity but of ingratitude for the kindnesses which his family had received from English people in the days of the Palatinate War, Rupert had in fact become a good Englishman. He was convinced, after Marston Moor, that the king's cause was lost, in a military sense, and moreover that the king's cause was bad. When he surrendered Bristol without fighting to the uttermost, it was because Fairfax placed the political issue in the foreground, and after the capitulation the prince rode to Oxford with his enemies, frankly discussing the prospect of peace. Already he had deliberately advised Charles to make peace, and had come to be suspected, in consequence, by Charles's optimistic adviser Digby. But to Charles himself the news of the fall of Bristol was a thunderbolt. "It is the greatest trial to my constancy that has yet befallen me," he wrote to the prince, "that one that is so near to me in blood and friendship submits himself to so mean an action." Rupert was deeply wounded by the implied stain on his honour; he forced his way to the king and demanded a court-martial. The verdict of this court smoothed over matters for a time, but Rupert was now too far estranged from the prevailing party at court to be of any assistance, and after further misfortunes and quarrels they separated, Charles to take refuge in the camp of the Scots, Rupert to stay, as a spectator without command, with the Oxford garrison. He received at the capitulation a pass from the parliament to leave England, as did also his faithful comrade Maurice.

For some time after this Rupert commanded the troops

formed of English exiles in the French army, and received a wound at the siege of La Bassée in 1647. Charles in misfortune had understood something of his nephew's devotion, and wrote to him in the friendliest terms, and though the prince had by no means forgiven Digby, Colepeper and others of the council, he obtained command of a Royalist fleet. The king's enemies were now no longer the Presbyterians and the majority of the English people but the stern Independent community, with whose aims and aspirations he could not have any sympathy whatever. A long and unprofitable naval campaign followed, which extended from Kinsale to Lisbon and from Toulon to Cape Verde. But the prince again quarrelled with the council, and spent six years (1654-60) in Germany, during which period nothing is known of him, except that he vainly attempted (as also before and afterwards) to obtain the apanage to which as a younger son he was entitled from his brother the elector palatine. At the Restoration he settled in England again, receiving from Charles II. an annuity and becoming a member of the privy council. He never again fought on land; but, turning admiral like Blake and Monk, he bore a brilliant part in the Dutch Wars. He died at his house in Spring Gardens, Westminster, on the 20th of November 1682.

Apart from his military renown, Prince Rupert is a distinguished figure in the history of art as one of the earliest mezzotinters. It has often been said that he was the inventor of mezzotint engraving, but this is erroneous, as he obtained the secret from a German officer, Ludwig von Siegen. One of the most beautiful and valuable of early mezzotints is his "Head of St John the Baptist." He was also interested in science, experimented with the manufacture of gunpowder, the boring of guns and the casting of shot, and invented a modified brass called "prince's metal."

Prince Rupert was duke of Cumberland and earl of Holderness in the English peerage. He was unmarried, but left two natural children: one a daughter who married General Emmanuel Scrope Howe and died in 1740, and the other a son, whose mother (who claimed that she was married to the prince) was Frances, daughter of Sir Henry Bard, Viscount Bellamont. The son was killed in 1686 at the siege of Buda.

See E. Warburton's *Life of Pr. Rupert* (London, 1849) and additional authorities quoted in the memoir by C. H. Firth in the *Dict. Nat. Biog.*

RUPERT (1352-1410), German king, and, as Rupert III., elector palatine of the Rhine, was a son of the elector Rupert II. and Beatrice, daughter of Peter II., king of Sicily. He was born at Amberg on the 5th of May 1352, and from his early years took part in the government of the Palatinate to which he succeeded on his father's death in 1398. He was one of the four electors who met at Oberlahnstein in August 1400 and declared King Wenceslaus deposed. This was followed by the election of Rupert as German king at Rense on the 21st of that month, and by his coronation at Cologne on the 6th of the following January. Winning some recognition in S. Germany, he made an expedition to Italy, where he hoped to receive the imperial crown, and to crush Gian Galeazzo Visconti, duke of Milan. In the autumn of 1401 he crossed the Alps, but his troops, checked before Brescia, melted away, and in 1402 Rupert, too poor to continue the campaign, returned to Germany. The news of this failure increased the disorder in Germany, but the king met with some success in his efforts to restore peace, and in October 1403 he was recognized by Pope Boniface IX. It was only the indolence of Wenceslaus that prevented his overthrow, and in 1406 he was compelled to make certain concessions. The quarrel was complicated by the papal schism, but the king was just beginning to make some headway when he died at his castle of Landskron near Oppenheim on the 18th of May 1410 and was buried at Heidelberg. He married Elizabeth, daughter of Frederick IV. of Hohenzollern, burgrave of Nuremberg, and left three sons and four daughters. Rupert, who earned the surname of *clemens*, was brave and generous, but his resources were totally inadequate to bear the strain of the German kingship.

BIBLIOGRAPHY.—J. Chmel, *Regesta chronologico-diplomatica Ruperti regis Romanorum* (Frankfurt, 1834); C. Höfler, *Ruprecht von der Pfalz genannt Clem römischer König* (Freiburg, 1861); L. Häusser, *Geschichte der Rheinischen Pfalz* (Heidelberg, 1845); Th. Lindner, *Geschichte des Deutschen Reiches vom Ende des 14 Jahrhunderts bis zur Reformation* (Brunswick, 1875-80), part i.; A. Winkelmann, *Der König Ruprecht von der Pfalz* (Innsbruck, 1892); and J. Weizsäcker, *Die Urkunden der Approbation König Ruprechts* (Berlin, 1899).

RUPERT'S LAND, a former district of Canada. The general charter of Charles II. given in 1670 to the Hudson's Bay Company gave rights of possession, trade and administration of justice "of all those seas, streights and bays, rivers, lakes, creeks and sounds, in whatsoever latitude they shall be, that lie within the entrance of the streights commonly called Hudson's streights, together with all the lands, countries and territories upon the coasts and confines of the seas, streights, bays, lakes, rivers, creeks and sounds aforesaid, which are not now actually possessed by any of our subjects, or by the subjects of any other Christian prince or state."

The general interpretation given to this was that it included all the country drained into Hudson Bay. As Prince Rupert was first governor of the Hudson's Bay Company his name was given to the concession under the name "Rupert's Land." It will be observed that Athabasca, New Caledonia and British Columbia were not included in this grant. They were held under the title Indian Territories by the Hudson's Bay Company by licence terminable every twenty-one years, the last term closing with 1850. Rupert's Land was transferred to Canada by the imperial government in 1870, and ceased to exist as a political name. It is still used as the title of the episcopal diocese, which is in the main coincident with the province of Manitoba.

RUPILIUS, PUBLIUS, Roman statesman, consul in 132 B.C. During the inquiry that followed the death of Tiberius Gracchus, conducted by himself and his colleague Popilius Laenas, he proceeded with the utmost severity against the supporters of Gracchus. In the same year he was despatched to Sicily, where he suppressed the revolt of the slaves under Eunus. During 131 he remained as proconsul of the island, and, with the assistance of ten commissioners appointed by the senate, drew up regulations for the organization of Sicily as a province. These regulations were known by the title of *leges Rupiliæ*, though they were not laws in the strict sense. Rupilius was subsequently brought to trial (123 B.C.) and condemned for his treatment of the friends of Gracchus. The disgrace of his condemnation, added to disappointment at the failure of his brother to obtain the consulship in spite of the efforts of Scipio, caused his death shortly afterwards.

See Cicero, *De Am.* 19, *Tusc. disp.* iv. 17, in *Verr.* ii. 13, 15; *Diod. Sic.* xxxiv. 1, 20; *Vel. Pat.* ii. 7.

RUPPIN, or Neuruppin, a town of Germany, in the Prussian province of Brandenburg, lies on the W. bank of a small lake, the Ruppiner See, 37 m. N.W. of Berlin by rail. Pop. (1905) 18,555. The town, which was rebuilt in fine, regular fashion after a destructive fire in 1787, contains three Protestant churches, a Roman Catholic church and various educational and benevolent institutions. Its inhabitants are employed in the manufacture of cloth, starch and machinery, in iron-founding and lithography. Important cattle and horse fairs are held here. Ruppiner received municipal rights in 1256.

The small town of Altruppin, lying at the north end of the lake, has a 13th-century church and some small manufactures. Pop. (1905) 1813.

See Heydemann, *Neuere Geschichte der Stadt Neuruppin* (Neuruppin, 1863); and G. Bittkau, *Ältere Geschichte der Stadt Neuruppin* (Neuruppin, 1887).

RUSELLAE, an ancient town of Etruria, Italy, about 10 m. S.E. of Vetulonia and 5 m. N.E. of Grosseto, situated on a hill with two summits, the higher 636 ft. above sea-level. It was one of the twelve cities of the Etruscan confederation, and was taken in 204 B.C. by the Romans. In 205 B.C. it contributed grain and timber for the needs of Scipio's fleet. A colony was founded here either by the Triumviri or by Augustus. The place was deserted in 1138, and the episcopal see was transferred

to Grosseto. The ruins are now thickly overgrown with brushwood; but the walls, nearly 2 m. in circumference, are in places well preserved. They consist of large unworked blocks of a travertine which naturally splits into roughly rectangular blocks; these are quite irregular, and often as much as 9 ft. long by 4 ft. wide: in the interstices smaller pieces are inserted. The walls are embanking walls, with a low breastwork in places. Within the circuit which they enclose, now under cultivation, are two summits, one occupied by a Roman amphitheatre [the other by a tower (?) of uncertain date]: a Roman cistern also is visible. Some 2 m. S.S.W. are modern baths, fed by hot springs, which were in use in Roman times also, as the discovery of remains of Roman buildings shows.

See G. Dennis, *Cities and Cemeteries of Etruria* (London, 1883), ii. 222. (T. As.)

RUSH, BENJAMIN (1745-1813), American physician, was born in Byberry township, near Philadelphia, on a homestead founded by his grandfather, a Quaker gunsmith, who had followed Penn from England in 1683. In 1760 he graduated at Princeton. After serving an apprenticeship of six years with a doctor in Philadelphia, he went for two years to Edinburgh, where he attached himself chiefly to William Cullen. He took his M.D. degree there in 1768, spent a year more in the hospitals of London and Paris, and began practice in Philadelphia at the age of twenty-four, undertaking at the same time the chemistry class at the Philadelphia medical college. He was a friend of Franklin, a member of Congress for the state of Pennsylvania in 1776, and one of those who signed the Declaration of Independence the same year. He had already written on the Test Laws, "Sermons to the Rich," and on negro slavery; and in 1774 he started along with James Pemberton the first anti-slavery society in America, and was its secretary for many years. In 1787 he was a member of the Pennsylvania convention which adopted the Federal constitution, and thereafter he retired from public life, and gave himself up wholly to medical practice. In 1780 he exchanged his chemistry lectureship for that of the theory and practice of physic; and when the medical college, which he had helped to found, was absorbed by the university of Pennsylvania in 1791 he became professor of the institutes of medicine and of clinical practice, succeeding in 1796 to the chair of the theory and practice of medicine. He gained great credit when the yellow fever devastated Philadelphia, in 1793, by his assiduity in visiting the sick, and by his bold and apparently successful treatment of the disease by bloodletting. He died in Philadelphia on the 19th of April 1813, after a five days' illness from typhus fever. His son Richard is separately noticed. Another son, James (1786-1860), was a physician, and author of various books, such as *Philosophy of the Human Voice* (1827) and *Analysis of the Human Intellect* (1865).

Benjamin Rush's writings covered an immense range of subjects, including language, the study of Latin and Greek, the moral faculty, capital punishment, medicine among the American Indians, maple sugar, the blackness of the negro, the cause of animal life, tobacco smoking, spirit drinking, as well as many more strictly professional topics. His last work was an elaborate treatise on the *Diseases of the Mind* (1812). He is best known by the five volumes of *Medical Inquiries and Observations*, which he brought out at intervals from 1789 to 1798 (two later editions revised by the author).

See eulogy by his friend Dr David Hosack (*Essays*, i., New York, 1824), with biographical details taken from a letter of Rush to President John Adams; also references in the works of Thacker, Gross and Bowditch on the history of medicine in America. His part in the yellow fever controversies is indicated by La Roche (*Yellow Fever in Philadelphia from 1669 to 1854*, 2 vols., Philadelphia, 1885) and by Bancroft (*Essay on the Yellow Fever*, London, 1811). His services as an abolitionist pioneer are recorded in Clarkson's *History of the Abolition of the African Slave Trade*.

RUSH, RICHARD (1780-1850), American statesman and diplomatist, son of Dr Benjamin Rush, was born in Philadelphia, Pennsylvania, on the 20th of August 1780. He graduated at Princeton in 1797, and was admitted to the bar in 1800. He was attorney-general of Pennsylvania in 1811, comptroller of the treasury of the United States in 1811-14, attorney-general in the cabinet of President James Madison in 1814-17,

acting secretary of state from March to September 1817, minister to Great Britain in 1817-25, secretary of the treasury in the cabinet of President J. Q. Adams in 1825-29, and candidate for vice-president on the Adams ticket in 1828. In 1818, while minister to Great Britain, he, in association with Albert Gallatin, concluded with British plenipotentiaries the important treaty which determined the boundary line between the United States and Canada from the Lake of the Woods to the Rocky Mountains and provided for the joint occupation of Oregon for ten years. He also conducted the negotiations with Canning in 1823 relating to the S. American policy of the Holy Alliance. He followed the Adams-Clay faction of the Democratic-Republican party in the split of 1825-28, but returned to the Democratic party about 1834 on the bank issue. In 1835 he and Benjamin C. Howard, of Baltimore, Maryland, were sent by President Jackson to prevent an outbreak of hostilities in the Ohio-Michigan boundary dispute. In 1836-38 Rush was commissioner to receive the Smithsonian legacy (see SMITHSONIAN INSTITUTION), and in 1847-49 he was minister to France. He died at Philadelphia on the 30th of July 1850.

He published *A Narrative of a Residence at the Court of London from 1817 to 1825* (2 vols., 1833-45; all editions after the first edition of the 1st volume are entitled *Memoiranda of a Residence, &c.*); *Washington in Domestic Life* (1857), compiled from letters written by Washington to his private secretary in 1790-98; and *Occasional Productions, Political, Diplomatic and Miscellaneous* (1860); and while attorney-general he suggested the plan for the compilation, *Laws of the Nation* (5 vols., 1815), edited by John B. Colvin.

RUSH. Under the name of rush or rushes, the stalks or hollow stem-like leaves of several plants have minor industrial applications. The common rushes (species of *Juncus*; see JUNCACEAE) are used in many parts of the world for chair-bottoms, mats and basket-work, and the pith serves as wicks in open oil-lamps and for tallow candles—whence rushlight. The fibrous stems and leaves of the bulrush or reed-mat, *Typha angustifolia*, are used in N. India for ropes, mats and baskets. *Scirpus* and other Cyperaceae are used for chair-bottoms, mats and thatch; the rush mats of Madras are made from a species of *Cyperus*. The sweet-rush, yielding essential oil, is a grass, *Andropogon Schoenanthus*, known also as lemon grass. Large quantities of the "horse-tail," *Equisetum hiemale*, are used under the name of Dutch or scouring rush for scouring metal and other hard surfaces on account of the large proportion of silica the plant contains. Flowering rush is *Butomus umbellatus* (see ALISMACEAE); wood-rush is the common name for *Luaua* (see JUNCACEAE). *Acorus Calamus*, sweet-flag, is also known as sweet-rush.

RUSHDEN, an urban district in the E. parliamentary division of Northamptonshire, England, 66 m. N.N.W. from London by the Midland railway. Pop. (1901) 12,453. The church of St Mary is a fine cruciform building with western tower and spire. It is mainly decorated, with perpendicular additions, but retains some Early English details. The growth of Rushden as a town is modern. The industrial population is employed in boot and shoe making, the local staple.

RUSHWORTH, JOHN (c. 1612-1690), the compiler of the *Historical Collections* commonly described by his name, was the son of Lawrence Rushworth of Acklington Park, Warkworth, Northumberland. When he was given the degree of M.A. at Oxford in 1649, he was said to belong to Queen's College, but there are no traces of his presence at the university. He was bred to the law, and in 1638 was appointed solicitor to the town of Berwick. He was enrolled in Lincoln's Inn in 1641, and was called to the bar in 1647. He made a point of attending on all public occasions of a political and judicial character, such as proceedings before the Star Chamber or the Council, and of making shorthand notes of them. On the 25th of April 1640 he was appointed an assistant clerk to the House of Commons. He was on duty when King Charles I. came down to arrest the five members on the 4th of January 1642, and made notes of his speech. The king insisted on taking the notes, and ordered them to be published. Rushworth

attended the trial of the earl of Strafford, and took shorthand notes of the proceedings. He was much employed as a messenger between the king and the parliament, and from the 11th of April 1644 till the 9th of March 1647 was licenser of pamphlets. When the new model army was formed he was appointed secretary to the parliamentary general, Sir Thomas Fairfax. He was present at the battle of Naseby, of which he wrote an account. When Fairfax, who was offended by the execution of the king, resigned his command, Rushworth was for a short time secretary to Cromwell. He was afterwards employed by the council of state and during the protectorate, and sat in Cromwell's parliament for Berwick. When Richard Cromwell resigned the protectorate, Rushworth was employed by the Rump after it had been re-established by Monk. He made his peace with the government of Charles II., and though he was threatened with trial as a regicide he was not seriously molested. During the reign of Charles II. he continued to act as agent for the town of Berwick, and he sat for it in parliament. He was also for a time agent for Massachusetts, but the colony complained that it received no advantage from his services. During the last years of his life he fell into poverty, and from 1684 till his death on the 12th of May 1690 he was a resident in the King's Bench prison. At this time he had destroyed his memory by over-indulgence in drink. The collection of papers which he made was published in eight volumes folio between 1659 and 1701. The volumes from the fourth onwards appeared after his death. The first, which appeared with a dedication to Richard Cromwell, was recalled and the dedication was suppressed.

RUSKIN, JOHN (1819-1900), English writer and critic, was born in London, at Hunter Street, Brunswick Square, on the 8th of February 1819, being the only child of John James Ruskin and Margaret Cox. They were Scots, first cousins, the grandchildren of a certain John Ruskin of Edinburgh (1732-1780). In *Præterita* the author professes small knowledge of his ancestry. But the memoirs published on the authority of the family trace their descent to the Adairs and Agnews of Galloway. In this family tree are men famous in arms and in the public service: Sir Andrew Agnew of Lochnaw, Admiral Sir John Ross, Field-Marshal Sir Hew Dalrymple Ross, Dr John Adair, in whose arms Wolfe died at Quebec, and the Rev. W. Tweeddale of Glenclue, to whom the original Covenant, now in the Glasgow Museum, had been confided. The name Ruskin is said to be a variant of Erskine, or Roskeen, or Rogerkin, and even Roughskin. It is more probably Rusking, an Anglian family, which passed northwards and became Ruskin, Rusken and Ruskin.

John Ruskin, the author's grandfather, a handsome lad of twenty, ran away with Catherine Tweeddale, daughter of the Covenanter minister and of Catherine Adair, then a beautiful girl of sixteen. He settled in Edinburgh and engaged in the wine trade, lived liberally in the cultivated society of the city, lost his health and his fortune, and ended his days in debt. His son, John James Ruskin (1785-1864), father of the author, was sent to the High School at Edinburgh under Dr A. Adam, received a sound classical education, and was well advised by his friend Dr Thomas Brown, the eminent metaphysician. When of age, John James was sent to London to enter the wine trade. There, in 1809, he founded the sherry business of Ruskin, Telford & Domecq; Domecq being proprietor of a famous vineyard in Spain, Telford contributing the capital of the firm, and Ruskin having sole control of the business. John James Ruskin, a typical Scot, of remarkable energy, probity and foresight, built up a great business, paid off his father's debts, formed near London a most hospitable and cultured home, where he maintained his taste for literature and art, and lived and died, as his son proudly wrote upon his tomb, "an entirely honest merchant." He was also a man of strong brain, generous nature and fine taste. After a delay of nine years, having at last obtained an adequate income, he married his cousin, Margaret Cox, who had already lived for eighteen years with his mother, the widow of John

Ruskin of Edinburgh. When this marriage of the two cousins, who had known each other all their lives, took place in 1818, neither of them was young. John James was thirty-three and Margaret was thirty-seven. In the following year (8th February 1819) their only child, John, was born in Hunter Street, London.

Margaret Ruskin, the author's mother, was a handsome, strong, stern, able, devoted woman of the old Puritan school, Calvinist in religion, unsparing of herself and others, rigid in her ideas of duty, proud, reserved and ungracious. She was the daughter of Captain Cox, of Yarmouth, master mariner in the herring fishery, who died young; whereupon his widow maintained herself as landlady of the King's Head Inn at Croydon. Her younger daughter married Mr Richardson, a baker, of Croydon; the elder, Margaret, married John James Ruskin, Jessie, a sister of John James, married Peter Richardson, a tanner, of Perth, so that the author had cousins of two Richardson families, unconnected with each other. In his own memoirs he speaks much more of these than of any Ruskins, Tweeddales, Adairs or Agnews. The child was brought up under a rigid system of nursing, physical, moral and intellectual; kept without toys, not seldom whipped, watched day and night, but trained from infancy in music, drawing, reading aloud and observation of natural objects. When he was four the family removed to a house on Herne Hill, then a country village, with a garden and rural surroundings. The father, who made long tours on business, took his wife, child and nurse year after year across England as far as Cumberland and Scotland, visiting towns, cathedrals, castles, colleges, parks, mountains and lakes. At five the child was taken to Keswick; at six to Paris, Brussels and Waterloo; at seven to Perthshire. At fourteen he was taken through Flanders, along the Rhine, and through the Black Forest to Switzerland, where he first imbibed his dominant passion for the Alps. His youth was largely passed in systematic travelling in search of everything beautiful in nature or in art. And to one so precocious, stimulated by a parent of much culture, ample means and great ambition, this resulted in an almost unexampled aesthetic education. In childhood also he began a systematic practice of composition, both in prose and verse. His mother trained him in reading the Bible, of which he read through every chapter of every book year by year; and to this study he justly attributes his early command of language and his pure sense of style. His father read to him Shakespeare, Scott, Don Quixote, Pope and Byron, and most of the great English classics; and his attention was especially turned to the formation of sentences and to the rhythm of prose. He began to compose both in prose and verse as soon as he had learned to read and write, both of which arts he taught himself by the eye.

His first letter is dated 1823, when he was only four. In it he corrects his aunt, who had put up the wooden pillars of his Waterloo bridge "upside down." At five he was a book-worm. At seven he began a work in four volumes, with "copper-plates printed and composed by a little boy, and also drawn." His first poem, correct in rhyme and form, was written before he was seven. At nine he began "Eudokia, a poem of the Universe." From that year until his Newdigate Prize, at the age of twenty, he wrote enormous quantities of verse, and began dramas, romances and imitations of Byron, Pope, Scott and Shelley. What remain of these effusions have no special quality except good sense, refined feeling, accuracy of phrase, and a curious correctness of accent and rhythm. Of true poetry in the higher sense there is hardly a single line.

His schooling was irregular and not successful. At the age of eleven he was taught Latin and Greek by Dr Andrews, a scholar of Glasgow University. About the same time he had lessons in drawing and in oil painting from Runciman. French and Euclid were taught by Rowbotham. At fifteen he was sent for two years to the day-school of the Rev. T. Dale of Peckham, and at seventeen he attended some courses in

literature at King's College, London. In painting he had lessons from Copley Fielding and afterwards from J. D. Harding. But in the incessant travelling, drawing, collecting specimens and composition in prose and verse he had gained but a very moderate classical and mathematical knowledge when he matriculated at Oxford; nor could he ever learn to write tolerable Latin. As a boy he was active, lively and docile; a good walker, but ignorant of all boyish games, as naif and as innocent as a child; and he never could learn to dance or to ride. He was only saved by his intellect and his fine nature from turning out an arrant prig. He was regarded by his parents, and seems to have regarded himself, as a genius. As a child he had been "a savant in petticoats"; as a boy he was a poet in breeches. At the age of seventeen he saw Adèle, the French daughter of Monsieur Domecq, Mr Ruskin's partner, a lovely girl of fifteen. John fell rapturously in love with her; and, it seems, the two fathers seriously contemplated their marriage. The young poet wooed the girl with poems, romances, dramas and mute worship, but received nothing except chilling indifference and lively ridicule. To the gay young beauty, familiar with Parisian society, the raw and serious youth was not a possible *parti*. She was sent to an English school, and he occasionally saw her. His unspoken passion lasted about three years, when she married the Baron Duquesne. Writing as an old man, long after her death, Ruskin speaks of his early love without any sort of rapture. But it is clear that it deeply coloured his life, and led to the dangerous illness which for some two years interrupted his studies and made him a wanderer over Europe.

As the father was resolved that John should have everything that money and pains could give, and was one day to be a bishop at least, he entered him at Christ Church, Oxford, as a gentleman-commoner—then an order reserved for men of wealth and rank. Ruskin's Oxford career, broken by the two years passed abroad, was not very full of incident or of usefulness. Though he never became either a scholar or a mathematician, he did enough accurate work to be placed in the honorary fourth class both in classics and in mathematics. By the young bloods of the "House" he was treated pleasantly as a raw outsider of genius. By some of the students and tutors, by Liddell, Newton, Acland and others, he was regarded as a youth of rare promise, and he made some lifelong friendships with men of mark and of power. Both he and his college took kindly the amazing proceeding of his mother, who left her husband and her home to reside in Oxford, that she might watch over her son's health. The one success of his Oxford career was the winning the Newdigate Prize by his poem "Salsete and Elephanta," which he recited in the Sheldonian Theatre (June 1830). Two years of ill-health and absence from home ensued. And he did not become "a Graduate of Oxford" until 1842, in his twenty-fourth year, five years after his first entrance at the university. In fact, his desultory school and college life had been little more than an interruption and hindrance to his real education—the study of nature, of art and of literature. Long before Ruskin published books he had appeared in print. In March 1834, when he was but fifteen, Loudon's *Magazine of Natural History* published an essay of his on the strata of mountains and an inquiry as to the colour of the Rhine. He then wrote for Loudon's *Magazine of Architecture*, and verses of his were inserted in Messrs Smith & Elder's *Friendship's Offering*, by the editor, T. Pringle, who took the lad to see the poet Rogers. At seventeen he wrote for *Blackwood* a defence of Turner, which the painter, to whom it was first submitted, did not take the trouble to forward to the magazine. At eighteen he wrote a series of papers, signed Kata Phusin, i.e. "after Nature," for Loudon's *Magazine*, on "The Poetry of Architecture." In 1838 (he was then nineteen) Mr Loudon wrote to the father: "Your son is the greatest natural genius that ever it has been my fortune to become acquainted with."

Having recovered his health and spirits by care and foreign travel, and having taken his degree and left Oxford, Ruskin set to work steadily at Herne Hill on the more elaborate defence of

Turner, which was to become his first work. *Modern Painters*, vol. i., by "a Graduate of Oxford," was published May 1843, when the author was little more than twenty-four. It produced a great and immediate sensation. It was vehemently attacked by the critics, and coolly received by the painters. Even Turner was somewhat disconcerted; but the painter was now known to both Ruskins, and they freely bought his pictures. The family then went again to the Alps, that John might study mountain formation and "Truth" in landscape. In 1845 he was again abroad in Italy, working on his *Modern Painters*, the second volume of which appeared in 1846. He had now plunged into the study of Bellini and the Venetian school, Fra Angelico and the early Tuscans, and he visited Lucca, Pisa, Florence, Padua, Verona and Venice, passionately devoting himself to architecture, sculpture and painting in each city of north Italy. He wrote a few essays for the *Quarterly Review* and other periodicals, and in 1840 (*æet.* 30) he published *The Seven Lamps of Architecture*, with his own etchings, which greatly increased the reputation acquired by his *Modern Painters*.

On the 10th of April 1848, a day famous in the history of Chartism, Ruskin was married at Perth to Euphemia Chalmers Gray, a lady of great beauty, of a family long intimate with the Ruskins. The marriage, we are told, was arranged by the parents of the pair, and was a somewhat hurried act. It was evidently ill-assorted, and brought no happiness to either. They travelled, lived in London, saw society, and attended a "Drawing-room" at Buckingham Palace. But Ruskin, immersed in various studies and projects, was no husband for a brilliant woman devoted to society. No particulars of their life have been made public. In 1854 his wife left him, obtained a nullification of the marriage under Scots law, and ultimately became the wife of John Everett Millais. John Ruskin returned to his parents, with whom he resided till their death; and neither his marriage nor the annulling of it seems to have affected seriously his literary career.

Ruskin's architectural studies, of which *The Seven Lamps* was the first fruit, turned him from Turner and *Modern Painters*. He planned a book about Venice in 1845, and *The Stones of Venice* was announced in 1849 as in preparation. After intense study in Italy and at home, early in 1851 (the year of the Great Exhibition in London) the first volume of *The Stones of Venice* appeared (*æet.* 32). It was by no means a mere antiquarian and artistic study. It was a concrete expansion of the ideas of *The Seven Lamps*—that the buildings and art of a people are the expression of their religion, their morality, their national aspirations and social habits. It was, as Carlyle wrote to the author, "a sermon in stones," "a singular sign of the times," "a new Renaissance." It appeared in the same year with the *Construction of Sheepfolds*—a plea for the reunion of Christian churches—in the same year with the essay on *Pre-Raphaelitism*, the year of Turner's death (10th December). *The Stones of Venice* was illustrated with engravings by some of the most refined artists of his time. The author spent a world of pains in having these brought up to the highest perfection of the reproductive art, and began the system of exquisite illustration, and those facsimiles of his own and other sketches, which make his works rank so high in the catalogues and price-lists of collectors. This delicate art was carried even farther in the later volumes of *Modern Painters* by the school of engravers whom Ruskin inspired and gathered round him. And these now rare and coveted pieces remain to rebuke us for our modern preference for the mechanical and unnatural *chiaroscuro* of photogravure—the successor and destroyer of the graver's art. Although Ruskin was practised in drawing from the time that he could hold a pencil, and had lessons in painting from some eminent artists, he at no time attempted to paint pictures. He said himself that he was unable to compose a picture, and he never sought to produce anything that he would call a work of original art. His drawings, of which he produced an enormous quantity, were always intended by himself to be studies or memoranda of buildings or natural objects precisely as they appeared to his eye. Clouds, mountains, landscapes, towers,

churches, trees, flowers and herbs were drawn with wonderful precision, minuteness of detail and delicacy of hand, solely to recall some specific aspect of nature or art, of which he wished to retain a record. In his gift for recording the most subtle characters of architectural carvings and details, Ruskin has hardly been surpassed by the most distinguished painters.

In 1853 *The Stones of Venice* was completed at Herne Hill, and he began a series of *Letters and Notes* on pictures and architecture. In this year (æet. 34) he opened the long series of public lectures wherein he came forward as an oral teacher and preacher, not a little to the alarm of his parents and amidst a storm of controversy. The Edinburgh Lectures (November 1853) treated Architecture, Turner, and Pre-Raphaelitism. The Manchester Lectures (July 1857) treated the moral and social uses of art, now embodied in *A Joy for Ever*. Some other lectures are reprinted in *On the Old Road* and *The Two Paths* (1859). These lectures did not prevent the issue of various *Notes* on the Royal Academy pictures and the Turner collections; works on the *Harbours of England* (1856); on the *Elements of Drawing* (1857); the *Elements of Perspective* (1859); and at last, after prolonged labour, the fifth and final volume of *Modern Painters* was published in 1860 (æet. 41). This marks an epoch in the career of John Ruskin; and the year 1860 closed the series of his works on art strictly so called; indeed, this was the last of his regular works in substantial form. The last forty years of his life were devoted to expounding his views, or rather his doctrines, on social and industrial problems, on education, morals and religion, wherein art becomes an incidental and instrumental means to a higher and more spiritual life. And his teaching was embodied in an enormous series of *Lectures, Letters, Articles, Selections* and serial pamphlets. These are now collected in upwards of thirty volumes in the final edition. The entire set of Ruskin's publications amounts to more than fifty works having distinctive titles. For some years before 1860 Ruskin had been deeply stirred by reflecting on the condition of all industrial work and the evils of modern society. His lectures on art had dealt bitterly with the mode in which buildings and other works were produced. In 1854 he joined Mr F. D. Maurice, Mr T. Hughes, and several of the new school of painters, in teaching classes at the Working Men's College. But it was not until 1860 that he definitely began to propound a new social scheme, denouncing the dogmas of political economy. Four lectures on this topic appeared in the *Cornhill Magazine* until the public disapproval led the editor, then W. M. Thackeray, to close the series. They were published in 1862 as *Unto this Last*. In the same year he wrote four papers in the same sense in *Fraser's Magazine*, then edited by J. A. Froude; but he in turn was compelled to suspend the issue. They were completed and ultimately issued under the title *Munera Pulveris*. These two small books contain the earliest and most systematic of all Ruskin's efforts to depict a new social Utopia: they contain a vehement repudiation of the orthodox formulas of the economists; and they are for the most part written in a trenchant but simple style, in striking contrast to the florid and discursive form of his works on art.

In 1864 Ruskin's father died, at the age of 70, leaving his son a large fortune and a fine property at Denmark Hill. John still lived there with his mother, aged 83, infirm, and failing in sight, to whom came as a companion their cousin, Joanna Ruskin Agnew, afterwards Mrs Arthur Severn. At the end of the year 1864 Ruskin delivered at Manchester a new series of lectures—not on art, but on reading, education, woman's work and social morals—the expansion of his earlier treatises on economic sophisms. This afterwards was included with a Dublin lecture of 1868 under the fantastic title of *Sesame and Lilies* (perhaps the most popular of his social essays), of which 44,000 copies were issued down to 1900. He made this, in 1871, the first volume of his collected lectures and essays, the more popular and didactic form of his new Utopia of human life. It contains, with *Fors*, the most complete sketch of his conception of the place of woman in modern society. In the very characteristic preface to the new edition of 1871 he

proposes never to reprint his earlier works on art; disclaims many of the views they contained, and much in their literary form; and specially regrets the narrow Protestantism by which they were pervaded. In the year 1866 he published a little book about girls, and written for girls, a mixture of morals, theology, economics and geology, under the title of *Ethics of the Dust*; and this was followed by a more important and popular work, *The Crown of Wild Olive*. This in its ultimate form contained lectures on "Work," "Traffic," "War," and the "Future of England." It was one of his most trenchant utterances, full of fancy, wit, eloquence and elevated thought. But a more serious volume was *Time and Tide* (1867), a series of twenty-five letters to a workman of Sunderland, upon various points in the Ruskinian Utopia. This little collection of "Thoughts," written with wonderful vivacity, ingenuity and fervour, is the best summary of the author's social and economic programme, and contains some of his wisest and finest thoughts in the purest and most masculine English that he had at his command. In 1869 he issued the *Queen of the Air*, lectures on Greek myths, a subject he now took up, with some aid from the late Sir C. Newton. It was followed by some other occasional pieces; and in the same year he was elected Slade professor of art in the university of Oxford. He now entered on his professorial career, which continued with some intervals down to 1884, and occupied a large part of his energies. His lectures began in February 1870, and were so crowded that they had to be given in the Sheldonian Theatre, and frequently were repeated to a second audience. He was made honorary fellow of Corpus Christi, and occupied rooms in the college. In 1871 his mother died, at the age of 90, and his cousin, Miss Agnew, married Mr Arthur Severn. In that year he bought from Mr Linton, Brantwood, an old cottage and property on Coniston Lake, a lovely spot facing the mountain named the Old Man. He added greatly to the house and property, and lived in it continuously until his death in 1900. In 1871, one of the most eventful years of his life, he began *Fors Clavigera*, a small serial addressed to the working men of England, and published only by Mr George Allen, engraver, at Keston, in Kent, at 7d., and afterwards at 10d., but without discount, and not through the trade. This was a medley of social, moral and religious reflections interspersed with casual thoughts about persons, events and art. *Fors* means alternatively Fate, Force or Chance, bearing the *Clavis*, Club, Key or Nail, i.e. power, patience and law. It was a desultory exposition of the Ruskinian ideal of life, manners and society, full of wit, play, invective and sermons on things in general. It was continued with intervals down to 1884, and contained ninety-six letters or pamphlets, partly illustrated, which originally filled eight volumes and are now reduced to four.

The early years of his Oxford professorship were occupied by severe labour, sundry travels, attacks of illness and another cruel disappointment in love. In spite of this, he lectured, founded a museum of art, to which he gave pictures and drawings and £5000; he sought to form at Oxford a school of drawing; he started a model shop for the sale of tea, and model lodgings in Marylebone for poor tenants. At Oxford he set his pupils to work on making roads to improve the country. He now founded "St George's Guild," himself contributing £7000, the object of which was to form a model industrial and social movement, to buy lands, mills and factories, and to start a model industry on co-operative or Socialist lines. In connexion with this was a museum for the study of art and science at Sheffield. Ruskin himself endowed the museum with works of art and money; a full account of it has been given in Mr E. T. Cook's *Studies in Ruskin* (1890), which contains the particulars of his university lectures and of his economic and social experiments. It is unnecessary to follow out the history of these somewhat unpromising attempts. None of them came to much good, except the Sheffield museum, which is an established success, and is now transferred to the town. In *Fors*, which was continued month by month for seven years, Ruskin poured out his thoughts, proposals and rebukes on

society and persons with inexhaustible fancy, wit, eloquence and freedom, until he was attacked with a violent brain malady in the spring of 1878 (*æet.* 59); and, although he recovered in a few months sufficiently to do some occasional work, he resigned his professorship early in 1879. The next three years he spent at Brantwood, mainly in retirement, and unhappy in finding nearly all his labours interrupted by his broken health. In 1880 he was able to travel in northern France, and began the *Bible of Amiens*, finished in 1885; and he issued occasional numbers of *Fors*, the last of which appeared at Christmas 1884. In 1882 he had another serious illness, with inflammation of the brain; but he recovered sufficiently to travel to his old haunts in France and Italy—his last visit. And in the following year he was re-elected professor at Oxford and resumed his lectures; but increasing brain excitement, and indignation at the establishment of a laboratory to which vivisection was admitted, led him to resign his Oxford career, and he retired in 1884 to Brantwood, which he never left. He now suffered from frequent attacks of brain irritation and exhaustion, and had many causes of sorrow and disappointment. His lectures were published at intervals from 1870 to 1885 in *Atrata Pentecici*, *The Eagle's Nest*, *Love's Meinie*, *Ariadne Florentina*, *Val d'Arno*, *Proserpina*, *Deucalion*, *The Laws of Fesolè*, *The Bible of Amiens*, *The Art of England* and *The Pleasures of England*, together with a series of pamphlets, letters, articles, notes, catalogues and circulars.

In the retirement of Brantwood he began his last work, *Præterita*, a desultory autobiography with personal anecdotes and reminiscences. He was again attacked with the same mental malady in 1885, which henceforth left him fit only for occasional letters and notes. In 1887 it was found that he had exhausted (spent, and given away) the whole of the fortune he had received from his father, amounting, it is said, to something like £200,000; and he was dependent on the vast and increasing sale of his works, which produced an average income of £4000 a year, and at times on the sale of his pictures and realizable property. In 1872 a correspondent had remonstrated with him in vain as to taking "usury," i.e. interest on capital lent to others for use. In 1874 Ruskin himself had begun to doubt its lawfulness. In 1876 he fiercely assailed the practice of receiving interest or rent, and he henceforth lived on his capital, which he gave freely to friends, dependants, public societies, charitable and social objects. The course of his opinions and his practice is fully explained in successive letters in *Fors*. Until 1880 he continued to write chapters of *Præterita*, which was designed to record memories of his life down to the year 1875 (*æet.* 56). It was, in fact, only completed in regular series down to 1858 (*æet.* 39), with a separate chapter as to Mrs Arthur Severn, and a fragment called *Dilecta*, containing letters and early recollections of friends, especially of Turner. These two books were published between 1855 and 1889; and except for occasional letters, notes and prefaces, they form the last writings of the author of *Modern Painters*. His literary career thus extends over fifty years. But he has left nothing more graceful, naïve and pathetic than his early memories in *Præterita*—a book which must rank with the most famous "Confessions" in any literature. The last ten years of his life were passed in complete retirement at Brantwood, in the loving care of the Severn family, to whom the estate was transferred, with occasional visits from friends, but with no sustained work beyond correspondence, the revision of his works, and a few notes and preface words to the books of others. He wished to withdraw his early art writings from circulation, but the public demand made this practically impossible. And now the whole of his writings are under the control of Mr George Allen, in several forms and prices, including a cheap series at 5s. per volume.

The close of his life was one of entire peace and honour. He was loaded with the degrees of the universities and membership of numerous societies and academies. "Ruskin Societies" were founded in many parts of the kingdom. His works were translated and read abroad, and had an enormous circulation

in Great Britain and the United States. Many volumes about his career and opinions were issued in his lifetime both at home and abroad. His 80th birthday, 8th February 1890, was celebrated by a burst of congratulations and addresses, both public and private. His strength failed gradually; his mind remained feeble but unclouded, and his spirit serene. An attack of influenza struck him down, and carried him off suddenly after only two days' illness, 20th January 1900. He was buried in Consiston churchyard by his own express wish, the family refusing the offer of a grave in Westminster Abbey.

Ruskin's literary life may be arranged in three divisions. From 1837 to 1860 (*æet.* 13 to 41) he was occupied mainly with the arts. From 1860 to 1871 (*æet.* 41 to 52) he was principally occupied with social problems. From 1871 to 1885 (*æet.* 52 to 66) he was again drawn back largely to art by his lectures as professor, whilst prosecuting his social Utopia by speech, pen, example and purse. But the essential break in his life was in 1860, which marks the close of his main works on art and the opening of his attempt to found a new social gospel. With regard to his views of art, he himself modified and revised them from time to time; and it is admitted that some of his judgments are founded on imperfect study and personal bias. But the essence of his teaching has triumphed in effect, and has profoundly modified the views of artists, critics and the public, although it has rarely been fully accepted as complete or final. The moral of his teaching—that all living art requires truth, nature, purity, earnestness—has now become the axiom of all aesthetic work or judgment. John Ruskin founded the Reformation in Art.

With regard to his economic and social ideas there is far less general concurrence, though the years that have passed since *Unto This Last* appeared have seen the practical overthrow of the rigid plutonomy which he denounced. So, too, the vague and sentimental socialism which pervades *Munera Pulveris*, *Time and Tide* and *Fors* is now very much in the air, and has inspired the notions of many energetic reformers. But the negative part of Ruskin's teaching on economics, social and political problems, has been much more effective than the positive part of his teaching. It must be admitted that nearly the whole of his practical experiments to realize his dreams have come to nothing, which is not unnatural, seeing his defiance of the ordinary habits and standards of the world. A more serious defect was his practice of violently assailing philosophers, economists and men of science, of whom he knew almost nothing, and whom he perversely misunderstood: men such as Adam Smith, Thomas Malthus, Spencer, and Darwin, who followed them. In art, Ruskin had enjoyed an unexampled training, which made him a consummate expert. In philosophy and science he was an amateur, seeking to found a new sociology and a Utopian polity out of his own inner consciousness and study of nature, of poetry and the Bible. It is not wonderful if, in doing this, he poured forth a quantity of crude conceits and some glaring blunders. But in the most Quixotic of his schemes, and the most Laputan of his theories, his pure and chivalrous nature, his marvellous insight into the heart of things and men, and his genius to seize on all that is true, real and noble in life, made his most startling proposals pregnant with meaning, and even his casual play full of fascination and moral suggestion.

In mastery of prose language he has never been surpassed, when he chose to curb his florid imagination and his discursive eagerness of soul. The beauty and gorgeous imagery of his art works bore away the public from the first, in spite of their heretical dogmatism and their too frequent extravagance of rhetoric. But his later economic and social pieces, such as *Unto this Last*, *Time and Tide*, *Sesame and Lilies*, are composed in the purest and most lucid of English styles. And many of his simply technical and explanatory notes have the same quality. Towards the close of his life, in *Fors* and in *Præterita*, will be found passages of tenderness, charm and subtlety which have never been surpassed in our language.

Ruskin's life and writings have been the subject of many works composed by friends, disciples and admirers. The principal is the *Life*, by W. G. Collingwood, his friend, neighbour and secretary (1900). His pupil, Mr E. T. Cook, published his *Studies in Ruskin* in 1890, with full details of his career as professor. Mr J. A. Hobson, in *John Ruskin, Social Reformer* (2nd ed., 1899), has elaborately discussed his social and economic teaching, and claims him as "the greatest social teacher of his age." An analysis of his works has been written by Mrs Meynell (1900). His art theories have been discussed by Professor Charles Waldstein of Cambridge in *The Work of John Ruskin* (1894), by Robert de la Sizeranne in *Ruskin et la religion de la beauté* (1897), and by Professor H. J. Brunhes of Fribourg in *Ruskin et la Bible* (1901). The monumental "library edition" of Ruskin's works (begun in 1903), prepared by Mr E. T. Cook, with Mr A. Wedderburn, is the greatest of all the tributes of literary admiration.

(F. H.A.)

RUSSELL (FAMILY). The great English Whig house of the Russells, earls and dukes of Bedford, rose under the favour of Henry VIII. Obsequious genealogists have traced their

lineage from "Hugh de Rozel," *alias* "Hugh Bertrand, lord of le Rozel," a companion of the Conqueror, padding their fiction with the pedigree of certain Russells who are found holding Kingston Russell in Dorset as early as the reign of King John. But the first undoubted ancestor of the Bedford line is Henry Russell, a Weymouth merchant, returned as a Burgess for that borough in four parliaments between 1425 and 1442. He may well have been the son of Stephen Russell, another Weymouth merchant, whose name is just before his in the list of those men of substance in Dorsetshire who, in 1434, under the act of parliament, were to be sworn not to maintain breakers of the peace. Stephen Russell, having served the office of bailiff of Weymouth, was returned as Burgess to the parliament of 1395, and one William Russell was returned for King's Melcombe in 1340. Both Stephen and Henry were in the wine trade with Bordeaux, and in 1427 Henry Russell was deputy to the chief butler of England for the port of Melcombe. In 1442 a pardon under the privy seal significantly describes Henry Russell of Weymouth, merchant, as *alias* Henry Gascoign, gentleman, and it is therefore probable that the ducal house of Bedford springs from a family of Gascon wine-merchants settled in a part of Dorsetshire, a county remarkable for the number of such French settlers.

Henry Russell of Weymouth made a firm footing upon the land by his marriage with Elizabeth Hering, one of the two daughters and co-heirs of John Hering of Chaldon Hering, a Dorsetshire squire of old family, heir of the Winterbournes of Winterbourne Clenston and of the Cernes of Draycot Cerne. John Russell, eldest son of this match, born before 1432, and returned to parliament for Weymouth in 1450, had his seat at Berwick in Swyre, he and his son and heir, James Russell, being buried in the parish church of Swyre.

Thus John Russell, son and heir of James, was born in a family of squire's rank, whose younger branches went on for many generations as merchants and shipowners at Weymouth. A happy accident is said to have brought him to court. The archduke Philip, son of the emperor Maximilian, was driven by heavy weather into Weymouth, whence Sir Thomas Trenchard had him escorted to the king at Windsor. According to tradition, John Russell, Trenchard's young kinsman, was lately home from his travels with a knowledge of foreign tongues, those travels being probably made in the mercantile interests of his family. As travelling companion, or as a spy upon the strange guests, young Russell was sent with the archduke, who is said to have commended him to King Henry. Certain it is that on the accession of Henry VIII. John Russell advanced rapidly, serving the crown as soldier and as diplomatic agent. He fought well at Théroutanne, saw the Field of Cloth of Gold and the French disaster at Pavia, lost an eye by an arrow at Morlaix. In 1523 he was knight-marshal of the king's household. In 1526 he married a rich widow, Anne, daughter and co-heir of Sir Guy Sapcotes by the co-heir of Sir Guy Wolston, a match which brought to the Russells the Buckinghamshire estate of Chenies, in whose chapel many generations of them lie buried. His peerage as Lord Russell of Chenies dated from 1539, and in the same year he had the Garter. Having held many high offices—lord high admiral, lord president of Devon, Cornwall, Dorset and Somerset, and lord privy seal—he was named by Henry VIII. as one of his executors. At the crowning of Edward VI. he was lord high steward, and after his defeat of the western rebels was raised, in 1550, to the earldom of Bedford. Queen Mary, like her brother, made him lord privy seal, although he is said to have favoured that Reformation which enriched him. He died in London in 1555, leaving to his son a vast estate of church lands and lands forfeited by less successful navigators of the troubled sea of Tudor politics. In the west he had the abbey lands of Tavistock, which give a marquess's title to his descendants. In Cambridgeshire he had the abbatical estate of Thorney, in Bedfordshire the Cistercian house of Woburn, now the chief seat of the Russells. In London he had Covent Garden with the "Long Acre." Thus the future wealth of his house was secured by those "immoderate grants" which made

a text for Edmund Burke's furious attack upon a duke of Bedford.

He left an only son, Francis, second earl of Bedford, K.G. (c. 1527-1585), who, being concerned in Wyatt's plot, escaped to the Continent and joined those exiles at Geneva whose religious sympathies he shared. He returned in 1557, and was employed by Queen Mary before her death. Under Queen Elizabeth he governed Berwick, and was lord-lieutenant of the northern counties. Three of his four sons died before him, the third, killed in a border fray, being father of Edward, third earl of Bedford, who died without issue in 1627. The fourth son, William, created Lord Russell of Thornhaugh in 1603, was a soldier who fought fiercely before Zutphen beside his friend Sir Philip Sidney, whom he succeeded as governor of Flushing, and was from 1594 to 1597 lord-deputy of Ireland. He died in 1613, leaving an only son, Francis, who in 1627 succeeded his cousin as fourth earl of Bedford. This earl built the square of Covent Garden, and headed the "undertakers" who began the scheme for draining the great Fen Level. He opposed the king in the House of Lords, but might have played a part as mediator between the sovereign and the popular party who accepted his leadership had he not died suddenly of the smallpox in 1641 on the day of the king's assent to the bill for Strafford's attainder. William, the eldest surviving son, succeeded as fifth earl, Edward, the youngest son, being father of Edward Russell (1653-1727), admiral of the fleet, who, having held the chief command in the victory of La Hogue, was created in 1697 earl of Orford. The fifth earl of Bedford, after fighting for the parliament at Edgehill and for the king at Newbury, surrendered to Essex and occupied himself with completing the drainage of the Bedford Level. He carried St Edward's staff at the crowning of Charles II., but quitted political life after the execution of his son, Lord Russell, in 1683. In 1694 he was created duke of Bedford and marquess of Tavistock, titles to which his grandson, Wrothesley Russell, succeeded in 1700. The "patriot" Lord Russell had added to the family estates by his marriage with Rachel, daughter and co-heir of Thomas Wrothesley, the fourth earl of Southampton, from whom she finally inherited the earl's property in Bloomsbury, with Southampton House, afterwards called Bedford House. Her son, the second duke of Bedford, married the daughter of a rich citizen, John Howland of Streatham, a match strangely commemorated by the barony of Howland of Streatham, created for the bridegroom's grandfather, the first duke, in 1695. The third duke, another Wrothesley Russell (1708-1732), died without issue, his brother John (1710-1771) succeeding him. This fourth duke, opposing Sir Robert Walpole, became, by reason of his rank and territorial importance, a recognized leader of the Whigs. In the duke of Devonshire's administration he was lord-lieutenant of Ireland, and he served as lord high constable at the coronation in 1760. His son Francis, styled marquess of Tavistock, was killed in 1767 by a fall in the hunting field, and Lord Tavistock's son Francis (1765-1802) became the fifth duke. This was the peer whom Burke, smarting from a criticism of his own pension, assailed as "the Leviathan of the creatures of the crown," enriched by grants that "outraged economy and even staggered credibility." He pulled down Bedford House, built by Inigo Jones, Russell Square and Tavistock Square rising on the site of its gardens and courts. Dying unmarried, he was succeeded by his brother John, the sixth duke (1766-1839), whose third son was the statesman created in 1861, Earl Russell of Kingston Russell, better known as Lord John Russell. Lord Odo Russell, a nephew of "Lord John," and ambassador at Berlin from 1871 to his death in 1884, was created Lord Amphilil in 1881. Herbrand Arthur Russell (b. 1858), the eleventh duke and fifteenth earl, succeeded an elder brother in 1893. (O. BA.)

RUSSELL, ISRAEL COOK (1852-), American geologist, was born at Garrattsville, New York, on the 10th of December 1852. He graduated at New York University in 1872, and later studied at the School of Mines, Columbia, where he was assistant professor of geology from 1875-77. He was assistant

Geologist on the United States Geographical and Geological Surveys in 1878, and in 1880 became attached to the Geological Survey of the United States. In 1892 he was appointed professor of geology in the university of Michigan.

His publications include *Sketch of the Geological History of Lake Lakomlan* (1885); *The Newark System* (Bulletin No. 85, U.S. Geol. Survey, 1892); *Present and Extinct Lakes of Nevada* (1896); *Glaciers of North America* (1897); *Volcanoes of North America* (1897); *Glaciers of Mount Rainier* (Ann. Rep. U.S. Geol. Survey, 1898); and *North America* (1900).

RUSSELL, JOHN (1745-1806), British portrait painter in pastel, was born at Guildford, Surrey. At an early age he entered the studio of Francis Cotes, R.A., from whom he derived his artistic education, and set up his own studio in 1767. Russell was a man of remarkable religious character, a devout follower of Whitefield. He began an elaborate introspective diary in Byrom's shorthand in 1766 and continued it to the time of his death. In it he records his own mental condition and religious exercises, entering with a certain morbid ingenuity into long disquisitions, and only occasionally recording information concerning his sitters. His religious life is the key to his complex character, as it actuated his whole career. He obtained the gold medal at the Royal Academy for figure drawing in 1770 and exhibited from the beginning of the Academy down to 1805. He was the finest painter in crayons England ever produced, and although he painted in oil, in water-colours and in miniature, it was by his works in crayon that his reputation was made. He wrote the *Elements of Painting in Crayon*, and described in it his method. He made his own crayons, blending them on his pictures by a peculiar method termed "sweetening." This he carried out with his fingers, rubbing in the colours and softening them in outline, uniting colour to colour so accurately that they melt into one another with a characteristic cadence. His pastel work is to oil painting "what the vaudeville is to the tragedy or the sonnet to the epic." His colours were pure and his blending so perfect that no change is to be seen in his works since they were executed. Sir Joseph Banks, writing in 1788 respecting his portraits of the president, of Lady, Mrs and Miss Banks, stated that "the oil pictures of the present time fade quicker than the persons they are intended to present, but the colours made use of by Russell will stand for ever," and in that prophecy is so far justified.

An important picture by him hangs in the Louvre ("Child with Cherries"), and two, including "The Old Bathing Man at Brighton," are owned by the crown. At the Royal Academy, of which he was a member, he exhibited three hundred and thirty works, and his portraits were engraved by Collyer, Turner, Heath, Dean, Bartolozzi, Trotter and other prominent engravers. Russell received warrants of appointment to the king, queen, prince of Wales and the duke of York. He was interested in astronomy, a friend of Sir W. Herschell, and no mean mathematician. He drew an exceedingly accurate map of the moon, and invented a piece of complicated mechanism for exhibiting its phenomena, publishing a pamphlet, illustrated by his own drawings, describing the apparatus.

Two of his sons inherited their father's talent, and one of them, William (1780-1870), exhibited five fine portraits in the Royal Academy.

See George C. Williamson, *John Russell* (London, 1894).

(G. C. W.)

RUSSELL, JOHN (d. 1494), English bishop and chancellor, was admitted to Winchester College in 1443, and in 1449 went to Oxford as fellow of New College. He resigned his fellowship in 1462, and appears to have entered the royal service. In April 1467 and January 1468 he was employed on missions to Charles the Bold at Bruges. He was there again in February 1470 as one of the envoys to invest Charles with the Garter: the Latin speech which Russell delivered on this last occasion was one of Caxton's earliest publications, probably printed for him at Bruges by Colard Mansion (see Blades, *Life of Caxton*, i. p. vii, ii. 29-31). In May 1474 he was promoted to be keeper of the privy seal, and retained his office even after his

consecration as bishop of Rochester on the 22nd of September 1476, and translation to Lincoln on the 9th of September 1480. As a trusted minister of Edward IV, he was one of the executors of the king's will; but on the 13th of May 1483 he accepted the office of chancellor in the interest of Richard of Gloucester, apparently with great reluctance. He retained the great seal till the 20th of July 1485. Russell was above all things an official, and was sometimes employed by Henry VII. in public affairs. But his last years were occupied chiefly with the business of his diocese, and of the university of Oxford, of which he had been elected chancellor in 1483. He died at Nettleham on the 30th of December 1494, and was buried at Lincoln Cathedral.

Sir Thomas More calls Russell "a wise manne and a good, and of much experience, and one of the best-learned men, undoubtedly, that England had in hys time." Two English speeches composed by Russell, for the intended parliament of Edward V., and the first parliament of Richard III., are printed in Nichols's *Grants of Edward V.* (Camden Soc.). Some other writings of less interest remain in manuscript.

For contemporary notices see especially More's *Life of Richard III.*, the *Continuation of the Croyland Chronicle* ap. Freeman *Scriptores*, and Bentley's *Excerpta Historica*, pp. 16-17. See also Wood's *History and Antiquities of the University of Oxford*, and T. Kirby, *Winchester Scholars*, and *Annals of Winchester College*. There are modern biographies in Campbell's *Lives of the Chancellors*, and Foss's *Judges of England*. (C. L. K.)

RUSSELL, JOHN RUSSELL, 1ST EARL (1792-1878), British statesman, third son of the 6th duke of Bedford, by Georgiana Elizabeth Byng, second daughter of the 4th Viscount Torrington, was born in London on the 18th of August 1792. He was sent to a private school at Sunbury in 1800, and from 1803 to 1804 he was at Westminster School, but was then withdrawn on account of his delicate health. From 1805 to 1808 he was with a private tutor at Woodnesborough, near Sandwich. After travelling in Scotland and in Spain, he studied from the autumn of 1809 to 1812 at the university of Edinburgh, then the academic centre of Liberalism, and dwelt in the house of Professor John Playfair. On leaving the university, he travelled in Portugal and Spain, but on the 4th of May 1813 he was returned for the dual borough of Tavistock and thereupon came back to England.

In foreign politics Lord John Russell's oratorical talents were especially shown in his struggles to prevent the union of Norway and Sweden. In domestic questions he cast in his lot with those who opposed the repressive measures of 1817, and protested that the causes of the discontent at home should be removed by remedial legislation. When failure attended all his efforts he resigned his seat for Tavistock in March 1817, and meditated permanent withdrawal from public life, but was dissuaded from this step by the arguments of his friends, and especially by a poetic appeal from his friend Tom Moore. In the parliament of 1818-20 he again represented the family borough in Devon, and in May 1819 began his long advocacy of parliamentary reform by moving for an inquiry into the corruption which prevailed in the Cornish constituency of Grampound. During the first parliament (1820-26) of George IV. he sat for the county of Huntingdon, and secured in 1821 the disfranchisement of Grampound, but the seats were not transferred to the constituency which he desired. Lord John Russell paid the penalty for his advocacy of Catholic emancipation with the loss in 1826 of his seat for Huntingdon county, but he found a shelter in the Irish borough of Bandon Bridge. He led the attack against the Test Acts by carrying in February 1828 with a majority of forty-four a motion for a committee to inquire into their operations, and after this decisive victory they were repealed (9th of May 1828). He warmly supported the Wellington ministry when it realized that the king's government could only be carried on by the passing of a Catholic Relief Act (April 1829). For the greater part of the short-lived parliament of 1830-31 he served his old constituency of Tavistock, having been beaten in a contest for Bedford county at the general election by one vote; and when Lord Grey's

Reform ministry was formed, in November 1830, Lord John Russell accepted the office of paymaster-general without a seat in the cabinet. This exclusion was the more remarkable in that he was chosen (1st of March 1831) to explain the provisions of the Reform Bill, to which the cabinet had given its formal sanction. The Whig ministry was soon defeated, but an appeal to the country increased the number of their adherents, and Lord John Russell was returned by the freeholders of Devon. After many a period of doubt and defeat, "the bill, the whole bill, and nothing but the bill" passed into law (7th of June 1832), and Lord John stood forth in the mind of the people as its champion. After the passing of the Reform Bill he sat for the S. division of Devon, and continued to retain the place of paymaster-general in the ministries of Lord Grey and Lord Melbourne. The former of these cabinets was broken up by the withdrawal of Mr Stanley, afterwards Lord Derby.

Lord John Russell had visited Ireland in the autumn of 1833 and had come back with a keen conviction of the necessity for readjusting the revenues of the Irish church. To these views he gave expression in a debate on the Irish Tithe Bill (May 1834), whereupon Stanley, with the remark that "Johnny has upset the coach," resigned his place. The latter was abruptly, if not rudely, dismissed by William IV. when the death of Lord Spencer promoted the leader of the House of Commons, Lord Althorp, to the peerage, and Lord John Russell was proposed as the spokesman of the ministry in the Commons (Nov. 1834). At the general election which ensued the Tories received a considerable accession of strength, but not sufficient to ensure their continuance in office, and the adoption by the House of Commons of the proposition, that the surplus funds of the Irish church should be applied to general education, necessitated the resignation of Sir Robert Peel's ministry (April 1835). In Lord Melbourne's new administration Lord John Russell became home secretary and leader of the House of Commons, but on his seeking a renewal of confidence from the electors of South Devon, he was defeated and driven to Stroud. The Whig ministry succeeded in passing a Municipal Reform Bill (7th of Sept. 1835), and a settlement of the tithe question in England and Ireland (1836). In May 1839, on an adverse motion concerning the administration of Jamaica, the ministry was left with a majority of five only, and promptly resigned. Sir Robert Peel's attempt to form a ministry was, however, frustrated by the refusal of the queen to dismiss the ladies of the bedchamber, and the Whigs resumed their places with Lord John Russell as secretary of state for the colonies. Their prospects brightened when Sir John Yarde Buller's motion of "no confidence" at the opening of the session of 1840 was defeated by twenty-one, but a similar vote was some months later carried by a majority of one, whereupon the Whig leader announced a dissolution of parliament (June 1841). At the polling-booth his friends sustained a crushing defeat; the return of Lord John Russell for the City of London was almost their solitary triumph.

On Sir Robert Peel's resignation (1846) the task of forming an administration was entrusted to Lord John Russell, and he remained at the head of affairs from July 1846 to Feb. 1852, but his tenure of office was not marked by any great legislative enactments. His celebrated Durham letter (4th of Nov. 1850) on the threatened assumption of ecclesiastical titles by the Roman Catholic bishops weakened the attachment of the "Peelites" and alienated his Irish supporters. The impotence of their opponents, rather than the strength of their friends, kept the Whig ministry in power, and, although beaten by a majority of nearly two to one on Mr Locke King's County Franchise Bill in February 1851, it could not divest itself of office. Lord Palmerston's unauthorized recognition of the French *coup d'état* was followed by his dismissal from the post of foreign secretary (Dec. 1851), but he had his revenge in the ejection of his old colleagues in February 1852. During Lord Aberdeen's administration Lord John Russell led the Lower House, at first as foreign secretary (to the 21st of February 1853), then without portfolio, and lastly as president of the council (June

1854). In 1854 he brought in a Reform Bill, but in consequence of the war with Russia the bill was allowed to drop. His popularity was diminished by this failure, and although he resigned in January 1855, on Mr Roebuck's motion for an inquiry into the conduct of the war in the Crimea, he did not regain his old position in the country. At the Vienna conference (1855) Lord John Russell was England's representative, and immediately on his return he became secretary of the colonies (May 1855), but the errors in his negotiations at the Austrian capital followed him and forced him to retire in July of the same year.

For some years after this he was the "stormy petrel" of politics. He was the chief instrument in defeating Lord Palmerston in 1857. He led the attack on the Tory Reform Bill of 1859. A reconciliation was then effected between the rival Whig leaders, and Lord John Russell consented to become foreign secretary in Lord Palmerston's ministry (1860) and to accept an earldom (July 1861). During the American War Earl Russell's sympathies with the North restrained his country from taking sides in the contest, and he warmly sympathized with the efforts for the unification of Italy, but he was not equally successful in preventing the spoliation of Denmark. On Lord Palmerston's death (October 1865) Earl Russell was once more summoned to form a cabinet, but the defeat of his ministry in the following June on the Reform Bill which they had introduced was followed by his retirement from public life. His leisure hours were spent after this event in the preparation of numberless letters and speeches, and in the composition of his *Recollections and Suggestions* (1875), but everything he wrote was marked by the belief that all philosophy, political or social, was summed up in the Whig creed of fifty years previously. Earl Russell died at Pembroke Lodge, Richmond Park, 28th May 1878.

Earl Russell was twice married—first in 1835, to Adelaide, daughter of Mr Thomas Lister, and widow of Thomas, second Lord Ribblesdale, and secondly, in 1841, to Lady Frances Ann Maria, daughter of Gilbert, second earl of Minto. By the former he had two daughters, by the latter three sons and one daughter. His eldest son, Lord Amberley, who married a daughter of the second Baron Stanley of Alderley, predeceased him on the 9th of January 1876, and their eldest son (b. 1865) succeeded as second Earl Russell.

Lord Russell played some part as an author. His tales, tragedies and essays (including *The Nun of Arrouca*, 1822, and *Essays and Sketches by a Gentleman who has left his Lodgings*, 1820) are forgotten, but his historical works, *Life of William Lord Russell* (1819), *Memoirs of the Affairs of Europe* (1824-29, 2 vols.), *Correspondence of John, 4th Duke of Bedford* (1842-46, 3 vols.), *Memorials and Correspondence of C. J. Fox* (1853-57, 4 vols.) and *Life and Times of C. J. Fox* (1859-66, 3 vols.) are among the chief authorities on Whig politics. He also edited the *Memoirs, Journal and Correspondence of Thomas Moore* (1853-56, 8 vols.).

The chief biography is that by Sir Spencer Walpole (1891, 2 vols.). The volume by Stuart J. Reid (1895, "Prime Ministers of Queen Victoria" Series) should also be consulted. (W. P. C.)

RUSSELL, JOHN SCOTT (1808-1882), British engineer, was born in 1808 near Glasgow, a "son of the manse," and was at first destined for the ministry. But this intention on his father's part was changed in consequence of the boy's early leanings towards practical science. He attended in succession the universities of St Andrews, Edinburgh and Glasgow, taking his degree in the last-named at the age of sixteen. After spending a couple of years in workshops, he settled in Edinburgh as a lecturer on science, and soon attracted large classes. In 1832-33 he was engaged to give the natural philosophy course at the university, the chair having become vacant by the death of Sir John Leslie. In the following year he began his remarkable series of observations on waves. Having been consulted as to the possibility of utilizing steam-navigation on the Edinburgh & Glasgow canal, he replied that the question could not be answered without experiments, which he was willing to undertake if a portion of the canal were placed at his disposal. The results of this inquiry are to be found in the *Trans. Roy. Soc. Ed.* (vol. xiv.), and in the *British*

Association Reports (seventh meeting). The existence of the long wave, or wave of translation, with many of its most important features, was here first recognized, and it was clearly pointed out why there is a special rate, depending on the depth of the water, at which a canal-boat can be towed at the least expenditure of effort by the horse. The elementary mathematical theory of the long wave was soon supplied by commentators on Scott Russell's work, and a more complete investigation was subsequently given by Sir G. G. Stokes. Russell indulged in many extraordinary and groundless speculations, some of which were published in a posthumous volume, *The Wave of Translation* (1885). His observations led him to propose and experiment on a new system of shaping vessels, known as the wave system, which culminated in the building of the "Great Eastern." His activity and ingenuity were also displayed in many other fields,—steam-coaches for roads, improvements in boilers and in marine engines, the immense iron dome of the Vienna Exhibition, cellular double bottoms for iron ships, &c. With Mr Stafford Northcote (afterwards Lord Idlesleigh), he was joint-secretary of the Great Exhibition of 1851; and he was one of the chief founders of the Institution of Naval Architects. He died at Ventnor on the 8th of June 1882.

RUSSELL, THOMAS (1762–1788), English poet, was born at Beaminster, early in 1762. He was the son of John Russell, an attorney at Bridport, in Dorsetshire, and his mother was Miss Virtue Brickle, of Shaftesbury. He was educated at the grammar school of Bridport, and in 1777 proceeded to Winchester, where he stayed three years, under Dr Joseph Warton, and Thomas Warton, the professor of poetry. In 1780 Russell became a member of New College, Oxford. He graduated B.A. in 1784 and was ordained priest in 1786. During his residence at the university he devoted himself to French, Italian, Spanish, Portuguese, Provençal and even German literature. His health, however, broke down, and he retired to Bristol hot wells to drink the waters; but in vain, for he died there on the 31st of July 1788. He was buried in Powerstock churchyard, Dorset. In 1789 was published a thin volume, containing his *Sonnets and Miscellaneous Poems*, now a very rare book. It contained twenty-three sonnets, of regular form, and a few paraphrases and original lyrics. The sonnets are the best, and it is by right of these that Russell takes his place as one of the most interesting precursors of the romantic school. "War, Love, the Wizard, and the Fay he sung"—in other words, he rejected entirely the narrow circle of subjects laid down for 18th-century poets. In this he was certainly influenced both by Chatterton and by Collins. But he was still more clearly the disciple of Petrarch, of Boccaccio and of Camoens, each of whom he had carefully and enthusiastically studied. His sonnet, "Suppos'd to be written at Lemnos," is his masterpiece, and is unquestionably the greatest English sonnet of the 18th century.

The anonymous editor of Russell's solitary volume is said to have been William Howley (1766–1848), long afterwards archbishop of Canterbury, who was a youthful bachelor of New College when Russell, who had been his tutor, died. His memoir of the poet is very perfunctory, and the fullest account of Russell is that published in 1897 by T. Seacombe.

RUSSELL, WILLIAM CLARK (1844–), British author, was born at the Carlton House Hotel, New York, on the 24th of February 1844, the son of Henry Russell, author of "Cheer, Boys, Cheer," and other popular songs. He went to school at Winchester, and then at Boulogne, joining the merchant service at thirteen, and serving for eight years. This apprenticeship to a seafaring life was turned to account in a series of stories which have fascinated two generations of boy readers. *John Holdsworth, Chief Mate* (1874), immediately made his reputation. Other successful stories were: *The Wreck of the Grosvenor* (1875), in which he pleaded for better food for English seamen; *The Frozen Pirate* (1877), *An Ocean Tragedy* (1881), *The Emigrant Ship* (1894), *The Ship, Her Story* (1894), *The Convict Ship* (1895), *What Cheer!* (1895), *The Two Captains* (1897), *The Romance of a Midshipman* (1898), *The Ship's*

Adventure (1899), *Oerdue* (1903), *Abandoned* (1904), *His Island Princess* (1905). He joined the staff of the *Newcastle Daily Chronicle*, and afterwards became a leader writer on the *Daily Telegraph*, but the double labour of journalism and novel-writing threatened his health, and he resigned in 1887. Many of the papers which he contributed to the *Daily Telegraph* were collected in volume form in *Round the Galley Fire* and other volumes. He also wrote a *Life of Lord Collingwood* (1891), and, with W. H. Jacques, *Nelson and the Naval Supremacy of England* (New York, 1890).

RUSSELL, SIR WILLIAM HOWARD (1821–1907), English war correspondent, was born at Lilyvale, near Tallaght, in the county of Dublin, on the 28th of March 1821, being one of the Russells of Limerick, whose settlement in Ireland dates from the time of Richard II. He entered Trinity College in 1838. Three years later he was thrown very much on his own resources, but a relative, Mr R. W. Russell, who had been sent to Ireland by *The Times*, deputed him to report the Irish elections at Longford, and his success definitely turned his attention to journalism. Coming to London in 1842, he went to Cambridge, but left before taking a degree. In the following year he was sent by *The Times* to Ireland to report the O'Connell meetings. In 1845 he was appointed to superintend the reports on the Irish railways, and was shortly afterwards sent by *The Times* to inspect the O'Connell property in S.W. Ireland, when his plain speaking drew forth a characteristic tirade from the "Liberator." For a short period in 1847 his services were temporarily transferred to the *Morning Chronicle*, but with that exception he remained permanently connected with *The Times*. He was sent as special correspondent to Denmark in the war of 1849–50. He did not, however, at once relinquish a legal career, and was called to the bar at the Middle Temple in 1851. On the outbreak of the Crimean War in 1853 he went out as special correspondent, and, accompanying the light division to Gallipoli, proceeded with the first detachment to Varna. On the embarkation for the Crimea he was attached to the second division, and landed with it on the 14th of September. He was present at the battle of the Alma on the 20th of September, at the investment of Sevastopol, at Balaklava on the 25th of October and Inkerman on the 5th of November.

Towards the end of May 1855 he accompanied the expedition to Kertch, and did not return to the Crimea until the following August. In September and October he described the attacks on the Malakoff and Redan, the occupation of Sevastopol and the capture of Fort Kiburn. The popularity of *The Times* Crimea correspondence led to its republication in two volumes under the title of *The War, 1855–56*. Russell's letters to *The Times* were mainly responsible for the enlightenment of the public at home as to the conduct of affairs at the scene of action, and his exposure of the mismanagement during the winter of 1854 did more than anything else to cause the downfall of Lord Aberdeen's ministry. In 1856 Russell was sent to Moscow to describe the coronation of the tsar, and in the following year was attached to the headquarters of Lord Clyde in India. He was present at the siege and capture of Lucknow in 1858, the operations in Oude, the battle of Bareilly and the actions in Rohilkhand, and he received the Indian war medal with the Lucknow clasp. The events of those stirring times are vividly recorded in *My Diary in India in 1858–59*. Next year he was sent to Italy, but arrived on the eve of the armistice at Villafranca. On the 7th of January 1860 appeared the first number of the *Army and Navy Gazette*, which he founded, and of which he was editor and principal proprietor. In 1861 Russell proceeded to Washington, and reached M'Dowell's headquarters just before the first battle of Bull Run, and his account of the Federal retreat drew much hostile criticism. He published a full account of the war, in so far as he had witnessed it, in *My Diary, North and South, during the Civil War in America, 1862*. Returning to England in 1863, he remained at home until 1866, when he proceeded to the headquarters of General Benedek and witnessed the battle of Königgrätz, 3rd of July.

During the interval of peace that followed he accompanied the prince of Wales to the Nile, Constantinople, the Crimea and Greece in 1868, and published an account of the tour in the following year, when he also contested the borough of Chelsea unsuccessfully in the Conservative interest. On the outbreak of the Franco-Prussian War in 1870, Russell was with the crown prince from the battle of Wörth, 6th of August, and Sedan, 12th of September, till the capitulation of Paris. His account appeared in 1874 under the title of *My Diary during the Last Great War*. His description of the burning of Paris by the Communards was not the least of his journalistic triumphs. In 1875-76 he was honorary private secretary to the prince of Wales during his tour through India, of which he published an account in 1877. When Lord Wolseley was sent to quell the Zulu rebellion in 1879, Russell was attached to his staff as correspondent. In 1881 he went with the duke of Sutherland's party for a tour in the United States and Canada, described in *Hesperothen*, and in 1882 he was again with Lord Wolseley in the Egyptian campaign. In 1895 he published a personal retrospect entitled *The Great War with Russia*. Russell was knighted in May 1895, and was the recipient of numerous war medals and various foreign orders. He married twice, first in 1846 Miss Burrowes, who died not long afterwards, and secondly in 1884 the Countess A. Malvezzi. He died on the 11th of February 1907.

RUSSELL, LORD WILLIAM (1639-1683), English politician, was the third son of the 1st duke of Bedford and was born on the 20th of September 1639. About 1654 he was sent to Cambridge with his elder brother Francis (on whose death in 1678 he obtained the courtesy title of Lord Russell). On leaving the university, the two brothers travelled abroad, visiting Lyons and Geneva, and residing for some while at Augsburg. William's account of his impressions is spirited and interesting. He was at Paris in 1658, but had returned to Woburn in December 1659. At the Restoration he was elected for the family borough of Tavistock. For a long time he appears to have taken no part in public affairs, but rather to have indulged in the follies of court life and intrigue; for both in 1663 and 1664 he was engaged in duels, in the latter of which he was wounded. In 1669 he married Rachel (1636-1723), second daughter of the 4th earl of Southampton, and widow of Lord Vaughan, thus becoming connected with Shaftesbury, who had married Southampton's niece. With his wife Russell always lived on terms of the greatest affection and confidence. She corresponded with Tillotson and other distinguished men, and a collection of her admirable letters was published in 1773.

It was not until the formation of the "country party," in opposition to the policy of the Cabal and Charles's French-Catholic plots, that Russell began to take an active part in affairs. He then joined Cavendish, Birch, Hampden, Powell, Lyttleton and others in vehement antagonism to the court. With a passionate hatred and distrust of the Catholics, and an intense love of political liberty, he united the desire for ease to Protestant Dissenters. His first speech appears to have been on the 22nd of January 1673, in which he inveighed against the stop of the exchequer, the attack on the Smyrna fleet, the corruption of courtiers with French money, and "the ill ministers about the king." He also supported the proceedings against the duke of Buckingham. In 1675 he moved an address to the king for the removal of Danby (see LEEDS, DUKE OF) from the royal councils, and for his impeachment. On the 15th of February 1677, in the debate on the fifteen months' prorogation, he moved the dissolution of parliament; and in March 1678 he seconded the address praying the king to declare war against France. The enmity of the country party against Danby and James, and their desire for a dissolution and the disbanding of the army, were greater than their enmity to Louis. The French king therefore found it easy to form a temporary alliance with Russell, Hollis and the opposition leaders, by which they engaged to cripple the king's power of hurting France and to compel him to seek Louis's friendship,—that friendship, however, to be given only on the condition that they in their turn

should have Louis's support for their cherished objects. Russell in particular entered into close communication with the marquis de Ruigny (Lady Russell's maternal uncle), who came over with money for distribution among members of parliament. By the testimony of Barillon, however, it is clear that Russell himself utterly refused to take any part in the intended corruption.

By the wild alarms which culminated in the Popish Terror Russell appears to have been affected more completely than his otherwise sober character would have led people to expect. He threw himself into the party which looked to Monmouth as the representative of Protestant interests, a grave political blunder, though he afterwards was in confidential communication with Orange. On the 4th of November 1678 he moved an address to the king—to remove the duke of York from his person and councils. At the dissolution of the pensionary parliament, he was, in the new elections, returned for Bedfordshire. Danby was at once overthrown, and in April 1679 Russell was one of the new privy council formed by Charles on the advice of Temple. Only six days after this we find him moving for a committee to draw up a bill to secure religion and property in case of a popish successor. He does not, however, appear to have taken part in the exclusion debates at this time. In June, on the occasion of the Covenanters' rising in Scotland, he attacked Lauderdale personally in full council.

In January 1680 Russell, along with Cavendish, Capell, Powell, Essex and Lyttleton, tendered his resignation to the king, which was received by Charles "with all my heart." On the 16th of June he accompanied Shaftesbury, when the latter indicted James at Westminster as a popish recusant; and on the 26th of October he took the extreme step of moving "how to suppress popery and prevent a popish successor"; while on the 2nd of November, now at the height of his influence, he went still further by seconding the motion for exclusion in its most emphatic shape, and on the 19th carried the bill to the House of Lords for their concurrence. The limitation scheme he opposed, on the ground that monarchy under the conditions expressed in it would be an absurdity. The statement, made by Echard alone (*Hist. of England*, ii.), that he joined in opposing the indulgence shown to Lord Strafford by Charles in dispensing with the more horrible parts of the sentence of death—an indulgence afterwards shown to Russell himself—is entirely unworthy of credence. On December 18 he moved to refuse supplies until the king passed the Exclusion Bill. The prince of Orange having come over at this time, there was a tendency on the part of the opposition leaders to accept his endeavours to secure a compromise on the exclusion question. Russell, however, refused to give way a hair's-breadth.

On the 26th of March 1681, in the parliament held at Oxford, Russell again seconded the Exclusion Bill. Upon the dissolution he retired into privacy at his country seat of Stratton in Hampshire. It was, however, no doubt at his wish that his chaplain wrote the *Life of Julian the Apostate*, in reply to Dr Hickeys's sermons, in which the lawfulness of resistance in extreme cases was defended. In the wild schemes of Shaftesbury after the election of Tory sheriffs for London in 1682 he had no share; upon the violation of the charters, however, in 1683, he began seriously to consider as to the best means of resisting the government, and on one occasion attended a meeting at which treason, or what might be construed as treason, was talked. Monmouth, Essex, Hampden, Sidney and Howard of Escrick were the principal of those who met to consult. On the breaking out of the Rye House Plot, of which neither he, Essex, nor Sidney had the slightest knowledge, he was accused by informers of promising his assistance to raise an insurrection and compass the death of the king. Refusing to attempt to escape, he was brought before the council, when his attendance at the meeting referred to was charged against him. He was sent on the 26th of June 1683 to the Tower, and, looking upon himself as a dying man, betook himself wholly to preparation for death. Monmouth offered to appear to take his trial, if thereby he could help Russell, and Essex refused to abscond for fear of injuring his friend's chance of escape. Before a committee of

the council Russell, on the 28th of June, acknowledged his presence at the meeting, but denied all knowledge of the proposed insurrection. He reserved his defence, however, until his trial. He would probably have saved his life but for the perjury of Lord Howard. The suicide of Essex, the news of which was brought into court during the trial, was quoted as additional evidence against him, as pointing to the certainty of Essex's guilt. On July 19 he was tried at the Old Bailey, his wife assisting him in his defence. Evidence was given by an informer that, while at Shaftesbury's hiding-place in Wapping, Russell had joined in the proposal to seize the king's guard, a charge indignantly denied by him in his farewell paper, and that he was one of a committee of six appointed to prepare the scheme for an insurrection. Howard, too, expressly declared that Russell had urged the entering into communications with Argyll in Scotland. Howard's perjury is clear from other witnesses, but the evidence was accepted. Russell spoke with spirit and dignity in his own defence, and, in especial, vehemently denied that he had ever been party to a design so wicked and so foolish as those of the murder of the king and of rebellion. It will be observed that the legality of the trial, in so far as the jurors were not properly qualified and the law of treason was shamefully strained, was denied in the act of 1 William & Mary which annulled the attainder. Hallam maintains that the only overt act of treason proved against Russell was his concurrence in the project of a rising at Taunton, which he denied, and which, Ramsay being the only witness, was not sufficient to warrant a conviction.

Russell was sentenced to die. Many attempts were made to save his life. The old earl of Bedford offered £50,000 or £100,000, and Monmouth, Legge, Lady Ranelagh, and Rochester asked their intercessions. Russell himself, in petitions to Charles and James, offered to live abroad if his life were spared, and never again to meddle in the affairs of England. He refused, however, to yield to the influence of Burnet and Tillotson, who endeavoured to make him grant the unlawfulness of resistance, although it is more than probable that compliance in this would have saved his life. He drew up, with Burnet's assistance, a paper containing his apology, and he wrote to the king a letter, to be delivered after his death, in which he asked Charles's pardon for any wrong he had done him. A suggestion of escape from Lord Cavendish he refused. He behaved with his usual quiet cheerfulness during his stay in the Tower, spending his last day on earth as he had intended to spend the following Sunday if he had reached it. He received the sacrament from Tillotson, and Burnet twice preached to him. Having supped with his wife, the parting from whom was his only great trial, he slept peacefully, and spent the last morning in devotion with Burnet. He went to the place of execution in Lincoln's Inn Fields with perfect calmness, which was preserved to the last. He died on the 21st of July 1683, in the forty-fourth year of his age. His attainder was reversed in 1689, and his son Wrothesley (1680-1711) succeeded his grandfather as 2nd duke of Bedford in 1700.

A true and moderate summing-up of his character will be found in his *Life*, by Lord John Russell (1820). (O. A.)

RUSSELL OF KILLOWEN, CHARLES RUSSELL, BARON (1832-1900), lord chief justice of England, was born at Newry, county Down, on the 10th of November 1832. He was the elder son of Arthur Russell, a Roman Catholic gentleman, who was engaged in commerce and brewing in Newry. Educated first at Belfast, afterwards in Newry, and finally at St Vincent's College, Castleknock, Dublin, in 1849, he was articled to a firm of solicitors in Newry. In 1854 he was admitted, and began to practise his profession. Disturbances between Roman Catholics and Orangemen were at that time prevalent in this part of Ireland, and in the legal proceedings which ensued at quarter and petty sessions young Russell distinguished himself as a bold and skilful advocate in the cause of his co-religionists. The political zeal which always formed an important element in Russell's character happily harmonized with these professional duties. After practising, however, for two years, he determined to seek a wider field for his abilities,

and to become a barrister in England. It was a wise ambition, early conceived by young Russell, stimulated by his present success, and encouraged by the counsel of at least one competent adviser, Judge Jones, who was much impressed by Russell's ability in the conduct of a case at the Newry quarter sessions. He believed, moreover, that to succeed at the Irish bar he would have (to use his own phrase) to "swallow his convictions." With this end in view Russell, whilst still practising and residing in Belfast, became a student of Trinity College, Dublin. He matriculated there in 1855, and passed examinations from time to time, but did not wait to become a graduate. In 1856 he went to London and became a student of Lincoln's Inn. In 1858 he married, in Belfast, Ellen, the eldest daughter of Dr Mulholland, a physician of distinction in that city. In 1859 he was called to the bar, after gaining by examination a first-class honour certificate, and joined the Northern Circuit. Except some valuable introductions to friends in London and Liverpool, which his uncle, the president of Maynooth, had given to him, Russell brought to the work of his profession no external aids. He had to rely upon himself. But the equipment was sufficient. A well-built frame; a strong, striking face, with broad forehead, keen grey eyes, and a full and sensitive mouth; a voice which, though not musical, was rich, and responded well to strong emotions, whether of indignation, or scorn, or pity; an amazing power of concentrating thought; an intellectual grasp, promptly seizing the real points of the most entangled case, and rejecting all that was secondary, or petty, or irrelevant; a faculty of lucid and forcible expression, which, without literary ornateness or grace of style, could on fit occasions rise to impassioned eloquence—all these things Russell had. But beyond and above all these was his immense personality, an embodiment of energetic will which riveted attention, dominated his audience, and bore down opposition. His successful advocacy in the Colin Campbell divorce case in 1886, and his famous cross-examination of hostile witnesses and still more famous speech before the Parnell Commission in 1888, afforded perhaps the best examples of Russell's characteristic powers. He was not a learned lawyer in the sense in which Willes, or Mellish, or Blackburn were learned lawyers; he did not possess the fine legal acumen of his great contemporary, Herschell; but he had a sufficient apprehension of legal principles. He handled a point of law with telling directness and force. His argument as the leading counsel for Great Britain in the Bering Sea Arbitration in 1893, and his address at Saratoga Springs on International Law and International Arbitration in August 1896, were expositions of law in its practical application to matters of state which the most learned jurist must admire for their thoroughness and perspicuity.

Russell's success, after he joined the Northern Circuit, did not, of course, come to him at once. For some time his work in court was principally in the Court of Passage at Liverpool, which he regularly attended from London. He wrote a book on its procedure, which was published in 1862. This ancient local court, possessing both common law and Admiralty jurisdiction, had as its presiding judge—then styled "assessor"—an eminent leader of the Northern Circuit, Mr Edward James. Substantial commercial cases were tried there, and of these Russell soon had a goodly portion. Steadily, and, for a barrister, speedily, Russell's fortune grew. His biographer, Mr Barry O'Brien, has given, in *The Life of Lord Russell of Killowen* (1901), an account of Russell's fees, which shows that they were, in round figures: in 1859, £117; in 1862, £1016; in 1866, £2367; and in 1870, £4230. At the beginning of this period Russell wrote occasionally for the newspapers, and especially for the Irish press. From early boyhood onwards he maintained a keen interest in politics, and pre-eminently in the public affairs of Ireland. In 1859 he published a pamphlet entitled *The Catholic in the Workhouse*, and an article from his pen is to be found in *The Dublin Review*, vol. xlviii. p. 497. His legal work was not wholly confined to the north of England. He was employed at the Guildhall and elsewhere by solicitors of position in the City of London. He was one of the counsel engaged in

the Windham lunacy case in 1861, and in the action of *Saurin v. Starr* in 1869. In 1865 he argued in *ex parte* Chavasse before Lord Westbury, L.C., and soon afterwards was honoured by him with the offer of a county court judgeship.

In 1872 Russell took "silk," and from that date for some time he divided the best leading work of the circuit with Holker, Herschell and Pope. In 1874 Holker became solicitor-general in the Conservative administration. In 1880 Herschell accepted the same office in a Liberal ministry, and about the same time Pope practically left the circuit, to become in a short time one of the most successful advocates at the parliamentary bar. Russell's success as a Q.C. during this period of his career was prodigious. He excelled in the conduct alike of commercial cases and of those involving, as he used to say, "a human interest," although undoubtedly it was the latter which more attracted him. He was seen to the least advantage in cases which involved technical or scientific detail. If his advocacy suffered a defeat, however, it was never an inglorious defeat. Those who were on the Northern Circuit at the time will not easily forget the case of *Dixon v. Pimmsoll*—a libel action brought by a Liverpool shipowner against Mr. S. Pimmsoll—tried before Baron Amphlett and a Liverpool special jury, in which Holker won a notable victory for the defendant; or *Nuttall v. Wilde*, a breach of promise action, in which Pope led brilliantly for the successful plaintiff, and Russell's speech for the defence was one of the finest in point of passion and pathos that was ever heard upon the Northern Circuit. At the same time, with all his fighting power, Russell was eminently a sagacious adviser. No barrister knew better how and when to settle a case, where the client's true interest called for a settlement.

In 1880 a new phase of Russell's arduous life began. He was returned to parliament as an independent Liberal member for Dundalk, a constituency which he had twice before unsuccessfully contested. From that time forward until his appointment to a lordship of appeal in succession to Lord Bowen in 1894, he sat in the House of Commons: for Dundalk until 1885, and afterwards for South Hackney, where he was returned as the Liberal member on four successive occasions—once in 1885, twice in 1886, and again in 1892. The entrance into parliament laid upon Russell's time and labour a heavy additional tax. His was a nature which could not, in work or even in pleasure, be content to do anything lightly or by halves. He was essentially a man of action; intensity—at times almost fierce intensity—both of purpose and of devotion to its fulfilment characterized everything he did. Upon such a man parliamentary life between 1880 and 1894 necessarily entailed a severe strain. During the whole of this epoch, in home affairs, Irish business almost monopolized the political stage; and Russell was Irish to the core. From 1880 to 1886, as a private member, and as the attorney-general in Mr Gladstone's administrations of 1886 and 1892, he worked in and out of parliament for the Liberal policy in regard to the treatment of Ireland as few men except Russell could or would work. He never spared himself. After a long day in the turmoil of the courts, he cheerfully gave a long evening to a distant and often, from the standpoint of personal notoriety, an obscure, platform. His position throughout was clear and consistent. Before 1886 on several occasions he supported the action of the Irish Nationalist party. He opposed coercion, voted for compensation for disturbance, advocated the release of political prisoners and voted for the Maamtrasna inquiry. He wrote to the *Daily Telegraph* a series of letters on the Irish land question, which were afterwards published (1889) in a collected form. But he never became a member of the Irish Home Rule or of the Parnellite party; he was elected at Dundalk as an independent Liberal, and such he remained. He was proud of the kingdom in whose might and glory Ireland could claim so large a part; and when, as attorney-general in the Gladstone administration, he warmly advocated the establishment of a subordinate parliament in Ireland, he did so because he sought the amelioration and not the destruction of Ireland's relations with the rest of that kingdom. "I am absolutely opposed," he said (*The Life*

of Lord Russell of Killowen, p. 104) to the South Hackney voters, "to separation; but, reserving imperial control on all imperial questions, I think Irishmen on Irish soil should have the power of dealing in the way which seems best to them with all questions that concern them." It is impossible to say that Russell's success in the House of Commons, considerable as it was, was comparable to his success as an advocate in the courts of justice. He was listened to, always with respect and often with admiration, but he was not made for a debater; and the position of a law officer has generally not proved favourable to the attainment of parliamentary eminence. In great public affairs the law officer advises and supports, but not for him is the glory of initiating public policy.

Russell's parliamentary duties, fully as he discharged them, first as a private member and afterwards as attorney-general, were not allowed by him to obstruct his professional career. He rapidly became in London what he was already in Lancashire, the favourite leader in *nisi prius* actions. The list of *causes célèbres* in the period 1880-94 is really a record of Russell's cases, and, for a great part, of Russell's victories. The best known of the exceptions from the latter category was the libel action *Belt v. Lawes* in 1882, which, after a trial before Baron Huddleston and a special jury lasting more than forty days, resulted in a verdict for the plaintiff, for whom Sir Hardinge Giffard (afterwards Lord Chancellor Halsbury) appeared as leading counsel. The triumph of his client in the Colin Campbell divorce suit in 1886 afforded perhaps the most brilliant instance of Russell's forensic capacity in private litigation. His fees in 1885, the year before he became attorney-general, amounted to nearly £17,000. More important, however, as well as more famous, than any of his successes in the ordinary courts of law during this period were his performances as an advocate in two public transactions of mark in British history. The first of these in point of date was the Parnell Commission of 1888-90, in which Sir Charles Russell appeared as leading counsel for Mr Parnell. The commission held its first sitting on the 22nd of October 1888, and presented its report in February 1890. In April 1889, after 63 sittings of the commission, in the course of which 340 witnesses had been examined, Sir Charles Russell, who had already destroyed the chief personal charge against Mr Parnell by a brilliant cross-examination, in which he proved it to have been based upon a forgery, made his great opening speech for the defence. It lasted several days, and concluded on the 12th of April. This speech, besides its merit as a wonderful piece of advocacy, possesses permanent value as an historical survey of the Irish question during the last century, from the point of view of an Irish Liberal. It was in the same year published after careful revision by its author (1889). The second public transaction was the Bering Sea Arbitration, held in Paris in 1893. Sir Charles Russell, then attorney-general, with Sir Richard Webster (afterwards Lord Alverstone, L.C.J.), was the leading counsel for Great Britain. Russell, in the course of his very powerful argument before the tribunal, maintained the proposition, which he again handled in his Saratoga address to the American Bar Association in 1896, that "international law is neither more nor less than what civilized nations have agreed shall be binding on one another as international law." The award was, substantially, in favour of Great Britain. In recognition of their distinguished services, the queen bestowed upon both the leading representatives of Great Britain the honour of the grand cross of St Michael and St George.

In 1894 Russell's career as an advocate ended. A judgeship, if he had wished it, had been within his reach twelve years before. In 1894, on the death of Lord Bowen, he accepted the position of a lord of appeal. A month later he was appointed lord chief justice of England in succession to Lord Coleridge, to whose memory he devoted in the following September a paper in the *North American Review*. To the discharge of his functions as a judge Russell brought with him all the qualities of intellect and character which had made him so eminent as an advocate, and their greatness was not less conspicuous in his

new position. Brief as was his tenure of the office, he proved himself well worthy of it. He was dignified without pomposness, quick without being irritable, and masterful without tyranny. He was scrupulously punctual. Suitors and hearers could not but be impressed by the manifest determination of the lord chief justice to get at the truth, and to do so without waste of time. If this was a fault, it was that of excessive zeal for despatch. When, occasionally, there were flashes of impatience, they were elicited by the exhibition, as he deemed it, of want of preparation, or slovenliness, or verbosity on the part of the advocate before him. Even the youngest and most obscure practitioner could always count upon the assiduous attention of the lord chief justice to a pertinent and thoughtful argument. In 1806 Lord Russell (Pollock B. and Hawkins J. being on this occasion his colleagues on the bench) presided at the trial at bar of the leaders of the Jameson Raid. It was a state trial of grave importance. Russell's conduct of it, in the midst of much popular excitement, was by itself sufficient to establish his reputation as a great judge. One other event at least in his career while lord chief justice deserves a record, namely, his share in the Venezuela Arbitration in 1899. Lord Herschell, who had been nominated to act with Lord Justice Collins (afterwards Master of the Rolls), as a British representative on the Commission of Arbitration, of which the distinguished Russian jurist M. Martens was president, died somewhat suddenly in America before the beginning of the proceedings. The lord chief justice accepted the invitation to take the vacant place, and performed his very onerous duty with conspicuous ability.

Nor was it only on the bench or as an international judge that Lord Russell of Killowen sought, during the last years of his busy life, to do service to his country. He signaled his zeal as a law reformer by the public advocacy of radical changes in the system of legal education in the Inns of Court, and by the promotion of measures to put down the vice of secret and illicit commissions in commercial and business life. On the former subject he delivered in 1805 an address in Lincoln's Inn Hall, under the auspices of the Council of Legal Education, which was afterwards printed and published. In 1809, dealing with the latter question, he introduced in the House of Lords a bill, which had its first reading. He again introduced a bill in the session of 1900, which was read a second time, but did not become law. On the 10th of August 1900 the great advocate and great judge passed quietly away at his London residence, after a short illness due to an internal malady.

In private as in public life Russell was always strenuous, and most attracted by things that called for the exercise of activity, whether bodily or intellectual. Inaction he disliked both for himself and in others. Though not an athlete, he took an interest in manly pastimes: he was fond of riding and of breeding horses; he liked being on the racecourse; and he enjoyed games, both of skill and of chance. A student of books he was not; he could lay no claim to wide learning or elegant scholarship; but he could appreciate a good book; he was versed in Shakespeare; and he knew and loved the poetry and the songs of his native land. When he wrote, his style, inornate, clear and forcible, reflected the character of his thought. He was a staunch and sympathetic friend, ever ready, in an unostentatious way, to help, where help was really needed. While he undoubtedly exhibited at times, chiefly during the earlier part of his career, a certain brusqueness and impetuosity of speech and demeanour, those who came into contact with him recognized that such occasional outbursts never sprang from any desire to hurt, or from any unkindness of disposition. In his contests at the bar he never made an enemy. He was a strong man, and he liked to have his way; but he was also large-hearted and without a tinge of rancour in his disposition. He was never offended by opposition. Whilst he did not himself shine as a wit or a humorist in conversation or in after-dinner oratory, he heartily enjoyed fun and humour in others; and, wherever he was, the

force and distinctness of his personality never failed to impress his company. Probably no English lawyer ever excited abroad the admiration which was accorded to Lord Russell of Killowen, alike on the continent of Europe and in America. To the United States he paid two visits, the first in 1883 and the second in 1896. On both occasions he won golden opinions, which were manifested in widespread and warm expressions of sympathy and regret when the news of the death of Lord Russell of Killowen passed across the Atlantic. Between 1894 and 1897 Lord Russell of Killowen received the degree of Doctor of Laws *honoris causa* from the universities of Dublin, Edinburgh and Cambridge, and from the Laval university, Quebec. In 1892 he was treasurer of Lincoln's Inn. He left surviving him, besides his widow, five sons and four daughters. His sister Katherine (in religion, Sister Mary Baptist Joseph), pioneer sister of mercy in California, had died two years before at San Francisco. (W. R. K.)

RUSSELL OF THORNHAUGH, WILLIAM, 1ST BARON (c. 1558-1613), English soldier, was a younger son of Francis Russell, 2nd earl of Bedford, and was educated at Magdalen College, Oxford. After spending a few years abroad, he went to Ireland in 1580, and having seen some service in that country he was knighted in September 1581. In 1585 he joined the English forces in the Netherlands, being made lieutenant-general of cavalry; in September 1586 he so distinguished himself at Zutphen that the Spaniards pronounced him "a devil and not a man"; and in 1587 he became governor of Flushing in succession to his late friend, Sir Philip Sidney. He dined with the estates of Holland and with his superior, Lord Willoughby de Eresby; consequently, on his own initiative, he was recalled to England in July 1588. In May 1594 Russell was made lord deputy of Ireland in place of Sir William Fitzwilliam. He relieved Enniskillen, but his attempts to capture the insurgent leaders, Hugh O'Neill, earl of Tyrone, and Fiagh MacHugh O'Byrne, came to nothing. In May 1595 Sir John Norris landed in Ireland, his orders being to help the lord deputy in his difficult task. Russell was somewhat chagrined at the choice, as he and Norris were not very good friends, but for a short time they acted together against the rebels in the N. of Ireland. Russell then led an expedition into Connaught, but soon he and Norris were at variance. Having captured O'Byrne in May 1597, Russell laid down his office and left Ireland later in the month. In 1603 he was created Baron Russell of Thornhaugh, and he died on the 9th of August 1613. In 1627 his only son Francis succeeded his cousin Edward as 4th earl of Bedford.

Russell's *Journal* of his doings in Ireland is in the Carew MSS., and many of his letters are in the British Museum. See J. H. Wiffen, *Historical Memoirs of the House of Russell* (1833), and R. Bagwell, *Ireland under the Tudors*, vol. iii. (1890).

RUSSIA (*Rossiya*), the general name for the European and Asiatic dominions of the "Tsar of All the Russias." Although the name is thus correctly applied, both in English and Russian, to the whole area of the Russian empire, its application is often limited, no less correctly, to European Russia, or even to European Russia exclusive of Finland and Poland. The use of the name in its most comprehensive sense dates only from the expansion of the empire in the 10th century; to the historian who writes of the earlier growth of the empire, Russia means, at most, Russia in Europe, or Muscovy, as it was usually called until the 18th century, from Moscow, its ancient capital. The origin of the term "Russia" has been much disputed. It is certainly derived, through *Rossiya*, from Slavonic *Rus* or *Ros* (Byzantine *Ῥῶς* or *Ῥώσος*), a name first given to the Scandinavians who founded a principality on the Dnieper in the 9th century; and afterwards extended to the collection of Russian states of which this principality formed the nucleus. The word *Rus*, in former times wrongly connected with the tribal name Rhoxolani, is more probably derived from *Ruotsi*, a Finnish name for the Swedes, which seems to be a corruption of the Swedish *rothsmenn*, "rowers" or "seafarers."

I. THE RUSSIAN EMPIRE

The Russian empire stretches over a vast territory in E. Europe and N. Asia, with an area exceeding 8,660,000 sq. m., or one-sixth of the land surface of the globe (one twenty-third of its whole superficies). It is, however, but thinly peopled on the average, including only one-twelfth of the inhabitants of the earth. It is almost entirely confined to the cold and temperate zones. In Novaya Zemlya and the Taimyr peninsula, it projects within the Arctic Circle as far as $77^{\circ} 6'$ and $79^{\circ} 40'$ N. respectively; while its S. extremities reach $38^{\circ} 50'$ in Armenia, 35° on the Afghan frontier, and $42^{\circ} 30'$ on the coasts of the Pacific. To the W. it advances as far as $20^{\circ} 40'$ E. in Lapland, 17° in Poland, and $29^{\circ} 42'$ on the Black Sea; and its E. limit—East Cape on the Bering Strait—is in 101° E.

The White, Barents and Kara Seas of the Arctic bound it on the N., and the northern Pacific—that is, the Sea of Bering, Okhotsk and Japan—bounds it on the E.

Boundaries. The Baltic, with the Gulfs of Bothnia and Finland, limits it on the N.W.; and two sinuous lines of land frontier separate it respectively from Sweden and Norway on the N.W. and from Prussia, Austria and Rumania on the W. On the S. and E. the frontier has changed frequently according to the expansion and contraction of the empire under the pressure of political exigency and expedience. The Black Sea is the principal demarcating feature on the S. of European Russia. On the W. side of that sea the S. frontier touches the Danube for some 120 m.; on the E. side of the same sea it zigzags from the Black Sea to the Caspian, utilizing the river Aras (Araxes) for part of the distance. As the Caspian is virtually a Russian sea, Persia may be said to form the next link in the S. boundary of the Russian empire, followed by Afghanistan. On the Pamirs Russia has since 1885 been continuous with British India (Kashmir); but the boundary then swings away N. round Chinese Turkestan and the N. side of Mongolia, and, since 1904-5, it has skirted the N. of Manchuria, being separated from it by the river Amur. As thus traced, the boundary in Central Asia includes the two khanates of Bokhara and Khiva, which, though nominally protected states, are to all intents and purposes integral parts of the Russian empire. But it excludes Manchuria, with the Liao-tung peninsula and Port Arthur, upon which Russia only placed her grasp in 1898-99, a grasp which she was compelled by Japan to release after the war of 1904-5. The total length of the frontier line of the Russian empire by land is 2800 m. in Europe, and nearly 10,000 m. in Asia, and by sea over 11,000 m. in Europe and between 19,000 and 20,000 m. in Asia.

Russia has no oceanic possessions; her islands are all appendages of the mainland to which they belong. Such are Karlo, East Kvarken, the Åland archipelago, **Islands.**

Dagö, and Ösel or Oesel in the Baltic Sea; Novaya Zemlya, with Kolguev and Vaigach, in the Barents Sea; the Solovetski Islands in the White Sea; the New Siberian archipelago, Wrangel Land and Bear Islands, off the Siberian coast; the Commander Islands off Kamchatka; the Shantar Islands and the N. of Sakhalin in the Sea of Okhotsk. The Aleutian archipelago was sold to the United States in 1867, together with Alaska, and in 1875 the Kurile Islands were ceded to Japan.

If the border regions, that is, two narrow belts, on the N. and S., be left out of account, a striking uniformity of physical feature prevails throughout the whole vast extent of the Russian empire. High plateaus like that of Pamir (the "Roof of the World") and Armenia, and lofty mountain chains like the snow-cad Caucasus, the Alai, the Tian-shan, the Sayan Mountains, exist only on the outskirts of the empire.

Viewed broadly, the Russian empire may be said to occupy the territories to the N.W. of the great plateau formation of the old continent—the backbone of Asia—which stretches with decreasing altitude and width from the high tableland of Tibet and Pamir to the lower plateaus of Mongolia, and thence N.E. through the Vitim

region to the farthest extremity of Asia. Thus it consists of the immense plains and flat lands which extend between the plateau formation and the Arctic Ocean, including the series of parallel chains and hilly spurs which skirt the former region on the N.W. And it is only to the E. of Lake Baikal that it climbs up on to the plateau, from which it descends again before it reaches the Pacific.

This plateau formation—the oldest geological continent of Asia—being unfit for agriculture and for the most part unsuited for permanent settlement, while its oceanic slopes have from the dawn of history been occupied by a relatively dense population, long pre-empted by Slav colonization from reaching the Pacific. The Russians managed to cross it in the 17th century at its narrowest and most N. part, and thus struck the Pacific on the foggy and froz'n shores of the Sea of Okhotsk; but two centuries elapsed ere, after coloring the depressions around Lake Baikal, they crossed over the plateau in a more genial zone and descended to the Pacific by the Amur. After that they spread rapidly S., up to the nearly uninhabited valley of the Usuri, to what is now the Gulf of Peter the Great. In the S.W. higher portions of the plateau formation the empire has only comparatively recently planted its foot on the Pacific, and it was only a few years earlier that it established itself firmly on the highlands of Armenia.

A broad belt of hilly tracts—in every respect alpine in character, and displaying the same variety of climate and organic life as alpine tracts usually do—skirts the plateau formation throughout its entire length on the N. and N.W., forming an intermediate region between the plateau and the plains. The **The alpine belt.** Caucasus, the Elburz, the Kopet-dagh and Paropamisus, the intricate and imperfectly known network of mountains W. of the Pamir, the Tian-shan and the Alai, the mountain ranges, and farther N.E. the Altai, the still unnamed complex of the Minusinsk Mountains, the intricate mountain-chains of Sayan, with those of the Olekma, Vitim and Aldan all arranged en échelon—the former from N.W. to S.E., and the others from S.W. to N.E.—all these belong to the same alpine belt that borders the plateau from end to end of the series.

The flat lands which extend from the base of the Alpine foothills to the shores of the Arctic Ocean, assume the character either of dry deserts, as in the Ural-Caspian depression, or of low **The flat lands.** tablelands in central Russia, and E. Siberia, or of marshy lacustrine regions in N.W. Russia and Finland, or of marshy prairies in W. Siberia, and of tundras in the far N. Throughout the whole of this vast area, their monotonous surfaces are diversified by only a few, and, for the most part, low, hilly tracts. Recently emerged from the Post-Pliocene sea, or freed from their mantle of ice, they persistently maintain the self-same features over immense areas; and the few portions that rise above the general elevation have more the character of broad and gentle swellings than of mountain-chains. Of this class are the swampy plateaus of the Kola peninsula, sloping gently S. to the lacustrine region of Finland and N.W. Russia; the Valdai tablelands, where all the great rivers of Russia take their rise; the broad and gently sloping meridional belt of the Ural Mountains; and lastly the Taimyr, Tunguzka and Verkhoyansk ranges in Siberia, which, notwithstanding their sub-Arctic position, do not reach the snow-line. The picturesque Bureya Mountains above the Amur, the forest-clad Sikhota-alin on the Pacific, and the volcanic chains of Kamchatka belong, however, to quite another orographical construction, being the border-ridges of the terraces by which the great plateau formation descends to the depths of the Pacific Ocean.

It is owing to these leading orographical features—divined by Carl Ritter, but only recently ascertained and established as fact by geographical research—that so many of the great **Rivers.** rivers of the old continent are comprised within the limits of the Russian empire. Taking their rise on the plateau formation, or in its outskirts, they flow first along lofty longitudinal valleys formerly filled with great lakes, next they curve their way through the rocky barriers, and finally they enter the lowlands, where they become navigable, and describing wide curves to avoid here and there the minor plateaus and hilly tracts, they bring into water-communication with one another places thousands of miles apart. The double river-systems of the Volga and Kama, the Ob and Irtysh, the Angara and Yenisei, the Lena and Vitim on the Arctic slope, and the Amur and Sungari on the Pacific slope, are instances. These were the obvious channels of Russian colonization.

A broad depression—the Aral-Caspian desert—has arisen where the plateau formation reaches its greatest altitude, and at the same time suddenly changes its direction from N.W. to N.E. This desert is now filled to only a small extent by the salt waters of the Caspian, Aral and Balkash inland seas; but it bears unmistakable traces of having been during Post-Pliocene times an immense inland basin. There the Volga, the Ural, the Syr-darya and the Amu-darya discharge their waters without reaching the ocean, but they bring life to the rapidly desiccating Transcasian steppes, and link together the most remote parts of Russia.

Geology.—The most striking feature in the geology of Russia is its

remarkable freedom from disturbances, either in the form of mountain folding or of igneous intrusions. Over the greater part of the

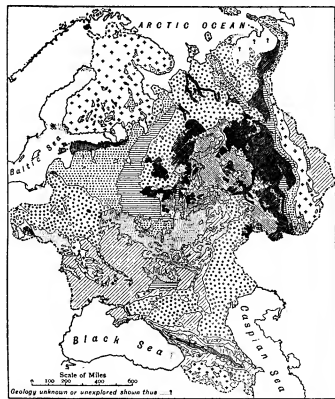

country the strata are still nearly as flat as when they were first laid down, and the deposits, even of the Cambrian period, are as soft as those of the Mesozoic and Tertiary formations in England. Only in the Urals, the Caucasus, the Timan Mountains, the region of the Donets coalfield, and the Kielce Hills is there any sign of the great folding from which nearly the whole of the rest of Europe has suffered at one time or another.

In the early part of the Palaeozoic era only the gneissic region of Finland and Olonets and probably the Archean mass of S. Russia remained constantly above the sea; but there were several oscillations. Gradually, however, the sea retreated from W. Russia and in the Upper Carboniferous and Permian periods it was confined to the E.

At the beginning of the Mesozoic era the whole country became land, bearing upon its surface the salt lakes in which the Trias was laid down. During the Jurassic period the sea again invaded the region, both from the N. and from the S., but still the W. of Russia rose above the waves. In the Cretaceous period the waters withdrew from the N.E., but in the S. they spread W., covering the whole of Poland and finally uniting with the ocean in which the chalk of W. Europe was deposited. The Tertiary era was marked by a gradual extension S. of the N. land-mass. In the later stages arms of the sea were cut off and were converted at first into lagoons and then into brackish or fresh-water lakes which continued to occupy much of S. Russia until the beginning of the Quaternary period.

During the first part of the Glacial period Russia extended to have been covered by an immense ice-sheet, which extended also over central Germany, and of which the E. limits cannot yet be determined. The Archean rocks have a broad extension in Finland, N. Russia, the Ural Mountains and the Caucasus. In S. Russia they form the floor upon which lies a thin covering of Tertiary beds, and they are exposed to view in the valleys of the Dnieper and the Bug. They consist for the most part of red and grey gneisses and granulates, with subordinate layers of granite and granite. The Finland *rappo-kivi*, the Serdobol gneiss, and the Fargas and Rustiala marble (with the so-called *Eosoon canadense*) yield good building stone; while iron, copper and zinc-ore are common in Finland and in the Urals. Rocks regarded as representing the Huronian system appear also in Finland, in N.W. Russia, as a narrow strip on the Urals, and in the Dnieper ridge. They consist of a series of unfossiliferous crystalline slates.

The Cambrian is represented by blue clays, unglutite sandstones and bituminous slates in Esthonia and St Petersburg. The Ordovician and Silurian systems are widely developed, and it is most probable that, with the exception of the Archean continents of Finland and the S., the sea covered the whole of Russia. Being concealed, however, by more recent deposits, the deposits appear on the surface only in N.W. Russia (Esthonia, Livonia, St Petersburg and on the Volkhov), where all the subdivisions of the system have been found; in the Timan ridge; on the W. slope of the Urals; in the Pechora ridge; and in the Volga to the Arctic Ocean. In Poland the rocks of these periods are met with in the Kielce Mountains, and in Podolia in the deeper ravines.

The Devonian dolomites, limestones and red sandstones cover immense tracts and appear on the surface over a much wider area. From Esthonia these rocks extend N.E. to Lake Onega, and S.E. to Mogilev; they form the central plateau, as also the slopes of the Urals and the Petchora region. In N.W. and middle Russia they contain a special fauna, and it appears that the Lower Devonian series of W. Europe, represented in Poland and in the Urals, is missing in N.W. and central Russia, where only the Middle and Upper Devonian divisions are found.

Carboniferous deposits occur over nearly the whole of E. Russia, their W. boundary being a line drawn from Archangel to the upper Dnieper, thence to the upper Don, and S. to the mouth of the last-named river, with a long narrow gulf extending W. to encircle the plateau of the Donets. They are visible, however, only on the W. borders of this region, being covered towards the E. by thick Permian and Triassic strata. Russia has three large coal-bearing regions—the Moscow basin, the Donets region and the Urals. In the Valdai plateau there are only a few beds of mediocre coal. In the Moscow basin, which was a broad gulf of the Carboniferous sea, coal appears as isolated inconstant seams amidst littoral deposits, the formation of which was favoured by frequent minor subsidences of the seacoast. The coal is here confined to the lower division of the system; the Upper Carboniferous (corresponding with the English Coal-Measures) is exclusively marine, consisting chiefly of *Fusulina* limestone. The Donets Coal-Measures, containing abundant remains of a rich land-fauna, cover nearly 16,000 sq. m., and comprise a valuable stock of excellent anthracite and coal, together with iron-mines. In this basin, as in W. Europe generally, the principal coal seams occur in the Upper Carboniferous, while the Lower Carboniferous is mainly composed of marine deposits, with, however, the first bed of coal near its summit. Several smaller coalfields on the slopes of the Urals and on the Timan ridge may be added to the above. The Polish coalfields belong to another Carboniferous area of deposit, which extended over Silesia.

The Permian limestones and marls occupy a strip in E. Russia of much less extent than that assigned to them by Murchison. The varied marls of E. Russia, rich in salt-springs, but very poor in fossils, are now held by most Russian geologists to be Triassic. The Permian deposits contain marine shells and also remains of plants similar to those of England and Germany. But in the government of Volodga, on the rivers Sukhona and N. Dvina, *Glossopteris*, *Noeggerathopsis* and other ferns characteristic of the Indian Gondwana beds have been found; and with these are numerous remains of reptiles similar to those which occur in the Indian deposits. In the Urals the marine facies is more fully developed and the fauna shows affinities with that of the *Productus* limestone of the Central Asian mountain belt.

During the Jurassic period the sea began again to invade Russia from S.E. and W. The limits of the Russian Jurassic system may be represented by a line drawn from the double valley of the Sukhona and Vytchegda to that of the upper Volga, and thence to Kieff, with a wide gulf penetrating towards the N.W. Within this space three depressions, all running S.W. to N.E., are filled up with Upper Jurassic deposits. They are much denuded in the higher parts of this region, and appear but as isolated islands in central Russia. In the S.E. all the older subdivisions are represented, the deposits having the characters of a deep-sea formation in the Aral-Caspian region and on the Caucasus.

Cretaceous beds—sands, loose sandstones, marls and white chalk—occupy nearly the whole of the region S. of a line drawn from the Niemen to the upper Oka and Don, and thence N.E. to Simbirsk. Over a large part of this area, however, they are concealed by the later Tertiary deposits, and they are absent over the Dnieper and Don ridge in the Yaila Mountains and in the higher parts of the Caucasus. They are rich in grinding stone, and in phosphatic deposits.

The Tertiary formations occupy large areas in S. Russia. The Eocene covers wide tracts from Lithuania to Tsaritsyn, and is represented in the Crimea and Caucasus by thick deposits belonging to the same ocean which left its deposits on the Alps and the Himalayas. Oligocene, quite similar to that of N. Germany, and containing brown lignite, has been met with in the basins of Poland, Courland and Lithuania. The Miocene (Sarmatian stage) occupies extensive tracts in S. Russia. S. of a line drawn through Lublin to Ekaterinoslav and Saratov. Not only the higher chains of Caucasus and Yaila, but also the Donets ridge, rose above the

level of the Miocene sea, which was very shallow to the N. of this last ridge, while farther S. it was connected both with the Vienna basin and with the Aral-Caspian. The Pliocene appears only in the coast region of the Black and Azov Seas, but it is widely developed in the Aral-Caspian region, where, however, the Ust-Urt and the Obshchiy Syr rise above the sea.

The thick Quaternary, or Post-Pliocene, deposits which cover nearly all Russia were for a long time a puzzle to geologists. They consist of a boulder clay in the N. and of loess in the S. The former presents an intimate mixture of boulders brought from Finland and Olonets (with an addition of local boulders) with small gravel, coarse sand and the finest glacial mud,—the whole bearing no trace of ever having been washed up and sorted by water in motion, except in subordinate layers of glacial sand and gravel; that of the boulders resembles on the whole that of the Ust-Urt, and the boulder clay, especially in N. and central Russia, often takes the shape of ridges parallel to the direction of the motion of the boulders. Its S. limits, roughly corresponding with those established by Murchison, but not yet settled in the S.E. and E., are, according to M. Nikitin, the following:—from the S. frontier of Poland to Ovrutch, Uman, Kremenchug, Pottava and Razdornaya (50° N. latitude), with a curve N. to Kozelsk (?); thence due N. to Vetluga (58° N. latitude), E. to Glazova in Vyatka, and from this place towards the N. and W. along the watershed of the Volga and Pechora (?). S. of the 50th parallel appears the loess, with all its usual characters (land fossils, want of stratification, &c.), showing a remarkable uniformity of composition over very large surfaces; it covers both watersheds and valleys, but chiefly the former. Such being the characters of the Quaternary deposits in Russia, the majority of Russian geologists now adopt the opinion that Russia was covered, as far as the above limits, with an immense ice-sheet which crept over central Russia and central Germany from Scandinavia and N. Russia. Another ice-covering was probably advancing at the same time from the N.E., that is, from the N. of the Urals, but the question as to the glaciation of the Urals still remains open. As to the loess, the usual view is that it was a steppe-deposit due to the drifting of fine sand and dust during a dry episode in the Pleistocene period.

The deposits of the Post-Glacial period are represented throughout Russia, Poland and Finland, as also throughout Siberia and Central Asia, by very thick lacustrine deposits, which show that, after the melting of the ice-sheet the country was covered with immense lakes, connected by broad channels (the *fjården* of the Swedes), which later on gave rise to the actual rivers. On the outskirts of the lacustrine region, traces of marine deposits, not higher than 200 or perhaps even 150 ft. above present sea-level, are found alike on the Arctic Sea and on the Baltic and Black Sea coasts. A deep gulf of the Arctic Sea advanced up the valley of the Dvina; and the Caspian, connected by the Manych with the Black Sea, and by the Uraloy valley with Lake Aral, penetrates to the N. up the Volga valley, as far as its Samara bend. Unmistakable traces show that, while during the Glacial period Russia had an arctic flora and fauna, the climate of the Lacustrine period was more genial than it is now, and a dense human population at that time peopled the shores of the numberless lakes.

The Lacustrine period has not yet reached its close in Russia. Finland and the N.W. hilly plateaus are still in the same geological phase, and are dotted with numberless lakes and ponds, while the rivers continue to dig out their yet undetermined channels. But the great lakes which covered the country during the Lacustrine period have disappeared, leaving behind them immense marshes like those of the Pripet and in the N.E. The disappearance of what still remains of them is accelerated not only by the general decrease of moisture, but also perhaps by the gradual upheaval of N. Russia, which is going on from Esthonia and Finland to the Kola peninsula and Novaya Zemlya, at an average rate of about two feet per century. This upheaval—the consequences of which have been felt even within the historic period, by *eroghi* (deep ravines), the summits of which rapidly advance, and rapidly in the loose surface deposits. As for the S. steppes, their desiccation, the consequence of the above causes, is in rapid progress.¹

¹ Bibliography: *Memoirs, Inventia* and Geological Maps of the Committee for the Geological Survey of Russia; *Memoirs* and *Shorniks* of the Mineralogical Society, of the Academy of Science and of the Societies of Naturalists at the Universities; *Mining Journal*; Murchison's *Geology of Russia*; Helmersen's and Möller's *Geological Maps of Russia* and the *Ural*; Inostrantsev in Appendix to Russian translation of Reclus's *Geogr. Univ.*, and *Manual of Geology* (Russian).

Population.—The population of the empire, which was estimated at 74,000,000 in 1859, was found to be over 129,200,000 at the census of 1897, taken over all the empire except Finland. In 1904 it was estimated to be 143,000,000, and in 1906, according to a detailed estimate of the Central Statistical Committee, it was 149,209,300. Thus from 1860 to 1897 the population increased 74½%, and from 1897 to 1904 26·3, an average annual increase of about 3½% as compared with an average annual increase of 2½% during the period 1860-97. The increase took place chiefly in the large cities, in Siberia, Poland, Lithuania, S. Russia and Caucasia. The official divisions of the empire are given here, and details are given in separate articles.

PROVINCE OR GOVERNMENT

European Russia—		
Archangel	Livonia	Saratov
Astrakhan	Minsk	Simbirsk
Bessarabia	Mogilev	Smolensk
Chernigov	Moscow	Tambov
Courland	Nizhnyi-Novgorod	Taurida
Don Cossacks' territory	Novgorod	Tula
Ekaterinoslav	Olonets	Tver
Esthonia	Orel	Ufa
Grodno	Orenburg	Vilna
Kaluga	Penza	Vitebsk
Kazan	Perm	Vladimir
Kiev	Podolia	Volhynia
Kostroma	Poltava	Vologda
Kovno	Pskov	Voronezh
Kursk	Ryazan	Vyatka
Kharkov	St Petersburg	Yaroslavl
Kherson	Samara	
Poland—		
Kalisz	Piotrkow	Siedlce
Kielce	Plock	Suwalki
Lomza	Radom	Warsaw
Lublin		
Grand-Duchy of Finland—		
Abo Björneborg	St Michel	Viborg
Kuopio	Tavastehus	Vasa
Nyland	Uleåborg	
Caucasia—		
Kuban	Stavropol	Terek
Baku	Elizavetpol	Kutais
Black Sea territory	Erivan	Tiflis with Zaka-
Daghestan	Kars	taly
Russia in Asia—		
	{ Akmolinsk	
	{ Semipalatinsk	
The Steppes	{ Turgai	
	{ Uralsk	
	{ Semireychensk	
	{ Samarkand	
Turkestan—		
	{ Ferghana	
	{ Syr-darya	
Transcaspia		
Western Siberia—		
	{ Tobolsk	
	{ Tomsk	
Eastern Siberia—		
	{ Irkutsk	Yakutsk
	{ Transbaikalia	Yeniseisk
Amur Region—		
	{ Amur	
	{ Maritime Province	
	{ Sakhalin	

It has been found, from a comparison of the densities of population of the various provinces in 1859 with the distribution in 1897, that the centre of density has distinctly moved S., towards the shores of the Black Sea, and W., the greatest increase having taken place in the E. Polish and in the Lithuanian provinces, along the S.W. border, in the prairie belt beside the Black Sea, and in Orenburg, N. Caucasia and S.W. Siberia likewise show a considerable increase. The census of 1897 revealed in several provinces a remarkably low proportion of men to women. This was owing to the fact that large numbers of the men engaged in agriculture pursuits during the summer temporarily move every year into the large industrial centres for the winter. Consequently there were only 87·4 and 89·8 women to every 100 men in the governments of St Petersburg and Taurida respectively, but as many as 133·8 in Yaroslavl, 119 in Tver and 117 in Kostroma. The average number of women to every 100 men in the Russian governments proper was 102·9; in Poland, 98·6; in Finland, 102·2; in Caucasia, 88·9; in Siberia, 93·7; and in Turkestan and Transcaspia, 83·0.



RUSSIA IN EUROPE
 Scale, 1:11,500,000
 English Miles
 0 50 100 200 300

Capitals of Governments & Provinces
 Boundaries of Governments & Provinces
 Fortifications * Railways Sand
 Canals Glaciers Swamps Tundra

Environments of ST. PETERSBURG
 Scale, 1:1,000,000
 English Miles
 0 20 40 60 80 100

The effects of emigration and immigration cannot be estimated with accuracy, because only those who cross the frontier with passports are taken account of. The statistics of these show that there was during the thirty-two years, 1856-88, an excess of emigration over immigration of 1,146,052 in the case of Russians, and a surplus of immigration of 2,304,717 foreigners. On the other hand, in the six years, 1892-97, the excess of Russian emigration over immigration was 207,353, as compared with an excess of foreign immigration over emigration of only 136,740. During the years 1900-4 inclusive the total emigrants from Russia numbered 2,358,539, of whom 1,144,246 were Russians; while the immigrants numbered 2,333,053, of whom 1,432,057 were foreigners. It is also known that the number of Russian immigrants into the United States in 1891-1902 was 742,869, as compared with 313,469 in 1873-90, or a grand total since 1873 of 1,056,338. By far the greater part of these were Jews. The emigration to Siberia varies much from year to year. It was 26,129 in 1888, and 60,000 in 1898. During the two following years it amounted to an average of over 160,000, but in the years 1901-3 to an average of 84,638 per annum. Altogether some 800,000 peasants are estimated to have settled in Siberia during the period 1886-96, but during the years 1893-1905 no less than four millions in all. There is also some emigration from central Russia to the S. Urals, as well as to some of the steppe governments.

Within the empire a very great diversity of nationalities is comprised, due to the amalgamation or absorption by the Slav race of a variety of Ural-Altaic stocks, of Turko-Tatars, Turko-Mongols and various Caucasian races. In some cases their ethnical relations have not yet been completely determined. According to the results obtained by the census committee of 1897, working on a linguistic basis, the distribution of races was given in the table opposite:—

Taken as a whole, only 13% of the population of Russia lived in towns in 1897, but in the years 1857-60 less than 10% was urban. In Russia proper less than 2% emigrated from the villages to the towns during the forty years ending 1897. The following table shows the urban population in the various divisions of the empire in 1897:—

	Urban Population.	Percentage of Total.
European Russia	12,027,038	12.8
Poland	2,055,892	21.7
Finland	281,126	11.0
Caucasia	1,010,615	10.9
Siberia	473,706	9.3
Central Asia	936,655	12.0
Russian Empire	16,785,212	13.0

There were in European Russia and Poland only twelve cities with more than 100,000 inhabitants in 1884; in 1900 there were sixteen, namely, St Petersburg, Moscow, Warsaw, Odessa, Lódz, Riga, Kiev, Kharkov, Vilna, Saratov, Kazán, Ekaterinoslav, Rostov-on-the-Don, Astrakhan, Tula and Kishinev. In other parts of the empire there were four cities each having over 100,000 inhabitants in that year, namely, Baku, Tiflis, Tashkent and Helsingfors. While only three in S. Russia. There are thirty-four cities in European Russia and Poland, and forty in the entire empire, with from 50,000 to 100,000 inhabitants each. The rural population live for the most part in villages, not as a rule scattered about the country. In the inclement regions of the N. and in the N. parts of the forest zone the villages are very small. They are larger, but still small, in White Russia, Lithuania and the region of the lakes; but in the steppe governments they are very appreciably bigger, some of the Cossack *stanitsas* or settlements exceeding 20,000, and many of them numbering more than 10,000 inhabitants each. The houses are generally built of wood and wear a poverty-stricken aspect. Owing to the great risks from fire the villages usually cover a large area of ground, and the houses are scattered and straggling. The mortality in most towns is so great that during the last ten years of the 19th century, in a very great number of cities, the deaths exceeded the births by 1 to 4. (P. A. K.; J. T. B.)

Government and Administration.—Russia was described in the *Almanach de Gotha* for 1910 as “a constitutional monarchy under an autocratic tsar.” This obvious contradiction in terms well illustrates the difficulty of defining in a single formula the system, essentially transitional and meanwhile *sui generis*, established in the Russian empire since October 1905. Before this date the fundamental laws of Russia described the power of the emperor as “autocratic and unlimited.” The imperial style is still “Emperor and Autocrat of All the Russias”; but in the fundamental laws as remodelled between the imperial manifesto of 17/30 October and the opening of the first Duma

¹ See A. Aitoff, *Peuples et langages de la Russie* (Paris, 1906), based on the report of the Russian Census Committee of 1897.

on the 27th of April 1906, while the name and principle of autocracy was jealously preserved, the word “unlimited” vanished. Not that the régime in Russia had become in any true sense constitutional, far less parliamentary; but the “unlimited autocracy” had given place to a “self-limited autocracy,” whether permanently so limited, or only at the discretion of the autocrat, remaining a subject of heated controversy between conflicting parties in the state.² Provisionally, then, the Russian governmental system may perhaps be best defined—as M. Chasles suggests³—as “a limited monarchy under an autocratic emperor.”

At the head of the government is the emperor,⁴ whose power is limited only by the provisions of the fundamental laws of the empire. Of these some are ancient and undisputed: the empire may not be partitioned, but descends entire in order of primogeniture, and by preference to the male heir; the emperor and his consort must belong to the Eastern Orthodox Church; the emperor can wear no crown that entails residence abroad. By the manifesto of the 17/30th of October 1905 the emperor voluntarily limited his legislative power by decreeing that no measure was to become law without the consent of the Imperial Duma, a freely elected national assembly. By the law of the 20th of February 1906 the Council of the Empire was associated with the Duma as a legislative Upper House; and from this time the legislative power has been exercised normally by the emperor only in concert with the two chambers.

The Council of the Empire, or Imperial Council (*Gosudarstvennyi Sovet*), as reconstituted for this purpose, consists of 167 members, of whom 98 are nominated by the emperor, while 98 are elective. The ministers, also nominated, are *ex officio* members. Of the elected members 3 are returned by the “black” clergy (the monks), 3 by the “white” clergy (seculars),⁵ 18 by the corporations of nobles, 6 by the academy of sciences and the universities, 6 by the chambers of commerce, 6 by the industrial councils, 34 by the governments having *zemstvos*, 16 by those having no *zemstvos*, and 6 by Poland. As a legislative body the powers of the Council are co-ordinate with those of the Duma; in practice, however, it has seldom if ever initiated legislation.⁶

The Duma of the Empire or Imperial Duma (*Gosudarstvennaya Duma*), which forms the Lower House of the Russian parliament, consists (since the *ukaz* of the 2nd of June 1907) of 442 members, elected by an exceedingly complicated process, so manipulated as to secure an overwhelming preponderance for the wealthy, and especially the landed classes, and also for the representatives of the Russian as opposed to the subject peoples. Each province of the empire, except the now disfranchised steppes of Central Asia,⁷ returns a certain proportion of members (fixed in each case by law in such a way as to give a preponderance to the Russian element), in addition to those returned by certain of

² M. Stolypin defended the *ukaz* of the 2nd of June 1907, which in flat contradiction of the provisions of the fundamental laws altered the electoral law without the consent of the legislature, on the ground that what the autocrat had granted the autocrat could take away. The members of the Opposition, on the other hand, quoting Art. 84 of the fundamental laws (“The empire is governed on the immutable basis of laws issued according to the established order”), argued that the emperor himself could only act within the limits of the order established by those laws. It is noteworthy that even the third Duma in its address to the throne, if it avoided the tabooed word “Constitution,” avoided also all mention of autocracy.

³ *Le Parlement russe*, p. 151.
⁴ *Emperor* is the official style. The Russian translation is *Gosudar*. Popularly, however, the emperor is known by his old Russian title of *tsar* (q.v.).

⁵ This is the first time since Peter the Great that the clergy have been given a voice in secular affairs in Russia.

⁶ The number of the council was formerly not fixed, and there are still honorary councillors who have no right to sit. Thus in 1910 the honorary president of the council was the grand-duke Michael Nicolaievich, the actual president M. G. Akimov. The judicial and administrative work of the old council was in 1900 assigned to *sepa-ata* committees.

⁷ These returned 23 members in the first and second Dumas.

The emperor.

The Council of the Empire.

The Duma.

Electoral system.

TABLE SHOWING DISTRIBUTION OF RACES

		Russia in Europe.	Poland.	Caucasia.	Siberia.	Central Asia.	Finland.	Totals. ¹		
ARYANS .	Slavs	Great Russians	48,558,721	267,160	1,820,793	4,423,803	587,992	5,939	55,673,408	
		Little Russians	20,414,866	335,337	1,305,463	223,274	101,611	22,380,551
		White Russians	5,823,331	29,347	10,642	12,346	829	5,885,547
		Poles	1,109,934	6,755,503	25,117	29,177	11,576	7,931,307
		Other Slavs ²	213,268	7,365	3,855	182	189	224,859
	Lithuanians	Lithuanians ³	1,345,160	305,322	5,121	1,877	1,042	1,658,532
		Letts	1,422,021	5,064	1,511	6,714	627	1,435,937
	Latin and Teutonic Races	Rumanians	1,121,660	5,223	7,232	1,134,124
		Germans	1,312,188	407,274	56,729	5,424	8,874	1,925	..	1,790,489
		Greeks	86,626	..	100,299	186,925
		Other Europeans ⁴	29,841	..	1,435	34,276
		Swedes	14,199	349,733	..	363,932
	Iranians	Armenians	76,635	..	1,096,461	..	4,862	1,173,096
		Persians	1,030	..	29,278	..	8,015	38,923
		Tajiks	350,397	350,397
Talyshes and Tates	130,347	130,347	
Kurds	99,836	99,836	
Ossetes	171,716	171,716	
Gypsies	16,004	1,056	3,041	6,253	771	27,125		
SEMITES	Jews	3,714,995	1,267,194	40,498	32,597	7,872	5,063,156	
Finns	Esthonians	989,883	4,372	4,281	4,202	1,002,738	
	Finns	143,068	2,352,990	..	2,496,058	
	Lapps	1,812	1,812	1,300	3,112	
	Mordvinians	989,959	20,802	13,080	1,023,841	
	Karelians	208,101	208,101	
	Cheremisses	375,439	375,439	
	Syryenians	146,535	7,083	153,618	
	Permiaks	103,339	103,339	
	Votyaks	420,970	420,970	
	Other Finns ⁵	43,393	24,453	67,846	
	Samoyedes	3,940	11,929	15,869	
URAL-ALTAIANS	Tatars	1,953,155	4,336	1,509,785	210,154	60,197	3,737,627	
	Chuvashes	87,872	929	411	4,332	311	843,755	
	Bashkirs	1,488,297	83	953	978	2,672	1,492,983	
	Turks (Osmanlis)	68,807	156	139,419	172	268	208,822	
	Turkomans	7,938	6	24,522	124	248,767	281,355	
	Kirghiz	264,059	123	98	32,648	3,988,893	4,084,139	
	Sarts	184	..	158	305	968,008	968,655	
	Uzbegs	43	77	726,414	726,534	
	Yakuts	227,384	227,384	
	Kara-kalpaks	1	2	104,271	104,274	
	Others	466	..	204,561	63	518,949	724,039	
	Tunguses	70,064	70,064	
	Mongols	Kalmucks	170,865	..	14,409	185,274
Buriats	288,663	288,663	
CAUCASIANS	Georgian Races ⁶	1,352,455	1,352,455	
	Circassians and other Cascaians ⁷	1,091,782	1,091,782	
KORYAKS, CHUKCHIS, &c.	39,349	39,349	
CHINESE, JAPANESE AND KOREANS	86,113	86,113	

¹ These totals include in some cases small linguistic groups not mentioned in the table.

² About 77% Bulgarians, the rest mostly Bohemians (Czechs).

³ Principally Frenchmen, with Englishmen, Italians, Norwegians, Danes, Dutchmen and Spaniards.

⁴ Ethnologically the Bulgarians ought perhaps to come here; but, as a large admixture of Slav blood flows in their veins and they speak a distinctly Slav language, they have in this table been grouped with the Slavs.

⁵ Includes Georgians, Mingrelians, Imeretians, Lazs and Svanetians.

⁷ For details, see table under the heading CAUCASIA. Of the total given here, 20% are Circassians.

the great cities. The members of the Duma are elected by electoral colleges in each government, and these in their turn are elected, like the *zemstvos* (see below), by electoral assemblies chosen by the three classes of landed proprietors, citizens and peasants. In these assemblies the large proprietors sit in person, being thus electors in the second degree; the lesser proprietors are represented by delegates, and therefore elect in the third degree. The urban population, divided into two categories according to their taxable wealth, elects delegates

direct to the college of the government (*Guberniya*), and is thus represented in the second degree; but the system of division into categories, according not to the number of taxpayers but to the amount they pay, gives a great preponderance to the richer classes. The peasants are represented only in the fourth degree, since the delegates to the electoral college are elected by the *votists* (see below). The workmen, finally, are specially treated. Every industrial concern employing fifty hands or over elects one or more delegates to the electoral

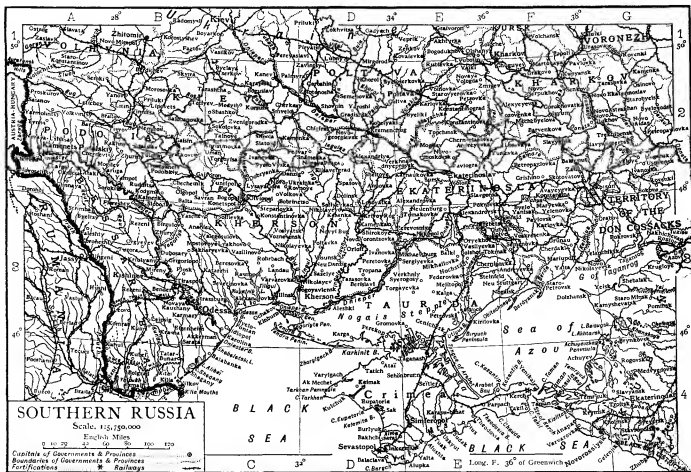

college of the government, in which, like the others, they form a separate *curia*.

In the college itself the voting—secret and by ballot throughout—is by majority; and since this majority consists, under the actual system, of very conservative elements (the landowners and urban delegates having $\frac{2}{3}$ ths of the votes), the progressive elements—however much they might preponderate in the country—would have no chance of representation at all save for the curious provision that one member at least in each government must be chosen from each of the five classes represented in the college. For example, were there no reactionary peasant among the delegates, a reactionary majority might be forced to return a Social Democrat to the Duma. As it is, though a fixed *minimum* of peasant delegates *must* be returned, they by no means probably represent the opinion of the peasantry. That in the Duma any Radical elements survive at all is mainly due to the peculiar franchise enjoyed by the seven largest towns—St Petersburg, Moscow, Kiev, Odessa, Riga and the Polish cities of Warsaw and Lodz. These elect their delegates to the Duma direct, and though their votes are divided into two *curias* (on the basis of taxable property) in such a way as to give the advantage to wealth, each returning the same number of delegates, the democratic colleges can at least return members of their own complexion.¹

The competence of the Russian parliament² thus constituted is strictly limited. It shares with the emperor the legislative **Powers of the Duma.** power, including the discussion and sanctioning of the budget. But, so far as the parliament is concerned, this power is subject to numerous and important exceptions. All measures, e.g. dealing with the organization of the army and navy are outside its competence; these are no longer called "laws" but "ordinary administrative rules." Moreover, the procedure of the Houses practically places the control of legislation in the hands of ministers. Any member may bring in a "project of law," but it has to be submitted to the minister of the department concerned, who is allowed a month to consider it, and himself prepares the final draft laid on the table of the House. Amendments, however, may be and have been carried against the government. Ministers are responsible, moreover, not to parliament but to the emperor. They may be interpellated, but only on the legality, not the policy, of their acts. In the words of M. Stolypin, there is no intention of converting the ministerial bench into a prisoners' dock. If by a two-thirds majority the action of a minister be arraigned, the president of the Imperial Council lays the case before the emperor, who decides. The powers of the parliament over the budget are even more limited, though not altogether illusory. No legislation by means of the budget is allowed, i.e. no alteration may be made in credits necessary for carrying out a law. This deprives parliament of control over the administrative departments, all the ministries being thus "armour-plated"—to use the cant phrase current in Russia—except that of ways and communications (railways). The sum of 700,000,000 roubles per annum is thus excepted from the control of the chambers. Other exceptions are the "Institutions of the Empress Marie," which absorb, *inter alia*, the duties on playing-cards and the taxes on places of public entertainment; the imperial civil list, so far as this does not exceed the sum fixed in 1906 (16,359,595 roubles!); the expenses of the two imperial chanceries, 70,000,000 roubles per annum, which constitute in effect a secret service fund. Altogether, half the annual expenditure of the country is outside the control of parliament. Nor is this all. If the budget be not sanctioned by the emperor, that of the previous year remains in force, and the government has power, *motu proprio*, to impose the extra taxes necessary to carry out new laws. In certain circumstances, too, the emperor reserves the right to raise fresh loans.

¹ Thus M. Guchkov, leader of the Octobrists, and M. Miliukov, leader of the cadets, were both returned by the second *curia* of St Petersburg to the third Duma.

² Strictly speaking, the title is inapplicable, there being no collective official name for the two chambers. The word parliament may, however, be used as a convenient term, failing a better.

Further, the emperor has the power to issue ordinances having the force of law, i.e. under extraordinary circumstances when the Duma is not sitting. These ordinances must, however, be of a temporary nature, must not infringe the fundamental laws or statutes passed by the two chambers, or change the electoral system, and must be laid upon the table of the Duma at the first opportunity. Since, however, the emperor has the power of proroguing or dissolving the Duma as often as he pleases, it is clear that these temporary ordinances might in effect be made permanent. Finally, the emperor has the right to proclaim anywhere and at any time a state of siege. In this way the fundamental laws were suspended not only in Poland but in St Petersburg and other parts of the empire during the greater part of the four years succeeding the grant of the constitution.

It should be noted, none the less, that the third Duma succeeded in establishing its position, and that in view of its useful activities even the extreme Right came to realize that there could be no return to the old undisguised absolutist régime (see *History*, below, *ad fin.*).

By the law of the 18th of October (November 1) 1905, to assist the emperor in the supreme administration a Council of Ministers (*Sovyet Ministrov*) was created, under a minister president, the first appearance of a prime minister in Russia. This council consists of all the ministers and of the heads of the principal administrations. The ministries are as follows: (1) of the Imperial Court, to which the administration of the apagnes, the chapter of the imperial orders, the imperial palaces and theatres, and the Academy of Fine Arts are subordinated; (2) Foreign Affairs; (3) War and Marine; (4) Finance; (5) Commerce and Industry (created in 1905); (6) Interior (including police, health, censorship and press, posts and telegraphs, foreign religions, statistics); (7) Agriculture; (8) Ways and Communications; (9) Justice; (10) Public Instruction. Dependent on the Council of Ministers are two other councils: the Holy Synod and the Senate.

Council of Ministers.

The Holy Synod (established in 1721) is the supreme organ of government of the Orthodox Church in Russia. It is presided over by a lay procurator, representing the emperor, and consists, for the rest, of the three metropolitans of Moscow, St Petersburg and Kiev, the archbishop of Georgia, and a number of bishops sitting in rotation.

Holy Synod.

The Senate (*Pravitelstvennyyehi Senat*, i.e. directing or governing senate), originally established by Peter the Great, consists of members nominated by the emperor. Its functions, which are exceedingly various, are carried out by the different departments into which it is divided. It is the supreme court of cassation (see *Judicial System*, below); an audit office, a high court of justice for all political offences; one of its departments fulfils the functions of a heralds' college. It also has supreme jurisdiction in all disputes arising out of the administration of the empire, notably differences between the representatives of the central power and the elected organs of local self-government. Lastly, it examines into registers and promulgates new laws. A function, in theory, gives it a power, akin to that of the Supreme Court of the United States, of rejecting measures not in accordance with the fundamental laws.

The Senate.

For purposes of provincial administration Russia is divided into 78 governments (*guberniya*), 18 provinces (*oblast*) and 1 district (*okrug*). Of these 11 governments, 17 provinces and 1 district (Sakhalin) belong to Asiatic Russia. Of the rest 8 governments are in Finland, 10 in Poland. European Russia thus embraces 59 governments and 1 province (that of the Don). The Don province is under the direct jurisdiction of the ministry of war; the rest have each a governor and deputy-governor, the latter presiding over the administrative council. In addition there are governors-general, generally placed over several governments and armed with more extensive powers,

Provincial administration.

usually including the command of the troops within the limits of their jurisdiction. In 1906 there were governors-general in Finland, Warsaw, Vilna, Kiev, Moscow and Riga. The larger cities (St Petersburg, Moscow, Odessa, Sevastopol, Kertch-Yenikala, Nikolayev, Rostov) have an administrative system of their own, independent of the governments; in these the chief of police acts as governor. As organs of the central government there are further, the *isppravniki*, chiefs of police in the districts into which the governments are divided. These are nominated by the governors,¹ and have under their orders in the principal localities commissaries (*stanovoi pristav*). *Isppravniki* and *stanovoi* alike are armed with large and ill-defined powers; and, since they are for the most part illiterate and wholly ignorant of the law, they have proved exasperating engines of oppression. Towards the end of the reign of Alexander II., the government, in order to preserve order in the country districts, also created a special class of mounted rural policemen (*uryadniki*, from *uriad*, order), who, armed with power to arrest all suspects on the spot, rapidly became the terror of the countryside.² Finally, in the towns every house is provided with a detective policeman in the person of the porter (*dnornik*), who is charged with the duty of reporting to the police the presence of any suspicious characters or anything else that may interest them.³

In addition to the above there is also a police organization, in direct subordination to the ministry of the interior, of which the principal function is the discovery, prevention and extirpation of political sedition. A secret police, armed with inquisitorial and arbitrary powers, has always existed in autocratic Russia. Its most famous development was the so-called "Third Section" (of the imperial chancery) instituted by the emperor Nicholas I. in 1826. This was entirely independent of the ordinary police, but was associated with the previously existing corps of gendarmes (*Korpus Zhandarmov*), whose chief was placed at its head. Its object had originally been to keep the emperor in close touch with all the branches of the administration and to bring to his notice any abuses and irregularities (see NICHOLAS I.), and for this purpose its chief was in constant personal intercourse with the sovereign. Actually, however, its activity, directed mainly to the discovery of political offences, degenerated into a hideous reign of terror. Its organization was spread all over Russia; its procedure was secret and summary (transportation by administrative order); and, its instruments being for the most part ignorant and largely corrupt, its victims were counted by thousands.

The "Third Section" was suppressed by Alexander II. in 1880, but only in name. In fact it was transformed into a separate department of the ministry of the interior, and, provided with an enormous secret service fund, soon dominated the whole ministry. The corps of gendarmes was also incorporated in this department, the under-secretary of the interior being placed at its head and at that of the police generally, with practically unlimited jurisdiction in all cases which, in the judgment of the minister of the interior, required to be dealt with by processes outside the ordinary law. In 1896 the powers of the minister were extended at the expense of those of the under-secretary, who remained only at the head of the corps of gendarmes; but by a law of the 24th of September 1904 this was again reversed, and the under-secretary was again placed at the head of all the police with the title of under-secretary for the administration of the police.

Local Elected Administrative Bodies.—Alongside the local organs of the central government in Russia there are three classes of local elected bodies charged with administrative functions: (1) the peasant assemblies in the *mir* and the *volost*,

¹ From Catherine II.'s time to that of Alexander II. they were elected by the nobles. This was changed in consequence of the emancipation of the serfs.

² They were soon nicknamed *Kuryadniki*, chicken-stealers (from *Kura*, hen). See Letoy-Belouze, *L'Empire des tsars*, ii. 134.

³ The *dnornik* is on duty for sixteen hours at a stretch, during which he is not allowed to sleep or even to shelter in the porch.

(2) the *zemstvos* in the 34 governments of Russia proper, (3) the municipal *dumas*. Of these the peasant assemblies are the most interesting and in some respects the most important, since the peasants (i.e. three-quarters of the population of Russia) form a class apart,⁴ largely excepted from the incidence of the ordinary law, and governed in accordance with their local customs. The *mir* itself, with its customs, is of immemorial antiquity (see VILLAGE COMMUNITIES); it was not, however, till the emancipation of the serfs in 1861 that the village community was withdrawn from the patrimonial jurisdiction of the landowning nobility and endowed with self-government. The assembly of the *mir* consists of all the peasant householders of the village.⁵ These elect a head-man (*starosta*) and a collector of taxes, who was responsible, at least until the *ukaz* of October 1906, which abolished communal responsibility for the payment of taxes, for the repartition among individuals of the taxes imposed on the commune. A number of *mir*s are united into a *volost*, or canton, which has an assembly consisting of elected delegates from the *mir*s. These elect an elder (*starshina*) and, hitherto, a court of justice (*volostnyye sud*). See *Judicial System*, below. The self-government of the *mir*s and *volost*s is, however, tempered by the authority of the police commissaries (*stanovoi*) and by the power of general oversight given to the nominated "district committees for the affairs of the peasants."

The system of local self-government is continued, so far as the 34 governments of old Russia are concerned,⁶ in the elective district and provincial assemblies (*zemstvos*). These bodies, one for each district and another for each province or government, were created by Alexander II. in 1864. They consist of a representative council (*zemskoye soboranye*) and of an executive board (*zemskaya uprava*) nominated by the former. The board consists of five classes of members: (1) large landed proprietors (nobles owning 500 acres and over), who sit in person; (2) delegates of the small landowners, including the clergy in their capacity of landed proprietors; (3) delegates of the wealthier townsmen; (4) delegates of the less wealthy urban classes; (5) delegates of the peasants, elected by the *volost*s.⁷ The rules governing elections to the *zemstvos* were taken as a model for the electoral law of 1906 and are sufficiently indicated by the account of this given below. The *zemstvos* were originally given large powers in relation to the incidence of taxation, and such questions as education, public health, roads and the like. These powers were, however, severely restricted by the emperor Alexander III. (law of 12/25 June 1890), the *zemstvos* being absolutely subordinated to the governors, whose consent was necessary to the validity of all their decisions, and who received drastic powers of discipline over the members.⁸ It was not till 1905 that the *zemstvos* regained, at least *de facto*, some of their independent initiative. The part played by the congress of *zemstvos* in the earlier stages of the Russian revolution is outlined below (see *History*: § 2. *Development of the Russian Constitution*).

⁴ Until the *ukaz* of October 18, 1906, the peasant class was stereotyped under the electoral law. No peasant, however rich, could qualify for a vote in any but the peasants' electoral colleges. The *ukaz* allowed peasants with the requisite qualifications to vote as landowners. At the same time the Senate interpreted the law so as to exclude all but heads of families actually engaged in farming from the vote for the Duma.

⁵ None but peasants—not even the noble-landowner—has a voice in the assembly of the *mir*.

⁶ Sixteen provinces have no *zemstvos*, i.e. the three Baltic provinces, the nine western governments annexed from Poland by Catherine II., and the Cossack provinces of the Don, Astrakhan, Orsk, and Stavropol.

⁷ By the law of the 18th (25th) of June 1890 the peasant members of the *zemstvos* were to be nominated by the governor of the government or province from a list elected by the *volost*s.

⁸ In spite of these restrictions and of an electoral system which tended to make these assemblies as strait-laced and reactionary as any government bureau, the *zemstvos* did good work, notably educational, in those provinces where the proprietors were inspired with a more liberal spirit. Many *zemstvos* also made extensive and valuable inquiries into the condition of agriculture, industry and the like.

Since 1870 the municipalities in European Russia have had institutions like those of the *zemstvos*. All owners of houses, and tax-paying merchants, artisans and workmen are enrolled on lists in a descending order according to their assessed wealth. The total valuation is then divided into three equal parts, representing three groups of electors very unequal in number, each of which elects an equal number of delegates to the municipal *duma*. The executive is in the hands of an elective mayor and an *uprava*, which consists of several members elected by the *duma*. Under Alexander III., however, by laws promulgated in 1892 and 1894, the municipal *umas* were subordinated to the governors in the same way as the *zemstvos*. In 1894 municipal institutions, with still more restricted powers, were granted to several towns in Siberia, and in 1895 to some in Caucasia.

In the Baltic provinces (Courland, Livonia and Esthonia) the landowning classes formerly enjoyed considerable powers of self-government and numerous privileges in matters affecting education, police and the administration of local justice. But by laws promulgated in 1888 and 1889 the rights of police and manorial justice were transferred from the landlords to officials of the central government. Since about the same time a process of rigorous Russification has been carried through in the same provinces, in all departments of administration, in the higher schools and in the university of Dorpat, the name of which was altered to Yuriev. In 1893 district committees for the management of the peasants' affairs, similar to those in the purely Russian governments, were introduced into this part of the empire.

Judicial System.—Not the least valuable of the gifts of the "tsar emancipator," Alexander II., to Russia was the judicial system established by the statute (*Sudebni Ustav*) of the 20th of November 1864. The system which this superseded was not indigenous to Russia, but had been set up by Peter the Great, who had taken as his model the inquisitorial procedure at that time in vogue on the continent of western Europe. Both civil and criminal procedure were secret. All the proceedings were conducted in writing, and the judges were not confronted with either the parties or the witnesses until they emerged to deliver judgment. This secrecy, combined with the fact that the judges were very ill paid, led to universal bribery and corruption. To check this courts were multiplied (there were five, six or more instances), which only multiplied the evil. Documents accumulated from court to court, till none but the clerks who had written them could tell their gist; costs were piled up; and all this, combined with the confusion caused by the chaotic mass of imperial ukazes, ordinances and ancient laws—often inconsistent or flatly contradictory—made the administration of justice, if possible, more dilatory and capricious than in the old, unreformed English court of chancery. Above all, there was no dividing line between the judiciary and the administrative functions. The judges were not so by profession; they were merely members of the official class (*chinovniks*), the prejudices and vices of which they shared.

Of this system—except so far as the confusion of the laws is concerned—the reform of 1864 made a clean sweep. The new system established—based partly on English, partly on French models—was built up on certain broad principles: the separation of the judicial and administrative functions, the independence of the judges and courts, the publicity of trials and oral procedure, the equality of all classes before the law. Moreover, a democratic element was introduced by the adoption of the jury system and—so far as one order of tribunal was concerned—the election of judges. The establishment of a judicial system on these principles constituted, as M. Leroy-Beaulieu justly observes, a fundamental change in the conception of the Russian state, which, by placing the administration of justice outside the sphere of the executive power, ceased to be a despotism. This fact made the new system especially obnoxious to the bureaucracy, and during the latter years of Alexander II. and the reign of

Alexander III. there was a piecemeal taking back of what had been given. It was reserved for the third Duma, after the revolution, to begin the reversal of this process.¹

The system established by the law of 1864 is remarkable in that it set up two wholly separate orders of tribunals, each having their own courts of appeal and coming in contact only in the senate, as the supreme court of cassation. The first of these, based on the English model, are the courts of the elected justices of the peace, with jurisdiction over petty causes, whether civil or criminal; the second, based on the French model, are the ordinary tribunals of nominated judges, sitting with or without a jury to hear important cases.

The justices of the peace, who must be landowners² or (in towns) persons of moderate property, are elected by the municipal *umas* in the towns, and by the *zemstvos* in the country districts, for a term of three years. They are of two classes: (1) acting justices (*uchastoknye mirovye sudi*); (2) honorary justices (*pochetnye mirovye sudi*). The acting justice sits normally alone to hear causes in his canton of the peace (*uchastok*), but, at the request of both parties to a suit, he may call in an honorary justice as assessor or substitute.³ In all civil cases involving less than 30 roubles, and in criminal cases punishable by no more than three days' arrest, his judgment is final. In other cases appeal can be made to the "assize of the peace" (*mirovye syezdi*), consisting of three or more justices of the peace meeting monthly (cf. the English quarter sessions), which acts both as a court of appeal and of cassation. From this again appeal can be made on points of law or disputed procedure to the senate, which may send the case back for retrial by an assize of the peace in another district.

The ordinary tribunals, in their organization, personnel and procedure, are modelled very closely on those of France (see FRANCE, *Law and Institutions*). From the town judge (*ispravnik*), who, in spite of the principle laid down in 1864, combines judicial and administrative functions, an appeal lies (as in the case of the justices of the peace) to an assembly of such judges; for these again there is an appeal to the district court (*okrugniya sud*), consisting of three judges;⁴ while over this to the court of appeal (*sudebniya palata*); while over this again is the senate, which, as the supreme court of cassation, can send a case for retrial for reason shown. The district court, sitting with a jury, can try criminal cases without appeal, but only by special leave in each case of the court of appeal. The senate, as supreme court of cassation, has two departments, one for civil and one for criminal cases. As a court of justice its main drawback is that it is wholly unable to cope with the vast mass of documents representing appeals from all parts of the empire.

Two important classes in Russia stood more or less outside the competence of the above systems: the clergy and the peasants. The ecclesiastical courts still retain a jurisdiction over the clergy which they have lost elsewhere in Europe; and in them the old secret written procedure survives. Their interest for the laity lies

¹ An *ukaz* of 1879 gave the governors the right to report secretly on the qualifications of candidates for the office of justice of the peace. In 1889 Alexander III. abolished the election of justices of the peace, except in certain large towns and some outlying parts of the empire, and greatly restricted the right of trial by jury. The confusion of the judicial and administrative functions was introduced again by the appointment of officials as judges. In 1909 the third Duma restored the election of justices of the peace.

² The justices, though noble-landowners, are almost exclusively of very moderate means, and, though elected by the land-owning class, they are—according to M. Leroy-Beaulieu—prejudiced in favour of the poor *mirnik* rather than of the wealthy landlord.

³ These honorary justices are mainly recruited from the ranks of the higher bureaucracy and the army.

⁴ This corresponds to the French *cour d'arrondissement*, but its jurisdiction is, territorially, much wider, often covering several districts or even a whole government.

mainly in the fact that marriage and divorce fall within their competence; and their reform has been postponed largely because the wealthy and corrupt society of the Russian capital preferred a system which makes divorce easily purchasable and avoids at the same time the scandal of publicity. The case of the peasants is more interesting, and deserves a somewhat more detailed notice.

The peasants, as already stated, form a class apart, untouched by the influence of Western civilization, the principles of which they are quite incapable of understanding or appreciating. This fact was recognized by the legislators of 1864, and beneath the statutory tribunals created in that year the special courts of the peasants were suffered to survive.¹ These were indeed but a few years older. Up to 1861, the date of the emancipation, the peasant serfs had been under the patrimonial jurisdiction of their lords. The edict of emancipation abolished this jurisdiction, and set up instead in each *volost* a court particular to the peasants (*volostnyye sud*), of which the judges and jury, themselves peasants, were elected by the assembly of the *volost* (*volostnyye skhod*) each year. In these courts the ordinary written law had little to say; the decisions of the *volost* courts were based on the local customary law, which alone the peasants, and the peasants alone, understand. The justice administered in them was patriarchal and rough, but not ineffective. All civil cases involving less than 100 roubles value were within their competence, and more important cases by consent of the parties. They acted also as police courts in the case of petty thefts, breaches of the peace and the like. They were also charged with the maintenance of order in the *mir* and the family, punishing infractions of the religious law, husbands who beat their wives, and parents who ill-treated their children. The penalty of flogging, preferred by the peasants to fine or imprisonment, was not unknown. The judges were, of course, wholly illiterate, and this tended to throw the ultimate power into the hands of the clerk (*pisar*) of the court, who was rarely above corruption.

In 1880, according to the observations of M. Leroy-Beaulieu,¹ the fines inflicted by the court were commonly paid in *vodka*, which was consumed on the premises by the judges and the parties to the suit; there is no reason to suppose that this amiable custom has been abandoned.

The peasants are not compelled to go to the *volost* court. They can apply to the police commissaries (*stanovoi*) or to the justices of the peace; but the great distances to be traversed in a country so sparsely populated makes this course highly inconvenient.² On the other hand, from the *volost* court there is no appeal, unless it has acted *ultra vires* or illegally. In the latter case a court of cassation is provided in the district committee for the affairs of the peasants (*Uyednoe po kreftianskim dolam pristutstviye*), which has superseded the assembly of arbiters of the peace (*mirovoye posredniki*) established in 1866.³ (W. A. P.)

Previous to the revolution of 1905 but little progress had been made in Russia as regards education.⁴ Distrust of the natural sciences, even in their technical applications, and of Western ideas of free government; desire to make university education, and even secondary education, a privilege of the wealthier classes; neglect of primary education, coupled with suppression by the ministry of public instruction of all initiative, private and public, in the matter of disseminating education among the illiterate classes—these were the distinctive features of the educational policy of the last twenty years of the 19th century.

It was only towards its close that a change took place in the attitude of the government towards technical education, and a few high and middle technical schools were opened. It was only then, too, that a reform was started in secondary education, with the object of revising the so-called "classical" system favoured in the lycées since the seventies, the complete failure of which has been demonstrated after nearly thirty years of experiment. Apart from the schools under the ministry of war (Cossack *voivods* and schools at the barracks), the great bulk of the primary schools are either under the ministry of public instruction or of the Holy Synod. Those under the latter body are of recent growth, the policy of the last twenty years of the 19th century having been to hand over the budget allowances for primary instruction to the Holy Synod, which opened parish schools under the local priests. The schools under the Synod are themselves divided into two categories: parish schools and reading schools of an inferior grade. No teaching certificate is required by the teachers in either class of school, the permission of the bishop (like the French *lettre d'obédience* of 1849) being sufficient. The consequence is, that the village priests, being too much occupied with their parochial duties, cannot give more than casual or perfunctory attention to the schools, and the numerous pupils either exist on paper only, or are handed over to half-educated cantors, deacons or hired teachers. One good feature of the Russian primary school system, however, is that in many villages there are school gardens or fields; in nearly 1000 schools, bee-keeping, and in 300 silkworm culture is taught; while in some 900 schools the children receive instruction in various trades; and in 300 schools in *self* manual training originated in Finland.⁵ Girls are taught, and work in many schools. In 50% of the schools are women. The total expenditure on primary schools in 1900 was £5,300,000 (about the average in recent years), of which 20% was supplied by the state, 23% by the *zemstvos*, 35½% by the village communities and the municipalities and 11½% by private persons. The middle schools are maintained by the state, which contributes 25% of the expenditure of the classical and technical schools, by the fees of the pupils (30%), and by donations from the *zemstvos* and municipalities. The total grants from the state exchequer for education of all grades in all parts of the empire amount to in 1906 to £8,107,000. The progress of primary education is illustrated by the fact that, while in 1885 there was one school for every 2665 inhabitants and one pupil for every 48 inhabitants, in 1898 the figures were 1643 and 31 inhabitants respectively. According to the census of 1897 the number of illiterates varied from 89.2 to 44.9% of the population in the rural districts, and from 63.6 to 37.2% in the urban.

For higher education there were in 1904 only 9 universities (Yuriev or Dorpat, Kazan, Kharkov, Kiev, Moscow, Odessa, St Petersburg, Warsaw and Tomsk), with 19,400 students, 6 medical academies (one for women), theological academies, 6 military academies, 5 philological institutes, 3 Eastern languages institutes, 3 law schools, 4 veterinary institutes, 4 agricultural colleges, 2 mining institutes, 4 engineering institutes, 2 universities for women (930 students at St Petersburg), 3 technical pedagogic schools, 10 technical institutes, 1 forestry and 1 topographical school. There has, however, been much activity since 1905 in the establishment of new educational institutions, notably technical and commercial schools, which are placed under the new minister of commerce and industry. Finland has a university of its own at Helsinki.

The standard of teaching in the universities is on the whole very high, and may be compared to that of the German universities. The students are hard working, and generally very intelligent. Mostly sons of poor parents, they live in extreme poverty, supporting themselves chiefly by translating and by tutorial work. The state of secondary education still leaves much to be desired. The steady tendency of Russian society towards increasing the number of secondary schools, where instruction would be based on the study of the natural sciences, is checked by the government in favour of the classical gymnasiums.⁶ Sunday schools and public lectures are virtually prohibited. A characteristic feature of the intellectual movement in Russia is its tendency to extend to women the means of higher instruction. The gymnasiums for girls are both numerous and good. In addition to these, notwithstanding government opposition, a series

been given to the effort for improvement, and that the question had been seriously taken in hand by the imperial administration and the Duma. What form it would ultimately take depended still on the balance between the forces of conservatism and change, the suspicious temper of the autocracy being revealed, during the years of unstable equilibrium, by the alteration, concession and withdrawal of privileges, e.g. in the matter of the independence of the universities. Any account of the educational system cannot, therefore, be otherwise than historical and provisional [Ed.].

⁶ An imperial rescript of 10th of June 1902 foreshadowed a re-organization of secondary education, and an imperial *ukaz* of 15th of March 1903 laid down the lines on which this was to proceed. The old curriculum of the *Real* schools is now superseded.

¹ *L'Empire des tsars*, ii, p. 310.

² In the ordinary tribunals weight is given to the "customs" of the peasants, even when these conflict with the written law.

³ The abolition of the special courts of the peasants was announced in the same imperial *ukaz* (18th of October 1906) which promised the relief of the peasants from the arbitrary control of the communes, and permission for them to migrate elsewhere without losing their communal rights. This was made part of the general reform of Russian local government, which in the autumn of 1910 was still under the consideration of the Duma.

⁴ Of the effects of the political changes in Russia on the educational system of the country it was, even in the autumn of 1910, too early to say anything save that an undoubted impetus had

of higher schools, in which careful instruction is given in natural and social sciences, have been opened in the chief cities under the name of "pedagogical courses." At St Petersburg a women's medical academy, the examinations of which were even more searching than those of the ordinary academy (especially as regards diseases of women and children), was opened, but after about one hundred women had received the degree of M.D. it was suppressed by government. In several university towns there are free teaching establishments for women, supported by subscription, with programmes and examinations equal to those of the universities.

The natural sciences are much cultivated in Russia. Besides the Academy of Science, the Moscow Society of Naturalists, the Mineralogical Society, the Geographical Society, with its *Scientific Societies.* Caucasian and Siberian branches, the archaeological societies and the scientific societies of the Baltic provinces, all of which are of old and recognized standing, there have lately sprung up a series of new societies in connexion with each university, and the serials are yearly growing in importance, as, too, are those of the Moscow Society of Friends of Natural Science, the Chemo-Physical Society, and various medical, educational and other associations. The work achieved by Russian savants, especially in biology, physiology and chemistry, and in the sciences descriptive of the vast territory of Russia, is well known to Europe.

The ordinary revenue of the empire is in excess of the ordinary expenditure, but the extraordinary expenditure not only swallows up this surplus, but necessitates the raising of fresh loans, and a large one. On the other hand, there is good cause to show for this extraordinary expenditure. A considerable number of new railways, including the Siberian, have been built with money obtained from that source. But since 1894 all extraordinary items of expenditure, with the exception of those for the construction of new lines of railway, have been defrayed out of ordinary revenue. The only sources of extraordinary revenue still remaining under that head are the money derived from loans and the perpetual deposits in the Imperial Bank. The ordinary revenue, obtained principally from the sale of spirits at 28% which is a state monopoly, from state railways (23½%) and customs (10½%), steadily rose from a total of £1,32,750,000 in 1895 to a total of £214,360,000 in 1905. Other noteworthy sources of revenue are trade licences, direct taxes on lands and forests, stamp duties, posts and telegraphs, indirect taxes on tobacco, sugar and other commodities, the crown forests, and land redemption payable annually by the peasants since 1861. At the same time the total ordinary expenditure has increased at a similarly steady rate, namely from £19,39,000 in 1854 to £1,55,000 in 1904, 81¼% of the extraordinary expenditure, namely £71,525,000, was incurred in consequence of the war with Japan, and to this must be added in 1906 a further expenditure of £42,085,000. The total national debt of Russia nearly trebled between 1852 (£57,038,600) and 1862 (£145,500,000), and again between 1872 (£242,277,000) and 1892 (£526,109,000) it more than doubled, while by 1906 it amounted altogether to £812,040,000. Of the total 77% stands at 4% and at less than 4%.

The system of obligatory military service for all, introduced in 1874, has been maintained, but the six years' term of service has been reduced to five, while the privileges granted to *Army.* young men who have received various degrees of education have been slightly extended. During the reign of Alexander III. efforts were mainly directed towards—(1) reducing the time required for the mobilization of the army; (2) increasing the immediate readiness of cavalry for war and its fitness for serving as mounted infantry (dragoon regiments taking the place of hussars and mousquetaires); (3) strengthening the army frontiers by fortresses and railways; and (4) increasing the artillery, siege and train reserves. Further, the age releasing from service was raised from 40 to 43 years and the militia (*landsturm*) was reorganized. The measures taken during the reign of Nicholas II. have been chiefly directed towards increasing the fighting capacity and readiness for immediate service of the troops in Asia, and towards the better reorganization of the local irregular militia forces. Broadly speaking, the army is divided into regulars, Cossacks and militia. The fighting strength of the army is estimated at 42,000 officers and 1,100,000 men (about 950,000 combatants), while the war strength is approximately 75,000 officers and 4,500,000 men. However, this latter figure is merely nominal, the available artillery and train service being much below the strength which would be required for such an army; estimates which put the military forces of Russia in time of war at 2,750,000—irrespective of the armies which may be levied during the war itself—seem to approach more nearly the strength of the forces which could actually be mustered. The infantry and militia are armed with small-bore magazine rifles, and the active artillery have steel breech-loaders with extreme ranges of 4150 to 4700 yds.

Before the Japanese war Russia maintained four separate squadrons: the Baltic, the Black Sea, the Pacific and the Caspian.

But in the operations before Port Arthur and in the disastrous battle of Tsushima the Russian fleets were almost completely annihilated. The bulk of the Black Sea fleet and a few other battleships were, however, still left, and since 1904

steps have been taken to build new ships, both battleships and powerful cruisers. Kronstadt is the naval headquarters in the Baltic, Sevastopol in the Black Sea and Vladivostok in the Pacific.

Fortresses.—The chief first-class fortresses of Russia are Warsaw and Novogorodsk in Poland, and Brest-Litovsk and Kovno in Lithuania. The second-class fortresses are Kronstadt and Sveaborg in the Gulf of Finland, Ivangorod in Poland, Libau on the Baltic Sea, Kerch on the Black Sea and Vladivostok on the Pacific. In the third class are Viborg in Finland, Osovets and Ust Dvinsk (or Dünamünde) in Lithuania, Sevastopol and Ochakov on the Black Sea, and Kars and Batum in Caucasia. There are, moreover, 46 forts and fortresses unclassified, of which 6 are in Poland, 8 in W. and S.W. Russia, and the remainder (mere fortified posts) in the Asiatic dominions.

II. EUROPEAN RUSSIA

Geography.—The administrative boundaries of European Russia, apart from Finland, coincide broadly with the natural limits of the East-European plains. In the N. it is bounded by the Arctic Ocean; the islands of Novaya-Zemlya, Kolguev and Vaigach also belong to it, but the Kara Sea is reckoned to Siberia. To the E. it has the Asiatic dominions of the empire, Siberia and the Kirghiz steppes, from both of which it is separated by the Ural Mountains, the Ural river and the Caspian—the administrative boundary, however, partly extending into Asia on the Siberian slope of the Urals. To the S. it has the Black Sea and Caucasia, being separated from the latter by the Manych depression, which in Post-Pliocene times connected the Sea of Azov with the Caspian. The W. boundary is purely conventional: it crosses the peninsula of Kola from the Varanger Fjord to the Gulf of Bothnia; thence it runs to the Kurisches Haff in the southern Baltic, and thence to the mouth of the Danube, taking a great circular sweep to the W. to embrace Poland, and separating Russia from Prussia, Austrian Galicia and Rumania.

It is a special feature of Russia that she has no free outlet to the open sea except on the ice-bound shores of the Arctic Ocean. Even the White Sea is merely a gulf of that ocean. The deep indentations of the gulfs of Bothnia and Finland are surrounded by what is ethnologically Finnish territory, and it is only at the very head of the latter gulf that the Russians have taken firm foothold by erecting their capital at the mouth of the Neva. The Gulf of Riga and the Baltic belong also to territory which is not inhabited by Slavs, but by Finnish races and by Germans. It is only within the last hundred and thirty years that the Russians have definitely taken possession of the N. shores of the Black Sea and the Sea of Azov. The E. coast of the Black Sea belongs properly to Transcaucasia, a great chain of mountains separating it from Russia. But even this sheet of water is an inland sea, the only outlet of which, the Bosphorus, is in foreign hands, while the Caspian, an immense shallow lake, mostly bordered by deserts, possesses more importance as a link between Russia and her Asiatic settlements than as a channel for intercourse with other countries.

The great territory occupied by European Russia—1600 m. in length from N. to S., and nearly as much from E. to W.—is on the whole a broad elevated plain, ranging between 500 and 900 ft. above sea-level, deeply cut into by river-valleys, and bounded on all sides by broad swellings or low mountain-ranges: the lake plateaus of Finland and the Maanselkä heights in the N.W.; the Baltic coast-range and spurs of the Carpathians in the W., with a broad depression between the two, occupied by Poland; the Crimean and Caucasian mountains in the S.; and the broad but moderately high swelling of the Ural Mountains in the E.

From a central plateau, which comprises the governments of Tver, Moscow, Smolensk and Kursk, and projects E. towards Samara, attaining an average elevation of 800 to 900 ft. above the sea, the surface slopes gently in all directions to a level of 300 to 500 ft. Then it again rises gradually as it approaches the hilly tracts which enclose the great plain. This central swelling may be considered a continuation towards the E.N.E. of the great line of upheavals of N.W. Europe; the elevated grounds of Finland would then represent a continuation of the Scania plateaus of S. Sweden, and the northern mountains of Finland a continuation of Kjølén (the Keel) which separate Sweden from Norway, while the other great line of

Boundaries.

Configuration.

upheaval of the old continent, which runs N.W. to S.E., would be represented in Russia by the Caucasus in the S. and by the Timan ridge of the Pechora basin in the N.

The hilly aspect of several parts of the central plateau is not due to foldings of the strata, which for the most part appear to be horizontal, but chiefly to the excavating action of the rivers, whose valleys are deeply eroded in the plateau, especially on its borders. The round flattened summits of the Valdai plateau do not rise above 1100 ft., and they present the appearance of mountains only in consequence of the depths of the valleys—the rivers which flow towards the depression of Lake Peipus being only 200 to 250 ft. above the sea. The same is true of the plateaus of Livonia, "Wendish Switzerland," and the government of Kovno, which do not exceed 1000 ft. at their highest points; and again of the E. spurs of the Baltic coast-ridge between the governments of Grodno and Minsk. The same elevation is reached by a very few flat summits of the plateau about Kursk, and farther E. on the Volga about Kamyshev, where the valleys are excavated to a depth of 800 or 900 ft., giving quite a hilly aspect to the country. It is only in the S.W. where spurs of the Carpathians enter the governments of Volhynia, Podolia and Bessarabia, that ridges reaching 1100 ft. are met with, these again intersected by deep ravines.

The depressions which gap the borders of the central plateau thus acquire a greater importance than the small differences in its vertical elevation. Such is the broad depression of the middle Volga and lower Kama, bounded on the N. by the faint swelling of the Uvaly, the watershed between the Arctic Ocean and the Volga basin. Another broad depression, 250 to 500 ft. above the sea, still filled by Lakes Peipus, Ladoga, Onega, Byelo-ozero, Lacha, Vozhe, and many thousands of smaller lakes, skirts the central plateau on the N. and follows in the same E.N.W. direction. Only a few low swellings penetrate into it from the N.E., about Lake Onega, and reach 900 ft., while in the N.E. it is enclosed by the Timan ridge (1000 ft.). A third depression, traversed by the Pripiet and the middle Dnieper, extends to the W. and penetrates into Poland. This immense lacustrine basin is now broken up into numberless ponds, lakes and marshes (see MINSK). It is bounded on the S. by the broad plateau which spread out E. of the Carpathians. S. of 50° N. the central plateau slopes gently towards the S., and we find there a fourth depression stretching W. and E. through Poltava and Khar'kov. The soil reaching in its highest parts 500 to 700 ft. It is separated from the Black Sea by gentle swelling which may be traced from Kremenes in Volhynia to the lower Don, and perhaps farther S.E. This swelling includes the Donets coal-measures and the middle granitic ridges which give rise to the rapids of the Dnieper. Finally a fifth depression, which descends below the level of the ocean, extends for more than 200 m. to the N. of the Caspian, comprising the lower Volga and the Ural and Emba rivers, and establishing a link between Russia and the Aral-Caspian region. It is continued farther N. by plains below 300 ft., which join the depression of the middle Volga, and extend as far as the mouth of the Oka.

The Ural Mountains present the aspect of a broad swelling whose strata no longer exhibit the horizontal quality which is characteristic of central Russia, and moreover are deeply cut into by rivers. They are connected in the W. with broad plateaus which join those of central Russia, but their orographical relations to other upheavals must be more closely studied before they can be definitely pronounced on.

The rhomboidal peninsula of the Crimea, connected by only a narrow isthmus with the continent, is occupied by an arid plateau sloping gently N. and E., and bordered on the S.E. by the Yaila Mountains, the summits of which range between 4000 and 5000 ft.

Owing to the orographical structure of the E. European plains the river systems have become more than usually prominent and their important features of the configuration. Taking their origin from a series of lacustrine basins scattered over the plateau and differing slightly in elevation, the Russian rivers describe immense curves before reaching the sea, and flow with a very gentle gradient, while numerous large tributaries collect their waters from over vast areas. Thus the Volga, the Dnieper and the Don attain respectively lengths of 2325, 1410 and 1325 m., and their basins run to 563,300, 202,140 and 166,000 sq. m. respectively. Moreover, the chief rivers, the Volga, the W. Dvina, the Dnieper, and even the Lovat at the mouth of the sea (the N.W. of the central plateau) are so close to one another that they may be said to radiate from the same centre. The sources of the Don interlace with the tributaries of the Oka, while the upper tributaries of the Kama join those of the N. Dvina and Pechora. In consequence of this, the rivers of Russia have been from remote antiquity the principal channels of trade and migration, and have contributed much more to the elaboration of national unity than any political institutions. Boats could be conveyed over flat and easy portages from one river-basin to another, and these portages were subsequently transformed with a relatively small amount of labour into navigable canals, and even at the present day the canals have more importance for the traffic of the country than have most of the railways. By their means the plains of the central plateau—the very heart of Russia, whose natural outlet was the Caspian—were brought into water-communication with the Baltic, and the Volga

basin was connected with the Gulf of Finland. The White Sea has also been brought into connexion with the central Volga basin while the sister-river of the Volga—the Kama—became the main artery of communication with Siberia.

But although the rivers of Russia rank before the rivers of W. Europe in respect of length, they are far behind them as regards the volumes of water which they discharge. They freeze in winter and dry up in summer, and most of them are navigable only during the spring floods; even the Volga becomes so shallow during the hot season that none but boats of light draught can pass over its shoals.

Arctic Ocean Basin.—The Pechora rises in the N. Urals, and enters the ocean by a large estuary at the Gulf of Pechora. Its basin, thinly-peopled and available only for cattle-breeding and for hunting, is quite isolated from Russia by the Timan ridge. The river is navigable for 770 m.; grain and a variety of goods conveyed from the upper Kama are floated down, while furs, fish and other products of the sea are shipped up the river to be transported to Cherdyn on the Kama. The Mezeñ enters the Bay of Mezeñ; it is navigable for 450 m., and is the channel of a considerable export of timber. The N. Dvina is formed by the union of the Yug and the Sukhona. The latter, although it flows over a great number of rapids, is navigable throughout its length (330 m.); it is connected by canal with the Caspian and the Baltic. The Vychehga, which flows W.S.W. to join the Sukhona, through a woody region, thinly peopled, is navigable for 500 m. and in its upper portion is connected by a canal with the upper Kama. The N. Dvina flows with a very slight gradient through a broad valley, and reaches the White Sea at Archangel. Notwithstanding serious obstacles offered by shallows, corn, fish, salt and timber are largely shipped to and from Archangel. The Onega, which flows into Onega Bay, has rapids; but timber is floated down in spring, and fishing and some navigation are carried on in the lower portion.

Baltic Basin.—The Neva (40 m.) flows from Lake Ladoga into the Gulf of Finland. The Volkhov, discharging into Lake Ladoga, and forming part of the Vyschniy-Volochok system of canals, is an important channel for navigation; it flows from Lake Ilmen, which receives the Msta, connected with the Volga, and the Lovat. The Svir, also discharging into Lake Ladoga, flows from Lake Onega, and, being part of the Mariinsk canal system, is of great importance for navigation. The Narova flows out of Lake Peipus into the Gulf of Finland at Narva; it has remarkable rapids, which are rare to be found now, far cotton-mills; in spite of this, the river is navigated. Lake Peipus, or Chudskoye, receives the Velikaya, a channel of traffic with S. Russia from a remote antiquity, but now navigable only in its lower portion, and the Embach, navigated by steamers to Dorpat (Yuryev). The S. Dvina, which falls into the sea below Riga, is shallow above the rapids of Jacobstadt, but navigation is carried on as far as Vitbesk—corn, timber, potash, flax, &c., being the principal shipments of its navigable tributaries (the Obsha, Ulla and Kasplya). The Ulla is connected by the Berezhina canals with the Dnieper. The Memel (Niemen), with a course of 470 m. in Russia, rises in the N. of Minsk, leaves Russia at Yurburg, and enters the Kurisches Haff; rafts are floated upon it almost from its source, and steamers ply as far as Kovno; it is connected by the Oginsky canal with the Dnieper. For the Vistula, with the Bug and Narew, see POLAND.

Black Sea Basin.—The Pruth rises in Austrian Bukovina, and separates Russia from Rumania; it enters the Danube, which flows along the Russian frontier for 100 m. below Reni, touching it with its Kilia branch. The Dniester (530 m. in Russia) rises in Galicia. Light boats and rafts are floated at all points, and steamers ply on its lower portion; its estuary has important fisheries. The Dnieper, with a basin of 202,140 sq. m., drains 33,000,000 cu. ft. of water, and has a population of 2,000,000, of whom 250,000 live in the marshy lakes in the N.W. parts of the central plateau, in the same way that the rivers which give rise to the Volga and the W. Dvina, and enters the Black Sea. In the middle navigable part of its course, from Dorogobuz to Ekaterinoslav, it is an active channel for traffic. It receives several large tributaries:—on the right, the Berezhina, connected with the W. Dvina, and the Pripiet, both very important for navigation—as well as several smaller tributaries on which rafts are floated; on the left the Sozh, the Desna, one of the most important rivers of Russia, navigated by steamers as far as Bryansk, the Sula, the Pse and the Voronezh. Below Ekaterinoslav the Dnieper flows for 46 m. over a series of rapids. At Kherson it enters its long (40 m.) but shallow estuary, which receives the S. Bug and the Ingul. The Don, with a basin of 166,000 sq. m., and navigable for 880 m., rises in the government of Tula and enters the Sea of Azov at Rostov, after describing a great curve to the E. at Tsaritsyn, approaching the Volga, with which it is connected by a railway (45 m.). Its navigation is of great importance, especially for goods brought from the Volga, and its fisheries are extensive. The chief tributaries are the Sosna and North Donets on the right, and the Voronezh, Kholer, Medvedyitsa and Manych on the left. The Ylya, the Kuban and the Rion descend to Caucasus. The Dnepr flows for 46 m. over a series of rapids. At Kherson it enters its long (40 m.) but shallow estuary, which receives the S. Bug and the Ingul. The Don, with a basin of 166,000 sq. m., and navigable for 880 m., rises in the government of Tula and enters the Sea of Azov at Rostov, after describing a great curve to the E. at Tsaritsyn, approaching the Volga, with which it is connected by a railway (45 m.). Its navigation is of great importance, especially for goods brought from the Volga, and its fisheries are extensive. The chief tributaries are the Sosna and North Donets on the right, and the Voronezh, Kholer, Medvedyitsa and Manych on the left. The Ylya, the Kuban and the Rion descend to Caucasus. The Dnepr flows for 46 m. over a series of rapids. At Kherson it enters its long (40 m.) but shallow estuary, which receives the S. Bug and the Ingul. The Don, with a basin of 166,000 sq. m., and navigable for 880 m., rises in the government of Tula and enters the Sea of Azov at Rostov, after describing a great curve to the E. at Tsaritsyn, approaching the Volga, with which it is connected by a railway (45 m.). Its navigation is of great importance, especially for goods brought from the Volga, and its fisheries are extensive. The chief tributaries are the Sosna and North Donets on the right, and the Voronezh, Kholer, Medvedyitsa and Manych on the left. The Ylya, the Kuban and the Rion descend to Caucasus. The Dnepr flows for 46 m. over a series of rapids. At Kherson it enters its long (40 m.) but shallow estuary, which receives the S. Bug and the Ingul. The Don, with a basin of 166,000 sq. m., and navigable for 880 m., rises in the government of Tula and enters the Sea of Azov at Rostov, after describing a great curve to the E. at Tsaritsyn, approaching the Volga, with which it is connected by a railway (45 m.). Its navigation is of great importance, especially for goods brought from the Volga, and its fisheries are extensive. The chief tributaries are the Sosna and North Donets on the right, and the Voronezh, Kholer, Medvedyitsa and Manych on the left. The Ylya, the Kuban and the Rion descend to Caucasus. The Dnepr flows for 46 m. over a series of rapids. At Kherson it enters its long (40 m.) but shallow estuary, which receives the S. Bug and the Ingul. The Don, with a basin of 166,000 sq. m., and navigable for 880 m., rises in the government of Tula and enters the Sea of Azov at Rostov, after describing a great curve to the E. at Tsaritsyn, approaching the Volga, with which it is connected by a railway (45 m.). Its navigation is of great importance, especially for goods brought from the Volga, and its fisheries are extensive. The chief tributaries are the Sosna and North Donets on the right, and the Voronezh, Kholer, Medvedyitsa and Manych on the left. The Ylya, the Kuban and the Rion descend to Caucasus. The Dnepr flows for 46 m. over a series of rapids. At Kherson it enters its long (40 m.) but shallow estuary, which receives the S. Bug and the Ingul. The Don, with a basin of 166,000 sq. m., and navigable for 880 m., rises in the government of Tula and enters the Sea of Azov at Rostov, after describing a great curve to the E. at Tsaritsyn, approaching the Volga, with which it is connected by a railway (45 m.). Its navigation is of great importance, especially for goods brought from the Volga, and its fisheries are extensive. The chief tributaries are the Sosna and North Donets on the right, and the Voronezh, Kholer, Medvedyitsa and Manych on the left. The Ylya, the Kuban and the Rion descend to Caucasus. The Dnepr flows for 46 m. over a series of rapids. At Kherson it enters its long (40 m.) but shallow estuary, which receives the S. Bug and the Ingul. The Don, with a basin of 166,000 sq. m., and navigable for 880 m., rises in the government of Tula and enters the Sea of Azov at Rostov, after describing a great curve to the E. at Tsaritsyn, approaching the Volga, with which it is connected by a railway (45 m.). Its navigation is of great importance, especially for goods brought from the Volga, and its fisheries are extensive. The chief tributaries are the Sosna and North Donets on the right, and the Voronezh, Kholer, Medvedyitsa and Manych on the left. The Ylya, the Kuban and the Rion descend to Caucasus. The Dnepr flows for 46 m. over a series of rapids. At Kherson it enters its long (40 m.) but shallow estuary, which receives the S. Bug and the Ingul. The Don, with a basin of 166,000 sq. m., and navigable for 880 m., rises in the government of Tula and enters the Sea of Azov at Rostov, after describing a great curve to the E. at Tsaritsyn, approaching the Volga, with which it is connected by a railway (45 m.). Its navigation is of great importance, especially for goods brought from the Volga, and its fisheries are extensive. The chief tributaries are the Sosna and North Donets on the right, and the Voronezh, Kholer, Medvedyitsa and Manych on the left. The Ylya, the Kuban and the Rion descend to Caucasus. The Dnepr flows for 46 m. over a series of rapids. At Kherson it enters its long (40 m.) but shallow estuary, which receives the S. Bug and the Ingul. The Don, with a basin of 166,000 sq. m., and navigable for 880 m., rises in the government of Tula and enters the Sea of Azov at Rostov, after describing a great curve to the E. at Tsaritsyn, approaching the Volga, with which it is connected by a railway (45 m.). Its navigation is of great importance, especially for goods brought from the Volga, and its fisheries are extensive. The chief tributaries are the Sosna and North Donets on the right, and the Voronezh, Kholer, Medvedyitsa and Manych on the left. The Ylya, the Kuban and the Rion descend to Caucasus. The Dnepr flows for 46 m. over a series of rapids. At Kherson it enters its long (40 m.) but shallow estuary, which receives the S. Bug and the Ingul. The Don, with a basin of 166,000 sq. m., and navigable for 880 m., rises in the government of Tula and enters the Sea of Azov at Rostov, after describing a great curve to the E. at Tsaritsyn, approaching the Volga, with which it is connected by a railway (45 m.). Its navigation is of great importance, especially for goods brought from the Volga, and its fisheries are extensive. The chief tributaries are the Sosna and North Donets on the right, and the Voronezh, Kholer, Medvedyitsa and Manych on the left. The Ylya, the Kuban and the Rion descend to Caucasus. The Dnepr flows for 46 m. over a series of rapids. At Kherson it enters its long (40 m.) but shallow estuary, which receives the S. Bug and the Ingul. The Don, with a basin of 166,000 sq. m., and navigable for 880 m., rises in the government of Tula and enters the Sea of Azov at Rostov, after describing a great curve to the E. at Tsaritsyn, approaching the Volga, with which it is connected by a railway (45 m.). Its navigation is of great importance, especially for goods brought from the Volga, and its fisheries are extensive. The chief tributaries are the Sosna and North Donets on the right, and the Voronezh, Kholer, Medvedyitsa and Manych on the left. The Ylya, the Kuban and the Rion descend to Caucasus. The Dnepr flows for 46 m. over a series of rapids. At Kherson it enters its long (40 m.) but shallow estuary, which receives the S. Bug and the Ingul. The Don, with a basin of 166,000 sq. m., and navigable for 880 m., rises in the government of Tula and enters the Sea of Azov at Rostov, after describing a great curve to the E. at Tsaritsyn, approaching the Volga, with which it is connected by a railway (45 m.). Its navigation is of great importance, especially for goods brought from the Volga, and its fisheries are extensive. The chief tributaries are the Sosna and North Donets on the right, and the Voronezh, Kholer, Medvedyitsa and Manych on the left. The Ylya, the Kuban and the Rion descend to Caucasus. The Dnepr flows for 46 m. over a series of rapids. At Kherson it enters its long (40 m.) but shallow estuary, which receives the S. Bug and the Ingul. The Don, with a basin of 166,000 sq. m., and navigable for 880 m., rises in the government of Tula and enters the Sea of Azov at Rostov, after describing a great curve to the E. at Tsaritsyn, approaching the Volga, with which it is connected by a railway (45 m.). Its navigation is of great importance, especially for goods brought from the Volga, and its fisheries are extensive. The chief tributaries are the Sosna and North Donets on the right, and the Voronezh, Kholer, Medvedyitsa and Manych on the left. The Ylya, the Kuban and the Rion descend to Caucasus. The Dnepr flows for 46 m. over a series of rapids. At Kherson it enters its long (40 m.) but shallow estuary, which receives the S. Bug and the Ingul. The Don, with a basin of 166,000 sq. m., and navigable for 880 m., rises in the government of Tula and enters the Sea of Azov at Rostov, after describing a great curve to the E. at Tsaritsyn, approaching the Volga, with which it is connected by a railway (45 m.). Its navigation is of great importance, especially for goods brought from the Volga, and its fisheries are extensive. The chief tributaries are the Sosna and North Donets on the right, and the Voronezh, Kholer, Medvedyitsa and Manych on the left. The Ylya, the Kuban and the Rion descend to Caucasus. The Dnepr flows for 46 m. over a series of rapids. At Kherson it enters its long (40 m.) but shallow estuary, which receives the S. Bug and the Ingul. The Don, with a basin of 166,000 sq. m., and navigable for 880 m., rises in the government of Tula and enters the Sea of Azov at Rostov, after describing a great curve to the E. at Tsaritsyn, approaching the Volga, with which it is connected by a railway (45 m.). Its navigation is of great importance, especially for goods brought from the Volga, and its fisheries are extensive. The chief tributaries are the Sosna and North Donets on the right, and the Voronezh, Kholer, Medvedyitsa and Manych on the left. The Ylya, the Kuban and the Rion descend to Caucasus. The Dnepr flows for 46 m. over a series of rapids. At Kherson it enters its long (40 m.) but shallow estuary, which receives the S. Bug and the Ingul. The Don, with a basin of 166,000 sq. m., and navigable for 880 m., rises in the government of Tula and enters the Sea of Azov at Rostov, after describing a great curve to the E. at Tsaritsyn, approaching the Volga, with which it is connected by a railway (45 m.). Its navigation is of great importance, especially for goods brought from the Volga, and its fisheries are extensive. The chief tributaries are the Sosna and North Donets on the right, and the Voronezh, Kholer, Medvedyitsa and Manych on the left. The Ylya, the Kuban and the Rion descend to Caucasus. The Dnepr flows for 46 m. over a series of rapids. At Kherson it enters its long (40 m.) but shallow estuary, which receives the S. Bug and the Ingul. The Don, with a basin of 166,000 sq. m., and navigable for 880 m., rises in the government of Tula and enters the Sea of Azov at Rostov, after describing a great curve to the E. at Tsaritsyn, approaching the Volga, with which it is connected by a railway (45 m.). Its navigation is of great importance, especially for goods brought from the Volga, and its fisheries are extensive. The chief tributaries are the Sosna and North Donets on the right, and the Voronezh, Kholer, Medvedyitsa and Manych on the left. The Ylya, the Kuban and the Rion descend to Caucasus. The Dnepr flows for 46 m. over a series of rapids. At Kherson it enters its long (40 m.) but shallow estuary, which receives the S. Bug and the Ingul. The Don, with a basin of 166,000 sq. m., and navigable for 880 m., rises in the government of Tula and enters the Sea of Azov at Rostov, after describing a great curve to the E. at Tsaritsyn, approaching the Volga, with which it is connected by a railway (45 m.). Its navigation is of great importance, especially for goods brought from the Volga, and its fisheries are extensive. The chief tributaries are the Sosna and North Donets on the right, and the Voronezh, Kholer, Medvedyitsa and Manych on the left. The Ylya, the Kuban and the Rion descend to Caucasus. The Dnepr flows for 46 m. over a series of rapids. At Kherson it enters its long (40 m.) but shallow estuary, which receives the S. Bug and the Ingul. The Don, with a basin of 166,000 sq. m., and navigable for 880 m., rises in the government of Tula and enters the Sea of Azov at Rostov, after describing a great curve to the E. at Tsaritsyn, approaching the Volga, with which it is connected by a railway (45 m.). Its navigation is of great importance, especially for goods brought from the Volga, and its fisheries are extensive. The chief tributaries are the Sosna and North Donets on the right, and the Voronezh, Kholer, Medvedyitsa and Manych on the left. The Ylya, the Kuban and the Rion descend to Caucasus. The Dnepr flows for 46 m. over a series of rapids. At Kherson it enters its long (40 m.) but shallow estuary, which receives the S. Bug and the Ingul. The Don, with a basin of 166,000 sq. m., and navigable for 880 m., rises in the government of Tula and enters the Sea of Azov at Rostov, after describing a great curve to the E. at Tsaritsyn, approaching the Volga, with which it is connected by a railway (45 m.). Its navigation is of great importance, especially for goods brought from the Volga, and its fisheries are extensive. The chief tributaries are the Sosna and North Donets on the right, and the Voronezh, Kholer, Medvedyitsa and Manych on the left. The Ylya, the Kuban and the Rion descend to Caucasus. The Dnepr flows for 46 m. over a series of rapids. At Kherson it enters its long (40 m.) but shallow estuary, which receives the S. Bug and the Ingul. The Don, with a basin of 166,000 sq. m., and navigable for 880 m., rises in the government of Tula and enters the Sea of Azov at Rostov, after describing a great curve to the E. at Tsaritsyn, approaching the Volga, with which it is connected by a railway (45 m.). Its navigation is of great importance, especially for goods brought from the Volga, and its fisheries are extensive. The chief tributaries are the Sosna and North Donets on the right, and the Voronezh, Kholer, Medvedyitsa and Manych on the left. The Ylya, the Kuban and the Rion descend to Caucasus. The Dnepr flows for 46 m. over a series of rapids. At Kherson it enters its long (40 m.) but shallow estuary, which receives the S. Bug and the Ingul. The Don, with a basin of 166,000 sq. m., and navigable for 880 m., rises in the government of Tula and enters the Sea of Azov at Rostov, after describing a great curve to the E. at Tsaritsyn, approaching the Volga, with which it is connected by a railway (45 m.). Its navigation is of great importance, especially for goods brought from the Volga, and its fisheries are extensive. The chief tributaries are the Sosna and North Donets on the right, and the Voronezh, Kholer, Medvedyitsa and Manych on the left. The Ylya, the Kuban and the Rion descend to Caucasus. The Dnepr flows for 46 m. over a series of rapids. At Kherson it enters its long (40 m.) but shallow estuary, which receives the S. Bug and the Ingul. The Don, with a basin of 166,000 sq. m., and navigable for 880 m., rises in the government of Tula and enters the Sea of Azov at Rostov, after describing a great curve to the E. at Tsaritsyn, approaching the Volga, with which it is connected by a railway (45 m.). Its navigation is of great importance, especially for goods brought from the Volga, and its fisheries are extensive. The chief tributaries are the Sosna and North Donets on the right, and the Voronezh, Kholer, Medvedyitsa and Manych on the left. The Ylya, the Kuban and the Rion descend to Caucasus. The Dnepr flows for 46 m. over a series of rapids. At Kherson it enters its long (40 m.) but shallow estuary, which receives the S. Bug and the Ingul. The Don, with a basin of 166,000 sq. m., and navigable for 880 m., rises in the government of Tula and enters the Sea of Azov at Rostov, after describing a great curve to the E. at Tsaritsyn, approaching the Volga, with which it is connected by a railway (45 m.). Its navigation is of great importance, especially for goods brought from the Volga, and its fisheries are extensive. The chief tributaries are the Sosna and North Donets on the right, and the Voronezh, Kholer, Medvedyitsa and Manych on the left. The Ylya, the Kuban and the Rion descend to Caucasus. The Dnepr flows for 46 m. over a series of rapids. At Kherson it enters its long (40 m.) but shallow estuary, which receives the S. Bug and the Ingul. The Don, with a basin of 166,000 sq. m., and navigable for 880 m., rises in the government of Tula and enters the Sea of Azov at Rostov, after describing a great curve to the E. at Tsaritsyn, approaching the Volga, with which it is connected by a railway (45 m.). Its navigation is of great importance, especially for goods brought from the Volga, and its fisheries are extensive. The chief tributaries are the Sosna and North Donets on the right, and the Voronezh, Kholer, Medvedyitsa and Manych on the left. The Ylya, the Kuban and the Rion descend to Caucasus. The Dnepr flows for 46 m. over a series of rapids. At Kherson it enters its long (40 m.) but shallow estuary, which receives the S. Bug and the Ingul. The Don, with a basin of 166,000 sq. m., and navigable for 880 m., rises in the government of Tula and enters the Sea of Azov at Rostov, after describing a great curve to the E. at Tsaritsyn, approaching the Volga, with which it is connected by a railway (45 m.). Its navigation is of great importance, especially for goods brought from the Volga, and its fisheries are extensive. The chief tributaries are the Sosna and North Donets on the right, and the Voronezh, Kholer, Medvedyitsa and Manych on the left. The Ylya, the Kuban and the Rion descend to Caucasus. The Dnepr flows for 46 m. over a series of rapids. At Kherson it enters its long (40 m.) but shallow estuary, which receives the S. Bug and the Ingul. The Don, with a basin of 166,000 sq. m., and navigable for 880 m., rises in the government of Tula and enters the Sea of Azov at Rostov, after describing a great curve to the E. at Tsaritsyn, approaching the Volga, with which it is connected by a railway (45 m.). Its navigation is of great importance, especially for goods brought from the Volga, and its fisheries are extensive. The chief tributaries are the Sosna and North Donets on the right, and the Voronezh, Kholer, Medvedyitsa and Manych on the left. The Ylya, the Kuban and the Rion descend to Caucasus. The Dnepr flows for 46 m. over a series of rapids. At Kherson it enters its long (40 m.) but shallow estuary, which receives the S. Bug and the Ingul. The Don, with a basin of 166,000 sq. m., and navigable for 880 m., rises in the government of Tula and enters the Sea of Azov at Rostov, after describing a great curve to the E. at Tsaritsyn, approaching the Volga, with which it is connected by a railway (45 m.). Its navigation is of great importance, especially for goods brought from the Volga, and its fisheries are extensive. The chief tributaries are the Sosna and North Donets on the right, and the Voronezh, Kholer, Medvedyitsa and Manych on the left. The Ylya, the Kuban and the Rion descend to Caucasus. The Dnepr flows for 46 m. over a series of rapids. At Kherson it enters its long (40 m.) but shallow estuary, which receives the S. Bug and the Ingul. The Don, with a basin of 166,000 sq. m., and navigable for 880 m., rises in the government of Tula and enters the Sea of Azov at Rostov, after describing a great curve to the E. at Tsaritsyn, approaching the Volga, with which it is connected by a railway (45 m.). Its navigation is of great importance, especially for goods brought from the Volga, and its fisheries are extensive. The chief tributaries are the Sosna and North Donets on the right, and the Voronezh, Kholer, Medvedyitsa and Manych on the left. The Ylya, the Kuban and the Rion descend to Caucasus. The Dnepr flows for 46 m. over a series of rapids. At Kherson it enters its long (40 m.) but shallow estuary, which receives the S. Bug and the Ingul. The Don, with a basin of 166,000 sq. m., and navigable for 880 m., rises in the government of Tula and enters the Sea of Azov at Rostov, after describing a great curve to the E. at Tsaritsyn, approaching the Volga, with which it is connected by a railway (45 m.). Its navigation is of great importance, especially for goods brought from the Volga, and its fisheries are extensive. The chief tributaries are the Sosna and North Donets on the right, and the Voronezh, Kholer, Medvedyitsa and Manych on the left. The Ylya, the Kuban and the Rion descend to Caucasus. The Dnepr flows for 46 m. over a series of rapids. At Kherson it enters its long (40 m.) but shallow estuary, which receives the S. Bug and the Ingul. The Don, with a basin of 166,000 sq. m., and navigable for 880 m., rises in the government of Tula and enters the Sea of Azov at Rostov, after describing a great curve to the E. at Tsaritsyn, approaching the Volga, with which it is connected by a railway (45 m.). Its navigation is of great importance, especially for goods brought from the Volga, and its fisheries are extensive. The chief tributaries are the Sosna and North Donets on the right, and the Voronezh, Kholer, Medvedyitsa and Manych on the left. The Ylya, the Kuban and the Rion descend to Caucasus. The Dnepr flows for 46 m. over a series of rapids. At Kherson it enters its long (40 m.) but shallow estuary, which receives the S. Bug and the Ingul. The Don, with a basin of 166,000 sq. m., and navigable for 880 m., rises in the government of Tula and enters the Sea of Azov at Rostov, after describing a great curve to the E. at Tsaritsyn, approaching the Volga, with which it is connected by a railway (45 m.). Its navigation is of great importance, especially for goods brought from the Volga, and its fisheries are extensive. The chief tributaries are the Sosna and North Donets on the right, and the Voronezh, Kholer, Medvedyitsa and Manych on the left. The Ylya, the Kuban and the Rion descend to Caucasus. The Dnepr flows for 46 m. over a series of rapids. At Kherson it enters its long (40 m.) but shallow estuary, which receives the S. Bug and the Ingul. The Don, with a basin of 166,000 sq. m., and navigable for 880 m., rises in the government of Tula and enters the Sea of Azov at Rostov, after describing a great curve to the E. at Tsaritsyn, approaching the Volga, with which it is connected by a railway (45 m.). Its navigation is of great importance, especially for goods brought from the Volga, and its fisheries are extensive. The chief tributaries are the Sosna and North Donets on the right, and the Voronezh, Kholer, Medvedyitsa and Manych on the left. The Ylya, the Kuban and the Rion descend to Caucasus. The Dnepr flows for 46 m. over a series of rapids. At Kherson it enters its long (40 m.) but shallow estuary, which receives the S. Bug and the Ingul. The Don, with a basin of 166,000 sq. m., and navigable for 880 m., rises in the government of Tula and enters the Sea of Azov at Rostov, after describing a great curve to the E. at Tsaritsyn, approaching the Volga, with which it is connected by a railway (45 m.). Its navigation is of great importance, especially for goods brought from the Volga, and its fisheries are extensive. The chief tributaries are the Sosna and North Donets on the right, and the Voronezh, Kholer, Medvedyitsa and Manych on the left. The Ylya, the Kuban and the Rion descend to Caucasus. The Dnepr flows for 46 m. over a series of rapids. At Kherson it enters its long (40 m.) but shallow estuary, which receives the S. Bug and the Ingul. The Don, with a basin of 166,000 sq. m., and navigable for 880 m., rises in the government of Tula and enters the Sea of Azov at Rostov, after describing a great curve to the E. at Tsaritsyn, approaching the Volga, with which it is connected by a railway (45 m.). Its navigation is of great importance, especially for goods brought from the Volga, and its fisheries are extensive. The chief tributaries are the Sosna and North Donets on the right, and the Voronezh, Kholer, Medvedyitsa and Manych on the left. The Ylya, the Kuban and the Rion descend to Caucasus. The Dnepr flows for 46 m. over a series of rapids. At Kherson it enters its long (40 m.) but shallow estuary, which receives the S. Bug and the Ingul. The Don, with a basin of 166,000 sq. m., and navigable for 880 m., rises in the government of Tula and enters the Sea of Azov at Rostov, after describing a great curve to the E. at Tsaritsyn, approaching the Volga, with which it is connected by a railway (45 m.). Its navigation is of great importance, especially for goods brought from the Volga, and its fisheries are extensive. The chief tributaries are the Sosna and North Donets on the right, and the Voronezh, Kholer, Medvedyitsa and Manych on the left. The Ylya, the Kuban and the Rion descend to Caucasus. The Dnepr flows for 46 m. over a series of rapids. At Kherson it enters its long (40 m.) but shallow estuary, which receives the S. Bug and the Ingul. The Don, with a basin of 166,000 sq. m., and navigable for 880 m., rises in the government of Tula and enters the Sea of Azov at Rostov, after describing a great curve to the E. at Tsaritsyn, approaching the Volga, with which it is connected by a railway (45 m.). Its navigation is of great importance, especially for goods brought from the Volga, and its fisheries are extensive. The chief tributaries are the Sosna and North Donets on the right, and the Voronezh, Kholer, Medvedyitsa and Manych on the left. The Ylya, the Kuban and the Rion descend to Caucasus. The Dnepr flows for 46 m. over a series of rapids. At Kherson it enters its long (40 m.) but shallow estuary, which receives the S. Bug and the Ingul. The Don, with a basin of 166,000 sq. m., and navigable for 880 m., rises in the government of Tula and enters the Sea of Azov at Rostov, after describing a great curve to the E. at Tsaritsyn, approaching the Volga, with which it is connected by a railway (45 m.). Its navigation is of great importance, especially for goods brought from the Volga, and its fisheries are extensive. The chief tributaries are the Sosna and North Donets on the right, and the Voronezh, Kholer, Medvedyitsa and Manych on the left. The Ylya, the Kuban and the Rion descend to Caucasus. The Dnepr flows for 46 m. over a series of rapids. At Kherson it enters its long (40 m.) but shallow estuary, which receives the S. Bug and the Ingul. The Don, with a basin of 166,000 sq. m., and navigable for 880 m., rises in the government of Tula and enters the Sea of Azov at Rostov, after describing a great curve to the E. at Tsaritsyn, approaching the Volga, with which it is connected by a railway (45 m.). Its navigation is of great importance, especially for goods brought from the Volga, and its fisheries are extensive. The chief tributaries are the Sosna and North Donets on the right, and the Voronezh, Kholer, Medvedyitsa and Manych on the left. The Ylya, the Kuban and the Rion descend to Caucasus. The Dnepr flows for 46 m. over a series of rapids. At Kherson it enters its long (40 m.) but shallow estuary, which receives the S. Bug and the Ingul. The Don, with a basin of 166,000 sq. m., and navigable for 880 m., rises in the government of Tula and enters the Sea of Azov at Rostov, after describing a great curve to the E. at Tsaritsyn, approaching the Volga, with which it is connected by a railway (45 m.). Its navigation is of great importance, especially for goods brought from the Volga, and its fisheries are extensive. The chief tributaries are the Sosna and North Donets on the right, and the Voronezh, Kholer, Medvedyitsa and Manych on the left. The Ylya, the Kuban and the Rion descend to Caucasus. The Dnepr flows for 46 m. over a series of rapids. At Kherson it enters its long (40 m.) but shallow estuary, which receives the S. Bug and the Ingul. The Don, with a basin of 166,000 sq. m., and navigable for 880 m., rises in the government of Tula and enters the Sea of Azov at Rostov, after describing a great curve to the E. at Tsaritsyn, approaching the Volga, with which it is connected by a railway (45 m.). Its navigation is of great importance, especially for goods brought from the Volga, and its fisheries are extensive. The chief tributaries are the Sosna and North Donets on the right, and the Voronezh, Kholer, Medvedyitsa and Manych on the left. The Ylya, the Kuban and the Rion descend to Caucasus. The Dnepr flows for 46 m. over a series of rapids. At Kherson it enters its long (40 m.) but shallow estuary, which receives the S. Bug and the Ingul. The Don, with a basin of 166,000 sq. m., and navigable for 880 m., rises in the government of Tula and enters the Sea of Azov at Rostov, after describing a great curve to the E. at Tsaritsyn, approaching the Volga, with which it is connected by a railway (45 m.). Its navigation is of great importance, especially for goods brought from the Volga, and its fisheries are extensive. The chief tributaries are the Sosna and North Donets on the right, and the Voronezh, Kholer, Medvedyitsa and Manych on the left. The Ylya, the Kuban and the Rion descend to Caucasus. The Dnepr flows for 46 m. over a series of rapids. At Kherson it enters its long (40 m.) but shallow estuary, which receives the S. Bug and the Ingul. The Don, with a basin of 166,000 sq. m., and navigable for 880 m., rises in the government of Tula and enters the Sea of Azov at Rostov, after describing a great curve to the E. at Tsaritsyn, approaching the Volga, with which it is connected by a railway (45 m.). Its navigation is of great importance, especially for goods brought from the Volga, and its fisheries are extensive. The chief tributaries are the Sosna and North Donets on the right, and the Voronezh, Kholer, Medvedyitsa and Manych on the left. The Ylya, the Kuban and the Rion descend to Caucasus. The Dnepr flows for 46 m. over a series of rapids. At Kherson it enters its long (40 m.) but shallow estuary, which receives the S. Bug and the Ingul. The Don, with a basin of 166,000 sq. m., and navigable for 880 m., rises in the government of Tula and enters the Sea of Azov at Rostov, after describing a great curve to the E. at Tsaritsyn, approaching the Volga, with which it is connected by a railway (45 m.). Its navigation is of great importance, especially for goods brought from the Volga, and its fisheries are extensive. The chief tributaries are the Sosna and North Donets on the right, and the Voronezh, Kholer, Medvedyitsa and Manych on the left. The Ylya, the Kuban and the Rion descend to Caucasus. The Dnepr flows for 46 m. over a series of rapids. At Kherson it enters its long (40 m.) but shallow estuary, which receives the S. Bug and the Ingul. The Don, with a basin of 166,000 sq. m., and navigable for 880 m., rises in the government of Tula and enters the Sea of Azov at Rostov, after describing a great curve to the E. at Tsaritsyn, approaching the Volga, with which it is connected by a railway (45 m.). Its navigation is of great importance, especially for goods brought from the Volga, and its fisheries are extensive. The chief tributaries are the Sosna and North Donets on the right, and the Voronezh, Kholer, Medvedyitsa and Manych on the left. The Ylya, the Kuban and the Rion descend to Caucasus. The Dnepr flows for 46 m. over a series of rapids. At Kherson it enters its long (40 m.) but shallow estuary, which receives the S. Bug and the Ingul. The Don, with a basin of 166,000 sq. m., and navigable for 880 m., rises in the government of Tula and enters the Sea of Azov at Rostov, after describing a great curve to the E. at Tsaritsyn, approaching the Volga, with which it is connected by a railway (45 m.). Its

part, constitutes the frontier between European Russia and the Kirghiz steppe; it receives the Sakmara on the right and the Ilek on the left. The Kuma, the Terek and the Kura, with the Aras, which receives the waters of Lake Gok-cha, belong to Caucasia.¹

The soil of Russia depends chiefly on the distribution of the boulder-clay and loess, on the degree to which the rivers have severally excavated their valleys, and on the moistness of the climate. Vast areas in Russia are quite unfit for cultivation, 10% of the aggregate surface of European Russia (apart from Poland and Finland) being occupied by lakes, marshes, sand, &c., 39% by forests, 16% by prairies, and only 26% being under cultivation. The distribution of all these is, however, very unequal, and the five following subdivisions may be established:—(1) the tundras; (2) the forest region; (3) the middle region, comprising the surface available for agriculture and partly covered with forests; (4) the black-earth (*chernozomy*) region; and (5) the steppes. Of these the black-earth region—about 150,000,000 acres—which reaches from the Carpathians to the Urals, from the Pinsk marshes in the S.W. to the upper Oka in the N.E., is the most important. It is covered with a thick sheet of black earth, a kind of loess mixed with 5 to 15% of humus, due to the decomposition of an herbaceous vegetation, which developed luxuriantly during the Lacustrine period on a continent relatively dry even at that epoch. On the three-fields system corn has been grown upon it for fifty to seventy consecutive years without manure. Isolated black-earth islands, though less fertile, occur also in Courland and Kovno, in the Oka-Volga-Kama depression, on the slopes of the Urals, and in a few patches in the N. Towards the Black Sea coast its thickness diminishes, and it disappears in the valleys. In the extensive region covered with boulder-clay the black earth appears only in isolated places, and the soil consists of the most porous sand-clay containing a much smaller admixture of humus. There cultivation is possible only with the aid of a considerable quantity of manure. Drainage finding no outlet through the thick clay, the soil of the forest region is often hidden beneath extensive marshes, and the forests themselves are often mere thickets choking marshy ground; large tracts of sand appear in the W., and the admixture of boulders with the clay in the N.W. renders agriculture difficult. On the Arctic coast the forests disappear, giving place to the tundras. Finally, in the S.E., towards the Caspian, on the slopes of the southern Urals and the plateau of Obshchy Syrt, as far as 10° in the N., the steppes of the Crimea, and the Bessarabia, there are the largest tracts of real desert, buried under coarse sand and devoid of vegetation.

Notwithstanding the fact that Russia extends from N. to S. through 30° of latitude, the climate of its different portions, apart from the Crimea and Caucasia, presents a striking uniformity. The aerial currents—cyclones, anti-cyclones and dry S.E. winds—prevail over extensive areas, and sweep across the flat plains without hindrance. Everywhere the winter is cold and the summer hot, both varying in their duration, but differing relatively little in the extremes of temperature recorded. There is no place in Russia, Archangel and Astrakhan included, where the thermometer does not rise in summer nearly to 86° Fahr. and descend in winter to -13° and -22°. It is only on the Black Sea coast that the absolute range of temperature does not exceed 108°, while in the remainder of Russia it reaches 126° to 144°, the oscillations being between -22° and -31°, occasionally going down as low as -54°, and rising as high as 81° to 104°, or even 109°. Everywhere the rainfall is small: if Finland and Poland on the one hand and Caucasia with the Caspian depression on the other be excluded, the average yearly rainfall varies between 16 and 28 in. Nowhere does the maximum rainfall take place in winter (as in W. Europe), but it occurs in summer, and everywhere the months of advanced spring are warmer than the corresponding months of winter.

Though thus exhibiting the distinctive features of a continental climate, Russia does not lie altogether outside the reach of the moderating influence of the ocean. The Atlantic cyclones penetrate to the Russian plains, mitigating to some extent the cold of winter, and in summer bringing with them their moist winds and thunderstorms. Their influence is chiefly felt in W. Russia, though it does reach as far as the Urals and beyond. They thus check the extension and limit the duration of the cold anticyclones.

¹ Bibliography of Geography: see Tillo, in *Investia of Russian Geogr. Soc.* (1883); P. F. Semenov, *Geogr. and Statist. Dictionary of the Russian Empire* (in Russian), 5 vols., St. Petersburg, 1868-84; the most trustworthy source for the geography of Russia; the official *Soil Material*, with regard to Russian rivers (1876); Statistical *Shornik* of the Ministry of Communications, vol. x. (freezing of Russian rivers, and navigation). A great variety of monographs dealing with separate rivers and basins are available; e.g. S. Martynov, *Das Petchoragobiet* (St. Petersburg, 1905); G. von Helmersen, *Das Olonenskie Bergevier* (St. Petersburg, 1860); Turbin, *The Dnieper*; Prasolenko, "The Dniester," in *Engn. Journ.* (1881); Danilevsky, "Kuban," in *Mem. Geogr. Soc. i.*; K. E. von Baer, *Kaspische Studien* (St. Petersburg, 1857-59); V. Rasozin, *Volga* (St. Petersburg, 1890); Petryatkovich, *Volga*; and Kikhlov, *Kama*. An hydrographical map of Russia in four sheets was published in 1878.

Throughout Russia the winter is of long duration. The last days of frost are experienced for the most part in April, but as late as May to the N. of 55° N. The spring is exceptionally beautiful in central Russia; late as it usually is, it sets in with vigour, and vegetation develops with a rapidity which gives to this season in Russia a special charm, unknown in warmer climates. The rapid melting of the snow at the same time causes the rivers to swell, and renders a great many minor streams navigable for a few weeks. But a return of cold weather, injurious to vegetation, is very frequently observed in central and E. Russia between May the 18th and the 24th, so that it is only in June that warm weather sets in definitely, and it reaches its maximum in the first half of July (or of August on the Black Sea coast). In S.E. Russia the summer is much warmer than in the corresponding latitudes of France, and really hot weather is experienced everywhere. It does not, however, prevail for long, and in the first half of September frosts begin on the middle Urals. They descend upon W. and S. Russia in the beginning of October, and are felt on the Caucasus about the middle of November. The temperature drops so rapidly that a month later, about October the 10th on the middle Urals and November the 15th throughout Russia, the thermometer ceases to rise above the freezing-point. The rivers freeze rapidly; towards November 20th all the streams of the White Sea basin are ice-bound, and so remain for an average of 167 days; those of the Baltic, Black Sea and Caspian basins freeze later, but about December the 20th nearly all the rivers of the country are highways for sledges. The Volga remains frozen for a period varying between 150 days in the N. and 90 days at Astrakhan, the Don for 100 to 110 days, and the Dnieper for 83 to 122 days. On the W. Dvina ice prevents navigation for 125 days, and even the Ostrova at Warsaw remains frozen for 77 days. The lowest temperatures are experienced in January, the average being as low as 20° to 5° Fahr. throughout Russia; in the west only does it rise above 22°. On the whole, February and March continue to be cold, and their average temperatures rise above zero nowhere except on the Black Sea coast. Even at Kiev and Lugansk the average of March is below 30°, while in central Russia it is 25° to 22°, and as low as 20° and 16° at Samara and Orenburg.

All Russia is comprised between the isotherms of 32° and 54°. On the whole, they are more remote from one another than even on the plains of N. America, those of 46° to 32° being distributed over twenty degrees of latitude. They are, on the whole, inclined towards the S. in E. Russia, thus the isotherm of 30° runs from St. Petersburg to Orenburg, and that of 35° from Torné in Finland to Uralsk. The inflexion is still greater for the winter isotherms. Closely following one another, they run almost N. and S.; thus Odessa and Königsberg are situated on the same winter isotherm of 28°; St. Petersburg, Orel and the mouth of the Ural river on about 20°; and Mezei and Ufa on 9°. The summer isotherms cross the winter isotherms nearly at right angles, so that Kiev and Ufa, Warsaw and Tobolsk, Riga and the upper Kama have the same average summer temperatures of 64°, 62° and 61° respectively.

The laws and relations of the cyclones and anti-cyclones in Russia are not yet thoroughly understood. It appears, however, that in January the cyclones mostly travel across N.W. Russia (N. of 55° and W. of 40° E.), following directions which vary between N.E. and S.E. In July they are pushed farther towards the N., and cross the Gulf of Bothnia, while another series of cyclones sweep across middle Russia, between 50° and 55° N. Nor are the laws of the anti-cyclones established. The winds closely depend on the routes followed by both. Generally, however, it may be said that alike in January and in July W. and S.W. winds prevail in W. Russia, while E. winds are most common in S.E. Russia. E. winds are predominant on the Black Sea coast. The strength of the winds is greater on the whole, than in the continental parts of W. Europe, and it attains its maximum velocity in winter. Terrible tempests blow from October to March, especially on the S. steppes and on the tundras. Hurricanes accompanied with snow (*burans*, *myatels*), and lasting from two to three days, or N. blizzards without snow, are especially dangerous to man and beast. The average relative moisture reaches 80 to 85% in the N., and only 70 to 81% in S. and E. Russia. In the steppes it is only 60% during summer, and still less (57) at Astrakhan. The average amount of cloud is 73 to 75% on the White Sea and in Lithuania, 68 to 64 in central Russia, and only 59 to 53 in the S. and S.E. The amount of rainfall is shown in the Table on next page.

The flora of Russia, which represents an intermediate link between the flora of Germany and the flora of Siberia, is strikingly uniform over a very large area. Though not poor at any given place, it appears so if the space occupied by Russia be taken into account, only 3300 species of phanerogams and ferns

² Bibliography of Meteorology: *Memoirs of the Central Physical Observatory*; *Repertorium für Meteorologie und Meteorologische Shornik*, published by the same body; Verhelovsky, *Climate of Russia* (Russian); H. Wild, *Temperatur-Vershältnisse des Russ. Reiches* (1883); Vovyeikov, *The Climates of the Globe* (Russian, 1884), containing the best general information about the climate of Russia.

being known. Four regions may be distinguished: the Arctic, the Forest, the Steppe and the Circum-Mediterranean.

	North Latitude.	Height above Sea in Feet.	Average Temperatures.			Average Rainfall in Inches.	
			Year.	January.	July.	Year.	November to March.
Archangeł	64 34	30	32.7	7.6	60.6	16.2	4.3
Petrozavodsk	60 10	40	36.4	11.8	62.1	19.0	...
St. Petersburg	59 57	40	39.0	19.5	61.5	19.6	7.3
Bogolovsk	59 45	630?	38.4	15.0	64.0	18.3	5.3
Dorpat	58 22	220	39.5	17.6	63.1	15.8	3.1
Kostroma	57 46	360	37.3	9.4	66.3	24.9	7.3
Ekaterinburg	56 49	890	32.8	2.2	63.5	14.1	1.6
Kazań	55 47	260	37.2	7.0	67.3	18.0	5.4
Moscow	55 45	520	39.0	12.1	66.0	23.0	7.3
Vilna	54 41	390	43.8	22.1	65.6
Warsaw	52 14	360	44.9	23.8	65.4	22.8	6.7
Orenburg	51 45	360	37.9	4.7	70.9	17.1	5.8
Kursk	51 44	690	41.0	13.7	67.2	19.9	5.6
Kiev	50 27	594	44.8	16.0	66.0	20.1	6.0
Tsaritsyn	48 42	1000	44.0	13.4	74.0
Lugansk	48 27	200	45.6	17.0	73.0	14.3	4.3
Odessa	46 29	270	49.0	24.8	72.3	15.6	5.4
Astrakhan	46 21	-70	49.0	19.2	77.9	5.7	1.5
Sevastopol	44 37	130	53.7	35.2	73.8	15.4	7.2
Poti	42 9	0	58.4	39.0	73.3	64.9	23.4
Tiflis	41 42	1440	54.5	33.0	75.7	19.3	4.3

The Arctic Region comprises the tundras of the Arctic littoral beyond the N. limit of the forests, which closely follows the coastline, with deviations towards the N. in the river valleys (70° N. in Finland and on the Arctic Circle about Archangel, 68° N. on the Ural, 71° in W. Siberia). The shortness of the summer, the deficiency of drainage and the depth to which the soil freezes in winter, are the circumstances which determine the characteristic features of the vegetation of the tundras. Their flora is far closer akin to the floras of N. Siberia and N. America than to that of central Europe. Mosses and lichens are distinctive, as also are the birch, the dwarf willow and several shrubs; but where the soil is drier, and humus has been able to accumulate, a variety of herbaceous flowering plants, some of them familiar in W. Europe, make their appearance. Only 275 to 280 phanerogams are found within this region.

The Forest Region of the Russian botanists includes the greater part of the country, from the Arctic tundras to the steppes, and over this immense expanse it maintains a remarkable uniformity of character. Beketov subdivides it into two portions—the forest region proper and the "Ante-Steppe" (*predstepie*). The N. limit of the ante-steppe is represented by a line drawn from the Pruth through Zhitomir, Kursk, Tambov and Stavropol-on-Volga to the sources of the Ural river. But the forest region proper presents a different aspect in the N. from that in the S., and must in turn be subdivided into two parts—the coniferous region and the region of the oak forests—these being separated by a line drawn through Pskov, Kostroma, Kazań and Ufa. Of course the oak occurs farther N. than this, and coniferous forests extend farther S., advancing even to the border-region of the steppes. To the N. of this line the forests are of great extent and densely grown, more frequently diversified by marshes than by meadows or cultivated fields. Vast and impenetrable forests, impassable marches and thickets, numerous lakes, swampy meadows, with cleared and dry spaces here and there occupied by villages, are the leading features of this region. Fishing and hunting are the most important sources of livelihood. The characteristics of the oak region, which comprises all central Russia, are totally different. The surface is undulating; marshy meadow lands no longer exist on the flat watersheds, and only a few in the deeper and broader river valleys. Forests are still numerous where they have not been destroyed by the hand of man, but their character has changed. Conifers are rare, and the Scotch pine, which is abundant on the sandy plains, takes the place of the *Abies*. The forests are composed of the birch, oak and other deciduous trees, the soil is dry, and the woodlands are divided by green prairies. Viewed from rising ground, the landscape presents a pleasing variety of cornfield and forest, while the horizon is broken by the tall towers of the numerous villages strung along the banks of the streams.

Viewed as a whole, the flora of the forest region is to be regarded as European-Siberian; and, though certain species disappear towards the E., while new ones make their appearance, it maintains, on the whole, the same features throughout from Poland to Kamchatka. Thus the beech (*Fagus sylvatica*) is unable to survive the continental climate of Russia, and does not penetrate beyond Poland and the S.W. provinces, reappearing again in the Crimea. The silver fir does not extend over Russia, and the oak does not

cross the Urals. On the other hand, several Asiatic species (Siberian pine, larch, cedar) grow freely in the N.E., while numerous shrubs and herbaceous plants, originally from the Asiatic steppes, have found their way into the S.E. But all these do not greatly alter the general character of the vegetation. The coniferous forests of the north contain, besides conifers, the birch (*Betula alba*, *B. pubescens*, *B. fruticosa* and *B. verrucosa*), which extends from the Pechora to the Caucasus, the aspen, two species of alder, the mountain-ash (*Sorbus aucuparia*), the wild cherry, and three species of willow. S. of 62°-64° N. appears the lime tree, which multiplies rapidly and, notwithstanding the rapidity with which it is being exterminated, constitutes entire forests in the east (central Volga, Ufa). Farther S. the ash (*Fraxinus excelsior*) and the oak make their appearance, the latter (*Quercus pedunculata*) reaching in isolated groups and single trees as far N. as St. Petersburg and South Finland (*Q. Robur* appears only in the S.W.). The hornbeam is prevalent in the Ukraine, and the maple begins to appear in the S. of the coniferous region. In the forest region no fewer than 772 flowering species are found, of which 568 dicotyledons occur in the Archangel government (only 436 to the E. of the White Sea, which is a botanical limit for many species). In central Russia the species become still more numerous, and, though the local floras are not yet complete, they number 850 to 1050 species in the separate governments, and about 1600 in the best explored parts of the S.W. Corn is cultivated throughout this region. Its N. limits advance almost to the Arctic coast at Varanger Fjord, farther E. they hardly reach N. of Archangel, and the limit is still lower towards the Urals. The N. boundary of rye closely corresponds to that of barley. Wheat is cultivated in S. Finland, but in W. Russia it hardly gets N. of 58° N. Its true domains are the oak region and the steppes. Fruit trees are cultivated as far as 62° N. in Finland, and as far as 58° in the E. Apricots and walnuts flourish at Warsaw, but in Russia they do not thrive beyond 50°. Apples, pears and cherries are grown throughout the oak region.

The Region of the Steppes, which is coincident with the whole of S. Russia, may be subdivided into two zones—an intermediate zone and that of the steppes proper. The ante-steppe of the preceding region and the intermediate zone of the steppes include those tracts where the European climate contends against the Asiatic, and where a struggle is carried on between the forest and the steppe. It is comprised between the summer isotherms of 59° and 63°, being bounded on the S. by a line which runs through Ekaterinoslav and Lugansk. S. of this line begin the steppes proper, which extend to the sea and penetrate to the foot of the Caucasus. The steppes proper are very fertile, elevated plains, slightly undulating, and intersected by numerous ravines which are dry in summer. The undulations are scarcely apparent. Not a tree is to be seen, the few woods and thickets being hidden in the depressions and deep valleys of the rivers. The soil is the black earth by which the steppe is covered a luxuriant vegetation develops in spring; after the old grass has been burned a bright green prevails over immense stretches, but this rapidly disappears under the burning rays of the sun and the hot E. winds. The colouring of the steppe changes as if by magic, and only the silvery plumes of the steppe-grass (*Stipa pennata*) wave in the wind, tinting the steppe a bright yellow. For days together the traveller sees no other vegetation; even this, however, disappears as he approaches the regions recently left dry by the Caspian, where saline clays, bearing a few *Salicaceae*, or green sand, make the place of the black earth. Here begins the Anti-Caspian desert. The steppe, however, is not so devoid of trees as at first sight appears. Innumerable clusters of wild cherries (*Prunus Chamaecerasus*), wild apricots (*Amygdalus nana*), the Siberian pea-tree (*Caragana frutescens*), and other deep-rooted shrubs grow at the bottoms of the depressions and on the slopes of the ravines, imparting to the steppe that charm which manifests itself in the popular poetry. Unfortunately the spread of cultivation is fatal to these oases (they are often called "islands" by the inhabitants); the axe and the plough ruthlessly destroy them.

The vegetation in the marshy bottoms of the ravines and in the valleys of the streams and rivers is totally different. The moist soil encourages luxuriant thickets of willows (*Salicaceae*), surrounded by dense *chevoux-de-frise* of wormwood and thorn-bearing Compositae, and interspersed with rich but not extensive prairies, harbouring a great variety of herbaceous plants; while in the deltas of the Black Sea rivers impenetrable beds of reeds (*Arundo phragmites*) shelter a forest fauna. But cultivation rapidly changes the physiognomy of the steppe. The prairies are superseded by wheat-fields, and flocks of sheep destroy the true steppe-grass (*Stipa pennata*).

A great many species unknown in the forest region make their appearance in the steppes. The Scotch pine still grows on all sandy spaces, and the maple (*Acer tatarica* and *A. campestre*), the hornbeam and the black and white poplar are very common. The number of species of herbaceous plants rapidly increases, while beyond the Volga a variety of Asiatic species are added to the W. European flora.

The Circum-Mediterranean Region is represented by a narrow

strip on the S. coast of the Crimea, where a climate similar to that of the Mediterranean coast has permitted the development of a flora closely resembling that of the valley of the Arno in Italy. Human cultivation has destroyed the abundant forests which sixty years ago made deer-hunting possible at Kherstones. The olive and the chestnut are rare; but the beech reappears, and the *Pinus pinaster* recalls the Italian pines. At a few points, such as Nikita near Livadia and Alupka, where plants have been acclimatized by human agency, the Californian *Wellingtonia*, the Lebanon cedar, many evergreen trees, the laurel, the cypress, and even the Anatolian palm (*Chamaerops excelsa*) flourish. The grass vegetation is very rich, and, according to lists still incomplete, no fewer than 1654 flowering plants are known. But on the whole, the Crimean flora has little in common with that of the Caucasus.¹

Flora belonging to the same zoogeographical region as central Europe and N. Asia, the same fauna existing in Siberia as far as the Yenisei and the Lena. In the forests not many animals which have disappeared from W. Europe have held their ground; while in the Urals only a few—now Siberian, but formerly also European—are met with. In S.E. Russia, however, towards the Caspian, there is a notable admixture of Asiatic species. Three separate sub-regions may, however, be distinguished on the E. European plains—the tundras, including the Arctic islands, the forest region, especially the coniferous part of it, and the ante-steppe and steppes of the black earth region. The Ural Mountains might be distinguished as a fourth sub-region, while the S. coast of the Crimea and Caucasia, as well as the Caspian deserts, have each their own individuality.

The fauna of the Caspian Ocean off the Norwegian coast corresponds, in its W. parts at least, to that of the N. Atlantic Gulf Stream. The White Sea and the Arctic Ocean to the E. of Svaytoi Nos on the Kola peninsula belong to a separate zoological region, connected with, and hardly separable from, that part of the Arctic Ocean which washes the Siberian coast as far as the mouth of the Lena. The Black Sea, the fauna of which appears to be very rich, belongs to the Mediterranean region, slightly modified, while the Caspian partakes of the characteristic fauna inhabiting the lakes and seas of the Aral-Caspian depression.

In the region of the tundras life has to contend with such unfavourable conditions that it cannot be abundant. Still, the reindeer frequents it for its lichens, and on the drier slopes of the moraine deposits there occur four species of lemming, hunted by the Arctic fox (*Vulpes lagopus*). The willow-grouse (*Lagopus albus*), the ptarmigan (*L. lagopus mutans*), the lark, the snow-bunting (*Plectrophenax nivalis*), two or three species of *Sylvia*, the *Phylloscopus* and a *Motacilla* must be added. Numberless aquatic birds visit it for breeding purposes. Ducks, divers, geese, gulls, all the Russian species of snipes and sandpipers (*Limicolae*, *Tringae*), &c., swarm on the marshes of the tundras and on the crags of the Lapland coast.

The forest region, and especially its coniferous portion, though it has lost some of its representatives within historic times, still possesses an abundant fauna. The reindeer, rapidly disappearing, is now met with only in the governments of Olonets and Volodga; *Cervus pygargus* is found everywhere, and reaches Novgorod. The weasel, the fox and the hare are exceedingly common, as also are the wolf and the bear in the N., but the glutton (*Gulo borealis*), the lynx and the elk (*C. alces*) are rapidly disappearing. The wild bear is confined to the basin of the W. Dvina, and the *Bison europæa* to the Byelovezh forest in Grodno. The sable has quite disappeared, being found only on the Urals; the beaver may be trapped at a few places in Minsk, and the otter is very rare. On the other hand, the hare, grey partridge (*Perdix cinerea*), hedgehog, quail, lark, rook and stork find their way into the coniferous region as the forests are cleared. The avifauna of this region is very rich; it includes all the forest and garden birds known in W. Europe, as well as a very great variety of aquatic birds. A list, still incomplete, of the birds of St Petersburg runs to 251 species. Hunting and shooting give occupation to a great number of persons. The reptiles are few. As for fishes, all those of W. Europe, except the carp, are met with in the lakes and rivers in immense quantities, the characteristic feature of the region being its wealth in *Coregoni* and in Salmonidae generally.

In the ante-steppe the forest species proper, such as *Pteromys volans* and *Tamias striatus*, disappear, but common squirrel (*Sciurus vulgaris*), weasel and bear are still met with in the forests. The hare is increasing rapidly, as well as the fox. The avifauna, of course, becomes poorer; nevertheless, the woods of the steppe, and still more the forests of the ante-steppe, give refuge to many

birds, even to hazel-hen (*Tetrao bonasa*), capercaillie (*T. tetrix*) and woodcock (*T. urogallus*). The fauna of the scrub in the river valleys is decidedly rich, and includes aquatic birds. The destruction of the forests and the advance of wheat into the prairies are rapidly thinning the steppe fauna. The various species of rapacious animals are disappearing, together with the colonies of marmots; the insectivores are also becoming scarce in consequence of the destruction of insects; while vermin, such as the musk, or pouched marmot (*Spermophilus*), and the destructive insects which are a scourge to agriculture, become a real plague. The absence of *Coregoni* is a characteristic feature of the fish-fauna of the steppes; the carp, on the contrary, reappears, and the rivers abound in sturgeon (*Acipenseridae*). In the Volga below Nizhnyi-Novgorod the sturgeon (*Acipenser ruthenus*), and others of the same family, as well as a very great variety of ganoids and Teleostei, appear in such quantities that they give occupation to nearly 100,000 people. The mouths of the Caspian rivers are especially celebrated for their wealth of fish.²

Ethnography.—Remains of Palaeolithic man, contemporary with the large Quaternary mammals, are few in Russia; they have been discovered only in Poland, Pottava and Voronezh, and perhaps also on the Oka. Those of the later Lacustrine period, on the contrary, are so numerous that there is scarcely one lacustrine basin in the regions of the Oka, the Kama, the Dnieper, not to speak of the lake-region itself, and even the White Sea coasts, where remains of Neolithic man have not been discovered. The Russian plains have been, however, the scene of so many migrations of successive races, that at many places a series of deposits belonging to widely distant epochs are found one upon another. Settlements belonging to the Stone age, and manufactories of stone implements, burial-grounds of the Bronze epoch, earthen forts and burial-mounds (*kurgans*)—of this last four different types are known, the earliest belonging to the Bronze period—are superposed, rendering the task of unravelling their several relations one of great difficulty.

Two different races—a brachycephalic and a dolichocephalic—can be distinguished among the remains of the earlier Stone period (Lacustrine period) as having inhabited the plains of E. Europe. But they are separated by so many generations from the earliest historic times that sure conclusions regarding them are impossible; at all events, as yet Russian archaeologists are not agreed as to whether the ancestors of the Slavs were Sarmatians only or Scythians also, whose skulls have nothing in common with those of the Mongol race. The earliest *dota* which may be regarded as established belong to the 1st century, when the Finns migrated from the N. Dvina region towards the W., and the Sarmatians were compelled to abandon the region of the Don, and cross the Russian steppes from E. to W., under the pressure of the Aorzes (the Mordvinian Erzya) and Siraks, who in their turn were soon followed by the Huns and Uigur-Turkish Avars.

In the 7th century S. Russia was the seat of the empire of the Khazars, who drove the Bulgarians, descendants of the Huns, from the Don, one section of them migrating up the Volga to found there the Bulgarian empire, and the remainder travelling towards the Danube. This migration compelled the N. Finns to advance farther W., and a body of intermingled Tavastians and Karelians penetrated to the S. of the Gulf of Finland.

² Bibliography of Fauna: see Pallas, *Zoographia Rosso-Asiatica*; Sievertsov for the birds of south-eastern Russia; M. A. Bogdanov, *Birds and Mammals of the Black-Earth Region of the Volga Basin* (in Russian, Kazan, 1871); Karelin for the southern Urals; Kessler for fishes; Strauch, *Die Schlangen des Russ. Reiches*, for reptiles generally; Rodoszkowski and the publications of the Entomological Society generally for insects; Czerniavsky for the marine fauna of the Black Sea; Kessler for that of Lakes Onega and Ladoga; Grimm for the Caspian. The fauna of the Baltic provinces is described in full in the *Memoirs of the scientific bodies of these provinces*. A. T. von Middendorff's *Sibirische Reise*, vol. iv., *Zoology* (St Petersburg, 1875), though dealing more especially with Siberia, is an invaluable source of information for the Russian fauna generally. A. E. Nordenskiöld's *Vega-expeditionens Vetenskapliga Iakttagelser* (5 vols. Stockholm, 1872-87) may be consulted for the mammals of the tundra region and marine fauna. For more detailed bibliographical information see *Aperçu des travaux zoologiques*, published at St Petersburg in connexion with the Exhibition of 1878; and the index *Ukazatel Russkoi Literatury* for natural science, mathematics and medicine, published since 1872 by the Society of the Kiev University.

¹ Bibliography of Flora: Beketov, appendix to Russian translation of Grisebacht and Reclus's *géogr. univ.*; C. F. von Ledebour, *Flora Rossica* (Stuttgart, 1842-53); E. von Trautvetter, *Rossische Arctische Pflanzen* (1880); and *Flora Rossicae Fontes* (St Petersburg, 1880). For flora of the tundras, Beketov's "Flora of Archangel, in *Mem. Soc. Natur.* of St Petersburg University, xv. (1884); Regel, *Flora Rossica* (1884); Brown, *Forestry in the Mining Districts of the Urals* (1885); *Repositis* by Commissioners of Woods and Forests in Russia (1884).

As early as the 8th century, and probably still earlier, a stream of Slav colonization, advancing E. from the Danube, poured over the plains of S.W. Russia. It is also most probable that another similar stream—the N., coming from the Elbe, through the basin of the Vistula—ought to be distinguished. In the 9th century the Slavs occupied the upper Vistula, the S. of the Russian lacustrine region, and the W. of the central plateau. They had Lithuanians to the W.; various Finnish tribes, intermingled towards the S.E. with Turkish (the present Bashkirs); the Bulgars, whose origin still remains doubtful, on the middle Volga and Kama; and to the S.E. the Turkish-Mongol races of the Pechenegs, Polovtzi, Uzes, &c., while in the S., along the Black Sea, was the empire of the Khazars, who had under their rule several Slav tribes, and perhaps also some of Finnish origin. In the 9th century also the Ugrians are supposed to have left their Ural abodes and to have traversed S.E. and S. Russia on their way to the basin of the Danube. If the Slavs be subdivided into three branches—the W. (Poles, Czechs and Wends), the S. (Servians, Bulgarians, Croatsians, &c.), and the E. (Great, Little and White Russians), it will be seen that, with the exception of some 3,000,000 Little Russians, now settled in East Galicia and in Poland, and of a few on the southern slope of the Carpathians, the whole of the E. Slavs occupy, as a compact body, W., central and S. Russia.

Like other races of mankind, the Russian race is not pure. The Russians have absorbed and assimilated in the course of their history a variety of Finnish and Turko-Finnish elements. Still, craniological researches show that, notwithstanding this fact, the Slav type has been maintained with remarkable persistency: Slav skulls ten and thirteen centuries old exhibit the same anthropological features as those which characterize the Slavs of our own day. This may be explained by a variety of causes, of which the chief is the maintenance by the Slavs down to a very late period of gentile or tribal organization and gentile marriages, a fact vouched for, not only in the pages of the Russian chronicler Nestor, but still more by visible social evidences, the *gens* later developing into the village community, and the colonization being carried on by large co-ordinated bodies of people. The Russians do not emigrate as isolated individuals; they migrate in whole villages. The overwhelming numerical superiority of the Slavs, and the very great differences in ethnical type, belief and mythology between the Indo-European and the Ural-Altaic races, may have contributed to the same end. Moreover, while a Russian man, far away from home among Siberians, readily marries a native, the Russian woman seldom does the like. All these causes, and especially the first-mentioned, have enabled the Slavs to maintain their ethnical purity in a relatively high degree, whereby they have been enabled to assimilate foreign elements and make them intensify or improve the ethnical type, without giving rise to half-breed races. The very same N. Russian type has thus been maintained from Novgorod to the Pacific, with but minor differentiations on the outskirts—and this notwithstanding the great variety of races with which the Russians have come into contact. But a closer observation of what is going on in the recently colonized confines of the empire—where whole villages live without mixing with the natives, but slowly bringing them over to the Russian manner of life, and then slowly taking in a few female elements from them—gives the key to this feature of Russian life.

Not so with the national customs. There are features—the wooden house, the oven, the bath—which the Russian never abandons, even when swamped in an alien population. But when settled among these the Russian—the N. Russian—readily adapts himself to many other differences. He speaks Finnish with Finns, Mongolian with Buriats, Ostiak with Ostiaks; he shows remarkable facility in adapting his agricultural practices to new conditions, without, however, abandoning the village community; he becomes hunter, cattle-breeder or fisherman, and carries on these occupations according to local usage; he modifies his dress and adapts his religious beliefs to the locality he inhabits. In consequence of all this,

the Russian peasant (not, be it noted, the trader) proves himself to be an excellent colonist.

Three different branches can be distinguished among the Russians from the dawn of their history;—the Great Russians, the Little Russians (Malorusses or Ukrainians), and the White Russians (the Byelorusses). These correspond to the two currents of immigration mentioned above—the N. and S., with perhaps an intermediate stream, the proper place of the White Russians not having been as yet exactly determined. The primary distinctions between these branches have been increased during the last nine centuries by their contact with different nationalities—the Great Russians absorbing Finnish elements, the Little Russians undergoing an admixture of Turkish blood, and the White Russians submitting to Lithuanian influence. Moreover, notwithstanding the unity of language, it is easy to detect among the Great Russians themselves two separate branches, differing from one another by slight divergences of language and type and deep diversities of national character—the Central Russians and the Novgorodians. The latter extend throughout N. Russia into Siberia. Many minor anthropological differentiae can be distinguished among both the Great and the Little Russians, depending probably on the assimilation of various minor subdivisions of the Ural-Altians.

The Great Russians occupy in one compact mass the space enclosed by a line drawn from the White Sea to Lake Pskov, the upper courses of the W. Dvina and the Donets, and thence, through the mouth of the Sura, by the Vetluga, to the Mezei. To the E. of this boundary they are intermingled with Turko-Finns, but in the Ural mountains they reappear in a second compact body, and thence extend through S. Siberia and along the courses of the Lena and the Amur. Great Russian Nonconformists are disseminated among Little Russians in the governments of Chernigov and Mogilev, and they reappear in greater masses in Novorossia (*i.e.* S. Russia), as also in N. Caucasia.

The Little Russians occupy the steppes of S. Russia, the S.W. slopes of the central plateau and those of the Carpathian and Lublin mountains, and the Carpathian plateau, that is, the governments of Podolia, Volhynia, Poltava, and Kiev. The Zaporozhian Cossacks colonized the steppes farther E., towards the Don, where they met with a large population of Great Russian runaways, constituting the present Don Cossacks. The Zaporozhian Cossacks, sent by Catherine II. to colonize the E. coast of the Sea of Azov, constituted there the Black Sea and later the Kuban Cossacks (part of whom, the Nekrasovs, migrated to Turkey). They have also peopled large parts of the governments of Stavropol and of N. Caucasia.

The White Russians, intermingled with some extent with the Little Russians, Poles and Lithuanians, occupy the upper parts of the W. slope of the central plateau.

The Finnish races, which in prehistoric times extended from the Ob all over N. Russia, even then were subdivided into Ugrians, Permyaks, Bulgarians and Finns proper, who drove back the previous Lapp population from what is now Finland, and about the 7th century penetrated to the S. of the Gulf of Finland, in the region of the Livs and Kurs, where they fused to some extent with the Lithuanians and the Letts. At present the races of Finnish origin are represented in Russia by the following: (a) the W. Finns; the Tavassars in central Finland; the Kvaens, in N.W. Finland; the Karelians, in the E., who also occupy the lake regions of Olonets and Archangel, and have settlements in Novgorod and Tver; the Izhores, on the Neva and the S.E. coast of the Gulf of Finland; the Esths, in Esthonia and the N. of Livonia; the Livs, on the Gulf of Riga; and the Kurs, intermingled with the Letts; (b) the N. Finns, or Lapps, in N. Finland and on the Kola peninsula, and the Samoyedes in Archangel and W. Siberia; (c) the Volga Finns, or rather the old Bulgarian branch, of which belong the Mordvians, and the Cheremissians in Kazan, Kostroma and Vyatka, though they are classified by some authors with the following; (d) the Permyaks, or Cis-Uralian Finns, including the Votjaks on the upper Vyatka, the Permyaks in Perm, the Stryenyans or Zyryans in Volodga, Archangel, Vyatka and Perm; (e) the Ugrians, or Trans-Uralian Finns, including the Voguls on both slopes of the Urals, the Ostiaks in Tobolsk and partly in Tomsk, and the Magyars, or Ugrians.

The following are the chief subdivisions of the Turko-Tatars in European Russia:—(1) The Tatars, of whom three different branches must be distinguished: (a) the Kazan Tatars on both banks of the Volga, below the mouth of the Oka, and on the lower Kama, but penetrating farther S. in Ryazan, Tambov, Samara, Simbirsk and Penza; (b) the Tatars of Astrakhan at the mouth of the Volga; and (c) those of the Crimea, a great many of whom emigrated to Turkey after the Crimean War (1854–56). There are, besides, a certain number of Tatars in the S.E. in Minsk, Grodno and Vilna. (2) The Bashkirs, who inhabit the slopes of the S. Urals, that is, the steppes of Ufa and Orenburg, extend also into Perm and Samara. (3) The Chuvashes, on the right bank of the Volga, in Kazan and Simbirsk. (4) The Meshcheryaks, a tribe of Finnish origin who formerly inhabited the basin of the Oka, and, driven thence during the 15th century by the Russian colonists, immigrated into Ufa and Perm, where they now live among the Bashkirs, having adopted their religion and customs. (5) The Teptyars, also of Finnish origin,

settled among the Tatars and Bashkirs in Samara and Vyatka. The Bashkirs, Meshcheryaks and Teptyars rendered able service to the Russian government against the Khirgiz, and until 1863 they constituted a separate Cossack army. (6) The Khirgiz, whose true abodes were in Asia, in the Ishim and Kirgiz steppe. One section of them crossed the Urals and occupied the steppes between the Urals and the Volga; the remainder belong to Turkestan and Siberia.

The Mongol race is represented in Russia by the Kalmucks, who inhabit the steppes of Astrakhan between the Volga, the Don and the Kuma. They are Lamaists by religion and immigrated to the mouth of the Volga from Dzungaria, in the 17th century, driving out the Tatars and Nogais, and after many wars with the Don Cossacks, one part of them was taken in by the Don Cossacks, so that even now there are among these Cossacks several Kalmuck *totmas* or squadrons. They live for the most part in tents, and support themselves by breeding live stock, and partly by agriculture.

The Semitic race is represented by upwards of 5,000,000 Jews. They first entered Poland from Germany during the era of the crusades, and soon spread through Lithuania, Courland, the Ukraine, and, in the 18th century, Bessarabia. The rapidity with which they peopled certain towns (e.g. Odessa) and where they prove really prodigious. The law of Russia prohibits them from entering Great Russia, only the wealthiest and best educated enjoying this privilege; nevertheless they are met with everywhere, even on the Urals. Their chief abodes, however, continue to be Poland, the W. provinces of Lithuania, White and Little Russia, and Bessarabia. In Russian Poland they constitute 13½% of the total population. In Kovno, Vilna, Mogilev, Grodno, Volhynia, Podolia, Minsk, Vitebsk, Kiev, Bessarabia and Kherson, they constitute, on the average, 12 to 17½% of the population, while in the cities and towns of these governments they reach 30 to 50% of the population. Organized as they are into a kind of community for mutual protection and mutual help, they soon become masters of the trade wherever they penetrate. In the villages they are mostly innkeepers, intermediaries in trade and pawnbrokers. In many towns most of the skilled labourers and a great many of the unskilled (for instance, the grain-porters at Odessa and elsewhere) are Jews.

The Jews of the Karaitic sect differ entirely from the orthodox Jews both in worship and in mode of life. They, too, are inclined to trade, but they also carry on agriculture successfully. Those inhabiting the Crimea speak Tatar, and the few who are settled in W. Russia speak Polish. They are on good terms with the Russians.

In W. Europeans, the Germans only attain considerable numbers in European Russia. In the Baltic provinces they constitute the ennobled landlord class, and are the tradesmen and artisans in the towns. Considerable numbers of Germans, tradesmen and artisans, settled at the invitation of the Russian government in many of the larger towns as early as the 16th century, and to a much greater extent in the 18th century. Numbers were invited in 1762 to settle in S. Russia, as separate agricultural colonies, and these have since then gradually extended into the Don region and N. Caucasus. Protected as they were by the right of self-government, exempted from military service, and endowed with considerable allotments of good land, these colonies are much wealthier than the neighbouring Russian peasants, from whom they have adopted the slowly modified village community. They are chiefly Lutherans, but many of them belong to other religious sects—Anabaptists, Moravians, Mennonites. During the closing years of the 19th century great numbers of Germans flocked into the industrial governments of Poland, namely, Piotrkow, Warsaw and Kalisz.

The Rumanians (Moldavians) inhabit the governments of Bessarabia, Podolia, Kherson and Ekaterinoslav. In Bessarabia they constitute from one-fourth to three-fourths of the population of certain districts, and nearly 50% of the entire population of the government. On the whole the Novossian governments (Bessarabia, Kherson, Ekaterinoslav and Taurida) exhibit the greatest variety of population. Little and Great Russians, Rumanians, Bulgarians, Germans, Greeks, Frenchmen, Poles, Tatars and Jews are mingled together and scattered about in small colonies, especially in Bessarabia. The Greeks inhabit chiefly the towns, where they are traders, as also do the Armenians, scattered through the towns of S. Russia, and appearing in larger numbers only in the district of Rostov.

The Lithuanians prevail in Kovno, Vilna and Suwalki; and the Letts, who are, however, more scattered, are chiefly concentrated in Vitebsk, Courland and Livonia.

In the Baltic provinces (Esthonia, Livonia and Courland) the prevailing population is Esthonian, Kuroonian or Lettish, the Germans being respectively only 2.8, 7.6 and 8.2% of the population. The relations of the Esths and Letts with their landlords are anything but friendly.

The governments of St Petersburg (apart from the capital), Olonets and Archangel contain an admixture of Karelians, Samoyedes and Syryenians, the remainder being Great Russians. In the E. and S.E. provinces of the Volga (Nizhny-Novgorod, Simbirsk, Samara, Penza and Saratov) the Great Russians prevail, the remainder being chiefly Mordvians, Tatars, Chuvashes and

Bashkirs, Germans in Samara and Saratov, and Little Russians in the last named. In the Ural governments of Perm and Vyatka Great Russians are in the majority, the remainder being a variety of Finno-Tatars. In the S. Ural governments (Uralsk, Orenburg, Ufa) the admixture of Turko-Tatars—of Kirgiz in Uralsk, Bashkirs in Orenburg and Ufa, and less important races—becomes considerable.

The state religion is that of the Orthodox Greek Church (Orthodox Catholic or Orthodox Eastern Church). Its head is the tsar; but although he makes and annuls all appointments, he does not determine questions of dogmatic theology. The principal ecclesiastical authority is the Holy Synod, the head of which, the Procurator, is one of the council of ministers and exercises very wide powers in ecclesiastical matters. In theory all religions may be freely professed, except that certain restrictions, such as domicile,¹ are laid upon the Jews; but in actual fact the dissenting sects are more or less severely treated. According to returns published in 1903 the adherents of the different religious communities in the whole of the Russian empire numbered approximately as follows, though the heading Orthodox Greek includes a very great many *Raskolniki* or Dissenters. Indeed it is estimated that there are more than 12,000,000 Dissenters in Great Russia alone.

Orthodox Greek	87,123,600
Dissenters	2,204,600
Armenian Gregorians	1,179,240
Armenian Catholics	38,840
Roman Catholics	11,468,000
Lutherans	3,572,650
Reformed	85,400
Baptists	38,140
Mennonites	66,560
Anglicans	4,180
Other Christians	3,950
Karaitic Jews	12,900
Jews	5,215,800
Mahomedans	13,907,000
Buddhists	433,860
Other non-Christians	285,300
Total	125,640,020

The ecclesiastical heads of the national Orthodox Greek Church consist of three metropolitans (St Petersburg, Moscow, Kiev), fourteen archbishops and fifty bishops, all drawn from the ranks of the monastic (celibate) clergy. The parochial clergy are celibate in so far as they must be married when appointed, but if left widowers may not marry again.

All Russians, with the exception of a number of White Russians who belong to the United Greek Church (see ROMAN CATHOLIC CHURCH), profess the Orthodox Greek faith or belong to one or other of the numberless dissident sects. The Poles and most of the Lithuanians are Roman Catholics. The Esths and all other Western Finns, the Germans and the Swedes are Protestant. The Tatars, Bashkirs and Kirgiz are Mahomedans; but the last-named have to a great extent maintained along with Mahomedanism their old Shamanism. The same holds good of the Meshcheryaks, both Moslem and Christian. The Mordvians are nearly all Orthodox Greek, as also are the Votyaks, Voguls, Cheremisses and Chuvashes, but their religions are, in reality, modifications of Shamanism under the influence of some Christian and Moslem beliefs. The Moguls, though baptized, are in fact believers in fetishism as much as the unconverted Samoyedes. Finally, the Kalmucks are Lamaite Buddhists.

In his relations with Moslems, Buddhists and even fetishists the Russian peasant looks rather to conduct than to creed, the latter being in his view simply a matter of nationality. Indeed, towards paganism, at least, he is perhaps even more than tolerant, preferring on the whole to keep on good terms with pagan divinities. The numerous outbreaks against the Jews are directed, not against their creed, but against them as keen business men and extortionate money-lenders. Any idea of proselytism is quite foreign to the ordinary Russian mind, and the outbursts of proselytizing zeal occasionally manifested by the clergy are really due to the desire for "Russification," and traceable to the influence of the higher clergy and of the government.

¹ The restrictions on domicile were to some extent relaxed in the beginning of 1907.

It is this political rather than religious spirit which also underlies the repressive attitude of the government, and of the Orthodox Church as the organ of the government, towards the various dissident sects (*Raskolniki*, from *raskol*, schism), which for more than two centuries past have played an important part in the popular life of Russia, and, since the political developments of the end of the 19th and early years of the 20th century, have tended to do so more and more. To understand the problem of the *Raskolniki* it is necessary to bear two things in mind: the fundamental principle of Eastern Orthodoxy as distinct from Western Catholicism, and the practical identification in Russia of the National Church with the National State. The very basis of Orthodoxy is that the Church is by Christ's ordinance unalterable, that its traditional forms, every one of which is a vehicle of saving grace, were established in the beginning by Christ and his apostles, and that consequently nothing may be added or altered. The trouble began early in the 17th century with the attempt, made in connexion with the printing of the liturgical books, to emend certain ritual details in which there was proved to have been a departure from primitive usage;¹ it came to a head under the patriarch Nikon (*q.v.*); under his influence a synod endorsed the changes in 1654; one bishop alone, Paul of Colonna, dissented, and he was deposed, knouted and kept in prison till he died mad. In 1656 the synod anathematized the adherents of the old forms, and the anathema was confirmed by those of 1666 and 1667. To the conservatives, known subsequently as Old Ritualists or Old Believers, this marked the beginning of the reign of Antichrist (was not 666 the number of the Beast?); but they continued the struggle, conservative opposition to the Westernizing policy of the tsars, which was held responsible for the introduction of Polish luxury and Latin heresy, giving it a political as well as a religious character. The rising of the Strelitsi in 1682 all but gave them the victory; the crushing of the rising relegated them definitely to the status of schismatics. They were placed in still completer antagonism to the established Orthodox Church by the innovations of Peter the Great. The Muscovite tsars had pursued them with fire and sword. The Russian emperors, having established themselves as heads of the Church and the Holy Synod as a state department, were not likely willingly to tolerate their existence.

The *Raskol* was threatened with extinction by the gradual dying out of its priests, which led to a further schism within itself, into the *Popovschina* (with priests) and the *Bespopovschina* (without priests). The *Popovsti*, who were served by priests converted from the Orthodox Church, made their headquarters in the island of Werka, in a tributary of the Dnieper, in Poland (1695), and after its destruction by the government in 1735 and again in 1764, at Starodubye in the government of Chernigov, whence their doctrine spread in the country of the Don. In 1771 their headquarters were fixed at Moscow, in the Rogoskiy cemetery assigned to them during the plague; here they had a monastery, seminary and consistory, until they were ejected by the emperor Nicholas I. In 1832 priests were forbidden to join them, and they had to apply to a deposed Bosnian metropolitan, who became their chief bishop, establishing his see in the monastery of Belokrinitsa in Bukovina. In 1862 the synod of the *Popovschina* passed a circular letter making advances to the government with a view to a compromise, which was arranged on the basis of the Old Believers consenting to accept the ministrations of Orthodox priests on condition that they should use the unrevised books. This led to a further schism into three sections: those who recognize the metropolitan and the compromise (*Edinoverstsi*), those who recognize the metropolitan but repudiate the compromise, those who repudiate both (*Bieglopovstsi*). There had already been other schisms on such questions as the right way to swing a censor and the legality of self-immolation for the Lord's sake.

The *Bespopovsti*, known also as *Pomoranye*, because they are

¹ The most important alterations were the repetition twice, instead of three times, of the "Alleluiah" at the Eucharist, and the making the sign of the cross with two fingers instead of three.

mainly found in the sparsely populated country near the White Sea, are in some ways more remarkable. They reject the ministrations of priests altogether, since in the time of Antichrist (*i.e.* the heretic tsar) the only sacrament that remains is baptism. They therefore elect elders, who expound the Scriptures, baptize and hear confessions. They are, however, in no sense evangelicals in the Western sense; for they observe rigorous fasts, reverence icons, and believe implicitly in the efficacy of the multiplication of crossings, bowings and prostrations. They have, moreover, thrown off from time to time a number of extravagant offshoots. Such are the *Philippovsti*, founded by one Philip (who burned himself alive for Christ's sake in 1743), who have exalted self-immolation into a principle; the *Stranniki* (pilgrims) and *Byeguni* (runners), who interpret Matt. x. 37 ff. literally, and reject legal marriage; the *Nyetovstsi* (denyers), who deny the necessity for common worship, since there are no priests; the *Molchalyniki* (mutes), whom no torture can persuade to utter a word.

Closely akin to these, though not derived from the Old Believers, are certain mystic sects which deny the efficacy of the sacraments altogether. Of these the most remarkable are the so-called *Khlystsi* ("flagellants," from *klyesati*, "to strike, lash," but possibly a corruption of *Khristi*, "Christ"). They originated in 1645, when, according to their belief, God the Father descended in a chariot of fire on Mount Gorodim, in the province of Vladimir, and took up his abode in a peasant named Daniel Philippov, who chose another peasant, named Ivan Suslov, for his son, the Christ. Suslov selected a "mother of God" and two apostles. Though twice crucified and once flayed by order of the tsar, he always rose again, and did not die till 1716. Suslov chose a successor in one Prokopyi Lupkin, and since then—in the belief of the sect—every generation, even every community, has had its Christ and its "mother of God," who are worshipped by reason of the Divine Spirit dwelling in them. It is the duty of all believers to strive to become one or other of these by subduing the flesh, which is the product of Evil, and all motions of the will. Each community is presided over by an "angel," or prophet, and a prophetess, whose word is law. All alike are subject to the twelve commandments issued by the "Sabaoth," that is to say Daniel Philippov. These include the prohibition of alcoholic drink, of fleshly sins and of marriage, and the inculcation of faith in the Holy Ghost and complete surrender to his influence. At their prayer-meetings the *Khlysti* dance to the accompaniment of hymns, the dance gradually developing into a wild dervish-like spinning which is kept up till they drop, foaming at the mouth and prophesying. Perhaps the most remarkable fact about this sect is that it is secret, and that its members ostensibly belong to the Orthodox Church.

An offshoot of the *Khlysti* is the more celebrated secret sect of the *Skoptsi* (*skopets*, a eunuch), which represents an extreme ascetic reaction from the promiscuous immorality of some (by no means all) of the *Khlysti*. Their idea of attaining salvation is self-mutilation according to the counsel of perfection implied in Matt. xix. 12 and xviii. 8, 9. The "royal seal" is complete self-castration; partial mutilation is known as the "second purity." In the case of women the mutilation usually takes the form of amputation of the breasts. This horrible sect, which was founded by one Selivanov in the last quarter of the 18th century, seems to have a morbid attraction for people of all classes in Russia, and all the efforts of the government have not succeeded in stamping it out (see *SKOPTSI*).

Closer akin to certain Western forms of dissidence from traditional Catholicism, though of native growth, are the *Molokani*, so called popularly because they continue to drink milk (*moloko*) during fasts. Their origin is unknown, but they are officially mentioned as early as 1765. They style themselves "truly spiritual Christians," and in their rejection of the sacraments, their indifference to outward forms, and their insistence on the spiritual interpretation of the Bible ("the letter killeth"), they are closely akin to the Quakers, whom they resemble also in their inoffensive mode of life and the practice of mutual help.

From the Molokani the *Dukhobortsy*, in England better known as Doukhobors (*q.v.*), are distinguished by their subordination of the Scriptures to the authority of the "inner light." They are dualists, like the Bogomils (*q.v.*), ascribing the body to a fall from a state when the soul was on the same plane as God. The Incarnation was no isolated historical occurrence, but it is repeated over and over again in the faithful, each one of whom is in a certain sense God, by virtue of the indwelling Spirit. Both the Molokani and the Dukhobortsy deny the authority of the civil government as such, and object on principle to military service. The former, however, give little trouble; on the other hand, the government has from time to time proceeded with extreme severity against the Dukhobortsy, whose refusal to serve in the army, if allowed to go unpunished, would have set a contagious example.

Dissidence of all kinds has made a considerable advance since the emancipation of the serfs in 1861, the increase—as might be expected in a wholly illiterate population—being greatest in the more extravagant sects. On the other hand, Western Protestantism has also made great headway, notably the Stundists, whose rationalistic-Protestant teaching has gained a firm foothold especially in Little Russia, where the *Raskol* never penetrated. The Baptists have also made considerable progress, notably among the Molokani.¹

Social Conditions.—The old subdivisions of the population into orders possessed of unequal rights is still maintained. The great mass of the people, 81.6%, belong to the peasant order, the others being: nobility, 1.3%; clergy, 0.9%; the burghers and merchants, 9.3; and military, 6.1. Thus more than 88 millions of the Russians are peasants. Half of them were formerly serfs (10,447,149 males in 1838)—the remainder being "state peasants" (9,194,891 males in 1838, exclusive of the Archangel government) and "domain peasants" (842,740 males the same year).

The serfdom which had sprung up in Russia in the 16th century, and became consecrated by law in 1600, taking, however, nearly one hundred and fifty years to attain its full growth, was abolished in 1861. This act liberated the serfs from a yoke which was really terrible, even under the best landlords, and from this point of view it was obviously an immense benefit.² But it was far from securing corresponding economic results.

The household servants or dependents attached to the personal service of their masters were merely set free; and they entirely went to reinforce the town proletariat. The peasants proper received their houses and orchards, and allotments of arable land. These allotments were given over to the rural commune (*mir*), which was made responsible, as a whole, for the payment of taxes for the allotments. For these allotments the peasants had to pay, as before, either by personal labour or by a fixed rent. The allotments could be redeemed by them with the help of the crown, and then they were freed from all obligations to the landlord. The crown paid the landlord in obligations representing the capitalized rent, and the peasants had to pay the crown, for forty-nine years, 6% interest on this capital. The redemption was not calculated on the value of the allotments of land, but was considered as a compensation for the loss of the compulsory labour of the serfs; so that throughout Russia, with the exception of a few provinces in the S.E., it was—and still remains, notwithstanding a very great increase in the value of land—much higher than the market value of the allotment. Moreover, many proprietors contrived to curtail seriously the allotments which the peasants had possessed under serfdom, and frequently they deprived them of precisely the parts which they were most in need of, namely, pasture lands around their houses, and forests. The effect of this, craftily calculated beforehand, was to compel the peasants to rent pasture lands from the landlord at any price.

¹ See N. Tsakni, *Russie sectaire* (1888); A. Leroy-Beaulieu, *L'Empire des Tsars*, tome iii. (1889; trans. 1896); C. K. Grass, *Russische Säkten* (1907 sqq.). Further useful references are given in Bonwetsch's article, "Raskolniken," in Herzog-Hauck, *Realencyklop.* (3rd ed., 1905), vol. xvi. p. 436.

² It was only as late as 1904, however, that the landed proprietors were forbidden by law to inflict corporal punishment upon the peasants.

The present condition of the peasants—according to official documents—appears to be as follows. In the twelve central governments they grow, on the average, sufficient rye-bread for only 200 days in the year—often for only 180 and 100 days. One quarter of them have received allotments of only 2.9 acres per male, and one-half less than 8.5 to 11.4 acres—the normal size of the allotment necessary to the subsistence of a family under the three-fields system being estimated at 28 to 42 acres. Land must thus necessarily be rented from the landlords at fabulous prices. The aggregate value of the redemption and land taxes often reaches 185 to 275% of the normal rental value of the allotments, not to speak of taxes for recruiting purposes, the church, roads, local administration and so on, chiefly levied from the peasants. The arrears increase every year; one-fifth of the inhabitants have left their houses; cattle are disappearing. Every year more than half the adult males (in some districts three-fourths of the men and one-third of the women) quit their homes and wander throughout Russia in search of labour. In the governments of the black-earth region the state of matters is hardly better. Many peasants took the "gratuitous allotments," whose amount was about one-eighth of the normal allotments.

The average allotment in Kherson is only 0.90 acre, and for allotments from 2.9 to 5.8 acres the peasants pay 5 to 10 roubles of redemption tax. The state peasants are better off, but still they are emigrating in masses. It is only in the steppe governments that the situation is more hopeful. In Little Russia, where the allotments were personal (the *mir* existing only among state peasants), the state of affairs does not differ for the better, on account of the high redemption rates. In the W. provinces, where the land was valued cheaper and the allotments somewhat better after the Polish insurrection, the general situation might be better were it not for the former misery of the peasants. Finally, in the Baltic provinces nearly all the land belongs to the German landlords, who either farm the land themselves, with hired labourers, or let it in small farms. Only one-fourth of the peasants are farmers, the remainder being mere labourers, who are emigrating in great numbers.

The situation of the former serf-proprietors is also unsatisfactory. Accustomed to the use of compulsory labour, they have failed to accumulate themselves to the new conditions. The millions of roubles of redemption money received from the crown have been spent without any real or lasting agricultural improvements having been effected. The forests have been sold, and only those landlords are prospering who exact rack-rents for the land without which the peasants could not live upon their allotments. During the years 1861 to 1892 the land owned by the nobles decreased 30%, or from 210,000,000 to 150,000,000 acres; during the following four years an additional 21,190,500 acres were sold; and since then the sales have gone on at an accelerated rate, until in 1903 more than 200,000 acres passed out of their hands. On the other hand, since 1861, and more especially since 1882, when the Peasant Land Bank was founded for making advances to peasants who were desirous of purchasing land, the former serfs, or rather their descendants, have between 1883 and 1904 bought about 19,500,000 acres from their former masters. There has been an increase of wealth among the few, but along with this a general impoverishment of the mass of the people, and the peculiar institution of the *mir*, framed on the principle of community of ownership and occupation of the land, was not conducive to the growth of individual effort. In November 1906, however, the emperor Nicholas II. promulgated a provisional ukaz permitting the peasants to become freeholders of allotments made at the time of emancipation, all redemption dues being remitted. This measure, which was endorsed by the third Duma in an act passed on the 21st of December 1908, is calculated to have far-reaching and profound effects upon the rural economy of Russia. Thirteen years previously the government had endeavoured to secure greater fixity and permanence of tenure by providing that at least twelve years must elapse between every two redistributions of the land belonging to *mir* amongst those entitled to share in it.³ The ukaz of November 1906 had provided that the various strips of land held by each peasant should be merged into a single holding; the Duma, however, on the advice of the government, left this to the future, as an ideal that could only gradually be realized.

The co-operative spirit of the Great Russians shows itself in another sphere in the *artel*, which has been a prominent feature of Russian life since the dawn of history. The *artel*, "Arтели," very much resembles the co-operative society of W. Europe, with this difference that it makes its appearance without

³ See *Collection of Materials on the Village Community*, vol. i.; *Collection of Materials on Landholding, and Statistical Descriptions of Separate Governments*, published by several zemstvos (Moscow, Tver, Nyzhny-Novgorod, Tula, Ryazan, Tambov, Poitava, Saratov, &c.); Kawani, *The Peasant Question*; Vasilchikov, *Land Property and Agriculture* (2 vols.); and Villars, *Life and Agriculture in ukov. The Fall of Serfdom in Russia*; Shashkov, *Peasantry in the Baltic Provinces*, in *Russkaya Mysl*. (1883), iii. and ix.; V. V., *Agric. Sketches of Russia*; Golovachov, *Capital and Peasant Farming*; Engelhardt's *Letters from the Countryside*.

any impulse from theory, simply as a spontaneous outgrowth of popular life. When workmen from any province come, for instance, to St Petersburg to engage in the textile industries, or to work as carpenters, masons, &c., they immediately unite in groups of ten to fifty persons, settle in a house together, keep a common table and pay each his part of the expense to the elected elder of the artei. All over Russia there is a network of such arteis—in the cities, in the forests, on the banks of the rivers, on journeys and even in the prisons.

The industrial artei is almost as frequent as the preceding, in all those trades which admit of it. Arteis of one or two hundred carpenters, bricklayers, &c., are common wherever new buildings have to be erected, or railways or bridges constructed; the contractors always prefer to deal with an artei, rather than with separate workmen. It is needless to add that the wages divided by the arteis are higher than those earned by isolated workmen.

Finally, a great number of arteis on the stock exchange, in the seaports, in the great cities, during the great fairs and on railways have grown up, and have acquired the confidence of traders even to such an extent that considerable sums of money and complicated banking operations are frequently handed over to an arteishik (member of an artei) without any receipt, his number or his name being accepted as sufficient guarantee. These arteis are recruited only on personal acquaintance with the candidates for membership. Co-operative societies have also been organized by several zemstvos. They have achieved good results, but do not exhibit, on the whole, the same unity of organization as those which have arisen in a natural way among the peasants and artisans.

The chief occupation of approximately seven-eighths of the population of European Russia is agriculture, but its character varies considerably according to the soil, the climate and the geographical position of the different regions. A sinuous line drawn from Zhitomir via Kiev, Tula and Kazan to Ufa—that is, from W.S.W. to E.N.E.—separates the "northern soils" from the "southern soils." To the S. of this line, as far as the sandy deserts of Astrakhan and the steppes of N. Caucasia, lies the "black earth" region. Broadly speaking, the forests here yield to steppes, and the soil is very fertile; but the whole region suffers periodically from drought. The "northern soils," which are glacial deposits or less redisturbed by water, are much less fertile, as a rule, and consist of all possible varieties from a tough boulder clay to loose sand. Both N. and S. of this line it is customary to distinguish several zones, lying, generally, parallel to it, and differentiated chiefly by climatic differences. In the tundras of the extreme N. agriculture does not exist; the reindeer constitutes the principal wealth of the nomad Samoyedes and Lapps. In the forest region S. of the tundras, which extends over an area of more than 500,000 sq. m., agriculture is carried on with great difficulty, not only because of the infertile soil, but also because of the severity of the climate and the fact that there are only three to four months in the year during which agriculture can be carried on. Apart from hunting and fishing, the exploitation of the forests provides the principal occupation of the inhabitants. Crops, chiefly barley, rye, oats, turnips and green crops, are, however, grown on clearings in the forest, though the yield is poor. S. of 60° N. agriculture becomes the predominant industry, while the exploitation of the forests plays only a secondary part. In this zone, which extends over an area of nearly 600,000 sq. m., and on the S. touches the agrarian line already mentioned, the principal crops are rye and oats, with barley and wheat coming next. The methods of agriculture are also grown. Cattle have to be housed for the winter. In the W. of this zone, that is in the Baltic provinces, the climate is less severe as well as moister. Agriculture is carried on in a more intelligent manner, and the yield is higher. Flax is almost of as much importance as wheat, and the potato is more cultivated than in any other part of Russia. Hardy fruit thrives, and live-stock breeding prospers. In the W. governments of Kovno, Vitebsk, Vilna, Mogilev, Minsk and Grodno the climate is more temperate, but agriculture is more backward than in the Baltic provinces. The three-field system of cropping a patch of land until its fertility is exhausted, and then allowing it to revert to the primeval condition, is still pursued, and both landowners and peasantry suffer from want of capital and lack of agricultural training. Flax is one of the principal exports of this region, timber being another.

In middle Russia the winters are both longer and harder, and agriculture is consequently carried on under greater difficulties. One of the most serious of these is caused not by the unfavourable character of the climate but by the shortness of labour. Since their emancipation in 1861, the peasants of the central governments of Russia have in large numbers drifted away into the black earth zone, or have gone to the factories. The methods of agriculture are still unscientific and unimproved. Rye is the staple crop, though buckwheat, flax, green crops and the potato are cultivated in considerable quantities.

Agriculture is most advanced in the W. of the black earth zone, that is in the governments of Kiev, Podolia, Poltava and in part of Kharkov. The winters are less severe, and modern agricultural machinery is generally employed, at all events on the larger estates.

In consequence of these more favourable conditions there is greater variety in the cropping; a good deal of wheat is grown, as well as beetroot for sugar, fibre plants and oleaginous plants, fruit, and even (W. of the Dnieper) the vine. Live-stock breeding is likewise in a more prosperous condition. The rest of the black earth zone, which stretches from these governments N.E. to the Volga, is less favoured by nature; the winters are longer and more inclement, and droughts are not uncommon. When this happens there is great suffering from famine, for wheat is the crop upon which the people principally depend, though rye, buckwheat and oats are also cultivated. But a long course of continuous cropping with these grain crops, without affording compensation to the soil in the form of manure or deep cultivation, has so exhausted it that its productiveness has sadly deteriorated. The consequence is that the peasantry are constantly in a state bordering on destitution, and exposed to the horrors of famine, like those which visited them in 1890 and 1898, and threatened in 1907.

S. of the above zone come the S. steppes. In the W., in Bessarabia, the three chief products are maize, wine and hardy fruit, especially plums. Here the climate is temperate and fairly moist, but farther E. it is distinctly more arid. Wheat is the principal crop, with barley second. Water-melons, sun-flowers and flax, both the last two for oil, are usual crops. But the breeding of horses and sheep is of equal importance with agriculture. Here again both capital and labour are short, and the cultivation of the soil suffers from the fact that, owing to the absence of timber, dry dung is used for fuel instead of being employed as manure. The steppe conditions extend over the greater part of the Crimea and up to the foothills of the Caucasus. The actual distribution of arable land, forests and meadows, in European Russia and Poland is shown in the following table:—

	European Russia.		Poland.	
	Acres.	Percentage.	Acres.	Percentage.
Arable land	301,435,000	26	16,900,000	53
Meadows and pasturages	185,498,000	16	6,059,000	19
Forests	452,152,000	39	7,334,000	23
Uncultivated	220,279,000	19	1,594,000	5
Total	1,159,364,000	100	31,887,000	100

The land in European Russia and Poland (Caucasia being excluded) is divided amongst the different classes of owners as follows:—

	European Russia.		Poland.	
	Acres.	Percentage.	Acres.	Percentage.
State and imperial family	400,816,000	35	1,808,000	5½
Peasants	446,657,000	38½	13,584,000	42½
Private owners, towns, &c.	245,835,000	21	15,106,000	47½
Unfit for cultivation	66,056,000	5½	1,389,000	4½
Total	1,159,364,000	100	31,887,000	100

Down to January 1st 1903, the peasants had actually redeemed out of the land allotted to them in 1861 a total of 280,530,516 acres. In Poland the peasants as a body have, in addition to the land thus assigned to them by the government, bought some 2½ million acres since 1863, and of this quantity they purchased no less than 1,600,000 acres, or 64% of the whole, between 1893 and 1902.

Taking the whole of European Russia and Poland, almost exactly two-thirds of the total area is sown every year with cereals. But generally in from 18 to 33 out of the 72 governments in European Russia (including Caucasia) and Poland the yield of cereals is not sufficient for the wants of the people. In 30 to 40 governments, however, there is in most years a surplus available for export. Out of the total acreage under cereals 34% is generally sown with rye, 26% with wheat, 20% with oats and 10½% with barley. Beetroot (6-8 million tons annually) for sugar is especially cultivated in Poland, the governments of Kiev, Podolia, Volhynia, Kharkov, Bessarabia and Kherston. About 100,000 tons of tobacco are grown annually in the S. Flax and hemp occupy considerable acreages in central and N.W. Russia. The vine is cultivated as far N. as 40° N. (in Bessarabia, Crimea, Don Cossacks territory and Caucasia), the annual production of wine amounting to 35-50 million gallons, three-fifths in Caucasia. Market-gardening and fruit-growing are profitable occupations in certain parts of S. and central Russia, and have led recently to the establishment

of factories for canning fruit and for making jam and pickles. Transcaucasia supplies, chiefly from the government of Erivan, some 12,000 tons of raw cotton annually. The tea plant thrives and is being planted fairly rapidly on the Black Sea littoral in Transcaucasia.

Live-stock are diminishing in numbers all round: in the case of horses, from 21 per 100 inhabitants in 1882 to 11 per 100 inhabitants in 1904; of cattle, from 31 in 1851 to 23 in 1882 and 27 in 1904; sheep, from 56 to 46 and 41 in the years named respectively; and pigs, from 13 to 9 and 10 respectively. Recent investigations in the government of Moscow have revealed that 40% of the peasant households possessed no horses, and similar inquiries in 41 governments elicited the fact that 28% of the peasant households were without horses, although of the total number of horses in the country 82% belong to the peasantry. The animal commonly met with is small and possessed of very little strength; the best are those of Poland, the W. governments and the S. steppe country. Both the horses of the Cossacks and the *bitny* race of S. Russia are fine animals, and those of the Kirghiz, though not big, are famous for their endurance. Finland ponies are exported in large numbers. The best bred races of cattle are those of Poland, the W. provinces, Little Russia and the far N. (Kholmogory). Of the 55 million sheep kept in Russia only about 15 millions belong to the fine merino breed, and these are pastured chiefly on the Black Sea steppes. Modern dairy-farming is only just beginning in Russia, but butter is being exported in increasing quantities to W. Europe, including Great Britain. Poultry-farming is being more extensively engaged in, and vast numbers of eggs are exported.

Agriculture stands at a low level in Russia. The landowners are often poor, and suffer from want of capital and lack of enterprise. The peasantry are impoverished, and in many parts live on the verge of starvation for the greater part of the year. While the methods of agriculture have generally shown little, if any, advance, the population is increasing rapidly; and although since the emancipation of the peasants the average annual export of cereals has increased from less than 1½ million tons in 1860 to over 6 million tons in 1900, this result has been attained largely by the repeated cropping to exhaustion of the soil. Thus the cultivators, whether nobles or peasants, have not profited much from the change in their economic circumstances brought about by the social emancipation of 1861. Agriculture suffers from the widespread poverty of the agricultural classes, from the taxation which weighs unjustly upon the peasantry, from their lack of education, their technical ignorance and national indolence, and from the absence of those progressive institutions (e.g. co-operative buying) by means of which the peasantry of Denmark have so wonderfully improved their position. As illustrating the general impoverishment of the Russian peasantry, it may be stated that the arrears of taxation owed by them have increased enormously since 1882, when they amounted to £2,854,000, until in 1900 the total amount was put at £15,222,000. And, strange to say, the heaviest arrears are due from the fertile black earth region of S. Russia, namely, 80% of their total indebtedness. Within recent years, however, some efforts have been made both by the Ministry of Agriculture and by the more enlightened of the *zemstvos* to improve the education of the peasantry, but the progress achieved has been small. The methods adopted by the *zemstvos* for improving the condition of agriculture have included the formation of agricultural councils, the appointment of inspectors, and the founding of museums, meteorological stations and depots for the sale of agricultural machinery. Measures are being taken by the *zemstvos* to increase the very low productivity of the forests. These cover a considerable area, as may be seen by the following table for 1904:—

Region.	Square Miles.	Percentage of Total Area.
European Russia	706,500	39
Poland	11,500	23
Finland	79,000	15
Caucasia	29,200	56
Total	826,200	39

The distribution of forests is very unequal, the area covered by them in the various governments varying from 70% of the total area in the Ural governments of Perm and Ufa, and 68% in Olonets and Archangel, down to 2% in the S.E. The state is the chief owner of forests (almost exclusive owner in Archangel), and owns no less than 289,226,000 acres in European Russia and Poland (235,000,000 acres of good forests), while private persons own 171,800,000 acres, the peasant communities 67,250,000 and the imperial family 22,400,000 acres.

Sericulture, which was in a flourishing condition in the 'sixties both in Caucasia and in S. Russia, was reduced to a very low ebb, in consequence of the silkworm disease, and was only renewed with its vigour towards the end of the 'eighties. At the beginning of

the 20th century it was most developed in Transcaucasia (Kutais, Elisavetpol), and extended into N. Caucasia. Sericulture is taught in a number of special schools and in a great number of village schools. Attempts are being made to re-establish the silk worm industry in S. Russia and in Poland. Altogether raw silk and silk yarn to an annual value exceeding 1½ millions sterling are exported from Russia.

Notwithstanding the wealth of the country in minerals and metals of all kinds, and the endeavours made by government to encourage mining, including the imposition of protective tariffs even against Finland (in 1885), this and the related industries are still at a low stage of development. The remoteness of the mining from the industrial centres, the want of technical instruction and of capital, and the existence of vexatious regulations, aggravated by the disturbed condition of the country, which hinder credit, confidence and enterprise, are amongst the chief reasons for this. The imports of foreign metals in the rough and of coal are steadily increasing, while the exports, never otherwise than insignificant, show no advance. As a producer of iron Russia nevertheless runs France neck and neck for the fourth place amongst the iron-producing countries of the world, her annual output having increased from 1,004,800 metric tons in 1891 to 2,808,000 in 1901 and to 2,900,000 in 1904. The two principal mining centres of European Russia are the Urals, Ekaterinoslav, Kharkov and the Don Cossacks territory. The Ural industry is the older, and is still conducted on primitive methods, wood being largely used for fuel, and the ore and metals being transported by water down the Kama and other rivers. The minerals chiefly produced in the Urals are iron, coal, gold, platinum, copper, salt and precious stones. The production of pig-iron nearly doubled between 1890 and 1900, increasing from 446,800 tons in the former year to 801,600 in the latter; but since 1900 the output has declined, the total for 1904 (inclusive of Siberia) being 644,000 tons. The amount of iron and steel produced in the Urals is not quite 20% of the total in all European Russia and Poland. The output of coal in the Urals is, altogether, less than 3% of the total for all the empire and 4% of the output of European Russia (exclusive of Poland) alone. The annual increase is but small, 261,300 tons in 1904 as against 239,100 in 1903, and 317,000 in the total in 1904. Gold has been mined in the Urals since 1820, but since 1902 the output has fallen off very considerably. Whereas in the latter year the yield amounted to 395,500 oz., in 1900 it was only 291,250 oz. No less than 96% of the world's supply of platinum comes from the Urals; but the total output only ranges between 10,000 and 16,000 lb annually. The copper industry has greatly declined since the 18th century; whereas then it kept 20 smelting works employed, now one-tenth of that number can hardly be kept going. The output for the year is less than 4000 tons. At one time salt was supplied with salt from the Urals, but at the present time the output is extremely small, the 350 tons annually. Salt has been mined there since the 16th century.

The mining region of S. Russia is much more important. It is of comparatively recent foundation (1860), and is carried on largely with French and Belgian capital, with modern appliances and with modern scientific knowledge. Out of an average of some 2,700,000 tons of pig-iron produced annually in the whole of the Russian empire, 61.5% is produced in the basin of the Donets, and out of an average of 2,160,500 tons of worked iron and steel 48.7% are prepared in the same region. The principal consumer of this iron and steel is the government, for the construction of railways, arsenals, artillery, &c. The output of coal in the Russian empire has increased from a total of less than 300,000 tons in 1860 to 3,280,000 in 1880, 15,878,200 in 1900, and 18,620,000 tons in 1904. Of these totals something like 70% is produced in the S. coal-field. Coal takes, however, an altogether secondary place as a fuel in Russia; wood is much more extensively used, not only for domestic, but also for industrial purposes. It is estimated that for domestic purposes nearly 150,000,000 tons of wood are consumed every year, while the steamships, railways and factories consume another 20 or 25 million tons. At the same time large quantities of petroleum refuse are used as fuel in the railways of S.E. Russia and Caucasia, and on the steamboats of the Volga system. For the petroleum industry and the mining of the Caucasus see CAUCASIA. Mining in Poland and Siberia are more fully discussed under those headings.¹

Since the time of Peter the Great, the Russian government has been unceasing in its efforts for the creation and development of home manufactures. Important monopolies in the 18th century, and prohibitive import duties, as well as large money bounties, in the 19th, contributed towards the accumulation of immense private fortunes, but manufactures have on the whole developed but slowly. A great upward movement has, however, been observable since 1863. About that time a thorough reform of the machinery in use was effected whereby the number of hands employed was reduced, but the yearly production doubled or trebled. Manufacturing industry in the modern sense can hardly be said to have existed in Russia

¹ See *Russian Journal of Financial Statistics*, in English (2 vols., St Petersburg, 1901).

before the 19th century, that is to say, industries carried on with capital and machinery in large factories. Industry of this character was first established in Poland in 1820, and it has grown there rapidly, though never so rapidly as during the last few years of the 19th century. The principal centre is Lodz in the government of Piotrkow, the staple industry being cottons. A good many factories have sprung up also in Warsaw and at Sosnowice and Bendzin in the extreme S.W. corner of Poland. Besides cottons the products include woollens and cloth, silks, chemicals, machinery, ironware, beer and flour. At Lodz alone the workmen, in great part Germans and Jews, number between 50,000 and 60,000, and the total output of the factories is estimated at £9,000,000 to £10,500,000 annually. Similar industries, carried on by similar methods, exist at St Petersburg, Riga, Narva and Odessa. In S. Russia, more particularly at Ekaterinoslav, a very vigorous metallurgical industry has grown up since 1860 in conjunction with the iron and coal mining.

The peculiar feature of Russian industry is the development out of the domestic petty handicrafts of central Russia of a semi-factory on a large scale. Owing to the forced abstention from agricultural labour in the winter months the peasants of central Russia, more especially those of the governments of Moscow, Vladimir, Yaroslavl, Kostroma, Tver, Smolensk and Ryazan have for centuries carried on a variety of domestic handicrafts during the period of compulsory leisure. The usual practice was for the whole of the people in one village to devote themselves to one special occupation. Thus, while one village would produce nothing but felt shoes, another would carve sacred images (*ikons*), and a third spin flax only, a fourth make wooden spoons, a fifth nails, a sixth iron chains, and so on. In the same way certain governments became famous for certain commodities, as Moscow for osier baskets, flower-baskets, wicker furniture and lace; Kostroma for lace, wooden utensils, toy, great part German; Perm for hats, sacks and mats, bast boots and garden products; Yaroslavl for furniture, brass samovars, saucapans, spurs, rings, &c.; Vladimir for furniture, osier baskets and flower-stands and sickles; Nizhniy-Novgorod for bast mats and sacks, knives, forks and scissors; Tver for lace, nails, sieves, anchors, fish-hooks, locks, coarse clay pottery, saddlery and harness, boots and shoes, and so on. Out of these have grown large factories, employing as many as 10,000 to 12,000 men each; but when harvest comes round, these men leave the factories and repair to their fields, and meantime the factories stand still for two or three months. Nor do the people work on the holidays of the church, the number of days they lose in this way amounting to nearly one-third of the whole year. Hence, although wages are painfully low, the cost of production to the manufacturer is relatively high; and it is still further increased by the cost of the raw materials, by the heavy rates of transport owing to the distance from the sea, by the dearness of capital and by the scarcity of fuel. As a consequence this central Russian industry, even when supported by very high protective duties, is only able to produce for the home market and the markets of the adjacent territories in Asia which are under Russian political control. Here again cotton is the principal product; and the remarkable growth of the industry is illustrated by the fact that, whereas in 1843 there were only 350,000 spindles at work, fifty years later there were 4,332,000 so employed, and in 1900, 6,554, 600. The number of looms increased from 87,190 in 1890 to 154,600 in 1900. Next after cottons come woollens, silk, cloth, chemicals, machinery, paper, furniture, hats, cement, leather, glass and china and other products. From the governments of Vyatka and Vladimir large numbers of bricklayers, carpenters and other handicraftsmen migrate temporarily to the S. governments every year, and similarly plasterers and painters from the government of Moscow.

The growth of Russian industry is set forth in the following table, which compares the number of workers for 1887, 1897 and 1902, of all factories throughout the empire of which the annual production was valued at more than £210—

Branch of Industry.	Number of Workers.		
	1887.	1897.	1902.
Textiles	399,178	642,520	708,186
Food products	205,223	255,357	303,213
Animal products	38,876	38,418	39,664
Wood	30,703	86,273	79,662
Paper	19,491	46,190	78,395
Chemical products	21,134	35,320	60,108
Ceramics	67,346	143,291	150,809
Mining and metals	390,915	544,333	549,000
Metals goods	103,300	214,311	252,215
Various	41,882	66,249	78,183
Total	1,318,048	2,098,262	2,259,773

With regard to Russian industry generally, the extravagant prices which have to be paid for iron and all iron goods, owing to the prohibitive tariffs, combined with the obstacles put in the way of education, hamper the development of all industries. The cotton factories excel chiefly in the production of red and printed

cottons. In the flax-mills the tendency is to produce the finest tissues as well as the coarser. The silk-mills employ silk obtained from the Caucasus, Italy and France. The growth of the sugar industry is shown by the fact that in 1888-93 the average annual production of sugar was 444,520 tons, in 1902-3 it was 1,180,293 tons. Since 1894 the government has had a monopoly in retailing spirituous liquors, but not wine or beer; but distilling, a very widespread industry, is left in private hands. Beer is chiefly brewed in Poland and the Baltic provinces. Tanneries exist in nearly every government, but it is especially at Warsaw and St Petersburg, and after these at Moscow, that the largest and best modern tanneries and shoe and glove factories are established. The governments of Orel (shoe factories), Kherson, Vyatka, Nizhniy-Novgorod, Perm, Kiev and Kazan rank next in this respect. Furniture factories are developing greatly, as is the paper industry. Flour-mills play an important part in the general industry of Russia, and there are several tobacco and hemp factories.

Far from being destroyed by the competition of the "modern" factories, domestic industries have well maintained their ground, new branches of petty trade having sprung up in some districts, among the manufacture of agricultural machinery (threshing machines in Ryazan, Vyatka and Perm; ploughs in Smolensk, &c.) deserves notice.

The wealth of Russia consisting mainly of raw produce, the trade of the country turns chiefly on the purchase of this for export, and on the sale of manufactured and imported goods in exchange. This traffic is in the hands of a great number of middlemen,—in the W. Jews, and elsewhere Russians,—to whom the peasants are for the most part in debt, as they purchase in advance on security of subsequent payments in corn, rat, wooden wares, &c. A good deal of the internal trade is carried on by travelling merchants.

The fairs are very numerous. Those of Nizhniy-Novgorod, with a return of 20 millions sterling, of Irbit and Kharkov, of Menzelinsk in Ufa, and Omsk and Ishim in Siberia, have considerable importance both for trade and for home manufactures. Altogether, no fewer than 16,600 fairs are held in Russia, 85% of them in European Russia. Of these, 30 show returns of goods imported to the value of over £100,000 each, 41 from £50,000 to £100,000, and 437 from £10,000 to £50,000 each.

The external trade of the Russian empire (bullion and the external trade of Finland not included) since the year 1886 is shown in the following table:—

Years (average).	Exports.	Imports.
1886-1891	£72,200,000	£43,250,000
1892-1896	60,360,000	46,100,000
1897-1901	68,500,000	55,180,000
1902-1905	103,448,000	66,533,000

The exports rank in the following order:—cereals (wheat, barley, rye, oats, maize, buckwheat) and flour, 49.2%; timber and wooden wares, 7.2; petroleum, 5.8; eggs, 5.4; flax, 5; butter, 3; sugar, 2.4; cottons and oilseeds, 2 each; oleaginous seeds, &c., 1.5; wool, 1.4; hemp, spirits, poultry, game, bristled hair, furs, leather, manganese ore, wool, caviar, live-stock, gutta-percha, vegetables and fruit, and tobacco. The two best customers of Russia are Germany, which takes 23.3% of her total exports, and the United Kingdom, which takes 22.9%. Then follow the Netherlands (9.8%), France, Italy, Finland, Belgium, Austria-Hungary, Denmark, Turkey and Sweden. The commodities which the United Kingdom principally takes are wheat, wool, barley, eggs, oats and flax. With regard to the imports into Russia—they consist mainly of raw materials and machinery for the manufactures, and of provisions, the principal items being raw cotton, 17% of the aggregate; machinery and metal goods, 13%; tea, 5%; mineral oils, 5%; gums and resins, 4%; wool and woollen yarns, 3.1%; textiles, 3%; fish, 3%; with leather and hides, chemicals, silks, wine and spirits, colours, fruits, coffee, tobacco and rice. The countries from which Russia buys most extensively are Germany (34%), the United Kingdom (15) and the United States (9%). Machinery, coal, iron, woollens, ships, lead and copper are the commodities supplied by the United Kingdom.

The total mercantile marine of Russia does not aggregate 700,000 tons; and it is distributed in the following proportions: 35.4% in the Caspian Sea, 34.7% in the Black Sea and 29.9% in the Azov, 24.7% in the Ba. Se. and 5.2% in the Shipping Sea. The White Sea. And these proportions represent fairly well the tonnages entering and clearing at the ports of these respective seas. But of the vessels that visit the Russian ports in the way of trade every year only 8.3% are Russian, the rest being of course foreign. Russian craft play, however, a much more important part on the internal waterways, the traffic on which increases rapidly, e.g. whilst in 1894 it amounted to an aggregate of 23,293,400 tons, in 1904 it reached a total of 38,720,240, or an increase of over 66% in the ten years. During the same period the tonnage of the craft themselves more than doubled, while the

the men of Rûs, or Variags, as they were sometimes called, were simply the hardy Norsemen or Normans who at that time, in various countries of Europe, appeared first as armed marauders and then lived in the invaded territory as a dominant military caste until they were gradually absorbed by the native population. Lake Ilmen and the river Volkhov, on which stands Novgorod, Rurik's capital, formed part of the great waterway from the Baltic to the Black Sea, and we know that by this route travelled from Scandinavia to Constantinople the tall fair-haired Northmen who composed the famous Varangian bodyguard of the Byzantine emperors.

The new rulers did not long confine their attention to the tribes who had invited them. They at once began to conquer the surrounding country in all directions, and before

Early conditions. The grand-princes.

two centuries had passed they had established themselves firmly at Kiev on the Dnieper, invaded Byzantine territory, threatened Constantinople with a fleet of small craft, obtained as consort for one of their princes, Vladimir I, (*q.v.*), a sister of the

Byzantine emperor on condition of the prince becoming a Christian, adopted Christianity for themselves and their subjects, learned to hold in check the nomadic hordes of the steppe, and formed matrimonial alliances with the reigning families of Poland, Hungary, Norway and France. In short, they became a considerable power in eastern Europe, and might be regarded as one of the claimants for the inheritance of the decrepit East Roman Empire. Unfortunately for the political future of this new state, its internal consolidation did not keep pace with its territorial expansion. In theory the whole Russian land was a gigantic family estate belonging to the Rurik dynasty, and each member of that great family considered himself entitled to a share of it. It had to be divided, therefore, into a number of independent principalities, but it continued to be loosely held together by the dynastic sentiment of the descendants of Rurik and by the patriarchal authority—a sort of *patria potestas*—of the senior member of the family, called the grand-prince, who ruled in Kiev, “the mother of Russian cities.” His administrative authority was confined to his own principality, but when territorial disputes arose between two or more of his relations, his paternal influence was exercised in the interests of peace and justice. What added to the practical difficulties of this arrangement was that the post of grand-prince was not an hereditary dignity in the sense of descending from father to son, but was always to be held by the senior member of the dynasty; and in the subordinate principalities the same principle of succession was applied, so that reigning princes had to be frequently shifted about from one district to another, according as they could establish the strongest claim to vacant principalities. What constituted in this primitive system of inheritance the strength of a claim was often not easily determined, and even when the legal question was clear enough the law was not always respected by the contending parties. Hence family quarrels became very frequent. These princes were, in fact, men of like passions with ourselves, and acted as powerful men generally do in a rude state of society. Instead of conforming to abstract principles of public law and hereditary succession, they strove to enlarge their territories at the expense of their rivals, and to leave them at their death to their sons rather than to their brothers, nephews and more distant relations. In these circumstances, the traditional authority of the grand-prince, never very great, rapidly declined, and the complicated law of succession, never scrupulously respected, was gradually replaced by “the good old rule, the simple plan, that he should take who has the power, and he should keep who can.” Yaroslav, surnamed the Great, a man of commanding personality, was the last grand-prince who upheld vigorously the old system. After his death in 1054 the process of disintegration went on apace and the family feuds multiplied at an alarming rate. During the next 170 years (1054–1224) no less than 64 principalities had a more or less ephemeral existence, 293 princes put forward succession-claims, and their disputes led to 83 civil wars.

During these interminable struggles of rival princes, Kiev, which had been so long the residence of the grand-prince and of the metropolitian, was repeatedly taken by storm and ruthlessly pillaged, and finally the whole valley of the Dnieper fell a prey to the marauding tribes of the steppe. Thereupon Russian colonization and political influence retreated northwards, and from that time the continuous stream of Russian history is to be sought in the land where the Vikings first settled and in the adjoining basin of the upper Volga. Here new principalities were founded and new agglomerations of principalities came into existence, some of them having a grand-prince who no longer professed allegiance to Kiev. Thus appeared the grand-prince of Suzdal or Vladimir, of Tver, of Ryazan and of Moscow—all irreconcilable rivals with little or no feeling of blood-relationship. The more ambitious and powerful among them aspired not to succeed but to subdue the others and to take possession of their territory, and the armed retainers, who were wont formerly to wander about as free lances, gave up their roving mode of life, settled down permanently in one principality, became landed proprietors, and sought to share as boyars the princes' authority.

Among the principalities of that northern region the first place was long held by Novgorod. Since the days when Rurik had first chosen it as his headquarters, the little town ^{Republic of Novgorod.} on the Volkhov had grown into a great commercial city and a member of the Hanseatic league, and it had brought under subjection a vast expanse of territory, stretching from the shores of the Baltic to the Ural Mountains, and containing several subordinate towns, of which the principal were Pskov, Nizhny-Novgorod and Vyatka. Unlike the ordinary Russian principalities, it had a republican rather than a monarchical form of government. Indeed, it was not so much a principality as a municipal republic of the Venetian type. It always had a prince, no doubt, but he was engaged by formal contract without much attention being paid to hereditary rights, and he was merely leader of the troops, while all the political power remained in the hands of the civil officials and the *Veiche*, a popular assembly which was called together in the market-place, as occasion required, by the tolling of the great bell. Descendants of Rurik, impregnated with the pride of a dominant military caste, did not much like serving those truculent, wilful burghers, and some of them, after a time, voluntarily laid down their office and retired to more congenial surroundings. Those of them who tried to have their own way and came into conflict with the authorities had always to yield in the long run, and they were liable to be treated very unceremoniously, so that the vulgar adage, “If the prince is bad, into the mud with him!” became a maxim of state policy.

There was here in the Russian land the germ of republicanism or constitutional monarchy, but it was not destined to be developed. The principality which was to become the nucleus of the future Russian empire was not Novgorod with its democratic institutions, but its eastern neighbour Moscow, in which the popular assembly played a very insignificant part, and the supreme law was the will of the prince. The opposition which he encountered came not from the burghers but from the boyars and the nobles.

II. *The Mongol or Tatar Domination, 1238–1462.*—Between Moscow and Novgorod there was a long and bitter rivalry, breaking out occasionally into armed conflicts, and among the princes of the other principalities the old struggle for precedence and territory went on unceasingly until it was suddenly interrupted, in the first half of the thirteenth century, by the unexpected irruption of an irresistible foreign foe coming from the mysterious regions of the Far East. “For our sins,” says the Russian chronicler of the time, “unknown nations arrived. No one knew their origin or whence they came, or what religion they practised. That is known only to God, and perhaps to wise men learned in books.” The Russian princes first heard of them from the wild nomadic Polovtsi, who usually pillaged the Russian settlers on the frontier but who now preferred

Mongol and Tatar invasions.

friendship and said: "These terrible strangers have taken our country, and to-morrow they will take yours if you do not come and help us." In response to this call some Russian princes formed a league and went out eastward to meet the foe, but they were utterly defeated in a great battle on the banks of the Kalka (1224), which has remained to this day in the memory of the Russian common people. Now the country was at the mercy of the invaders, but, instead of advancing, they suddenly retreated and did not reappear for thirteen years, during which the princes went on quarrelling and fighting as before, till they were startled by a new invasion much more formidable than its predecessor. This time the invaders came to stay, and they built for themselves a capital, called Sarai, on the lower Volga. Here the commander of "the Golden Horde," as the western

The Golden Horde. section of the Mongol empire was called, fixed his headquarters and represented the majesty of his sovereign the grand khan who lived with the Great Horde in the valley of the Amur. About the origin and character of these terrible invaders we are much better informed than the early Russian chroniclers. The nucleus of the invading horde was a small pastoral tribe in Mongolia, the chief of which, known subsequently to Europe as Jenghiz Khan (*q. v.*), became a mighty conqueror and created a vast empire stretching from China, across northern and central Asia, to the shores of the Baltic and the valley of the Danube—a heterogeneous state containing many nationalities held together by purely administrative ties and by an enormous military force. For forty years after the death of its founder it remained united under the authority of a series of grand khans chosen from among his descendants, and then it began to fall to pieces till the various fractions of it became independent khanates.

The khanate closely connected with the history of Russia was that of Kipchak or the Golden Horde, the khans of which settled, as we have seen, on the lower Volga and built for themselves a capital called Sarai. Here they had their headquarters and held Russia in subjection for nearly three centuries.

The term by which this subjection is commonly designated, the Mongol or Tatar yoke, suggests ideas of terrible oppression, **Character** but in reality these barbarous invaders from the Far East were not such cruel, oppressive taskmasters as is generally supposed. In the first place, they never settled in the country, and they had not much direct dealings with the inhabitants. In accordance with the admonitions of Jenghiz to his children and grandchildren, they retained their pastoral mode of life, so that the subject races, agriculturists and dwellers in towns, were not disturbed in their ordinary avocations. In religious matters they were extremely tolerant. When they first appeared in Europe they were idolaters or Shamanists, and as such they had naturally no religious fanaticism; but even when they adopted Islam they remained as tolerant as before, and the khan of the Golden Horde (Berkaï) who first became a Mussulman allowed the Russians to found a Christian bishopric in his capital. One of his successors, half a century later, married a daughter of the Byzantine emperor, and gave his own daughter in marriage to a Russian prince. These represent the bright side of Tatar rule. It had its dark side also. So long as a great horde of nomads was encamped on the frontier the country was liable to be invaded by an overwhelming force of ruthless marauders. These invasions were fortunately not frequent, but when they occurred they caused an incalculable amount of devastation and suffering. In the intervals the people had to pay a fixed tribute. At first it was collected in a rough-and-ready fashion by a swarm of Tatar tax-gatherers, but about 1250 it was regulated by a census of the population, and, finally, the collection of it was entrusted to the native princes, so that the people were no longer brought into direct contact with the Tatar officials.

By the princes the "yoke" was felt more keenly, and it was very galling. In order to reply to accusations brought against them, or in order to be confirmed in their functions, they had to travel to the Golden Horde on the Volga or even to the camp of the grand khan in some distant part of Siberia,

and the journey was considered so perilous that many of them, before setting out, made their last will and testament and wrote a parental admonition for the guidance of their children. Nor were these precautions by any means superfluous, for not a few princes died on the journey or were condemned to death and executed for real or imaginary offences. Even when the visit to the Horde did not end so tragically, it involved a great deal of anxiety and expense, for the Mongol dignitaries had to be conciliated very liberally, and it was commonly believed that the judges were more influenced by the amount of the bribes than by the force of the arguments. The grand khan was the lord paramount or suzerain of the Russian princes, and he had the force required for making his authority respected. Ambitious members of the Rurik dynasty, instead of seeking to acquire territory by conquest in the field, now sought to attain their ends by intrigue and bribery at the Mongol court.

Of all the princes who sought to advance their fortunes in this way the most dexterous and successful were those of Moscow. They made themselves responsible for the tribute of other principalities as well as of their own, and gradually they became lieutenants-general of their Mongol suzerain. So long as the Mongol empire remained united and strong, they were most submissive and obsequious, but as soon as it was weakened by internal dissensions and began to fall to pieces, they assumed airs of independence, intrigued with the insubordinate Tatar generals, retained for their own use the tribute collected for the grand khan, and finally put themselves at the head of the patriotic movement which aimed at throwing off completely the hated Mongol yoke. For this purpose Dimitri Donskoi formed in 1380 a coalition of Russian princes, and gained a great victory over Khan Mamai of the Golden Horde on the famous battlefield of Kulikovo, the memory of which still lives in the popular legends. For some time longer the Tatars remained troublesome neighbours, capable of invading and devastating large tracts of Russian territory and of threatening even the city of Moscow, but the Horde was now broken up into independent and mutually hostile khanates, and the Moscow diplomatists could generally play off one khanate against the other, so that there was no danger of the old political domination being re-established.

Having thus freed themselves from Tatar control, the Moscow princes continued to carry out energetically their traditional policy of extending and consolidating their dominions at the expense of their less powerful relations. Already Dimitri of the Don was called the grand-prince of all Russia, but the assumption of such an ambitious title was hardly justified by facts, because there were still in his time principalities with grand-princes who claimed to be independent. The complete suppression of these small moribund states and the creation of the autocratic tsardom of Muscovy were the work of Ivan III., surnamed the Great, his son Basil and his grandson Ivan IV., commonly known as Ivan the Terrible, whose united reigns cover a period of 122 years (1462-1584).

III. *The Tsardom of Muscovy.*—What may be called the home policy of these three remarkable rulers consisted in absorbing the few principalities which still remained independent, and in creating for themselves an uncontrolled monarchical authority. In the pursuit of both of these objects they were completely successful. When Ivan III. came to the throne the remaining independent principalities were Great Novgorod, Pskov, Tver, Ryazan and Novgorod-Seversk. He first directed his attention to Novgorod, and by gradually undermining and then destroying the ancient republican liberties he reduced the haughty city, which had long styled itself Lord Novgorod the Great, to the rank of a provincial town. Then he annexed its colonies and thereby extended his dominions to the Polar Ocean and the Ural Mountains. At the same time he took possession of Tver, on the ground that the prince had allied himself with Lithuania. His successor Basil followed in his footsteps, and dealt with the municipal republic of Pskov as Ivan had dealt with Novgorod. Finding the inhabitants too much attached to

The princes of Moscow.
Dimitri Donskoi
1362-1389.

Ivan III.
1462-1505.

Basil III.
1505-1533.

their ancient liberties, he abolished the popular assembly, removed the great bell to Novgorod, installed his own boyars in the administration, transported 300 of the leading families to other localities, replaced them by 300 families from Moscow, and left in the town a strong garrison of his own troops. Ryazan shared the same fate. In 1521 the prince, being suspected of forming an alliance with the Crimean Tatars, was summoned to Moscow and arrested. Two years later the prince of Novgorod-Seversk was accused of intriguing with the Poles and imprisoned for the rest of his life. Thus all the principalities were brought under the power of Moscow, and in that respect there remained nothing for Ivan the Terrible to do. He took precautions, however, against any of the dead or moribund principalities being resuscitated, and punished with merciless severity any attempt to resist or undermine his authority.

With the suppression and absorption of the independent principalities the problem was only half solved. The tsars of Muscovy meant to be autocratic rulers alike in their old and in their new territories. Their forefathers had been trained in the Tatar school of politics and administration, and in their ideas of government they had come to resemble Tatar khans much more than grand-princes of the old patriarchal type. Their autocratic tendencies were fostered also by the Church. As Christianity was brought into Russia from Constantinople it was only natural that the ecclesiastics, many of whom were Greeks, should admire Byzantine ideals and recommend them as models to be imitated. For the ambitious Moscow princes many of the Byzantine ideas were very acceptable. They liked to consider themselves as the Lord's anointed, ranked high above all ordinary mortals even of the most exalted rank; and when Constantinople fell into the hands of the infidel they began to imagine that, as the most powerful potentates of the Eastern Orthodox world they were the protectors of the Orthodox faith and the political heirs of the East Roman emperors. With a view to strengthen this claim Ivan III. married a niece of the emperor Constantine Palaeologus, who had fallen fighting when his capital was taken by the Turks (1453). From that moment Ivan's subjects noticed a change in his attitude towards them, and attributed it to the evil influence of the Greek princess. In the old times the grand-prince was simply *primus inter pares* among the minor princes, and these lived with their boyars almost on a footing of equality. Now the tsar of Muscovy and of all Russia adopted the airs and methods of a Tatar khan and surrounded himself with the pomp and splendours of a Byzantine emperor. Ivan III., notwithstanding the influence of his Greek consort, showed some respect for the ancient traditions and the susceptibilities of those around him, but his successor Basil did not follow his father's example. All through his reign he preferred to employ as officials men of humble origin, and habitually treated the boyars and great nobles very unceremoniously. For disobedience to his orders he imprisoned a boyar who was his own brother-in-law, and he caused another to be beheaded for complaining that the boyar-council was not consulted in important affairs of state. A boyar of Nizhny-Novgorod who allowed himself to criticize the new order of things, and attributed the change to the influence of the Greek princess, had his tongue cut out. From the ecclesiastics Basil likewise insisted on unquestioning obedience, and he did not hesitate to depose by his own authority a metropolitan who was at that time the highest dignity of the Russian Church. According to Siegmund von Herberstein (1486-1566), an Austrian envoy who visited Moscow at that period, no sovereign in Europe was obeyed like the grand-prince of Muscovy, and his court was remarkable for barbaric luxury. In his palace were numerous equerries, chamberlains and other court dignitaries, and when he went out he was attended by a guard of young nobles dressed in gaudy costumes and armed with silver halberds.¹

Such radical changes naturally produced a great deal of

¹ See Friedrich Adelung, *Siegmund Freiherr von Herberstein, mit besonderer Rücksicht auf seine Reisen in Russland geschildert*. (St Petersburg, 1818); autobiography of Herberstein in *Fontes rerum Austriacarum*, part i. vol. i. pp. 67-396.

dissatisfaction among men of Slavonic temperament, whose grandfathers had been independent princes, boyars or free lances, and the malcontents could not adopt the old practice of emigrating to some other principality. There was no longer within the Russian land any independent principality in which an asylum could be found, and emigration to a principality beyond the frontier, such as Lithuania, was regarded as treason, for which the property of the fugitive would be confiscated and his family might be punished. In these circumstances the only outlet for discontent was sedition, and the malcontents awaited impatiently a favourable opportunity for an attempt to curb or overthrow the autocratic power. That opportunity came when Basil died in 1533, leaving as successor a child only three years old, and the chances seemed all on the side of the nobles; but the result belied the current expectations, for the child came to be known in history as Ivan the Terrible, and died half a century later in the full enjoyment of unlimited autocratic power. The fierce struggle between autocratic tyranny and oligarchic disorder, which went on in intermittent fashion during the whole of his reign, cannot be here described in detail, but the chief incidents may be mentioned.

During Ivan's minority the country was governed, or rather misgoverned, first by his mother, and then by rival factions led by great nobles such as the princes Shuiski and *Ivan the Terrible, 1533-84.* Bêlski. Only once during this period did the young tsar come forward and assert his authority. Having convoked his boyars he reproached them collectively with robbing the treasury and committing acts of injustice, and he caused one of them, a Prince Shuiski who happened to be in power at the moment, to be seized by his huntsmen and torn in pieces by a pack of hounds, as a warning to others. Thus apparently he asserted his authority, but in reality, being only thirteen years old, he was a mere puppet in the hands of one of the opposition factions, who wished to oust their rivals, and for the next four years the misgovernment of the nobles went on as before. It was not till he was about seventeen that he took an active part in the administration, and one of his first acts foreshadowed his future policy: he insisted on the metropolitan crowning him, not as grand-prince of Muscovy, but as tsar of all Russia (1547). From the earliest times the term tsar—a contraction of the word Caesar—had been applied to the kings in Biblical history and the Byzantine emperors, and Ivan III. had already been described in the Church service as "the ruler and autocrat of all Russia, the new Tsar Constantine in the new city of Constantine Moscow," but on no previous occasion had a grand-prince been crowned under that title. A few months later occurred in Moscow a great fire, which destroyed nearly the whole of the city, and a serious popular tumult, in which the tsar's uncle was murdered by the populace. Ivan regarded these events as a punishment from Heaven for the neglect of his duties, and he began to attend to public affairs under the influence of an enlightened priest called Sylvester and an official of humble origin called Adashev. With the assistance of these two counsellors he held in check the lawless, turbulent nobles, and ruled justly, to the satisfaction of the people, for fourteen years. Then suddenly, for reasons which cannot easily be explained, he inaugurated a reign of terror which lasted for twenty-four years and earned for him the epithet of "the Terrible." Though there had been no open insurrection, he caused many boyars and humbler persons to be executed, and when some of the great nobles, fearing a similar fate, fled across the frontier and tendered their allegiance to the prince of Lithuania, his suspicion and indignation increased and he determined to adopt still more drastic measures. For this purpose he organized, outside the regular administration, a large corps of civil officials and armed retainers, whose duty it was to obey him implicitly in all things; and with this force, which rose rapidly from 1000 to 6000 men, he acted like a savage invader in a conquered country. Accompanied by these so-called *Oprichniki*, who have been compared to the Turkish Janissaries of the worst period, he ruthlessly devastated large districts—with no other object

apparently than that of terrorizing the population and rewarding his myrmidons—and during a residence of six weeks in Novgorod, lest the old turbulent spirit of the municipal republic should revive, he massacred, it is said, no less than 60,000 of the inhabitants, including many women and children. It is quite possible, as some apologists suggest, that the number of his victims may have been exaggerated, but that they are to be counted by thousands there can be no doubt. In the monastery of St Cyril has been preserved a list of those for whom he requested the prayers of the Church, the total being 3470. The only reference to Novgorod in this curious document is: "Remember, O Lord, the souls of thy Novgorodian servants to the number of 1505 persons." According to the Novgorodian annalists as many as 1500 persons were sometimes put to death in a single day. Perhaps the discrepancy is to be explained by supposing that the pious tsar did not consider all his victims as servants of the Lord, whose souls deserved the prayers of the faithful.

While thus uniting under their vigorous autocratic rule the small rival principalities, the Moscow princes had to keep a watchful eye on their eastern neighbours. The Golden Horde, long weakened by internal dissensions, had now fallen into several khanates, the chief of which were Kazan, Astrakhan and the Crimea. As these independent Tatar states were always jealous of each other, and their jealousy often broke out in open hostility, it was easy to prevent any combined action on their part; and as in each khanate there were always several pretenders and contending factions, Muscovite diplomacy had little difficulty in weakening them individually and preparing for their annexation. In the case of Kazan and Astrakhan the annexation was effected without any great effort in 1552-54, and two years later the Bashkirs, who had likewise formed part of the great Mongol empire, consented to pay tribute. On the other hand, the khans of the Crimea were able, partly from their geographical position and partly from having placed themselves under the protection of the sultans of Turkey, to resist annexation for more than two centuries and to give the Muscovites a great deal of trouble, not only by frequent raids and occasional invasions, but also by allying themselves with the Western enemies of the tsars. As late as 1571 Moscow was pillaged by a Tatar horde; but there was no longer any question of permanent political subjection to the Asiatics, and the Russian frontier was being gradually pushed forward at the expense of the nomads of the steppe by the constant advance of the agricultural population in quest of virgin soil. These latter, like the colonists in the American Far West, had to be constantly on the alert against the attacks of their troublesome neighbours, and they accordingly organized themselves in semi-military fashion. Those of them who lived on the outskirts of the pacified territory adopted a mode of life similar to that of their hereditary opponents, and constituted a peculiar class known as Cossacks, living more by flocks and herds and by marauding expeditions than by agriculture.

The Cossacks.

In the basins of the southern rivers they formed semi-independent military communities. Those of the Volga and the Don professed allegiance to the tsar of Muscovy, whilst those of the Dnieper recognized at first as their suzerain the king of Poland. In neither case did the allegiance involve strict obedience to orders from the superior, and their loyalty was always in danger of being troubled by their love of independence and equality and their desire for loot. More than once they raided and pillaged in wholesale fashion the territory they were supposed to protect. On the whole, however, at that period as in more recent times, they contributed largely to the process of territorial expansion. (See also POLAND: *History*.)

Before the Eastern menace had been entirely removed the ambitious Moscow princes had begun to look with envious eyes beyond their western frontier. Here lay the principality of Lithuania and beyond it the kingdom of Poland, two loosely conglomerated states which had been created by the Piast and Gedymin dynasties in pretty much the same way as the tsardom of Muscovy had been created by the descendants of Rurik. When

the two became united under one ruler towards the end of the 14th century they formed a broad strip of territory stretching from the Baltic to the Black Sea and separating Russia from central Europe. For Russian ambition the barrier was a formidable one, but it did not entirely preclude possibilities of expansion in a more or less remote future. When examined closely it was found to contain many internal flaws. In no sense could it be considered a homogeneous political unit, for in Lithuania the majority of the population were Russian in nationality, language and religion, whereas in Poland the great majority of the inhabitants were Polish and Roman Catholic. Gradually, it is true, the Lithuanian nobles, who possessed all the land and held the peasantry in a state of serfage, adopted Polish nationality and culture, but this change did not secure homogeneity, because the masses clung obstinately to their old nationality and religion, and all the efforts of the Church of Rome to bring them under papal authority proved fruitless. A further source of weakness was the political organization. Nominally it was an hereditary monarchy, but the warlike, turbulent nobles systematically encroached on the sovereign power till they reduced it to a mere shadow and made it elective, with the result that the kingdom of Poland, including the principality of Lithuania, was at last, politically speaking, the most anarchical country in Europe.

As the Muscovite and the Lithuanian-Polish princes were equally ambitious and equally anxious to widen their borders, they naturally came into conflict. At first the Muscovite was decidedly the aggressor. On the death of Casimir, king of Poland and grand-prince of Lithuania, in 1492, the kingdom and the principality ceased to be united and Ivan III. considered he had a good opportunity for attacking the latter. After a short campaign a peace was concluded and Ivan's daughter was given in marriage to the Lithuanian grand-prince, but the matrimonial alliance did not improve the relations between the two countries. On the contrary it served as a pretext for Ivan to interfere in Lithuanian affairs. He not only insisted that his daughter's religion should be duly respected, but he constituted himself the protector of the Orthodox population and this led to a new war in 1499, which went on till 1503, when it was concluded by the cession to Russia of Chernigov, Starodub and 17 other towns. His successor, Basil, tried to get himself elected grand-prince of Lithuania when the throne became vacant by the death of his brother-in-law in 1506, but the choice fell on the late prince's brother Sigismund, who was likewise elected king of Poland. The two countries were thus once more united and better able to resist aggression, but some of the great nobles were discontented and Basil hoped with their assistance to attain his ends. He began war hereafter in 1514 and at once captured Smolensk, but in the following year he was defeated, and the war dragged on during more than seven years, with varying successes and without any important result. In the negotiations for peace the inordinate pretensions of the Muscovite prince were put forward boldly: he not only refused to restore Smolensk, but claimed Kiev and a number of other towns on the ground that in the old time of the independent principalities they had belonged to descendants of Rurik.

The policy of expansion westwards, inaugurated by Ivan III., was modified and enlarged by Ivan the Terrible. The former had aimed simply at making annexations in Lithuania; the latter aspired to obtaining a firm footing on the Baltic coast and establishing direct relations, diplomatic and commercial, with the Western Powers. In this respect he was a precursor of Peter the Great, but he greatly underestimated the difficulties of the task. To reach the Baltic he had to overcome the resistance, not only of the Lithuanians and the Poles, but also of the Teutonic and Livonian military orders, the Swedes and the Danes, who all had possessions in the intervening territory and who all objected to the barbarous Muscovites, already sufficiently formidable, strengthening themselves by direct foreign trade with western Europe and especially by the importation of arms and cunning

foreign artificers. Like the European settlers on the coast of Africa in more recent times, they wished the barbarians of the interior to be restricted to the use of their primitive weapons. One of the Polish kings, for example, threatened with death the English sailors who should attempt to carry on the illicit trade in arms, on the ground that "the Muscovite, who is not only our opponent of to-day but the eternal enemy of all free nations, should not be allowed to supply himself with cannons, bullets and munitions or with artisans who manufacture arms hitherto unknown to those barbarians." This was precisely the reason why Ivan IV. was so anxious to force his way to the coast. His grandfather had obtained from Venice an "artist" who undertook "to build churches and palaces, to cast big bells and cannons, to fire off the said cannons and to make every sort of castings very cunningly"; and with the aid of that clever Venetian he had become the proud possessor of a "cannon-house," subsequently dignified with the name of "arsenal." In imitation of the grandfather the grandson gave a commission to a Saxon, in whom he had confidence, to collect artists and artisans in Germany and bring them to Moscow, but he was prevented from carrying out his scheme by the Livonian Order (1547). A few years later (1553) he found unexpectedly a different route for communication with the West. A ship of an English squadron which was trying to reach China by the North-East passage, entered the northern Dvina, and her captain, Richard Chancellor, journeyed to Moscow in quest of opportunities for trade.

First relations with England.

He met with such a favourable reception from the tsar that on his return to England a special envoy was sent to Moscow by Queen Mary, and he succeeded in obtaining for his countrymen the privilege of trading freely in Russian towns. In return the Russians were allowed to trade freely in England. This afforded great satisfaction to Ivan, but it did not entirely satisfy his requirements, because the new route by the White Sea and North Cape was long and uncertain and for a great part of the year communications were stopped by the ice. He continued, therefore, his efforts to reach the Baltic coast, and he soon came into collision with the Swedes. After a dilatory war of three years he concluded a peace on the ground of free commercial relations, and then he attacked the Livonian Order, on the pretext that the Livonian town of Dorpat had not paid tribute according to ancient treaties. Finding himself unable to resist the Muscovites, the grand master of the Order put himself under Polish protection, and this led to a seven years' war (1563-70) with Poland, during which the Swedes and Danes intervened on their own account. Ivan did not display much military talent, but he showed a remarkable amount of tenacity. No sooner had he made peace with the Poles and failed to get himself elected as their king, than he began a war with the Swedes which dragged on for more than a decade (1572-1583), and before it was ended he was again at war with Poland (1579-81). Though severely tried by disappointments and defeats he never lost hope, and when he died in 1584 he was preparing to renew the struggle and endeavouring to form for that purpose an alliance with England; his great idea, however, was not to be realized till more than a century later, and meanwhile the tsardom of Muscovy had to pass through a severe internal crisis in which its existence was seriously endangered.

Ivan the Terrible had succeeded in stamping out ruthlessly all open resistance to his will, and had created an autocratic government of the Oriental type; but the elements of disorder were still lying beneath the surface, and as soon as the cunning, energetic despot died they reappeared.

His son and successor, Theodore (Feodor), was a weak man of saintly character, very ill fitted to consolidate his father's work and maintain order among the ambitious, turbulent nobles; but he had the good fortune to have an energetic brother-in-law, with no pretensions to sanctity, called Boris Godunov, who was able, with the tsar's moral support, to keep his fellow-boycars in order. This he did during fourteen years, and his administration was signalized by two important innovations—the attaching of the peasants

to the land (*adscriptio glebæ*) and the creation of the patriarchate—both of which deserve a passing notice.

Boris has often been called the creator of serfage in Russia, but in reality he merely accelerated a process which was the natural result of economic conditions. In a primitive, thinly populated, agricultural country, in which the demand for agricultural labour greatly exceeds the supply, the value of land is in proportion to the number of permanent labourers settled on it, and the landed proprietors naturally try to attract to their estates as many peasants as possible; and in this competition the large proprietors have evidently an advantage over their humbler and weaker rivals. Such had been for a considerable time the condition of Russia, and the small proprietors were now becoming so impoverished that they could no longer fulfil their duties to the state. The remedy they proposed was that the labourers should be prohibited from migrating from one estate to another, and an order to that effect was issued, with the result that the peasants, being no longer able to change their domicile and seek new employers, fell practically under the unlimited power of the proprietors on whose land they resided. This change was, of course, popular among the lower and middle ranks of the landlord class, but was very displeasing to the great nobles.

The second of the two innovations above mentioned was popular among all classes. Hitherto the highest authority in the Russian Church was the metropolitan, who was nominally under the jurisdiction of the patriarch of Constantinople, and as soon as Constantinople fell into the hands of the infidel, and the tsars of Muscovy claimed to be the successors of the Byzantine emperors, it seemed right and proper that the Russian Church should become autocephalous and be governed by an independent Russian patriarch. The change was very dexterously effected by Godunov, with the formal assent of the Eastern Orthodox Church as a whole, and one of his adherents was placed on the patriarchal throne.

Having thus gained the support of a large majority of the landed proprietors and the ecclesiastics, Boris Godunov increased his influence to such an extent that on the death of Tsar Feodor without male issue in 1598 he was elected his successor by a Great National Assembly. His short reign was not so successful as his administration under the weak Feodor. The oligarchical party considered it a disgrace to obey a simple boyar; conspiracies were frequent, the rural districts were desolated by famine and plague, great bands of armed brigands roamed about the country committing all manner of atrocities, the Cossacks on the frontier were restless, and the government showed itself incapable of maintaining order. Under the influence of the great nobles who had unsuccessfully opposed the election of Godunov, the general discontent took the form of hostility to him as a usurper, and rumours were heard that the late tsar's younger brother Dimitri (Demetrius), supposed to be dead, was still alive and in hiding. In 1603 a man calling himself Dimitri, and professing to be the rightful heir to the throne, appeared in Poland, and a few months later he crossed the frontier with a large force of Poles, Russian exiles, German mercenaries and Cossacks from the Dnieper and the Don. In reality the younger son of Ivan the Terrible had been strangled before his brother's death—by orders, it was said, of Godunov—and the mysterious individual who was impersonating him was an impostor; but he was regarded as the rightful heir by a large section of the population, and immediately after Boris's death in 1605 he made his triumphal entry into Moscow. Thus began a period of Russian history commonly called "the Troublesome Times," which lasted until 1613. (See DEMETRIUS, PSEUDO-)

The reign of Dimitri was short and uneventful. Before a year had passed a conspiracy was formed against him by an ambitious noble called Basil (Vassili) Shuiski, and he was assassinated in the Kremlin. The chief conspirator, Shuiski, seized the power and was elected tsar by an Assembly composed of his faction, but neither

Beginnings of serfdom.

The patriarchate.

Boris Godunov, 1598-1605.

The pseudo-Demetrius.

Basil Shuiski, 1606-10.

the ambitious boyars, nor the pillaging Cossacks, nor the German mercenaries were satisfied with the change, and soon a new impostor, likewise calling himself Dimitri, son of Tsar Ivan, came forward as the rightful heir. Like his predecessor, he enjoyed the protection and support of the Polish king, Sigismund III., and was strong enough to compel Shuiski to abdicate; but as soon as the throne was vacant Sigismund put forward as a candidate his own son, Wladislaus. To this latter the people of Moscow swore allegiance on condition of his maintaining Orthodoxy and granting certain rights, and on this understanding the Polish troops were allowed to occupy the city and the Kremlin. Then Sigismund unveiled his real plan, which was to obtain the throne not for his son but for himself. This scheme did not please any of the contending factions and it roused the anti-Catholic fanaticism of the masses. At the same time it was displeasing to the Swedes, who had become rivals of the Poles on the Baltic coast, and they started a false Dimitri of their own in Novgorod.

Russia was thus in a very critical condition. The throne was vacant, the great nobles quarrelling among themselves, the Catholic Poles in the Kremlin of Moscow, the Protestant Swedes in Novgorod, and enormous bands of brigands everywhere. The severity of the crisis produced a remedy, in the form of a patriotic rising of the masses under the leadership of a butcher called Minin and a Prince Pozharski. In a short time the invaders were expelled, and a Grand National Assembly elected as tsar Michael Románov, the young son of the metropolitan Philaret, who was connected by marriage with the late dynasty.

During the reign of Michael (1613-45) the new dynasty came to be accepted by all classes, and the country recovered to some extent from the disorders and exhaustion from which it had suffered so severely; but it was not strong enough to pursue at once an aggressive foreign policy, and the tsar prudently determined to make peace with Sweden and conclude an armistice of fourteen years with Poland. At the conclusion of the armistice in 1632, during a short interregnum in Poland, he attempted to avenge past injuries and recover lost territory; but the campaign was not successful, and in 1634 he signed a definitive treaty by no means favourable to Russia. That lesson was laid to heart, and he subsequently maintained a purely defensive attitude. As a precaution against Tatar invasions he founded fortified towns on his southern frontiers—Tambov, Kozlov, Penza and Simbirsk; but when the Don Cossacks offered him Azov, which they had captured from the Turks, and a National Assembly, convoked for the purpose of considering the question, were in favour of accepting it as a means of increasing Russian influence on the Black Sea, he decided that the town should be restored to the sultan, much to the disappointment of its captors.

In the reign of Michael's successor, Alexius (1645-76), the country recovered its strength so rapidly that the tsar was tempted to revive the energetic aggressive policy and put forward claims to Livonia, Lithuania and Little Russia, but he was obliged to moderate his pretensions. Livonia continued to be under Swedish rule, and Lithuania remained united with Poland. Some advantages, however, were obtained. Smolensk and Chernigov were definitely incorporated in the tsardom of Muscovy, and great progress was made towards the absorption of Little Russia.

Roughly speaking, Little Russia, otherwise called the Ukraine, may be described as the basin of the Dnieper southward of the 51st parallel of latitude. In the 16th century it was a thinly populated region inhabited chiefly by Cossacks, speaking the so-called Little Russian dialect, and until 1569 it formed nominally part of Lithuania, but was practically independent. In that year, when Lithuania and Poland were permanently united, it fell under Polish rule, and the Polish government considered it necessary to tame the wild inhabitants and bring them under regular administration. For this decision there were good

reasons, for those turbulent sons of the steppe paid no taxes and were much given to brigandage, and their raiding propensities occasionally created international difficulties with the khan of the Crimea and the sultan of Turkey. It was proposed, therefore, in 1576, that 6000 families should be registered as a militia under a Polish Hetman for the protection of the country against Tatar raids, and that the remainder of the inhabitants should be assimilated to the ordinary peasants of Poland. This arrangement was very distasteful to all classes. The registered Cossacks objected to being placed under a Hetman not freely chosen by themselves, and those who were not included in the militia objected still more strongly to the prospect of being reduced to the miserable condition of Polish serfs. To escape this danger many of them moved down the river and settled on the waste lands beyond the rapids. Here, about 1590, was founded an independent military colony called the *Setch*, the members of which, recognizing no authority but that of their own elected officers, lived by fishing, hunting and making raids on the Tatars, and were always ready to assist their less fortunate countrymen in resisting Polish aggression. For half a century the struggle between the two races went on with varying success, but on the whole the Polish government proved stronger than its insubordinate subjects, and about 1638 it seemed to have attained its object. Polish proprietors settled in large numbers on the Cossack territory, and great efforts were made, with the assistance of the Jesuits, to bring the Orthodox population under papal authority. But for both proprietors and Jesuits a surprise was in store. Threatened seriously in their liberty and their faith, the people rose with greater enthusiasm than before, and a general insurrection, in which the peasants joined, spread over the whole country under the leadership of Bogdan Khmelnicki or Khmelnitiski (*q.v.*), whose name is still remembered in the Ukraine. As in all previous insurrections the Poles proved stronger in the field, and Khmelnitiski in desperation sought foreign assistance, first in Constantinople and then in Moscow. For some time Tsar Alexius hesitated, because he knew that intervention could entail a war with Poland, but after consulting a National Assembly on the subject, he decided to take Little Russia under his protection, and in January 1654 a great Cossack assembly ratified the arrangement, on the understanding that a large part of the old local autonomy should be preserved. In the expected war with Poland, which followed quickly, the Russians were so successful that the arrangement was upheld; but it was soon found that the Cossacks, though they professed unbounded devotion to the Orthodox tsar, disliked Muscovite, quite as much as Polish, interference in their internal affairs, and some of their leaders were in favour of substituting federation with Poland for annexation by Russia. In these circumstances the tsar was induced to accept a compromise, and signed in 1667 the treaty of Andrussovo, by which the territory in dispute was partitioned and the middle course of the Dnieper became the frontier between Russia and Poland.

In the reign of Alexius a conflict took place between the tsar and the patriarch, which is often described as a conflict between Church and State, and which illustrates the relations between the temporal and the spiritual power in Russian state-organization. Until the beginning of the 17th century the Byzantine tradition that in all matters outside the sphere of dogma the ecclesiastical is subordinate to the civil power had been observed in Russia; but the traditional conceptions had been to some extent undermined during the reign of Michael, when the metropolitan Philaret, who was the tsar's father (*vide supra*), became patriarch and was associated with his son in the government on a footing of equality. Like the tsar, he had the official title of "Great Lord" (*veliki gosúdar*), and he had his palace, his court-dignitaries, his retinue, his boyars and his officials all organized on the model of those of the sovereign. Without his assent and blessing no important decisions were taken, all state documents emanating from the highest authority bore his signature, and he was regarded, both in the official world and by the

Pseudo-Demetrius II., 1608-10.

Accession of the House of Románov.

Michael, 1613-45.

Alexius, 1645-76.

The tsar and the patriarch.

public generally, as the tsar's equal in rank and dignity. His immediate successors, being men of humble origin and submissive character, made no pretensions to such an exalted position, but when the haughty, ambitious and energetic Nikon, who enjoyed in large measure the affection and favour of the devout Tsar Alexius, became patriarch, he took Philaret as his model, and propounded, like the popes in western Europe, the doctrine that the spiritual is higher than the temporal power, the former corresponding to the sun and the latter to the moon in the firmament. In accordance with this view he declared that the patriarch was the image of Christ, the head of the Church, and was therefore subject to no earthly authority, and he complained of the tsar's interference in ecclesiastical affairs. His pretensions and his haughty dictatorial manner at last exhausted the tsar's patience, and he was formally deposed and exiled to a monastery. As no voice was raised in his defence and the decision of the ecclesiastical council which condemned him was universally accepted without protest, we must conclude that the conflict was not really between Church and State but simply between the haughty, ambitious Patriarch Nikon and the devout, long-suffering Tsar Alexius. The incident afforded a new proof, where no proof was required, that the autocratic power in Russia was supreme. In order to prevent such incidents in future, Peter the Great abolished the patriarchate altogether, and entrusted the administration of the Church to a synd entirely dependent on the government.

Much more important in its consequences was Nikon's activity as an ecclesiastical reformer. During the Russian Dark Ages certain clerical errors had crept into the liturgical books and certain peculiarities had been adopted in the ritual.

These had been detected and pointed out by learned ecclesiastics of Kiev, where some of the ancient learning of Byzantium had been preserved, and Nikon determined to make the necessary corrections. He determined also to introduce into the Church many desirable reforms. His project was approved by an ecclesiastical council and was supported by the tsar, but it met with violent opposition from a large section of the clergy, and it alarmed the ignorant masses, who regarded any alterations in the ritual, however insignificant they might be, as heretical and very dangerous to salvation. When put into execution the project produced in the Russian Church a great schism and numerous fantastic sects. The cruel persecutions instituted by the authorities with a view to securing conformity increased the number and fanaticism of the schismatics and heretics, and created among them a widespread belief that the reign of Antichrist, foretold in the Apocalypse, was at hand. In support of this idea, independently of the ecclesiastical innovations, many significant facts could be adduced. Numerous foreigners had been allowed to settle in Moscow and to build for themselves a heretical church, and their strange unholy customs had been adopted by not a few courtiers and great dignitaries. Matveyev, the most influential of the boyars, had married a foreigner who conversed freely with her husband's male friends, contrary to the Muscovite notions of respectability and decorum, and his house, in which the tsar was a frequent visitor, was furnished and decorated in foreign fashion. Books on mundane subjects, not at all conducive to the spiritual edification of the faithful, were read by the tsar's counsellors, and a theatre had been erected, in which the tsar often witnessed very unedifying dramas and ballets. Worst of all, the Orthodox tsar occasionally abandoned the decorous flowing robes of his venerated ancestors, and appeared publicly in the unseemly costume of heretical foreigners, whilst his consort, when carried through the streets in a litter, did not conceal her face from the public gaze. Such innovations troubled deeply the pious souls of the conservative Muscovites, and confirmed them in their repugnance to accept the ecclesiastical reforms. Though this original fanaticism gradually cooled and the rigorists had to make many concessions to the exigencies of practical life, a large section of the Russian people remained outside the official fold, so that at the present day, if we may credit the most competent authorities, the schismatics and heretics number more than twelve millions.

While the Muscovites of the upper classes were thus beginning to abandon their old oriental habits, their government was preparing to make a political evolution of a similar kind. Notwithstanding the efforts of the Poles and the **Foreign Relations.** Military Orders to exclude Russia from the shores of the Baltic and keep her in a state of isolation, she was coming slowly into closer relations with central and western Europe. The emperor, the governments of England, Holland, France and Sweden, and even the Grand Turk made advances to the tsar. Some of them wished to gain him as an ally against their rivals, whilst others hoped to obtain from him commercial privileges and permission to trade directly with Persia. The political and the commercial proposals were alike received with coldness, because the native diplomatists had aims which could not be reconciled completely with the policy of any other country, and the native merchants were afraid of foreign competition. The negotiations gave, therefore, little tangible result, but they helped to prepare the way for the new order of things which was soon to be introduced by Alexius's son, Peter the Great.

Before reaching the new order of things, the country had to pass through an internal crisis similar to that which followed the death of Ivan the Terrible, but not nearly so severe. Alexius had been twice married and had left several children by each of his wives, and, as generally happened in such cases, a struggle for power ensued between the two rival families. The late tsar's eldest son, Theodore, was weak in health and died **Theodore III., 1676-82.** without male issue after an uneventful reign of six years (1676-82). As the second son, Ivan, next in

the order of succession, was almost an imbecile, the third son, Peter, born of the second marriage, was proclaimed tsar, and his maternal relations became the dominant faction, but their triumph was of very short duration. An ambitious, energetic sister of Ivan, well known in Russian history as Sophia Alexeyevna, instigated the *stryelski* (*stryelits*), as the troops of the unreformed standing army were called, to upset the arrangement. After making a tumult in the Kremlin and assassinating several of the men in power, they insisted that Ivan should be proclaimed tsar conjointly with Peter, and that Sophia should act as regent during the minority of the two young sovereigns. She accepted unhesitatingly the difficult and dangerous post, and ruled autocratically for seven years (1682-89), but this did not satisfy her ambition. Having discovered that Peter, who had reached the age of seventeen, was thinking of taking the administration into his own hands, she conspired against him with the commander of the *stryelski* and some of his maternal relations; but she was circumvented by the rival faction and interned in a convent, and Peter's mother was put in her place. The importance of these incidents, which are very characteristic of political life in the tsardom of Muscovy, will appear in the sequel.

If Peter really thought of taking the administration into his own hands, he very soon abandoned the idea and returned to the irregular suburban life he had led during his half-sister's regency—associating with foreigners who could teach him the mechanical arts of the West, drilling troops, building and sailing boats, forming projects for the creation of a great navy, indulging publicly in Bacchanalian revels and boisterous amusements not at all to the taste of his pious countrymen, and appearing in Moscow as Orthodox tsar only on great ceremonial occasions. Already the desire to make his country a great naval power was becoming his ruling passion, and when he found by experience that the White Sea, Russia's sole maritime outlet, had great practical inconveniences as a naval base, he revived the project of getting a firm footing on the shores of the Black Sea or the Baltic. At first he gave the preference to the former, and with the aid of a flotilla of small craft, constructed on a tributary of the Don, he succeeded in capturing Azov from the Turks. Greatly elated by this success, he recommended to the council of boyars the construction of a powerful fleet for carrying on war with the infidel, and he himself went abroad to learn more about shipbuilding and useful foreign inventions, and to prepare

Sophia Alexeyevna.

Ivan V. (II.), 1682-89.

Peter the Great, 1689-1725.

diplomatically the projected crusade. His foreign tour, during which he visited Germany, Holland, England, France and Austria, lasted nearly a year and a half, and was suddenly interrupted, when on his way from Vienna to Venice to study the construction of war-galleys, by the alarming news that the turbulent *stryeltsi* of Moscow had mutinied anew with the intention of placing Sophia on the throne. On arriving in Moscow he found that the mutiny had been suppressed and the ringleaders punished, but he considered it necessary to reopen the investigation and act with exemplary severity. Of the surviving mutineers over twelve hundred were executed, some of them by his own hand, and the entire corps was disbanded.

From this moment may be dated the personal reign of Peter, for he now began to direct personally all branches of the administration, and governed with indefatigable vigour for twenty-seven years, during which he greatly increased the area and profoundly modified the internal condition of his country. At first he concentrated his attention on foreign affairs. During his foreign tour he had discovered that the idea of a grand crusade against the infidel was unrealizable, for France was, according to her traditional policy, the ally of the sultan, Austria wished to avoid trouble on her eastern frontier in order to devote her energies to the question of the Spanish succession, and all the other countries which he wished to draw into the coalition had good reasons of their own for desiring the maintenance of peace in eastern Europe. For his Baltic schemes, on the contrary, he had found the ground well prepared. During a halt of a few days in Poland on his way back from Vienna, King Augustus had explained to him a project for partitioning the trans-Baltic provinces of Sweden, by which Poland should recover Livonia and annex Esthonia, Russia should obtain Ingria and Karelia, and Denmark should take possession of Holstein. As Sweden was known to be exhausted by the long wars of Gustavus Adolphus and his successors, and weakened by internal dissensions, the dismemberment seemed an easy matter, and Peter embarked on the scheme with a light heart; but his illusions were quickly dispelled by the eccentric young Swedish king, Charles XII., who arrived suddenly in Esthonia and completely routed the Russian army before Narva. Thus began the so-called Northern War, which lasted intermittently for more than twenty years, and was terminated by the treaty of Nystad (Sept. 10, 1721). By that treaty Peter acquired not only Ingria and Karelia, as originally contemplated, but also Livonia, Esthonia and part of Finland. The problem of obtaining a firm footing on the Baltic coast, on which Ivan the Terrible had squandered his resources to no purpose, was now solved satisfactorily.

Peter's other favourite scheme, that of acquiring the command of the Black Sea, was as far from realization as ever. In the midst of the Northern War, shortly after the great Russian victory of Poltava (1709), the sultan, at the instigation of Swedish and French agents, determined to recover Azov, and made great military preparations for that purpose. Having annihilated at Poltava the army of Charles XII., Peter was not at all indisposed to renew the struggle with Turkey, and began the campaign in the confident hope of making extensive conquests; but he had only got as far as the Pruth when he found himself surrounded by a great Turkish army, and, in order to extricate himself from his critical position, he had to sign a humiliating treaty by which Azov and other conquests were restored to the sultan. His dreams of freeing the Christians from the yoke of the infidel had to be abandoned, and the conquest of the northern shores of the Black Sea was postponed till the reign of Catherine II.

Those tedious and exhausting wars did not prevent Peter from attending to internal affairs, and he displayed as a reformer even more vigour and tenacity than as a general in the field. His first reforms were connected with the army. Several of his immediate predecessors had come to recognize that Russia, with her antiquated military organization, was unable to cope with her Western neighbours, and

had begun to organize, with the help of foreigners, a military force more in accordance with modern requirements; but the progress made in that direction had been slow and unsatisfactory. Unlike his predecessors, Peter was in a hurry to realize his plans, and he set to work at once. In less than two years from the time of disbanding the *stryeltsi* he contrived to create an army of 40,000 men. This army, it is true, was so inefficient that it was completely routed by the Swedish king with a most inferior force, but it was improved gradually until it learned to conquer its Swedish opponents. To accomplish such a feat it was necessary, of course, to expend large sums of money; and as the country could ill bear an increase of taxation, the whole financial system had to be improved and the natural resources of the country had to be developed. At the same time the military and financial requirements dislocated the local and central administration, and consequently a series of radical administrative reforms had to be undertaken. Thus one reform led to another; but Peter was not dismayed by the magnitude of the task, and worked vigorously in all departments with a sublime disregard for the clamour of reactionary opponents and for the feelings and prejudices of his subjects in general. A prudent ruler in his position would have sought to preserve the outward forms while changing the inner substance, but Peter was not at all prudent in that sense. Very often he wantonly provoked opposition, as when he shaved off his beard and compelled his chief officials to do likewise, though he well knew that the operation was regarded by the ignorant masses and the pious of all ranks as a sinful defacing of the image of God. In his eyes the beard was a symbol of the old régime, and as such it must be removed. Reckless of consequences, he swept away the venerated ceremonial formalities which his ancestors had scrupulously observed, openly scoffed at ancient usage, habitually dressed in foreign costume, and generally chose foreign heretics as his boon companions. In adopting foreign innovations, he showed, like the Japanese of the present day, no sentimental preference for any particular nation, and was ready to borrow from the Germans, Dutch, English, Swedes or French whatever seemed best suited for his purpose. The innovations, it must be admitted, did not prove so efficient as he expected, because human nature and traditional habits cannot be changed as quickly as institutions. When the Boyar Duma became the Senate, and the *Prikazi* or administrative departments were organized under the name of Colleges, and when every important town was endowed with a *Rathhaus*, a *Polizei-meister*, guilds, aldermen, and all the municipal paraphernalia of western Europe, the vices of the old institutions survived in the new. Notwithstanding the changes in organization and terminology, the officials remained ignorant, indolent, careless, indifferent to the public welfare, high-handed and extortionate, and the local self-government which was intended to enlighten and control them proved sadly wanting in vitality and practically worthless. So inefficient, indeed, were the reforms as a whole, and so unsuited to the national character and customs, that the Slavophil critics of a later date could maintain plausibly the paradoxical thesis that in regard to internal administration Peter was anything but a national benefactor. However that may be, it must be confessed even by Slavophiles that he dragged his countrymen, more by force than by persuasion, from the paths of traditional routine and pushed them along with all his might on the broad road of progress in the modern sense of the term. Abandoning the ancient Muscovite capital, where many influential personages were fanatically hostile to his innovations and not a few of the superstitious inhabitants regarded him with horror as Antichrist, he built at the mouth of the Neva a new capital which was to serve as "a window through which his people might look into Europe"; and laying aside the national title of tsar he proclaimed himself (1711) emperor (Imperator) of all Russia—much to the surprise and indignation of foreign diplomatic chancelleries, which resented the audacity of a semi-barbarous potentate in claiming to be

equal in rank with the head of the Holy Roman Empire. Gradually, however, the chancelleries had to withdraw their protests, for it came to be generally recognized that the semi-barbarian, who died at the early age of fifty-three, had transformed the oriental tatarism of Muscovy into a state of the Western type and had made it a powerful member of the European family of nations (see PETER I.).

IV. *The Modern Empire.*—On the death of (1725) the internal tranquillity and progress of the empire were again seriously threatened by the uncertainty of the order of succession, and the autocratic power which he had wielded so vigorously passed into the hands of a series of weak, indolent sovereigns who were habitually guided by personal caprice and the advice of intriguing favourites rather than by serious political considerations. During this period, which lasted from 1725 to 1762, the male line of the Romanov dynasty became extinct, and the succession passed to various members of the female line, which intermarried with German princes. In this way German influence was enormously increased, and was represented by men of considerable capacity holding the highest official positions, such as Biren, Münnich and Ostermann. The main events of the period may be summarized very briefly. Peter, by his first marriage, had a son, the unhappy cesarevich Alexis (q.v.), who figures more largely in imaginative literature than in history—a narrow-minded, obstinate, pious youth, who had no sympathy with his father's violent innovations, and was completely under the influence of the old Muscovite reactionary faction. Intimidated by the paternal anger and threats he took refuge in Austria, and when he had been induced by illusory promises to return to Russia he was tried for high treason by a special tribunal, and after being subjected to torture died in prison (1718). To avert the danger of a man of this type succeeding to the throne Peter made a law by which the reigning sovereign might choose his successor according to his own judgment, and two years later he caused his second wife,

Catherine I., 1725-27.

Catherine, the daughter of a Lithuanian peasant, to be crowned with all due solemnity, "in recognition of the courageous services rendered by her to the Russian Empire." This gave Catherine a certain right to the throne at her husband's death, and her claims were supported by Peter's most influential coadjutors, especially by Prince Menshikov, an ambitious man of humble origin who had been raised by his patron to the highest offices of state. On the other hand the great nobles of more conservative tendencies wished to get the young son of the cesarevich Alexis made emperor under their own control. The former faction triumphed, and Catherine reigned for about a year and a half, after which the son of the cesarevich Alexis, Peter II., occupied the throne from 1727 to 1730.

Peter II., 1727-30.

was under the tutelage of Menshikov, who wished him to marry his daughter, but he soon contrived, with the aid of the Dolgorukis and other old families, to get his imperious tutor arrested and exiled to Siberia. The Dolgorukis and their friends thus came into power, and on the death of Peter II. in 1730 they offered the throne to Anne, duchess of Courland, a daughter of Ivan V., elder brother of Peter the Great, on condition of her signing a formal document by which the seat of government should be transferred from St Petersburg to Moscow, and the autocratic power should be limited and controlled by a grand council composed of their own faction. Anne accepted the condition and became empress, but when she discovered that the attempt to limit her powers in favour of a small conservative oligarchy was extremely unpopular among all classes, she submitted the question to an assembly of 800 ecclesiastical and lay dignitaries, and at their request the unlimited autocratic rule was re-established. Her reign (1730-40) was a régime of methodical German despotism on the lines laid down by her uncle, Peter the Great, and as she was naturally indolent and much addicted to frivolous amusements, the administration was directed by her favourite Biren (q.v.) and other men of German origin. Having no male issue,

Anne, 1730-40.

she chose as her successor the infant son of her niece, Anna Leopoldovna, duchess of Brunswick, and at her death the child was duly proclaimed emperor, under the name of Ivan VI., but in little more than a year he was dethroned by the partisans of the Princess Elizabeth, a daughter of Peter the Great and Catherine I. As a true daughter of the great Russian reformer, Elizabeth (1741-61) relegated the German element to a subordinate position in the administration and gave her confidence to genuine Russians like Bestuzhev, Vorontsov, Razumovski (hermorganatic husband) and the Shuvalovs. Her hatred of Germans showed itself likewise in her persistent struggle with Frederick the Great, which cost Russia 300,000 men and 30 millions of roubles—an enormous sum for those days—but in the choice of a successor she could not follow her natural inclinations, for among the few descendants of Michael Romanov there was no one, even in the female line, who could be called a genuine Russian. She proclaimed, therefore, as heir-apparent the son of her deceased elder sister Anna, Charles Peter Ulrich, duke of Holstein-Gottorp, a German in character, habits and religion, and tried to Russinize him by making him adopt the Eastern Orthodox faith and live in St Petersburg during the whole of her reign; but her well-meant efforts were singularly unsuccessful. Impervious to Russian influence, he remained true to his original nationality, and by his undisguised aversion to everything in his adopted country and his passionate, childish admiration of Frederick the Great, he made himself so unpopular that within a few months of his accession, in December 1761, he was dethroned and assassinated by the partisans of his ambitious and able consort, the famous Catherine II.

During the long reign of Catherine II. (1762-96) Russia made rapid progress in civilization, and came to be fully recognized as one of the Great Powers. Coming after a *Catherine II., 1762-96.* series of incompetent rulers, the German princess II., proved herself a worthy successor to Peter the Great both in home and in foreign affairs; but she was not a mere imitator. Peter had endeavoured to import from western Europe the essentials of good government and such of the useful arts as were required for the development of the natural resources of the country; Catherine did likewise, but she did not restrict herself to purely utilitarian aims in the narrower sense of the term. She strove to impart also something of the refinement and ornamental attributes of Western civilization, and aspired to raise her adopted fatherland intellectually and artistically to the west-European level. This new departure she lost no time in proclaiming to the world. Within a few months of her accession, having heard that the publication of the famous French *Encyclopédie* was in danger of being stopped by the French government on account of its irreligious spirit, she proposed to Diderot that he should complete his great work in Russia under her protection. Four years later she endeavoured to embody in a legislative form the principles of enlightenment which she had imbibed from the study of the French philosophers. A Grand Commission, which might be called a consultative parliament, composed of 652 members of all classes—officials, nobles, burghers and peasants—and

¹ To assist the reader in threading the genealogical maze briefly described above, the following tabular statement is inserted:—

(I) Michael, founder of the Romanov dynasty (1613-45).

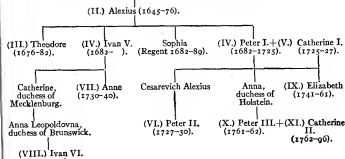

of various nationalities, was called together at Moscow to consider the needs of the empire and the means of satisfying them. The instructions for the guidance of the Assembly were prepared by the empress herself and were, as she frankly admitted, the result of "pillaging the philosophers of the West," especially Montesquieu and Beccaria. As many of the democratic principles frightened her more moderate and experienced advisers, she wisely refrained from immediately putting them into execution. After holding more than 200 sittings the so-called Commission was dissolved without getting beyond the realm of theory and *pia desideria*. Subsequently very important reforms were introduced, not by the vote of an assembly, but by the fiat of the autocratic power. The large

territorial units of administration created by Peter the Great were broken up into so-called "governments" (*gubernii*) and further subdivided into districts (*uyezdy*), and each government was confided to the care of a governor and a vice-governor assisted by a council. A certain amount of local self-government was entrusted to the nobles and the burghers, and the judicial administration was thoroughly reorganized in an enlightened and humane spirit. The great estates of the Church, on which were settled about a million serfs, were secularized and assimilated with the state-domains. At one moment the idea of emancipating all the serfs was entertained, but the project was speedily abandoned, because it would have alienated the nobles—the only class on which Catherine could rely for support. To conciliate them she greatly extended the area of serfage by making large grants of land and serfs to courtiers and public servants who had specially distinguished themselves. About education a great deal was spoken and written, and a certain amount of progress was effected. Whilst primary education was neglected, secondary schools were created in the principal towns and a Russian Academy was founded in St Petersburg. In the imperial court, so far as outward decorum and refinement were concerned, there was an immense improvement, and the upper section of the old Russian *Dvorianstvo* became a noblesse with French aristocratic conceptions and ideals. A taste for French literature spread rapidly, and the poets and dramatists of Paris found clever imitators in St Petersburg.

By such means Catherine made herself very popular in the upper ranks of society, but as a woman and a usurper who did little or nothing to lighten the burdens of the people she failed to gain the loyalty and devotion of the masses. In the first part of her reign popular discontent found expression in various forms, and on one occasion it produced a serious insurrection. In 1773 a Don Cossack called Pugachev, who was so uneducated that he could not even sign the manifestoes written for him, declared himself to be Peter III., and announced that he was going to St Petersburg to punish his faithless wife and place his son Paul on the throne. Many believed, or affected to believe, in the pretender, and in a short time he gathered around him a large force of Cossacks, peasants, Tatars and Tchuvash, swept over the basin of the lower Volga, executed mercilessly the landed proprietors, seized and pillaged the town of Kazan, and kept the whole country in a state of alarm for more than a year. Finally, after a crushing defeat in which 2000 of the insurgents were killed and 6000 taken prisoners, he was betrayed by some of his followers and executed in Moscow. His name and exploits still live in the popular legends, and the insurrection is often referred to in revolutionary pamphlets as a laudable popular protest against tyrannical autocracy.

In foreign affairs Catherine devoted her attention mainly to pushing forward the Russian frontier westwards and southwards, and as France was the traditional ally of Sweden, Poland and Turkey, she adopted at first the so-called *système du Nord*, that is to say, a close alliance with Prussia, England and Denmark against France and Austria, who had buried their traditional enmity in the famous alliance of 1756. The first step westwards was taken in Courland, which lay between Russian territory and

the Baltic coast. At the time of her accession the duchy was ruled by a son of the Polish king Augustus III., and he gave a pretext for aggression by refusing to allow Russian troops returning from the Seven Years' War to pass through his territory. For this unfriendly act he was deposed and replaced by Biren, who had previously been duke of Courland (1737-40) and had since been an exile in Siberia and Yaroslav. Under Biren (1763-69) and his son and successor (1769-95), as nominees of Catherine, Courland was completely under Russian influence until 1795, when it was formally incorporated with the empire. The next country to feel the expansive tendencies of Russia was Poland, which had now very little power of resistance. Whilst Russia, Austria, Prussia and France were becoming powerful monarchies with centralized administration, Poland had remained a weak feudal republic with an elected king chosen under foreign influence and fettered by constitutional restrictions. All political authority was in the hands of turbulent nobles who quarrelled among themselves, who were always inclined to submit the questions at issue to the arbitration of arms, and who did not scruple to invite foreign powers to intervene on their behalf. The middle classes, which were making other countries rich and powerful, existed only in an embryonic condition. Instead of a well-organized army of the modern type there was merely an undisciplined militia composed almost exclusively of irregular cavalry; and the national defences as a whole were so weak that, in the opinion of such a competent authority as Maurice of Saxony, the country might easily be conquered by a regular army of 48,000 men. Here was a tempting field for the application of Catherine's aggressive policy, and if she had had to deal merely with the Poles she would have had an easy task. Unfortunately for the success of her schemes she had to reckon with stronger states which were anxious to check the Russian advance, and which were determined, in the event of aggression, to have a share of the plunder. Frederick the Great was at that moment impatient to extend and consolidate his kingdom by getting possession of the basin of the lower Vistula, which separated eastern Prussia from the rest of his dominions, while Austria had also claims on Polish territory and would certainly not submit to be excluded by her two rivals. In these circumstances Catherine hesitated to bring matters to a crisis, but her hand was forced by Frederick, and in 1772 the first partition of Poland took place without any very strenuous resistance on the part of the victim. This national disaster opened the eyes of many Polish patriots to the necessity of changing radically the old order of things, and an attempt was made by them to remove some of the more glaring absurdities of the existing constitution: the throne was declared to be hereditary, the *liberum veto* by which any petty noble could annul the most important decision of the national assembly was abolished, the royal authority was greatly strengthened, and the towns were empowered to send deputies to the Diet (1791). Such salutary reforms were naturally unwelcome to the aggressive neighbours who wished to preserve the traditional anarchy in order to have new facilities for intervention, and as Russia had signed with the puppet-king in 1768 a treaty by which the constitution could not be modified without her consent, she had a plausible ground for protest. She waited, however, until a deputation of the malcontents, who regretted the loss of *liberum veto* and who were afraid that the party of reform might undertake the emancipation of the serfs, came to St Petersburg and asked for support in defence of the ancient liberties. Then an imperial manifesto reminding the Poles of the treaty of 1768 was issued and a large Russian force entered the Ukraine. This led to the second partition (1793), by which Russia obtained the eastern provinces with three millions of inhabitants. Even now the work of spoliation was not complete. When the patriots under Kosciuszko made a desperate effort to recover the national independence the struggle produced a third partition (1795), by which the remainder of the kingdom was again divided between Russia, Prussia and Austria. Thus Poland disappeared for a time from the map of Europe.

Russia's advance westward raised indirectly the Eastern Question, because it threatened two of France's traditional allies, Sweden and Poland, and Choiseul considered that the best means of checkmating Catherine's aggressive schemes was to incite France's third traditional ally, Turkey, to attack her. This was not a difficult matter, because the Sublime Porte had many things to complain of in the past and had good reason to fear aggression in the near future. War was accordingly declared in 1768, but it proved disastrous for the sultan; and he had to sign in 1774 the treaty of Kuchuk-Kainarji, which gave Russia a firm hold on the Black Sea and the lower Danube (see *TURKEY: History*). The Tatars of the Bug, of the Crimea and of the Kuban were liberated from the suzerainty of the Porte; Azov, Kinburn and all the fortified places of the Crimea were ceded to Russia; the Bosphorus and Dardanelles were opened to Russian merchant vessels; and Russian ambassadors obtained the right to intervene in favour of the inhabitants of the Danubian principalities. Ten years later the semblance of independence which was left to the khans of the Crimea was destroyed and the peninsula formally annexed to the empire.

The peace concluded at Kuchuk-Kainarji was not of long duration. Catherine had conceived an ambitious plan of solving radically the Eastern Question by partitioning Turkey as she and her allies had partitioned Poland, and she had persuaded the emperor Joseph II. to take part in the scheme. It was intended that Russia should take what remained of the northern coast of the Black Sea, Austria should annex the Turkish provinces contiguous to her territory, the Danubian principalities and Bessarabia should be formed into an independent kingdom called Dacia, the Turks should be expelled from Europe, the Byzantine empire should be resuscitated, and the grand-duke Constantine, second son of the Russian heir-apparent, should be placed on the throne of the Palaeologi. Rumours of this gigantic scheme reached Constantinople, and as Catherine's menacing attitude left little doubt as to her aggressive intentions the Porte presented an ultimatum and finally declared war (1787). Fortune again favoured the Russian arms, but as Austria was less successful and signed a separate peace at Sistova in 1791, Catherine did not obtain much material advantage from the campaign. By the peace of Jassy, signed in January 1792, she retained Ochakov and the coast between the Bug and the Dniester, and she secured certain privileges for the Danubian principalities, but the Turks remained in Constantinople, and the realization of the famous Greck project, as it was termed, had to be indefinitely postponed.

During the first years of the French Revolution Catherine's sympathy with philosophic liberalism rapidly evaporated, and she did all in her power to stimulate the hostility of the European sovereigns to the democratic movement; but she carefully abstained from joining the Coalition, and waited patiently for the moment when the complications in western Europe would give her an opportunity of solving independently the Eastern Question in accordance with Russian interests. That moment never came. In November 1796, when the country was not yet prepared to enter on a decisive struggle with Turkey, Catherine died at the age of sixty-six, and was succeeded by her son Paul, whom she had kept during her long reign in a state of semi-captivity.

The short reign of Paul (1796-1801) resembled in many points the still shorter one of his father, Peter III. Both sovereigns were childishly wayward and capriciously autocratic; both were recklessly indifferent to the feelings, convictions and wishes of those around them; both took a passionate interest in the minutiae of military affairs; as Peter had conceived a boundless admiration for Frederick the Great, so Paul conceived a similar admiration for Napoleon, and both suddenly reversed the national policy to suit this feeling; both were singularly blind to the consequences of their foolish conduct; and both fell victims to court conspiracies which could be in some measure justified, or at least excused, on patriotic grounds.

Paul left no deep, permanent mark on Russian history. In internal affairs he wished to undo what his mother had done, but his impulsive, incoherent efforts in that direction merely dislocated the administrative mechanism without producing any tangible results. In foreign affairs he displayed the same capriciousness and want of perseverance. After proclaiming his intention of conferring on his subjects the blessings of peace, he joined in 1798 an Anglo-Austrian coalition against France; but when Austria paid more attention to her own interests than to the interests of monarchical institutions in general, and when England did not respect the independence of Malta, which he had taken under his protection, he succumbed to the artful blandishments of Napoleon and formed with him a plan for ruining the British empire by the conquest of India. Having roused, by what ought perhaps to be called his insanity, the enmity, distrust and fear of all around him, including some members of his own family, he was assassinated on the night of the 23rd to 24th of March 1801, and was succeeded by his son Alexander I.

The early part of Alexander's reign (1801-25) was a period of generous ideas and liberal reforms. Under the influence of his Swiss tutor, Frederick César de Laharpe, he had imbibed many of the democratic ideas of the **Alexander I., 1801-25.** time, and he aspired to put them in practice, with the assistance at first of three young friends, Novosiltov, Adam Czartoryski and Strogonov, who were his intimate counsellors and were popularly known as the Triumvirate, and later of Mikhail Speranski (*q.v.*). Some of the more oppressive measures of the previous reign were abolished; the clergy, the nobles and the merchants were exempted from corporal punishment; the central organs of administration were modernized and the Council of the Empire was created; the idea of granting a constitution was academically discussed; great schemes for educating the people were entertained; parish schools, gymnasia, training colleges and ecclesiastical seminaries were founded; the existing universities of Moscow, Vilna and Dorpat were reorganized and new ones founded in Kazan and Kharkov; the great work of self-emancipation was begun in the Baltic provinces. In all these schemes Alexander took a keen personal interest; but his enthusiasm was soon cooled by practical difficulties, and his attention became more and more engrossed by foreign affairs.

At that time, in respect of foreign affairs, Russia was entering on a new phase of her history. Hitherto she had confined her efforts to territorial expansion in eastern Europe and in Asia, and she had sought foreign alliances merely as temporary expedients to facilitate the attainment of that object. Now she was beginning to consider herself a powerful member of the European family of nations, and she aspired to exercise a predominant influence in all European questions. This tendency was already shown by Catherine when she created the League of Neutrals as an arm against the naval supremacy of England, and by Paul when he insisted that his peace negotiations with Bonaparte should be regarded as part of a general European participation, in which he must be consulted. Alexander insisted still more strongly on this claim, and in the convention which he concluded with the First Consul in October **Alexander and Napoleon.** 1801 it was agreed that the maintenance of a just equilibrium between Austria and Prussia should be taken as an invariable principle in the plans of both parties, that the integrity of the kingdom of the Two Sicilies should be respected, that the duke of Württemberg should receive in Germany an indemnity proportionate to his losses, that the dominions of the elector of Bavaria should be preserved intact, and that the independence of the Ionian Islands should not be violated. Having obtained these important concessions the tsar imagined for a moment that in any further territorial changes he would be consulted and his advice allowed due weight, and he seems even to have indulged in the hope that the affairs of Europe might be directed by himself and his new ally. His illusion was soon dispelled, because the aims and policy of the two potentates were utterly irreconcilable. Whilst

the one strove to erect bulwarks against French aggression, the other was preparing the ground for fresh annexations. During 1803-4 the breach between the two rivals widened, because Napoleon became more and more aggressive and unceremonious in Italy and Germany. Before the end of 1803 Alexander had come to perceive the necessity of resisting him energetically in order to save Europe from complete subjection, and in August 1804 he recognized that an armed conflict was inevitable. It broke out in the following year, and after the battles of Austerlitz (December 1805) and Friedland (June 1807), in which the Russians were completely defeated, the two sovereigns held their famous interviews at Tilsit, at which they not only made peace but agreed to divide the world between them, with a sublime indifference to the interests of other states. The grandiose project was at once vaguely outlined in three formal documents, to the intense satisfaction of both parties, and on both sides there was much rejoicing at the conclusion of such an auspicious alliance; but the diplomatic honeymoon was not of long duration. The mutual assurances of unbounded confidence, admiration and sympathy, if there was any genuine sincerity in them, represented merely a transient state of feeling. Napoleon, who could brook no equal, was nourishing the secret hope that his confederate might be used as a docile subordinate in the realization of his own plans, and the confederate soon came to suspect that he was being duped. His suspicions were intensified by the hostile criticisms of the Tilsit arrangement among his own subjects and by the arbitrary conduct of his ally, who continued his aggressions in reckless fashion as if he were sole master of Europe. The sovereigns of Sardinia, Naples, Portugal and Spain were dethroned, the pope was driven from Rome, the Rhine Confederation was extended till France obtained a footing on the Baltic, the grand-duchy of Warsaw was reorganized and strengthened, the promised evacuation of Prussia was indefinitely postponed, an armistice between Russia and Turkey was negotiated by French diplomacy in such a way that the Russian troops should evacuate the Danubian principalities, which Alexander intended to annex to his empire, and the scheme for breaking up the Ottoman empire and ruining England by the conquest of India, which had been one of the most attractive baits in the Tilsit negotiations, but which had not been formulated in the treaty, was no longer spoken of. At the same time Napoleon threatened openly to crush Austria, and in 1809 he carried out his threat by defeating the Austrian armies at Wagram and elsewhere, and dictating the treaty of Schönbrunn (October 14).

Russia now remained the only unconquered power on the continent, and it was evident that the final struggle with her could not be long delayed. It began in 1812 by the advance of the *Grande Armée* on Moscow, and it ended in 1815 at Waterloo. During those three years Alexander was the chief antagonist of Napoleon, and it was largely due to his skill and persistency that the allies held together and freed Europe permanently from the Napoleonic domination. When peace was finally concluded, he had obtained that predominant position in European politics which had been the object of his ambition since the commencement of his reign, and he now believed firmly that he had been chosen by Providence to secure the happiness of the world in general and of the European nations in particular. In the fulfilment of this supposed mission he was not very successful, because his conception of national happiness and the means of obtaining it differed widely from that of the peoples whom he wished to benefit. They had fought for freedom in order to liberate themselves not only from the yoke of Napoleon but also from the tyranny of their own governments, whereas he expected them to remain submissively under the patriarchal institutions which their native rulers imposed on them. Thus, in spite of his academic sympathy with liberal ideas, he became, together with Metternich, a champion of political stagnation, and co-operated willingly in the reactionary measures against the revolutionary movements in Germany, Italy and Spain. In the affairs of his own

Alexander and the reaction in Europe.

country he refrained from developing and extending the liberal institutions which he had created immediately after his accession, and he finally adopted in all departments of administration a strongly reactionary policy. This naturally caused profound disappointment and dissatisfaction in the liberal section of the educated classes and especially among the young officers of the regiments which had spent some years in western Europe. Some of these officers had been in touch with the revolutionary movements, and had adopted the idea then prevalent in France, Germany and Italy that the best instrument for assuring political progress was to be found in secret societies. In Russia such societies began to be formed about 1816. The tsar, though he came to know of their existence, refrained from taking repressive measures against them, and when he died suddenly at Taganrog on the 1st of December 1825, two of them made an attempt to realize their political aspirations. The heir to the throne was the late tsar's eldest brother, Constantine, but he declined, for private reasons, to accept the succession, and a few days elapsed before the second brother, **Nicholas I., 1825-55.** Nicholas, was proclaimed emperor. Taking advantage of this short interregnum, some members of the secret societies, mostly officers of the Guards, organized a mutiny among the troops quartered in St Petersburg and in Podolia, with a view to effecting a political revolution, but the movement was easily suppressed, and the ringleaders, known subsequently as the Decembrists, were severely punished (see NICHOLAS I.).

Nicholas was a blunt soldier incapable of comprehending his brother's sentimental sympathy with liberalism. The Decembrists' abortive attempt at revolution and the Polish insurrection of 1831, which he crushed with great severity, confirmed him in his conviction that Russia must be ruled with a strong hand. That conviction he put into practice with extreme rigour during the thirty years of his reign (1825-55), endeavouring by every means at his disposal to prevent revolutionary ideas from germinating spontaneously among his subjects and from being imported from abroad. For this purpose he created a very severe press-censorship and an expensive system of passports, which made it more difficult for Russians to visit foreign countries. It would be unjust, however, to say that he was the determined enemy of all progress. Progress was to be made in certain directions and in a certain way. Not only was the army to be well drilled and the fleet to be carefully equipped, but railways were to be constructed, river-navigation was to be facilitated, manufacturing industry was to be developed, commerce was to be encouraged, the administration was to be improved, the laws were to be codified and the tribunals were to be reorganized. All this was to be done, however, under the strict supervision and guidance of the autocratic power, with as little aid as possible from private initiative and with no control whatever of public opinion, because influential public opinion is apt to produce insubordination. When the results proved unsatisfactory, remedies were sought in increased administrative supervision, draconian legislation and severe punishment, and no attempt was made to get out of the vicious circle. In the last months of his life, under the influence of a great national disaster, the conscientious, persistent autocrat began to suspect that his system was a mistake, but he still clung to it obstinately. "My successor," he is reported to have said on his death-bed, "may do as he pleases, but I cannot change!"

This steadfast faith in autocratic methods and the exaggerated fear of revolutionary principles were shown in foreign as well as in home affairs. Like Alexander in the last period of his reign, Nicholas considered himself the supreme guardian of European order, and was ever on the watch to oppose revolution in all its forms. Hence he was generally in strained relations with France, especially in the time of Louis Philippe, who became king not by the grace of God but by the will of the people. During the revolutionary ferment of 1848-49 he urged the Prussian king to refuse the imperial crown, co-operated with the Austrian emperor in suppressing the Hungarian insurrection, and compelled the Prussians to withdraw their support from the insurgents

in Schleswig-Holstein. Unfortunately for the peace of the world his habitual policy of maintaining the existing state of things was frequently obscured and disturbed by his desire to maintain and increase his own and his country's prestige, influence and territory. By the Persian War, which broke out in 1826, in consequence of frontier disputes, he annexed the provinces of Erivan and Nakhichevan, and during the whole of his reign the conquest of the Caucasus was systematically carried on. With regard also to the Ottoman empire his policy cannot be said to have been strictly conservative. As protector of the Orthodox Christians he espoused the cause of the rayahs in Greece, Servia and Rumania. Under a threat of war he obtained in 1826 the Convention of Akerman, by which the autonomy of Moldavia, Walachia and Servia was confirmed, free passage of the straits was secured for merchant ships and disputed territory on the Asiatic frontier was annexed, and in July 1827 he signed with England and France the treaty of London for the solution of the Greek question by the mediation of the Powers. As the sultan rejected the mediation, his fleet was destroyed by the combined squadrons of the three Powers at Navarino; and as this "untoward event" did not suffice to overcome his resistance, a Russian army crossed the Danube and after two hard-fought campaigns advanced to Adrianople. Here, on the 14th of September 1829, was signed a treaty by which the Porte ceded to Russia the islands at the mouth of the Danube and several districts on the Asiatic frontier, granted full liberty to Russian navigation and commerce in the Black Sea, and guaranteed the autonomous rights previously accorded to Moldavia, Walachia and Servia. By the 10th article of the treaty, moreover, Turkey acceded to the protocol of the 22nd of March 1829, by which the Powers had agreed to the erection of Greece into a tributary principality. This attempt of Russia to secure the sole prestige of liberating Greece was, however, frustrated by the action of the other Powers in putting forward the principle of the independence of the new Greek state, with a further extension of frontiers.

The result of the war was to make Russia supreme at Constantinople; and before long an opportunity of further increasing her influence was created by Mehemet Ali, the ambitious pasha of Egypt, who in November 1831 began a war with his sovereign in Syria, gained a series of victories over the Turkish forces in Asia Minor and threatened Constantinople. Sultan Mahmud II. after appealing in vain to Great Britain for active assistance turned in despair to Russia. Nicholas immediately sent his Black Sea fleet into the Bosphorus, landed on the Asiatic shore a force of 10,000 men, and advanced another large force towards the Turkish frontier in Bessarabia. Under pressure from England and France the Egyptians retreated and the Russian forces were withdrawn, but the tsar had meanwhile (July 8, 1833) concluded with the sultan the treaty of Unkiar-Skelessi, which constituted ostensibly a defensive and offensive alliance between the two Powers and established virtually a Russian protectorate over Turkey. In a secret article of the treaty the sultan undertook in the event of a *casus foederis* arising, and in consideration of being relieved of his obligations under the articles of the public treaty, to close the Dardanelles to the warships of all nations "as he sees fit," which meant in effect that in the event of Russia being threatened with an attack from the Mediterranean he would close the Dardanelles against the invader. England and France protested energetically and the treaty remained a dead letter, but the question came up again in 1840, after Mahmud's renewed attempt to crush Mehemet Ali had ended in the utter defeat of the Turks by Ibrahim at Nezib (June 24, 1839). This time Mehemet Ali was supported by the French government, which aimed at establishing predominant influence in Egypt, but he was successfully opposed by a coalition of Great Britain, Russia, Austria and Prussia, which checkmated the aggressive designs of France by the convention of London (July 15, 1840) (see MEHEMET ALI and TURKEY). In this way the development of Russian policy with regard to Turkey was checked for some years, but the project of confirming and extending the Russian

Nicholas I. and the Ottoman empire.

Treaty of Unkiar-Skelessi, 1833.

protectorate over the Orthodox Christians was revived in 1852, when Napoleon III. obtained for the Roman Catholics certain privileges with regard to the Holy Places in Palestine. At the same time Austria intervened in Montenegrin affairs and induced the sultan to withdraw his troops from the principality. In these two incidents the tsar perceived a diminution of Russian prestige and influence in Turkey, and Prince Meshikoff was sent on a special mission to Constantinople to obtain reparation in the form of a treaty which should guarantee the rights of the Orthodox Church with regard to the Holy Places and confirm the protectorate of Russia over the Orthodox rayahs, established by the treaties of Kainarji, Bucharest and Adrianople. The resistance of the sultan, supported by Great Britain and France, led to the Crimean War, which was terminated by the taking of Sevastopol (September 1855) and the treaty of Paris (March 30, 1856). By that important document Russia reluctantly consented to a strict limitation of her armaments in the Black Sea, to withdrawal from the mouths of the Danube by the retrocession of Bessarabia which she had annexed in 1812, and finally to a renunciation of all special rights of intervention between the sultan and his Christian subjects. Nicholas did not live to experience this humiliation. He had died at St Petersburg on the 2nd of March 1855 and had been succeeded by his eldest son, Alexander II.

The Holy Places.

The Crimean War.

The first decade of Alexander's reign is commonly known in Russia as "the epoch of the great reforms," and may be described as a violent reaction against the political and intellectual stagnation of the preceding period. The repressive system of Nicholas, in which all other public interests were sacrificed to that of making Russia a great military power, the guardian of order in Europe and the predominant factor in the Eastern Question, had been tried and found wanting. Ending in a military disaster and a diplomatic humiliation, it had failed to attain even the narrow object for which it had been created. This was clearly perceived and keenly felt by the educated classes, and as soon as the strong hand of the uncompromising autocrat was withdrawn, they clamoured loudly for radical changes in the aims and methods of their rulers. Russia must adopt, it was said, those enlightened principles and liberal institutions which made the Western nations superior to her not only in the arts of peace but even in the art of war; only by imitating her rivals could she hope to overtake and surpass them in the race of progress. On that subject there was wonderful unanimity, and the few persons who could not join in the chorus had the prudence to remain silent. For the first time in the history of Russia public opinion in the modern sense became a power in the state and influenced strongly the policy of the government. Though the young emperor was of too phlegmatic a temperament to be carried away by the prevailing excitement and of too practical a turn of mind to adopt wholesale the doctrinaire theories of his self-constituted, irresponsible advisers, he recognized that great administrative and economic changes were required, and after a short period of hesitation he entered on a series of drastic reforms, of which the most important were the emancipation of the serfs, the thorough reorganization of the judicial administration and the development of local self-government. All these undertakings, in which the humane, liberal-minded autocrat received the sympathy, support and co-operation of the more enlightened of his subjects, were successfully accomplished. The serfs were liberated entirely from the arbitrary rule of the landowners and became proprietors of the communal land; the old tribunals which could be justly described as "dens of iniquity and incompetence," were replaced by civil and criminal law-courts of the French type, in which justice was dispensed by trained jurists according to codified legislation, and from which the traditional bribery and corruption were rigidly excluded; and the administration of local affairs—roads, schools, hospitals, &c.—was entrusted to provincial and district councils freely elected by all classes of the population. In addition to these great and beneficent changes, means were taken for developing more rapidly the

Alexander II., 1855-61.

vast natural resources of the country, public instruction received an unprecedented impetus, a considerable amount of liberty was accorded to the press, a strong spirit of liberalism pervaded rapidly all sections of the educated classes, a new imaginative and critical literature dealing with economic, philosophical and political questions sprang into existence, and for a time the young generation fondly imagined that Russia, awakening from her traditional lethargy, was about to overtake, and soon to surpass, on the path of national progress, the older nations of western Europe.

These sanguine expectations were not fully realized. The economic and moral condition of the peasantry was little improved by freedom, and in many districts there were signs of positive impoverishment and demoralization. The local self-government institutions after a short period of feverish and not always well-directed activity, showed symptoms of organic exhaustion. The reformed tribunals, though incomparably better than their predecessors, did not give universal satisfaction. In the imperial administration, the corruption and long-established abuses which had momentarily vanished, began to reappear. Industrial enterprises did not always succeed. Education produced many unforeseen and undesirable practical results. The liberty of the press not unfrequently degenerated into licence, and sane liberalism was often replaced by socialistic dreaming. In short, it became only too evident that there was no royal road to national prosperity, and that Russia, like other nations, must be content to advance slowly and laboriously along the rough path of painful experience. In these circumstances sanguine enthusiasm naturally gave way to despondency, and the reforming zeal of the government was replaced by tendencies of a decidedly reactionary kind. Partly from disappointment and nervous exhaustion, and partly from a conviction that the country required rest in order to judge the practical results of the reforms already accomplished, the tsar refrained from further initiating new legislation, and the government gave it to be understood that the epoch of the great reforms was closed.

In the younger ranks of the educated classes this state of things produced keen dissatisfaction, which soon found vent in revolutionary agitation. At first the agitation was of an academic character and was dealt with by the press-censure; but it gradually took the form of secret associations, and the police had to interfere. There were no great, well-organized secret societies, but there were many small groups, composed chiefly of male and female students of the universities and technical schools, which worked independently for a common purpose. Finding that the walls of autocracy could not be overturned by blasts of revolutionary trumpets in the periodical press and in clandestinely printed seditious proclamations, the young enthusiasts determined to seek the support of the masses, or, as they termed it, "to go in among the people" (*iditi v narod*). Under the disguise of doctors, midwives, school teachers, governesses, factory hands or common labourers, they sought to make proselytes among the peasantry and the workmen in the industrial centres by revolutionary pamphlets and oral explanations. For a time the propaganda had very little success, because the uneducated peasants and factory workers could not understand the phraseology and abstract principles of socialism; but when the propagandists descended to a lower platform and spread rumours that the tsar had given all the land to the peasants, and was prevented by the proprietors and officials from carrying out his benevolent intentions, there was a serious danger of agrarian disorders, and energetic measures were adopted by the authorities. Wholesale arrests were made by the police, and many of the accused were imprisoned or exiled to distant provinces, some by the regular tribunals, and others by so-called "administrative procedure" without a formal trial. The activity of the police and the sufferings of the victims naturally produced intense excitement and bitterness among those who escaped arrest, and a secret organization calling itself the Executive Committee announced in its clandestinely printed organs that the functionaries who distinguished themselves in the suppression of the propaganda would be "removed." A number

of prominent officials were accordingly condemned to death by this secret terrorist tribunal, and in some cases the sentences were carried out. General Mezentsov, the head of the political police, was assassinated in broad daylight in one of the principal streets of St Petersburg, and in the provinces a good many officials of various grades shared the same fate. As these acts of terrorism had quite the opposite of the desired effect, repeated attempts were made on the life of the emperor, and at last the carefully laid plans of the conspirators were successful. On the 13th of March 1881, when returning from a military parade to the Winter Palace, Alexander II. was terribly wounded by the explosion of a bomb, and died shortly afterwards. (For details of this revolutionary movement, see Nihilism.)

In respect of foreign policy the reign of Alexander II. differed widely from that of Nicholas. The Eastern Colossus no longer inspired respect and fear in Europe. Until the country had completely recovered from the exhaustion of the Crimean War the government remained in the background of European politics. Its attitude was graphically described in the famous declaration of Prince Gorchakov: "La Russie ne boude pas; elle se recueille." On one point, however, this description was not accurate; Russia sulked so far as Austria was concerned, for she could not forget that the emperor Francis Joseph, by his wavering and unfriendly conduct towards her during the Crimean War, had ill repaid her assistance to the Habsburg Monarchy in 1849, and had fulfilled the cynical prediction of Prince Schwarzenberg that his country would astonish the world by her ingratitude. It was not without secret satisfaction, therefore, that Prince Gorchakov watched the repeated defeats of the Austrian army in the Italian campaign of 1859, and he felt inclined to respond to the advances made to him by Napoleon III.; but the germs of a Russo-French alliance, which had come into existence immediately after the Crimean War, ripened very slowly, and they were completely destroyed in 1863 when the French emperor wounded Russian sensibilities deeply by giving moral and diplomatic support to the Polish insurrection. On that occasion Bismarck helped Gorchakov to ward off the threatened intervention of France and England, and he thereby founded the cordial relations which subsisted between the cabinets of Berlin and St Petersburg down to 1878, and which contributed powerfully to the creation of the German empire by defending the Prussian cabinet against the jealousy and enmity of Austria and France. In return for these services Bismarck helped Russia to recover a portion of what she had lost by the Crimean War, for it was thanks to his connivance and diplomatic support that she was able in 1871 to denounce with impunity the clauses of the treaty of Paris which limited Russian armament in the Black Sea. Had the tsar been satisfied with this important success, which enabled him to rebuild Sevastopol and construct a Black Sea fleet, his reign might have been a peaceful and prosperous one, but he tried to recover the remainder of what had been lost by the Crimean War, the province of Bessarabia and predominant influence in Turkey. To effect this, he embarked on the Turkish War of 1877-78, which ended in disappointment. Though the campaign enabled him to recover Bessarabia at the expense of his Rumanian ally, it did not increase Russian prestige in the East, because the Russian army was repeatedly repulsed by the Turks, and when at last it reached Constantinople, it was prevented from entering the city by the threatening attitude of England and Austria. In the field of diplomacy there was likewise disappointment. The concessions extorted from the Porte in the preliminary treaty of San Stefano (March 3, 1878) were revived and considerably modified in favour of Turkey by the congress of Berlin (June 13-July 13, 1878); see EUROPE: history.

Much greater success attended the efforts of Russian diplomacy and Russian arms in Asia. By the treaty of Aigun (May 28, 1858), and without any military operations, the Russian acquisition of a great part of the basin of the Amur was obtained from China. Six years later began the rapid expansion of Russia in Central Asia, and at the end

Foreign
policy

Russo-
Turkish
War of
1877-78.

Russian
expansion
in Asia.

of Alexander II's reign her domination had been firmly established throughout nearly the whole of the vast expanse of territory lying between Siberia on the north and Persia and Afghanistan on the south, and stretching without interruption from the eastern coast of the Caspian to the Chinese frontier. The greater part of the territory was formally incorporated into the empire, and the petty potentates, such as the khan of Khiva and the amir of Bokhara, who were allowed to retain a semblance of their former sovereignty, became obsequious vassals of the White Tsar.

The assassination of Alexander II. by the terrorists made a profound impression on his son and successor, and determined the general character of his rule. Alexander III. (1881-94), who had never sympathized with liberalism in any form, entered frankly on a reactionary policy, which was pursued consistently during the whole of his reign. He could not, of course, undo the great reforms of his predecessor, but he amended them in such a way as to counteract what he considered the exaggerations of liberalism. Local self-government in the village communes, the rural districts and the towns was carefully restricted, and placed to a greater extent under the control of the regular officials. The reformers of the previous reign had endeavoured to make the emancipated peasantry administratively and economically independent of the landed proprietors; the conservatives of this later era, proceeding on the assumption that the peasants did not know how to make a proper use of the liberty prematurely conferred upon them, endeavoured to re-establish the influence of the landed proprietors by appointing from amongst them "land-chiefs," who were to exercise over the peasants of their district a certain amount of patriarchal jurisdiction. The reformers of the previous reign had sought to make the new local administration (*zemstvo*) a system of genuine rural self-government and a basis for future parliamentary institutions; these later conservatives transformed it into a mere branch of the ordinary state administration, and took precautions against its ever assuming a political character. Even municipal institutions, which had never shown much vitality, were subjected to similar restrictions. In short, the various forms of local self-government, which were intended to raise the nation gradually to the higher political level of western Europe, were condemned as unsuited to the national character and traditions, and as productive of disorder and demoralization. They were accordingly replaced in great measure by the old autocratic methods of administration, and much of the administrative corruption which had been cured, or at least repressed, by the reform enthusiasm again flourished luxuriantly.

In a small but influential section of the educated classes there was a conviction that the revolutionism tendencies, which culminated in Nihilism and Anarchism, proceeded from the adoption of cosmopolitan rather than national principles in all spheres of educational and administrative activity, and that the best remedy for the evils from which the country was suffering was to be found in a return to the three great principles of Nationality, Orthodoxy and Autocracy. This doctrine, which had been invented by the Slavophiles of a previous generation, was early instilled into the mind of Alexander III. by Pobédonostsev (*q.v.*), who was one of his teachers, and later his most trusted adviser, and his influence can be traced in all the more important acts of the government during that monarch's reign. His determination to maintain autocracy was officially proclaimed a few days after his accession. Nationality and Eastern Orthodoxy, which are so closely connected as to be almost blended together in the Russian mind, received not less attention. Even in European Russia the regions near the frontier contain a great variety of nationalities, languages and religions. In Finland the population is composed of Finnish-speaking and Swedish-speaking Protestants; the Baltic provinces are inhabited by German-speaking, Lett-speaking and Esth-speaking Lutherans; the inhabitants of the south-western provinces are chiefly Polish-speaking Roman

Catholics and Yiddish-speaking Jews; in the Crimea and on the Middle Volga there are a considerable number of Tatar-speaking Mahomedans; and in the Caucasus there is a conglomeration of races and languages such as is to be found on no other portion of the earth's surface. Until recent times these various nationalities were allowed to retain unmolested the language, religion and peculiar local administration of their ancestors; but when the new nationality doctrine came into fashion, attempts were made to spread among them the language, religion and administrative institutions of the dominant race. In the reigns of Nicholas I. and Alexander II. these attempts were merely occasional and intermittent; under Alexander III. they were made systematically and with very little consideration for the feelings, wishes and interests of the people concerned. The local institutions were assimilated to those of the purely Russian provinces; the use of the Russian language was made obligatory in the administration, in the tribunals and to some extent in the schools; the spread of Eastern Orthodoxy was encouraged by the authorities, whilst the other confessions were placed under severe restrictions; foreigners were prohibited from possessing landed property; and in some provinces administrative measures were taken for making the land pass into the hands of Orthodox Russians. In this process some of the local officials displayed probably an amount of zeal beyond the intentions of the government, but any attempt to oppose the movement was rigorously punished. Of all the various races the Jews were the most severely treated. The great majority of them had long been confined to the western and south-western provinces. In the rest of the country they had not been allowed to reside in the villages, because their habits of keeping vodka-shops and lending money at usurious interest were found to demoralize the peasantry, and even in the towns their numbers and occupations had been restricted by the authorities. But, partly from the usual laxity of the administration and partly from the readiness of the Jews to conciliate the needy officials, the rules had been by no means strictly applied. As soon as this fact became known to Alexander III. he ordered the rules to be strictly carried out, without considering what an enormous amount of hardship and suffering such an order entailed. He also caused new rules to be enacted by which his Jewish subjects were heavily handicapped in education and professional advancement. In short, complete Russification of all non-Russian populations and institutions was the chief aim of the government in home affairs.

In the foreign policy of the empire Alexander III. likewise introduced considerable changes. During his father's reign its main objects were: in the west, the maintenance of the alliance with Germany; in south-eastern Europe, the recovery of what had been lost by the Crimean War, the gradual weakening of the Sultan's authority, and the increase of Russian influence among the minor Slav nationalities; in Asia, the gradual but cautious expansion of Russian dominion. In the reign of Alexander III. the first of these objects was abandoned. Already, before his accession, the bonds of friendship which united Russia to Germany had been weakened by the action of Bismarck in giving to the cabinet of St Petersburg at the Berlin congress less diplomatic support than was expected, and by the Austro-German treaty of alliance (October 1879), concluded avowedly for the purpose of opposing Russian aggression; but the old relations were partly re-established by secret negotiations in 1880, by a meeting of the young tsar and the old emperor at Danzig in 1881, and by the meeting of the three emperors at Skirmiewice in 1884, by which the Three Emperors' League was reconstituted for a term of three years (see EUROPE: *History*). Gradually, however, a great change took place in the tsar's views with regard to the German alliance. He suspected Bismarck of harbouring hostile designs against Russia, and he came to recognize that the permanent weakening of France was not in accordance with Russian political interests. He determined, therefore, to oppose any further disturbance of the balance of power in favour

Foreign
policy.

of Germany, and when the treaty of Skierniewice expired in 1887 he declined to renew it. From that time Russia gravitated slowly towards an alliance with France, and sought to create a counterpoise against the Triple Alliance of Germany, Austria and Italy. The tsar was reluctant to bind himself by a formal treaty, because the French government did not offer the requisite guarantees of stability, and because he feared that it might be induced, by the prospect of Russian support, to assume an aggressive attitude towards Germany. He recognized, however, that in the event of a great European war the two nations would in all probability be found fighting on the same side, and that if they made no preparations for concerted military action they would be placed at a grave disadvantage in comparison with their opponents of the Triple Alliance, who were believed to have already worked out an elaborate plan of campaign. In view of this contingency the Russian and French military authorities studied the military questions in common, and the result of their labours was the preparation of a military convention, which was finally ratified in 1894. During this period the relations between the two governments and the two countries became much more cordial. In the summer of 1891 the visit to Kronstadt of a French squadron under Admiral Gervais was made the occasion for an enthusiastic demonstration in favour of a Franco-Russian alliance; and two years later (October 1893) a still more enthusiastic reception was given to the Russian Admiral Avelan and his officers when they visited Toulon and Paris. But it was not till after the death of Alexander III. that the word "alliance" was used publicly by official personages. In 1895 the term was first publicly employed by M. Ribot, then president of the council, in the Chamber of Deputies, but the expressions he used were so vague that they did not entirely remove the prevailing doubts as to the existence of a formal treaty. Two years later (August 1897), during the official visit of M. Félix Faure to St Petersburg, a little more light was thrown on the subject. In the complimentary speeches delivered by the president of the French Republic and the tsar, France and Russia were referred to as allies, and the term "nations alliées" was afterwards repeatedly used on occasions of a similar kind.

In south-eastern Europe Alexander III. adopted an attitude of reserve and expectancy. He greatly increased and strengthened his Black Sea fleet, so as to be ready for any emergency that might arise, and in June 1886, contrary to the declaration made in the Treaty of Berlin (Art. 59), he ordered Batum to be transformed into a fortified naval port, but in the Balkan Peninsula he persistently refrained, under a good deal of provocation, from any intervention that might lead to a European war. The Bulgarian government, first under Prince Alexander and afterwards under the direction of M. Stamboloff, pursued systematically an anti-Russian policy, but the cabinet of St Petersburg confined itself officially to breaking off diplomatic relations and making diplomatic protests, and unofficially to giving tacit encouragement to revolutionary agitation.

In Asia, during the reign of Alexander III. the expansion of Russian domination made considerable progress. A few weeks after his accession he sanctioned the annexation of the territory of the Tekke Turkomans, which had been conquered by General Skobelev, and in 1884 he formally annexed the Merv oasis without military operations. He then allowed the military authorities to push forward in the direction of Afghanistan, until in March 1885 an engagement took place between Russian and Afghan forces at Panjdeh. Thereupon the British government, which had been for some time carrying on negotiations with the cabinet of St Petersburg for a delimitation of the Russo-Afghan frontier, intervened energetically and prepared for war; but a compromise was effected, and after more than two years of negotiation a delimitation convention was signed at St Petersburg on 20th July 1887. The forward movement of Russia was thus stopped in the direction of Herat, but it continued with great activity farther east in the region of the Pamirs, until another Anglo-Russian convention was signed in 1895. During the whole reign of Alexander III. the increase of terri-

tory in Central Asia is calculated by Russian authorities at 429,895 square kilometres.

On 1st November 1894 Alexander III. died, and was succeeded by his son, Nicholas II., who, partly from similarity of character and partly from veneration for his father's memory, continued the existing lines of policy in home and foreign affairs. The expectation entertained in many quarters that great legislative changes would at once be made in a liberal sense was not realized. When an influential deputation from the province of Tver, which had long enjoyed a reputation for liberalism, ventured to hint in a loyal address that the time had come for changes in the existing autocratic régime, they received a reply which showed that the emperor had no intention of making any such changes. Private suggestions in the same sense, offered directly and respectfully, were no better received, and no important changes were made in the legislation of the preceding reign. But a great alteration took place noiselessly in the manner of carrying out the laws and ministerial circulars. Though resembling his father in the main points of his character, the young tsar was of a more humane disposition, and he was much less of a doctrinaire. With his father's aspiration of making Holy Russia a homogeneous empire he thoroughly sympathized in principle, but he disliked the systematic persecution of Jews, heretics and schismatics to which it gave rise, and he let it be understood, without any formal order or proclamation, that the severe measures hitherto employed would not meet with his approval. The officials were not slow to take the hint, and their undue zeal at once disappeared. Nicholas II. showed, however, that his father's policy of Russification was neither to be reversed nor to be abandoned. When an influential deputation was sent from Finland to St Petersburg to represent to him respectfully that the officials were infringing the local rights and privileges solemnly accorded at the time of the annexation, it was refused an audience, and the leaders of the movement were informed indirectly that local interests must be subordinated to the general welfare of the empire. In accordance with this declaration, the policy of Russification in Finland was steadily maintained, and caused much disappointment, not only to the Finlanders, but also to the other nationalities who desired the preservation of their ancient rights.

In foreign affairs Nicholas II. likewise continued the policy of his predecessor, with certain modifications suggested by the change of circumstances. He strengthened the cordial understanding with France by a formal agreement, the terms of which were not divulged, but he never encouraged the French government in any aggressive designs, and he maintained friendly relations with Germany. In the Balkan Peninsula a slight change of attitude took place. Alexander III., indignant at what he considered the ingratitude of the Slav nationalities, remained coldly aloof, as far as possible, from all intervention in their affairs. About three months after his death, de Giers, who thoroughly approved of this attitude, died (26th January 1895), and his successor, Prince Lobanov, minister of foreign affairs from 19th March 1895 to 30th August 1896, endeavoured to recover what he considered Russia's legitimate influence in the Slav world. For this purpose Russian diplomacy became more active in south-eastern Europe. The result was perceived first in Montenegro and Servia, and then in Bulgaria. Prince Ferdinand of Bulgaria had long been anxious to legalize his position by a reconciliation, and as soon as he got rid of Stamboloff he made advances to the Russian government. They were well received, and a reconciliation was effected on certain conditions, the first of which was that Prince Ferdinand's eldest son and heir should become a member of the Eastern Orthodox Church. As another means of opposing Western influence in south-eastern Europe, Prince Lobanov inclined to the policy of protecting rather than weakening the Ottoman empire. When the British government seemed disposed to use coercive measures for the protection of the Armenians, he gave it clearly to be understood that any such proceeding would be opposed by Russia. After Prince Lobanov's death and the appointment

Death of Alexander III., accession of Nicholas II.

of Count Muraviev as his successor in January 1897, this tendency of Russian policy became less marked. In April 1897, it is true, when the Greeks provoked a war with Turkey, they received no support from St Petersburg, but at the close of the war the tsar showed himself more friendly to them; and afterwards, when it proved extremely difficult to find a suitable person as governor-general of Crete (see CRETE), he recommended the appointment of his cousin, Prince George of Greece—a selection which was pretty sure to accelerate the union of the island with the Hellenic kingdom. How far the recommendation was due to personal feeling, as opposed to political considerations, it is impossible to say.

In Asia, after the accession of Nicholas II., the expansion of Russia, following the line of least resistance and stimulated by the construction of the Trans-Siberian railway, took the direction of northern China and the effete little kingdom of Korea. A great part of the eastern section of the railway was constructed on Chinese territory, and elaborate preparations were made for bringing Manchuria within the sphere of Russian influence. With this view, the cabinet of St Petersburg, at the close of the Chino-Japanese War in 1895, objected to all annexations by Japan in that quarter, and insisted on having the treaty of Shimonoseki modified accordingly. Subsequently, by obtaining from the Tsungli-Yaman a long lease of Port Arthur and Talienwan and a concession to unite those ports with the Trans-Siberian by a branch line, she tightened her hold on that portion of the Chinese empire and prepared to complete the work of aggression by so-called "spontaneous infiltration." From Manchuria, it was assumed, the political influence and spontaneous infiltration would naturally spread to Korea, and on the deeply indented coast of the Hermit Kingdom might be constructed new ports and arsenals more spacious and strategically more important than Port Arthur.

This grandiose project was unexpectedly destroyed by the energetic resistance of Japan, who had ear-marked the Hermit Kingdom for herself, and who declared plainly that she would never tolerate the exclusive influence of Russia in Manchuria. In vain the Russian diplomatists sought to overcome her opposition by dilatory negotiations, in the firm conviction that a small island kingdom in the Pacific would never have the audacity to attack a power which had conquered and absorbed the whole of Northern Asia. Their calculations proved erroneous. Convinced that the onward march of the Colossus could not be permanently arrested by mere diplomatic conventions, the cabinet of Tokio suddenly broke off diplomatic relations and commenced hostilities (February 8, 1904). For Russia the war proved a series of uninterrupted reverses both on land and on sea, until it was terminated by the treaty of Portsmouth in October 1905 (see RUSSO-JAPANESE WAR).

What contributed powerfully to the conclusion of peace was the fact that the Russian government was hampered by internal troubles. The old Liberal movement and the terrorist organizations which had been suppressed by Alexander III. were being resuscitated, and the liberal *la Russia*, and revolutionary leaders, taking advantage of the unpopularity of the war, were agitating for the convocation of a Constituent Assembly, which should replace the hated bureaucratic régime by democratic institutions. With great reluctance the tsar consented to convoke a consultative chamber of deputies as a sop to public opinion, but that concession stimulated rather than calmed public opinion, and shortly after the conclusion of peace the Liberals and the Revolutionaries, combining their forces, brought about a general strike in St Petersburg together with the stoppage of railway communication all over the empire. Panic-stricken for a moment, the government issued a manifesto proclaiming Liberal principles and promising in vague language all manner of political reforms (October 30, 1905), and when the inordinate expectations created by this extraordinary document were not at once realized, preparations were made for overthrowing the existing régime by means of an armed insurrection. Many

believed that the end of autocracy had come, and an extemporized Council of Labour Deputies, anxious to play the part of a *Comité de Salut Public*, was ready to take over the supreme power and exercise it in the interests of the proletariat. In reality the revolutionary movement was not so strong and the government not so weak as was generally supposed. Mutinies occurred, it is true, during the next few weeks in Kronstadt and Sevastopol, and in December there was street-fighting for several days in Moscow, but such serious disorders were speedily suppressed, and thereafter the revolutionary manifestations were confined to mass meetings, processions with red flags, attempts on the lives of officials and policemen, robberies under arms and agrarian disturbances.

Notwithstanding the unsatisfactory results of the October manifesto the tsar kept his promise of convoking a legislative assembly, and on the 10th of May 1906 the first Duma was opened by his majesty in person; but it was so systematically and violently hostile to the government and so determined to obtain executive, in addition to its legislative, functions, that it was dissolved on the 23rd of July without any legislative work being accomplished. The second Duma, which met on the 5th of March 1907, avoided some of the mistakes of its predecessor, but as a legislative assembly it showed itself equally incompetent, and a large section of its members were implicated in a well-organized attempt to spread sedition in the army by revolutionary propaganda. It was dissolved, therefore, on the 16th of June 1907, and the electoral law which had given such unsatisfactory results was modified by imperial ukase.

The third Duma was subsequently convoked for the 14th of November 1907. (D. M. W.)

Development of the Russian Constitution.—At the end of 1910 the Russian revolution, which seemed at one time to promise an overturn as complete as that of the *ancien régime* in France, would seem to have entered on a path of orderly and conservative development, and it is possible, now that the smoke of combat has cleared away, to form some estimate of the forces through the interplay of which this result has been achieved. At the outset the superficial resemblance between the revolutionary movement in Russia and that of 1789 in France was striking: there was the same breakdown of the traditional machinery of government, the same general outcry for control by a representative national assembly, the same gradual and reluctant concessions wrung from the crown under pressure of disaffection in the army, popular *émeutes*, the assassination of unpopular officials, and the burning of country houses by organized bands of peasants. Similar, too, was the revelation, when freedom of speech was at last allowed, of the unhappy effect of the long divorce of the intellect of the country from any experience of practical politics. But here the analogy breaks down. France in 1789, though its ancient provincial boundaries survived, had long since been welded into a nation conscious of its common interests; Russia remains a vast empire, composed of the most heterogeneous, sometimes even mutually hostile, elements, whose antagonisms were bound to be an element of weakness in any assembly truly representative of all sections of the people. In France the Revolution had been the work of the middle classes; in Russia an indigenous middle class has, comparatively speaking, no existence, the peasants forming the overwhelming majority of the population.¹ The supreme peril to the autocracy in Russia lay in the genuine grievances of the peasants, less political than economic, which had opened their minds to revolutionary propaganda. These grievances once removed, and their legitimate land-hunger satisfied, the peasants would become a bulwark of the established order, whatever that might be, as had happened in similar circumstances in Austria in 1849. As for the revolutionary "intellectuals," without the lever of agrarian discontent they

The
Russian
revolution.

¹ In 1897 only 15% of the population were engaged in commerce or industry, including the work-people. Of the middle class, moreover, a large proportion were Jews and Germans. The peasants numbered 75%.

were practically powerless, the more so as their political activity consisted mainly in "building theories for an imaginary world." The *bourgeois* revolutionists of France had all been *philosophes*, but their philosophy had at least paid lip-service to "reason"; the Russian revolutionists who formed the majority of the first and second Dumas, as though inspired by the exalted nonsense preached by Tolstói,¹ subordinated reason to sentiment, until—their impracticable temper having been advertised to all the world—it became easy for the government to treat them as a mere excrescence on the national life, a malignant growth to be removed by a necessary operation. In 1909 the number of exiles for political reasons from Russia was reckoned at 180,000; but the third Duma, purged and packed by an ingenious franchiser system, was in its third year passing measures of beneficent legislation, in complete harmony with the government. It is proposed to trace briefly the steps by which this result was obtained.

In order to explain the course of the revolution which came to a head in 1905 it is necessary to say a few words about constitutional plans and liberal experiments, initiated from above, which had preceded it. Of the ancient *zemski sobor* (assembly of the country) it is unnecessary here to say much, though Nicholas II. was pressed by the more reactionary elements to model his parliament on this rough equivalent of the Western states-general. The *zemski sobor*, which had played a considerable part in the struggle of the tsars against the great boyars in the 17th century, had met but once since the days of Peter the Great.² The origin of the present constitution of Russia must be sought, not in this ancient and obsolete institution, but in the artificial constitution elaborated by Mikhail Speranski (*g.v.*) in 1809 at the instance of the emperor Alexander I. Of Speranski's plan only the establishment of the Imperial Council (January 1st, 1810) was realized in his lifetime.³ In 1864, however, the emperor Alexander II. carried the scheme a step further by the creation of elected provincial assemblies (*zemstvos*), to which in 1870 elected municipal councils (*dumas*) were added. The opportunity thus given for debate naturally stimulated the movement in favour of constitutional government, which received new impulses from the sympathetic attitude of the emperor Alexander II., his grant in 1870 of a constitution to the liberated principality of Bulgaria, and the multiplication of Nihilist outrages which pointed to the necessity of conciliating Liberal opinion in order to present a united front against revolutionary agitation. In January 1881 Count Loris-Melikov, minister of the interior, proposed to convene a "general commission" to examine legislative proposals before these were laid before the Imperial Council; this commission was to consist of members elected by the *zemstvos* and the larger towns, and others nominated in the provinces having no *zemstvos*. The plan was approved by Alexander II. on the very morning of his assassination (February 17th, 1881), but it was never promulgated. The new tsar, Alexander III., was an apt pupil of his tutor Pobedonostsev (*g.v.*), the celebrated procurator of the

Reaction under Alexander III. Holy Synod, for whom the representative system was "a modern lie," and his reign covered a period of frank reaction, during which there was not only no question of granting any fresh liberties but those already conceded (e.g. the principle of the separation of the administrative and judicial functions) were largely curtailed. The result of this policy of repression, associated as it was with gross incompetence and corruption in the organs of the administration, was the rapid spread of the revolutionary movement, which gradually permeated the intelligent classes and ultimately

¹ "Tolstói observed that that was argument and reason, and that he paid no attention to them; he only guided himself (he said) by sentiment, which he felt sure told him what was good and right!"—Interview with Metchnikoff in Sir Ray Lankester's *Science from an Easy Chair*, p. 43.

² In 1767, when Catherine II.—in a mood of encyclopaedist enlightenment—summoned it. The meeting confined its attention to economic questions, and had no political character whatever.

³ In his speech at the opening of the first Polish parliament at Warsaw in 1818, Alexander I. publicly announced his intention of granting free institutions to Russia.

affected even the stolid and apparently immovable masses of the peasantry.

The movement came to a head, as a result of the disasters of the war with Japan, in 1904. The assassination of the minister of the interior Plehve, on the 14th of July, by the revolutionist Sazonov was remarkable as a symptom mainly owing to the widespread sympathy of the European press of all shades of opinion with the motives of the assassin. It was clear that the system with which the murdered minister's name had been associated stood all but universally condemned, and in the appointment of the conciliatory Prince Sviatopolk-Mirski as his successor the tsar himself seemed to concede the necessity for a change of policy.⁴ In November, with the tacit consent of the police, a private assembly of eminent members of local *zemstvos* and municipal *dumas* was held in St Petersburg to discuss the situation. The majority of this decided to approach the crown with a suggestion for a reform of the Russian system on the basis of a national representative assembly, an extension of local self-government, and wider guarantees for individual liberty. The day on which the deputation laid these views before Prince Mirski was hailed by public opinion as recalling the 5th of May 1789, the date of the meeting of the French states-general at Versailles. The emperor, however, whatever his own views, was surrounded by reactionary influences, of which the most powerful were the empress-mother, Pobedonostsev the procurator of the Holy Synod, Count Muraviev and the Grand-duke Sergius. The imperial *ukaz* of the 12th of December enunciating reforms affecting the peasants, workmen and local *zemstvos* failed to satisfy public opinion; for there was no word in it of constitutional government. Petitions continued to flow in to the emperor's cabinet, praying for a national representation, from the *zemstvos*, from the nobles and from the professional classes, and their moral

Influence of the Japanese War.

Meeting of zemstvos.

Agitation and outrages.

was enforced by general agitation, by partial strikes, and by outrages which culminated at Moscow in the murder of the Grand-duke Sergius (February 4th, 1905). In the imperial counsels the resisting forces still seemed to have the upper hand. Prince Mirski resigned, his resignation being immediately followed by a reactionary imperial manifesto reaffirming the principle of autocracy (February 18th). Bulygin, Mirski's successor, had no knowledge of this until after its publication; he hastened to the tsar and obtained the issue on the same day of a rescript which, while reserving the "fundamental laws of the empire" inviolate, stated the emperor's intention of summoning the representatives of the people to aid in "the preparation and examination of legislative proposals." A commission of inquiry, under the emperor's presidency, was now established to elaborate the means for carrying this promise into effect. On the 6th of June, in reply to a deputation of the second congress of *zemstvos* headed by Prince Trubetzkoi, the emperor promised the speedy convocation of a National Assembly. When, however, on the 6th of August, the new law was promulgated, it was found that the "Imperial Duma"⁵ was to be no more than a consultative body, charged with the examination of legislative proposals before these came before the Imperial Council, the duty and right of passing them into law being still reserved for the autocrat alone. The members of the Duma, moreover, were placed at the mercy of the government by a clause empowering the Directing Senate to suspend or deprive them. The promulgation of this truncated constitution was greeted by a furious agitation, culminating in September in a general strike, rightly described as the most remarkable political phenomenon of modern times. For days the whole mechanism of civilized existence in Russia was at a standstill, all intercourse

⁴ Sazonov's sentence of twenty years' hard labour was commuted by Nicholas II. to fourteen years.

⁵ *Duma* = council, assembly (*dumat*, to think over, reflect upon). The name was first suggested by Speranski, under Alexander I. for the suggested parliament of delegates from the *zemstvos* and local *dumas*.

with the outside world cut off; until at last the government was forced to yield, and on the 17/30th of October 1905 the tsar issued the famous manifesto promising to Russia a constitution based on the main principles of modern Liberalism: national representation, freedom of conscience and opinion, guarantees for individual liberty.

The enormous programme of constitutional reform foreshadowed in the manifesto had to be elaborated in haste by Count Witte, the minister of the interior, under circumstances by no means promising. The organs of government seemed paralysed by the repudiation of the principle on which their authority was based, and the empire to be in danger of falling into complete anarchy. The revolutionary terrorists took advantage of the situation to multiply outrages; popular agitation was fomented by a multitude of new journals preaching every kind of extravagant doctrine, now that the censor no longer dared to act; in December the trouble culminated in a formidable rising in Moscow.

The revolutionary terrorists were countered by the terrorists of the reaction who, under the name of "the Union of the Russian People," began an organized extermination of the elements supposed to be hostile to the traditional régime. The "black band" (*chernaya sotnia*), or "black hundreds," as they were branded by public opinion, directed their attacks especially against the Jews, and *pogroms*,¹ i.e. organized wholesale robbery and murder of Jews, occurred in many places, it was believed with the connivance of the police and veiled approval in exalted quarters.

Meanwhile the political parties which were to divide the new Duma had taken shape. Apart from the extremists on one side or the other, frank reactionaries on the Right and Socialists on the Left, two main divisions of opinion revealed themselves in the congresses of the *zemstvos* that met at Moscow in September and November. In the former there had been a fusion between the Radicals, supporters of the autonomy of Poland and a federal constitution for the empire, and the Independence party (*Osvobodivshaya*) formed by political exiles at Paris in 1903, the fusion taking the name of Constitutional Democrats, known (from a word-play on the initials K.D.) as "Cadets." The more moderate elements found a rallying cry in the manifesto of October, took the name of "the Party of 17 October," and became known as "Octobrists." In the *zemstvo* congress of November the "Cadets" protested against the "grant" of a constitution already elaborated, and demanded the convocation of a Constituent Assembly. The Octobrists, on the other hand, supported Count Witte's moderate programme, the most important provisions of which were the extension (11 December 1905) of the suffrage under the stillborn constitution of August, and (20 February 1906) the reorganization of the Duma as the Lower House, and of the Imperial Council (half of which was to be elective) as the Upper House² in the new parliament.

The elections were held in March 1906, and on the 27th of April the emperor Nicholas II. solemnly opened the first Duma of the Empire. The "Cadets" commanded an overwhelming majority in the Lower House, and their intractable temper and ignorance of affairs became at once apparent. The address in reply to the speech from the throne, voted after a debate in which abstract theories had triumphed over common sense, demanded universal suffrage, the establishment of pure parliamentary government, the abolition of capital punishment, the expropriation of the landlords, a political amnesty, and the suppression of the Imperial Council. When the minister of the interior, M. Goremykin, who had succeeded Witte at the head of the government, met these preposterous demands with a flat refusal, the House voted, on the motion of M. Kuzmin-Karaviev, for an appeal to the

people (July 4).³ Four days later the government dissolved the Duma, M. Goremykin at the same time being replaced by M. Stolypin. The "Cadets" refused to accept this action and, in imitation of the famous meeting in the tennis-court at Versailles, adjourned to Vyborg in Finland, where, under the ex-president of the Duma, M. Muromtsov, they drew up and issued a manifesto calling on the Russian people to refuse taxes and military service. Its sole result, apart from the punishment which afterwards fell on its authors,⁴ was to show how little the majority of the dissolved Duma had represented the Russian people. Isolated mutinies in the army followed, and terrorist outrages here and there—notably, in August, the dastardly bomb outrage in the Isle of Apothecaries at St Petersburg, which seriously injured one of M. Stolypin's little daughters; but the mass of the nation and of the army remained wholly unmoved, while the repetition of troubles was made more difficult by the establishment of field courts martial with summary powers.

The second Duma met on the 6th of March 1907. M. Stolypin had not ventured to alter the electoral law without parliamentary consent, but with the aid of a complaisant Senate the provisions of the existing law were interpreted in a restrictive sense for the purpose of influencing the elections. The result was, however, hardly more satisfactory to the government. The "Cadets," it is true, lost many seats both to the Socialists and to the extreme Right, but they held the balance of the House, of which the Octobrists and the Right together only constituted one-fifth, and their leader, M. Golovin, was elected president of the House. The temper of the second Duma, was, indeed, even more democratic than that of the first; but M. Stolypin did his best to work in harmony with it, realizing that under the existing law another dissolution could but lead to a like result, and shrinking from the only alternative—an alteration of the law by a *coup d'état*, a course which could only be justified on the plea of extreme necessity. On the 19th of March he laid before the House his programme of reforms, which included the emancipation of the peasants from the control of the communes and the handing over to them of the crown lands and imperial estates. The majority, however, refused to be reconciled. The abolition of the field courts martial was demanded; on the 13th of April a bill for the expropriation of landlords was carried by a two-thirds majority,⁵ and the 30th the Army Bill would have been lost but for the Polish vote. The crisis came with the discovery of a treasonable plot for the subordination of the army, in which many Socialist members of the Duma were involved. On the 14th of June Stolypin's proposal for the arrest of 16 members and the indictment of 55 was shelved by being referred to a committee.

The excuse for which the government had been waiting was thus provided, and two days later the Duma was dissolved. An imperial *ukaz* fixed the new elections for the 14th of September, and the meeting of the third Duma for the 14th of November; at the same time, in violation of the October manifesto, the electoral law was altered, so as to secure a representation at once more Russian and more conservative. The non-Russian frontier provinces (*obkrainas*) had even before been under-represented (one member for every 350,000 inhabitants, as against one for every 250,000 in the central provinces); the members returned by Poland, the Caucasus and Siberia were now reduced from 89 to 39, those from the Central Asian steppes (23) were swept away altogether; the total number of deputies was reduced from 524 to 442. Even more drastic were the changes in the electoral machinery, by far the most complicated in Europe, established by this law of 1905.⁶ This was based on the principle of indirect

¹ Of this M. Chasles remarks that it would have been a revolutionary act even in republican France.

² They were condemned in 1907 to three months' imprisonment and loss of civil rights.

³ This was reversed, on the 8th of June, by 238 votes to 191, after a patient exposition by M. Stolypin of the fact that there was plenty of land in Russia for the peasants without any attack on private property.

⁴ The electoral law covers 107 octavo pages.

Constitutional manifesto of October 17/30, 1905.

The "Union of the Russian People."

Development of political parties.

The first Duma.

The Vyborg manifesto.

The second Duma.

Alteration by ukaz of the electoral law.

election, through a series of electoral colleges. It was a simple matter to manipulate these so as to throw the effective power into the hands of the propertied classes without ostensibly depriving any one of the vote.¹ The result was that in the third Duma, which met on the 15th of November 1907, the conservative Right preponderated as much as the Left had done in its two predecessors. Its president, M. Khomiakov, had been one of the founders of the "Union of 17 October," but even the Octobrists formed but a third of the House and were compelled to act with the reactionaries of the Right; and the vice-president, Prince Volkonsky, was a member of the Union of the Russian People.

On the whole, the new Duma was fairly representative of the changed temper of the Russian people, disillusioned and weary of anarchy. The government had done wisely in obscuring the passion for democratic ideals by an appeal to Russian chauvinism, an appeal soon to bear fruit in disuniting the revolutionary parties. The congress of *zemstvos*, hitherto the focus of Liberalism, had petitioned the government, before the opening of the third Duma, to take measures for the restoration of order. The authorities began to exhibit something of their old spirit. M. Dubrovin, president of the Union of the Russian People and organizer of *pogroms*, having written a letter of congratulation to the tsar on the occasion of the *coup d'état*, received a gracious reply; the hideous reign of terror of the "Black Hundred" in Odessa did not prevent the Grand-duke Constantine from accepting the badge of membership of the Union. The ordinary laws, too, had been suspended; the fining and confiscation of newspapers had been resumed, and the "Cadets" had been forbidden to hold a congress. All this, however, did not argue an intention on the part of the government to revert to the autocratic *status quo*. M. Stolypin indeed defended the *coup d'état* in the Duma on the ground that the autocrat had merely altered what the autocrat had originally granted; but, while laying stress on the necessity for restoring order in the body politic, he announced a long programme of reforms, including agrarian measures, reform of local government and its extension in the frontier provinces, and state insurance of workmen. The most far-reaching of these reforms, carried in the first session of the third Duma, was the partial abolition of the communal and family ownership of land, which involved the establishment of a class of true peasant-proprietors.² Besides this, the Duma had passed before its adjournment on the 28th of October 1908 much useful legislation, some 300 bills in all, including two for the building of important railways on the Amur and in Siberia. Nor had it exhibited by any means a wholly docile spirit. On the 7th of June, for instance, M. Guchkov attacked the maladministration in the navy, pointing out that no reforms were possible so long as grand-dukes were at the head of its departments. The Duma endorsed this all but unanimously, and as the result the Grand-dukes Peter and Sergius resigned their posts of inspector-general of Engineers and Ordnance respectively, and the Grand-duke Nicholas his chairmanship of the Committee of National Defence. A year later the Duma again came into collision with the government in a matter highly illuminating of the struggle between the ancient traditions and the new ideas in Russia. On the 14th of June 1909 a bill was passed removing the disabilities hitherto attaching to some 15,000,000 of Old Believers. In spite of strenuous government opposition, inspired by the authorities of the Orthodox Church, amendments were carried allowing dissident ministers to assume ecclesiastical titles and to preach, and permitting Christians to join non-Christian religions or even to describe themselves as unbelievers. Thus a step forward was made in securing the freedom of conscience proclaimed in the October manifesto and denounced by a synod of Orthodox bishops at Kiev in 1908, though the rights granted by the Duma were seriously curtailed in the Imperial Council, and have been largely rendered a dead letter by the action of the administration.

Meanwhile the pan-Russian movement had been gaining apace. At first it had seemed that the new birth of Russia would lead to a revival of pan-Slavism, directed not, as in the middle of the 19th century, against Austria but against Germany. In May 1908 a deputation of the Slav members of the Austrian *Reichsrat* paid a ceremonial visit to the Duma at St Petersburg, and in this "neo-Slav" demonstration M. Dmowski, leader of the Polish party in the Duma, took part. In the following year, however, the situation was completely altered, a result due to the growing anti-Polish feeling in the Duma and, more especially, to the support given by the Austrian Slavs to the annexation of Bosnia and Herzegovina. This event caused the utmost excitement in Russia; the crown prince of Serbia, who arrived in St Petersburg on the 28th of October to ask for the armed assistance of the tsar, was received with enthusiasm by all classes of the people; and, though armed intervention was impossible, M. Isvolsky took the lead in the abortive demand for a European conference (see EUROPE: History). Neo-Slav dreams were now replaced by a passionate desire to consolidate the Russian empire on a purely Russian basis. Even the remnant of the "Cadets" had by this time renounced their sympathy with Polish aspirations, and in the matter of Finland the Duma proved itself even more imperial than the emperor himself. The Finnish question is dealt with elsewhere (see FINLAND: History). Here it may suffice to mention, as illustrating the changed temper of the Russian national assembly, *The Duma and Finland*, among the imperial questions in Finland which the Finnish diet ought to refer to the imperial legislature not only all military matters—as the tsar demanded (Rescript of October 14)—but the question of the use of the Russian language in the grand-duchy, the principles of the Finnish administration, police, justice, education, formation of business companies and of associations, public meetings, the press, the customs tariff, the monetary system, means of communication, and the pilot and lighthouse system. The old tendency illustrated by the outcome of the revolutionary movements of 1848 was once more in evidence—the tendency of merely artificial theories of democratic liberty to succumb to the immemorial instinct of race and race ascendancy.

As an international force Russia had been, of course, all but completely crippled by the outcome of the Japanese War and the subsequent revolution. Her recovery, however, *International position of Russia*, revealed the immense reserves of her strength. On the 30th of July 1907 she signed a convention with Japan of mutual respect for treaty and territorial rights, and guaranteeing the integrity of China. On the 31st of August of the same year the long period of mutual suspicion between Great Britain and Russia was closed by a convention for an amicable settlement of all questions likely to disturb the relations of the two Powers in Asia generally, including the demarcation of Persia into spheres of influence (see PERSIA: History). This new *entente* with Great Britain, cemented by a visit paid by King Edward VII. to the tsar at Reval on the 9th June 1908, helped to knit close once more the loosened alliance with France, and so to preserve the threatened balance of Europe. That in the work of restoring its military position the Russian government had the support of the Russian parliament was proved by a subsidy of £11,000,000 voted by the Duma, on the 30th of December 1909, for the special service of the reorganization and redistribution of the army. (W. A. P.)

BIBLIOGRAPHY.—The history of Russia, especially that of the last few years, has formed the subject of a vast number of works, of very varying authority in many languages. In Russia itself the first great history of the Russian empire was that of N. M. Karamzin (12 vols., St Petersburg, 1818–29; French translation, 11 vols., 1819–26), which, though reactionary in tone and largely superseded, remains a classic. The next monumental history of Russia, that of Sergei Mikhailovich Soloviev (29 vols., Moscow, 1863–75), marks the enormous advance made since Karamzin's day in historical method and research. Soloviev's history, from the earliest times to 1774, is based throughout on original investigation of sources, and therefore, though inferior to Karamzin's work as

¹ See above, *Government and Administration*.

² The law establishing individual peasant-proprietorship was passed on December 21st.

literature, is incomparably superior to it in authority. Of other works it is only possible to give a classified selection. In general, the reader must be warned that most Russian works on history, especially those dealing with recent years, are inspired by a violent party bias—the inevitable result of the conflict of diametrically opposed political ideals,—and this quality is shared by not a few foreign books about Russia.

Sources.—See Sienkiewicz, *Recueil de documents relatifs à la Russie, 1502-1842* (1852); Soloviev, *Russian Historical Writers (Pisatel' russkoe isst. in collected works, vol. xviii. sqq.)*; Nikolai Ivanovich Kostomarov (1817-1895), professor of history at Kiev and St Petersburg, whose monographs and researches are collected in his *Sobranie sochineny* (collected works, 21 vols., St Petersburg, 1903-6); V. Burtsev and S. M. Kravchinski, *Za sto let, 1800-1860*. Documents relating to the political and social movements in Russia (London, 1897). There is a French translation by L. Leger (Paris, 1884); the chronicle of Nestor, the main source for early Russian history. The publications of the Imperial Russian Historical Society of St Petersburg, amounting to upwards of 100 vols., are of great value. For diplomatic history, see F. F. de Martens, *Recueil des traités conclus par la Russie avec les puissances étrangères* (St Petersburg, from 1878 still incomplete), which contains valuable historical introductions based on unpublished sources; A. N. Rambaud, *Recueil des instructions aux ambassadeurs de France, vols. viii. and ix., Russie, 1657-1703* (Paris, 1890).

General Works.—In addition to those of Karamzin and Soloviev, already mentioned, see R. Nisbet Bain, *The Pupils of Peter the Great . . . 1697-1740* (Westminster, 1897); *The Daughter of Peter the Great . . . A History of Russian Diplomacy under the Empress Elizabeth Peterovna, 1741-1762* (London, 1897); *Russia, 1613-1725* (1905); K. N. Bestuzhev-Riumin, *Russland, 1700-1725* (St Petersburg, 1872), especially for internal history and social life; A. Brückner, *Gesch. Russlands . . . bis zum Tode Peters des Grossen* (Gotha, 1896); Gaston Créhange, *Histoire de la Russie depuis la mort de Paul I.* (Paris, 1882; 2nd ed. extended to 1894, *ibid.*, 1896); T. von Bernhardi, *Geschichte Russlands . . . 1814-1831* (3 vols., Leipzig, 1868-78); J. W. A. von Eckardt, *Russland vor und nach dem Kriege* (1879; Eng. trans. 1880); N. Flerovski, *Russische Geschichte, Nicholas I., Alexander II., Alexander III.* (Kurs, Gessen, 1897; Ger. transl., Berlin, 1898); V. Kluchevskii, *Kurs russkoe istorii* (1904-8); A. Kleinsmidt, *Drei Jahrhunderte russischer Geschichte, 1568-1868* (Berlin, 1868); A. Krasovskii, *Russia in Asia, 1558-1899* (1899); W. R. Morfill, *Russia* (Story of the Nations Series, New York, 1891); *History of Russia* (New York, 1902); H. H. Munro, *Rise of the Russian Empire* (Boston, 1900); F. Neuberger, *Russland unter Kaiser Alexander III.* (Berlin, 1895); W. R. S. Ralston, *Early Russian History—1613* (1874); A. N. Rambaud, *Histoire de la Russie* (Paris, 1878; new ed. 1900); *Eng. transl.*, of 1st ed. by L. B. Lang, 2 vols., 1879); Theodor Schirmer, *Russland, Polen und Litauen bis im xvi. Jahrhundert* (2 vols., in Oncken's *Allgemeine Gesch.*, Berlin, 1886-87); *Gesch. Russlands unter Kaiser Nikolaus I.* (Kaiser Alexander I. und die Ergebnisse seiner Lebensarbeit, Berlin, 1904, vol. ii, 1908), with appendices giving many unpublished documents; J. H. Schmitzer, *Gesch. des Russischen Reichs* (Leipzig, 1874); F. H. Skrine, *The Expansion of Russia, 1815-1900* (Cambridge, 1903); V. L. P. Thomsen, *The Relation between Ancient Russia and Scandinavia and the Origin of the Russian State* (London, 1877); the series of works by K. Waliszewski under the general title of *Les Origines de la Russie moderne: L'Héritage de Pierre le Grand, 1725-41* (Paris, 1900); *La Russie de To-day*; *La Crise russe, La Crise révolutionnaire, 1848-1864* (1906); *Le Berceau de la Russie, Les Premiers Romanov* (1909). For the relations of Russia with the papacy, see T. Pierling, *Russie et le Saint-Siège, 1417-1758* (4 vols., 1896-1907). The only history of Little Russia is that in Russian by D. N. Bantshy-Kamenskii (Moscow, 1842). Of the numerous books on the Russian revolutionary movement, besides those of "Stepniak," Kropotkin, and other revolutionary writers, the following may be mentioned: C. A. de Arnaud, *The New Era in Russia* (Washington, 1899); E. von der Burgken, *Das heutige Russland* (Eng. trans., *Russia of To-day*, 1904); C. Drage, *Russian Affairs* (New York, 1904); P. N. Miljukov, *La Crise russe* (Paris, 1907; an earlier English edition appeared in 1905); Bernard Pares, *Russia and Reform* (1907); A. Thun, *Geschichte der revolutionären Bewegungen in Russland* (Leipzig, 1883); Konni Zilliacus, *The Russian Revolutionary movement* (London, 1905).

Economic Works.—Georges Alfassa, *La Crise agricole en Russie* (Paris, 1905); Anatole Leroy-Beaulieu, *L'Empire des Tsars* (3 vols., Paris, 1882-88; Eng. trans., 1896), an admirable account, partly historical, partly based on personal observation of the government, religion and the social and economic conditions of Russia; Combes de Lastrapes, *La Russie économique et sociale* (Paris, 1896); "Nikolai" (pseudonym of Danielson), *Histoire des développements économiques de la Russie depuis l'abolition du serfage* (Paris, 1896).

Law and Constitution.—A. Chaslès, *Le Parlement russe* (Paris, 1910); H. D. Edwards, *Das Staatsrecht Russlands* (vol. iv. of Marquardsen's *Handbuch des öffentlichen Rechts*, Freiburg, 1888); S. N. Harper, *The New Electoral Law for the Russian Duma* (Chicago, 1908); J. Kappnit, *Code d'organisation judiciaire russe* (Paris

1893); V. Kluchovski, *Boyarshkaya Duma* (1882), an account of the boyars' *duma* from the 10th to the 17th century; Maksim M. Kovalevski, *Modern Customs and Ancient Laws of Russia* (London, 1891); Max von Ottingen, *Abriss des russischen Staatsrechts* (1899); F. de Rocca, *Les Assemblées dans la Russie ancienne; Zemskii Sobors* (1899); L. Z. Slonimski, *Polit. ensiklopediya* (t. 1, 1907), compiled from the Liberal standpoint.

There is a fuller bibliography of Russian history in vol. xvii. of the *Historians' History of the World* ("Times" ed., 1907), which also includes considerable extracts from Russian works not elsewhere translated. Many additional works will be found s.v. "Russia" in the *Subject Index* of the London Library (1909). (W. A. P.)

RUSSIAN LANGUAGE. For the characteristics which this special branch of the Slavonic family shares with the rest, for a table showing the Russian alphabet and the transliterations of it used in this and in other (non-linguistic) articles of the *Encyclopaedia*, and for the points which distinguish Russian alike from the Southern (Balkan) and from the North-Western (Polish, Czech, &c.) branches of Slavonic, see SLAVS. These latter points, fully treated under corresponding sections of the article SLAVS, are here summarized:—

I. Proto-Slavonic (Proto-Sl.) half vowels *ü* and *ÿ* have disappeared as such: *ü* (*Ъ*), though still written at the ends of words, is mute; it serves but to show that the foregoing consonant is "hard." See V. below for "hard" and "soft" (denoted by 'y) consonants, not the "hard" = *surd*, *lenus*, ("soft" = *sonant*, *media* of Eng. usage. Where a vowel was indispensable to help out a group of consonants, *ü* has been replaced by *o* or *e*, but these vowels sometimes appear without such justification (e.g. *ogont*, Lat. *ignis*); *ÿ* when so needed becomes *e*, otherwise it disappears or else leaves a trace in the "softness" of the preceding consonant, in which case it is still written: Old Slavonic (O.S.), *trъnъ*, "sleep"; *drъt*, "day"; *R. sonû* (*û* mute), *denû* ('d'en').

II. Proto-Sl. *y* survives in R. and Polish. The sound is a "high-mixed-narrow *i*," pronounced with the lips as for *i* and the tongue as for *u*, not unlike Eng. *y* in "rhythm." After labials there is a distinct *w* sound before the vowel. After gutturals it has become *i*.

III. Treatment of Liquids: retention of *r'* instead of the *ř* of N.W. Slav.; retention as in Polish of hard *l* (between *l* and *w*, not unlike Eng. *l* in "milk," "people"); helping out of sonant *r* and *l* by a vowel put in before the *r* or *l*; especially the so-called full vocalism by which, e.g. Proto-Sl. **gorûd*, "town," became R. *gorodû*, O.S. *gradû*, Polish, *gród*; Proto-Sl. **mêko*, "milk," R. *moloko*, O.S. *mêko*, Polish, *mleko*.

IV. Proto-Sl. nasals: *q*. (Fr. *on*), became R. *u*; *e* (Fr. *în*), R. *'a*, *ja*; O.S. *pait*, "way"; *peit*, "five"; R. *puti*, *put'*.

V. Softening (Palatalization, &c.): Proto-Sl. *ÿ*, *dj* gave R. *ÿ*, *ÿ*, Proto-Sl. **sÿlja*, "candle"; **medja*, "boundary"; R. *sveča*, *m'êca*. Proto-Sl. *pj*, *bj*, *ovj*, *gvj* gave R. and S. Slav. *pl*, *bl*, *vl*, *ml*, e.g. R. *z' em' a*; Polish, *ziemia*, "land." Before Proto-Sl. soft vowels *e*, *ÿ*, *i*, *ÿ* consonants were affected, the tongue being raised in anticipation of the narrow vowel, and so not making so clean a contact with the palate. Then what amounted to a new *j* developed in R., as *f* became practically *j*; *e* and *ÿ* (orig. *e*) came to sound as *je*, *e* as *ja* at the beginning of a syllable, and all together with *i* began very much to soften the preceding consonant in literary R.; however, this new *j* never broke down the consonant into a palatalized sibilant or affricate, though it had this effect in White Russian (Wh. R.) and Polish.

The result is that almost every consonant in Russian can be pronounced "hard" or "soft," a distinction which is very difficult for a foreigner to make, as his tendency is to overdo the softness and pronounce a full *j* after the consonant instead of the palatal element melting into it. This is encouraged by the alphabetic system by which the letters *ц* (*ѣ*), *ш*, *ж*, stand for *je*, *ju*, *ja* at the beginning of a syllable, but after a consonant merely indicate that the consonant is soft, the vowel being the same as in *з*, *у*, *а* (*е*, *и*, *а*), e.g. *т ж* stands for *t'-a* rather than for *t-ja*. A soft consonant in its turn narrows the vowel before it, e.g. the vowel in *жёлт*, "fir," is like *a* in "Yale"; that in *жёлт*,

"marks" a hypothetical form

"ate," like *e* in "yell"; *e* and $\frac{3}{2}$ ($\frac{3}{2}$) are now indistinguishable, except that accented *e* before a hard consonant has a tendency to be pronounced *jo*, e.g. *s' elu*, "of villages," is pronounced *s' ol*, but *sélú*, "sat," *s' el*: $\frac{3}{2}$ = *jo* is sometimes denoted by $\frac{3}{2}$.

VI. Great Russian has kept *g* where Little Russian (Lit. R.) and Wh. R., like Čech and High Sorb, now have *h*.

VII. A specially Russian point is that Proto-Sl. *je* and *ju* beginning a word, appear in R. as *o* and *u*; O.S. *jednŭ*, "one," *jutro*, "morning," R. *odínŭ*, *utro*.

VIII. Russian has lost the distinctions of quantity which survive in Čech and S. Slav., but its accent is free as in S. Slav. The accent is extremely capricious, often falling differently in different cases of the same noun, or persons of the same tense, also it is an expiratory accent, so strong that the unaccented syllables are much slurred over and their vowels dulled. In learning Russian it is therefore most important to pay great attention to the accent, and at first to read accented texts.

The above phonetic peculiarities have marked Russian as far back as we can trace it. In the earliest documents it appears with an apparatus of grammatical forms practically identical with that ascribed to primitive Slavonic. The history of the language is not so much that of its phonetic decay as that of its morphological simplification and syntactic development. The tracing of this process is rendered difficult by the fact that O.S. was the ecclesiastical and literary language until the 17th century, and though in the end the O.S. texts suffer modifications, producing the Russian form of Church Slavonic, it is only by accident that the Russian forms appear in them. Russian is better represented in additions made by the scribe, as in the colophon of the Ostromir gospel (A.D. 1056/57), the oldest dated O.S. MS. In a certain number of legal documents dating from the 12th century onwards Russian forms definitely predominate, but the subject-matter is too limited to offer much material.

Borrowings.—The effect of the Church language upon Russian has been very strong, comparable to that of Latin upon French or English: O.S. forms of words and suffixes, betrayed by their phonetic peculiarities though pronounced more or less *à la russe*, have in some cases ousted the native forms, in other cases the two exist side by side; the Slav. form generally has the more dignified or metaphorical, the Russian the simpler and more direct sense: even some of the grammatical terminations (e.g. pres. part. act.; certain forms of the adj., &c.) are Slavonic; but speakers are quite unconscious of using anything that is not Russian (see S. Bulič, *Church Slavonic Elements in Modern Russian*, St P., 1893), and not till the 18th century did even grammarians understand the difference. Less important elements have been the Tatar which gave names for many Oriental things such as weapons, jewels, stuffs, garments and some terms concerned with government, and the Polish, which during the 17th century supplied many terms needed to express European things and ideas. In the 18th century such importations were made from Latin and all the Western European languages, in Peter's time mostly from German and Dutch (for nautical terms, English supplied some), in Catherine's ruder from French, which had become the language of the aristocracy. During the first quarter of the 19th century modern Russian found itself and discarded superfluous Slavonic and European borrowings alike. Since then fresh loan-words have mostly belonged to the international quasi-Greek terminology, though like German R. sometimes prefers analogous compounds made from its own roots.

Literary Russian as spoken by educated people throughout the empire is the Moscow dialect (see below) modified by these influences. It is still a highly inflected language, comparable in that respect rather to Latin and Greek than to the languages of western Europe, though during historic time it has lost many of the grammatical forms whose full development we can study in O.S., and whose presence we can assert in the scanty remains of Old R. This process has relieved it of the dual number, save for certain survivals; in the nouns, of the vocative case (save for certain ecclesiastical forms), and many

of the distinctions between the declensions, especially in the plural, the oblique cases of the simple, and the more cumbersome forms of the compound, adjective; in the verbs, of the supine, the imperfect, the aorist and the conditional (now reduced to a participle); but this simplification leaves it with six cases, Nom., Acc., Gen., Dat., Instrumental and Locative, three genders, three substantial declensions, -*a*, -*o*, -*i*, and traces of -*u* and consonantal stems, a special pronominal declension with many tricky forms, an adjective which takes its place between them, and a system of numerals in which a compromise between grammar and logic has produced a kind of maze. The forms of the verb are easier, as only the present indic. has three persons, the imperat. has but the 2nd, and the past is a participle, which, having discarded the copula, distinguishes only gender and number. The infinitive and four participles offer no special difficulty, but the gerundives or verbal adverbs, from the old masc. nom. sing., are troublesome. The curious mechanism by which these few verbal forms are by means of the aspects made to express most of our tenses and other shades of meaning of which even English is incapable, is briefly explained under SLAVS. On the whole the syntax is simple, the periods which imitation of Latin and German once brought into fashion having given place to the shorter sentences of French and English models.

Such a language, though less difficult than it is generally supposed, is learned much better if some preliminary study is devoted to the accidence, before the student launches out into conversation, as otherwise the habit may be acquired of disregarding the terminations and speaking very incorrectly.

Dialects.—Russian dialects fall into two main divisions—Great (Velikoruskij), including White (Béloruskij) Russian, and Little Russian (Maloruskij). The latter is spoken in a belt reaching from Galicia and the Northern Carpathians (see RUTHENIANS) through Podolia and Volhynia and the governments of Kiev, Chernigov, Poltava, Khárkov and the southern part of Vorónezh to the Don and the Kubán upon which the Dněpr Cossacks were settled. To the south of this belt in "New Russia" the population is much mixed, but Little Russians on the whole predominate. In all there must be about 30,000,000 Little Russians.

The Great Russian division includes all other Russian speakers—the main body to the N. and E. of the Little Russians, the settlers in Siberia, the Caucasus and along the southern coast, the educated classes, officials and many townsmen throughout the empire, probably not less than 70,000,000 speakers exclusive of White Russians. On the whole it is very conservative, and therefore, in spite of its vast extent, is wonderfully uniform. It falls into two main dialect groups—the northern or *o* group and the southern or *a* group. The line between them runs roughly E.S.E. from Pskov to the Oka and then eastwards to the Urals. The northern group is the more conservative and pronounces very nearly according to the spelling, unaccented *o* remaining *o*, but *o* is in general rather like *u*, while *e* before hard consonants is apt to be *jo* and before soft consonants *i*. The southern part of this group, comprising most of the governments of Vladímir and Yarosláv with adjoining parts of Tver and Kostromá, are alone free from a further peculiarity, a tendency to mix up *e* and $\frac{3}{2}$ which can be traced in the ancient documents of Nóvgorod and has spread with the Nóvgorod colonists across the whole of N. Russia to the Urals and Siberia. These distant dialects have adopted many words from the Ugro-Finnish natives. The southern or *a* group of dialects pronounces unaccented *o*, *e* and even *i* as *a* or *ja*; with this goes a tendency to pronounce *g* as *h*, and to mix up *u* and *v*. The Moscow dialect, which is the foundation of the literary language, and White Russian, are both best classed with the *a* dialect.

The Moscow dialect really covers a very small area, not even the whole of the government of Moscow, but political causes have made it the language of the governing classes and hence of literature. It is a border dialect, having the southern pronunciation of unaccented *o* as *a*, but in the *jo* for accented $\frac{3}{2}$

before a hard consonant it is akin to the North and it has also kept the northern pronunciation of *g* instead of the southern *h*. So too unaccented *e* sounds like *i* or *ji*.

White Russian, in the governments of Vitěbsk, Mohilév and Minsk, and adjoining parts of Pskov, Smolensk, Chernigov and Vilna (some 10,000,000 speakers), appears at first so different from Great Russian that it was long classed as a separate division. It was the official language of the Lithuanian principality afterwards merged in Poland and hence was under strong Polish influence. Little R. was under somewhat similar influence, so that the two dialects have approximated in some respects; but originally White Russian was not much nearer Lit. R. than was any other south G. R. dialect. In its main characteristic Wh. R. approximates to Polish, but this likeness goes deeper than the surface Polishisms above referred to, as it falls into its natural place in the classification of Slavonic languages by the phenomena of "softening." Accordingly *t* and *d*, when soft or before soft *v*, become *č* and *ď*, e.g. *R. t'šlo*, "body," *d'šlo*, "deed," *m'adv'ed*, "bear," Wh. *čelo*, *ďselo*, *m'adv'ed*, Polish *ciato*, *dielo*, *niedźwiędź*. Other special points which distinguish Wh. R. from the other dialects are a tendency to confuse *u* and *v* and to pronounce either of them as a *w*, the same sound also taking the place of hard *l* closing a syllable; *r* is always hard; *f*, a sound essentially non-Slavonic, appears as *ch* or *chw*, e.g. *čhrancuz*, R. *francuz*, "a Frenchman," *Ch'odar*, R. *F'odor*, "Theodore."

In incidence we may note the preservation of the vocative; of the sibilants before case terminations where R. has restored gutturals by analogy, e.g. locatives *nasě, rucě, sasě, R. nogě, rukě, sochě*, from *noğs*, "foot," *ruká*, "hand," *sochá*, "plough"; and of the 3rd sing. pres. ind. in *č* for *l'*, or without any *l'*. *V'ad'seč* or *v'ad'seč* for R. *ved'otú*, "leads."

On the boundary between Wh. R. and the Novgorod dialect the former has the latter's confusion of *č* and *ž*.

The best account of Wh. R. is E. Karskij, *Sketch of the Sounds and Forms of Wh. R. Speech* (Moscow, 1886); there is a dictionary by Novosiv (St. P., 1875). Bezsonov, *Wh. R. Songs* (Moscow, 1871), and P. V. Schein in a whole series of publications give good specimens of the dialect.

The Little Russian dialect claims to be a literary language; it has established this claim in Galicia (see RUTHENIANS), but its use as such is much restricted in Russia. The Little Russians differ from the Great Russians not only in language but in physical type, customs, domestic architecture and folk-lore; but though Russophobes have tried to prove that this is due to the Finnish element in the Great Russians, it cannot be substantiated, and the Little Russians, especially the descendants of the Cossacks, have no small Tatar element in them. For the last three centuries they have been under strong Polish influence, and this has had great effect upon the vocabulary but not much on phonetics or morphology. Little Russian is divided into three main groups of dialects: those of Hungary, which show an approximation to Slovak; those of Galicia, which rather recall Polish; and those of the Ukrain and other districts in Russia, which gradually shade into South Great Russian and White R., though the love of the sound *o* is noticeably absent. Little Russian is rather characterized by itacism; for original *y* and original *i* have coincided in a sound between *i* and *y* not unlike the Eng. short *i*, and original *ě*, also *e* and even *o* after having been lengthened in compensation for lost semi-vowels are now represented by *i*.

Further, Little Russian has reduced the common Russian softening, only keeping it before *a* and *o* and *i* for *č* and *o*, and hardening the consonant before *e* and original *i*. In common with Wh. R. it has *h* for *g*, a vocative case, gutturals made sibilant before *i* (for *ž*) in oblique cases, 3rd sing. without the *t*, 1st plur. in *-mo* and *-me* instead of *mú, nn* for *nj, ll* for *ff*, *w* for *u*, *v* and hard *l*, but all these occur more or less throughout S. Russian and only tend to a superficial resemblance.

These phonetic peculiarities are not universal, but the presence of the narrowed *č*, *e* and *o* is sufficient to mark a dialect as Little Russian. The Russian alphabet is modified for Little Russian

use as *r = h* and hence *t = g*; *č* is used for the *e* which does not soften the preceding vowel, *u* for the thick and *i* for the pure *i*.

BIBLIOGRAPHY.—Dictionaries: *Dict. of the R. Language*, published by the Second Section of the Imperial Academy of Sciences (4 vols., St Petersburg, 1847; new ed., 1891—); V. I. Dahl, *Explanatory D. of Living Great R. Language* (Moscow, 1880), re-ed. by J. Baudouin de Courtenay (1906); I. I. Sreznevskij, *Materials for a Dict. of Old R. Language* (to T.) (St. P., 1903); *Atsemit (Opýtá) at a Great R. Provincial Dict.* (Supplement to the old Dict. of the Acad.) (St. P., 1882); A. Alexandrov, *R. Eng. and Eng.-R. Dict.* (2 vols., St. P.); J. Pawlowsky, *R.-Deutsches Wörterbuch* (Riga, 1900).
Little Russian Dictionary: Eug. Zelechowski, *Ruthenisch-Deutsches Wörterbuch* (Lemberg, 1886).

Grammars: Th. Buslaev, *Historical Grammar of the R. Language* (Moscow, 1875); A. Sobolevskij, *Lectures on the History of the R. Language* (St. P., 1891); id., *Atsemit at R. Dialectology*, pt. i. (Gt. and Wh. R.) (St. P., 1897); W. R. Morfill, *R. Grammar* (Oxford, 1887); P. Motti, *R. Conversation Grammar* (London, 1890); C. R. Reiff, *R. Grammar* (London, 1883); O. Asbóth, *Kurse R. Grammatik* (Leipzig, 1900); R. Abicht, *Die Hauptschwierigkeiten der R. Sprache* (Leipzig, 1897); P. Boyer, M. Speranski and S. Harper, *Russian Reader* (Chicago, 1906).

Little Russian Grammar: St. Smal'-Stocky and Fed. Gartner, *Ruska Grammatyka* (Lemberg, 1893); see also Miklosich, *Vergl. Gram. d. Slav. Sprachen*, passim (Vienna, 1875-84).

Many accented texts are published by R. Gerhard, Leipzig. Th. Buslaev, *Historical R. Chrestomathy* (Moscow, 1861), gives specimens of Russo-Slavonic, Old R. and Dialects. The chief periodicals containing scientific papers on the R. language are the *Sbornik* (Miscellany) and *Izvestia* (Bulletin) of the Second Section of the St. P. Academy, and the *Zapiski* (Transactions) of the Philological Faculty of Old Russian universities. Old Russian Texts are published mostly by the *Obščestvo L'ubitelej Drevnej Pis'mennosti* (Soc. of Lovers of Ancient Literature) in St Petersburg. (E. H. M.)

RUSSIAN LITERATURE. To get a clear idea of Russian literature, it will be most convenient for us to divide it into oral and written. The first of these sections includes the interesting *byliny*, or "tales of old time," as the word may be translated, which have come down to us in great numbers, as they have been sung by wandering minstrels all over the country. The scholars who have given their attention to these compositions have made the following division of them into cycles: (1) that of the older heroes; (2) that of Vladimir, prince of Kiev; (3) that of Novgorod; (4) that of Moscow; (5) that of the Cossacks; (6) that of Peter the Great; (7) the modern period. These poems, if they may be so styled, are not in rhyme; the ear is satisfied with a certain cadence which is observed throughout. For a long time they were neglected, and the collection of them began only towards the conclusion of the 17th century. The style of Russian literature which prevailed from the time of Lomonosov was wholly based upon the French or pseudo-classical school. It was, therefore, hardly likely that these peasant songs would attract attention. But when the gospel of romanticism was preached and the *History* of Karamzin appeared, a new impulse was given to the collection of all the remains of popular literature. In 1804 appeared a volume based upon those which had been gathered together by Cyril or Kirsha Danilov, a Cossack, at the beginning of the 18th century. They were received with much enthusiasm, and a second edition was published in 1818. In the following year there appeared at Leipzig a translation of many of these pieces into German, in consequence of which they became known much more widely. This little book of 160 pages is important because the originals of some of the *byliny* translated in it are now lost. Since that time large collections of these poems have been published, edited by Rybnikov, Hilferding, Sreznevskij, Avenarius and others.

These curious productions have all the characteristics of popular poetry in the endless repetitions of certain conventional phrases—the "green wine," "the bright sun" (applied to a hero), "the damp earth" and others. The heroes of the first cycle are monstrous beings, and seem to be merely impersonifications of the powers of nature; such are Volga Vseslavich, Mikula Selianovich and Sviatogor. They are called the *bogatyri staršie*. Sometimes we have the giants of the mountain, as Sviatogor, and the serpent Gorinich, the root of part of both

Peasant songs.

names being *gora* (mountain). The serpent Gorinich lives in caves, and has the care of the precious metals. Sometimes animal natures are mixed up with them, as *zmei-bogatyr*, who unites the qualities of the serpent and the giant, and bears the name of Tugarin Zmievich. There is the Pagan Idol (*Idolitsche Poganskoie*), a great glutton, and Nightingale the Robber (*Solovey Razboinik*), who terrifies travellers and lives in a nest built upon six oaks.

In the second cycle the legends group themselves round the celebrated Prince Vladimir of Kiev. The chief hero is Ilya Muromets, who performs prodigies of valour, and is of gigantic stature and superhuman strength. The cycle of Novgorod deals with the stories of Vasilii Buslaevich and Sadko, the rich merchant. The fourth cycle deals with the autocracy; already Moscow has become the capital of the future empire. We are told of the taking of Kazan, of the conquest of Siberia by Yermak, of Ivan the Terrible and his confidant Maliuta Skuratovich. It is observable that in the popular tradition Ivan is not spoken of with any hatred. As early as 1610 some of these *byliny* were committed to writing by Richard James, an Oxford graduate who was in Russia as chaplain of the embassy. The most pathetic is that relating to the unfortunate Xenia, the daughter of Boris Godunov. Yermak, the conqueror of Siberia, forms the subject of a very spirited lay, and there is another on the death of Ivan the Terrible. Considering the relation in which she stood to the Russians, we cannot wonder that Marina, the wife of the false Demetrius, appears as a magician. Many spirited poems are consecrated to the achievements of Stenka Razin, the bold robber of the Volga, who was for a long time a popular hero. The cycle of Peter the Great is a very interesting one. We have songs in abundance on the achievements of the tsar, as the taking of Azov in 1696. There is also a poem on the execution of the *streltsy*, and another on the death of Peter. In the more modern period there are many songs on Napoleon. The Cossack songs, written in the Little Russian language, dwell upon the glories of the *sech*, the sufferings of the people from the invasions of the Turks and Mongols, the exploits of the Haidamaks and, lastly, the fall of the Cossack republic. Besides these, the Russians can boast of large collections of religious poems, many of them containing very curious legends. In them we have a complete store of the beliefs of the Middle Ages. A rich field may be found here for the study of comparative mythology and folk-lore. Many of them are of considerable antiquity, and some seem to have been derived from the Midrash. Some of the more important of these have been collected by Beszonov. Besides the *byliny* or legendary poems, the Russians have large collections of *skazki* or folk-tales, which have been gathered together by Sakharov, Afanasiev and others. They also are full of valuable materials for the study of comparative mythology.

Leaving the popular and oral literature, we come to what has been committed to writing. The earliest specimen of

Earliest written literature.

Russian, properly so called, must be considered the Ostromir Codex, written by the *diak* Gregory at the order of Ostromir, the *posadnik* or governor of Novgorod. This is a Russian recension of the Slavonic Gospels, of the date 1056-57. Of the year 1073 we have the *Izbornik* or "Miscellany" of Sviatoslav. It was written by John the *diak* or deacon for that prince, and is a kind of Russian encyclopaedia, drawn from Greek sources. The date is 1076. The style is praised by Buslaev as clear and simple. The next monument of the language is the *Discourse concerning the Old and New Testament*, by Hilarion, metropolitan of Kiev. In this work there is a panegyric on Prince Vladimir of Kiev, the hero of so much of the Russian popular poetry. Other writers are Theodosius, a monk of the Pestchersky cloister, who wrote on the Latin faith and some *Pouchenia* or "Instructions," and Luke Zhidiata, bishop of Novgorod, who has left us a curious *Discourse to the Brethren*. From the writings of Theodosius we see that many pagan habits were still in vogue among the people. He finds fault with them for allowing these to continue, and also for their drunkenness; nor do the monks escape his censures.

Zhidiata writes in a more vernacular style than many of his contemporaries; he eschews the declamatory tone of the Byzantine authors.

With the so-called *Chronicle of Nestor* (*g.v.*) begins the long series of the Russian annalists. There is a regular catena of these chronicles, extending with only two breaks *Annalists and travellers.* to the time of Alexis Mikhailovich, the father of Peter the Great. Besides the work attributed to Nestor, we have chronicles of Novgorod, Kiev, Volhynia and many others. Every town of any importance could boast of its annalists, Pskov and Suzdal among others. In some respects these compilations, the productions of monks in their cloisters, remind us of the *Anglo-Saxon Chronicle*, dry details alternating with here and there a picturesque incident; and many of these annals abound with the quaintest stories. There are also works of early travellers, as the igumen Daniel, who visited the Holy Land at the end of the 11th and beginning of the 12th century. A later traveller was Athanasius Nikitin, a merchant of Tver, who visited India in 1470. He has left a record of his adventures, which has been translated into English and published for the Hakluyt Society. Later also is the account written by the two merchants, Korobeinikov and Grekov. They were sent with a sum of money to the Holy Sepulchre to entreat the monks to pray without ceasing for the soul of the son of Ivan the Terrible, whom his father had killed. A curious monument of old Slavonic times is the *Pouchenie* ("Instruction"), written by Vladimir Monomakh for the benefit of his sons. This composition is generally found inserted in the *Chronicle of Nestor*; it gives a quaint picture of the daily life of a Slavonic prince.

In the 12th century we have the sermons of Cyril, the bishop of Turov, which are attempts to imitate in Russian the florid Byzantine style. In his sermon on Holy Week, Christianity is represented under the form of spring, Paganism and Judaism under that of winter, and evil thoughts are spoken of as boisterous winds. And here may be mentioned the many lives of the saints and the Fathers to be found in early Russian literature. Some of these have been edited by Count Bezborodko in his *Pamiatniki Starinnoy Russkoy Literatury* ("Memorials of Ancient Russian Literature").

We now come to the story of the expedition of Prince Igor, which is a kind of *bylina* in prose, and narrates the expedition of Igor, prince of Novgorod-Severskiy, against the Polovtzes. The manuscript was at one time preserved in a monastery at Yaroslavl, but was burnt in the great fire at Moscow in the year 1812. Luckily the story had been edited (after a fashion) by Count Musin-Pushkin, and a transcript was also found among the papers of the empress Catherine.

The Story of Igor.

The original was seen by several men of letters in Russia, Karamzin among the number. There is a mixture of Christian and heathen allusions, but there are parallels to this style of writing in such a piece as the "Discourse of a Lover of Christ and Advocate of the True Faith," from which an extract has been given by Buslaev in his *Chrestomathy*. There is a great deal of poetical spirit in the story of Igor, and the metaphors are frequently very vigorous. Mention is made in it of another bard named Boyan, but none of his inspirations have come down to us. A strange legend is that of the tsar Solomon and Kitovras, but the story occurs in the popular literatures of many countries. Some similar productions among the Russians are merely adaptations of old Bulgarian tales, especially the so-called apocryphal writings. The *Zadonstchina* is a sort of prose poem such in the style of the "Story of Igor," and the resemblance of the latter to this piece and to many other of the *skazania* included in or attached to the Russian chronicle, furnishes an additional proof of its genuineness. The account of the battle of the "Field of Woodcocks," which was gained by Dmitri Donskoy over the Mongols in 1380, has come down in three important versions. The first bears the title "Story of the Fight of the Prince Dmitri Ivanovich with Mamai"; it is rather meagre in details but full of expressions showing the patriotism of the writer. The second version is more complete in its historical details, but still is not without

Other popular tales.

anachronisms. The third is altogether poetical. The *Povest o Drakule* ("Story of Drakula") is a collection of anecdotes relating to a cruel prince of Walachia who lived in the 15th century. (See RUMANIA, *History*.) Several of the barbarities described in it have also been assigned to Ivan the Terrible.

The early Russian laws present many features of interest, such as the *Russkaya Pravda* of Yaroslav, which is preserved in the chronicle of Novgorod; the date is between 1018 and 1054. The laws show Russia at that time to have been in civilization quite on a level with the rest of Europe. But the evil influence of the Mongols was soon to make itself felt. The next important code is the *Sudebnik* of Ivan III., the date of which is 1497; this was followed by that of Ivan IV. of the year 1550, in which we have a republication by the tsar of his grandfather's laws, with additions. In the time of this emperor also was issued the *Sloglav* (1551), a body of ecclesiastical regulations. Mention must also be made of the *Ulozhenie* or "Ordinance" of the tsar Alexis. This abounds with enactments of sanguinary punishment: women are buried alive for murdering their husbands; torture is recognized as a means of procuring evidence; and the knout and mutilation are mentioned on almost every page. Some of the penalties are whimsical: for instance, the man who uses tobacco is to have his nose cut off; this was altered by Peter the Great, who himself practised the habit and encouraged it in others.

In 1553 a printing press was established at Moscow, and in 1564 the first book was printed, an "Apostol," as it is called, i.e. a book containing the Acts of the Apostles and the Epistles. The printers were Ivan Feodorov and Peter Timofeiev; a monument has been erected to the memory of the former. As early as 1548 Ivan had invited printers to Russia, but they were detained on their journey. Feodorov and his companions were soon, however, compelled to leave Russia, and found a protector in Sigismund III. The cause appears to have been the enmity of the copyists of books, who succeeded in drawing over to their side the more fanatical priests. The first Slavonic Bible was printed at Ostrog in Volhynia in 1581. Another press, however, was soon established at Moscow; up to 1600 sixteen books had been issued there.

A curious work of the time of Ivan the Terrible is the *Domostroy*, or "Book of Household Management," which is said to have been written by the monk Sylvester. This priest was at one time very influential with Ivan the Terrible. Ivan, but ultimately was banished to the Solovetsky monastery on the White Sea. The work was originally intended by Sylvester for his son Anthemius and his daughter-in-law Pelagia, but it soon became very popular. We have a faithful picture of the Russia of the time, with all its barbarisms and ignorance. We see the unbending authority of the husband in his own household: he may inflict personal chastisement upon his wife; and her chief duty lies in ministering to his wants. To the reign of Ivan the Terrible must also be assigned the *Chetii-Minei* or "Book of Monthly Readings," containing extracts from the Greek fathers, arranged for every day of the week. The work was compiled by the metropolitan Macarius, and was the labour of twelve years. An important writer of the same period was Prince Andrew Kurbskiy, descended from the sovereigns of Yaroslavl, who was born about 1528. In his early days Kurbskiy saw a great deal of service, having fought at Kazan and in Livonia. But he quarrelled with Ivan, who had begun to persecute the followers of Sylvester and Adashev, and fled to Lithuania in 1563, where he was well received by Sigismund Augustus. From his retreat he commenced a correspondence with Ivan, in which he reproached him for his many cruelties. Ivan in his answer declared that he was quite justified in taking the lives of his slaves if he thought it right to do so. Kurbskiy died in exile in 1583. He also wrote a life of Ivan, but Bestuzhev Riumin thinks that his hatred of Ivan led him to exaggerate, and he regrets that Karamzin should have followed him so closely. Besides the answers of

Ivan to Kurbskiy, there is his letter to Cosmas and the brotherhood of the Cyrillian monastery on the White Lake (Bielo Ozero), in which he reproaches them for the self-indulgent lives they are leading. Other works of the 16th century are the *Stepennaya Kniga*, or "Book of Degrees" (or "Pedigrees"), in which historical events are grouped under the reigns of the grand-dukes, whose pedigrees are also given; and the *Life of the Tsar Feodor Ivanovich* (1584-98), written by the patriarch Job.

To the beginning of the 17th century belongs the *Chronograph* of Sergius Kubasov of Tobolsk. His work extends from the creation of the world to the accession of Michael Romanov, and contains interesting accounts of such members of the Russian royal family as Kubasov had himself seen. Something of the same kind must have been the journal of Prince Mstislavskiy, which he showed the English ambassador Jerome Horsey, but which is now lost.¹

To the time of the first Romanovs belongs the story of the siege of Azov, a prose poem, which tells us, in an inflated style, how in 1637 a body of Cossacks triumphantly repelled the attacks of the Turks. There is also an account of the siege of the Troitzka monastery by the Poles during the "Smutnoe Vremya," or Period of Troubles, as it is called—that which deals with the adventures of the false Demetrius and the Polish invasion which followed. But all these are surpassed by the work on Russia of Gregory Karpov Kotoshikhin. He served in the ambassador's office (*posolskiy prikaz*), and when called upon to give information against

his colleagues fled to Poland about 1664. Thence he passed into Sweden and wrote his account of Russia under Alexis Mikhailovich at the request of Count Delagardie, the chancellor. He was executed in 1667 for slaying in a quarrel the master of the house in which he lived. The manuscript was found by Professor Soloviev of Helsingfors at Upsala and printed in 1840. The picture which Kotoshikhin draws of his native country is a sad one, and from his description, and the facts we gather from the *Domostroy*, we can reconstruct the Old Russia of the time before Peter the Great. Perhaps, as an ex-ile, Kotoshikhin allowed himself to write too bitterly. A curious work is the *Uriadnik Sokolnichia Puti* ("Directions for Falconry"), which was written for the use of the emperor Alexis, who, like many Russians of old time, was much addicted to this pastime. The Serb, Yuri Krzhanich, who wrote in Russian, was the first pan-Slavist, anticipating Kollar by one hundred and fifty years or more. He wrote a critical Servian grammar (with comparison of the Russian, Polish, Croatian and White Russian), which was edited from the manuscripts by Bodianski in 1848. For his time he had a very good insight into Slavonic philology. His pan-Slavism, however, sometimes took a form by no means practical. He went so far as to maintain that a common Slavonic language might be made for all the peoples of that race—an impossible project which has been the dream of many enthusiasts. He was banished to Siberia, and finished his grammar at Tobolsk. He also wrote a work on the Russian empire in the middle of the 17th century, completed in 1676, which was edited by Beszonov in 1860. The picture drawn, as in the corresponding production of Kotoshikhin, is a very gloomy one. To this period belongs the life of the patriarch Nikon by Shusherin. The struggles of Nikon with the tsar, and his emendations of the sacred books, which led to a great schism in Russia, are well known. They have been made familiar to Englishmen by the eloquent pages of the late Dean Stanley.² From this revision may be dated the rise of the Rascolniks (Dissenters) or Staro-obriadtsi (those who adhere to the old ritual). With Simeon Polotzki (Polotzki) (1628-1680) the old period of Russian

¹ Horsey says: "I read in their cronicells written and kept in secret by a great priem prince of that country named Knez Ivan Fedorovich Misioloiskoie, who, out of his love and favour, imparted unto me many secrets observed in the memory and procis of his tyme, which was lowresore years, of the state, natur, and government of that commonwealch."—Bond, *Russia at the Close of the Sixteenth Century* (Hakluyt Society, 1856).

² *Lectures on the Eastern Church*.

literature may be closed. He was tutor to the tsar Feodor, son of Alexis, and may be said to have helped to introduce the culture of the West into Russia, as he was educated at Kiev, then a portion of Polish territory. Polotzki came to Moscow about 1664. He wrote religious works (*Vienets Viery*, "The Garland of Faith"), and composed poems and religious dramas (*The Prodigal Son*, *Nebuchadnezzar*, &c.). He has left us some droll verses on the tsar's new palace of Kolomenskoe, which are very curious doggerel. The artificial lions that roared, moved their eyes, and walked especially delighted him. There does not seem to be any ground for the assertion (often met with even in Russian writers) that Sophia, the sister of Peter the Great, was acquainted with French, and translated some of the plays of Molière.

And now all things were to be changed. Russia was to adopt the forms of literature in use in the West. One of the chief helpers of Peter the Great in the education of the people was Feofane (Theophanes) Procopovich (*moderna period*, 1681-1736), author of the Ecclesiastical Regulations and some plays, who advocated the cause of science; the old school was defended by Stephen Yavorski (1658-1722), whose *Rock of Faith* was written to refute the Lutherans and Calvinists. Another remarkable writer of the times of Peter the Great was Possokhov (b. 1673), a peasant by birth, who produced a valuable work on *Poverty and Riches*. Antioch Kantemir (1708-1744), son of a former hospodar of Moldavia, wrote some clever satires still read; they are imitated from Boileau. He also translated parts of Horace. Besides his satires, he published versions of Fontenelle's *Pluralité des Mondes* and the histories of Justin and Cornelius Nepos. He was for some time Russian ambassador at the courts of London and Paris. But more celebrated than these men was

Lomonosov. Michael Lomonosov (q.v.). He was an indefatigable writer of verse and prose, and has left odes, tragedies, didactic poetry, essays and fragments of epics.

Vassili Tatistchev (1686-1750) was the author of a Russian history which is interesting as the first attempt in that field. He was disgraced for peculation, and died at Astrakhan, as governor, in 1750. His work was not given to the world till after his death. There had been a slight sketch published before by Khilkov, entitled the *Marrow of Russian History*. Boris Trediakovski (1703-1766) was born at Astrakhan, and we are told that Peter, passing through that city at the time of his Persian expedition, had Trediakovski pointed out to him as one of the most promising boys of the school there. Whereupon, having questioned him, the tsar said with truly prophetic insight, "A busy worker, but master of nothing." His *Telemakhida*, a poem in which he versified the *Télémaque* of Fénelon, drew upon him the derision of the wits of the time. He had frequently to endure the rough horse-play of the courtiers, for the position of a literary man at that time in Russia was not altogether a cheerful one. His services, however, to the Russian language were great.

From the commencement of the reign of Elizabeth Russian literature made great progress, the French furnishing models.

Sumarokov. Alexander Sumarokov (1718-1777) wrote prose and verse in abundance—comedies, tragedies, idyls, satires and epigrams. He is, perhaps, best entitled to remembrance for his plays, which are rhymed, and in the French style. His *Dmitri Samovannets* ("Demetrius the Pretender") is certainly not without merit. Some of the pieces of Kniazhin had great success in their time, such as *The Chatterbox*, *Kniazhinia*.

Originals and especially *The Fatal Carriage*. He is now almost forgotten. In 1756 the first theatre was opened at St Petersburg, the director being Sumarokov. Up to this time the Russians had acted only religious plays, such as those written by Simeon Polotzki. The reign of Catherine II. (1762-96), herself a voluminous writer, saw the rise of a whole generation of court poets. Everything in Russia was to be forced like plants in a hot-house; she was to have Homers, Pindars, Horaces and Virgils. Michael Kheraskov (1743-1807) wrote besides other poems two enormous epics—the *Rossida* in twelve books, and *Vladimir* in eighteen; they are now but little read. Hippolitus Bogdanovich (1743-1803) wrote a pretty lyric piece, *Dushenka*, based upon La Fontaine, and telling the old story of the loves of Cupid and Psyche. With Ivan Khemnitzner begins the long list of fabulists; this half-oriental form of literature, so common in countries ruled absolutely, has been very popular in Russia. Khemnitzner (1744-1784), whose name seems to imply a German origin, began by translating the fables of Gellert, but afterwards produced original

specimens. A writer of real national comedy appeared in Denis von Visin, probably of German extraction, but born at Moscow (1744-1792). His best production is *Nedorosits* ("The Minor"), in which he satirizes the coarse features of Russian society, the ill-treatment of the serfs, and other matters. He saw France on the eve of the great Revolution, and has well described what he did see. Russian as he was, and accustomed to serfdom, he was yet astonished at the wretched condition of the French peasants. The great poet of the age of Catherine, the laureate of her glory, was Gabriel Derzhavina (1733-1816). He essayed many styles of composition, and was a great master of his native language. There is something grandiose and organ-like in his high-sounding verses; unfortunately he occasionally degenerates into bombast. His versification is perfect; and he had the courage to write satirically of many persons of high rank. His *Ode to God* is the best known of his poems in Western countries. He was a student of Ossian, and of Edward Young, the author of the *Night Thoughts*. Other celebrated poems of Derzhavina are *Felitsa*, *Odes on the Death of Prince Mestcherski*, *The Noblemen*, *The Taking of Ismail*, and *The Taking of Warsaw*. His Memoirs were published in 1857.

An unfortunate author of the days of Catherine was Alexander Raditschev (1749-1802), who, having, in a small work, *A Journey to St Petersburg and Moscow*, spoken too severely of the miserable condition of the serfs, was punished by banishment to Siberia, from which he was afterwards allowed to return, but not till his health had been permanently injured by his sufferings. An equally sad fate befell the spirited writer Nicholas Novikov (1744-1818), who, after having worked hard as a journalist, and done much for education in Russia, fell under the suspicion of the government and was imprisoned by Catherine. On her death he was released by her successor. The short reign of Paul was not favourable to literary production; the censorship of the press was extremely severe, and many foreign books were excluded from Russia.

But a better state of things came with the reign of Alexander, one of the glories of whose day was Nikolai Karamzin (q.v.). His chief work is his *History of the Russian Empire*, but he appeared in the fourfold aspect of historian, novelist, essayist and poet, nor need we do more than mention the celebrated Archbishop Latkov (q.v.) Ivan Dmitriev (1760-1837) wrote some pleasing lyrics and epistles, but without much force. He appears from his translations to have been well acquainted with the English poets. Ozerov (1760-1816) wrote a great many tragedies, which are but little read now. They are in rhyming alexandrines. He occasionally handled native subjects with success, as in his *Dmitri Donskoy* (1807) and *Yaropolk and Oleg* (1780).

In Ivan Kriloff (q.v.) the Russians found their most general fabulist. As Derzhavina was the poet of the age of Catherine, so Kriloff Zhukovskiy (1763-1852) may be said to have been that of the age of Alexander. It is more remarkable, however, as a translator than as an original poet. With him Romanticism began in Russia. He became reader to the empress and afterwards tutor to her children. In 1802 he published his version of Gray's *Elegy*, which at once became a highly popular poem in Russia. Zhukovskiy translated many pieces from the German (Goethe, Schiller, Uhland) and English (Byron, Moore, Southey). One of his original productions, "The Poet in the Camp of the Russian Warriors," was on the lips of every one at the time of the War of the Fatherland (1806-1812).

Translations. Constantine Batushkov (1787-1855) was the author of many elegant poems, and at the outset of his career promised much, but sank into imbecility, and lived in this condition to an advanced age. Merzliakov and Tziganov deserve a passing notice as the writers of songs some of which still keep their popularity. During his short life (1799-1837) Alexander Pushkin produced many celebrated poems, which will be found enumerated in the article devoted to him (see PUSHKIN). In Alexander Griboyedov (1795-1829) (q.v.) the Russians saw the writer of one of their most clever comedies (*Gore et Uma*), which may perhaps be translated into the line of being "Too Clever" (lit. "Cried out of Wit"). Ivan Kozlov (1774-1838) was author of some pretty original lyrics, and some translations from the English, among others Burns's *Collar's Saturday Night*. He became a cripple and blind, and his misfortunes elicited some cheering and sympathetic lines from Pushkin, which will always be read with pleasure.

Pushkin found a successor in Michael Lermontov (q.v.), who

Vista.

Derzhavina.

Raditschev.

Nicholas Novikov.

Karamzin.

Platon.

Ozerov.

Kriloff.

Zhukovskiy.

Batushkov.

Gnedich.

Batushkov.

Pushkin.

Griboyedov.

Kozlov.

has left us many exquisite lyrics. A genuine bard of the people, and one of their most truly national authors, was Alexis Koltsov (1809-1842), the son of a tallow merchant of Voronezh. He has left us a few exquisite lyrics, which are to be found in all the collections of Russian poetry. Koltsov died of consumption after a protracted illness. Another poet who much resembled Koltsov was Ivan Nikitin (1826-1861), born in the same town of Voronezh. His best poem was *Kudlak*, Nikitin, to support his relations, was obliged to keep an inn; this he was afterwards enabled to change for the more congenial occupation of a bookseller. The novel in Russia has had its cultivators in Zagoskin and Lazhechnikov, who imitated Sir Walter Scott. The most celebrated of the romances of Zagoskin was *Yuri Mioslavskiy*, a tale of the expulsion of the Poles from Russia in 1612. The book may even yet be read with interest: it gives a very spirited picture of the times; unfortunately, a gloss is put upon the barbarity of the manners of the period. Among the better known productions of Lazhechnikov are *The Heretic* and *The Palace of Ice*. A flashy but now forgotten writer of novels was Thaddeus Bulgarin (1789-1850) author of *Ivan Yshigin*, a work which once enjoyed considerable popularity.

The first Russian novelist of great and original talent was Nicolai Gogol (1809-1852) (g.n.). In his *Dead Souls* he satirized all classes of society, some of the portraits being wonderfully vivid. Being a native of Little Russia, he describes its scenery and the habits of the people, especially in such stories as the *Old-Father's House* and *The Government Inspector*. His best *Bubba*. This last is a highly wrought story giving us a picture of the savage warfare carried on between the Cossacks and Poles. Gogol was also the author of a good comedy, *The Revisor*, wherein the petty pilferings of Russian municipal authorities are satirized. In his *Memoirs of a Madman* and *Portraits*, he shows a weird and fantastic power which proves him to have been a man of strong imagination. The same may be said of *The Cloak*, and the curious tale *Viv* ("The Demon"), where he gives us a picture of Kiev in the old days.

In the field of fiction Gogol had various famous successors, concerning whom details will be found in separate articles. It must suffice here to enumerate Alexander Herzen (d. 1869); Ivan Goncharov (1812-1891); Dmitri Grigorovich (1822-1899), author of *The Fisherman and The Emigrants*; Alexis Pisemskiy (1822-1900); Michael Saltikov (1826-1889); Feodor Dostoevskiy (1821-1881); Alexander Ostrovskiy (1823-1886); Feodor Kischetnikov (1841-1871); Count A. Tolstoy (1817-1875), also famous as a dramatist; and greater than all these Ivan Turgeniev (1819-1883), and Count L. Tolstoy (1828-1910), the last of whom ranks as much more than a mere letter-writer.

In Visarion Belinski the Russians produced their best critic. For thirteen years (1834-47) he was the Aristarchus of Russian literature and exercised a healthy influence. In his later days he addressed a withering epistle to Gogol on the newly adopted reactionary views of the latter.

Since the time of Karamzin the study of Russian history has made great strides. He was followed by Nicholas Polevov (1775-1842), who wrote what he called the *History of the Russian People* (6 vols., 1829-33), but his work was not received with much favour. Polevov was a self-educated man, the son of a Siberian merchant; besides editing a well-known Russian journal, *The Telegraph* (suppressed in 1834), he was also the author of many plays, among others a translation of *Hamlet*. Since his time, however, the English dramatist has been produced in a more perfect dress by Kronberg, Druzhinin and others. Sergius Soloviev (1820-1879) was the author of a *History of Russia* which may be described rather as a quarry of materials for future historians of Russia than an actual history. In 1885 died N. Kostomarov, the author of many valuable works on Russian law, and K. Malatchev published a classical edition of the old Russian codes. Ilvovskiy and Gedeonov attempted to upset the general belief that the founders of the Russian empire were Scandinavians. A good history of Russia (1855) was published by N. Ustrialov, but his most celebrated work was his *Tzarstvennoe Petra Velikogo* ("Reign of Peter the Great"); in this many important documents first saw the light, and the circumstances of the death of the unfortunate Alexis were made clear. Russian writers of history have not generally occupied themselves with any other subject than that of their own country, but an exception may be found in the writings of Timofei Granovskiy (1813-1855), such as *Abd Sager* (1849) and *Four Historical Portraits* (1850). So also Kudriav-

tsov, who died in 1850, wrote on "The Fortunes of Italy, from the Fall of the Roman Empire of the West till its Reconstruction by Charlemagne." He also wrote on "The Roman Women as described by Tacitus." We may add Kareyev, professor at Warsaw, who wrote on the condition of the French peasantry before the Revolution. Other writers on Russian history have been H. Pogodin (d. 1873), who compiled a *History of Russia till the Invasion of the Tartars* (1871), and especially I. Zabelin, who has written a *History of Russian Life from the most Remote Times* (1876), and the *Private Lives of the Czarinas and Czsars* (1869 and 1872) and a *History of Moscow*. Leshkov has written a *History of Russian Law to the 18th Century*, and Tchitcherin a *History of Provincial Institutions in Russia in the 17th Century* (1856). To these must be added the work of Zagoskin, *History of Law in the State of Muscovy* (Kazan, 1877). Professor Michael Kovalevskiy, of the university of Moscow, wrote an excellent work on *Communal Land Tenure*, in which he investigates the remains of this custom throughout the world. In 1885 Dvubrovnik published an excellent history of the revolt of Pugachev. The valuable work by Alexander Pypin (b. 1833) and Vladimir Spasovich, *History of Slavonic Literatures*, is the most complete account of the subject, and has been made more generally accessible by the German translation of Pech. N. Tikhonravov (1832-1893) wrote a *Chronicle of Russian Literature and Antiquities* (5 vols., 1859-61). The *History of Slavonic Literature* by Schafarik, published in 1826, has long been antiquated. A history of Russian literature by Paul Folevov has appeared, which has gone through two editions. The account of the *Pol-Slav* of 1861 and 1878, published in 1873, and which gave many startling and picturesque episodes of the celebrated struggle, was withdrawn from circulation. It appeared originally in the pages of the Russian magazine *Starina*.

Nicholas Nekrasov, who died in 1877, left six volumes of poetry which in many respects remind us of the writings of Crabbe; the poet is of that realistic school in which Russian authors **Poets**, so much resemble English. Another writer of poetry deserving mention is Ogariev, for a long time the companion in exile of Herzen in England; many of his compositions appeared in the *Pol-Slav* of the latter, which was a collection of interesting autobiographical sketches of Herzen, entitled *Byloe i Dumy* ("The Past and my Thoughts"). Apollon Maikov (1821-1847) at one time enjoyed great popularity as a poet; he is a kind of link with Pushkin, of whose elegance of versification he is an imitator. Another poet of a past generation was Prince Viazemskiy (1792-1878). Graceful lyrics were written by Mei, Fet (whose name would apparently prove Dutch extraction, Veth), Stcherbina, and, going a little further back, Yazykov, the friend of Pushkin, and Khomiakov, celebrated for his Slavonic pronouncements. To these may be added M. Milde, Zhadovskaya, Benediktov, Podolinskoy and Tjutchev. Polonskoy (1820-1898) contributed exquisite lyrics to the *Viestnik Vevropi*.

Excellent works on subjects connected with Slavonic philology have been published by Vostokov, who edited the *Ostromir Codex*, and Sreznjevskiy and Bodianskiy, who put forth an edition of the celebrated codex used at Reims for the coronation of the French kings. After their deaths their work was carried on by Professor Grot (*Philological Investigations*), also many critical editions of Russian classics), Budilovik, professor at Warsaw, Potebnya of Kharkov, and Baudouin de Courtenay, who, among other services to philology, has described the Slavonic dialect spoken by the Resanians, a tribe living in Italy, in two villages of the Julian Alps. The songs (*byliny*) of the Russians have been collected by Zakrevskiy, Rybnikov, Hliferding, Barsov and others, and their national tales by Sakharov, Afanasiev and Erlenvien. Kotliarskevskiy, Tereshenko and others have treated of their customs and superstitions. S. Stanislaus Mikutskiy, professor at the university of Warsaw, has published his *Materials for a Dictionary of the Basis of the Russian and Old Slavonic Dialects*, but a somewhat obsolete school of philology. The Early Russian Text Society continues its useful labours, and has edited many interesting monuments of the older Slavonic literature. Two valuable codices have been printed in Russia, Zographus and Marianus, interesting versions of the Gospels in Palaeoslavonic. They were edited by the learned Croat Jagic, who occupied the chair of Sreznjevskiy in St Petersburg. An excellent *Tolkovi Slovar Velikorusskogo Yazyka* ("Explanatory Dictionary of the Great Russian Language") was compiled by Vladimir Dahl. Alexander Hliferding published some valuable works on ethnology and a philology, among others on the Polabs, an extinct Slavonic tribe who once dwelt on the banks of the Elbe. The Russians have not exhibited many works in the field of classical or other branches of philology. Exception, however, must be made of the studies of Tchubinov in Georgian, Minayev in the Indian and Tsvetayev in the old languages of Italy.

In moral and mental philology the Russians have produced but few authors. We meet with some good mathematicians, Labachevskiy among others, and in natural science the publications of the Society for the Natural History at Moscow have attracted considerable attention. *Recent Literature*—The death of Nekrasov in 1877 deprived Russia of her most eminent poet since the days of Pushkin and

Philo-

logists.

Lermontov. During the last generation of the 19th century most of the Titans of her literature departed, and cannot be said to have left successors of equal merit. Dostoievsky, Pisemsky, Turgeniev, Goncharov, Ostrovsky and Saltikov followed each other to the grave in rapid succession. Leo Tolstoy alone remained, a veritable patriarch, whose views on life gave him a world-interest beyond even the contributions of his great prose fiction. In 1805 Apukhtin, author of many of our best lyrics, died; in 1807 Apollon Maikov, a year soon afterwards, Polonsky. These were well known throughout Russia. A new school of poets has sprung up, consisting for the most part of the so-called decadents and symbolists. Among them may be mentioned A. Korinsky; Ivan Bunin, who has published an excellent translation of Longfellow's *Hiawatha*; and Constantine Balmont. The last of these has given to the public several volumes of lyrics, many of which exhibit a graceful imagination. He has been a successful translator of Shelley, and of Edgar Allan Poe, Ibsen and Calderon. We must also mention V. Briusov and K. Sluchevsky, Mme. Gippius-Merzhkovskaya and Mme. Myrrha Lkhvitskaya. Excellent historical novels have been written by Merzhkovskiy (Merejkovskiy (q.v.)). The drama is not in a flourishing condition. Very little of merit has been produced since the great trilogy (1866-69) of Alexis Tolstoy dealing with the reign of Ivan the Terrible—full of picturesque horrors for the dramatist—and the *bourgeois* comedies of Ostrovsky.

If we turn to history, in which the Russians have always shown considerable talent, we can cite some really good work. We cannot here find room to discuss the memoirs and other documents which appear in the *Annuaire Russe* (*Russkaya Starina*), the *Historical Messenger* (*Istoricheskiy Vestnik*) and other journals, the names of which is legion. In 1807 Professor Bestuzhev-Riumin, of the university of St Petersburg, died. He had held his chair of history since 1865. His valuable *History of Russia* must now remain a torso only, the first volume and the first half of the second having alone appeared. Soloviev and Kostomarov are dead. The famous school of Russian historians is thus almost extinct. But some excellent writers in this department have come to the front. Professor Miljukov has started his *Sketches of the History of Russian Culture* (*Očerki russkoi kul'tury*), which has been much read. Professor Bilbasov wrote a *History of Catherine II* and N. Shilder a *Life of Alexander I.* D. Evarnitskiy has added a third volume to his interesting work on the Zaporozhian Cossacks. The Russians have always enjoyed a considerable reputation as memoir-writers, and the *Recollections of Mme. Smirnov*, which first appeared in the *Northern Messenger* (*Sivernyi Vestnik*), proved very interesting. Pushkin appears here before us in the most minute details of his everyday life. The centenary of his birth (1809) was signalized by the publication of many interesting monographs on his strange career. The details of his life, however, L. Pavlovich has written, especially noteworthy. The second volume appeared of the classical *History of the Russian Church*, by E. Golubinskiy. A valuable contribution to early Russian history was furnished by the *Legal Antiquities* (*Yuridicheskaya Drevnost'*) of V. Sergueievich, by which quite a new light has been thrown upon the Russian *sobor*. The well-known savant, Maxime Kovalevskiy, published the second volume of his *Economic Development of Europe to the Rise of Capitalism*. N. Rozhkov wrote an important work entitled *Village Economy in Muscovy in the Sixteenth Century*. This book analyses the conditions under which economic production was developed in Old Russia. S. Platonov published a *History of the Insurrections in Russia in the Sixteenth and Seventeenth Centuries*. He holds entirely new views on the *oprichina*, the famous bodyguard of Ivan the Terrible. Professor B. Kliuchevsky, of the university of Moscow, published in 1883 a valuable book on the Russian Duma, as the privy council of the emperors was called, and in 1890 he issued his *Aids to Lectures on Russian History*. Russian writers have not often devoted themselves to the political and social conditions of other countries, but an exception may be made in the case of the books by Professor A. Vinogradov, formerly of Moscow, especially his *Investigations into the Social History of England in the Middle Ages* (1887). The learned author, who was called to Oxford as Corpus professor of jurisprudence, also prepared an edition of this work for the English public. In fiction no new writers appeared of equal calibre to Gogol, Turgeniev, Dostoievskiy and Tolstoy. But A. Chekhov showed considerable power in his short stories. Some of the tales of Gorki (q.v.), Erel and Yasinskiy are also of great merit. The brilliant Garshin died insane in 1888.

A few words may be said on the literature of the Russian dialects, the Little and White Russian. The Little Russian is a *byanka* (tales) and songs. Peculiar to them is the *duma*, a narrative poem which corresponds in many particulars with the Russian *bylina*. Since the commencement of the 19th century, the Little Russian *dumy* have been repeatedly edited, as by Maksimovich Metlinskiy and others, and an elaborate edition was undertaken by Dragomanov and Antonovich. Just as the *byliny* of the Great Russians, so also these *dumy* of the Little Russians admit of classification, and they have been divided by their latest editors as follows: (1) the songs of the *druzhina*, treating of princely and their followers; (2) the Cossack period (*Kozachestvo*), in which the Cossacks are

found in continual warfare with the Polish *panns* and the attempts of the Jesuits to introduce the Roman Catholic religion; (3) the period of the Haidamaks, who formed the nucleus of the national party, and prolonged the struggle.

The foundation of the Little Russian literature (written, as opposed to the oral) was laid by Ivan Kotliarevskiy (1769-1838), whose travesty of part of the *Aeneid* enjoys great popularity among some of his countrymen. Others, however, object to it as tending to bring the language or dialect into ridicule. A truly national poet appeared in Taras Shevchenko, born at the village of Kirilovka, in the government of Kiev, in the condition of a serf. The strange adventures of his early life he has told us in his autobiography. He did not get his freedom till some time after he had reached manhood, when he was purchased from his master by the generous efforts of the poet Zhukovskiy and others. Besides poetry, he occupied himself with painting, with considerable success. He unfortunately became obnoxious to the government, and was banished with exile to Siberia from 1847 to 1857. He did not long survive his return, dying in 1861, aged forty-six. No one has described with greater vigour than Shevchenko the old days of the Ukraine. In his youth he listened to the village traditions handed down by the priests, and he has faithfully reproduced them. In the powerful poem entitled *Haidamak* we have a graphic picture of the horrors enacted by Gonta and his followers at Uman. The funeral of the poet was a vast public procession; a great cairn, surmounted with a cross, was raised over his remains, where he lies buried near Kanov on the banks of the Dnieper. His grave has been sanctified by the fact that Siberia from 1847 to 1857. A complete edition of his works, with interesting biographical notices—one contributed by the novelist Turgeniev—appeared at Prague in 1876. Besides the national songs, excellent collections of the South Russian folk-tales have appeared, edited by Dragomanov, Rudchenko, and others. Many of these are still recited by the *tchumaki*, or wandering pedlars. A valuable work is the *Zapiski o Uzhnoy Rossii* ("Papers on Southern Russia"), published at St Petersburg in 1857 by Panteleimon Kulish. After he got into trouble (with Kostomarov and Shevchenko) for his political views, the late works of this author show that he had undergone a complete change. Other writers using the Little Russian language are Marko-Vovchok (that is, Madame Eugenia Markovitch) and Yuri Fedkovich, who employs a dialect of Bukovina. Fedkovich, like Shevchenko, sprang from a peasant family, and served as a soldier in the Austrian army against the French during the Italian campaign. Naturally we find his poems filled with descriptions of life in the camp. Like the Croat Preradovic, he began writing poetry in the German language, till he was turned into more natural paths by some patriotic friends. A collection of songs of Bukovina was published at Kiev in 1875 by Lonachevskiy. Eugene Zelchovskiy compiled a valuable *Dictionary of Little Russian*. There is a good grammar by Osadtsa, a pupil of Mikloshich.

In the White Russian dialect are to be found only a few songs, with the exception of portions of the Scriptures and some legal documents. A valuable dictionary has been published by Nosovich, but this is one of the most neglected of the Russian dialects. Collections of White Russian songs have been published by Shein and others.

BIBLIOGRAPHY.—A. Fyfin, *History of Russ. Lit.* (in Russian); A. Brückner, *Geschichte der Russ. Lit.* (Leipzig, 1905, Eng. trans. E. H. Minns, London, 1909); A. Skabichevskiy, *History of the Latest Russ. Lit., 1848-1802* (in Russian, St Petersburg, 1897); *Gallery of Russian Writers* (in Russian, Moscow, 1901); *Russian Poets*, compiled by A. Salnikov (in Russian, St Petersburg, 1901); L. Wiener, *Anthology of Russ. Lit.* (New York, 1902); Rosa Newnarth, *Poetry and Progress in Russia* (London, 1907). (W. R. M.)

RUSSO-JAPANESE WAR, 1904-5. The seizure by Russia of the Chinese fortress of Port Arthur, which she had a few years previously, in concert with other powers, compelled Japan to relinquish, was from the Russian point of view the logical outcome of her eastward expansion and her need for an ice-free harbour on the Pacific. The extension of the Trans-Siberian railway through Manchuria to Port Arthur and a large measure of influence in Manchuria followed equally naturally. But the whole course of this expansion had been watched with suspicion by Japan, from the time of the Saghalien incident of 1875, when the island power, then barely emerging from the feudal age, had to cede her half of the island to Russia, to the Shimonoeki treaty of 1895, when the powers compelled her to forego the profits of her victory over China. The subsequent occupation of Port Arthur and other Chinese harbours by European powers, and the evident intention of consolidating Russian influence in Manchuria, were again and again the subject of Japanese representations at St Petersburg, and these representations became more vigorous when, in 1903, Russia seemed to be about to extend her Manchurian policy into Korea. No less than ten draft treaties

White
Russian
dialect.

were discussed in vain between August 1903 and February 1904, and finally negotiations were broken off on February 5th.¹ Japan had already on the 4th decided to use force, and her military and naval preparations, unlike those of Russia, kept pace with her diplomacy.

This was in fact an eventuality which had been foreseen and on which the naval and military policy of Japan had been based for ten years. She too had her projects of expansion and hegemony, and by the Chino-Japanese War she had gained a start over her rival. The reply of the Western powers was first to compel the victor to maintain the territorial integrity of China, and then within two years to establish themselves in Chinese harbours. From that moment Japanese policy was directed towards establishing her own hegemony and meeting the advance of Russia with a *fait accompli*. But her armaments were not then adequate to give effect to a strong-handed policy, so that for some years thereafter the government had both to impose heavy burdens on the people and to pursue a foreign policy of marking time, and endured the fiercest criticism on both counts, for the idea of war with Russia was as popular as the taxes necessary to that object were detested. But as the army and the navy grew year by year, the tone of Japanese policy became firmer. In 1902 her position was strengthened by the alliance with England; in 1903 her army, though in the event it proved almost too small, was considered by the military authorities as sufficiently numerous and well prepared, and the arguments of the Japanese diplomatists stiffened with menaces. Russia, on the other hand, was divided in policy and consequently in military intentions and preparations. In some quarters the force of the new Japanese army was well understood, and the estimates of the balance of military power formed by the minister of war, Kuropatkin, coincided so remarkably with the facts that at the end of the summer of 1903 he saw that the moment had come when the preponderance was on the side of the Japanese. He therefore proposed to abandon Russian projects in southern Manchuria and the Port Arthur region and to restore Port Arthur to China in return for considerable concessions on the side of Vladivostok. His plan was accepted, but "a lateral influence suddenly made itself felt, and the completely unexpected result was war." Large commercial interests were in fact involved in the forward policy, "the period of heavy capital expenditure was over, that of profits about to commence," and the power and intentions of Japan were ignored or misunderstood. Further, Dragomirov, a higher military authority even than Kuropatkin, declared that "Far Eastern affairs were decided in Europe." Thus Russia entered upon the war both unprepared in a military sense, and almost entirely indifferent to its causes and its objects. To the guards and patrols of the Manchurian railway and the garrisons of Port Arthur and Vladivostok, 80,000 in all, Japan could, in consequence of her recruiting law of 1896, oppose a first-line army of some 270,000 trained men. Behind these, however, there were scarcely 200,000 trained men of the older classes, and at the other end of the long Trans-Siberian railway Russia had almost limitless reserves.² The strategical problem for Japan was, how to strike a blow sufficiently decisive to secure her object, before the at present insignificant forces of the East Siberian army were augmented to the point of being unassailable. It turned, therefore, principally upon the efficiency of the Trans-Siberian railway and in calculating this the Japanese made a serious underestimate. In consequence, far from applying the "universal service" principle to its full extent, they trained only one-fifth of the annual contingent of men found fit for service. The quality of the army, thus composed of picked men (a point which is often forgotten), approximated to that of a professional force; but this policy had the result that, as there was no adequate second-line army, parts of the first-line had to be reserved, instead of being employed at the front. And when for want of these active troops the first great victory proved indecisive,

¹ Belated declarations of war appeared on the 10th.

² The total Russian army on a peace footing is almost 1,000,000 strong.

half-trained elements had to be sent to the front in considerable numbers—indeed the ration strength of the army was actually trebled. The aim of the war, "limited" in so far that the Japanese never deluded themselves with dreams of attacking Russia at home, was to win such victories as would establish the integrity of Japan herself and place her hegemony in the Far East beyond challenge. Now the integrity of Japan was worth little if the Russians could hope ultimately to invade her in superior force, and as Port Arthur was the station of the fleet that might convoy an invasion, as well as the symbol of the longed-for hegemony, the fortress was necessarily the army's first objective, a convincing Sedan was the next. For the navy, which had materially only a narrow margin of superiority over the Russian Pacific Squadron, the object was to keep the two halves of that squadron, at Port Arthur and Vladivostok respectively, separate and to destroy them in detail. But in February weather these objects could not be pursued simultaneously. Prior to the break-up of the ice, the army could only disembark at Chemulpo, far from the objective, or at Dalny under the very eyes of its defenders. The army could therefore, for the moment, only occupy Korea and try to draw upon itself hostile forces that would otherwise be available to assist Port Arthur when the land attack opened. For the navy, instant action was imperative.

On the 8th of February the main battle-fleet, commanded by Vice-Admiral Togo, was on the way to Port Arthur. During the night his torpedo-boats surprised the Russian squadron in harbour and inflicted serious losses, and later in the day the battleships engaged the coast batteries. Repulsed in this attempt, the Japanese established a stringent blockade, which tried the endurance of the ships and the men to the utmost. From time to time the torpedo-craft tried to run in past the batteries, several attempts were made to block the harbour entrance by sinking vessels in the fairway, and free and deadly use was made by both sides of submarine mines. But, though not destroyed, the Port Arthur squadron was paralysed by the instantaneous assertion of naval superiority.

Admiral Alexieiev, the tsar's viceroy in the Far East and the evil genius of the war, was at Port Arthur and forbade the navy to take the risks of proceeding to sea.³ For a time, when in place of Admiral Starck (who was held responsible for the surprise of February), Admiral Makárov, an officer of European reputation, commanded the fleet, this lethargy was shaken off. The new commander took his ships to sea every day. But his energetic leadership was soon ended by a tragedy. A field of electro-mechanical mines was laid by the Japanese in the night of April 12th-13th, and on the following day the Japanese cruisers stood inshore to tempt the enemy on to the mine-field. Makárov, however, crossed it without accident, and pursued the cruisers until Togo's battle-fleet appeared, whereupon he went about and steamed for port. In doing so he recrossed the mine-field, and this time the mines were effectual. The flagship "Petropavlovsk" was struck and went down with the admiral and 600 men, and another battleship was seriously injured. Then the advocates of passivity regained the upper hand and kept the squadron in harbour, and henceforward for many months the Japanese navy lay unchallenged off Port Arthur, engaging in minor operations, covering the transport of troops to the mainland, and watching for the moment when the advance of the army should force the Russian fleet to come out. Meantime seven Japanese cruisers under Vice-Admiral Kaimamura went in search of the Russian Vladivostok squadron; this, however, evaded them for some months, and inflicted some damage on the Japanese mercantile marine and transports. The Japanese had not waited to gain command of the sea before beginning the sea transport of that part of their troops allotted to Korea. The roads of that country were so poor that the landing had

Ob-
jects of
the
Japanese
attack.

Makárov
at Port
Arthur.

³ A vivid picture of the state of affairs in the navy at this period is given in Semenov's *Rasplata* (Eng. trans.).

to be made, not on the Straits of Tsushima, but as far north as possible. Chemulpo, nearer by 50 m. to Port Arthur than to Japan, was selected. On the first day of hostilities Rear-Admiral Uru disembarked troops at Chemulpo under the eyes of the Russian cruiser "Variag," and next day he attacked and destroyed the "Variag" and some smaller war-vessels in the harbour, and the rest of the 1st Army (General Kuroki) was gradually brought over during February and March, in spite of an unbeaten and, under Makárov's régime, an enterprising hostile navy. But owing to the thaw and the subsequent break-up of the miserable Korean roads, six weeks passed before the columns of the army (Guard, 2nd and 12th divisions), strung out along the "Mandarin road" to a total depth of six days' march, closed upon the head at Wiju, the frontier town on the Yalu. Opposite to them they found a large Russian force of all arms.

The Russian commanders, at this stage at least, had not and could not have any definite objective. Both by sea and by land their policy was to mass their resources, repulsing meantime the attacks of the Japanese with as much damage to the enemy and as little to themselves as possible. Their strategy was to gain time without immobilizing themselves so far that the Japanese could impose a decisive action at the moment that suited them best. Both by sea and by land, such strategy was an exceedingly difficult game to play. But afloat, had Makárov survived, it would have been played to the end, and Togo's fleet would have been steadily used up. One day, indeed (May 15th), two of Japan's largest battleships, the "Hatsume" and the "Yashima," came in contact with free mines and were sunk. One of them went to the bottom with five hundred souls. But the admiral was not on board. The Russian sailors said, when Makárov's fate was made known, "It is not the loss of a battleship. The Japanese are welcome to two of them. It is *he*." Not only the skill, but the force of character required for playing with fire, was wanting to Makárov's successors.

It was much the same on land. Kuropatkin, who had taken command of the army, saw from the first that he would have to gain three months, and disposed his forces as they came on the scene, unit by unit, in perfect accord with the necessities of the case. His expressed intention was to fight no *battle* until superiority in numbers was on his side. He could have gained his respite by concentrating at Harbin or even at Mukden or at Liao-Yang. But he had to reckon with the fleet¹ at Port Arthur. He knew that the defences of that place were defective, and that if the fleet were destroyed whilst that of Togo kept the sea, there would be no Russian offensive. He therefore chose Liao-Yang as the point of concentration, and having thus to gain time by force instead of by distance, he pushed out a strong covering detachment towards the Yalu.

But little by little he succumbed to his *milieu*, the atmosphere of false confidence and passivity created around him by Alexeiev. After he had minutely arranged the Eastern Detachment in a series of rearguard positions, so that each fraction of it could contribute a little to the game of delaying the enemy before retiring on the positions next in rear, the commander of the detachment, Zasilich, told him that "it was not the custom of a knight of the order of St George to retreat," and Kuropatkin did not use his authority to recall the general, who, whether competent or not, obviously misunderstood his mission. Thus, whilst the detachment was still disposed as a series of rearguards, the foremost fractions of it stood to fight on the Yalu, against odds of four to one.

The Japanese 1st Army was carefully concealed about Wiju until it was ready to strike. Determined that in this first battle against a white nation they would show their mettle, the Japanese lavished both time and forethought on the minutest preparations. Forethought was still busy when, in accordance with instructions from Tokio, Kuroki on the 30th of April ordered the attack to begin at daybreak on the 1st of May. For several miles above Antung the rivers Yalu and Aihō are

¹ Not, as is often assumed, the fortress itself.

parallel and connected by numerous channels. The majority of the islands thus formed were held and had been bridged by the Japanese. The points of passage were commanded by high ground a little farther up where the valleys definitely diverge, and beyond the flank of the ill-concealed positions of the defence. The first task of the right division (12th) was to cross the upper Yalu and seize this. To the Guard and 2nd divisions was assigned the frontal attack on the Chiuliencheng position, where the Russians had about one-half of their forces under Major-General Kashtalinski. On the 30th of April, Inouye's 12th division accomplished its task of clearing the high ground up to the Aihō. The Russians, though well aware that the force in their front was an army, neither retired nor concentrated. Zasilich's medieval generalship had been modified so far that he intended to retreat when he had taught the Japanese a lesson, and therefore Kuropatkin's original arrangements were not sensibly modified. So it came about that the combined attack of the 2nd and Guard divisions against the front, and Inouye on the left flank and rear, found Kashtalinski without support. After a rather ineffective artillery bombardment the Japanese advanced in full force, without hesitation or finesse, and plunging into the river, stormed forward under a heavy fire. A few moments afterwards Zasilich ordered the retreat. But the pressure was far too close now. Broken up by superior numbers the Russian line parted into groups, each of which, after resisting bravely for a time, was driven back. Then the frontal attack stopped and both divisions abandoned themselves to the intoxication of victory. Meanwhile, the right attack (12th division) encountering no very serious resistance, crossed the Aihō and began to move on the left rear of the Russians. On the side of the defence, each colonel had been left to retire as best he could, and thus certain fractions of the retreating Russians encountered Inouye's advancing troops and were destroyed after a most gallant resistance. The rearguard itself, at Hamatan, was almost entirely sacrificed, owing to the wrong direction taken in retreating by its left flankguard. Fresh attempts were made by subordinates to form rearguards, but Zasilich made no stand even at Feng-hwang-cheng, and the Japanese occupied that town unopposed on the 5th of May. The Japanese losses were 1100 out of over 40,000 present, the Russian (chiefly in the retreat) at least 2500 out of some 7000 engaged.

The Yalu, like Valmy, was a moment in the world's history. It mattered little that the Russians had escaped or that they had been in inferior numbers. The serious fact was that they had been beaten.

The general distribution of the Russian forces was now as follows: The main army under Kuropatkin was forming, by successive brigades, in two groups—I. Siberian Corps (Stakelberg), Niu-chwang and Kaiping; II. Siberian Corps, Liao-Yang. Zasilich (III. Corps and various other units) had still 21,000. In the Port Arthur "fortified rayon," under Lieut.-General Stoessel (IV. Corps), were 27,000 men, and General Linievich around Vladivostok had 23,000. These are, however, paper strengths only, and the actual number for duty cannot have been higher than 110,000 in all. The Trans-Siberian railway was the only line of communication with Europe and western Siberia, and its calculated output of men was 40,000 a month in the summer. In October 1904, therefore, supposing the Japanese to have used part of their forces against Port Arthur, and setting this off against the absence of Linievich and Stoessel, Kuropatkin could expect to have a sufficient superiority in numbers to take the offensive. His policy was still, "No battle before we are in superior force."

For the moment it was equally Japan's interest to mark time in Manchuria. Still intent upon the Russian Port Arthur squadron, she had embarked her 2nd Army (General Oku, 1st, 3rd, 4th and 5th divisions) during April, and sent it to the Chinampo whence, as soon as the ice melted and Kuroki's victory cleared the air, it sailed to the selected landing-place near Pitszewo. Here, under the protection of a continuous chain of war-vessels between the Elliot

The Japanese 1st Army in Korea.

Battle of the Yalu.

Landing of the Japanese 2nd Army.

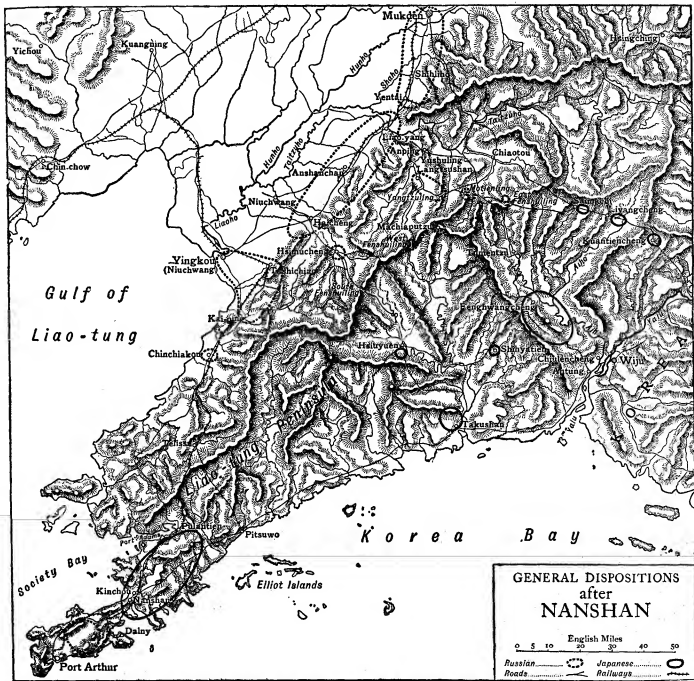

Islands and the mainland, Oku began to disembark on the 5th of May. But the difficulties of the coast were such that it took three weeks to disembark the whole and to extend across the peninsula to Port Adams. Oku then, leaving the 5th division behind, moved down with the rest towards Kinchow, and after storming that place found himself face to face with a position of enormous strength, Nanshan Hill, at the narrowest part of the peninsula, where part of a Russian division (3000 only out of 12,000 were actually engaged) had fortified itself with extreme care. On the 26th of May took place the battle of Nanshan. The Japanese attack was convergent, but there was no room for envelopment; the Russian position moreover was "all-round" and presented no flanks, and except for the enfilade fire of the Japanese and Russian gunboats in the shallow bays on either side the battle was locally at every point a frontal attack and defence. The first rush of the assailants carried them up to the wire and other obstacles, but they were for many hours unable to advance a step farther. But the resolute Oku attacked time after time, and at last the 4th division on his right, assisted by its gunboats,

forced its way into the Russian position. The Russians had just begun to retreat, in accordance with orders from higher authorities. But it was a second undeniable victory. It was, moreover, a preface to those furious assaults on Port Arthur which, because they were the expression of a need that every soldier felt, and not merely of a tactical method, transcend all cool-blooded criticism. The Japanese losses were 4500 out of 30,000 engaged or 15%, that of the Russians fully half of the 3000 engaged. The victors captured many guns, but were too exhausted to pursue the Russians, whose retirement was not made in the best order.

The transports were now conveying the 6th and 11th divisions to Pitszewo; these were to form the 3rd Army (Nogi) for operations against Port Arthur. Oku exchanged his 1st division for the 6th. The 2nd Army then turned northward (3rd, 4th, 5th and 6th divisions). The 10th division, forming the nucleus of the 4th Army, had begun to land at Takushan on the 19th of May. The 2nd and 4th Armies were the left wing of a widespread converging movement on Liao-Yang. Oku had the greatest

distance to march, Kuroki the smallest. The latter therefore had to stand fast in the face of the Russian Eastern Detachment, which was three days' march at most from Feng-hwang-cheng and could be supported in three more days by Kuropatkin's main body, whereas the pressure of Oku's advance would not begin to be felt by the Russian Southern Detachment until the twelfth day at earliest. It was necessary therefore for the first objective to make a slight concession to the second. Oku had to start at the earliest possible moment, even though operations against Port Arthur were thereby delayed for a week or two. In fact, Oku's march began on June 13th, Kuroki's on June 24th; the moves of the intermediate forces at various dates within this time.

Meanwhile Kuropatkin, assembling the main army week by week, was in a difficult position. His policy of gaining time had received a severe blow in the failure of his executive officer to realize it, and that officer, though his unpursued troops quickly regained their *moral*, had himself completely lost confidence. On the news of the battle (coupled with that of a fresh army appearing on the Korean coast),¹ Kuropatkin instantly sent off part of his embryo central mass to bar the mountain passes of Fenshuling and Motienling against the imagined relentless pursuit of the victors, and prepared to shift his centre of concentration back to Mukden. The subsidiary protective forces on either flank of Zasiluch had promptly abandoned their look-out positions and fallen back to join him. But the commander-in-chief, soon realizing that the Japanese were not pursuing, reasserted himself, sent the protective troops back to their posts, and cancelled all orders for the evacuation of Liao-Yang. From this time forward, Kuropatkin allowed his subordinates little or no initiative. A few days later, Zasiluch's persistent requests to be allowed to retreat and the still uncertain movements of the 2nd Army induced him once more to prepare a concentration on Mukden. But on the 6th of May he learned that the Japanese 1st Army had again halted at Feng-hwang-cheng and that the 2nd Army was disembarking at Pitszewo, and he resumed (though less confidently) his original idea. The Eastern protective detachment, now strengthened and placed under the orders of Count Keller, was disposed with a view to countering any advance on Liao-Yang from the east by a combination of manoeuvre and fighting.² It was at this moment of doubt that Alexeiev, leaving Port Arthur just in time and profoundly impressed with the precarious state of affairs in the fleet and the fortress, gave the order, as commander-

in-chief by land and sea, for an "active" policy (19th May). Kuropatkin, thus required to abandon his own plan, had only to choose between attacking the 1st Army and turning upon Oku. He did not yield at once; a second letter from the viceroy, the news of Nanshan, and above all a signed order from the tsar himself, "Inform General Kuropatkin that I impose upon him all the responsibility for the fate of Port Arthur," were needed to bring him definitely to execute a scheme which in his heart he knew to be perilous. The path of duty for a general saddled with a plan which he disapproves is not easily discoverable. Napoleon in like case refused, at the risk of enforced resignation, but so did Moreau; the generality of lesser men have obeyed, but so did Suwárow.

Stakelberg's I. Siberian Corps was therefore reinforced towards the end of May up to a strength of above 35,000. But

it remained a detachment only. The Liao-Yang central mass was still held in hand, for the landing of the 4th Army—really only a division at present—at Takushan and the wrong placing of another Japanese division supposed to be with Kuroki (really intended for Nogi) had aroused Kuropatkin's fears for the holding capacity of Keller's detachment. Moreover, disliking the whole enterprise, he was most unwilling to use up his army in it. The Russians, then, at the beginning of June, were divided into three groups, the Southern, or offensive group (35,000), in the triangle Neuchwang-Haicheng-Kaiping; the Eastern or defensive group (30,000), the main body of it guarding the passes right and left of the Wiju-Liao-Yang road, the left (Cossacks) in the roadless hills of the upper Aibo and Yalu valleys, the right (Mishchenko's Cossacks and infantry supports) guarding Fenshuling pass and the road from Takushan; the reserve (42,000) with Kuropatkin at Liao-Yang; the "Ussuri Army": about Vladivostok; and Stessel's two divisions in the Kwantung peninsula.

On the other side the 1st Army was at Feng-hwang-cheng with one brigade detached on the roads on either hand, the left being therefore in front of the Takushan division and facing the Fenshuling. Oku's 2nd Army (4 divisions or 60,000 combatants) was about Port Adams. This last was the objective of the attack of Stakelberg's 35,000. Kuropatkin's orders to his subordinate were a compromise between his own plan and Alexeiev's. Stakelberg was to crush by a rapid and energetic advance the covering forces of the enemy met with, and his object was "the capture of the Nanshan position and thereafter an advance on Port Arthur." Yet another object was given him, to "relieve the pressure on Port Arthur by drawing upon himself the bulk of the enemy's forces," and he was not to allow himself to be drawn into a decisive action against superior numbers. Lastly, on June 7th, while Stakelberg was proceeding southward on his ill-defined errand, Kuropatkin, imposed upon by the advance of the Takushan column to Siu-yen, forbade him to concentrate to the front, only removing the veto when he learned that the 4th Army had halted and entrenched at Siu-yen.

On the 14th, all his arrangements for supply and transport being at last complete, Oku moved north. Although he was still short of part of the 6th division, he was in superior force. He had, moreover, the perfectly definite purpose of fighting his way north, and at Telissu or Wafangkou on the 14th of June, as he expected, he came upon Stakelberg's detachment in an entrenched position. On the 14th and 15th, attacking sharply on the Russian front and lapping round both its flanks, Oku won an important and handsome victory, at a cost of 1200 men out of 35,000 engaged, while the Russians, with a loss of at least 3600 out of about 25,000 engaged, retired in disorder. Thus swiftly and disastrously ended the southern expedition.

Meantime, except for the movement on Siu-yen already mentioned,³ and various reconnaissances in force by Keller's main body and by Rennenkampff's Cossacks farther inland, all was quiet along the Motienling front. Kuroki entrenched himself carefully about Feng-hwang-cheng, intending, if attacked by the Russian main army, to defend to the last extremity the ground and the prestige gained on the 1st of May.

From this point to the culmination of the advance at Liao-Yang, the situation of the Japanese closely resembles that of the Prussians in 1866. Haicheng represents Münchgrätz, Liao-Yang Gitschin, and the passes east of Liao-Yang Nachod and Trautenau. The concentration of the various Japanese armies on one battlefield was to be made, not along the circumference of the long arc they occupied, but towards the centre. Similarly, Kuropatkin was in the position of Benedek. He possessed the interior lines and the central reserve which enables interior lines to be utilized, and a stroke of good fortune prolonged the period in which he could command the situation, for

³ The occupation of Siu-yen was chiefly the work of the brigade pushed out to his left by Kuroki. Only a portion of the 10th division from Takushan helped to drive away Mishchenko's Cossacks.

¹ This was the 2nd Army, waiting in the port of Chinampo for the moment to sail for Pitszewo.

² One isolated incident which deserves mention took place at this time, the bold raid of Colonel Madritov and 500 Cossacks against the communications of the 1st Army. The raid (involving a ride of 240 m. forward and back) was carried out in entire ignorance of the battle of the Yalu, and on arriving at Anju Madritov found nothing to attack, the 1st Army having after its victory adopted a short line of communication from a sea base near the Yalu mouth. This incident suggests two reflections—first, that raids or attacks in rear of the "centre of operations" are valueless, however daring, and second that had Zasiluch, in his determination to be worthy of his knighthood, concentrated for battle, the presence of the Madritov detachment on the field would have prevented the lamentable and costly misunderstandings of the retreat on Hamatan.

on the 23rd of June an unexpected sortie of the Russian Port Arthur squadron paralysed the Japanese land offensive. In the squadron were seen the battleships damaged in the February attacks, and the balance of force was now against Togo, who had lost the "Yashima" and the "Hatsuse." The squadron nevertheless tamely returned to harbour, Togo resumed the blockade and Nogi began his advance from Nanshan, but the 2nd and 4th Armies came to a standstill at once (naval escort for their sea-borne supplies being no longer available), and the 1st Army, whose turn to advance had just arrived, only pushed ahead a few miles to cover a larger supply area. On the 1st of July the Vladivostok squadron appeared in the Tsushima Straits, and then vanished to an unknown destination, and whether this intensified the anxiety of the Japanese or not, it is the fact that the 2nd Army halted for eleven days at Kaiping, bringing the next on its right, 4th Army, to a standstill likewise. Its next advance brought it to the fortified position of Tashichiao, where Kuropatkin had, by drawing heavily upon his central reserve and even on the Eastern Detachment, massed about two army corps.

On the 24th Oku attacked, but the Russian general, Zarubayev, handled his troops very skillfully, and the Japanese were repulsed with a loss of 1200 men. Zarubayev, who had used only about half his forces in the battle, nevertheless retired in the night, fearing to be cut off by a descent of the approaching 4th Army on Haicheng, and well content to have broken the spell of defeat. Oku renewed the attack next day, but found only a rearguard in front of him, and without following up the retiring Russians he again halted for six days before proceeding to Haicheng to effect a junction with the 4th Army (Nozu), which meantime had won a number of minor actions and forced the passage of the mountains at Fenshuling South.¹

The 1st Army, after its long halt at Feng-hwang-cheng, which was employed in minutely organizing the supply service—a task of exceptional difficulty in these roadless mountains—reopened the campaign on the 24th of June, but only tentatively on account of the discouraging news from Port Arthur. A tremendous rainstorm imposed further delays, for the coolies and the native transport that had been laboriously collected scattered in all directions. The Motienling pass, however, had been seized without difficulty, and Keller's power of counter-attack had been reduced to nothing by the despatch of most of his forces to the concentration at Tashichiao. But Oku's 2nd Army was now at a standstill at Kaiping, and until he was further advanced the 1st Army could not press forward. The captured passes were therefore fortified (as Feng-hwang-cheng had been) for passive resistance. This, and the movements of the 4th Army, which had set its face towards Haicheng and no longer seemed to be part of a threat on Liao-Yang, led to the idea being entertained at Kuropatkin's headquarters that the centre of gravity was shifting to the south. To clear up the situation Keller's force was augmented and ordered to attack Kuroki. It was repulsed with a loss of nearly 1000 men in the action at the Motienling (17th July), but it was at least ascertained that considerable forces were still on the Japanese right, and upon the arrival of a fresh army corps from Europe Kuropatkin announced his intention of attacking Kuroki. And in effect he succeeded in concentrating the equivalent of an army corps, in addition to Keller's force, opposite to Kuroki's right. But having secured this advantage he stood still for five days, and Kuroki had ample time to make his arrangements. The Japanese general occupied some 20 m. of front in two halves, separated by 6 m. of impassable mountain, and knowing well the danger of a "cordon" defensive, he met the crisis in another and a bolder fashion. Calling in the brigade detached to the assistance of Nozu as well as all other available fractions of his scattered army, he himself attacked

Actions on the eastern front.

¹ The 5th division of the 2nd Army had been sent to join the 10th as the latter approached Hsimucheng. The Guard brigade of Kuroki's army which had served with Nozu in the advance had now returned to Feng-hwang-cheng.

on the 31st of July, all along the line. It was little more than an assertion of his will to conquer, but it was effectual. On his left wing the attacks of the Guard and 2nd divisions (action of Yang-tzu-ling) on the Russian front and flank failed, the frontal attack because of the resolute defence, the flank attack from sheer fatigue of the troops. Count Keller was killed in the defence. Meantime on the Japanese right the 12th division attacked the large bodies of troops that Kuropatkin had massed (Yu-shu-ling) equally in vain. But one marked success was achieved by the Japanese. The Russian 33th and 36th regiments (10th European Corps) were caught between two advancing columns, and, thanks to the initiative of one of the column leaders, Okasaki, destroyed. At night, discouraged on each wing by the fall of Count Keller and the fate of the 35th and 36th, the whole Russian force retired on Anping, with a loss of 2400, to the Japanese 1000 men.

This was the only manifestation of the offensive spirit on Kuropatkin's part during the six months of marking time. It was for defence, sometimes partial and elastic, sometimes rigid and "at-all-costs," that he had made his dispositions throughout. His policy now was to retire on Liao-Yang as slowly as possible and to defend himself in a series of concentric prepared positions. In his orders for the battle around his stronghold there is no word of counter-attack, and his central mass, the special weapon of the commander-in-chief, he gave over to Biderling and to Zarubayev to strengthen the defence in their respective sections or posted for the protection of his line of retreat. Nevertheless he had every intention of delivering a heavy and decisive counterstroke when the right moment should come, and meantime his defensive tactics would certainly have full play on this prearranged battlefield with its elaborate redoubts, bombproofs and obstacles, and its garrison of a strength obviously equal (and in reality superior) to that of the assailants.

Russian retirement on Liao-Yang.

The Japanese, too, had effected their object, and as they converged on their objective, the inner flanks of the three armies had connected and the supreme commander Marshal Oyama had taken command of the whole. But, as the event was to prove, the military policy of Japan had failed to produce the requisite number of men for the desired Sedan, and so, instead of boldly pushing out the 1st Army to such a distance that it could manoeuvre, as Moltke did in 1866 and 1870, he attached it to the general line of battle. It was not in two or three powerful groups but in one long chain of seven deployed divisions that the advance was made.

On the 25th of August the 2nd and 4th Armies from Haicheng and the 1st Army from the Yin-tsu-ling and Yu-shu-ling began the last stage of their convergent advance. The Russian first position extended in a semicircle from Anshantien (on the Liao-Yang-Hai-cheng railway) into the hills at Anping, and thence to the Taitse river above Liao-Yang; both sides had mixed detachments farther out on the flanks. The first step in the Japanese plan was the advance of Kuroki's army to Anping. Throughout the 25th, night of 25th-26th, and 26th of August, Kuroki advanced, fighting heavily all along the line, until on the night of the 26th the defenders gave up the contested ground at Anping. Hitherto there had only been skirmishing on a large scale on the side of Hai-cheng. Kuropatkin having already drawn in his line of defence on the south side towards Liao-Yang, the 2nd and 4th Japanese Armies delivered what was practically a blow in the air. But on the 27th there was a marked change in the Japanese plan. The right of the 1st Army, when about to continue the advance west on Liao-Yang, was diverted northward by Oyama's orders and ordered to prepare to cross the Taitseho. The retirement of the Russian Southern Force into its entrenchments emboldened the Japanese commander-in-chief to imitate Moltke's method to the full. On the 28th, however, the 1st Army made scarcely any progress. The right (12th) division reached the upper Taitseho, but the divisions that were to come up on its left were held fast by their

Battle of Liao-Yang.

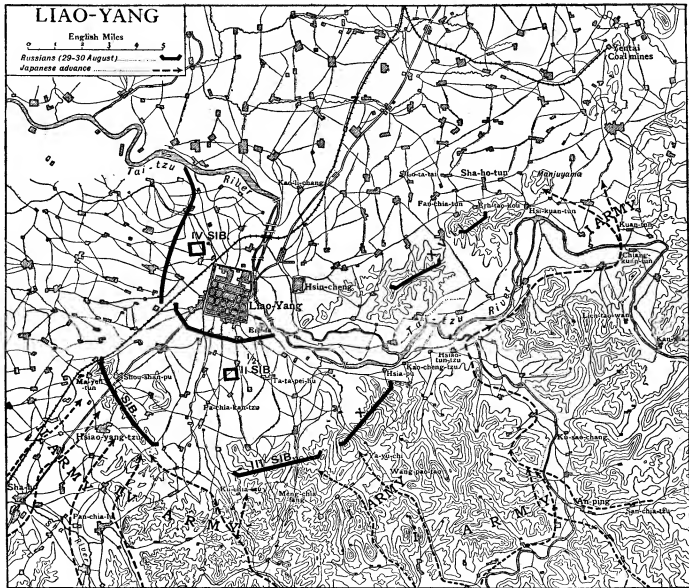

opponents. The 29th was an uneventful day, on which both sides prepared for the next phase.

The Russians' semicircle, now contracted, rested on the Taitzeho above and below the town, and their forces were massed most closely on either side of the "Mandarin" road that the 1st Army had followed. Opposite this portion of the line was the Guard and the 4th Army. Oku was astride the railway, Kuroki extending towards his proposed crossing-points just beyond Kuropatkin's extreme left (the latter was behind the river). On the 30th the attack was renewed. The Guard, the 4th Army and the 2nd Army were completely repulsed.

On the night of the 30th the first Japanese troops crossed the Taitzeho near Lien-Tao-Wun, and during the 31st three brigades were deployed north of Kwan-tun, facing west. The Russian left wing observed the movement all day, and within its limited local resources made dispositions to meet it. Kuropatkin's opportunity was now come. The remainder of the 2nd division was following the 12th, leaving a nine-mile gap between Kuroki and Nozu, as well as the river. It was not into this gap, which had no military significance, but upon the isolated divisions of the 1st Army that the Russian general proposed to launch his counterstroke. Reorganizing his southern defences on a shorter front, so as to regain possession of the reserves that he had so liberally given away to his subordinates, he began to collect large bodies of troops opposite Kuroki, while Stakelberg and Zarubayev, before withdrawing silently into the

lines or rather the fortress of Liao-Yang, again repulsed Oku's determined attacks on the south side. But it was not in confidence of victory that Kuropatkin began the execution of the new plan—rather as a desperate expedient to avoid being cut off by the 1st Army, whose strength he greatly overestimated.

On the morning of the 1st of September—the anniversary of Sedan, as the Japanese officers told their men—Oyama, whose intentions the active Kuroki had somewhat outrun, delivered a last attack with the 2nd and 4th Armies, and the Guard on the south front, in the hope of keeping the main body of the Russians occupied and so assisting Kuroki, but the assailants encountered no resistance, Zarubayev having already retired into the fortress. North of the Taitzeho the crisis was approaching. Kuroki's left, near the river, vigorously attacked a hill called Manjuyama which formed part of the line of defence of the XVII. Corps from Europe. But the right of the 1st Army (12th division) was threatened by the gathering storm of the counterstroke from the side of Yentai Mines, and had it not been that the resolute Okasaki continued the attack on Manjuyama alone, the Japanese offensive would have come to a standstill. Manjuyama, thanks to the courage of the army commander and of a single brigadier, was at last carried after nightfall, and the dislodged Russians made two counter-attacks in the dark before they would acknowledge themselves beaten. Next morning, when Kuroki, who had conceived the mistaken idea of a general retreat of the Russians on Mukden, was preparing

to pursue, the storm broke. Kuropatkin had drawn together seven divisions on the left rear of the XVII. Corps, the strength of the whole being about 90,000. On the extreme left was Orlov's brigade of all arms at Yentai Mines, then came the I. Siberian Corps (Stakelberg), then the X. Corps, then the XVII. But Orlov, perplexed by conflicting instructions and caught in an unfavourable situation by a brigade of the 12th division which was executing the proposed "pursuit," gave way—part of his force in actual rout—and the cavalry that was with him was driven back by the Kobi (reserve army) brigade of the Guard. The fugitives of Orlov's command disordered the on-coming corps of Stakelberg, and the outer flank of the great counterstroke that was to have rolled up Kuroki's thin line came to an entire standstill. Meantime the X. Corps furiously attacked Okasaki on the Manjuyama, and though its first assault drove in a portion of Okasaki's line, a second and a third, made in the night, failed to shake the constancy of the 15th brigade. Misunderstandings and movements at cross-purposes multiplied on the Russian side, and at midnight Kuropatkin at last obtained information of events on the side of Yentai Mines. This was to the effect that Orlov was routed, Stakelberg's command much shaken, and at the same time Zarubayev in Liao-Yang, upon whom Oku and Nozu had pressed a last furious attack, reported that he had only a handful of troops still in reserve. Then Kuropatkin's resolution collapsed, although about three divisions were still intact, and he gave the order to retreat on Mukden.

Thus the Japanese had won their great victory with inferior forces, thanks "in the first instance to the defeat of General Orlov. But at least as large a share in the ruin of the Russian operations must be attributed to the steadfast gallantry of the 15th brigade on Manjuyama." The losses of the Japanese totalled 23,000, those of the Russians 19,000. Coming, as it did, at a moment when the first attacks on Port Arthur had been repulsed with heavy losses, this brilliantly successful climax of the four months' campaign more than restored the balance. But it was not the expected Sedan. Had the two divisions still kept in Japan been present Kuroki would have had the balance of force on his side, the Russian retreat would have been confused, if not actually a rout, and the war would have been ended on Japan's own terms. As it was, after another day's fighting, Kuropatkin drew off the whole of his forces in safety, sharply repulsing an attempt at pursuit made by part of the 12th division on the 4th of September. The railway still delivered 30,000 men a month at Mukden, and Japan had for a time outrun her resources. At St Petersburg the talk was not of peace but of victory, and after a period of reorganization the Russians advanced afresh to a new trial of strength. But the remainder of the Manchurian campaign, like the second half of the war of 1859, was nothing more than a series of violent and resultless encounters of huge armies—armies far larger than those which had fought out the real struggle for supremacy at Liao-Yang and Magenta.

At this time the siege of Port Arthur had only progressed so far that the besiegers were able to realize the difficulties before them. Nogi landed on the 1st of June, and his army (1st and 11th divisions) gradually separated itself from Oku's and got into position for the advance on Port Arthur. Dalny, the commercial harbour, was seized without fighting, and a month was spent in preparing a base there. But so far from retiring within his fort-line Stessel took up a strong position outside. Dislodged from this on the 26th of June, the Russians checked Nogi's further advance on July 3-4 by a fierce, though unsuccessful, counterstroke. Having been reinforced by the 9th division and two extra brigades of infantry, Nogi advanced again on the 26th. The Russians, having had a month wherein to entrench themselves, held out all along the line; but after two days and one night of fighting amongst rocks and on precipitous hill-sides, the Japanese broke through on the night of July 27-28. Stessel then withdrew in good order into Port Arthur, which in the two months he had gained by his fighting manœuvre had been considerably strengthened. Nogi had already lost 8000 men.

The defences of Port Arthur, as designed by the Russians in 1900, and owing to the meagre allotment of funds only partially carried out before the war, had some tincture, but no more, of modern continental ideas. There was a continuous enceinte of plain trace

round the Old Town, at a distance of 1000 to 2000 yds. from it, which had not and could not have had any influence on the issue of the siege. The main line of defence followed the outer edge of the amphitheatre of hills surrounding the harbour. These hills had their greatest development on the N.E. side, their outer crests being some 4000 yds. from the Old Town. West of the Lun river the defensive line offered by the hills is less defined, and the line adopted for the permanent works was on the north only 3000 yds. from the harbour and 2000 yds. from the New Town. Running S.W. and S. back to the coast, it gradually draws in quite close to the S.W. end of the harbour. The total length of this line from sea to sea is some 12 m. Its most obvious weakness is that 5000 yds. N.W. of the harbour and New Town the now famous "203-Metre Hill" overlooks both. Here it had been intended to construct permanent works, but considerations of expenditure had caused this to be deferred.

On this main line of defence some seven or eight permanent works had been disposed (it is difficult to define with accuracy, as some of the concreted works were little better than semi-permanent in character). Some of these had been prepared with interior parapets and platforms of concrete for medium guns. Fort Erh-Lung was of this character. The general design appears to have been grounded on the French detached forts of the 'seventies (see FORTIFICATION), as the front parapet was designed for infantry and the interior, 10 ft. higher, for guns. The ditch, 30 ft. deep, excavated in the rock, was flanked by counterscarp galleries. The living casemates were under the gorge parapet. A grave defect in the design was that there was no covered communication between these casemates and the parapets. Fort Chi-Kuan had no artillery parapet. The ditch, 12 to 15 ft. deep, was defended by counterscarp galleries. The casemates in the gorge, partly cut off from the terreplein by a couple of deep sally yards or areas, could be defended in the last resort as a keep. In addition to this the terreplein was retrenched. In both of these forts there was an apparently meaningless projection at the gorge. It is possible that these were embryonic "batteries traïdiores" to flank the intervals. Fort Sung-Shu was of the same type as Chi-Kuan. These three were the only permanent forts seriously attacked.

The permanent works were supplemented before the siege began by a prodigious development of semi-permanent works and trenches. Every knoll had its redoubt or battery, and the trenches were arranged line behind line, to give supporting, cross and enfilade fire in every direction. Thus on the north-west, there was a Chi-Kuan battery to flank Shu's distance of about two miles, then were three permanent forts and seven semi-permanent works and batteries. Behind these was the "Chinese Wall," and behind that more batteries and trenches. On the north-west front, 203-Metre Hill, in advance of the main line, was occupied by strong semi-permanent works, with trenches and redoubts to either flank; and 174-Metre Hill, 1500 yds. beyond it, was also held. The Lun-Ho valley where it cut through the line was closed by entanglements and fougasses, and swept by batteries on each side. In front of the centre, the Waterworks Redoubt, a semi-permanent work covering the Port Arthur water supply, and connected by trenches with the four Temple Redoubts a mile away to the west, formed a strong advanced position. Wire entanglements were disposed in repeated lines in front of the defences, but they were not of a strong type. The Russians, with the resources of the fleet at their disposal (just as at Sevastopol), used great numbers of machine guns and electric lights, and the available garrison at first was probably, including sailors, 47,000 men.

Such were the defences that the Japanese attacked, with a force at the outset (30th of July) little more than superior numerically to the defenders, and an entirely inadequate siege train (18.6-in. howitzers, 60 4.7-in. guns and howitzers, and about 200 field and mountain guns). They were miserably informed of the strength of the garrison and the nature of the defences. Recollections of their easy triumph in 1894 and perhaps thoughts of Sevastopol, German theories of the "brusque attack," the fiery ardour of the army, and above all the need of rapidly crushing or expelling the squadron in harbour, combined to suggest a bombardment and general assault. The bombardment began on the 19th of August and continued for three days, while the infantry was spreading along the front and gaining ground where it could. The real assault was made on the night of the 21st on the two Pan-Lung forts (semi-permanent) on the centre of the north-eastern front. The fighting was of the utmost severity, and continued through the 22nd; and although the stormers captured the two forts they were absolutely unable to make any further progress under the fire of the permanent forts Erh-Lung and Chi-Kuan on either side of, and the Wan-tai fort behind, Pan-Lung. Every attempt to bring up supports to the captured positions failed, and the Russians concentrated on the spot from all quarters. On the night of the 23rd-24th, just as the assault was being renewed, Stessel delivered a fierce counter-attack against the lost positions, and the result of an all-night battle was that though the forts were not recaptured the assault was rewarded with over 5000 casualties, and the Japanese in Pan-Lung were isolated. This sortie raised the spirits of the Russians to the highest pitch. They seemed indeed to have broken the spell of defeat. On the Japanese side 15,000

Russian retreat on Mukden.

Nogi's advance on Port Arthur.

Defences of Port Arthur.

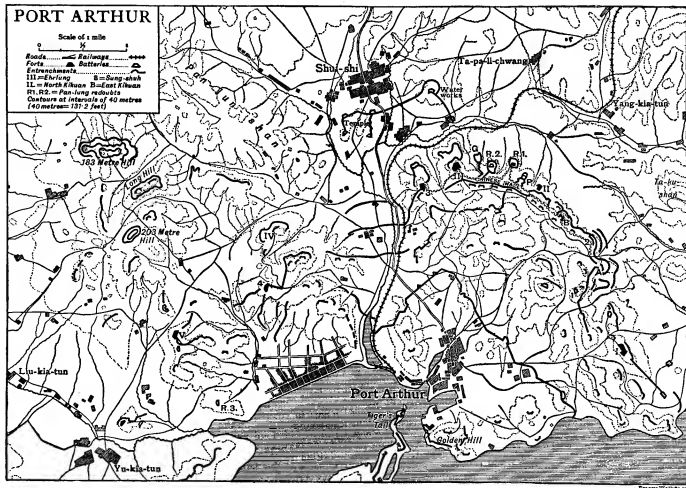

Henry Walker

men had been killed and wounded in three weeks. The Russians strengthened their works around the captured forts in such a way as effectually to prevent farther advance, and the Japanese 3rd Army had now to resign itself to a methodical siege. Small sorties, partial attacks¹ and duels between the Japanese guns and the Russian guns generally more powerful ordnance of the fortress continued.

Attacks on the north front. The siege approaches were first directed against the Temple-Waterworks group, which was stormed on the 19th and 20th of September. Pan-Lung was connected with the Japanese lines by covered ways, approaches were begun towards several of the eastern forts, and on the 20th of September 180-Metre Hill was stormed, though the crest was untenable under the fire from 203-Metre Hill. The Japanese were now beginning to pay more attention to the western side of the fortress, and from the 16th to the 22nd there was hard fighting around 203-Metre Hill, the attack being eventually repulsed with the loss of 2000 men. Operations in the west were thereupon abandoned for the time being, and the eastern forts remained the principal objective of the attack. Heavier howitzers had been sent for from Japan, and on the 1st of October the first batteries of 28 centimetre (11 in.) howitzers came into action. They fired a shell weighing 485 lb. with a bursting charge of 17 lb. On the 12th, the Japanese took the trenches between the Waterworks Redoubt and Erh-Lung, and cut the water-supply. They were then pushed on against Erh-Lung, and to help in their progress a Russian advanced work called "G" was captured on the 16th, by a skilfully combined attack of infantry and artillery. From this time forward there was a desperate struggle at the saps-heads on the north front.²

On the 26th of October another assault was made on Chi-Kuan

¹ A particular feature of these constant night-fights was the effective use of the defenders' searchlight, not only to show up the enemy but to blind him.

² Hand grenades and extemporized trench mortars were used on both sides with very great effect. The Japanese hand grenades consisted of about 1 lb of high explosive in a tin case; the Russian cases were of all sorts, including old Chinese shell. The Japanese employed wire-netting screens to stop the Russian grenades. Various means were tried for the destruction of entanglements. Eventually it was found that the best plan was to sap through them.

Fort and Battery, and was continued at intervals, varied by Russian counter-attacks, till the 2nd of November. By this time the Japanese were becoming disheartened. They had incurred an additional loss of 13,000 men without substantial gain, except a lodgment on the counterscarp of Sung-Shu. This prepared the way for mining, which had already been begun at Erh-Lung. On the 17th of November seven mines were exploded at Sung-Shu, which blew in the back of the counterscarp galleries. At Erh-Lung on the 20th of November three mines were exploded, which half filled the ditch, and the Japanese later on sapped across to the escarp over the débris. At Chi-Kuan, the counterscarp gallery had been breached by an ill-managed Russian mine on the 23rd of October and the Japanese got in through the breach and made a lodgment. They did not, however, get possession of the whole of the counterscarp galleries before about the middle of November. On the 22nd of November the Japanese assaulted the trench round Chi-Kuan battery. It was captured and retaken by counter-attack twice between 6 p.m. and 1 a.m. In this fight each side was using corpses as breastworks.

On the 26th of November another assault was made on the same lines as that of the 30th of October. By this time the besiegers were sapping under the escarp of the northern forts, and it would have been better to delay. But the situation was serious in the extreme. In Manchuria Kuropatkin's army had reasserted itself. From Europe Rozhdestvenski's squadron was just setting sail for the Far East. Marshal Oyama sent his principal staff officers to stimulate Nogi to fresh efforts, and some exhausted units of the besieging army were replaced by fresh troops from Japan. With 100,000 men and this urgent need of immediate victory, Nogi and the marshal's staff officers felt bound to make a third general assault. The siege works had indeed made considerable progress. The ditches of Sung-Shu and Erh-Lung were partially filled. They held most of the ditch of Chi-Kuan Fort and were cutting down the escarp, and two parallels had been made only 30 yds. from the Chinese Wall at "G" and Pan-Lung.

The general attack was made at 1 p.m. At Sung-Shu the stormers got into the fort, but suffered much from the artillery on the western side of the Lun-ho valley, and were beaten out of it again in 20 minutes; 2000 men tried in vain to get up the Lun-ho valley to take Sung-Shu in rear. At Erh-Lung they could not get over the outer parapet. At "G" they took a portion of the Chinese Wall and lost

it again, other trenches with a cross fire being behind. At Pan-Lung the machine guns on the Wall prevented them from leaving the parallel. At Chi-Kuan Fort the terreplein of the fort had been covered with entanglements defended by machine guns on the gorge parapets, and the Japanese could make no way. Briefly, there was a furious fight all along the line, and nothing gained. On the 27th of November, after losing 12,000 men, the assault was abandoned. On the north front the Japanese returned to mining.

But so urgent was the necessity of speedy victory that the fighting had to continue elsewhere. And at last, after every other point had been attempted, the weight of the attack was directed on 203-Metre Hill. A battery of 11-inch howitzers was established only one mile away. On the 28th of November assaults were made and failed. On the 30th of November an attack with fresh troops failed again. On the 1st of December there was a heavy bombardment by the big howitzers, which obliged the Russians to take shelter in rear of the ruined works. On the 2nd of December the Russians tried a counter-attack. During the next two days the artillery were busy. The engineers sapped up to the ruins of the western work, saw the shelters on the reverse slope and directed artillery fire by telephone. Thirty-six guns swept the ground with shrapnel. Finally on the 5th of December the Japanese attacked successfully. Their losses in the last ten days at 203-Metre Hill had been probably over 10,000. Those of the Russians were about 5000, chiefly from artillery fire.

This was the turning-point of the siege. At once the 11-inch howitzers, assisted by telephone from 203-Metre, opened upon the Russian ships; a few days later these were wholly *hors de combat*, and at the capitulation only a few destroyers were in a condition to escape. The siege was now pressed with vigour by the construction of batteries at and around 203 Metre, by an infantry advance against the main western defences, and by renewed operations against the eastern forts. The escarp of Chi-Kuan was blown up, and at the cost of 800 men, General Sameyeda (11th division), personally leading his stormers, captured the great fort on the 19th of December. The escarp of Eikang was also blown up, and the ruins of the fort were stormed by the 9th division on the 28th of December, though a mere handful of the defenders prolonged the fighting for eight hours and the assailants lost 1000 men. Sung-Shu suffered a worse fate on the 31st, the greater part of the fort and its defenders being blown up, and on this day the whole defence of the eastern front collapsed. The Japanese 7th and 1st divisions were now advancing on the western main line; the soul of the defence, the brave and capable General Kondratenko, had been killed on the 15th of December, and though the Japanese seem to have anticipated a further stand, Stessel surrendered on the 2nd of January, 1905, with 24,000 men, slightly wounded and 15,000 wounded and sick men, the remnant of his original 47,000. The total losses of the 3rd Japanese Army during the siege were about 92,000 men (58,000 casualties and 34,000 sick).

Meanwhile the Japanese navy had scored two important successes. After months of blockade and minor fighting, the Russian Port Arthur squadron had been brought to action on the 10th of August. Admiral Vitheft, Makarov's successor, had put to sea shortly after the appearance of the 3rd Army on the land front of Port Arthur. The battle opened about noon, 20 m. south of the harbour; the forces engaged on each side varied somewhat, but Togo finally had a superiority. Admiral Vitheft was killed, the Russians became gradually weaker, and the Japanese closed in to within 3 m. range, and Prince Ukhtsky (who succeeded to the command on Vitheft's fall) gave up the struggle at nightfall. The Russians scattered, some vessels heading southward, the majority with the admiral making for Port Arthur, whence they did not again emerge. All the rest were either forced into neutral ports (where they were interned) or destroyed, among the latter being the third-class cruiser "Novik," which had already earned a brilliant reputation for daring, and now steamed half round Japan before she was brought to action and ran ashore. The victors blockaded Port Arthur, until near the close of the siege, when, after going ashore and examining the remnant of the Russian fleet from 203-Metre Hill, Togo concluded that it would be safe to return to Japan and give his ships a complete refit. Kaimura's squadron, after various adventures, at last succeeded on the 14th of August in engaging and defeating the Russian Vladivostok squadron (Admiral Jessen). Thus the Russian flag disappeared from the Pacific, and thenceforward only the Baltic fleet could hope seriously to challenge the supremacy of the Japanese navy.

The remainder of the war on land, although it included two battles on a large scale and numerous minor operations, was principally a test of endurance. After Liao-Yang there were no extended operations, the area of conflict being confined to the plain of the coast side of the Hun-ho and the fringe of the

mountains. Japan had partially accomplished her task, but had employed all her trained men in this partial accomplishment. It was questionable, even in October 1904, whether she could endure the drain of men and money, if it were prolonged much further. On the other hand, in Russia opposition to the war, which had never been popular, gradually became the central feature of a widespread movement against irresponsible government. Thus while the armies in Manchuria faced one another with every appearance of confidence, behind them the situation was exceedingly grave for both parties. A state of equilibrium was established, only momentarily disturbed by Kuropatkin's offensive on the Sha-ho in October, and by the Sandepu incident in the winter, until at last Oyama fought a battle on a grand scale and won it. Even then, however, the results fell far short of anticipation, and the armies settled down into equilibrium again.

After the battle of Liao-Yang Kuropatkin reverted for a moment to the plan of a concentration to the rear at Tieling. Politically, however, it was important to hold Mukden, the Manchurian capital, and since the Japanese, as on previous occasions, reorganized instead of pursuing, he decided to send his guns to the rear, which had a demoralizing effect on his army. Moreover, owing in strength day by day, and aware that the Japanese had outworn their powers, he resolved, in spite of the depondency of many of his senior officers, to take the offensive. He disposed of about 200,000 men, the Japanese had about 170,000. The latter lay entrenched north of Liao-Yang, from a point 9 m. west of the railway, through Yentai Station and Yentai Mines, to the hills farther east. There had been a good deal of rain, and the ground was heavy. Kuropatkin's intention was to work round the Japanese right on the hills with his eastern wing (Stakeberg), to move his western wing (Bilderling) slowly southwards, entrenching each strip of ground gained, and finally with the centre—i.e. Bilderling's left—and Stakeberg, to envelop and crush the 1st Army, which formed the Japanese right, keeping the 4th Army (Nozu) and the 2nd Army (Oku) in countenance by means of Bilderling's main body. The manoeuvre began on the 5th of October, and by the evening of the 10th, after four days of fairly heavy advanced-guard fighting, chiefly between Bilderling and Nozu, Stakeberg was in his assigned position in the mountainous country, facing west towards Liao-Yang, with his left on the Taitseho. The advance of Bilderling, however, necessarily methodical and slow in any case, had taken more time than was anticipated. Still, Bilderling crossed the Sha-ho and made some progress towards Yentai, and the demonstration was so far effective that Kuroki's *Sha-ho*, the Japanese were almost disregarded by the Japanese headquarters. The commander of the 1st Army, however, took his measures well, and Stakeberg found the greatest trouble in deploying his forces for action in this difficult country. Oyama became convinced of the truth on the 9th and 10th, and prepared a great counter-attack. Kuroki with only a portion of the 1st Army was left to defend at least 15 m. of front, and the entire 2nd and 4th Armies and the general reserves were to be thrown upon Bilderling. On the 11th the real battle opened. Kuroki displayed the greatest skill, but he was of course pressed back by the four-to-one superiority of the Russians. Still the result of Stakeberg's attack, for which he was unable to deploy his whole force, was disappointing, but the main Japanese attack on Bilderling was not much more satisfactory for the Russians had entrenched every step of their previous advance, and fought splendidly. The Russian commander-in-chief states in his work on the war that Bilderling became engaged *à fond* instead of gradually withdrawing as Kuropatkin intended, and at any rate it is unquestioned that in consequence of the serious position of affairs on the western wing, not only did Stakeberg use his reserves to support Bilderling, when the 12th division of Kuroki's army was almost at its last gasp and must have yielded to fresh pressure, but Kuropatkin himself suspended the general offensive on the 13th of October. In the fighting of the 13th-16th of October the Russians gradually gave back as far as the rear of the Sha-ho, the Japanese following. The fighting was faced roughly north and south on parallel fronts. The fighting, irregular but severe, continued. Kuropatkin was so far averse to retreat that he ordered a new offensive, which was carried out on the 16-17th. Putilov and Novgorod hills, south of the Sha-ho, were stormed by the Russians, and the Japanese made several efforts to retake these positions without success. Kuropatkin wished to continue the offensive, but his corps commanders offered so much opposition to a further offensive that he at last gave up the idea. The positions of the rival armies from the 18th of October, the close of the battle of the Sha-ho, to the 26th of January 1905, the opening of the battle of Sandepu (Heikoutai)—a period almost entirely devoid of incident—may be described by the old-fashioned term *interim* quarters. The total losses of the Russians are stated as 300,000 men, but this is very considerably exaggerated; in the Japanese acknowledged 20,000 casualties.

In January 1905, apart from Mishchenko's cavalry raid in rear

¹ As regards food and ammunition, the resources of the defence were not by any means exhausted, and General Stessel and other senior officers of the defence were tried by court-martial, and some of them convicted, on the charge of premature surrender.

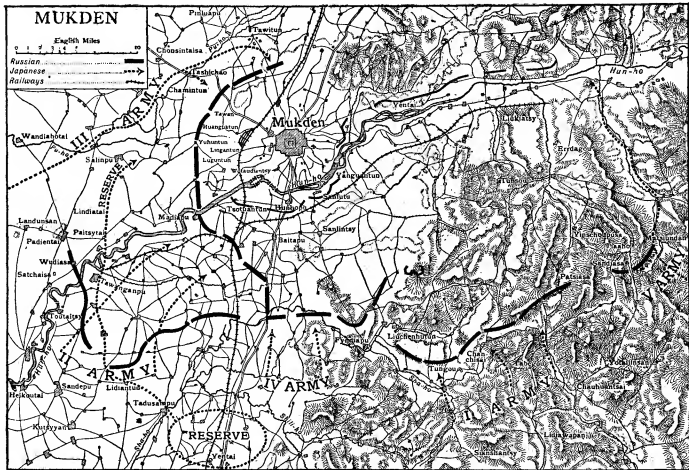

of Oyama's forces (January 8th-16th) the only change in the relative positions of Oyama and Kuropatkin as they stood after the battle of the Sha-ho was that the Japanese had extended somewhat westwards towards the Hun-ho. The Russians, 300,000 strong, were now organized in three armies, commanded by Generals Linievich, Gripenberg and Kaulbars; the total strength of the Japanese 1st, 2nd and 4th Armies and reserve was estimated by the Russians at 220,000. Towards the end of January, Kuropatkin took the offensive. He wished to inflict a severe blow before the enemy could be reinforced by the late besiegers of Port Arthur, and sent Gripenberg with seven divisions against Oku's two on the Japanese left. The battle of Sandepu (Heikoutai), fought in a terrible snow-storm on the 26th and 27th of January 1905, came near to being a great Russian victory. But the usual *discourtesy* of Russian operations and their own magnificent-resistance saved the Japanese, and after two days' severe fighting, although Gripenberg had not been checked, Kuropatkin, in face of a counter-attack by Oyama, decided to abandon the attempt. The losses were roughly 8000 Japanese to over 10,000 Russians.

Both sides stood fast in the old positions up to the verge of the last and greatest battle. Kuropatkin was reinforced, and appointed Kaulbars to succeed Gripenberg and Bilderling to the command of the 3rd Army vacated by Kaulbars. On the other hand, Nogi's 3rd Army, released by the fall of Port Arthur, was brought up on the Japanese left, and a new army under Kawamura (5th), formed of one of the Port Arthur and two reserve divisions, was working from the upper Yalu through the mountains towards the Russian left rear. The Russian line in front of Mukden from the Hun-ho, through the Putilov and Novgorod hills on the Sha-ho, to the mountains, was 47 m. long, the armies from right to left being II. (Kaulbars), III. (Bilderling) and I. (Linievich); a general reserve was at Mukden. On the other side from left to right, on a line 40 m. long, were Oku (2nd Army), Nozu (4th), Kuroki (1st) and Kawamura (5th), the general reserve in rear of the centre at Yentai and the 3rd Army in rear of Oku. Each side had about 310,000 men present. The entire front of both armies was heavily entrenched. The Russians had another offensive in contemplation

when the Japanese forestalled them by advancing on the 21st of February. The 5th Army gradually drove in Kuropatkin's small detachments in the mountains, and came up **Mukden**, in line with Kuroki, threatening to envelop the Russian left. The events on this side and misleading information induced Kuropatkin to pay particular attention to his left. The Japanese 1st and 5th Armies were now engaged (25th February), and elsewhere all was quiet. But on the 27th the fighting spread to the centre, and Nogi (originally behind Oku) was on the march to envelop the Russian right. He was held under observation throughout by Russian cavalry, but it seems that little attention was paid to their reports by Kuropatkin, who was still occupied with Kuroki and Kawamura, and even denied his right of its reserves to reinforce his left. With a battle-front exceeding two days' marches the wrong distribution of reserves by both sides was a grave misfortune. Kuropatkin was at last convinced, on the 28th of February, of the danger from the west, and did all in his power to form a solid line of defence on the west side of Mukden. Nogi's first attack (1st-2nd March) had not much success, and a heavy counterstroke was delivered on the 2nd. Fighting for localities and alterations in the interior distribution of the opposing forces occupied much time, and by the 3rd, though the battle had become severe, Kuropatkin had merely drawn in his right and right centre (now facing W. and S.W. respectively) a little nearer Mukden. His centre on the Sha-ho held firm, Kuroki and Kawamura made but slight progress against his left in the mountains. Nogi and Oyama were equally impressed with the strength of the new (west) Russian front, and like Grant at Petersburg in 1864, extended farther and farther to the outer flank, the Russians following suit. The Japanese marshal now sent up his army reserve, which had been kept far to the rear at Yentai, to help Nogi. It was not before the evening of the 6th of March that it came up with the 3rd Army and was placed in position opposite the centre of the Russian west front. **On**

the rest of the line severe local fighting had continued, but the Russian positions were quite unshaken, and Kuropatkin's reserves—which would have been invaluable in backing up the counter-attack of the 2nd of March—had returned to face Nogi. He had organized another counterstroke for the 6th, to be led by Kaulbars, but this collapsed unexpectedly after a brief but severe fight.

Kuropatkin now decided to draw in his centre and left towards Mukden. On the 7th, the various columns executed their movement to the Hun-ho with complete success, thanks to good staff work. The Japanese followed up only slowly. Nogi and Kaulbars stood fast, facing each other on the west front; after the arrival of the general reserve, Nogi was able to prolong his line to the north and eventually to bend it inwards towards the Russian line of retreat. Bilderling and Linievh were now close in to Mukden and along the Hun-ho. On the other side Oku had taken over part of Nogi's line, thus freeing the 3rd Army for further extension to the north-west, and the rest of the 2nd Army, the 4th, the 1st and the 5th were approaching the Hun-ho from the south (March 8th). On this day the

Russian fighting between Nogi and Kaulbars was very severe, and Kuropatkin now made up his mind to retreat towards Tieling. On the 9th, by Oyama's orders, Nogi extended northward instead of further swinging in south-eastward, Oku now occupied all the original line of the 3rd Army, Nozu alone was left on the south front, and Kuroki and Kawamura began to engage Linievh seriously. But Nogi had not yet reached the Mukden-Tieling railway when, on the night of the 9th, every preparation having been made, Kuropatkin's retreat began. On the 10th, covered by Kaulbars, who held off Nogi, and by strong rearguards at and east of Mukden, the movement continued, and though it was not executed with entire precision, and the rearguards suffered very heavily, the Russians managed to draw off in safety to the northward. On the evening of the 10th, after all their long and hardly contested enveloping marches, Nogi's left and Kawamura's right met north of Mukden. The circle was complete, but there were no Russians in the centre, and a map of the positions of the Japanese on the evening of the 10th shows the seventeen divisions thoroughly mixed up and pointing in every direction but that of the enemy. Thus the further pursuit of the Russians could only be undertaken after an interval of re-organization by the northernmost troops of the 5th and 3rd Armies. But the material loss inflicted on the Russians was far heavier than it had ever been before. It is generally estimated that the Russian losses were no less than 97,000, and the Japanese between 40,000 and 50,000. Japan had had to put forth her supreme effort for the battle, while of Russia's whole strength not one-tenth had been used. But Russia's strength in Europe, with but one line whereby it could be brought to bear in the Far East, was immaterial, and on the theatre of war a quarter of the Russian field forces had been killed, wounded or taken.

It remains to narrate briefly the tragic career of the Russian Baltic fleet. Leaving Libau on the 13th-15th of October 1904, the fleet steamed down the North Sea, expecting every night to be attacked by torpedo-boats. On the 21st, in their excitement, they opened fire on a fleet of British trawlers on the Dogger Bank (q.v.), and several fishermen were killed. This incident provoked the wildest indignation, and Russia was for some days on the verge of war with England. A British fleet "shadowed" Rozhstvenski for some time, but eventually the Russians were allowed to proceed. On reaching Madagascar, Rozhstvenski heard of the fall of Port Arthur, and the question of returning to Russia arose. But a reinforcement under Rear-Admiral Nebogatov was despatched from the Baltic via Suez early in March 1905, and the armada proceeded by the Straits of Malacca, Nebogatov joining at Kamranh Bay in Coochin China. The united fleet was formidable rather in number than in quality; the battleships were of very unequal value, and the faster vessels were tied to the movements of many "lame ducks." Rozhstvenski had, moreover, numerous store-ships, colliers, &c. Nevertheless, the Japanese viewed his approach with considerable anxiety, and braced themselves for a final struggle. Of the various courses open to him, Togo prudently chose that of awaiting Rozhstvenski in home waters. The Russians left Kamranh on the 14th of May, and for a time disappeared into the Pacific. It was assumed that

they were making for Vladivostok either via Tsushima strait or by the Pacific. Rozhstvenski chose the former course, and on the 27th of May the fleets met near Tsushima. About 1.45 p.m., the Russians, who were still in a close cruising formation, attempted to open out for battle as the Japanese approached. The Russian battleships, originally heading N.N.E., swerved to the E. as the Japanese battle squadron passed across their front. Togo's line was concentrated first on the "Oshibin," the leading Russian battleship, and by 2.25 she was *hors de combat*. At this time both the battle-fleets were running E. Togo, concentrating his fire on each ship in succession, and seeking by superior speed to head off the Russians, now inclined towards the S.E., and the Russians conformed. At 3, the Russian flagship "Suvorov" had fallen out of the line, though still firing. Rozhstvenski himself had been wounded, and the command had devolved on Nebogatov. Shortly afterwards the Russians suddenly turned N., and sought to pass, across the wake of Togo's battle-fleet, up the straits. Thereupon the leading Japanese ships promptly turned together, covered by the rear ships, which ran past them on the original course, and then came round in succession; this manoeuvre was so well executed that the Japanese again headed off their enemy, who swerved for the second time towards the E. The Japanese thereupon executed the same manoeuvre as before, and steamed S.E. again (about 4.40). They were not unscathed, but the Russians were suffering far more severely. Meanwhile, the cruisers on both sides had been heavily engaged. The Russian cruisers kept on the right of their battleships, while the Japanese, very superior in speed, ran S., S.E. and E. across the rear of the enemy's main squadron, and about 3 ranged up alongside the Russian cruisers. The latter were slower, and hampered by the crowd of damaged battleships, store-ships and colliers; before 5 they were in the greatest confusion, which was presently increased by the battleship squadron, now turned back and heading W., with Togo in pursuit. The Russians again broke out northward; but some of the Japanese squadrons hung on to the remnant of the enemy's battle-fleet, and the others dealt with the numerous Russian vessels that were unable to keep up. Then Togo called off his ships, and gave the torpedo craft room and the night in which to act. At daylight the larger ships joined in again, and before long the whole Russian fleet, with few exceptions, had been captured or sunk.

After the disasters of Mukden and Tsushima, and being threatened with internal disorder in European Russia, the tsar, early in June, accepted the mediation of the president of the United States, and *power-parlers* were set on foot. The war meanwhile drifted on through May, June and July. Linievh, who succeeded Kuropatkin shortly after the battle of Mukden, retired slowly northward, re-organizing his forces and receiving fresh reinforcements from Europe. A Japanese expedition occupied Saghalien (July 8-30), and another, General Hasegawa, advanced through Korea towards Vladivostok. But the fighting was desultory. The peace negotiations were opened at Portsmouth, New Hampshire, on the 9th of August, and by the end of the month the belligerents had agreed as to the main points at issue, that Russia should cede the half of Saghalien, annexed in 1875, surrender her lease of the Kwangtung peninsula and Port Arthur, evacuate Manchuria and recognize Japan's sphere of influence in Korea. The treaty of peace was signed on the 23rd of August 1905.

BIBLIOGRAPHY.—The first place in the already numerous works on the war is by the general consent of military Europe awarded to General Sir I. S. M. Hamilton's *A Staff Officer's Scrap Book*, and the second to the reports of the British staffs (*The Russo-Japanese War, British Official Reports*, War Office, 1908). Other first-hand narratives of importance are the American officers' reports (*Reports of Military Observers*, General Staff, U.S.A.); Major v. Tettau's *18 Monate beim Heere Russlands*; von Schwarz, *Zehn Monate beim Heere Kuropatkin's*, and Kuropatkin's own work (part of which has been translated into English). Of detailed military histories the principal are the semi-official series of narratives and monographs produced by the Austrian military journal "Strefleuer" (*Einzelnschriften über den russ-japanischen Krieg*); the volumes of lectures delivered at the Russian Staff College after the war, French translation (*Conférences sur la guerre russo-japonaise faite à Pétersbourg*); Nicolaï's (*Conférences sur l'histoire de la Russo-japonaise War 1904-1905*); German official *Russisch-japanischer Krieg 1906-*; English translation by K. von Donat; Löfler, *Der Russisch-Japanische Krieg* (Leipzig, 1907); French trans.; L. Gianni Trapani, *La Guerra russo-japonese* (Rome, 1908); E. Bujac, *La Guerre russo-japonaise* (1909). Of critical studies the most important are Cordonnier's "Les Japonais en Mandchourie" (*Revue d'Infanterie*, 1910); and Culmann, *Étude sur les caractères généraux de la guerre en extrême-orient* (Paris, 1906). One naval narrative of absorbing interest has, however, appeared, Semenov's *Raspjata* (English trans.).

Battle of Tsushima (Sea of Japan).

The Peace of Portsmouth.

RUSO-TURKISH WARS (1828-29 and 1877-78). The earlier wars between Russia and Turkey possess little military interest to-day, and are scarcely remembered except as the occasion of Suvarov's exploits. The first of the three 19th-century (1806-1812) wars, however, though much less vigorously fought than the preceding wars, at any rate introduced the "Eastern question" into European politics as a factor affecting the balance of power, and its cessation at the moment of Napoleon's advance on Moscow had a great effect on the emperor's Russian campaign.

The second war is more celebrated. It was a reflex of the Greek War of Independence, and began with the invasion of Rumania by the Russians in May 1828. One corps invested and took Braila, another passed by Bucharest and besieged Rustchuk and Silistria, and a third crossed the Danube below Isacka. The first and the last were united as an army under the tsar and advanced through the Dobrudja on Shumla. But after a considerable amount of fighting it was decided that the Turks here were too strong for the invaders, and the tsar drew off his forces by degrees towards Varna, which was besieged next. But the Shumla troops were thus gradually set free to join the Turkish field army under the grand vizier, which, however, merely menaced, without seriously attacking, the besiegers of Varna. The place surrendered on the 10th of October 1828, and the tsar at once turned upon the grand vizier, attacked him on the river Kamchik (15th October) and forced him to retreat to Aidos.

Meantime, however, Silistria offered a gallant resistance. Even when the besiegers were reinforced from the main army they could not master the defence, and when winter came on the siege was abandoned, and the Russians drew off into Rumania into winter quarters. In Asia, meanwhile, a Russian army under Prince Paskievich had advanced from Tiflis, and captured Kars and other places, while the Black Sea fleet secured the surrender of Poti. Paskievich next defeated the Turks at Akhalzik (27th August), captured Ardahan, and advanced by Bayazid to the upper Euphrates. But coming there into conflict with the fierce Kurds, he gave up further enterprises and, leaving garrisons in the strong places, took his army back into the Caucasus for the winter.

In 1829 Diebitsch took over the command of the 70,000 men on the Danube, and resolved to carry the war over the Balkans. As a preliminary the fleet seized Sozopolis (Sisepol). A second and vigorously pressed siege of Silistria ended with the surrender of the place on June 30th, the Turkish operations for the expulsion of the Sozopolis garrison and the relief of Silistria being dilatory as before. The Turkish army was at this time in process of reorganization on a European model, which added to the difficulties of their situation. The grand vizier, Reschid Mehmet, in May attempted to combine the Rustchuk and Shumla garrisons for the expulsion of the Russians from Varna, but unsuccessfully, the two columns being beaten in detail. Soon afterwards Diebitsch, with part of the army investing Silistria, marched against him and defeated him at Tcherkovna (11th June). Immediately after this Diebitsch carried out the brilliant passage of the Balkans and advanced to Adrianople, which laid Constantinople at his mercy, and brought about an immediate peace. A month after its signature, a Turkish army from the west, attempting to recapture Adrianople behind Diebitsch, was defeated on the 16th October at Arnaut Kaliessi. In Asia, meantime, Paskievich, after relieving Akhalzik, where his garrison had been blockaded, won two victories on two successive days at Kainly and Millli Duzov (1st and 2nd June), and captured a number of fortresses, his victorious advance being arrested only by the terms of peace. (X.)

The War of 1877-78.—On 24th April 1877, the tsar declared war against Turkey, with the avowed object of righting the wrongs of the Christians in Turkey. The Turco-Servian war was just over. Contrary to expectation the Turks had proved victorious. Hostilities had ceased in October 1876, though it was not till 1st March 1877 that peace had been signed. During 1876 the Turks had also quelled an insurrection of the Christians

in Bulgaria, when the treatment they meted out to the Christians and the cry of "Bulgarian atrocities" had aroused the sentimental sympathies of Europe.

The Danube formed the Turkish frontier. Flowing west to east along the southern boundary of Rumania, it turned to the north and then to the east to the Black Sea, enclosing the Dobrudja, an inhospitable and difficult region, of rectangular shape, some 100 m. N. to S. by 30 to 60 m. E. to W., which was the extreme northern part of the Turkish dominions.

The Russians did not anticipate that the opposition to be encountered from the Turkish forces would be of a serious nature. As for natural obstacles, there were the Danube and the Balkans directly across their route, but the passage of these was not likely to cause any serious delay.

The Turkish fortresses of the Quadrilateral—Rustchuk, Silistria, Shumla and Varna—could be avoided, and Nikopol and Vidin were more or less isolated. It would only be necessary to cover the lines of communication from the action of the garrisons of these places. It was known that Osman Pasha was at Vidin with what remained of the Turkish force which had defeated the Servians the previous year, and it would be necessary to detach a force to operate against him. There would be some delay in the forwarding of supplies, due to the fact that the Rumanian railway was of different gauge to the railways of Russia, but this would not be serious. This line, the only railway through Rumania, ran from Galatz to Bucharest, where one branch ran west by Slatina and the other to Giurgevo on the Danube, where it connected with a line south of the river from Rustchuk to Shumla and Varna through Rasgrad. It was generally imagined that the advance to Constantinople would be of the nature of a triumphal march. By a clause of the Treaty of Paris of 1856 the Russian naval forces in the Black Sea had been destroyed, and though this clause was revoked in 1871, in 1877 the Turks possessed the undoubted command of the sea. Had things been different, an advance through the Dobrudja, with a safe line of supply by water, would have offered many advantages. Under existing circumstances, with Turkish gunboats on the Danube and ironclads on the Black Sea, such a course was out of the question.

The plan of campaign formed by the Russians was as follows: One corps was to enter the Dobrudja to protect the line of communication against any Turkish advance east of the Danube, while the remainder would cross the Balkans between Rustchuk and Nikopol, cross the Balkans and advance on Adrianople. Detached forces would meanwhile mask the "Quadrilateral" and the Turkish force at Vidin.

A Convention had been made with Rumania, allowing the passage of the Russians through the country. The Rumanians proclaimed their independence of Turkey, and although the tsar declined their offer of active co-operation for the time being, their troops occupied Calafat, facing Vidin, and early in May their batteries engaged the guns of Vidin across the river. The Russian army with which it was proposed to carry on the war, consisted of six army corps and two rifle brigades. Each corps was formed of one cavalry and two infantry divisions. There were in addition 74 squadrons and 52 guns of Cossacks. Each infantry division had 48, and each cavalry division 12 guns. This force had been mobilized in the November of the previous year, and was now distributed as follows:—

Commander-in-chief: The grand-duke Nicholas, with headquarters at Kishinev.

VII. Army Corps	. . .	Odessa and Tatar Bunar.
XI. "	. . .	Tarutinskaja and Kansanzay.
VIII. "	. . .	Kishinev.
XII. "	. . .	Ugheni.
IX. "	. . .	Winnica.
X. "	. . .	Crimea.
Rifle Brigades	. . .	Bestomak.

The mobilization of the IV., XIII., and XIV. Army Corps had been ordered in December 1876, but they would not be ready to move till the following month—May 1877. In

addition to the above, there were heavy artillery with 400 siege guns, engineers with pontoon trains, naval launches, and the necessary supply trains. The total Russian forces numbered 200,000 combatants of all arms, with 850 field and 400 siege guns.

For some months prior to the tsar's declaration, Turkey had realized that war was inevitable, but such preparations as were made were far from adequate. Abdul Kerim, who had commanded in Servia the previous year, was still acting as commander-in-chief, but the task set him was not an easy one. With the Russians in front, the Servians and Montenegrins, whose action was known to be uncertain, on the flank, and the Christian population of Bulgaria, in sympathy with the Russians, in the midst, it required a younger and more energetic man, with a greater knowledge of the art of war than he possessed, to plan and to carry out a successful defence of the Moslem dominions. The prospect of war had aroused the Turks, and the nation had taken steps to prepare for the conflict, but they lacked trained leaders. The Turkish officers were but ill-instructed. Works on the art of war did not exist in the Turkish language. General conscription existed in Turkey, but there was an entire absence of organization. Theoretically, each of the six districts into which the empire was divided should have produced an army of four corps, but it was only on paper. Practically the troops were not organized in corps. At the outbreak of war, Osman's force, some 30,000 strong, was at Vidin; a few battalions were spread along the Danube from Vidin to Siliustria, with a brigade of infantry at Nikopol, another at Sistova, and the best part of two divisions at Rustchuk. Abdul Kerim's headquarters were at Shumla where there were two more infantry divisions. A cavalry division was in process of organization. Varna was the base of supply and was connected by rail with Shumla and Rustchuk. Suleiman Pasha with some 40,000 men was still in Montenegro. The total Turkish forces in Europe at that time were about 120,000 men with 450 guns, but they were disseminated instead of being concentrated, or grouped in view of a rapid concentration. Abdul Kerim's plan, or rather his idea, was, that the Russians would find some difficulty in the first place in forcing the passage of the Danube, and when they had succeeded in this, they would be bound to enter the zone of the Quadrilateral, where he hoped, operating with the fortresses as supports, to deal with them successfully. As regards the Turkish fleet, at the outset, in addition to a fleet of 8 ironclads below Braila, there were 7 monitors and 18 wooden ships of war on the Danube between Hirsova and Vidin.

In the matter of armament the Turks had the advantage. The artillery were armed with a Krupp breech-loading gun, which was better than the Russian bronze gun, while the Peabody-Martini rifles of the infantry were superior to the Russian Krenk. The firearm of the Turkish cavalry was the Winchester repeating carbine, which was inferior to the short Berden with which the Russian cavalry was armed. But this advantage in armament was discounted by the fact that, from motives of economy, the Turkish soldier had done but little rifle practice.

Hostilities commenced on the 24th of April, when the Russian army advanced in three columns towards Bucharest, the eastern flank covered by the XI. Corps which marched to Galatz. By the end of May the bulk of the Russian forces were assembled at Bucharest practically opposite the intended point of passage, with the advanced guard under General Skobelev at Giurgevo, and cavalry observing the river line from Turnu Magureli to Kalarashi. It was now decided to await the arrival of the IV., XIII., and XIV. Corps and the necessary bridging material for the passage of the Danube.

On June 15th the troops were disposed as follows: 8th Cavalry Division at Turnu Magureli; 12th at Oltenitza; 2nd at Kalarashi; Advanced Guard at Giurgevo; XI. Army Corps

at Oltenitza and Giurgevo; VIII., XII., XIII., XIX., at Bucharest; XIX. at Slatina; IV. at Slobodsia; XIV. at Galatz; VII. at Odessa; X. in the Crimea. Meanwhile steam launches were brought overland, and the Russians, by means of torpedoes, submarine mines and their shore batteries, had succeeded in clearing the Danube of Turkish vessels between Nikopolis and Rustchuk. Two of the smaller ironclads had been sunk, the remainder of the flotilla driven under the shelter of the fortresses, while barricades of mines effectually isolated them and prevented them from again entering the zone of operations. Of the large ironclads on the lower Danube, one was sunk near Sulina, and from that time the remainder stayed in Sulina harbour.

On June 22nd the XIV. Army Corps crossed into the Dobrudja at Galatz and advanced south, the Turkish detachment there retiring before them. pontoons having been brought by rail, the necessary rafts and boats (which had been constructed at Slatina on the Aluta) were floated down to the neighbourhood of Zimnitza, and on June 24th siege batteries opened fire on Nikopol and Rustchuk, while the IX. Army Corps made a feint of crossing just below Nikopol. These measures were effective in confusing the Turkish commander as to the Russian intentions, and on the night of June 26/27th, 12 companies of rifles, with a squadron and 6 guns, were landed on the south bank opposite Zimnitza, and within twenty-four hours the whole of the VIII. Corps had crossed the river. By July 2nd the Russians had completed a bridge over the river, which is 1000 yds. wide at this part. At Sistova was a Turkish brigade of infantry. The commander, in the early morning of the 27th, received information from his outposts of the crossing, but instead of moving with his whole force, sent two battalions to oppose it. The Russians drove them back, and when reinforced, advanced against the heights in rear of Sistova, which were occupied with a loss of 800 men, the Turkish troops retreating to Tirnova and Nikopol. The Turks had remained ignorant of the Russians' concentration in Rumania and no attempt had been made to discover their plans. Abdul Kerim remained inactive in the fortresses of the Quadrilateral, and even when he heard of the crossing at Sistova, decided that it was but a demonstration. No measures were taken to observe the Russians. They were thus able to complete their crossing practically undisturbed, and this although it was never likely that the Russians would voluntarily select a point of passage leading into the Quadrilateral. Everything pointed to a crossing between Nikopol and Rustchuk. The best course for the Turks under existing circumstances would have been to leave garrisons in the fortresses, to observe the river line and to push reconnaissances to the north of the river, and to dispose the field army in a central position, whence it could concentrate on any point as soon as the enemy's intentions were revealed.

On June 30th Lieut.-General Gurko was put in command of a detachment composed of 10 battalions, 31 squadrons and 32 guns, with which he was ordered to advance rapidly to Tirnova to gain possession of a pass over the Balkans, to damage railways and telegraphs, and to endeavour to stir up a Bulgarian revolt. He crossed the Danube by the Russian bridge on July 3rd and occupied Tirnova on July 7th, the Turkish garrison retreating to Osman Bazar. At Tirnova he learned that the Shipka Pass was occupied by 3000 Turks, and that none of the remaining passes were held in any force. He then determined to cross by the Hainkioi Pass and to turn the Shipka. He started from Tirnova on the 12th July, on which day the head of the VIII. Corps reached the town. Hainkioi was occupied on the 14th, a detachment of 300 Turks being driven away. Gurko then sent two squadrons to cut the telegraph at Yeni Zagra, and leaving a garrison to hold the pass, set out for Kazanlik on July 16th. It had been arranged that a force from the VIII. Corps should attack the Shipka Pass (q.v.) from the north on the 17th, Gurko attacking simultaneously from the south; but his advance was delayed

1st
Period.—
The
Russian
advance
and
passage
of the
Danube.

2nd
Period.—
Operations
in
Bulgaria
to the
fall of
Plevna.

by small bodies of the enemy, and he failed to co-operate, with the result that the attack from the north was repulsed. The Turkish commander, however, evacuated the pass that night (July 18th/19th). It was occupied by the Russians on July 19th, and held till the end of the war. Gurko's detachment was followed across the Danube bridge by the XII. and XIII. Army Corps, which crossed between July 3rd and 8th and moved towards the Jantra river; the IX. Corps was across by July 10th and advanced on Nikopol; the XI. Corps crossed July 10th-15th; and finally the IV. Corps between July 20th and 30th. The VIII. Corps had meanwhile advanced on Timova, as we have seen.

On July 3rd Abdul Kerim received orders from Constantinople to advance against the Russians, and set out with the force from Shumla for Rustchuk, immediately preceded by the cavalry division. Still no attempt was made to gain contact with the Russians and discover their intentions. From Rustchuk, Abdul Kerim advanced towards the Jantra, and after a skirmish between the Turkish cavalry and a Russian cavalry brigade again retired. Realizing Abdul Kerim's incapacity, and rendered anxious by Gurko's successful advance, the authorities at Constantinople now decided to give the command to Mehemet Ali. He superseded Abdul Kerim on July 19th, and at once ordered the concentration of all available forces at Rasgrad. Meanwhile Osman Pasha, who had till now been condemned to inactivity at Vidin, received permission to march.

Vidin, with its modern fortifications and heavy armament, and with the Danube on one side and marshy ground towards the interior, was a place of considerable strength. But with the Russians south of the Danube there could no longer be any justification for keeping Osman's 30,000 men isolated. Leaving garrisons in Vidin and the other towns along the Danube from Nikopol to Rakovitz, and to bar the roads from Servia, Osman left Vidin with the remaining 19 battalions, 6 squadrons and 9 batteries on July 13th. His original plan was to join the 10 battalions under Haiiri Pasha, then garrisoning Nikopol, and attack the Russian flank between Biela and Timova; but on July 15th he received news that the Russians were attacking Nikopol, and he then decided to march straight to Plevna, where there was a garrison of 3000 men under Atouf Pasha.

First battle of Plevna. Osman reached Plevna (გუ.) on July 19th, and at once took up a position which had been previously reconnoitred by Atouf Pasha, on the hills to the north-east and east of the town. He had arrived just in time. On July 16th the Russian IX. Corps had taken Nikopol, and on the 18th orders were received to occupy Plevna with one division. At 5 a.m. on July 20th General Schilder-Schuldner, with the 5th Division IX. Corps and other forces, attacked Osman's position. No preliminary reconnaissance was made, and the Russians, after an artillery bombardment lasting about an hour, attacked at four points with separate columns. By midday the Russians were in retreat, having lost over 2800 men. There was no pursuit. On July 20th Osman was reinforced by fourteen battalions from Sofia, and the following day sent Rifaat Pasha with six battalions, a battery and some Circassian cavalry to occupy Lovcha in order to secure his communications with Sofia.

Osman's force at Plevna, within three days' march of the one Russian bridge over the Danube and flanking their line of operations, could not be neglected, and General Krüdener, commanding the IX. Corps, received orders to attack again as soon as possible. After the battle of the 20th he had been reinforced by brigades of the IV. and XII. Corps and a cavalry division. With this force, 30,000 in all, he attacked on July 30th. Krüdener advanced in two columns, cavalry covering both flanks. Skobelev, with the cavalry on the southern flank, was subsequently reinforced by infantry, so there were practically three columns of attack. A general reserve of one brigade was kept at Karagatsch (16 m. east of Plevna). After an artillery engagement which lasted from 8.30 a.m. till 2.30 p.m. the infantry advanced. The

fighting lasted till sunset, when the Russians withdrew to Karagatsch, having lost 7300 officers and men. The Turkish casualties were 2000. General Krüdener, having reconnoitred the position, had hesitated to attack with the force available, and only acted in obedience to the orders received from headquarters, then 80 m. distant at Timova. His defeat was an unpleasant surprise for the Russians. Their plans were rudely upset, and their attention was now directed solely to the taking of Plevna. Headquarters were moved from Timova back to Bulgareni, Gurko was called back from south of the Balkans, the Rumanian army was called in to co-operate, orders were issued for the Guards and Grenadier Corps and the 24th and 26th infantry divisions to mobilize, 188,000 of the 1st Ban militia and three divisions of the reserve were called out, and the 2nd and 3rd infantry divisions and the 3rd Rifle Brigade from Moscow district, where they had been mobilized, were at once ordered to the front.

At this time the position of the Russians was as follows: the XIV. and part of the VII. Corps were north of the Danube, covering the communications; the IV. and IX. Corps were opposed to Osman Pasha at Plevna and his garrisons of Lovcha and Orchanie (the advanced depot of the Plevna force); the XI., XII. and XIII. Corps were along the White Lom facing Mehemet Ali, who was on the line Rasgrad-Eski Djuma with a force of about 80,000 infantry with 60 guns and a few regiments of cavalry, in addition to the garrisons of the fortresses; a small garrison on the Shipka Pass. Gurko was south of the Balkans, where Suleiman Pasha had a force of some 30,000 men. The Russian casualties since the commencement had reached 15,000, and their numbers south of the Danube did not exceed 130,000. Suleiman Pasha could have joined Osman or Mehemet Ali, avoiding the Shipka, and a vigorous offensive against the Russian flank at that time held out every prospect of success. The Shipka Pass would of necessity have been evacuated, but all through we find the Turkish commanders with their eyes fixed on geographical, which were sometimes strategical, points, and losing sight of the fact that the Russian army was their first objective. It is true that the ministers at Constantinople were largely responsible for the faulty strategy, but the generals in the field were also to blame. It was the moment for vigorous action on the part of the Turks. The moral equilibrium of the enemy was upset and the whole army demoralized by this second defeat at Plevna, but not a move was made. Again Osman failed to pursue. He was weak in cavalry, but he had sufficient to keep in touch with the enemy, who were utterly demoralized, and could have followed on with his whole force. He was but 35 m. distant from Sistova, and the result of the demolition of the bridge would have been incalculable. He was subsequently forbidden by Constantinople to assume the offensive, but it was not necessary to consult ministers as to pursuit after a successful battle, and they cannot be held responsible for this. The other Turkish commanders received news of the results of the battles of Plevna with incredulity, and likewise failed to turn them to account.

South of the Balkans was Suleiman's army. He was ordered from Montenegro on July 1st, and, leaving garrisons along the Montenegrin frontier, embarked at Antivari on July 15th. Disembarking at Dedeagatch on the 21st, he moved thence by train to Adrianople. His command, increased by some 15 battalions under Reouf Pasha, raised in the Balkan zone, amounted to approximately 30,000 men, and he was ordered to retake the Shipka Pass and to join Osman Pasha. Suleiman arrived at Karabunar on July 20th and moved to Eski Sagra, where he was joined by Reouf Pasha. Gurko, who had been resting about the Shipka Pass, ignorant of the arrival of Suleiman, moved against Reouf Pasha on the 27th of July, and found himself confronted by their combined forces on the 31st. He was attacked by Suleiman that day and was forced to retire. His force consisted of 15,000 men, including six battalions of Bulgarian volunteers which had just been raised. The following day he retreated across the Balkans by Hainkioi, where he left two brigades to hold the Hainkioi and Elena Passes, the

Bulgarian troops joining the garrison on the Shipka. Suleiman remained at Yeni Zagra till the 17th of August, when he set out for the Shipka. On August 21st the heights east of the pass were taken, and during the next few days there was desperate fighting; but the original garrison was gradually reinforced, and the Russians held on. In this fighting the Russian losses amounted to close on 4000, while the Turkish casualties were about treble that number. Suleiman now intrenched himself close to the Russian position, and there he remained till Sept. 17th, when after a three days' bombardment he again assaulted the position, but was repulsed with considerable loss. This was the last assault made on the Russian position. Suleiman replaced Mehemet Ali as commander-in-chief on Oct. 2nd, and was himself succeeded by Reouf Pasha. Thus, under orders from Constantinople, Suleiman frittered away his opportunity and his army in a fruitless attempt to retake the Shipka Pass.

It was not till the middle of August that Mehemet Ali decided to move against the Russians and ordered an advance. The **The lighting on the Lom.** Cesarevich (afterwards Alexander III.), who was opposing him with the XI., XII. and XIII. Corps, in all about 50,000, was extended on the line of the White Lom from Pirgos to Eski Djuma. On August 22nd and 23rd there were engagements about Ayaslar, resulting in the retirement of the Russians. On August 30th he attacked at Karahassankoi and drove the Russians across the river. On September 3rd he crossed the White Lom and again defeated them at Katzelevo, the enemy retiring behind the Banitcha Lom. On September 12th Mehemet Ali continued his advance, but halted on the 14th for a week. He then made an attack on Cerkovna on the 21st, but was repulsed with a loss of 1600 men, and two days later retired his army behind the White Lom. He had effected nothing. As will be seen later, the Russian operations against Plevna had not in any way disturbed. The containing force under the Cesarevich had retired a certain distance, but it still held the main Turkish army. Mehemet Ali's original plan had been to advance by Osman Bazar, effect a junction with Suleiman, and move on Timova. But Suleiman was averse to his plan and it was negated at Constantinople, though if this plan had been carried out with vigour, the position of the Russians should have been critical. He then advanced on a front of 50 m. instead of moving concentrated, which is the explanation of his failure. It is true that he was much hampered by the state of his cavalry, which was exhausted, and consequently was without information, while the Russians were well served. Mehemet Ali now concentrated his force, but at this juncture he was superseded by Suleiman Pasha.

To return to Plevna. At this time the Russians were disposed in a semicircle round Plevna, their right or N. flank resting on Ribina and the S. flank resting on Bogot. **Third battle of Plevna.** On August 30th Osman had moved out with a column of all arms towards Pelisat. The following day he engaged the Russians. The Turks lost 300 killed and 1000 wounded, and the Russian losses were about 1000. It is difficult to say what was the object of this sortie, which was of the nature of a reconnaissance in force. It achieved nothing. The Turks were not defeated, but retired again into Plevna the same evening. By the end of August the whole of the Rumanian army had crossed the Danube, and during the first days of September the first Russian reinforcements, consisting of the 2nd and 3rd infantry divisions and the 3rd Rifle Brigade, had arrived and joined the forces round Plevna. Mehemet Ali's advance and the assaults on the Shipka had been repulsed. The Russians could expect no further reinforcements before October, and it was therefore decided to make a third attempt to take Plevna, but first of all to occupy Lovcha. Skobelev had already made an unsuccessful attempt on August 6th, and General Prince Imeretinski, with a force of two infantry divisions and a brigade of Cossacks, in addition to **Lovcha.** Skobelev's mixed brigade, was now entrusted with the task. The garrison under Rifaat Pasha amounted to 8 battalions, 6 guns and some Circassians. Fighting commenced

on Sept. 1st and on the 3rd the Turks were driven out, most of the survivors finding their way to Plevna, and bringing 5 guns with them. The Russians lost 1500, the Turks 2500. On Sept. 2nd, Osman set out with a strong relieving column from Plevna, but on the 4th, hearing that the Russians had already occupied the town, he turned back and reached Plevna on the 6th. On Sept. 5th, 8 battalions and 2 batteries reached Orkhanie, and Osman's force, including the Lovcha troops, numbered about 30,000 men and 72 guns. The Russian forces, including the Rumanians, numbered about 90,000. Their plan was, after a long artillery bombardment, to attack the eastern front with the Rumanian forces, the south-eastern front with the IV. and IX. Corps and the southern front with Imeretinski's command. The attacks were to be simultaneous. The cavalry divisions were to be kept in rear and close to the flank of the attacking infantry. During the night of Sept. 6th/7th the troops were moved into preparatory position, and batteries were constructed at 3000 to 5000 yds. from the outer works. The artillery bombardment was commenced at 6 a.m. on Sept. 7th and continued till midday Sept. 11th. So far the infantry had only been engaged on the south flank, where Skobelev had succeeded Imeretinski in the command. He had succeeded in advancing to within 2000 yds. of the southern Turkish redoubts and had entrenched himself. The orders for Sept. 11th were for the infantry assaults to be delivered at 3 p.m. after a six hours' cannonade. A dense fog interfered with the artillery bombardment. At the end of the day the Rumanians had taken No. 1 Grivizta redoubt, the attack on the S.E. front had been repulsed and Skobelev had established himself within 1000 yds. of Plevna, having taken Kavanlik and Issa forts. On Sept. 12th the Turks retook these forts and drove Skobelev back. During the next two days the Russians continued to bombard the works, but no further attack was made. The Rumanians remained in possession of the Grivizta redoubt, defeating an attempt made by the Turks to retake it on Sept. 14th. The Russians then decided to retire and entrenched themselves on a line with Verbitza-Radishevo, with their cavalry extending to the Vid on either flank. There was no question of pursuit; in the first and second battles the numbers had been about equal, but now the Russians were vastly superior and Osman would have been crushed by a powerful counter-attack.

In their third battle the Turks had lost 5000, while the Russian casualties amounted to close on 20,000. The Russian bombardment, lasting four days, had effected nothing. It had not caused 200 casualties. The object of the artillery is to cover the advance of the infantry, and the arms must work in combination. The defender does not expose himself to the artillery fire unless compelled to do so by the approaching infantry. The Russians failed to realize this and practically wasted their ammunition. They had again failed to reconnoitre the position and attacked along the whole front instead of pressing home in strength at the decisive points. Their attacks were not even simultaneous, and Osman was able to shift his reserves from point to point. In addition to this, when the Russians retired one-third of their force had not been engaged. The defects in their plan of action are largely attributable to the fact that though control was nominally centred in one man, senior officers were present who interfered with his arrangements.

It was now decided to complete the investment of Plevna, and Todleben, the defender of Sevastopol, was entrusted with supreme control of the operations. He arrived on the scene on Sept. 28th, but it was not till Oct. 24th that the investment was completed, and, meanwhile, **Investment and fall of Plevna.** on Sept. 24th and again on Oct. 8th, strong reinforcements arrived, raising the Turkish force under Osman to 84 battalions, 25 squadrons and 96 guns, with an effective of 48,000 men. Plevna had been re-victualled and the sick and wounded had been sent back to Orkhanie. General Krilov, who had been operating west of the Vid, with 52 squadrons and 30 horse artillery guns, had failed to prevent these movements, and was superseded by General Gurko on Oct. 8th. The Russian

Guards Corps had all reached Plevna by Oct. 20th, and two divisions were at once placed under Gurko's orders, raising his command to 35,000 infantry, 10,000 cavalry and 48 guns. His instructions were to capture the Turkish positions along the Sofia road. He compelled the garrison of Dolni-Dubnik to retire into Plevna, and captured Gorni Dubnik and Telis with their garrisons after severe fighting on Oct. 24th and 28th. Osman's force was thereby reduced by 12 battalions. About the middle of November the opposing forces were distributed as follows: 6 divisions along the Lom, under the Cesarevich, facing Suleiman's army; 3 divisions holding the Shipka under Radetzky; 1 division at Lovcha; 2½ divisions west of the Vid under Gurko; and 12 divisions east of the Vid, investing Plevna. The XIV. Corps was in the Dobrudja, the VII. Corps about Odessa and the X. Corps in the Crimea.

On the Turkish side Suleiman advanced across the Lom, leaving small garrisons in the fortresses, and attacked at Mechka on Nov. 10th, and at Mechka and Tristenik on Nov. 26th, and again on Dec. 12th, but each time without success, and he retired across the Lom. South of the Balkans Vessil Pasha had succeeded Reouf Pasha on the Shipka. He continued to contain the three Russian divisions there, but made no attempt to dislodge them, beyond small offensive demonstrations made with the object of concealing the departure of large drafts which were sent to Sofia.

At Sofia and Orkhanie, the Turks were forming an army of recruits and reservists with the object of advancing to the relief of Osman. Mehemet Ali was entrusted with the command. Osman had already asked the sultan's permission to evacuate Plevna, with a view to co-operating with Mehemet Ali, but permission was refused. It was not till the investment was completed that the sultan changed his mind, too late, and gave his sanction to the move. The Russians received information of Mehemet Ali's intended advance, and as the force round Plevna amounted to 101 battalions, 120 squadrons and 650 guns, it was decided that Gurko should move with his detachment towards Sofia. He concentrated his force at Yablontza on Nov. 5th and succeeded in driving the Turkish advanced guard from Orkhanie. Mehemet Ali now occupied a strong position covering the Arabi Konak Pass over the Balkans, and, with a force of 43 battalions with cavalry and guns, made no attempt to relieve Osman.

Osman Pasha, his supplies having given out, eventually decided on a sortie. His troops had been short of food since the beginning of November, and the number of sick had risen to 10,000. His plan was to break through to the west and make for Sofia via Berkovitz. The Russians observed the preparations made and concentrated sufficient force at the threatened point, with the result that Osman and his army of 40,000 men capitulated. The Turkish losses in the action were about 6000 and the Russians lost about 1500. The Russians now decided, notwithstanding the difficulties due to the winter season, to push on across the Balkans. The VII. and X. Corps were still left guarding the Russian coasts. The Cesarevich was left north of the Balkans with 71,000 men to guard the communications. Gurko's force was raised to 80,000. Leaving a containing force to oppose the Turks at the Arabi Konak Pass positions, he crossed by the Curia Pass. The Turks retired unobserved, and after a feeble stand at Tashkosen retreated to Kustendil. Gurko occupied Sofia on Jan. 4th. Radetzky's force at the Shipka was raised to 66,000, with which force, having defeated Vessil Pasha, he was to join Gurko south of the Balkans. Radetzky commenced operations on Jan. 5th. Keeping one division to hold the works on the Shipka, he moved the remainder of the force in two columns under Skobelev and Prince Mirski, who were to cross one on each side and attack simultaneously from the south. Vessil Pasha held an entrenched camp at Shenovo with some 12,000 men; the remainder of his force was in position on the mountains. Owing to the difficulties of the crossing, Skobelev was delayed. Mirski attacked on

Jan. 8th and was repulsed. The following day Skobelev and Mirski attacking together were successful, and Vessil Pasha capitulated with his force, some 36,000, of whom 6000 were sick and wounded. Vessil Pasha had pointed out the danger of his position on Jan. 7th, but, contrary to Suleiman's advice, the war minister, believing an armistice imminent, had ordered him to hold on to the Shipka Pass. Mehemet Ali's force, dangerously delayed owing to interference by the minister of war, eventually reached Tatar-Bazardjik, which was selected by Suleiman (now commander-in-chief) for the concentration of his forces. Having received news of the capture of the Shipka force he retired on Philippopolis, with Gurko's forces closely pursuing. But Radetzky's forces had already pushed on and practically cut Suleiman off from Adrianople. After some engagements about Philippopolis on Jan. 15th, 16th and 17th, he retreated towards the Aegean Sea through the Rhodope mountains, having lost most of his guns, and reached Enos about Jan. 28th, whence what remained of his force was conveyed by water to Constantinople.

Suleiman had again missed his opportunity. The Russians crossed the Balkans in a wide front of about 180 miles, and there was opportunity for successful action by a capable commander. There were not only the columns commanded by Gurko and Radetzky, but also a third column under General Kartzoff, which crossed by the Trojan Pass, after which it joined Gurko's force. There were the troops under Mehemet Ali about Sofia, Vessil Pasha's force about the Shipka, and the main army on the Lom, which had been withdrawn south of the Balkans after the fall of Plevna, so that Suleiman, who had been appointed commander-in-chief, had an available force of 130 battalions, 120 guns and a proportion of cavalry. The fortified town of Adrianople offered a strong central position at which to concentrate his forces, and with this point as support, acting on interior lines, he could have dealt with the invading and widely separated columns in detail. But he missed his opportunity and left his scattered forces to be overwhelmed by superior numbers in each instance. The minister for war was undoubtedly responsible to a great extent for this faulty strategy, but the blame falls on the head of Suleiman as commander-in-chief. There was no object in leaving Vessil Pasha on the Shipka. All available forces should have been concentrated in a sound strategical situation.

The Servians had crossed the frontier after the fall of Plevna, and the Montenegrins were also pressing on. On Jan. 16th the Russians occupied Adrianople, and on Jan. 30th they were facing the Buyuk Tchemedji lines, with their flanks resting on the Black Sea and the Sea of Marmora. Mehemet Ali was in command of what remained of the Turkish armies behind the lines. On Jan. 31st an armistice was arranged, and on March 3rd the treaty of San Stefano was signed, the terms of which were modified later at the Berlin Conference in June and July 1878.

The Russo-Turkish War proved once for all the great value of improvised fortifications, in other words, of spade work in warfare, and the advantages of field works as regards invisibility against artillery fire. It was not only at Plevna that field intrenchments were made use of. Notable instances were the defence of Lovcha by the small Turkish garrison of 8 battalions with one battery, which from their entrenchments kept Skobelev with over 20,000 men and 90 guns at bay for three days, inflicting on him a loss of over 1500 men. Again, at Gorni Dubnik on Oct. 24th, 3500 Turks with 4 guns held their works throughout the day against 20,000 Russians with 60 guns, inflicting a loss on them of over 3300, and eventually were forced to surrender by a surprise attack under cover of darkness, when their ammunition had run short, and their numbers had been reduced by 1500 casualties. In the attack the success of Skobelev stands out, and we find that he had realized the necessity of intrenching the ground he had gained.

The war was brought to a conclusion, but the Turks had not been beaten in battle. With the exception of the fighting round Plevna and the rout of Suleiman's army at Philippopolis

**Turkish
move-
ments.**

**3rd
Period.—
Passage
of the
Balkans
and advance
to Constantinople.**

there had been no decisive battles. The Turks had been defeated owing to the incapacity of their leaders, none of whom had previously commanded an army organized according to modern ideas. They were ignorant of strategic principles. Then, again, the interference with the generals in the field by the authorities at Constantinople had in each case resulted in the disasters which invariably follow the attempt of civilian amateurs to control warlike operations.

On the Russian side, the enemy had been at first despised, and consequently the forces originally employed were inadequate, which meant subsequent delays, losses and expense. The command of the sea had proved of little value to the Turks. Their flotilla rendered them no assistance. In the early stages it could have materially assisted by landing reconnoitring parties N. of the Danube, and by interfering with the Russians when crossing the river. The Russian bridge offered a tempting objective throughout the campaign, but commanders with the requisite dash and initiative were not forthcoming. The defeat of the Turks was due in the first place to the failure of their politicians to ensure the adequate organization and training of the army during peace time, in the second place to the want of a commander who had educated himself to undertake the responsibilities entrusted to him. (J. H. V. C.)

A separate campaign had been waged, as before, in Asia Minor. Here the Turks under Mukhtar Pasha had 57,000 men in two corps, the one on the side of Batoum and Ardahan, the other between Erzerum and Kars. His opponent, Loris Melikov, had at first only some 28,000 infantry, but a disproportionate number of Cossack Sotnias. The Russians advanced in three weak columns. On the 17th of May after bombardment the right column stormed Ardahan. The right and centre columns then closed inwards upon Kars, which they besieged, but the siege was given up in July, after Mukhtar, advancing to its relief with 35,000 men, had repulsed Melikov's attack at Zivin (June 26th). The left column occupied Bayazid without difficulty, but when it had proceeded thence on the Erzerum road the Russian garrison was blockaded by the Turks and the column retraced its steps to relieve the place. After this it halted at Igdır in the Araxes valley. Meanwhile the Turks on the coast had advanced, in concert with their fleet, and raised an insurrection amongst the Mahomedans of the littoral. They were eventually repulsed, but the insurrection was not completely suppressed until the summer of 1878.

In August Mukhtar, who had followed up Melikov's retreat from Kars, and won the victory of Kizil-Tepe, led 30,000 men in front of this position, and behind them the Kars garrison of 10,000. Ismail on the Bayazid side had 40,000; Derwish, at Batoum 17,000. But after an interval of two months Melikov was reinforced, while drafts for the armies in Europe were taken from Mukhtar, and the grand-duke Michael, assuming command of the Russians, defeated his opponent completely in the battle of the Aladja Dagh (Oct. 15th). The remnants of Mukhtar's army retreated on Erzerum, and while part of the Russian army besieged Kars, and part attempted to cut off the retreat of Ismail on the Bayazid road, while the corps from the Araxes valley followed the latter up. Ismail slipped past them, however, and rejoined Mukhtar at Erzerum. But the two together were no longer able to resist the superior numbers of the Russians, who defeated them in a last battle at Dexe Boyun (Nov. 4th). Kars was stormed on the night of the 11th of November.

RUST (O.E. *rūst*, a word which appears in many Teutonic languages, cf. Du. *roest*, Ger. *rost*); in origin it is allied with "ruddy" and "red," the reddish-brown powdery substance which forms on the surface of iron or steel exposed to atmospheric corrosion. Formerly the process was regarded as oxidation pure and simple, and, although it was known that iron did not rust in dry air, yet no attempt was made to explain why water was necessary to the action. F. Crace-Calvert in 1871 showed that the carbon dioxide of the atmosphere was a factor; and in 1888 Crum Brown published the theory—termed the "carbonic acid theory"—that water and carbon dioxide react with iron to form ferrous carbonate and hydrogen, the ferrous carbonate being subsequently oxidized by moist oxygen to ferric hydrate and regenerating carbon dioxide, which again reacts with more iron. This theory was controverted by Wyndham Dunstan, who attempted to prove that carbon dioxide was not necessary to rusting; and in place of the acid theory, he set up a scheme which involved the production of hydrogen peroxide. G. T. Moody has since shown that when all traces of carbon dioxide are removed (which is a matter

of great experimental difficulty) iron may be left in contact with oxygen and water for long periods without rust appearing, but on the admission of carbon dioxide specks are rapidly formed. It also appears that rust changes in composition on exposure to the atmosphere, both the ferrous oxide and carbonate being in part oxidized to ferric oxide. Acids, other than carbonic, may promote rusting; this is particularly the case with ironwork exposed to the acids—sulphurous, nitric, &c.—contained in smoke. It is probable that the action depends upon the presence of iron, oxygen and water, and some acid which makes the water an electrolyte.

Steel differs in many ways from iron in respect of atmospheric corrosion; the heterogeneous nature of steel gives occasion to a selective rusting, ferrite is much more readily attacked than the cementite and pearlite; moreover, the introduction of other elements may retard rusting; this is particularly the case with the nickel-steels.

RUSTCHUK (Bulg. *Russé*), the capital of the department of Rustchuk, Bulgaria, on the right bank of the Danube, where it receives the E. Lom. Pop. (1906) 33,552. Rustchuk is the headquarters of a military division and of a naval flotilla stationed on the Danube. As a river-port and the terminus of railways from Varna and from Sofia via Trnovo, it has much commercial importance; and it possesses tobacco and cigarette factories, soap-works, breweries, aerated water factories, dyeworks, tanneries, sawmills, brick and tile works and a celebrated pottery.

In the time of the Romans Rustchuk was one of the fortified points along the line of the Danube. In the *Tabula Peutingeriana* it appears as Prisca, in the *Antonine Itinerary* as Serantaprista, in the *Notitia* as Seragintaprista and in Ptolemy as Priste Polis. Destroyed by barbarian invaders in the 7th century the town recovered its importance only in comparatively modern times. In 1810 it was captured by the Russians, who destroyed the fortifications. It played an important part in the Russo-Turkish Wars of 1828–29, 1853–54 and 1877–78. In 1877 it was nearly destroyed by the Russian artillery stationed in the Rumanian town of Giurgevo, on the opposite bank of the Danube.

RUSTENBURG, a district and town of the Transvaal, South Africa. The district originally included all the N.W. part of the country, but is now of much smaller dimensions. Its S. border is marked by the Magaliesberg and other hills forming the N. escarpment of the high veld and the watershed between the Vaal and Limpopo. Several of the headstreams of the Limpopo rise within the district on the N. slopes of the Magaliesberg. The climate of the district is sub-tropical and the principal cultivation is that of tobacco, and fruit trees, notably oranges. The opening of the railway to Pretoria in 1904 led to a marked development of trade. In an amphitheatre formed by the hills and 61 m. by rail W. of Pretoria is the town of Rustenburg with a population (1904) of 1815. The town is one of the oldest in the Transvaal, having been founded in 1850 by the *Vooruitreikers*. It was at Rustenburg that the volksraad met in March 1852 to ratify the Sand River Convention granting independence to the Transvaal Boers. At the time it was feared that there would be civil war between Hendrik Potgieter and Andries Pretorius, but they were reconciled in Potgieter's tent. Later Rustenburg became the home of the Kruger family. It was occupied by the British under R. S. Baden Powell in June 1900.

RUSTICATION (i.e. the making "rustic" or countrified, from Lat. *rūs*, country; thus the term "rusticate" is used for taking a country holiday, or in academic circles to be "rusticated" is to be sent away from a university for punishment), in architecture, the technical term (French equivalent *bossage*) given to masonry in which the centre part of the face of the stone is either left rough as it came from the quarry, or is worked in various ways to give variety to the surface. The earliest example exists in the platform at Pasargadae in Persia (560 B.C.), erected by Cyrus, where the edge round the four sides of the stone forms a draft, two or three inches wide, worked with a chisel, the centre

part being left rough. Similar work exists at Arak-el-Emir in Palestine (151 B.C.). The finest examples are those of the walls of the temple at Jerusalem, and at Hebron, where the stones are of immense size and the rustication projects sometimes over a foot. The Crusaders' castles in Palestine are all boldly rusticated, but the projecting portions have been worked over with a chisel in diagonal lines, and this enables them to be distinguished from the earlier masonry. In the five-sided tower at Nuremberg and the Burg-Capelle at Rothenburg, the rustication has a decorative value, so that in later work it was employed for the quoins-stones of towers. The masonry of the Palazzo Vecchio, and of the Pitti, Strozzi and Riccardi palaces, all in Florence, and of other palaces in Siena and Volterra, is rusticated. Rustication was employed in terraces and grottos in Italy, where on account of its extravagances it gave rise to the term "grotesque." In the later Renaissance the edges of the stone were bevelled off, with a sunk joint in addition; and the treatment was known as vermiculated, if in imitation of earth burrowed by worms; marine, if with small shell holes; stalactitic, if carved in imitation of lime deposits, &c. In Italy the projecting portions were sometimes worked into facets. Rustication was introduced into England by Inigo Jones, who, in old Somerset House, York Stairs Watergate, the gateway of the Botanical Garden at Oxford, and elsewhere, used it only in alternate courses, his example being followed by other architects of the Renaissance. The term is now applied to the ashlar blocks of masonry which alternate with the circular drums of columns in many public buildings.

RÜSTOW, FRIEDRICH WILHELM (1821-1878), Swiss soldier and military writer, was a Prussian by birth. He entered the service of his native country, and served for some years, until the publication of *Der Deutsche Militärstaat vor und während der Revolution* (Zürich, 1850) brought him official condemnation. He was sentenced by a court-martial to a long term of fortress imprisonment, but succeeded in escaping to Switzerland. He obtained military employment in the service of the Republic, and in 1857 was major on the engineer staff. Three years later he accompanied Garibaldi in the famous expedition against the two Sicilies as colonel and chief of the staff, and to him must be ascribed the victories of Capua (19th Sept. 1860) and the Voltorno (1st Oct. 1860). At the end of the campaign he once more settled down at Zürich. At the outbreak of the war of 1870 he offered his services to Prussia, but was not accepted. In 1878, on the foundation of a military professorship at Zürich, Rüstow applied for the post, and, on its being given to another officer, lost heart and committed suicide.

Two younger brothers, both Prussian soldiers, were also distinguished men. The elder, ALEXANDER (1824-1866), is remembered for his work *Der Küstenkrieg* (Berlin, 1848); the younger, CAESAR (1826-1866), was one of the foremost experts of his time in the design and construction of military rifles, and the writer of several treatises on that subject, of which we may mention *Die Kriegsgeschützmaschinen* (Berlin, 1857-64). Both Alexander and Caesar fell on the field of battle in the war of 1866, at Königgrätz and Dermach respectively.

Amongst F. W. Rüstow's works, which covered nearly every branch of the military art, a large number must be mentioned. *Historical-Heracles and Kriegführung Julius Cæsars* (Gotha, 1855; 2nd ed., Nordhausen, 1862), *Kommentar zu Napoleon III.'s Geschichte Julius Cæsars* (Stuttgart, 1865-67), *Geschichte des Griechischen Kriegswesens* (in collaboration with Köchly, Aarau, 1852), *Militär-Biographien (David, Xenophon, Montluc)* (Zürich, 1858), *Geschichte der Infanterie* (Gotha, 1857-58; 3rd ed., 1884), *Die Ersten Feldzüge Napoleons 1796-1797* (Zürich, 1867), *Der Krieg von 1805 in Deutschland und Italien* (Frauenfeld, 1854), *Geschichte des Ungarischen Insurrektionskrieges 1848-49* (Zürich, 1860), reminiscences of 1860 in Italy (Leipzig, 1861) and monographs on the campaigns of 1848-49 in Italy (Zürich, 1849) and the Crimean War (Zürich, 1855-56). Critical and General—*Allgemeine Taktik* (Zürich, 1858; 2nd ed., 1868), *Kriegspolitik und Kriegsgebrauch* (Zürich, 1876), *Militär-Handwörterbuch* (Zürich, 1859), *Die Feldherrnkunst des XIX Jahrhunderts* (Zürich, 1857; 3rd ed., 1878-79), *Der Krieg und seine Mittel* (Leipzig, 1856). He also wrote *Annalen des Königreichs Italien* (Zürich, 1862-63).

See Zernin, "F. W. Rüstow," in *Unsere Zeit*, vol. 2 (Leipzig, 1882).

RUTEBEUF, or RUSTEBUEF (fl. 1245-1285), French trouvère, was born in the first half of the 13th century. His name is nowhere mentioned by his contemporaries. He frequently plays in his verse on the word Rutebeuf, which was probably a *nom de guerre*, and is variously explained by him as derived from *rude basif* and *rude œuvre*. He was evidently of humble birth, and he was a Parisian by education and residence. Paulin Paris thought that he began life in the lowest rank of the minstrel profession as a *jongleur*. Some of his poems have autobiographical value. In *Le Mariage de Rutebeuf* he says that on the 2nd of January 1261 he married a woman old and ugly, with neither dowry nor amiability.¹ In the *Complainte de Rutebeuf* he details a series of misfortunes which have reduced him to abject destitution. In these circumstances he addresses himself to Alphonse, comte de Poitiers, brother of Louis IX., for relief. Other poems in the same vein reveal that his own miserable circumstances were chiefly due to a love of play, particularly a game played with dice, which was known as *grièche*. It would seem that his destitution could not be due to lack of patrons, for his metrical life of Saint Elizabeth of Hungary was written by request of Erard de Valéry, who wished to present it to Isabel, queen of Navarre; and he wrote elegies on the deaths of Anceau de l'Isle Adam, the third of the name, who died about 1251, Eude, comte de Nevers (d. 1267), Thibaut V. of Navarre (d. 1270), and Alphonse, comte de Poitiers (d. 1271), who were probably paid for by the families of the personages celebrated. In the *Pauvreté de Rutebeuf* he addresses Louis IX. himself.

The piece which is most obviously intended for popular recitation is the *Dit de l'Herberie*, a dramatic monologue in prose and verse supposed to be delivered by a quack doctor. Rutebeuf was also a master in the *verse conte*, and the five of his *fabliaux* that have come down to us are gay and amusing. The matter, it may be added, is sufficiently gross. The adventures of *Frère Denyse le cordelier*, and of "*la dame qui alla trois fois autour du moulier*," find a place in the *Cent Nouvelles nouvelles*.

Rutebeuf's serious work as a satirist probably dates from about 1260. His chief topics are the iniquities of the friars, and the defence of the secular clergy of the university of Paris against their encroachments; and he delivered a series of eloquent and insistent poems (1262, 1263, 1268, 1274) exhorting princes and people to take part in the crusades. He was a redoubtable champion of the university of Paris in its quarrel with the religious orders who were supported by Pope Alexander IV., and he boldly defended Guillaume de Saint-Amour when he was driven into exile. The libels, indecent songs and rhymes condemned by the pope to be burnt together with the *Péris des derniers temps* attributed to Saint-Amour, were probably the work of Rutebeuf. The satire of *Renart le Bestourné*, which borrows from the Reynard cycle little but the names under which the characters are disguised, was directed, according to Paulin Paris, against Philip the Bold. To his later years belong his religious poems, and also the *Voie de Paradis*, the description of a dream, in the manner of the *Roman de la Rose*.

The best work of Rutebeuf is to be found in his satires and *verse contes*. A miracle play of his, *Le Miracle de Théophilus*, is one of the earliest dramatic pieces extant in French. The subject of Theophilus, the Cilician monk who made a pact with the devil, which was afterwards returned to him by the intervention of the Virgin, was a familiar one with the story-tellers of the middle ages. Rutebeuf can claim no priority in the choice of the subject, which had been treated dramatically in the Latin piece ascribed to the nun Hrosiwtha of Gandersheim, but his piece has considerable importance in dramatic history.

The *Œuvres* of Rutebeuf were edited by Achille Jubinal in 1839 (new edition, 1874); a more critical edition is by Dr Adolf Kressner

¹ It has been suggested that Brunetto Latini was thinking of Rutebeuf when he wrote in his *Livre du Trésor*: "Le Rire, le jeu, voilà la vie du jongleur, qui se moque de lui-même, de sa femme, de ses enfants, de tout le monde."

(*Rustebuef's Gedichte*; Wolfenbüttel, 1885). See also the article by Paulin Paris in *Hist. litt. de la France* (1842), vol. xx. pp. 719-83; and *Rulebeuf* (1891), by M. Léon Clédaf, in the *Grands Écrivains français* Series.

RUTH, BOOK OF, in the Old Testament. The story of Ruth (the Moabitess, great-grandmother of David) is one of the Old Testament Hagiographa and is usually reckoned as the second of the five *Megilloth* (Festal Rolls). This position corresponds to the Jewish practice of reading the book at the feast of Pentecost; Spanish MSS., however, place it at the head of the *Megilloth*; and the Talmud (*Baba Bathra*, 14b) gives it the first place among all the Hagiographa. On the other hand, it follows Judges in the Septuagint, the Vulgate and the English version. But although it was very natural that a later rearrangement should transfer Ruth from the Hagiographa to the historical books, and place it between Judges and Samuel, no motive can be suggested for the opposite change, and the presumption is that it found a place in the last part of the Jewish canon after the second (with the historical books) had been definitely closed. See BIBLE: *Old Testament*, section I. "Canon"; CANTICLES; LAMENTATIONS.

That the book of Ruth did not originally form part of the series of "Former Prophets" (Joshua-Kings) is further probable from the fact that it is quite untouched by the process of "prophetic" or "Deuteronomistic" editing, which helped to give that series its present shape after the fall of the kingdom of Judah. The narrative has no affinity with the point of view which looks on the history of Israel as a series of examples of divine justice and mercy in the successive rebellions and repentances of the people of God.¹ But if the book had been known at the time when the history from Joshua to Kings was edited it could hardly have been excluded from the collection; the ancestry of David (iv. 17, 18-22) was of greater interest than that of Saul, which is given in 1 Sam. ix. 1, whereas the old history names no ancestor of David beyond his father Jesse.

In truth the book of Ruth presents itself as dealing with times far back (Ruth i. 1), and takes delight in depicting details of antique life and obsolete usages (iv. 7); it **Date.** views the stormy period before the institution of the kingship through the softening atmosphere of time, which imparts to the scene a gentle sweetness very different from the harsher colours of the old narratives of the book of Judges. It has indeed been argued that, as the author seems to take no offence at the marriage of Israelites with Moabite women, he must have lived before the time of Ezra and Nehemiah (Ezra ix.; Neh. xiii.); but the same argument would prove that the book of Esther was written before Ezra. The very designation of a period of Hebrew history as "the days of the judges" is based on the Deuteronomistic additions to the book of Judges (ii. 16 sqq.) and does not occur till the period of the exile. It is true that the language has some features which appear to link it with the narratives in Samuel and Kings, but it might fairly be assumed either that the book is the work of a late author well acquainted with the earlier literature, or that an old narrative had undergone some rewriting at a later age. No definite conclusion can be drawn from the fact that the language stands in marked contrast to that of Chronicles, Ezra, Nehemiah, &c., since writers presumably more or less contemporary did not necessarily share the same characteristics (observe, for example, the prose parts of Job).

Like the stories appended to Judges (by a post-Deuteronomist hand) the book of Ruth connects itself with Bethlehem, the traditional birthplace of David. Some connexion between Bethlehem and Moab has been found in the (now corrupt) text of 1 Chron. iv. 22 (where the Targum and late rabbinical exegesis discover references to the story of Ruth), and is more explicitly suggested by the isolated 1 Sam. xxii. 3 seq. which evidently knew of some relationship between Moab and the illustrious descendant of Boaz and Ruth. Next, the writer claims the sympathy of his readers

¹ The religious pragmatism lacking in the original is in part supplied by the Targum (i. 5, 6).

for Ruth, upon whose Moabite origin he frequently insists, and this feature is noteworthy in view of the aversion with which intermarriage was regarded at a certain period (Deut. xxiii. 3; Neh. xiii.; Ezra ix. seq.). The independent evidence for the present post-exilic form of the book has consequently led many scholars to the conclusion that it was directed against the drastic steps associated with the reforms of Ezra and Nehemiah, which, as is known, were not everywhere acceptable. Thus, not only do we have a beautiful portrait of a woman of Moabite origin, but she becomes the ancestress of David himself, and in the days of these measures the charming and simple story would inevitably suggest the question whether the exclusiveness of Judaism could not be carried too far. There is no reason, however, to believe that this was the original object of the story. It contains other features of considerable interest to which more importance seems to be attached, and the writer is evidently an artist who takes manifest delight in the touching and graceful details of his picture, and is not simply guided by a desire to impart historical information or to enforce some particular lesson.

One does not look for absolute consistency in oriental narratives, and even this little book contains several internal intricacies which demand investigation. The genealogy from Perez to David in iv. 18-22 is of little value since Salma (Salmon), father of Boaz, is a Calebite clan-name, not associated with its earlier seat S. of Hebron as in Judges i., 1 Sam. xxv., &c., but as "father" of Bethlehem, representing exile or later conditions (1 Chron. ii. 51; see CALEB). Apart from other signs of a late date in this list of the ancestors and descendants of Boaz, iv. 12 certainly implies that the genealogical lines of Perez and Boaz were not identical, and thus verses 18-22 in the opinion of most scholars are a later addition.

Further, the story involves points of old family usage which are no longer clear. The well-known custom which gives the nearest heir of the dead a right to inherit the widow is naturally distinct from the levirate (g. z.), where it is the brother's duty to marry his widowed sister-in-law if childless, and where the eldest son succeeds to the name and inheritance of the deceased. In Hebrew usage the refusal to perform the levirate brought ignominy (see Deut. xxv. 5-10), and Gen. xxxviii. relates how Tamar, when Shelah was not given to her, obtained a child through her father-in-law Judah (see esp. vers. 14, 26).² In addition to these customs to prevent the alienation of the estate and to perpetuate the family name, the post-exilic story in Num. xxvii. 1-11, xxxvi. gives daughters the right of inheritance provided they do not marry outside the tribe. Although the levirate still continued (Matt. xxii. 24 sqq.), the late laws in Lev. xviii. 16, xx. 21, as also this story, may be aimed against it. Finally, the *gōel* ("next kinsman," lit. "avenger"; see Driver, *Ency. Bib. col.* 1745 sqq.) has the first right of purchase to an estate (Jer. xxxii. 6-15), and indeed must redeem the property which his needy relative might be compelled to sell (Lev. xxv., see ver. 25). Now it appears that Boaz combines the essential duty of the *gōel* in purchasing the estate over which Naomi holds rights, and at the same time marries, not Naomi, who is now old, but her daughter-in-law Ruth, in order to perpetuate her husband's family. Naomi, who had realized the impossibility of the levirate in her case (i. 11 seq.), returned home a disconsolate and childless widow (i. 20 seq.), but the filial Ruth fell in with her plans and put herself entirely into the hands of the kinsman Boaz (iii.). In the happy finale, Naomi is the recipient of congratulations upon the birth of a son to the faithful Ruth (iv. 17a, "there is a son born to Naomi"); the name of the dead is thus "raised up" (iv. 5, 10), and the child Obed is clearly recognized

² See further, W. R. Smith, *Kinship and Marriage in Early Arabia*, 2nd ed. p. 105; Wellhausen, *Götting. Gelehrte Anzeig.* (1893), pp. 455 seq. Ruth iv. 7 refers to the custom of drawing off the shoe as a sign of renunciation (cf. Deut. loc. cit., and G. A. Smith, *Ency. Bib. col.* 5196 head), and ver. 12 to the story of Tamar and Judah. Compare, for the retention of simple methods of transacting business, the striking of hands (Prov. vi. 1, xxii. 26).

Critical problems.

as of the line of Elimelech and Mahlon (Naomi's husband and son). In point of fact, a nearer kinsman than Boaz had agreed to purchase the estate (as *göel*), which Naomi evidently had not yet sold (see commentaries on iv. 3); but he was unwilling to marry Ruth (reading in ver. 5, "and also Ruth thou must buy"; cf. ver. 10), recognizing that if a son were born the estate would revert to the line of Elimelech, thus leaving him at a disadvantage. He was evidently unprepared for what seems a novel condition (contrast Boaz in iii. 12 seq.), although, from the felicitations in iv. 11-13, the issue of the marriage is actually reckoned to the husband (Boaz). It is improbable that these conflicting features in v. 11-13 and ver. 17a, and all that they involve, co-existed, and it is possible that the former (with the implied reference to the coming David) is not part of the original. However, as in the equally complicated story in Gen. xxxviii, it is difficult to trace the extent or growth of the various motives, e.g. the primary interest in Naomi, the romantic marriage of Ruth, the selling of the land (which comes only in ch. iv.), &c.

LITERATURE.—See S. R. Driver, *Literature of Old Testament*, who, with C. F. Kent (*Beginnings of Heb. Hist.*, p. 310 seq.), favours a pre-exilic origin. An exilic date has found the support of Ewald and König, but that it is now of the post-exilic age is the opinion of most writers. See further W. R. Smith's art. "Ruth" in *Ency. Brit.* 9th ed. (several portions of which have been retained by the present writer), revised and supplemented by T. K. Cheyne in *Ency. Bib. & A. Bertholet, Kurzer Handkommentar* (1898); W. Nowack, *Handkommentar* (1902); and with special reference to traces of earlier mythological motives) H. Winckler, *Altorient. Forschungen* (iii. 66 sqq.). For the customs discussed above, see I. Beninger, *Ency. Bib. col.* 2949 seq.; J. A. Bewer, *Theol. Stud. u. Krit.* (1903), pp. 328 seq.; 302 seq. (with G. A. Barton's art. "Ruth" in *Jew. Encyc.*); and T. W. Juyboll, *Theolog. Tijdschr.* (1906), pp. 158 seq.

(W. R. S. & S. A. C.)

RUTHENIANS, a name applied to those of the Little Russians who are Austrian subjects. The name is a form of the word *Russian*. The Ruthenians were separated from the bulk of Russians by the accident of the two feudal principalities of the old Red Russia, Halicz and Volhynia, having fallen to Lithuania, which in turn was united with Poland. At the partition of Poland no one troubled about ethnological boundaries. The language is in substance like the Little Russian of the Ukraine, though it has marked differences; the most interesting dialects are those in the extreme W., which approach to Slovak and that of the Huzuli in Bukovina. The Ruthenians number some three million in Galicia, Bukovina, and in the Carpathians along the edges of Hungary from the 21st meridian eastwards. Throughout Galicia the Poles form the aristocracy, though in two-thirds of it Ruthenians form the bulk of the population, while the middle class is Jewish or German. The Ruthenians are therefore under an alien yoke both politically and economically: in religion they mostly belong to the Uniate Church, acknowledging the Pope but retaining their Slavonic liturgy and most of the outward forms of the Greek Church. Their intellectual centre is Lemberg (Lviv or Lwów), where some lectures in the university are given in their language, and they are agitating for it to have equal rights with Polish. Yet here Little Russian is freer than in the Russian empire, and in Lemberg is the centre of its literature, the society called by the name of *Ševčenko*, the Little Russian poet. This society publishes voluminous transactions in a special orthography and deals with everything concerning Little Russia, its archaeology, people and language.

See summary of the work of the Ševčenko for ten years in *Archiv f. slavische Phil.* xxvii. (1905), p. 279.

RUTHENIUM [symbol Ru, atomic weight 101.7 (O=16)], in chemistry, a metallic element, found associated with platinum, in platinum ore and in osmiridium. The metal may be obtained from the residues obtained in the separation of osmium from osmiridium. These are washed with ammonium chloride until the filtrate is colourless, ignited, fused with caustic potash and nitre, the melt dissolved in water and nitric acid added to the solution until the colour of potassium ruthenate disappears. A precipitate of ruthenium oxide gradually separates; this is collected and ignited in a graphite crucible and finally fused in

the oxyhydrogen furnace (H. Sainte-Claire Deville and H. J. Debray, *Ann. chim. phys.*, 1859, (3), 56, p. 406). For other methods see C. E. Claus, *Pogg. Ann.*, 1845, 65, p. 200; E. Frémy, *Comptes rendus*, 1854, 38, p. 1008; T. Wilm, *Ber.*, 1883, 16, p. 1524. A purer ruthenium is obtained by A. Gutbier and L. Trenker (*Zeit. anorg. Chem.*, 1905, 45, p. 166) by heating the crude metal (obtained by other processes) in a current of oxygen until all the osmium is volatilized as tetroxide. The residue is then fused with caustic potash and nitre, dissolved in water, saturated with chlorine and distilled on the water-bath in a current of chlorine. Pure ruthenium tetroxide distils over. This is then dissolved in water, reduced by alcohol and ignited in oxygen. Ruthenium in bulk resembles platinum in its general appearance, and has been obtained crystalline by heating an alloy of ruthenium and tin in a current of hydrochloric acid gas. Its specific gravity (after fusion) is 12.063 (A. Joly, *Comptes rendus*, 1893, 116, p. 430). It fuses easily in the electric arc. It oxidizes superficially when heated, but fairly rapidly when ignited in an oxidizing blowpipe flame, forming a black smoke of the oxide. It is also oxidized when fused with caustic potash and nitre, forming a ruthenate. Acids have practically no action on the metal, but it is soluble in solutions of the alkaline hypochlorites. Like most of the other metals of the group, it absorbs gases. A colloidal form has been obtained by A. Gutbier and G. Hofmeier (*Jour. prakt. Chem.*, 1905, (2), 71, p. 452) by reducing ruthenium salts with hydrazine hydrate in the presence of gum-arabic.

Several oxides of ruthenium have been described, the definite existence of some of which appears to be doubtful. The dioxide, RuO₂, is formed by heating sulphate, or by heating the metal in a current of oxygen. It crystallizes in octahedra isomorphous with stannic oxide. It is insoluble in acids and decomposes when heated to a sufficiently high temperature. Fusion with caustic potash converts it into a mixture of potassium ruthenate and ruthenium sesquioxide, Ru₂O₃, which is a black, almost insoluble powder. An oxide of composition Ru₃O₄ is obtained as a black hydrated powder when the peroxide is heated with water for some time. It becomes anhydrous at about 360° C., and is unattacked by acids and alkalis. The peroxide, RuO₄, is formed when a solution of potassium ruthenate is decomposed by chlorine, or by oxidizing ruthenium compounds with potassium chlorate, or with hydrochloric acid, or with potassium permanganate and sulphuric acid. It forms a golden yellow crystalline mass, which sublimes slowly in vacuo, and melts at 25.5° C. It blackens on exposure to moisture, and decomposes when exposed to light. It is insoluble in water, but gradually decomposes, forming a hydrated oxide, Ru₂O₃.H₂O. It is readily reduced. Its vapour possesses a characteristic smell, somewhat resembling that of ozone. Ruthenium dichloride, RuCl₂, is obtained (in solution) by reducing the sesquichloride by sulphuretted hydrogen or zinc. It is stable in the cold. The sesquichloride, Ru₂Cl₃, is formed when a mixture of chlorine and carbon monoxide is passed over finely divided ruthenium heated to 350° C. (Joly, *Comptes rendus*, 1892, 114, p. 291). It is a brown powder which is readily decomposed by boiling water. It absorbs ammonia readily, forming Ru₂Cl₃.7NH₃. Numerous double chlorides are known, e.g. Ru₂Cl₃.4KCl; Ru₂Cl₃.4NH₄Cl, &c. The pure tetrachloride, RuCl₄, has not been isolated, but is chiefly known in the form of its double salts, such as potassium ruthenium chloride, K₂RuCl₆, which is obtained when finely divided ruthenium is fused with caustic potash and potassium chloride is gradually added to the fused mass (U. Antony and A. Luchesi, *Gazz.*, 1899, 29, II, p. 82). It is a red-brown crystalline powder, which is soluble in water. A similar ruthenium salt has been obtained. Ruthenium sulphides are obtained when the metal is warmed with pyrites and some borax, and the fused mass treated with hydrochloric acid first in the cold and then hot. The insoluble residue contains a mixture of two sulphides, one of which is converted into the sulphate by nitric acid, whilst the other (a crystalline solid) is insoluble in acids. Ruthenium sulphate, Ru(SO₄)₃, as obtained by oxidizing the sulphide, is an orange-yellow mass which is deliquescent and dissolves in water, the solution possessing a strongly acid reaction. *Rouge de Ruthene*, Ru₂(OH)₂Cl₂(NH₄)₂, is obtained from ammonia and ruthenium sesquichloride at 60° C., the product being purified by crystallization from ammonia. It forms small brown lamellae which dissolve slowly in water to give a fuchsia-red solution possessing a violet reflex. The solution possesses a considerable tinctorial power, dyeing silk in the cold. Potassium ruthenium cyanide, K₂Ru(CN)₂.3H₂O, formed when potassium ruthenate is boiled with a solution of potassium cyanide, crystallizes in colourless plates which are soluble in water. A ruthenium silicide, RuSi₃, has been prepared by H. Moissan (*Comptes rendus*, 1903, 137, p. 229) by the

direct combination of the two elements in the electric furnace. It forms very hard metallic-looking crystals, burns in oxygen and is not attacked by acids. Potassium ruthenate, $K_2RuO_6 \cdot H_2O$, obtained by fusion of the metal with caustic potash and nitre, crystallizes in prisms which become covered with a black deposit on exposure to moist air. It is soluble in water, giving an orange-red solution which becomes green on standing, and gradually deposits the hydrated pentoxide, $Ru_2O_5 \cdot H_2O$ (H. Debray and A. Joly, *Comptes rendus*, 1888, 106, p. 1494). The per-ruthenate, $KRuO_6$, formed by the action of chlorine on the ruthenate, or of alkalis on the peroxide at $50^\circ C.$, is a black crystalline solid which is stable in dry air but decomposes when heated strongly. On the nitroso, nitroso-ammonium and nitroso-diammonium compounds see C. E. Claus, *Ann.*, 1856, 98, p. 317; A. Joly, *Comptes rendus*, 1888, 107, p. 994; 1889, 108, pp. 854, 1200; 1890, 111, p. 969; L. Brizard, *ibid.*, 1896, 122, p. 739; 1896, 133, p. 182. The atomic weight of ruthenium was determined by A. Joly (*Comptes rendus*, 1889, 188, p. 946), who obtained the values 101.5 and 101.3.

RUTHERFORD, MARK, the pen-name of William Hale White, English author, who was born at Bedford about 1830. His father, William White, a member of the nonconformist community of the Bunyan Meeting, removed to London, where he was well known as a doorkeeper of the House of Commons; he wrote sketches of parliamentary life for the *Illustrated Times*, papers afterwards collected by his son as *The Inner Life of the House of Commons* (1897). The son was educated for the Congregational ministry, but the development of his views prevented his taking up that career, and he became a clerk in the admiralty. He had already served an apprenticeship to journalism before he made his name as a novelist by the three books "edited by Reuben Shapcott," *The Autobiography of Mark Rutherford* (1881), *Mark Rutherford's Deliverance* (1885), and *The Revolution in Tanner's Lane* (1887). Under his own name he translated Spinoza's *Ethic* (1883). Later books are *Miriam's Schooling*, and *other Papers* (1890), *Catherine Furze* (2 vols., 1893), *Clara Hopgood* (1896), *Pages from a Journal, with other Papers* (1900), and *John Bunyan* (1905). Though for a long time little appreciated by the public, his novels—particularly the earlier ones—have a power and style which must always give his works a place of their own in the literary history of their time.

RUTHERFORD, WILLIAM GUNION (1853–1907), English scholar, was born in Peeblesshire on the 17th of July 1853. He was educated at St Andrews and Oxford, where he graduated in natural science, with a view to following the medical profession, which he abandoned in favour of a scholastic career. From 1883 to 1901 he was headmaster of Westminster school; and his death, on the 19th of July 1907, deprived classical scholarship in England of one of its most brilliant modern representatives. Rutherford devoted special attention to Attic idioms and the language of Aristophanes. His most important work, the *New Phrynichus* (1882), dealing with the Atticisms of the grammarian, was supplemented by his *Babrius* (1883), a specimen of the later Greek, which was the chief subject of C. A. Lobeck's earlier commentary (1820) on Phrynichus. His edition (1896–1905) of the Aristophanic scholia from the Ravenna MS. was less successful. Mention may also be made of his *Elementary Greek Accidence and Lex Rex*, a list of cognate words in Greek, Latin and English.

RUTHERFORD (or RUTHERFORD), **SAMUEL** (c. 1600–1661), Scottish divine, was born about 1600 at the village of Nisbet, Roxburghshire. He went to college at Edinburgh in 1617, graduating M.A. in 1621, and two years afterwards was elected professor of humanity. On account of an alleged indiscretion before his marriage in 1626 he was dismissed his professorship in that year, but, after studying theology, he was in 1627 appointed minister of Anwoth, Kirkcudbrightshire, and soon took a leading place among the clergy of Galloway. In 1636 his first book, entitled *Exercitationes Apologeticae pro Divina Gratia*—an elaborate treatise against Arminianism—appeared at Amsterdam. Its severe Calvinism led to a prosecution by the bishop, Thomas Sydeser, in the High Commission Court, first at Wigtown and afterwards at Edinburgh, with the result that Rutherford was deposed from his pastoral office, and sentenced to confinement in Aberdeen during the king's pleasure.

His banishment lasted from September 1636 to February 1638, and the greater number of his published *Letters* belong to this period of his life. He was present at the signing of the Covenant in Edinburgh in 1638, and at the Glasgow Assembly of the same year he was restored to his parish. In 1639 he was appointed professor of divinity in St Mary's College, St Andrews. He only accepted the position on the condition that he should be allowed to act as colleague to Robert Blair in the church of St Andrews. He was sent up to London in 1643 as one of the eight commissioners from Scotland to the Westminster Assembly. Remaining at his post over three years, he did great service to the cause of his party. In 1642 he had published his *Peaceable and Temperate Plea for Paul's Presbytery in Scotland*, and the sequel to it in 1644 on *The Due Right of Presbyteries* provoked Milton's contemptuous reference to "mere A. S. and Rutherford" in his sonnet *On the New Forcers of Conscience under the Long Parliament*. In 1644 also appeared Rutherford's *Lex Rex, a Dispute for the Just Prerogative of King and People*, which gives him a recognized place among the early writers on constitutional law; it was followed by *The Divine Right of Church Government and Excommunication* (1646), and *Free Disputation against Pretended Liberty of Conscience* (1648), characterized by Bishop Heber as "perhaps the most elaborate defence of persecution which has ever appeared in a Christian country." Among his other works are *The Tryal and Triumph of Faith* (1645), *Christ Dying and Drawing Sinners to Himself* (1647), and *Survey of the Spiritual Antichrist* (1648). In 1647 he returned to St Andrews to become principal of the New College there, and in 1648 and 1651 he declined successive invitations to theological chairs at Harderwijk and Utrecht. After the Restoration in 1660, his *Lex Rex* was ordered to be burned. He was deprived of all his offices, and on a charge of high treason was cited to appear before the ensuing parliament. His health utterly broke down, and he drew up, on the 26th of February 1661, a *Testimony*, which was posthumously published. He died on the 23rd of the following March.

The fame of Rutherford now rests principally upon his remarkable *Letters*, which, to the number of 215, were first published anonymously by M^r Ward, an amanuensis, as *Joshua Redivivus, or Mr Rutherford's Letters*, in 1664. They have been frequently reprinted, the best edition (365 letters) being that by Rev. A. A. Bonar (1848), with a sketch of his life. In addition to the other works already mentioned, Rutherford published in 1651 a treatise, *De Divina Providentia*, against Molinism, Socinianism and Arminianism, of which Richard Baxter, not without justice, remarked that "as the *Letters* were the best piece so this was the worst he had ever read."

See also a short *Life* by Rev. Dr Andrew Thomson (1884); Dr A. B. Grosart in *Representative Nonconformists*; Dr Alexander Whyte, *Samuel Rutherford and some of his Correspondents* (1894); Rev. R. Gilmour, *Samuel Rutherford* (1904).

RUTHERGLEN (locally pronounced *Rüglen*), a royal municipal and police burgh of Lanarkshire, Scotland. Pop. of royal burgh (1901) 18,270. It is situated on the left bank of the Clyde, 2½ m. by the Caledonian railway S.E. of Glasgow, with the E. of which it is connected by a bridge. The parish church stands near the spire of the ancient church where, according to tradition, the treaty was made in 1297 with Edward I., by which Sir John Menteith undertook to betray Wallace to the English. The principal public building is the town hall, dating from 1861. The industries include collieries, chemical works, dye-works, cotton- and paper-mills, chair-making, tube-making, pottery, rope- and twine-works and some shipbuilding. It forms one of the Kilmarnock group of parliamentary burghs, with Dumbarton, Port-Glasgow, Renfrew and Kilmarnock.

Rutherford was erected into a royal burgh by David I. in 1126. It then included a portion of Glasgow, but in 1226 the boundaries were rectified so as to exclude the whole of the city. In early times it had a castle, which was taken by Robert Bruce from the English in 1313. It was kept in good repair till after the battle of Langside (1568), when it was burnt by order of the regent Moray. In 1679 the Covenanters published their "Declaration and Testimony" at Rutherford prior to the battles of Drumclog and Bothwell Brig (1679).

RUTHIN (*Rhudd din*, "red fortress"), a municipal and contributory parliamentary borough (with Denbigh and Holt) and market town of Denbighshire, N. Wales, situated on a hill rising from the river Clwyd, 21 m. from Chester, and 215 from London by rail. Pop. (1901) 2643. It is on the Great Western railway (Denbigh, Corwen & Ruthin branch). Apart from the legends of Arthur and his limestone block (shown in the market-place), the first event of note in its history is its connexion with the de Grey de Ruthyn family (the first lord died 1353). Owen Glendower attacked it unsuccessfully in 1400. It was sold by the de Greys to Henry VII., and Elizabeth gave it to the earl of Warwick. In 1646, after two months' siege, it was dismantled by the Parliamentarians. The new castle occupies the same site, and is built of the same coloured sandstone as the old. New buildings for the Free Grammar School (founded in 1595 by Gabriel Goodman, dean of Westminster, who also in 1590 had built the hospital for twelve decayed housekeepers), were opened in the town in 1893. The old (conventual) Anglican church of St Peter, once belonging to "Les Bons-homes," and made collegiate in 1310 by John de Grey, has a Perpendicular north aisle roof, nearly 500 panels of carved oak, and cloisters which have been made into a house for the warden of the hospital. Agriculture is the staple, but there are chemical, aerated waters, bricks, terra-cotta and other manufactures.

RUTHVEN, the name of a noble Scottish family which traces its descent from a certain Thor, who settled in Scotland during the reign of David I. In 1488 one of its members, Sir William Ruthven (d. 1528), was created a lord of parliament as Lord Ruthven. His eldest son William was killed at Flodden in 1513, and consequently his grandson William succeeded him in the title, and after holding the offices of extraordinary lord of session and keeper of the privy seal died in December 1552, leaving three sons. The eldest of these, Patrick, 3rd Lord Ruthven (c. 1520-1566), played an important part in the political intrigues of the 16th century as a strong Protestant and a supporter of the lords of the congregation. He favoured the marriage of Mary with Darnley, and was the leader of the band which murdered Rizzio. This event was followed by his flight into England, where he died on the 13th of June 1566. Ruthven wrote for Queen Elizabeth a *Relation of the murder*, which is preserved in MSS. in the British Museum.

A descendant of the 1st Lord Ruthven in a collateral line, also named Patrick Ruthven (c. 1573-1651), distinguished himself in the service of Sweden, which he entered about 1606. As a negotiator he was very useful to Gustavus Adolphus because of his ability to "drink immeasurably and preserve his understanding to the last," and he also won fame on the field of battle. Having taken part in the Thirty Years' War and been governor of Ulm, he left the Swedish service and returned to Scotland, where he was employed by Charles I. He defended Edinburgh Castle for the king in 1640, and when the Civil War broke out he joined Charles at Shrewsbury. He led the left wing at the battle of Edgehill, and after this engagement was appointed general-in-chief of the Royalist army. For his services he was created Lord Ruthven of Ettrick in 1639, earl of Forth in 1642 and earl of Brentford in 1644. The earl compelled Essex to surrender Lostwithiel, and was wounded at both battles of Newbury. But his faculties had begun to decay, and in 1644 he was superseded in his command by Prince Rupert. After visiting Sweden on a mission for Charles II., Brentford died at Dundee on the 2nd of February 1651. He left no sons and his titles became extinct.

Patrick, 3rd Lord Ruthven, was succeeded as 4th lord by his son William (c. 1541-1584), who like his father was prominent in the political intrigues of the period and was also concerned in the Rizzio murder. In 1582 he devised the plot to seize King James VI., known as the raid of Ruthven, and he was the last-known custodian of the famous silver casket containing the letters alleged to have been written by Mary, queen of Scots, to Bothwell. In 1581 he was created earl of Gowrie, but all his honours were forfeited when he was attainted and executed in May 1584 (see GOWRIE, 3RD EARL OF).

The 2nd Lord Ruthven left a son, Alexander (d. 1599), the founder of the family of Ruthven of Freeland, and the grandfather of Sir Thomas Ruthven (d. 1673), on whom Charles II. bestowed the title of Lord Ruthven of Freeland in 1651. When his son David died unmarried in April 1701 the title of Baroness Ruthven was assumed by the latter's sister, Jean (d. 1722), although according to some authorities the peerage had become extinct. It was, however, assumed in 1722 by Isobel (d. 1732), wife of James Johnson, who took the name of Ruthven on succeeding to the family estates; and their son, James Ruthven (d. 1783), took the title and was allowed to vote at the elections of Scots representative peers. In 1853 the barony again descended to a female, Mary Elizabeth Thornton (c. 1784-1864), the wife of Walter Hore (d. 1878). She and her husband took the name of Hore-Ruthven, and their grandson, Walter James Hore-Ruthven (b. 1838), became the 8th baron in 1864.

See the *Ruthven Correspondence*, edited with introduction by the Rev. W. D. Macray (1868); J. H. Round, "The Barony of Ruthven of Freeland" in Joseph Foster's *Collectanea Genealogica* (1881-85); and Sir R. Douglas, *The Peerage of Scotland* (new ed. by Sir J. B. Paul).

RUTILE, the most abundant of the three native forms of titanium dioxide (TiO_2); the other forms being anatase (*q.v.*) and brookite (*q.v.*). Like anatase, it crystallizes in the tetragonal system, but with different angles and cleavages, it being crystallographically related to cassiterite, with which it is isomorphous. The crystals resemble cassiterite in their prismatic habit and terminal pyramid planes (fig. 1) and also in the twinning; the prism planes are striated vertically. Geniculated twins, with ϵ (101) as twin-plane, are of frequent occurrence, and the twinning is usually several times repeated, giving rise to triplets (fig. 2), sextets and octets. Twin-lamellae are often

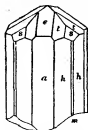

FIG. 1.

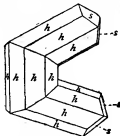

FIG. 2.

present in the crystals. Acicular crystals are sometimes twinned together to form reticulated skeletal plates to which the name "sagenite," from Gr. *σάγινη* (a net), is applied. A rarer type of twinning, on the plane (301), gives rise to heart-shaped or kite-shaped forms. There are distinct cleavages parallel to the faces of the prisms m (110) and a (100). The colour is usually reddish-brown, though yellowish in the very fine needles, and black in the ferruginous varieties ("nigrine" and "limonite-rutile"); the streak is pale brown. The name rutile, given by A. G. Werner in 1803, refers to the colour, being from the Latin *rutilus* (red). Crystals are transparent to opaque, and have a brilliant metallic-adamantine lustre. The hardness is 6½ and the specific gravity 4.2, ranging, however, up to 5.2 in varieties containing 10% of ferric oxide. The refractive indices and the positive birefringence are high.

Rutile occurs as a primary constituent in eruptive rocks, but more frequently in schistose rocks. As delicate acicular crystals it is often enclosed in mica and quartz; in mica (*q.v.*) it gives rise to the phenomenon of asterism; and clear transparent quartz (rock-crystal) enclosing rutile is often cut as a gem under the name of "Venus' hair stone" (*Veneris crinis* of Pliny). Larger crystals occur in the cavities of granite and crystalline schists; very large twinned crystals have been found at Graves Mountain in Lincoln county, Georgia, and good specimens have been obtained from several places in Norway and the Swiss and Tirolese Alps. As a secondary mineral, rutile in the form of minute needles is of wide distribution in various sedimentary rocks, especially clays and slates. As rounded grains it is often met with in auriferous sands and gravels. The mineral has little economic value: it has been used for imparting a yellow colour to glass and porcelain, and for this purpose is mined at Risør and other places in Norway. (L. J. S.)

RUTILIUS CLAUDIUS NAMATIUS, Roman poet, flourished at the beginning of the 5th century A.D. He was the author of a Latin poem, *De Reditu Svo*, in elegiac metre, describing a coast voyage from Rome to Gaul in A.D. 416. The literary excellence of the work, and the flashes of light which it throws across a momentous but dark epoch of history, combine to give it exceptional importance among the relics of late Roman literature. The poem was in two books; the exordium of the first and the greater part of the second have been lost. What remains consists of about seven hundred lines.

The author is a native of S. Gaul (Toulouse or perhaps Poitiers), and belonged, like Sidonius, to one of the great governing families of the Gaulish provinces. His father, whom he calls Lachanuis, had held high offices in Italy and at the imperial court, had been governor of Tuscia (Etruria and Umbria), then imperial treasurer (*comes sacrarum largitionum*), imperial recorder (*quaestor*), and governor of the capital itself (*praefectus urbi*). Rutilius boasts his career to have been no less distinguished than his father's, and particularly indicates that he had been secretary of state (*magister officiorum*) and governor of the capital (i. 157, 427, 467, 561). After reaching manhood, he passed through the tempestuous period between the death of Theodosius (395) and the fall of the usurper Attalus, which occurred near the date when his poem was written. He witnessed the chequered career of Stilicho as actual, though not titular, emperor of the West; he saw the hosts of Radagaisus rolled back from Italy, only to sweep over Gaul and Spain; the defeats and triumphs of Alaric; the three sieges and final sack of Rome, followed by the marvellous recovery of the city; Heraclian's vast armament dissipated; and the fall of seven pretenders to the Western diadem. Undoubtedly the sympathies of Rutilius were with those who during this period dissented from and, when they could, opposed the general tendencies of the imperial policy. We know from himself that he was the intimate of those who belonged to the circle of the great orator Symmachus—men who scouted Stilicho's compact with the Goths, and led the Roman senate to support the pretenders Eugenius and Attalus in the vain hope of reinstating the gods whom Julian had failed to save.

While making but few direct assertions about historical characters or events, the poem forces on us important conclusions concerning the politics and religion of the time. The attitude of the writer towards paganism is remarkable. The whole poem is intensely pagan, and is penetrated by the feeling that the world of literature and culture is and must remain pagan; that outside paganism lies a realm of barbarism. The poet wears an air of exalted superiority over the religious innovators of his day, and entertains a buoyant confidence that the future of the ancient gods of Rome will not belie their glorious past. Invective and apology he scorns alike, nor troubles himself to show, with Claudian, even a suppressed grief at the indignities put upon the old religion by the new. As a statesman, he is at pains to avoid offending those politic Christian senators over whom pride in their country had at least as great power as attachment to their new religion. Only once or twice does Rutilius speak directly of Christianity, and then only to attack the monks, whom the temporal authorities had hardly as yet recognized, and whom, indeed, only a short time before, a Christian emperor had forced by thousands into the ranks of his army. Judaism Rutilius could assail without wounding either pagans or Christians, but he intimates, not openly, that he hates it chiefly as the evil root whence the rank plant of Christianity had sprung.

We read in Gibbon that "Honorius excluded all persons who were adverse to the catholic church from holding any office in the state," that he "obstinately rejected the service of all those who dissented from his religion," and that "the law was applied in the utmost latitude and rigorously executed." Far different is the picture of political life impressed upon us by Rutilius. His voice is assuredly not that of a partisan of a discredited and overthrown government. We see by the title of his poem a senate at Rome composed of past office-holders, the majority of whom were certainly pagan still. We discern a Christian section whose Christianity was political rather than religious, who were Romans first and Christians afterwards, whom a new breeze in politics might easily have wafted back to the old religion. Between these two sections the broad old Roman toleration reigns. Some ecclesiastical historians have fondly imagined that after the sack of Rome the bishop Innocent returned to a position of predominance. To one who fairly reads Rutilius can cherish this idea. The air of the

capital, perhaps even of Italy, was still charged with paganism. The court was far in advance of the people, and the persecuting laws were in large part incapable of execution.

Perhaps the most interesting lines in the whole poem are those in which Rutilius assails the memory of "dire Stilicho," as he names him. Stilicho, fearing to suffer all that had caused himself to be feared of annihilated those defenders of Alps and Apennines which the provident gods had interposed between the barbarians and the Eternal City, and planted the cruel Goths, his "skien-clad" minions, in the very sanctuary of the empire. His wife was wickeder than the wife of the Trojan horse, than the wife of Althaea or of Scylla. May Nero rest from all the torments of the damned, that they may seize on Stilicho; for Nero smote his own mother, but Stilicho the mother of the world!

We shall not err in supposing that we have here (what we find nowhere else) an authentic expression of the feeling entertained by a majority of the Roman senate concerning Stilicho. He had but imitated the policy of Theodosius with regard to the barbarians; but even that great emperor had met with passive opposition from the old Roman families. The relations, however, between Alaric and Stilicho had been closer and more mysterious than those between Alaric and Theodosius, and men who had seen Stilicho surrounded by his body-guard of Goths not unaturally looked on the Goths who assailed Rome as Stilicho's avengers. It is noteworthy that the name of Stilicho is never in the poem in terms far different from those used by Orosius and the historians of the lower empire. They believed that Stilicho was plotting to make his son emperor, and that he called in the Goths in order to climb higher. Rutilius holds that he used the barbarians merely to save himself from impending ruin. The Christian historians assert that Stilicho designed to restore paganism. To Rutilius he is the most uncompromising foe of paganism. His crowning sin (recorded by the poet alone) was the destruction of the Sibylline books—a sin worthy of one who had denied his wife in the spoils of Victory, the goddess who had for centuries presided over the deliberations of the senate. This crime of Stilicho alone is sufficient in the eyes of Rutilius to account for the disasters that afterwards befell the city, just as Merobaudes, a generation or two later, traced the miseries of his own day to the overthrow of the ancient rites of Vesta.

With regard to the form of the poem, Rutilius handles the elegiac couplet with great metrical purity and freedom, and betrays many signs of long study in the elegiac poetry of the Augustan era. The Latin is unusually clean and clear, and generally fairly classical both in vocabulary and construction. The taste of Rutilius, too, is comparatively pure. If he lacks the genius of Claudian, he also lacks his overladen gaudiness and his large exaggeration, and the directness of Rutilius shines by comparison with the laboured complexity of Ausonius. It is common to call Claudian the last of the Roman poets. That title might fairly be claimed for Rutilius, unless it be reserved for Merobaudes. At any rate, in passing from Rutilius to Sidonius no reader can fail to feel that he has left the region of Latin poetry for the region of Latin verse.

Of the many interesting details of the poem we can only mention a few. At the outset we have an almost dithyrambic address to the goddess Roma, whose glory has ever shone the brighter for disaster, and who will rise once more in her might and confound her barbarian foes. The poet shows as deep a consciousness as any modern historian that the grandest achievement of Rome was the spread of law. Next we get an indignant but not unimportant reference to the destruction of roads and property wrought by the Goths, to the state of the havens at the mouths of the Tiber, and the general decay of nearly all the old commercial ports on the coast. Most of these were as desolate then as now. Rutilius even exaggerates the desolation of the once important city of Cosa in Etruria, whose walls have scarcely changed from that day to ours. The port that served Pisa, almost alone of all those visited by Rutilius, seems to have retained its prosperity, and to have fared somewhat the subsequent greatness of the city. It is one of the most beautiful cities in Italy, and was "soothing their worried hearts with holy merriment," and were celebrating the festival of Osiris.

AUTHORITIES.—All existing MSS. of Rutilius are later than 1494, and are copies from a lost copy of an ancient MS. once at the monastery of Bobbio, which disappeared about 1700. The *editio princeps* is that by J. B. Pius (Bologna, 1520) and the principal editions since have been those by Barth (1623), P. Burman (1731, in his edition of the minor Latin poets), Wernsdorf (1778, part of a similar collection), Zang (1849), and the critical edition by Müller (1904); also an annotated edition by Keene, with a translation by G. F. Savage-Armstrong (1906). Müller writes the poet's name as Claudius Rutilius Namatianus, instead of the usual Rutilius Claudius Namatianus; but if the identification of the poet's father with the Claudius mentioned in the Theodosian Code (2, 4, 5) be correct, Müller is probably wrong. Rutilius receives more or less attention from all writers on the history or literature of the times, but a lucky opportunity is given to the critic-editor of the *Paganisme Occidentale* (1835), which may be especially mentioned, and one in Pichon's *Derniers écrivains profanes* (1906). (J. S. R.)

RUTILIUS RUFUS, PUBLIUS, Roman statesman, orator and historian, born c. 158 B.C. He was on intimate terms with the younger Scipio, under whom he served in the Numantine War (134), and he also accompanied Q. Metellus Numidicus in the campaign against Jugurtha (109). In 105 he was elected to the consulship, and restored the discipline of the army and introduced an improved system of drill. Subsequently, he went as legate to Q. Mucius Scaevola, governor of Asia. By assisting his superior in his efforts to protect the provincials from the extortions of the *publicani*, or farmers of taxes, Rufus incurred the hatred of the equestrian order, to which the *publicani* belonged. In 92 he was charged with the very offence of extortion which he had done his utmost to prevent. The charge was absurd, but as the juries at that time were chosen from the equites, his condemnation was only to be expected. Rufus accepted the verdict with the resignation befitting a Stoic and pupil of Panaetius. He retired to Mytilene, and afterwards to Smyrna, where he spent the rest of his life, and where Cicero saw him as late as the year 78. Although invited by Sulla to return to Rome, Rufus refused to do so. It was doubtless during his stay at Smyrna that he wrote his autobiography and a history of Rome in Greek, part of which is known to have been devoted to the Numantine War. He possessed a thorough knowledge of law, and wrote treatises on that subject, some fragments of which are quoted in the Digests. He was also well acquainted with Greek literature.

See Cicero, *Pro Fonteio*, 17, *Brutus*, 22, 30; Livy, *epit.* 70; Macrobius, *Sat.* i. xvi. 34; Appian, *Hisp.* 88; Athenaeus iv. p. 168; W. H. Suringar, *De Romanis Autobiographis* (Leiden, 1846); H. Peter, *Hist. Rom. Reliquae*, i. cclxi–cclxviii. (life), frags. p. 187; A. H. J. Greenidge, *Hist. of Rome*, i. p. 484.

RUTLAND, EARLS AND DUKES OF. The 1st earl of Rutland was Edward Plantagenet (1373–1415), son of Edmund, duke of York, and grandson of King Edward III. In 1390 he was created earl of Rutland, but was to hold the title only during the lifetime of his father, on whose death in 1402 the earldom accordingly became extinct, the earl then becoming duke of York. The title earl of Rutland seems to have been assumed subsequently by different members of the house of York, though it does not appear that any of them had a legal right to it. One of these was the 1st earl's nephew, Richard Plantagenet, duke of York, father of King Edward IV. Richard's daughter Anne married for her second husband Sir Thomas St Leger, and their daughter Anne married George Manners, 12th Baron Ros, or Roos (d. 1513). Their son, Thomas Manners (d. 1543), was therefore great-grandson of Richard Plantagenet, who had styled himself earl of Rutland among other titles. In 1525 Thomas Manners was created earl of Rutland, and his descendants have held this title to the present day.

Thomas was a favourite of Henry VIII., who conferred on him many offices and extensive grants of land, including Belvoir Castle, in Leicestershire, which became henceforth the chief residence of his family. He was succeeded in the earldom by his son Henry (c. 1516–1563); and his second son, Sir John Manners, acquired Haddon Hall, Derbyshire, by his marriage with Dorothy, daughter of Sir George Vernon, called "the king of the Peak." Henry, the 2nd earl, was an admiral of the fleet in the reign of Queen Mary, and later enjoyed the favour of Queen Elizabeth. His son Edward, 3rd earl (c. 1548–1587), who was also a favourite with Elizabeth, left no sons, and the barony of Ros, which had hitherto descended with the earldom, passed to his daughter Elizabeth (d. 1591), wife of William Cecil, earl of Exeter; his successor in the earldom was his brother John (d. 1588), whose son Roger, 5th earl (1576–1612), married a daughter of Sir Philip Sidney. The barony of Ros was restored to the main line of the family in the person of Francis, 6th earl (1578–1632), who inherited it in 1618 as heir general of his cousin William Cecil, Lord Ros (1590–1618); but it was again separated from the earldom of Rutland on the death of Francis without male issue, and the assumption of the courtesy title of Lord Ros by the eldest son of subsequent earls of Rutland appears to have had no legal basis.

The 8th earl, a cousin of his predecessor and also of the 6th earl, was John (1604–1679), eldest son of Sir George Manners (d. 1623) of Haddon, a descendant of Sir John Manners, the second son of the 1st earl. His son John, 9th earl (1638–1711), a partisan of the revolution of 1688, received the Princess Anne at Belvoir Castle on her flight from London; after the accession of Anne to the throne she created him marquis of Granby and duke of Rutland in 1703. The 1st duke was three times married; the divorce in 1670, while he was still known as Lord Ros, of his first wife, Anne, daughter of the marquis of Dorchester, was a very celebrated legal case, being the first instance of divorce *a vinculo* by act of parliament, a divorce *a mensa et thoro* having previously been granted by the ecclesiastical courts. His grandson John, the 3rd duke (1696–1770), was the father of John Manners, marquis of Granby (a.n.), a distinguished soldier, whose son Charles, 4th duke of Rutland (1754–1787), succeeded his grandfather. When marquis of Granby he represented Cambridge University in the House of Commons, and hotly opposed the policy that led to war with the American colonies. He was instrumental in procuring the entrance of the younger Pitt to the House of Commons, and remained through life an intimate friend of that statesman. After succeeding to the dukedom in 1770, he sat in the cabinets of Shelburne and of Pitt, and became lord lieutenant of Ireland in 1784. He was one of the earliest to advocate a legislative union between Ireland and Great Britain, which he recommended in a letter to Pitt in June 1784. The poet Crabbe was for some time private chaplain to the duke at Belvoir. His wife, Mary Isabella (1756–1831), "the beautiful duchess," whose portrait was four times painted by Sir Joshua Reynolds, was a daughter of the 4th duke of Beaufort. His eldest son, John Henry, 5th duke (1778–1857), was "the duke" in Disraeli's *Coningsby*; the latter's two sons, the marquis of Granby and Lord John Manners, figuring in the same novel as "the marquis of Beaumont" and "Lord Henry Sidney" respectively. Both these sons succeeded in turn to the dukedom, Lord John Manners succeeding his brother Charles Cecil John, the 6th duke (1815–1888), as 7th duke of Rutland (see below) in 1888. In 1801 he was made a knight of the Garter, being the tenth earl and the sixth duke of Rutland of the same creation to wear this illustrious order.

RUTLAND, JOHN JAMES ROBERT MANNERS, 7TH DUKE OF (1818–1906), English statesman, was born at Belvoir Castle on the 13th of December 1818, being the younger son of the 5th duke of Rutland by Lady Elizabeth Howard, daughter of Byron's guardian, the 5th earl of Carlisle. Lord John Manners, as he then was, was educated at Eton and Trinity College, Cambridge. In 1841 he was returned for Newark in the Tory interest, along with W. E. Gladstone, and sat for that borough until 1847. Subsequently he sat for Colchester, 1850–57; for North Leicestershire, 1857–85; and for East Leicestershire from 1885 until in 1888 he took his seat in the House of Lords upon succeeding to the dukedom.

Melbourne's Whig government had been doomed for some time before it went out in June 1841. The Tories came in with a large majority under Peel, and among Manners's friends who were successful in the constituencies, besides Gladstone, were Smythe, afterwards 7th Viscount Strangford, at Canterbury; Baillie-Cochrane, afterwards 1st Lord Lamington, at Bridport; and Disraeli at Shrewsbury. Cherishing many of the ideas of the cavaliers of the 17th century, and full of political and literary ardour, Lord John was soon prominent in the social group which revolved round Lady Blessington. In 1841 he committed some of his loyalist and other fancies to a volume called *England's Trusts, and other Poems*, which he dedicated to his friend Smythe, and in which occurred the familiar line about "laws and learning" and "our old nobility." Before the end of this year Manners had definitely associated himself with the "Young England" party, under the leadership of Disraeli. This party sought to extinguish the predominance of the middle-class *bourgeoisie*, and to re-create the political prestige of the aristocracy by resolutely proving its capacity to ameliorate the social, intellectual, and material condition of

the peasantry and the labouring classes. At the same time its members looked for a regeneration of the Church, and the rescue of both the Church and Ireland from the trammels inherited from the Whig predominance of the 18th century. Manners made an extensive tour of inspection in the industrial parts of N. England, in the course of which he and his friend Smyth expounded their views with a brilliancy which frequently extorted compliments from the leaders of the Manchester school. In 1843 he supported Lord Grey's motion for an inquiry into the condition of England, the serious disaffection of the working classes of the north being a subject to which he was constantly drawing the attention of parliament. Among other measures that he urged were the disestablishment of the Irish Church, the modification of the Mortmain Acts, and the resumption of regular diplomatic relations with the Vatican. In the same year he issued in pamphlet form a strong *Plea for National Holydays*. In 1844 Lord John vigorously supported the Ten-hours Bill, which, though strongly opposed by Bright, Cobden, and other members of the Manchester school, was ultimately passed in May 1847. In October during that year he took part in, and spoke at, the brilliant *sorée* held at the Manchester Athenaeum under the presidency of Disraeli. A few days later he and his friends attended a festival at Bingley, in Yorkshire, to celebrate the allotment of land for gardens to working men, a step which, through the agency of his father, he had done a great deal to further. About the same time Smyth dedicated to him his *Historic Fancies* as to "the Sir Philip Sidney of our generation." Manners figured as Lord Henry Sidney in Disraeli's *Coningsby*, and not a few of his ideas are represented as those of Egremont in *Sybil* and Waldershare in *Endymion*. But the disruption of the Young England party was already impending. Lord John's support to Peel's decision to increase the Maynooth grant in 1845 led to a difference with Disraeli. Divergences of opinion with regard to Newman's secession from the English Church produced further defections in the ranks, and the rupture was completed by Smyth acquiescing in Peel's conversion to Free Trade. Lord John produced another volume of verse, known as *English Ballads*, chiefly patriotic and historical, in 1850. In the same year he wrote the letterpress for an atlas of coloured views by J. C. Schetky; and he published several pamphlets, one on the *Church of England in the Colonies*, in 1851. During the three short administrations of Lord Derby (1851, 1858, and 1866) he sat in the cabinet as first commissioner of the office of works. On the return of the Conservatives to power in 1874 he became postmaster-general in Disraeli's administration, and was made G.C.B. on his retirement in 1880. He was again postmaster-general in Lord Salisbury's administration, 1885-86, and was head of the department when sixpenny telegrams were introduced. Finally, in the Conservative government of 1886-92 he was chancellor of the duchy of Lancaster. He had succeeded to the dukedom of Rutland in March 1888, upon the death of his elder brother. He died on the 4th of August 1906 at Belvoir Castle.

He was succeeded as 8th duke by his eldest son (b. 1852), who had been Conservative M.P. for the Melton division of Leicestershire from 1888 to 1895; and whose wife, as marchioness of Granby, became well known as a clever artist, a volume of her *Portraits* of various distinguished men and women being published in 1899.

RUTLAND, a midland county of England, bounded N. and E. by Lincolnshire, N. and W. by Leicestershire, and S.E. by Northamptonshire. It is the smallest county in England, having an area of 152 sq. m. The surface is pleasantly undulating, ridges of high ground running E. and W., separated by rich valleys. The principal of these valleys is the vale of Catmose, in the Oakham district, to the N. of which rises a tableland commanding wide views into Leicestershire. The vale maintains its reputation for richness of soil assigned to it by Drayton in his *Poly-Olbion*. This, the N.W. part of the county, is also the district of the well-known Cottesmore hunt.

The royal forest of Lyfield, or Leafield, which included the greater part of the hundreds of Oakham and Martinsley, once extended over the county between Oakham and Uppingham, and patches of it still exist. To the S. of Uppingham it was known as Beaumont Chase. The river Welland, flowing N.E., forms the S.E. boundary of Rutland with Northamptonshire. The Gwash, or Wash, which rises in Leicestershire, flows eastward through the centre of the county, and just beyond its borders in Lincolnshire joins the Welland. The Chater, also rising in Leicestershire and flowing E., enters the Welland about 2 m. from Stamford. The Eye, forming part of the S.W. boundary, is also tributary to the Welland.

Geology.—The county consists entirely of Jurassic formations, viz. of Liassic and Oolitic strata—the harder beds, chiefly limestone containing iron, forming the hills and escarpments, and the claybeds the slopes of the valleys. The oldest rocks are those belonging to the Lower Lias in the N.W. The bottom of the vale of Catmose is formed of marlstone rocks belonging to the Middle Lias, and its sides are composed of lower slopes of Upper Lias clay. The Upper Lias also covers a large area in the W. of the county, and is worked for bricks at Luffenham and Seaton. The lowest of the Oolitic formations is the Northampton sand, which has yielded iron ore at Manton and Cottesmore. The Lincolnshire Oolitic limestone prevails in the E. of the county N. of Stamford. It is largely quarried for building purposes, the quarries at Ketton, Clipsham, and Casterton being famous beyond the boundaries of the county. The Great Oolite and Estuarine beds prevail towards the S.E. Glacial deposits of boulder clay, sand and gravel, mask the older strata in many places.

Industries.—In the E. and S.E. districts the soil is light and shallow. In the other districts it consists chiefly of a tenacious but fertile loam, and in the vale of Catmose the soil is either clay or loam, or a mixture of the two. The prevailing redness, which colours even the streams, is owing to the ferruginous limestone carried down from the slopes of the hills. The name of the county is by some authorities derived from this characteristic of the soil, but the explanation is doubtful. The E. of the county is chiefly under tillage and the W. in grass. Nearly nine-tenths of the total area (a high proportion) is under cultivation, wheat being by far the most important grain crop. Turnips and swedes occupy the greater part of the area under green crops. The rearing of sheep (Leicesters and South Downs) and cattle (Shorthorns) occupies the chief attention of the farmer. Large quantities of these are manufactured and sold as Stilton. Agriculture is practically the only industry of importance, but there is some quarrying and boot-making.

The main line of the Great Northern railway intersects the N.E. corner, and branches of that system, of the London & North-Western, and of the Midland railways, serve the remainder of the county.

Population and Administration.—The area of the ancient and administrative county is 97,273 acres, with a population in 1891 of 20,652, and in 1901 of 19,709. The county contains five hundreds. There are no municipal boroughs or urban districts. The county town is Oakham (pop. 3294), and other towns are Uppingham (2588) and Ketton (1041). The county is in the midland circuit, and assizes are held at Oakham. It has one court of quarter sessions, but is not divided for petty-sessional purposes. There are 58 civil parishes. The county is in the diocese of Peterborough, and contains 42 ecclesiastical parishes or districts, wholly or in part. It returns one member to parliament.

History.—The district which is now Rutland was probably occupied by a tribe of Middle Angles in the 6th or 7th century, and was subsequently absorbed in the kingdom of Mercia. Although mentioned by name in the will of Edward the Confessor, who bequeathed it to his queen Edith for life with remainder to Westminster Abbey, Rutland did not rank as a county at the time of the Domesday Survey, in which the term Rutland is only applied to that portion assessed under Nottinghamshire, while the S.E. portion of the modern county is surveyed under Northamptonshire, where it appears as the wapentake of Wiceslea. Rutland is first mentioned as a distinct county under the administration of a separate sheriff in the pipe roll of 1150, but as late as the 14th century it is designated "Rutland Soke" in the *Vision of Piers Plowman*, and the curious connexion with Nottinghamshire, a county which does not adjoin it at any point, was maintained up to the reign of Henry III., when the sheriff of Nottingham was by statute appointed also escheator in Rutland. Of the five modern hundreds of Rutland, Alstoe and Martinsley appear in the Domesday Survey of Nottinghamshire as wapentakes, Martinsley at that date including the modern hundred of Oakham Soke; East hundred

and Wrangdike hundred are mentioned in the middle of the 12th century, the latter formerly including the additional hundred of Little Casterton. The shire-court for Rutland was held at Oakham.

Rutland was originally included in the diocese of Lincoln, and in 1291 formed a rural deanery within the archdeaconry of Northampton; but on the erection of Peterborough to an episcopal see by Henry VIII. in 1541, the archdeaconry of Northampton, with the deanery of Rutland, was transferred to that diocese. In 1879 the deanery of Rutland was subdivided into three portions, and in 1876 it was placed within the newly-founded archdeaconry of Oakham.

Among the most conspicuous of the Norman lords connected with this county was Walkelin de Ferrers, who founded Oakham Castle in the 12th century. The castle was subsequently bestowed by Richard II., together with the earldom of Rutland (see above), on Edward, son of Edmund, duke of York. Essendine (Essenden or Essingdon) was purchased in 1545 by Richard Cecil of Burleigh, and the title of baron of Essenden bestowed on his grandson is retained by the earls of Salisbury. Sir Everard Digby, one of the conspirators in the Gunpowder plot, belonged to the family of Digby, of Stoke Dry. Burley-on-the-hill was held by Henry Despenser, the warlike bishop of Norwich, in the reign of Richard II., and was purchased by George Villiers, duke of Buckingham, who entertained James I. there with Ben Jonson's *Mask of the Gypsies*.

The battle of Stamford was fought at Horn, near Exton; in March 1470 between Edward IV. and the Lancastrians, when from the precipitate flight of the latter the engagement became known as Losecoat Field. On the outbreak of the Civil War Rutland displayed a strong puritanical and anti-royalist sentiment, and in 1642 the sheriff and a large number of the gentry and nobility of the county forwarded a petition to the House of Lords begging that the county might be placed in a state of defence, and that the votes of papists and prelates might be disallowed; and again, in 1648, a memorial addressed to Lord Fairfax protested against the design of the parliament to treat with Charles.

Rutland has always been mainly an agricultural county. The Domesday Survey mentions numerous mills in Rutland, and a fishery at Ayston rendered 325 eels. In the 14th century the county exported wool. Stilton cheese has long been made in Leyfield Forest and the vale of Catmose, and limestone is dug in many parts of the county. The development of the economic resources of Rutland was helped in 1793 by the extension of the Melton Mowbray canal to Oakham.

Two members were returned to parliament for the county of Rutland from 1295 until under the Redistribution of Seats Act of 1885 the representation was reduced to one member.

The only old castle of which there are important remains is Oakham, dating from the time of Henry II. and remarkable for its Norman hall. Of Essendine Castle only the moat remains. The Bede-house at Liddington dates from the end of the 14th century. Hambleton Hall, now a farm-house, is a good specimen of Jacobean architecture. Many old houses of the 17th and 18th centuries are to be met with in the villages. An interesting feature of the ecclesiastical architecture of the county is the frequent continuation of the round-headed arch after the Early English style had become fully developed; as, for instance, in the Early English churches at Great Casterton, Stretton, Empingham, Clipham (Early English and Decorated), and St Peter's, Preston, where the nave arcade is Norman on one side and Early English on the other, but yet retains round-headed arches on both sides. Tickencote church is a remarkable specimen of late Norman work, with one of the finest chancel-arches extant in this style. Ketton church is transitional Norman, Early English, and early Decorated, the broach spire being of later date. St Mary's, Greetham, is a good example of Decorated, with fine tower and spire.

See *Victoria County History, Rutland*; James Wright, *History and Antiquities of the County of Rutland* (London, 1684); T. Blore, *History and Antiquities of the County of Rutland*, vol. i. pt. 2 (containing the East hundred and including the hundred of Casterton Parva; Stamford, 1811); C. G. Smith, *A Translation of that portion of Domesday Book which relates to Lincolnshire and Rutland* (London, 1870).

RUTLAND, a city and the county seat of Rutland county, Vermont, U.S.A., on Otter creek, about 67 m. S. by E. of

Burlington. Pop. (1900) 11,490, of whom 1533 were foreign-born; (1910 census) 13,546. Area, 8½ sq. m. It is served by the Delaware & Hudson (being a terminus of one of its branches) and the Rutland (New York Central system) railways. It is pleasantly situated within sight of the Green Mountains. Among its public buildings and institutions are the United States Government Building, the State House of Correction, the Rutland Free Library (1886, with 17,500 volumes in 1908), the H. H. Baxter Memorial Library, a Memorial Hall, the County Court House, the City Hall, and the City Hospital. The famous Rutland marble is quarried in W. Rutland (pop. in 1910, 3427 and Proctor (pop. in 1910, 2871), which were parts of the township of Rutland until 1886. In 1905 the value of the city's factory products was \$2,522,856 (28.8% more than in 1900). The township of Rutland was granted by New Hampshire in 1761 to John Murray of Rutland, Massachusetts, and about the same time it was granted (as Fairfield) by New York. No settlement was made until 1770, and in 1772 the place was again granted by New York under the name of Socialborough. From 1784 to 1804 Rutland was one of the capitals of Vermont, and the Capitol, built in 1784, is the second oldest building in the state. The *Rutland Herald*, one of the oldest newspapers in Vermont still published, was established as a Federalist weekly in 1794—a daily edition first appeared in 1861, and is now Republican. In 1847 the village of Rutland was incorporated, and in 1892 a portion of the township including the village was chartered as a city.

RUTLEDGE, JOHN (1739-1800), American jurist and politician, was born in Charleston, South Carolina, in 1739. He studied law in London and began to practise in Charleston in 1761. He was a delegate to the Stamp Act Congress in 1765, and to the Continental Congress in 1774-77 and 1782-83; he was chairman of the committee which framed the state constitution of 1776, and the first "president" (governor) of South Carolina in 1776-78. Disapproving of certain changes in the constitution, he resigned in 1778, but was elected governor in the following year, and served until 1782. From 1784 to 1789 he was a member of the state court of chancery. In the Constitutional Convention of 1787 he urged that the president and the Federal judges should be chosen by the national legislature; and preferably by the Senate alone, and that the president should be chosen for a term of seven years, and should be ineligible to succeed himself. Rutledge championed the Constitution in the South Carolina convention by which that instrument was adopted on behalf of the state. He was associate justice of the United States Supreme Court in 1789-91, and chief justice of the supreme court of South Carolina in 1791-95. Nominated chief justice of the Supreme Court of the United States in 1795, he presided during the August term, but the Senate refused to confirm the nomination, apparently because of his opposition to the Jay Treaty. His mind failed late in 1795, and he died in Charleston on the 23rd of July 1800.

His brother, **EDWARD RUTLEDGE** (1749-1800), a signer of the Declaration of Independence, was born in Charleston on the 23rd of November 1749. He studied law in his brother's office, and in London in 1769-73, and began to practise in Charleston in 1773. He served in the Continental Congress in 1774-77, and was sent with John Adams and Benjamin Franklin to confer on terms of peace with Lord Howe on Staten Island in September 1776. As captain of artillery and later as lieutenant-colonel he served against the British in South Carolina in 1779-80, but he was captured near Charleston in 1780, and was imprisoned at St. Augustine, Florida, for a year. He was a member of the state legislature from 1782 to 1798, and in 1791 drafted the act which abolished primogeniture in South Carolina. From 1798 until his death in Charleston, on the 23rd of January 1800, he was governor of South Carolina.

RUTLEY, FRANK (1824-1904), English geologist and petrographer, was born at Dover on the 14th of May 1824. He was educated partly at Bonn, but his interest in geology was kindled at the Royal School of Mines, where he studied from 1862-64; he then joined the army, and served as lieutenant until 1867,

when he became an Assistant Geologist on the Geological Survey. Working then in the Lake district, he began to make a special study of rocks and rock-forming minerals, and soon qualified as acting petrographer on the Geological Survey. For several years he worked in this capacity at the Museum in Jermyn Street: he described the volcanic rocks of E. Somerset and the Bristol district in 1876, and wrote special memoirs on *The Eruptive Rocks of Brent Tor* (1878), and on *The Felsitic Lavas of England and Wales* (1885). He was the author of an exceedingly useful little book on *Mineralogy* (1874; 12th ed., 1900); also of *The Study of Rocks* (1879; 2nd ed., 1881), *Rock-forming Minerals* (1888), and *Granites and Greenstones* (1894); and of a number of petrographical papers, dealing with perlitic and spherulitic structures, with the rocks of the Malvern Hills, &c. In 1882 he was appointed lecturer on Mineralogy in the Royal College of Science, and held this post until ill-health compelled him to retire in 1898. He died in London on the 16th of May 1904.

Obituary (by H. B. Woodward), with bibliography, in *Geol. Mag.* (July 1904).

RUTULI, a people of ancient Italy inhabiting Ardea and the district round it on the coast of Latium, at no great distance from Aricia, and just W. of the territory of the Volsci. They are ranked by the form of their name with the Siculi and Appuli (Apuli), probably also with the Itali, whose real Italic name would probably have been Vituli (see ITALY). This suggests that they belong to a fairly early stratum of the Indo-European population of Italy. The same is suggested by the tradition adopted or moulded by Virgil, by which the leader of the people of the soil in their resistance to the settlement of Aeneas was the Rutulian prince Turnus, a name which, if any conjecture could be founded on it, might be held to point rather to Etruria than to any pure Italic source; he is represented as the *hospes* of the exiled Etruscan king Mezentius, and as taking up arms to defend him against his angry subjects. Pliny (iii. § 6) classes them, with the Siculi, among the primitive tribes that at one time or another inhabited part of Latium, and it is to be observed that they are not included in the thirty Latin communities who once took part in the Latin Festival on the Alban Mount (see further SICULI). (R. S. C.)

RUWIGNY, HENRI DE MASSUE, MARQUIS DE, afterwards EARL OF GALWAY (1648–1720), was born at Paris on the 9th of April 1648, and was the son of the 1st Marquis de Ruwigny, a distinguished French diplomatist, and a relative of Rachel, the wife of Lord William Russell. He saw service under Turenne, who thought very highly of him. Probably on account of his English connexions he was selected in 1678 by Louis XIV. to carry out the secret negotiations for a compact with Charles II., a difficult mission which he executed with great skill. Succeeding his father as “general of the Huguenots,” he refused Louis’s offer, at the revocation of the Edict of Nantes, to retain him in that office, and in 1690, having gone into exile with his fellow Huguenots, he entered the service of William III. of England as a major-general, forfeiting thereby his French estates. In July 1691 he distinguished himself at the battle of Aughrim, and in 1692 he was for a time commander-in-chief in Ireland. In November of that year he was created Viscount Galway and Baron Portarlington, and received a large grant of forfeited estates in Ireland. In 1693 he fought at Neerwinden and was wounded, and in 1694, with the rank of lieutenant-general, he was sent to command a force in English pay which was to assist the duke of Savoy against the French, and at the same time to relieve the distressed Vaudois. But in 1695 the duke changed sides, the Italian peninsula was neutralized, and Galway’s force was withdrawn to the Netherlands. From 1697 to 1701, a critical period of Irish history, the Earl of Galway (he was advanced to that rank in 1697) was practically in control of Irish affairs as lord justice of Ireland. After some years spent in retirement, he was appointed in 1704 to command the allied forces in Portugal, a post which he sustained with honour and success until the battle of Almanza in 1707, in which Galway, in spite of care and skill on his own part, was

decisively defeated. But he scraped together a fresh army, and, although infirm, was reappointed to his command by the home government. After taking part in one more campaign, and distinguishing himself by his personal bravery in action, he retired from active life. His last service was rendered in 1715, when he was sent as one of the lords justices to Ireland during the Jacobite insurrection. As most of his property in Ireland had been restored to its former owners, and all his French estates had long before been forfeited, parliament voted him pensions amounting to £1500 a year. He died unmarried on the 3rd of September 1720. The English peerage died with him, but not the French marquisate.¹

RUVO, a town and episcopal see of Apulia, Italy, in the province of Bari, 21 m. W. of the city of that name by steam tramway, 853 ft. above sea-level. Pop. (1901) 25,245. The cathedral, a basilica with a very lofty nave (so high, indeed, that the gable of the façade is only slightly above the steep sloping roofs of the aisles, and the clerestory is very small), and with two aisles, has three apses, a square campanile and a rich façade with three portals. It belongs probably to the 13th century. The interior has a fine triforium; it contains some interesting frescoes of the 15th century, and is unique in Apulia in having a gallery supported by corbels round the nave (see A. Avena, *Monumenti dell’Italia Meridionale*, Rome, 1902, 117). S. Giovanni Rotondo is an ancient circular baptistry with two large fonts. In the Palazzo Jatta is a famous and beautiful collection of vases and coins found in the Apulian tombs around the city; part of these, however, are now to be found in the museum at Naples. The Palazzo Spinola has an interesting Renaissance court. Ruvo occupies the site of the ancient Rubi, on the Via Trajana (see APPAIA, VIA). Coins were issued by the city before it became Roman. (T. AS.)

RUWENZORI, more correctly Rungoro, said to be known also as Kokora, a mountain range in Central Africa, lying just north of the equator, and intersected near its eastern edge by 30° E. It has a length of about 65 m., with a maximum breadth of about 30 m., and its highest peaks rise above the limits of perpetual snow. The range as a whole, the major axis of which runs a little east of north, falls steeply on the west to the Central African rift-valley traversed by the Semliki, the western head-stream of the Nile, while on the east the fall is somewhat more gradual towards the highlands of western Uganda. The upper parts are separated by fairly low passes into six groups of snowy summits, lying a little to the west of the central line, rising in each case more than 15,000 ft. above the sea and reaching, in the culminating point of the western group (Mount Stanley), about 16,800 ft.

The origin of the range seems connected with that of the rift-valley on the west, both being due to vertical displacements of the earth’s crust. Ruwenzori has been formed by an upheaval *en masse* of a portion of the archæan floor of the continent, bounded east and west by lines of fracture, but resulting in a general dip from west to east. A further upheaval seems to have produced an ellipsoidal anticline, causing the strata to dip outwards at a generally high angle. Traces of volcanic action are almost non-existent. Composed in its outer parts of gneisses and mica-schists offering no great resistance to denudation, in its centre the range consists of much more refractory rocks (amphibolites, diorites, diabases, &c.), to which fact, coupled with the existence of vertical fractures, the persistence and separation of the higher summits is probably due. The snow-clad area does not now extend more than ten miles in any direction, though there is abundant evidence that the glaciers were formerly far more extensive.

The upper region is almost entirely enveloped by day in thick cloud, which descends on the east to about 9000 ft., and lower still on the west. It sometimes lifts towards evening, giving a sight of the snowy peaks, but by 9 a.m. these have

¹ The later Viscounts Galway are descended from John Monckton (1605–1751), who was created viscount in 1727. His first wife’s mother, wife of the 2nd duke of Rutland, was a daughter of Lady William Russell, and thus a connexion of the Ruwignys.

once more been hidden. As a result, the climate is very humid, the rainfall being probably at least 100 in. annually, and the slopes are furrowed by numberless streams, the most important fed by the glaciers of the upper region, and afterwards flowing in deeply cut valleys between the outer spurs. From the innermost recesses between Mounts Stanley, Speke and Baker, the main branches of the Mobuku descend to the east, while the four principal streams on the west unite to form the Butagu, the drainage on both sides ultimately finding its way to the Semliki, either directly or through Lake Dweru and the Albert Edward Nyanza.

As in other ranges of Central Africa the vegetation displays well-marked zones, varying with the altitude; but owing to the lower level to which the cloud descends on the west (probably an outcome of the general climatic régime of Central Africa, as the range lies between the east African plateau and the relatively low-lying basin of the Congo), the limits of the several zones reach a lower level on the west than on the east. They have been defined as follows by Mr R. B. Wooman of the British Museum scientific expedition of 1906-7:—

Zones.	Upper Limits (East Side).
Grass	6,500 ft.
Forest	8,500 "
Bamboos	10,000 "
Tree heaths	12,500 "
Lobelias and Senecios	14,500 "

above which is the summit region of snow and bare rock. The boundaries between the zones are not of course hard and fast lines, but merely indicate the levels between which the respective forms are specially characteristic, though they occur also in higher or lower zones. The forest zone is perhaps the best marked, being visible from a distance as a dark ring. On the west it merges in part with the low-lying forest of the Semliki valley. Owing to the abundance of moisture, mosses, hepaticae and lichens are prevalent in several of the zones, and bogs, with *Vaccinium* and other low-growing plants, are common above the forest zone. *Helichrysums* are abundant in the zone immediately below the snow, where they form large bushes. The larger mammals are found chiefly on the lower slopes, but bushbuck, pigs, leopards, monkeys, a hyrax and a serval cat occur at higher altitudes. The birds include kites, buzzards, ravens, sun-birds, toucans, a large swift, and various warblers and other small kinds. The upper limit of human settlement, with cultivation of colocasias and beans, has been placed at 6700 ft.

Attempts have been made to identify the range with the "Mountains of the Moon" of Ptolemy and other ancient writers, the snows of which were thought to feed the Nile lakes. But in view of the extreme vagueness of the statements and the absence of all detailed knowledge of the geography, it is far more likely that the rumours of snowy mountains really referred to Mounts Kenya and Kilimanjaro, especially as they seem to have been obtained rather from the east coast than from the direction of the Nile. In modern times the existence of a snowy range in this part of Africa was first made known by Sir Henry Stanley during the Emin Pasha relief expedition of 1887-89, though hints of high mountains had been obtained by Stanley himself and by Romolo Gessi in 1876 and by others from the neighbourhood of the Albert Nyanza. Stanley named the main mass Ruwenzori, and outlying eastern peaks he called Mt. Gordon Bennett, Mt. Lawson, Mt. Edwin Arnold, &c.—the last named lying N.E. of Lake Dweru. Subsequently Stanley's own name was given to the chief summit. One of Stanley's officers, Lieut. Stairs, ascended the western slopes to over 10,000 ft. in 1889, and partial ascents were afterwards made by Dr Stuhlmann, Mr Scott Elliot, Mr J. E. Moore, Sir Harry Johnston, Mr Douglas Freshfield, and others. Early in 1906 some of the secondary ridges above the snow-line were scaled by Messrs Grauer, Tegart and Maddox, and by Dr Wollaston and other members of the British Museum expedition, while later in the year the duke of the Abruzzi led a well-equipped expedition, including various scientists, to

the upper parts of the range, and with the help of trained Alpine guides ascended not only the culminating twin summits (which he named Margharita and Alexandra after the queens of Italy and England), but all the principal snow-clad peaks. The expedition produced for the first time a detailed map of the upper region, and threw much light on the geology and natural history of the range.

AUTHORITIES.—Sir H. M. Stanley, *In Darkest Africa* (London, 1890); F. Stuhlmann, *Mit Emin Pasha ins Herz von Afrika* (Berlin, 1894); G. F. Scott-Elliott, *A Naturalist in Mid-Africa* (London, 1896); J. E. S. Moore, "Tanganyika," &c., *Geog. Jnl.* (January 1901); *To the Mountains of the Moon* (London, 1901); Sir H. H. Johnston, *The Uganda Protectorate* (London, 1902); The Duke of the Abruzzi, in *Geog. Jnl.* (February 1907); R. B. Wooman, *ibid.* (December 1907); F. de Filippi, *Ruwenzori* (London, 1908), the general account of the Abruzzi expedition, and *Il Ruwenzori. Parle Scientifica* (2 vols., Milan, 1909); A. R. F. Wollaston, *From Ruwenzori to the Congo* (London, 1908); R. G. T. Bright, "The Uganda-Congo Boundary," *Geog. Jnl.* (1909). (E. H.)

RUYSBROEK (or **RUYSBROECK**), **JAN VAN** (1293-1381), Dutch mystic, was born at Ruysbroek, near Brussels, in 1293. In 1317 he was ordained priest and became vicar of St Gudule, Brussels. When sixty years of age he withdrew with a few companions to the monastery of Groenendael, near Waterloo, giving himself to meditation and mystical writing, and to a full share of the practical tasks of the society. He was known as the "Ecstatic Teacher," and formed a link between the Friends of God and the Brothers of the Common Life, sects which helped to bring about the Reformation. Ruysbroek insisted that "the soul finds God in its own depths," and noted three stages of progress in what he called "the spiritual ladder" of Christian attainment: (1) the active life, (2) the inward life, (3) the contemplative life. He did not teach the fusion of the self in God, but held that at the summit of the ascent the soul still preserves its identity. His works, of which the most important were *De vera contemplatione* and *De septem gradibus amoris*, were published in 1848 at Hanover; also *Reflections from the Mirror of a Mystic* (1906) and *Die Zierde der geesteliken Hochzeit* (1901).

See Rufus M. Jones, *Studies in Mystical Religion*, pp. 308-14 (1909); M. Maeterlinck, *Ruysbroek and the Mystics, with selections from The Adornment of the Spiritual Marriage* (tr. by J. T. Stoddart, London, 1894); and art. **MYSTICISM**.

RUYSDAEL (or **RUISDAAL**), **JACOB VAN** (c. 1628-1682), the most celebrated of the Dutch landscapists, was born at Haarlem. He appears to have studied under his father Izaak Ruysdael, a landscape painter, though other authorities make him the pupil of Berghem and of Albert van Everdingen. The earliest date that appears on his paintings and etchings is 1645. Three years later he was admitted a member of the guild of St Luke in Haarlem; in 1659 he obtained the freedom of the city of Amsterdam, and in 1668 his name appears there as a witness to the marriage of Hobbema. During his lifetime his works were little appreciated, and he seems to have suffered from poverty. In 1681 the sect of the Mennonites, with whom he was connected, petitioned the council of Haarlem for his admission into the almshouse of the town, and there the artist died on the 14th of March 1682.

The works of Ruysdael may be studied in the Louvre and the National Gallery, London, and in the collections at the Hague, Amsterdam, Berlin, and Dresden. His favourite subjects are simple woodland scenes, similar to those of Everdingen and Hobbema. He is especially noted as a painter of trees, and his rendering of foliage, particularly of oak leafage, is characterized by the greatest spirit and precision. His views of distant cities, such as that of Haarlem in the possession of the marquess of Bute, and that of Katwijk in the Glasgow Corporation Galleries, clearly indicate the influence of Rembrandt. He frequently paints coast-scenes and sea-pieces, but it is in his rendering of lonely forest glades that we find him at his best. The subjects of certain of his mountain scenes seem to be taken from Norway, and have led to the supposition that he had travelled in that country. We have, however, no record of such a journey, and the works in question are probably merely adaptations from the landscapes of Van

Everdingen, whose manner he copied at one period. Only a single architectural subject from his brush is known—an admirable interior of the New Church, Amsterdam, in the possession of the marquess of Bute. The prevailing hue of his landscapes is a full rich green, which, however, has darkened with time, while a clear grey tone is characteristic of his seapieces. The art of Ruysdael, while it shows little of the scientific knowledge of later landscapists, is sensitive and poetic in sentiment, and direct and skilful in technique. Figures are sparingly introduced into his compositions, and such as occur are believed to be from the pencils of Adrian Vandevelde, Philip Wouwerman, and Jan Lingelbach.

Unlike the other great Dutch landscape painters, Ruysdael did not aim at a pictorial record of particular scenes, but he carefully thought out and arranged his compositions, introducing into them an infinite variety of subtle contrasts in the formation of the clouds, the plants and tree forms, and the play of light. He particularly excels in the painting of cloudy skies which are spanned dome-like over the landscape, and determine the light and shade of the objects.

Characteristic of his early period, from about 1646 to 1653, is the choice of very simple motifs and the careful and laborious study of the details of nature. The time between his departure from Haarlem and his settling in Amsterdam may have been spent in travelling and helped him to gain a broader view of nature and to widen the horizon of his art. Mr Otto Beit owns a magnificent view of the "Castle of Bentheim," dated 1654, from which it may be concluded that his wanderings extended to Germany. In his last period, from about 1675 onwards, he shows a tendency towards overcrowded compositions, and affects a darker tonality, which may partly be due to the use of thin paint on a dark ground. Towards the end, in his leaning towards the romantic mood, he preferred to draw his inspiration from other masters, instead of going to nature direct, his favourite subjects being rushing torrents and waterfalls, and ruined castles on mountain crests, which are frequently borrowed from the Swiss views by Roghman.

Ruysdael etched a few plates, which were reproduced by Amand Durand in 1878, with text by Georges Duplessis. The "Cornfield" and the "Travellers" are characterized by M. Duplessis as prints of a high order which may be regarded as the most significant expressions of landscape art in the low Countries.

RYAN, LACY (c. 1604-1760), English actor, appeared at the Haymarket about 1709. By 1718 he had joined the company at Lincoln's Inn Fields, where he shared the lead with his friend Quin. In 1732 he followed the company to Covent Garden, and there he remained until his death. Iago, Cassius, Edgar (in *King Lear*) and Macduff were among his best parts.

RYAZAN, a government of central Russia, bounded by the governments of Moscow and Tula on the W., by Vladimir on the N., and by Tambov on the E. and S., with an area of 16,250 sq. m. Ryazan is an intermediate link between the central Great Russian governments and the steppe governments of the S.E.—the wide and deep valley of the Oka being the natural boundary between the two. On the left of the Oka the surface often consists of sand, marshes and forests; while on the right the fertile black-earth prairies begin, occupying especially the districts of Ranenburg, Sapozhok and Dankov. The whole of Ryazan is a plateau about 700 ft. above the sea, but deeply cut by the river valleys and numerous ravines. Iron-ores, limestone, grindstone grits, potters' clays, and thick beds of peat are worked, besides coal. The N. belongs to the forest regions, and, notwithstanding the wholesale destruction of forests, these (chiefly coniferous) in several districts still cover one-third of the surface. In the S., where the proximity of the steppes is felt, they are much less extensive, the prevailing species being oak, birch, and other deciduous trees. Altogether forests cover about one-fifth of the total area.

The Oka is the chief river; it is navigable throughout, and receives the navigable Pronya and Pra, besides a great many smaller streams utilized for floating timber. Steamers ply on the Oka to Kasimov and Nizhny-Novgorod. The Don belongs to Ryazan in its upper course only. On the whole, the S. districts are not well watered. Small lakes are numerous in the broad depression

of the Oka and elsewhere, while extensive marshes occur in the N.E. districts; a few attempts at draining some of these beside the Oka have resulted in the reclamation of excellent pasture lands. The climate is a little warmer than at Moscow, the average temperature at the city of Ryazan being 40°; February, 3°-2; July, 67°.

The estimated population in 1906 was 2,100,000, and is nearly Great Russian throughout, containing only a trifling admixture of Tatars, Poles and Jews in towns. Some Tatars immigrated into the Kasimov region in the 15th century, and are noted for their honesty of character as well as for their agricultural prosperity. The people of the Pra river are described as Meshcheryaks, but their manners and customs do not differ from those of the Russians. The chief occupation is agriculture. Out of the total area only 8% is unfit for tillage, and between 50 and 60% is under crops; although the area under cultivation and the crops themselves are increasing, yet even here, in one of the wealthiest governments of Russia, the situation of the peasants is far from satisfactory. Live-stock breeding is rapidly falling off on account of want of pasture lands, but hay, which is abundant, especially on the rich meadow lands of the Oka, is exported. More than half of the land (52%) is owned by the village communities, 40% by private owners, 5% by the crown, and 2% by various institutions. During the last thirty years of the 19th century the nobles sold 36% (1,261,000 acres) of their lands, mainly to merchants and peasants; the latter cultivate two-thirds of the total cultivated area.

The principal crops are oats, rye and potatoes, with wheat, barley, buckwheat, flax, hemp, tobacco, hops and fruit. But the crops are insufficient for the needs of the inhabitants. Tobacco, hops, vegetables and fruit, however, are grown for export. Bee-keeping is developing and manufactures increasing, the factories being chiefly cotton and flax mills, flour mills, machine works, tanneries, soap works, boot, cement, glass and match factories, distilleries, and chemical works.

The government is divided into twelve districts, the chief towns of which are Ryazan, Dankov, Egorievsk, Kasimov, Mikhailov, Promsk, Ranenburg, Ryazak, Sapozhok, Skopin, Spask and Zaraisk. Small industries, such as boat-building, the preparation of pitch and tar, the making of wooden vessels and sledges, mat-weaving and boot-making, are carried on in the villages, especially in the N., which belongs, properly speaking, to the Vladimir industrial region. Domestic trades, such as lace-making (supported by two schools) and embroidering on leather, give occupation to 40,000 women. Trade, especially in corn and manufactured goods, is brisk, and has been stimulated by the opening of coal-mines, e.g. in the district of Skopin. Considerable efforts have been made by the local governing bodies to increase the number of schools. Most interesting archaeological finds have been made in the government, and have been placed in the new museum at the city of Ryazan.

The Slavs began to colonize the region of Ryazan as early as the 9th century, penetrating thither both from the N.W. (Great Russians) and from the Dnieper (Little Russians). As early as the 10th century the principality of Murom and Ryazan is mentioned in the chronicles. During the following centuries this principality increased both in extent and in wealth, and included parts of what are now the governments of Kaluga and Moscow. Owing to the fertility of the soil, its Russian population rapidly increased, while the Finnish tribes which formerly inhabited it migrated farther E., or became merged among the Slavs. The Mongol invasion of 1239-42 stopped all development. The principality, however, still continued to exist; its princes strongly opposed the annexation by Moscow, making alliance with the Mongols and with Lithuania, but they finally succumbed, and the principality was definitely annexed in 1517.

RYAZAN, a town of Russia, capital of the government of the same name, 124 m. by rail S.E. of Moscow, on the elevated right bank of the Trubezh, a mile above its confluence with the Oka. Pop. (1897) 44,552. A wide prairie dotted with large villages, the bottom of a former lake, spreads out from the base of the crag on which Ryazan stands, and actually has the aspect of an immense lake when it is inundated in the spring. Ryazan is the see of an archbishop of the Orthodox Greek Church. The cathedral, first built in the 17th century, was reconstructed in 1776. The Krestovozdvizhensk church contains tombs of the princes of the 15th and 16th centuries.

The capital of Ryazan principality was Ryazan—now Old Ryazan, a village close to Spask, also on the Oka. It is mentioned in annals as early as 1007, but continued to be the chief town of the principality only until the 14th century. In the 11th century one of the Kiev princes founded, on the banks

of a small lake, a fort which received the name of Pereyaslav-Ryazanskij. In 1294 (or in 1335) the bishop of Murom, compelled to leave his own town, settled in Pereyaslav-Ryazanskij. The princes of Ryazan followed his example, and by and by completely abandoned the old republican town of Ryazan. In 1300 a congress of Russian princes was held there, and in the following year the town was taken by the Moscow prince. It continued, however, to be the residence of the Ryazan princes until 1517. In 1365 and 1377 it was plundered and burned by the Tatars, but in 1460, 1513, 1521 and 1564 it was strong enough to repel them. Earthen walls with towers were erected after 1301; and in the 17th century a *kremi* or citadel still stood on the high crag above the Trubezh.

RYAZHSK, a town of Russia, in the government of Ryazan, 72 m. by rail S. of the city of Ryazan. Pop. (1897) 12,993. It is one of the chief railway junctions of Russia, where meet the lines from Moscow to S. Russia and Caucasia and from Poland to Samara and Siberia. It has become a centre for all the corn-growing regions of Russia, and is a wealthy place.

RYBINSK, or **RUBINSK**, a town of Russia, in the government of Yaroslavl, 60 m. by river N.W. of Yaroslavl. It is connected by rail (186 m.) with Bologoye, on the line between St Petersburg and Moscow. It derives its importance from its situation on the Volga, opposite the mouth of the Sheksna, which connects the Volga with the regions around Lake Ladoga. Rybinsk has also an active trade in agricultural products from the neighbouring districts. The permanent population, which was 25,223 in 1897, is increased in the summer by nearly 100,000 workers from different parts of Russia.

RYDBERG, **ABRAHAM VIKTOR** (1828-1895), Swedish author and publicist, was born in Jönköping on 18th December 1828. He was educated at the high school of Växjö, and passed on to the university of Lund in 1851. While at school he was publishing verse and prose in the periodicals; some of these early miscellanies he collected in 1894 in the volumes called *Varia*. As a student he turned to more precise labours, and devoted himself to science. He had almost determined to adopt the profession of an engineer, when he was offered in 1855 a post on the staff of one of the largest Swedish newspapers. This caused his thoughts to return to imaginative literature, and in the feuilleton of this journal (the *Göteborgs Handels-och sjöfartstidning*) that Viktor Rydberg's romances successively appeared; he was editorially connected with it until 1876. *The Freebooter on the Baltic* (1857) and *The Last of the Athenians* (1859) gave Rydberg a place in the front rank of contemporary novelists. It was a surprise to his admirers to see him presently turn to theology, but with *The Bible's Teaching about Christ* (1862), in which the aspects of modern Biblical criticism were first placed before Swedish readers, he enjoyed a vast success. He followed this up by a number of contributions to the popular philosophy of religion, all inspired by the same reverent and yet searching spirit of inquiry. The modernity of his views led to his being opposed by the orthodox clergy, but by the wider public he was greatly esteemed. Nevertheless, it is said that it was his religious criticism which so long excluded him from the Swedish Academy, since he was not elected until 1877, when he had long been the first living author of Sweden. *Roman Days* is a series of archaeological essays on Italy (1876). He collected his poems in 1882; his version of *Faust* dates from 1876. In 1884 he was appointed professor of ecclesiastical history at Stockholm. He died, after a short illness, on the 22nd of September 1895. In Viktor Rydberg Sweden possessed a writer of the first order, who carried on the tradition of Boström and Geijer in philosophy and history, and possessed in addition a glow of imagination and a marvellous charm of style. He was an idealist of the old romantic type which Sweden had known for three-quarters of a century; he was the last of that race, and perhaps, as a mere writer, the greatest. In personal character Rydberg was extremely like his writings—stately, ardent and ceremonious, with a fund of amiability which made him universally beloved. His premature death was the subject of national

mourning, and had even a historical significance, for with him the old romantic influence in Swedish literature ceased to be paramount. (E. G.)

RYDE, a municipal borough and watering-place in the Isle of Wight, England, 5 m. S.S.W. of Portsmouth. Pop. (1901) 11,043. It is beautifully situated on rising ground on the N.E. coast, overlooking Spithead. It occupies the site of a village called La Rye or La Riche, which was destroyed by the French in the reign of Edward II. About the close of the 18th century it was a small fishing hamlet, but it rapidly grew into favour as a watering-place. Ryde is connected by rail with the other towns in the island, and there is also steamboat communication with Portsmouth, Southampton, Southsea, Portsea and Stoke's Bay. The pier, built originally in 1812, but since then greatly extended, forms a delightful promenade half a mile in length. The railway trains run out to its head, and an electric tramway also runs along it. The principal buildings are All Saints church, erected in 1870 from the designs of Sir Gilbert Scott, and other churches, the market house and town hall, the Royal Victoria Yacht club-house, the theatre and the Royal Isle of Wight Infirmary. There are golf-links near the town. The town was incorporated in 1868, and is governed by a mayor, 6 aldermen and 18 councillors. Area, 819 acres.

RYDER, **ALBERT PINKHAM** (1847-), American artist, was born at New Bedford, Mass., on the 10th of March 1847. He was a pupil of William E. Marshall and of the schools of the National Academy of Design. Among his better known paintings are: "Temple of the Mind," "Jonah and the Whale," "Christ appearing unto Mary," "The Flying Dutchman," "Charity," and "The Little Maid of Arcadie." He became a member of the Society of American Artists in 1878, and a National Academician in 1906.

RYE, a market town and municipal borough in the Rye parliamentary division of Sussex, England, 11 m. N.E. by E. from Hastings, on the South-Eastern & Chatham railway. Pop. (1901) 3900. It rises on a sharp eminence above the S. of Romney Marsh, which within historic times was an inlet of the English Channel. The sea began to recede in the 16th century, and now the river Rother forms a small estuary with its mouth 2 m. from the town; this serves as a small harbour with a depth of 15 ft. at high tide, and there is some trade in coal, grain and timber. Fishing and shipbuilding are carried on, and there is a market for sheep (which are pastured in great numbers on the marshes), wool, grain and hops. The church of St Mary is of mixed architecture, chiefly Transitional, Norman and Early English; it is cruciform, with a low central tower. Of the old fortifications there remain portions of the town wall, a strong quadrangular tower built by William of Ypres, earl of Kent, and lord warden in the time of Stephen, and now forming part of the police station, and a handsome gate with a round tower on each side, known as the Land Gate, at the entrance into Rye from the London road. Picturesque old houses are numerous. In the low land S. of the town stands Camber Castle, one of the coastal defensive works of Henry VIII. In the vicinity are golf-links, to which a steam tram runs from the town. The municipal borough is under a mayor, 4 aldermen and 12 councillors. Area, 985 acres.

In the time of Edward the Confessor, Rye (Ria, Ryerot, La Ric) was a fishing village and, as part of the manor of "Rameslie," was granted by the king to the abbot and convent of Fécamp, by whom it was retained until Henry III. resumed it. By 1086 Rye was probably a port of consequence, and a charter of Richard I. shows that in the reign of Henry II., if not before, it had been added to the Cinque Ports. The fluctuations of the sea and attacks of the French caused its decline in the 13th and 14th centuries, and the walls were therefore built in the reign of Edward III. The decay of Winchelsea contributed to the partial revival of Rye in the 15th and 16th centuries, when it was a chief port of passage. Towards the end of the 16th century the decay of the port began, and notwithstanding frequent attempts to improve the harbour it never recovered its ancient prosperity. Rye was incorporated under a mayor and jurats

by the beginning of the 14th century, but possesses no charter distinct from the Cinque Ports. As a member of the Cinque Ports, which were summoned from 1322 onwards, Rye returned two representatives to parliament from 1366 until 1832; after that date one only until 1885. In 1290 the barons of the royal port of Rye were granted a three days' fair in September, altered in 1305 to March. The mayor and commonalty evidently held weekly markets on Wednesday and Friday before 1405, as in that year the Friday market was changed to Saturday. Ship-building has been carried on since the 13th century.

RYE. This cereal, known botanically as *Secale cereale*, is supposed to be the cultivated form of *S. montanum*, a wild perennial species occurring in the more elevated districts of parts of the Mediterranean region, and W. to Central Asia. Its cultivation does not appear to have been practised at a



Rye (*Secale cereale*), about $\frac{1}{4}$ nat. size.
1, single spikelet; 2, single flower with awned plume and palea; 3, pistil; 4, grain.
1, 2, 4, about two-thirds nat. size.

very early date, relatively speaking. Alphonse de Candolle, who has collected the evidence on this point, draws attention to the fact that no traces of this cereal have hitherto been found in Egyptian monuments, or in the earlier Swiss dwellings, though seeds have been found in association with weapons of the Bronze period at Olmütz. The absence of any special name for it in the Semitic, Chinese and Sanskrit languages is also adduced as an indication of its comparatively recent culture. On the other hand, the general occurrence of the name in the more modern languages of N. Europe, under various modifications, points to the cultivation of the plant then, as now, in those regions. The origin of the Latin name *secale*, which exists in a modified form among the Basques and Bretons, is not explained. Rye is a tall-growing annual grass, with fibrous roots, flat, narrow, ribbon-like bluish-green leaves, and erect or decurved cylindrical slender spikes like those of barley. The spikelets contain two or three flowers, of which the uppermost is usually imperfect. The outer glumes are acute and glabrous, the flowering glumes lance-shaped, with a comb-like keel at the back, and the outer or lower one prolonged at the apex into a very long bristly awn. Within these are three stamens surrounding a compressed ovary, with two feathery stigmas. When ripe, the grain is of an elongated oval form, with a few hairs at the summit. When the ovaries of the plant become affected with a peculiar fungus (*Claviceps purpurea*) they become blackened and distorted, constituting ergot (*g.v.*).

In the S. of Great Britain rye is chiefly or solely cultivated as a forage-plant for cattle and horses, being usually sown in autumn for spring use, after the crop of roots, turnips, &c., is exhausted, and before the clover and lucerne are ready. For forage purposes it is best to cut early, before the leaves and baulms have been exhausted of their supplies to benefit the

grain. In the N. of Europe, and more especially in Scandinavia, Russia and parts of N. Germany, rye is the principal cereal; and in nutritive value, as measured by the amount of gluten it contains, it stands next to wheat, a fact which furnishes the explanation of its culture in N. latitudes ill-suited for the growth of wheat. Rye bread or black bread is in general use in N. Europe. The straw, which is prized on account of its length, is used for making hats and in the manufacture of paper. The bran is used for cattle-food and poultices, and the grain in the distillery.

RYEZHITSA, a town of Russia, in the government of Vitebsk, 150 m. N.W. from the town of Vitebsk and on the railway between St Petersburg and Warsaw. Its population increased from 7306 in 1867 to 10,681 in 1897; but its importance is mainly historical. The cathedral is a modern building (1846). Ryezhitsa, or, as it is called in the Livonian chronicles, Roziten, was founded in 1285 by the Teutonic Knights to keep in subjection the Lithuanians and Letts. The castle was continually the object of hostile attacks. In 1561 the Teutonic Knights gave it in pawn to Poland, and, though it was captured by the Russians in 1567 and 1577, and had its fortifications dismantled by the Swedes during the war of 1656-60, it continued Polish till 1773, when White Russia was united with the Russian empire.

RYLAND, WILLIAM WYNNE (1738-1783), English engraver, was born in London in July 1738, the son of an engraver and copper-plate printer. He studied under Ravenet, and in Paris under Boucher and J. P. le Bas. After spending five years on the continent he returned to England, and having engraved portraits of George III. and Lord Bute after Ramsay, and a portrait of Queen Charlotte and the Princess Royal after Francis Cotes, R.A., he was appointed engraver to the king. In 1766 he became a member of the Incorporated Society of Artists, and he exhibited with them and in the Royal Academy. In his later life Ryland abandoned line-engraving, and introduced "chalk-engraving," in which the line is composed of stippled dots, and in which he transcribed Mortimer's "King John Signing Magna Charta," and copied the drawings of the old masters and the works of Angelica Kauffman. In consequence of his extravagant habits his affairs became involved; he was convicted of forging bills upon the East India Company, and, after attempting to commit suicide, was executed at Tyburn on the 20th of August 1783.

RYLANDS, JOHN (1801-1888), English manufacturer and merchant, was born at St Helens, Lancashire, on the 7th of February 1801, and was educated at the grammar school in that town. In 1819 he, his elder brothers and his father, a manufacturer of cotton goods, founded the firm of Rylands & Sons, cotton goods and linen manufacturers, at Wigan. The business rapidly increased, dye-works and bleach-works were added, and the discovery of coal under some of the firm's property added materially to its wealth. In 1825 the partners became merchants as well as manufacturers, and subsequently acquired spinning mills at Bolton and elsewhere. In 1847, his father being dead and his brothers having retired, John Rylands assumed entire control of the business, which in 1873 was turned into a limited liability company. It has mills at Manchester, Bolton, and Wigan, and is now probably the largest concern of the kind in Great Britain. John Rylands was a benefactor to various charities, and was one of the original financiers of the Manchester Ship Canal. He died at Stretford on the 11th of December 1888. A permanent memorial, the John Rylands Library, was erected by his widow in Manchester in 1890.

RYLE, JOHN CHARLES (1816-1900), English bishop, was born at Marclesfield on the 10th of May 1816, and was educated at Eton and at Christ Church, Oxford, where he was Craven Scholar in 1836. After holding a curacy at Exbury in Hampshire, he became rector of St Thomas's, Winchester (1843), rector of Helmingham, Suffolk (1844), vicar of Stradbroke (1861), honorary canon of Norwich (1872), and dean of Salisbury (1880); but before taking this office was advanced to the new see of Liverpool, where he remained until his resignation, which took place three months before his death at Reston on the 10th of June 1900.

Ryle was a strong supporter of the evangelical school. Among his longer works are *Christian Leaders of the Eighteenth Century* (1869), *Expository Thoughts on the Gospels* (7 vols., 1856–60), *Principles for Churchmen* (1884). His second son, HERBERT EDWARD RYLE (b. 1856), a distinguished Old Testament scholar, was made bishop of Exeter in 1901, and in 1903 bishop of Winchester.

RYLSK, a town of Russia, in the government of Kursk, 71 m. by rail W.S.W. of the town of Kursk. It is connected by a branch line with the Kursk-Kiev railway. Pop. (1897) 11,415. It has oil works, blast furnaces, and manufactories of soap and tallow, and an active trade in corn, hemp, and scythes imported from Austria. It was founded in the 9th century, and is frequently mentioned in the annals from 1152 onwards. Its cathedral was built in the 15th century.

RYMER, THOMAS (1641–1713), English historiographer royal, was the younger son of Ralph Rymer, lord of the manor of Brafferton in Yorkshire, described by Clarendon as "possessed of a good estate," and executed for his share in the "Presbyterian rising" of 1663. Thomas was probably born at Yafforth Hall early in 1641, and was educated at a private school kept at Danby-Wisike by Thomas Smelt, a noted Royalist, with whom Rymer was "a great favourite," and "well known for his great critical skill in human learning, especially in poetry and history."¹

He was admitted as *pensionarius minor* at Sidney Sussex College, Cambridge, on April 29, 1658, but left the university without taking a degree. On May 2, 1666, he became a member of Gray's Inn, and was called to the bar on June 16, 1673. His first appearance in print was as translator of *Cicero's Prince* (1668), from the Latin treatise (1608) drawn up for Prince Henry. He also translated Rapin's *Reflections on Aristotle's Treatise of Poesie* (1674), with a preface in defence of the classical rules for unity in the drama, and followed the principles there set forth in a tragedy in verse, licensed September 13, 1677, called *Edgar, or the English Monarch*, which was a failure. The printed editions of 1678, 1691 and 1693 belong to the same issue, with new title-pages. Rymer's views on the drama were again given to the world in the shape of a printed letter to Fleetwood Shephard, the friend of Prior, under the title of *The Tragedies of the Last Age Consider'd* (1678, and ed. 1692). To Ovid's *Epistles Translated by Several Hands* (1680), with preface by Dryden, "Penelope to Ulysses" was contributed by Rymer, who was also one of the "hands" who "Englished" the Plutarch of 1683–86. The life of Nicias fell to his share. He furnished a preface to Whitelocke's *Memorials of English Affairs* (1682), and wrote in 1681 *A General Draught and Prospect of the Government of Europe*, reprinted in 1689 and 1714 as *Of the Antiquity, Power, and Decay of Parliaments*, where, ignorant of his future dignity, the critic had the misfortune to observe, "You are not to expect truth from an historiographer royal." He contributed three pieces to the collection of *Poems to the Memory of Edmund Waller* (1688), afterwards reprinted in *Dryden's Miscellany Poems*, and is said to have written the Latin inscription on Waller's monument in Beaconsfield churchyard. The preface to the posthumous *Historia Ecclesiastica* (1688) of Thomas Hobbes is said to have been by Rymer, but the *Life of Hobbes* (1681) sometimes ascribed to him was written by Richard Blackburne. He produced a congratulatory poem upon the arrival of Queen Mary in 1689. His next piece of authorship was to translate the sixth elegy of the third book of Ovid's *Tristia* for *Dryden's Miscellany Poems* (1692, p. 148). On the death of Thomas Shadwell in 1692 Rymer received the appointment of historiographer royal, at a yearly salary of £200. Immediately afterwards appeared his much discussed *Short View of Tragedy* (1693), criticizing Shakespeare and Ben Jonson, which produced *The Imperial Critick* (1693) of Dennis, the epigram of Dryden,² and the judgment of Macaulay that Rymer was "the" ¹ See Hickeys, *Memoirs of John Kettlewell* (1718), pp. 10–14.

² "The corruption of a poet is the generation of a critic" (*Ded. of the Third Miscellany, in Works* (1821), xii. p. 49), which is much more pointed than Beaconsfield's reference to critics as "men who have failed in literature and art" (*Lothair*, chap. xxxv.) or Balzac's sly hit at Mérimée in similar terms. The poet's remarks on the

worst critic that ever lived." John Dunton (*Life and Letters*, p. 354), however, considered him "orthodox and modest," and Pope "one of the best critics we ever had" (*Spence's Anecdotes*). Rymer contended that although Shakespeare possessed humour he had no genius for tragedy, Othello being merely "a bloody farce without salt or savour."

Within eight months of his official appointment Rymer was directed (August 26, 1693) to carry out that great national undertaking with which his name will always be honourably connected, and of which there is reason to believe that Lords Somers and Halifax were the original promoters. The *Codex Juris Gentium Diplomaticus* (1693) of Leibnitz was taken by the editor as the model of the *Foedera*. The plan was to publish all records of alliances and other transactions in which England was concerned with foreign powers from 1101 to the time of publication, limiting the collection to original documents in the royal archives and the great national libraries. Unfortunately, this was not uniformly carried out, and the work contains some extracts from printed chronicles. From 1694 he corresponded with Leibnitz, by whom he was greatly influenced with respect to the plan and formation of the *Foedera*. While collecting materials, Rymer unwisely engraved a spurious charter of King Malcolm, acknowledging that Scotland was held in homage from Edward the Confessor. When this came to be known the Scottish antiquaries were extremely indignant. G. Redpath published a MS. on the independence of the Scottish crown, by Sir T. Craig, entitled *Scotland's Sovereignty Asserted* (1695), and the subject was referred to by Bishop Nicolson in his *Scottish Historical Library* (1702). This led Rymer to address three letters to the Bishop of Carlisle (1702–1706) explaining his action, and discussing other antiquarian matters. Sir Robert Sibbald answered the second letter (1704). The first and second letters are usually found together; the third is extremely rare. Rymer had now been for some years working with great industry, but was constantly obliged to petition the crown for money to carry on the undertaking. Up to August 1698 he had expended £1253, and had only received £500 on account.

At last, on November 20, 1704, was issued the first folio volume of the *Foedera, Conventiones, Litterae et cujuscuque generis Acta Publica inter reges Angliae et alios quosvis imperatores, reges, &c.*, ab. A.D. 1101 ad nostra usque tempora habita aut tractata. The publication proceeded with great rapidity, and fifteen volumes were brought out by Rymer in nine years. Two hundred and fifty copies were printed; but, as nearly all of them were presented to persons of distinction, the work soon became so scarce that it was priced by booksellers at one hundred guineas. A hundred and twenty sheets of the fifteenth volume and the copy for the remainder were burnt at a fire at William Bower's, the printer, on January 30, 1712–13. Rymer died shortly after the appearance of this volume, but he had prepared materials for carrying the work down to the end of the reign of James I. These were placed in the hands of Robert Sanderson, his assistant.

For the greater part of his life Rymer derived his chief subsistence from a mortgage assigned to him by his father. His miscellaneous literary work could not have been very profitable. At one time he was reduced to offer his MSS. for a new edition for sale to the earl of Oxford. About 1703 his affairs became more settled, and he afterwards regularly received his salary as historiographer, besides an additional £200 a year as editor of the *Foedera*. He died at Arundel Street, Strand, December 14, 1713, and was buried in the church of St Clement Danes. His will was dated July 10, 1713. Tomson issued an edition of *Rochester's Works* (1714), with a short preface by the late historiographer. Another posthumous publication was in a miscellaneous collection called *Curious Amusements*, by M. B. (1714), which included "some translations from Greek, Latin and Italian poets, by T. Tragedies of the Last Age have been reprinted in his *Works* (1821), xv. pp. 383–396, and in Johnson's *Life of Dryden*. See also Dryden's *Works*, i. 377, vi. 251, xi. 60, xiii. 20. "I never came across a worse critic than Thomas Rymer," says Prof. George Saintsbury, who discusses his theories at length in *History of Criticism* (1902), pp. 391–397. See also A. Hofherr, *T. Rymer's dramatische Kritik* (1908).

Rymer." Some of his poetical pieces were also inserted in J. Nichols's *Select Collection* (1780-86, 8 vols.), and two are reproduced in A. H. Bullen's *Musa Proterva* (1895).

Two more volumes of the *Foedera* were issued by Sanderson in 1715 and 1717, and the last three volumes (xviii., xix. and xx.) by the same editor, but upon a slightly different plan, in 1726-35. The latter volumes were published by Tonson, all the former by Churchill. Under Rymer it was carried down to 1386, and continued by Sanderson to 1654. The rarity and importance of the work induced Tonson to obtain a licence for a second edition, and George Holmes, deputy keeper of the Tower records, was appointed editor. The new edition appeared between 1727 and 1735. The last three volumes are the same in both issues. There are some corrections, enumerated in a volume, *The Emendations in the New Edition of Mr Rymer's Foedera*, printed by Tonson in 1730, and on the whole the second is an improvement upon the first edition. A third edition, embodying Holmes's collation, was commenced at the Hague in 1737 and finished in 1745. It is in smaller type than the others, and is compressed within ten folio volumes. The arrangement is rather more convenient; there is some additional matter; the index is better; the type is not so good, but it is to be preferred to either of the previous editions. When the volumes of the *Foedera* first appeared they were analysed by Leclerc and Rapin in the *Bibliothèque choisie* and *Bibliothèque ancienne et moderne*. Rapin's articles were collected together and appended, under the title of *Abregé historique des actes publics de l'Angleterre*, to the Hague edition. A translation, called *Acta Regia*, was published by Stephen Whatley, (1726-27), 4 vols. 8vo, reprinted both in 8vo and folio, the latter edition containing an analysis of the cancelled sheets, relating to the journals of the first parliament of Charles I., of the 18th volume of the *Foedera*.

In 1810 the Record Commissioners authorized Dr Adam Clarke to prepare a new and improved edition of the *Foedera*. Six parts, large folio, edited by Clarke, Caley and Holbrooke, were published between 1816 and 1830. Considerable additions were made, but the editing was performed in so unsatisfactory a manner that the publication was suspended in the middle of printing a seventh part. The latter portion, bringing the work down to 1383, was ultimately issued in 1869. A general introduction to the *Foedera* was issued by the Record Commission in 1817, 4to.

His early learning and untiring labours of Rymer have received the warmest praise, from historians. His industry was praised by Hearne (*Collections*, ii. 296). Sir T. D. Hardy styles the *Foedera* "a work of which this nation has every reason to be proud, for with all its blemishes—and what work is faultless?—it has no rival in its class" (*Syllabus*, vol. ii. xxxvi.), and Mr J. B. Mullinger calls it "a collection of the highest value and authority" (*Gardiner and Mullinger's Introduction to English History*, p. 224).

The best account of Rymer is to be found in the prefaces to Sir T. D. Hardy's *Syllabus* (1869-85, 3 vols. 8vo). There is an unpublished life by Des Matzeaux (*Brit. Mus. Add. MS. No. 4223*), and a few memoranda in Bishop Kennet's collections (*Lansd. MS. No. 987*). See also *Dict. of Nat. Biogr.*, vol. i. In Caulfield's *Portraits*, &c. (1819), i. 50, may be seen an engraving of Rymer, with a description of a satirical print of him as "a garret poet." Rymer's two critical works on the drama are discussed by Sir T. N. Talfourd in the *Retrospective Review* (1820), vol. i. pp. 1-15.

Sir T. D. Hardy's *Syllabus* gives in English a condensed notice of each instrument in the several editions of the *Foedera*, arranged in chronological order. The third volume contains a complete index of names and places, with a catalogue of the volumes of transcripts collected for the Record edition of the *Foedera*. In 1866 the Record Office printed, for private circulation, *Appendix A to E*, "so a report on the *Foedera* intended to have been submitted by C. Purton Cooper to the late Commissioners of Public Records," 3 vols. 8vo (including accounts of MSS. in foreign archives relating to Great Britain, with facsimiles). In the British Museum is preserved (*Add. MS. 24699*) a folio volume of reports and papers relating to the Record edition. Rymer left extensive materials for a new edition of the *Foedera*, bound in 59 vols. folio, and embracing the period from 1115 to 1698. This was the collection offered to the earl of Oxford.

It was purchased by the Treasury for £215 from Mrs Anne Parry, to whom Rymer left all his property, and is now in the British Museum (*Add. MSS.*, Nos. 4573 to 4630, and 1891). A catalogue and index may be consulted in the 17th volume of Tonson's edition of the *Foedera*. The Public Record Office possesses a MS. volume, compiled by Robert Lemon about 1800, containing instruments in the Patent Rolls omitted by Rymer. In the same place may be seen a volume of reports, orders, &c., on the *Foedera*, 1808-11, and the transcripts collected for the new and unfinished edition. (H. K. T.)

RYOT, or **RAYAT** (from the Arabic *ra'ā*, "to pasture"), properly a subject, then a tenant of the soil. The word is used throughout India for the general body of cultivators; but it has a special meaning in different provinces. The ryotwari

tenure is one of the two main revenue systems in India. Where the land revenue is imposed on an individual or community owning an estate, and occupying a position analogous to that of a landlord, the assessment is known as zamindari; and where the land revenue is imposed on individuals who are the actual occupants, the assessment is known as ryotwari. Under zamindari tenure the land is held as independent property; while under ryotwari tenure it is held of the crown in a right of occupancy, which is under British rule both heritable and transferable. The former system prevails in northern and central India, and the latter in Bombay, Madras, Assam and Burma.

RYSWICK, TREATY OF, the peace which in 1697 ended the war between France on the one side and the Empire, England, Spain and Holland, on the other. Begun in 1689 under the leadership of the new king of England, William III., its object was to put a check on the ambitious designs of Louis XIV., and it raged in the Netherlands, the Rhineland, Italy, Ireland and Spain, in India and America and on the sea (see GRAND ALLIANCE, WAR OF THE). Negotiations for peace had begun in 1696, but they were soon broken off, William III. and the English parliament at this time refusing to treat except "with our swords in our hands." But in May 1697 they were renewed under the mediation of the king of Sweden. The French representatives had their headquarters at the Hague and those of the allies at Delft, the conferences between them taking place at Ryswick. For the first few weeks no result was reached, and in June William III. and Louis XIV., the protagonists in the struggle, each appointed one representative to meet together privately. The two chosen were William Bentinck, earl of Portland, and marshal Boufflers, and they soon drew up the terms of an agreement, to which, however, the emperor Leopold I. and the king of Spain would not assent. But in a short time Spain gave way, and on the 20th of September 1697 a treaty of peace was signed between France and the three powers, England, Spain and Holland, the Empire still holding aloof. William then persuaded Leopold to make peace, and a treaty between France and the Empire was signed on the 30th of October following.

The basis of the peace was that all towns and districts seized since the treaty of Nijmegen in 1679 should be restored. Then France surrendered Freiburg, Breisach and Philippsburg to Germany, although she kept Strassburg. On the other hand, she regained Pondicherry and Nova Scotia, while Spain recovered Catalonia, and the barrier fortresses of Mons, Luxemburg and Courtrai. The duchy of Lorraine, which for many years had been in the possession of France, was restored to Leopold Joseph, a son of duke Charles V., and the Dutch were to be allowed to garrison some of the chief fortresses in the Netherlands, including Namur and Ypres. Louis undertook to recognize William as king of England, and promised to give no further assistance to James II.; he abandoned his interference in the electorate of Cologne and also the claim which he had put forward to some of the lands of the Rhenish Palatinate.

For further detail see C. W. von Koch and F. Scholl, *Histoire abrégée des traités de paix* (1817-18); A. Moetiens, *Actes et mémoires de la paix de Ryswick* (The Hague, 1725); A. Legrelle, *Notes et documents sur la paix de Ryswick* (Lille, 1894); and H. Vast, *Les Grands Traités du règne de Louis XIV.* (Paris, 1893-99). See also L. von Ranke, *Englische Geschichte*, English translation as *History of England* (Oxford, 1875).

RZHEV, or **RZHOV**, a town of Russia, in the government of Tver, 76 m. S.W. of the town of Tver, occupying the bluffs on both banks of the Volga (here 350 ft. wide) near the confluence of the Vazuza. Pop. (1900) 31,514. It is the terminus of a branch line (85 m.) from the St Petersburg & Moscow railway, and is the centre of a large transit trade between Orel, Kaluga and Smolensk and the ports of St Petersburg and Riga. In the 12th century Rzhhev belonged to the principality of Smolensk. Under the rulers of Novgorod it became from 1225 a subordinate principality, and in the 15th century the two portions of the town were held by two independent princes.

S the twenty-first letter of the Phoenician alphabet, is one of the four sibilants which that alphabet possesses. In the Phoenician alphabet it takes a form closely resembling the English W, and this when moved through an angle of 90° is the ordinary Greek *sigma* Σ. In Phoenician itself and in the other Semitic alphabets the position of the middle legs of the W is altered so that the symbol takes such forms as √ or ∨ or ∞, ultimately ending sometimes in a form like K laid sideways, ∞. In Greek, where Σ is the twentieth letter of the alphabet, or, if the merely numerical ς and ϣ are excluded, the eighteenth, another form ζ or ∫ according to the direction of the writing is also widespread. This, which is the only form of the earliest period at Cumae, where it is also found more rounded ς, is the origin of the Latin S and its descendants. The development from the angular to the curved shape of S may be seen in its occurrences on the early cippus found in the Roman Forum in 1899. Apart from doubtful instances it is there six times clearly engraved; four of the instances are angular, the other two are more or less rounded. The Semitic name of the symbol is *shin*; the Greek name *sigma* may mean merely the hissing letter and may be a genuine Greek derivative from the verb σίω, hiss. Some, however, see in it a corruption of the Semitic name *samekh*, the letter which corresponds in alphabetic position and in shape to the Greek ξ (x). The Dorian Greeks, however, as Herodotus tells us (i. 139), called that letter *san* which the Ionian Greeks called *sigma*; *san* seems more likely to be an attempt to reproduce the Semitic name. Herodotus says nothing of a difference in shape, but most authorities regard the form M, which with the value of s is practically confined to Doric areas, as being *san*. In the compound σαμφόρος, *san* like koppa (κοππίριος) was known to the Athenians as a brand for highbred horses (cf. Aristophanes, *Clouds*, 122, 1298, 23, 438). For the symbol T which was used at Ephesus and other places in Asia Minor and elsewhere for the sound represented by -σσ- in Ionic Greek, by -ττ- in Attic, see ALPHABET. Further points of difficulty in connexion with the sibilants are discussed under X and Z. The pronunciation of s was originally unvoiced: in English it is often used for the voiced sound as well, compare *lose* with *loose*, *house* with *houses*. At the end of words the voiced sound is often written with -s, the unvoiced with -ss as in *his* and *hiss*. In other cases the pronunciation can be ascertained only from the context, as in *use*, unvoiced for the substantive, voiced for the verb. Sometimes a difference of meaning is indicated by difference of spelling though the sounds in the two words are identical, as in *furs* and *furse*. The voiced form of s (i.e. z) readily passes into r in many languages: compare the Eng. *hare* with the Ger. *Hase*, the Eng. *ear* and Lat. *auris* with the Gothic *auso* and Lithuanian *ausis*, "ear." Here also should be mentioned the sound *sh*, which, like *th*, is not a combination of sounds though written with two symbols. Hence in transcription from foreign languages and in works on phonetics it is represented by *š* or *ž*. The difference in formation between *š* and *ž* is that the former is dental or alveolar, the latter is produced farther back and has at least two varieties. In the usual Eng. *sh* the tip of the tongue is bent backwards so that the tongue becomes spoon-shaped. The voiced sound to this is generally written *z* as in *azure*, but sometimes *s* as in *pleasure*. The sound of *sh* is also sometimes represented by *s*, as in *sure*, *sugar*. This is occasioned by the y-sound with which *u* now begins, and is carried further in dialect than in the literary language, *sue* and *suit*, for example, being pronounced in Scotland like the Eng. *shoe* and *shoot*. The *sh* sound is sometimes not even written with a sibilant, as in the pronunciation of the *ci* and *ti* of words like *rhetorician* and *nation*. (P. Gr.)

SAALE, a river of Germany, a tributary of the Elbe, rises between Bayreuth and Hof in the N.E. of Bavaria, springing out

of the Fichtelgebirge at an altitude of 2390 ft. It pursues a winding course in a northerly direction, and after passing the manufacturing town of Hof, flows amid well-wooded hills until it reaches the pleasant vale of Saalberg. Here it receives the waters of the Schwarzra, in whose romantic valley lies the castle of Schwarzburg, the ancestral seat of the princes of the ruling house of Schwarzburg-Rudolstadt. From Saalberg the Saale enters the dreary limestone formation of Thuringia, sweeps beneath the barren, conical hills lying opposite to the university town of Jena, passes the pleasant watering-place of Kösen, washes numerous vine-clad hills and, after receiving at Naumburg the deep and navigable Unstrut, flows past Weissenfels, Merseburg, Halle, Bernburg and Kalbe, and joins the Elbe just above Barby, after traversing a distance of 226 m. It is navigable from Naumburg, 100 m., with the help of sluices, and is connected with the Elster near Leipzig by a canal. The soil of the lower part of its valley is of exceptional fertility, and produces, amongst other crops, large supplies of sugar beetroot. Among its affluents are the Elster, Regnitz and Orla on the right bank, and the Ilm, Unstrut, Salza, Wipper and Bode on the left. Its upper course is rapid. Its valley, down to Merseburg, is picturesque, and even romantic, because of the many castles which crown the enclosing heights. It is sometimes called the Thuringian or Saxon Saale, to distinguish it from another Saale (70 m. long), a right-bank tributary of the Main, in the Bavarian district of Lower Franconia.

See Hertzberg, *Die historische Bedeutung des Saalelets* (Halle, 1895).

SAALFELD, a town of Germany, in the duchy of Saxe-Meiningen, picturesquely situated on the left bank of the Saale, 24 m. S. of Weimar and 77 S.W. of Leipzig by rail. Pop. (1905) 13,245. One of the most ancient towns in Thuringia, Saalfeld, once the capital of the extinct duchy of Saxe-Saalfeld, is still partly surrounded by old walls and bastions, and contains some interesting mediæval buildings, among them being a palace, built in 1679 on the site of the Benedictine abbey of St Peter, which was destroyed during the Peasants' War. Other notable edifices are the Gothic church of St John, dating from the beginning of the 13th century; the Gothic town hall, completed in 1537; and, standing on an eminence above the river, the Kitzerstein, a palace said to have been originally erected by the German king Henry I., although the present building is not older than the 16th century. But perhaps the most interesting relic of the past in Saalfeld is the striking ruin of the Hoher Schwarm, called later the Sorbenburg, said to have been erected in the 7th century. Saalfeld is situated in one of the busiest parts of Meiningen and has a number of prosperous industries, including the manufacture of machinery, bricks, colours, malt, cigars, hosiery and vinegar. Other industries are brewing, printing and iron-founding, and there are ochre and iron mines in the neighbourhood.

Saalfeld grew up around the abbey founded in 1075 by Anno, archbishop of Cologne, and the palace built by the emperor Frederick I. In 1389 it was purchased by the landgrave of Thuringia, and with this district it formed part of Saxony. In 1680 it became the capital of a separate duchy, but in 1699 it was united with Saxe-Coburg, passing to Saxe-Meiningen in 1826. On the 10th of October 1806 a battle took place near Saalfeld between the French and the Prussians, during which Prince Louis Ferdinand of Prussia was killed.

See Wagner and Grobe, *Chronik der Stadt Saalfeld* (Saalfeld, 1865-1867), and Thümmel, *Kriegstage aus Saalfelds Vergangenheit* (Berlin, 1882).

SAAR, a river of Germany, a right-bank tributary of the Mosel. It rises in the Donon, an eminence of the Vosges, close to the Franco-German frontier, and flows at first north, then north-west and finally north again to its junction with the Mosel

at Konz. Its length is 143 m. The middle part of its valley is an important industrial district, with coal-mines and a variety of manufactures; the Saar wines are also well known. The principal towns on the Saar are Saargemünd, Saarbrücken and St Johann (which face each other across the river), Saarlouis and Saarburg. The river is navigable up to Saargemünd, a distance of 75 m. From here there is connexion with the Rhine-Marne canal by way of the Saar canal, built in 1862, and 40 m. in length, following the Saar valley upwards for about half that distance.

SAARBRÜCKEN, a town of Germany, in the Prussian Rhine Province, on the left bank of the Saar, a navigable tributary of the Mosel, is situated 49 m. by rail N.E. of Metz, at the south end of one of the most extensive coal-fields in Europe, to which it has given its name. Pop. (1885) 10,453; (1905) 26,944. With the towns of St Johann, immediately opposite on the right bank of the river, and Malstatt-Burbach, Saarbrücken forms a single community, the three places having been united in 1900. Saarbrücken has four Protestant churches, a Roman Catholic and an Old Catholic church, and a town hall adorned with paintings by Anton von Werner, illustrating episodes of the war of 1870. Other buildings are the castle, until 1793 the residence of the princes of the house of Nassau-Saarbrücken; a gymnasium, founded in 1615, and a celebrated mining academy. The industries of St Johann-Saarbrücken include wool-spinning, brewing, and the manufacture of leather, tobacco, chemicals and iron wares. The trade is chiefly connected with the produce of the neighbouring coal-mines and that of the numerous important iron and glass works of the district. The Saarbrücken coal-fields extend over 70 sq. m., are estimated to yield about 10,000,000 tons annually, and give employment to nearly 50,000 men.

Saarbrücken owes its name to a bridge which existed in Roman times. Its early lords were the bishops of Metz, the counts of the lower Saargau, and the counts of the Ardennes. From 1381 to 1793 it belonged to the counts of Nassau-Saarbrücken, and then, after having been in the possession of France from 1801 to 1815, it passed to Prussia. In the Franco-Prussian War Saarbrücken was seized by the French on the 2nd of August 1870, but the first German victory on the heights of Spicheren, 3 m. to the south, relieved it four days later.

See Köllner, *Geschichte der Städte Saarbrücken und St Johann* (Saarbrücken, 1865); Ruppertsberg, *Geschichte der ehemaligen Grafschaft Saarbrücken* (Saarbrücken, 1899-1903); and H. Kniebe, *Bilder aus Saarbrückens Vergangenheit* (Saarbrücken, 1894).

SAARBURG, a town of Germany, in the imperial province of Alsace-Lorraine, on the Saar, 44 m. N.W. from Strassburg by rail. Pop. (1905) 9818. Its chief industries are the manufacture of watch springs, gloves, lace, beer and machinery, and it has a trade in grain. Saarbürg, which has been identified with the *Pons Sarovi* of the Romans, belonged to France from 1661 to 1871, its earlier owners having been the bishops of Metz and the dukes of Lorraine.

Another Saarbürg is a town in Prussia at the confluence of the Saar and the Leuk. Pop. (1905) 2186. It has the ruins of a castle, formerly belonging to the electors of Trier, and is still partly surrounded by walls. It has manufactures of bells, furniture and cigars, other industries being tanning and vine-growing. Saarbürg dates from the 10th century and received municipal rights in 1291. From 1036 until 1727, when it passed into the possession of France, it belonged to the electors of Trier. It became Prussian in 1815.

See Hewer, *Geschichte der Burg und Stadt Saarbürg* (Trier, 1862).

SAARGEMÜND (Fr. *Sarreguemines*), a town of Germany, in the imperial province of Alsace-Lorraine, situated at the confluence of the Blies and the Saar, 40 m. E. of Metz, 60 m. N.W. of Strassburg by rail, and at the junction of lines to Trier and Saarburg. Pop. (1905) 14,932. It carries on considerable manufactures of faience, plush, velvet, leather, porcelain and earthenware, and is a chief depot for the papier-mâché boxes, mostly snuff-boxes, which are made in great quantities in the neighbourhood.

Saargemünd, originally a Roman settlement, obtained civic

rights early in the 13th century. In 1297 it was ceded by the count of Saarbrücken to the duke of Lorraine, and passed with Lorraine in 1766 to France, being transferred to Germany in 1871.

See Thomire, *Notes historiques sur Sarreguemines* (Strassburg, 1887); and Box, *Notice sur le pays de la Saare* (Nancy, 1903).

SAARLOUIS, a town and former fortress of Germany, in the Prussian Rhine Province, situated in a fertile district on the left bank of the Saar, and on the railway from Saarbrücken to Trier, 40 m. S. of the latter. Pop. (1905) 8313. The town is well laid out and has spacious streets and a handsome market square. It contains a Roman Catholic and a Protestant church, a town hall, the walls of the council chamber in which are hung with Gobelins, the gift of Louis XIV., a classical school and a hospital. There are coal-mines in the vicinity, and the town has considerable manufactures of porcelain, enamel wares and leather, as well as a brisk trade in cattle and grain.

SaarloUIS was founded in 1681 by Louis XIV. of France, and was fortified by Vauban in 1680-1685. By the peace of Paris, in 1815, it was ceded to the allies and by them was made over to Prussia. The fortifications were dismantled in 1889. Marshal Ney was born here.

See Niessen, *Geschichte des Kreises Saarlouis* (Saarlouis, 1893 and 1897); and Baltzer, *Historische Notizen über die Stadt Saarlouis* (Trier, 1865).

SAAVEDRA, ANGEL DE, DUKE OF RIVAS (1791-1865), Spanish poet and politician, was born at Cordova on the 19th of March 1791. He fought in the war of independence, was a prominent member of the advanced Liberal party from 1820 to 1823, and in the latter year was condemned to death. He escaped to London and lived successively in Italy, Malta and France, until the amnesty of 1834, when he returned to Spain, shortly afterwards succeeding his brother as duke of Rivas. In 1835 he became minister of the interior under Istúriz, and along with his chief had again to leave the country. Returning in 1837, he joined the moderate party, became prime minister, and was subsequently ambassador at Paris and Naples. He died on the 22nd of June 1865. In 1813 he published *Ensayos políticos*, and between that date and his first exile several of his tragedies (the most notable being *Alator*, 1814, and *Lanusa*, 1822) were put upon the stage. Traces of foreign influence are observable in *El Moro Expósito* (1833), a narrative poem dedicated to John Hookham Frere; these are still more marked in *Don Alvaro ó La Fuerza del sino* (first played on the 22nd of March 1835), a drama of historical importance inasmuch as it established the new French romanticism in Spain.

BIBLIOGRAPHY.—*Obras completas del Duque de Rivas* (Madrid, 1894-1904); L. A. de Cueto, "Discurso," in *Memorias de la academia española* (Madrid, 1870); M. Cañete, *Escritores españoles é hispano-americanos* (Madrid, 1884); J. Valera in *El Ateneo* (Madrid, December 1888-February 1889); E. Piñeyro, *El Romanticismo en España* (Paris, 1904).

SAAVEDRA FAJARDO, DIEGO DE (1584-1648), diplomatist and man of letters, was born of a noble family at Algezares (Murcia) on the 6th of May 1584. Educated for the church at Salamanca, he took orders, and in 1606 was appointed secretary to Cardinal Gaspar Borghia, the Spanish ambassador at Rome. Ultimately he became Spanish plenipotentiary at Regensburg in 1636 and at Münster in 1645. He returned to Spain in 1646 and took up the post of member of the council of the Indies to which he had been nominated in 1636, but shortly afterwards retired to a monastery, where he died in 1648. In 1640 he published his *Empresas políticas, ó idea de un principio político cristiano*, a hundred short essays on the education of a prince; these were written primarily for the son of Philip IV. Its sententious style is still admired in Spain. It passed through a number of editions and was translated in several languages, the English version being by Astrý (2 vols., 8vo, London, 1700). An unfinished historical work, entitled *Corona gótica, castellana, y austriaca políticamente ilustrada*, appeared in 1646. Another work ascribed to Saavedra, the *República literaria*, was published posthumously in 1670; it is a satirical discussion on some of the leading characters in the ancient and modern world of letters.

Collected editions of his works appeared at Antwerp in 1677-1678, and again at Madrid in 1789-1790; see also vol. xiv. of the *Bibli. de aed. esp.* (1853).

SAAZ (Czech *Žatec*), a town of Bohemia, Austria, 64 m. N.W. of Prague by rail. Pop. (1900) 16,168, mostly German. It lies on the Eger, which is spanned here by a suspension bridge, 210 ft. long, which is the oldest of its kind in Bohemia, having been constructed in 1826. It possesses several ancient churches, of which one is said to date from 1206, and a town hall built in 1550. Saz is the centre of the extensive hop trade of the neighbourhood. In early times it was the seat of a royal count (*Zupan* or *gauzgraf*). A coat-of-arms was given to the inhabitants by Ladislav for their courage during the storming of Milan; and the place is mentioned as a royal town under Ottokar II. From the outbreak of the Hussite Wars to the Thirty Years' War Saz was Hussite or Protestant, but after the battle of the White Mountain (1620) the greater part of the Bohemian inhabitants left the town, which became German and Roman Catholic.

SABADELL, a town of north-eastern Spain, in the province of Barcelona; on the river Ripoll and on the Barcelona-Saragossa railway. Pop. (1900) 23,294. The town has handsome modern public buildings, including the town hall, schools for primary and higher education, hospitals and theatres. Cloth, linen, paper, flour and brandy are manufactured, and there are iron foundries and saw-mills. About half the inhabitants are employed in the textile factories. Sabadell is said to be the Roman *Sebendunum*, but in Spanish annals it is not noticed until the 13th century.

SABAEANS. The ancient name of the people of Yemen (*q.v.*) was Saba (Saba' with final *hemza*); and the oldest notices of them are in the Hebrew Scriptures. The list of the sons of Joktan in Gen. x. 26-29 contains in genealogical form a record of peoples of South Arabia which must rest on good information from Yemen itself. Many of these names are found on the inscriptions or in the Arabic geographers—Sheba (Saba'), Hazarmaveth (Ḥadramut), Abimael (Abime'athtar), Jobab (Yuhabib, according to Halévy), Jerah (Warāḥ of the geographers), Joktan (Arab Qabtan; *waqata = qabata*). On the other hand, the names of some famous nations mentioned on the inscriptions are lacking, from which it may be concluded that they did not rise to prominence till a later date. Saba' (Sheba) itself, which was in later times the chief name, has in Gen. x. 28 a subordinate place; it was perhaps only a collective name for the companies of merchants who conducted the South-Arabian export trade (the root *saba'* in the inscriptions meaning to make a trading journey), and in that case would be of such late origin as to hold one of the last places in a list that has genealogical form. Two other accounts in Genesis, originally independent, give supplementary information drawn from the Sabaean colonies, the stations and factories established to facilitate trade through the desert. The inscriptions of Al-'Ola published by D. H. Müller show that there were Minaean colonies in North Arabia. Other South Arabs, and especially the Sabaeans, doubtless also planted settlers on the northern trade routes, who in process of time united into one community with their North-Arab kinsmen and neighbours. Thus we can understand how in Gen. xxv. 2-3 Sheba and Dedan appear among the North-Arab "sons of Keturah." Again, the Sabaeans had colonies in Africa and there mingled with the black Africans; and so in Gen. x. 7 Sheba and Dedan, the sons of Raamah (Raghma), appear in the genealogy of the Cushites. With the Ethiopians *Saba'* means "men," a clear indication of their Sabaean descent.

The queen of Sheba who visited Solomon may have come with a caravan trading to Gaza, to see the great king whose ships plied on the Red Sea. The other biblical books do not mention the Sabaeans except incidentally, in allusion to their trade in incense and perfumes, gold and precious stones, ivory, ebony, and costly garments (Jer. vi. 20; Ezek. xxvii. 15, 20, 22 seq.; Isa. lx. 6; Job vi. 10). These passages attest the wealth and trading importance of Saba from the days of Solomon to those of Cyrus. When the prologue to Job speaks of plundering

Sabaeans (and Chaldaeans) on the northern skirts of Arabia, these may be either colonists or caravans, which, like the old Phoenician and Greek traders, combined on occasion robbery with trade. The prologue may not be historical; but it is to be presumed that it deals with historical possibilities, and is good evidence thus far.

The biblical picture of the Sabaean kingdom is confirmed and supplemented by the Assyrian inscriptions. Tiglath-Pileser II. (733 B.C.) tells us that Teima, Saba', and Ḥaiḥā (= Ephah, Gen. xxv. 4 and Isa. lx. 6) paid him tribute of gold, silver and much incense. Similarly Sargon (715 B.C.) in his *Annals* mentions the tribute of Shamsi, queen of Arabia, and of Itamara of the land of Saba'—gold and fragrant spices, horses and camels.

The earliest Greek accounts of the Sabaeans and other South-Arabian peoples are of the 3rd century B.C. Eratosthenes (276-194 B.C.) in Strabo (xv. 4. 2) says that the extreme south of Arabia, over against Ethiopia, is inhabited by four great nations—the Minaeans (*Μιναιῶν, Μιναιῶν*; Ma'in of the inscriptions) on the Red Sea, whose chief city is Carna; next to them the Sabaeans, whose capital is Mariaba (Mariab of the inscriptions); then the Catabanes (Qatabān of the inscriptions), near the Straits of Bāb-el-Mandeb, the seat of whose king is Tamna; fourthly, and furthest east, the people of Ḥadramut (Chatramotitae), with their city Sabota. The Catabanes produce frankincense and Ḥadramut myrrh, and there is a trade in these and other spices with merchants who make the journey from Aelana (Elath, on the Gulf of 'Akaba) to Minaea in seventy days; the Gaba'eans (the Gaba'an of the inscriptions, Pliny's Gebaniteae) take forty days to go to Ḥadramut. This short but important and well-informed notice is followed a little later by that of Agatharchides (120 B.C.), who speaks in glowing terms of the wealth and greatness of the Sabaeans, but seems to have less exact information than Eratosthenes. He knows only the Sabaeans and thinks that Saba is the name of their capital. He mentions, however, the "happy islands" beyond the straits, the station of the Indian trade (§ 103). Artemidorus (100 B.C.), quoted by Strabo, gives a similar account of the Sabaeans and their capital Mariaba, of their wealth and trade, adding the characteristic feature that each tribe receives the wares and passes them on to its neighbours as far as Syria and Mesopotamia.

The accounts of the wealth of the Sabaeans brought back by traders and travellers excited the cupidity of Rome, and Augustus entrusted Aelius Gallus with an expedition to South Arabia, of which we have an authentic account in Strabo (xvi. 4. 22). He hoped for assistance from the friendly Nabataeans; but, as they owed everything to their position as middlemen for the South-Arabian trade, which a direct communication between Rome and the Sabaeans would have ruined, their viceroy Syllaueus, who did not dare openly to refuse help, sought to frustrate the emperor's scheme by craft. Instead of showing the Romans the caravan route, he induced them to sail from Cleopatra to Leucocome, and then led them by a circuitous way through waterless regions, so that they reached South Arabia too much weakened to effect anything. But the expedition brought back a considerable knowledge of the country and its products, and the Roman leader seems to have perceived that the best entrance to South Arabia was from the havens on the coast. So at least we may conclude when, a hundred years later (A.D. 77, as Dillmann has shown), in the *Periplus* of an anonymous contemporary of Pliny (§ 23) we read that Charibaet of Zafar, "the legitimate sovereign of two nations, the Homerites and Sabaeans," maintained friendly relations with Rome by frequent embassies and gifts. Pliny's account of Yemen, too, must be largely drawn from the expedition of Gallus, though he also used itineraries of travellers to India, like the *Periplus Maris Erythraei* just quoted.

Nautical improvements, and the discovery that the south-west monsoon (Hippalus) gave sure navigation at certain seasons, increased the connexion of the West with South Arabia, but also wrought such a change in the trade as involved a revolution in the state of that country. The hegemony of the Sabaeans

now yields to that of a new people, the Homerites or Himyar, and the king henceforth bears the title "king of the Himyarites and Sabaeans." Naval expeditions from Berenice and Myos-hormus to the Arabian ports brought back the information on which Claudius Ptolemy constructed his map, which still surprises us by its wealth of geographical names.

Sabaeen colonies in Africa have been already mentioned. That Abyssinia was peopled from South Arabia is proved by its language and writing; but the difference between the two languages is such as to imply that the settlement was very early and that there were many centuries of separation, during which the Abyssinians were exposed to foreign influences. New colonies, however, seem to have followed from time to time, and, according to the *Periplus* (§ 16), some parts of the African coast were under the suzerainty of the Sabaeen kings as late as the Sabaeo-Himyaritic period; the district of Azania was held for the Sabaeen monarch by the governor of Maphoritis (Ma'āfir), and was exploited by a Sabaeen company. Naturally difficulties would arise between Abyssinia and the Sabaeen power. In the inscription of Adulis (2nd century) the king of Ethiopia claims to have made war in Arabia from Leucomme to the land of the Sabaeen king. And the Ethiopians were not without successes, for on the Greek inscription of Axūm (c. the middle of the 4th century) King Azeianes calls himself "king of the Axūmites, the Homerites, and Raidan, and of the Ethiopians, Sabaeans, and Silee." More serious was the conflict under Dhū-Nu'ās (Dhū-Nuwās of the Arab historians) in the beginning of the 6th century; it ended in the overthrow of the Himyarite king and the subjugation of Yemen, which was governed by a deputy of the Axūmite king, till (about 570) the conquerors were overthrown by a small band of Persian adventurers.

With the exception of what the South-Arabian Hamdāni relates of his own observation or from authentic tradition, the Mahomedan Arabic accounts of South Arabia and Sabaea are of little worth. The great event they dwell on is the bursting of the dam of Ma'rib, which led to the emigration northwards of the Yemenite tribes. We may be sure that this event was not the cause but the consequence of the decline of the country. When the inland trade fell away and the traffic of the coast towns took the sea route, the ancient metropolis and the numerous inland emporia came to ruin, while the many colonies in the north were broken up and their population dispersed. To this the Koran alludes in its oracular style, when it speaks (xxxiv. 17) of well-known cities which God appointed as trading stations between the Sabaeans and the cities He had blessed (Egypt and Syria), and which He destroyed because of their sins.

Inscriptions.—This abstract of the history of Yemen from ancient sources can now be verified and supplemented from inscriptions. Doubts as to the greatness and importance of the Sabaeen state, as attested by the ancients, and as to the existence of a special Sabaeen writing, called "Musnad," of which the Arabs tell, were still current when Niebuhr, in the 18th century, brought to Europe the first account of the existence of ancient inscriptions (not seen by himself in the neighbourhood of S. m.). Following this hint, Seetzen, in 1810, was able to send to Europe, from porphyry blocks near Yarim, the first copies of Sabaeen inscriptions. They could not, however, be read. But the inscriptions found by Wellsted in 1834 at Hishn Ghorāb were deciphered by Gesenius and Rödiger. Soon after this the courageous explorer Arnaud discovered the ancient Mariab, the royal city of the Sabaeans, and at great risk copied fifty-six inscriptions and took a plan of the walls, the dam, and the temple to the east of the city. These, with other inscriptions on stone and on bronze plates brought home by Englishmen, found a cautious and sound interpreter in Oslander. The historical and geographical researches of Kremer and Sprenger gave a fresh impulse to inquiry. Then Joseph Halévy made his remarkable journey through the Jauf, visiting districts and ruins which no European foot had trod since the expedition of Gallus, and returned with almost 800 inscriptions. Of more recent travellers S. Langer and E. Glaser have done most for epigraphy, while Manzoni is to be remembered for his excellent geographical work.

The alphabet of the Sabaeen inscriptions is most closely akin to the Ethiopic, but is purely consonantal, without the modifications in the consonantal forms which Ethiopic has devised to express vowels. There are twenty-nine letters, more than in Arabic, Samekh and Š, being distinct forms, as in Hebrew. This alphabet, which is probably the parent of the South-Indian character, is undoubtedly derived from the so-called Phoenician alphabet, the

connecting link being the forms of the Safa inscriptions and of the Thamudaean inscriptions found by Doughty and Euting. Of the latter we can determine twenty-six characters, while a twenty-seventh probably corresponds to Arabic ط (ṭ). A sign for ص also probably existed, but does not occur in the known inscriptions. In the Thamudaean and Sabaeen alphabets the twenty-two original Phoenician characters are mostly similar, and so are the differentiated forms for غ and خ, while ث, ذ, and probably also ط and ص, have

been differentiated in many ways. This seems to imply that the two alphabets had a common history up to a certain point, but parted company before they were fully developed. The Thamudaean inscriptions are locally nearer to Phoenicia, and the letters are more like the Phoenician; this character therefore appears to be the link connecting Phoenician with Sabaeen writing. It may be noticed that a Thamudaean legend has been found on a Babylonian cylinder of about 1000 B.C., and it is remarkable that the Sabaeen *sātara*, "write," seems to be borrowed from Assyrian *šātāru*.

The language of the inscriptions is South Semitic, forming a link between the North Arabic and the Ethiopic, but is much nearer the former than the latter. Of the two dialects commonly called Sabaeen and Minaean the latter might be better called Hadramitic, inasmuch as it is the dialect of the inscriptions found in Hadramut, and the Minaeans seem undoubtedly to have entered the Jauf from Hadramut.

The inscriptions not only give names of nations corresponding to those in the Bible and in classical authors, but throw a good deal of fresh light on the political history of Yemen. The inscriptions and coins give the names of more than forty-five Sabaeen kings. The chronology is still vague, since only a few very late inscriptions are dated by an era and the era itself is not certain. But the rulers named can be assigned to three periods, according as they bear the title mukrab of Saba, "king of Saba," or "king of Saba and Raidān." The last, as we know from the Axūm inscriptions, are the latest, and those with the title "mukrab" must be the earliest. Four princes of the oldest period bear the name Yatha'amar, and one of these may, with the greatest probability, be held to be the "Itamarā Sabai," who paid tribute to Sargon of Assyria. This helps us to the age of some buildings also. The famous dam of Ma'rib and its sluices were the work of this ancient prince—structures which Arnaud in the 19th century found in the same state in which Hamdāni saw them a thousand years ago. The power of these old sovereigns extended far beyond Ma'rib, for their names are found on buildings in moments in the Axūm.

We cannot tell when the kings took the place of the mukrab, but the Sabaeo-Himyaritic period seems to begin with, or a little after, the expedition of Aelius Gallus. A fragmentary inscription of Ma'rib (Br. Mus., 33) was made by 'Isharh Yaḥḍib and Ya'zil Bayyin, the two kings of Saba and Raidān, sons of Far'm Yanhab, king of Saba." If this Isharh is identical with the Ἰλασάρος of Strabo, king of Mariaba at the time of the Roman invasion, the inscription preserves a trace of the influence of that event on the union of the two kingdoms.

The inscriptions of the latest period present a series of dates—669, 640, 582, 573, 485—of an unknown era. Reinaud thought of the Seleucid era, which is not impossible; but Halévy observes that the fortress of Mawiyat (now Hishn Ghorāb) bears the date 640, and is said to have been erected "when the Abyssinians overran the country and destroyed the king of Himyar and his princes." Referring this to the death of Dhū Nuwās (A.D. 525), Halévy fixes 115 B.C. as the epoch of the Sabaeen era. This ingenious combination accords well with the circumstance that the oldest dated inscription, of the year 385 (A.D. 270), mentions 'Ahtar, Shams and other heathen deities, while the inscriptions of 582 (A.D. 467) and 573 (A.D. 458), so far as they can be read, contain no name of a heathen god, but do speak of a god Raḥmān— that is, the Hebrew Raḥmān, "the compassionate" (Arabic, al-Raḥmān), agreeably with the fact that Jewish and Christian influences were powerful in Arabia in the 4th century. The only objections to Halévy's hypothesis are (1) that we know nothing of an epoch-making event in 115 B.C., and (2) that it is a little remarkable that the latest dated inscription, of the year 669 (A.D. 554), should be twenty-five years later than the Abyssinian conquest. An inscription found by Wedel at 'Obne is dated "in the year 120 of the Lion in Heaven," which we must leave the astronomers to explain.

The inscriptions throw considerable light not only on the Sabaeans but on other South-Arabian nations. The Minaeans, whose importance has been already indicated, appear in the inscriptions as only second to the Sabaeans, and with details which have put an end to much guesswork, e.g. to the idea that they are connected with Minā near Mecca. Their capital, Ma'in, lay in the heart of the Sabaeen country, forming a sort of enclave on the right hand of the road that leads northward from Ma'rib. South-west of Ma'in, on the western coast, their name occurs in connection with the road from Ma'in to the north, lies Barāqish, anciently Yathib, which is an inscription and Arabic geographers always mention with Ma'in. The third Minaean fortress, probably identical with the Κόρυς of the Greeks, lies in the middle of the northern Jauf, and north of the other two.

The three Minaean citadels lie nearly in this position (-.), with old Sabaeen settlements (Raïam) all round them, and even with some Sabaeen places (e.g. Nask and Kamna) within the triangle they form. The dialect of the Minaeans is sharply distinguished from the Sabaeans (see above). The inscriptions have yielded the names of twenty-seven Minaean kings, who were quite independent, and, as it would seem, not always friends of the Sabaeans, for neither dynasty mentions the other on its inscriptions, while minor kings and kingdoms are freely mentioned by both, presumably when they stood under the protection of the one or the other respectively. The Minaeans were evidently active rivals of the Sabaeans influence, and a war between the two is once mentioned. In Hadramut they disputed the hegemony with one another, the government there being at one time under a Minaean, at another under a Sabaeen prince, while the language shows now the one and now the other influence. The religions also of the two powers present many points of agreement, with some notable differences. Thus, puzzling as the fact appears, it is clear that the Minaeans formed a sort of political and linguistic island in the Sabaeen country. The origin of the Minaeans from Hadramut is rendered probable by the predominance of their dialect in the inscriptions of that country (except in that of Hissn 'athrah), by the fact, already mentioned, of a Minaean prince in Hadramut, and by Pliny (iii. 62), that frankincense was collected at Sabota (the capital of Hadramut; inscr. 322), but exported only through the Gebanites, whose kings received custom dues on it, compared with xii. 69, where he speaks of Minaean myrrh "in qua et Atramitica est et Gebanitica et Ausaritis Gebanitarum regno." &c., implying that Minaean myrrh was really a Hadramite and Gebanite product. All this suggests a close connexion between the Minaeans and Hadramut; and from the Minaean inscriptions we know that the Gebanites were at one time a Minaean race, and stood in high favour with the queen of Ma'in. Thus we are led to conclude that the Minaeans were a Hadramite settlement in the Jauf, whose object was to secure the northern trade road for their products. We cannot but see that their fortified posts in the north of the Sabaeen kingdom had a strategical purpose; and so Pliny (xiii. 54) says, "Attinunt ut Minaei, pagus alius, per quos evehitur uo tramic anguste [from Hadramut]. Hi primi commercium turis ferace maximeque exercent, a quibus et Minaeum dictum est." Besides this road, they had the sea-route, for, according to Pliny, their allies, the Gebanites, held the port of Ocelis. If the Minaeans were later immigrants from Hadramut, we can understand how they are not mentioned in Gen. x. In later times, as is proved by the Minaean colony in Ad-Ola, which Euting has revealed to us, they superseded the Sabaeans in some of the sovereignty. In the Olla (see above) we read the names of Minaean kings and gods. Notable also is the mention in I. Chron. iv. 41 of the "Bedouin encampments (בדואים) and the Ma'inim" smitten by the Simeonites, which may possibly refer to the destruction of a Minaean caravan protected by these Bedouins. The LXX. at least renders Ma'inim by Μυαίονες. It seems bold to conjecture that the Minaeans were in accord with the Romans under Aelius Gallus, yet it is noteworthy that no Minaean town is named among the cities which that general destroyed, though ruin fell on Nask and Kamna, which lie inside the Minaean territory.

The inscriptions seem to indicate that the monarchies of South Arabia were hereditary, the son generally following the father, though not seldom the brother of the deceased came between, apparently on the principle of seniority, which we find also in Yemen. Eratosthenes (in Strabo xvi. 4. 3) says that the first child born to one of the magnates after a king came to the throne was his designated successor; the wives of the magnates who were pregnant at the king's accession were carefully watched, and the first child born was brought up as heir to the kingdom. There seems to be a mistake in the first part of this statement; but Eratosthenes will have said is that the oldest prince after the king was the designated successor. This law of succession explains how we repeatedly find two kings named together among the Sabaeans, and almost always find two among the Minaeans; the second king is the heir. The principle of seniority, as we know from North Arabian history, gives rise to intrigues and palace revolutions, and was probably often violated in favour of the elect heir. On the other hand, it readily leads to a limited power of election by the magnates, and in fact good Arabian sources speak of seven electoral princes. Some inscriptions name, besides the king, an eponymus, whose office seems to have been priestly, his titles being *dhu harif*, *eponymus* and *rashiku*, "sacrificer." All royal inscriptions are signed by him at the beginning and the end, and he appears with the king on coins.

Religion.—In spite of the many ruins of temples and inscriptions, the religion of the Sabaeans is obscure. Most of the many names of gods are mere names that appear and vanish again in particular districts and peoples. Of the great national gods of the Sabaeans and Minaeans we know but little. The chief deity was the sun-god, for which there is Arabic evidence, had really a great place in Yemen. Sun-worship seems to have been peculiar to the Sabaeans and Hamdanites; and, if the Sabis of Sabota (Pliny) was in fact the sun deity Shams, this must be ascribed to Sabaeen influence. The Sabaeen Shams was a goddess, while the chief divinity of the Minaeans was the god 'Athrah, a male figure, worshipped under several forms, of which the commonest are the Eastern 'Athrah and

'Athrah Dhu Kabd. Wadd and Nikrah, the gods of love and hate, are possibly only other forms of the two 'Athrahs. The Sabaeans also recognize 'Athrah; but with them he is superseded by Almaqah, who, according to Hamdani, is the planet Venus, and therefore is identical with 'Athrah. The moon-god Sin appears on an inscription of Shabwat; but, according to Hamdani, Haubas, "the drier," was the Sabaeen moon-god. On the Shabwat inscription 'Athrah is the father of Sin, and it is noteworthy that these two deities also appear as nearly related in the Babylonian legend of 'Ishtar's descent to Hades, where 'Ishtar is conversely the daughter of the god Sin. The mother of 'Athrah on an inscription is probably the sun-god. We find also the common Semitic Il (El) and a Dhu Samai answering to the northern Ba'al Shamayim. Three gods of the inscriptions are named in the Koran—Wadd, Yaghuth and Nasr. In the god-name Ta'lab there may be an indication of tree-worship. The many minor deities may be passed over; but we must mention the sanctuary of Riyam, with its images of the sun and moon, and, according to tradition, an oracle. In conformity with old Semitic usage, pilgrimages were made at definite seasons to certain deities, and the Sabaeen pilgrim month, Dhu Hijjat, is the northern Dhu'l-Hijja. The outlines, and little more, of a few of the many temples can still be traced. Noteworthy are the elliptic form of the chief temples in Ma'in and Sirhan, and the castle of Naqab-al-Hajar with its entrances north and south.

Sacrifices and incense were offered to the gods. The names for altar (*midhab*) and sacrifice (*dhibh*) are common Semitic words, and the altar of incense has among other names that of *miqrah*, and in Hebrew. A variety of spices—the wealth of the land—are named on these altars, as *rand*, *ladanum*, *costus*, *larum*, &c. Frankincense appears as *luban*, and there are other names not yet understood. The gods received tithes of the produce of trade and of the field, in kind or in ingots and golden statues, and these tributes, with freewill offerings, erected and maintained the temples. Temples and fortifications were often combined. The golden statues were votive offerings; the four children and the wife of the goddess were for the health of their four children, and a man offers to Dhu Samai the statue of a man and two camels, in prayer for his own health and the protection of his camels from disease of the joints.

Their commerce brought the Sabaeans under Christian and Jewish influence; and, though the old gods were too closely connected with their life and trade to be readily abandoned, the great change in the trading policy, already spoken of, seems to have affected religion as well as the state. The inland gods lost importance with the failure of the overland trade, and Judaism and Christianity seem for a time to have contended for the mastery in South Arabia. The name of Allah appears in the name Rahman (see above), while efforts at Christianization seem to have gone forth from several places at various times. According to Philostorgius, the Homsa were converted under Constantius II. by the Indian Theophilus, who built churches in Zafar and Aden. Another account places their conversion in the reign of Anastasius (491–518). In Nejran Syrian missionaries seem to have introduced Christianity (Nöldeke). But, as the religion of the hostile Ethiopians, Christianity found political obstacles to its adoption in Yemen; and, as heathenism had quite lost its power, it is intelligible that Dhu Nuwas, who was at war with Ethiopia before the last fatal struggle, became a Jew. His expedition against Christian Nejran had therefore political as well as religious motives. The Ethiopian conquest rather hurt than helped Christianity. The famous *palis* (see above) of Abrahah in San'a seems to have been looked on as a sign of foreign dominion, and Islam found it easy to supersede Christianity in Yemen.

Coins.—In older times and in many districts coins were not used, and trade was carried on mainly by barter. Nor have there been many great finds of coins; indeed most of the pieces in European collections probably come from the same hoard. At the same time the coins throw a general light on the relations of ancient Yemen. The oldest known pieces are imitations of the Athenian mintage of the 4th century B.C., with the legend AGE and the owl standing on an overturned amphora. The reverse has the head of Pallas with a Sabaeen N. Of younger coins the first series has a king's head as Sabaeen N., and the old obverse is enriched with two Sabaeen monograms, which have been interpreted as meaning "majesty" and "eponymus" respectively. In a second series the Greek legend has disappeared, and, instead of the two Sabaeen monograms, we have the names of the king and the eponymus. A third series shows Roman influence and must be later than the expedition of Gallus. As the standard of the coins of Attic type is not Attic but Babylonian, we must not think of direct Athenian influence. The type must have been introduced either from Persia or from Phoenicia (Gaza). One remarkable tetradrachm with the Sabaeen legend *Abayath's* is imitated from an Alexander of the 2nd century B.C., the inscription being quite Arabic and the weight Attic. There are also some struck at Raydan and Hadyah, which must be ascribed to the Himyarite period (1st and 2nd century A.D.). The inscriptions speak of "bright Hadyali coins in high relief," but of these none have been found. They also speak of *sel* pieces. The *sel* in late Hebrew answers to the older shekel, and the mention of it seems to point to Jewish or Christian influence.

LITERATURE.—Fresnel, *Pièces rel. aux inscr. Himyarites déc. par M. Arnaud* (1845); *Inscriptions in the Himyaritic Character in the*

British Museum (London, 1863); Praetorius, *Beitr. zur Erklärung der himjar. Inschr.* (3 parts, Halle, 1872-1874); Kremer, *Südarabische Sage* (1866); Sprenger, *Alte Geogr. Arabiens* (1873); D. H. Müller, *Südarabische Studien* (Vienna, 1877); Id., *Die Burgen u. Schlösser Südarabiens* (2 parts, Vienna, 1879-1881) (especially for chronology and antiquities); Mordtmann and Müller, *Sabäisches Denkmäler* (Vienna, 1883); Derenburg, *Études sur l'Épigraphie du Yémen* (Paris, 1884); Id., *Novae. Érud.* (1885); Glaser, *Mitteilungen über . . . sab. Inschr.* (1886); Hildbrandt, *Geogr. d. arab. Halbinsel*, ed. D. H. Müller, vol. 1 (Leiden, 1884). See also papers by Osiander, *Z.D.M.G.* xix.-xx. (1864-1865); Halévy, *Journ. As.* (1872-1874); D. H. Müller, *Z.D.M.G.* xxxi.-xxxix. xxviii.; Prédiaux, *Tr. Soc. Bibl. Arch.* (1873); Derenburg, *Bab. and Or. Record* (London, 1887).

Later works are: D. H. Müller, *Epigraphische Denkmäler aus Arabien* (Vienna, 1880); E. Glaser, *Skizze der Geschichte und Geographie Arabiens* &c., 1 Heft (Munich, 1880), vol. II. (Berlin, 1890); *Corpus inscriptionum Semiticarum* . . . iv. Paris, vol. I. fasc. 1 (1889), 2 (1892), 3 (1900), 4 (1908) (Fr. Hommel, *Aufsätze und Abhandlungen* 1892 sqq.); Fr. Hommel, *Südarabische Chrestomathie* (Munich, 1893); J. H. Mordtmann, *Ägyptische Inschriften und Altägypter in den kgl. Museen zu Berlin* (Berlin, 1893); H. Winckler, *Altorientalische Forschungen* ("das Land Musri"); D. H. Müller, *Epigraphische Denkmäler aus Abyssinien* (Vienna, 1894); E. Glaser, *Die Abyssinier in Arabien und Afrika* (Munich, 1895); J. H. Mordtmann, *Musée Impérial Ottoman*, &c. (Constantinople, 1895); D. H. Müller, "Arabia" in Pauly-Wissowa, *Realencyclopädie des klassischen Altertums*, i. 344-359 (1897); J. H. Mordtmann, *Beiträge zur misnaischen Epigraphik* (Weimar, 1897); E. Glaser, *Zwei Inschriften über den Damburk von Märis*; D. H. Müller, *Südarabische Altägypter im kunsthistorischen Hofmuseum* (Vienna, 1899); M. Lichtarski in *Epigraphica* (1901 sqq.); O. Weber, *Studien zur südarabischen Altertumskunde*, i. iii. (1901-1908); H. Grimme, "Verschiedene Aufsätze" in *O.L.Z.* &c.; D. Nielsen, *Die all-arabische Mondreligion* (1904); D. Nielsen, *Neue Katabanische Inschriften* (1906); E. Glaser, *Altägyptische Nachrichten*, vol. I. (1906); M. Hartman, "Südarabisches," i.-viii., in *O.L.Z.* (1907-1908); *Mélanges H. Derenburg* (Paris, 1909); M. Hartman, *Die arabische Frage mit einem Versuche der Archäologie Jemens* (Halle, 1908); D. Nielsen, *Der südarabische Gott Imekah* (1909); O. Weber, "Gottes Symbole auf südarabischen Denkmälern" in *Die Hesperiden* (1909), 269-280, cf. also 282-283.

The lexical material, in so far as it touches the Hebrew, was incorporated by D. H. Müller in the 10th-12th edition of the Gesenius Lexicon and is now incorporated by O. Weber in the 15th edition of the Gesenius-Buhl Lexicon. For collected literature see: up to 1892, F. Hommel's *Südarabische Chrestomathie*; from 1892 to 1907, O. Weber's *Studien zur südarabischen Altertumskunde*, iii. (D. H. M.).

SABAKI, a river of British East Africa which enters the Indian Ocean in 3° 12' S., just north of Malinda. The Sabaki rises (as the Athi) in 1° 42' S., and after flowing north-east 70 m. across the Kapote and Athi plains, turns south-south-east under the wooded slopes of the Yatta ridge, which shuts in its basin on the east. In 3° S. it turns east, and in its lower course (known as the Sabaki) traverses the sterile quartz-land of the outer plateau. The valley is in parts low and flat, covered with forest and scrub, and containing small lakes and backwaters connected with the river in the rains. At this season the stream—which rises as much as 30 ft. in places—is deep and strong and of a turbid yellow colour; but navigation is interrupted by the Lugard falls, about 100 m. from its mouth. Its total length is about 400 m. Apart from the numerous small feeders of the upper river, almost the only tributary is the Tsavo, from the east side of Kilimanjaro, which enters in about 3° S.

SABAS, ST (439-531), a Palestinian monk, born near Caesarea of Cappadocia. Becoming a monk in his childhood, he went to Jerusalem and lived as a hermit. After a time he established the "Great Laura" monastery in the neighbourhood of the Dead Sea, and later on the "New Laura," under St Basil's Rule. In the Lauras the young monks lived a cenobitical life, but the elders a semi-eremitical one, each in his own hut within the precincts of the Laura, attending only the solemn church services. Sabas was made *exarch* or superior of all the monasteries in Palestine, and composed a *Typicon* or Rule for their guidance. He took a prominent part, on the orthodox side, in the Monophysite and Origenistic controversies. His Laura long continued to be the most influential monastery in those parts, and produced several distinguished monks, among them St John of Damascus. It is now known as the monastery of Mar Saba. He is commemorated on the 5th of December.

Another saint of this name, surnamed "the Goth," suffered martyrdom at the hands of Athanaric the Visigoth in the reign of Valentinian, and he is commemorated on the 12th of April in

the Roman Martyrology, on varying days from 12th to 18th in the Greek Menologies.

Sabas's Life was written by his disciple Cyril of Scythopolis. The chief modern authority is A. Ehrhard in Wtzer u. Welte's *Kirchenlexikon* (ed. 2) and *Römische Quartalschrift*, vii.; see also Helyot, *Histoire des ordres religieux* (1714), i. c. 16, and Max Heimbucher, *Orden u. Kongregationen* (1907), i. § 10. (E. C. B.)

SABATIER, LOUIS AUGUSTE (1839-1901), French Protestant theologian, was born at Vallon (Ardèche), in the Cévennes, on the 22nd of October 1839, and was educated at the Protestant theological faculty of Montauban and the universities of Tübingen and Heidelberg. After holding the pastorate at Aubenas in the Ardèche from 1864 to 1868 he was appointed professor of reformed dogmatics in the theological faculty of Strassburg. His markedly French sympathies during the war of 1870 led to his expulsion from Strassburg in 1872. After five years' effort he succeeded in establishing a Protestant theological faculty in Paris, and became professor and then dean. In 1886 he became a teacher in the newly founded religious science department of the École des Hautes Études de la Sorbonne. Among his chief works were *The Apostle Paul* (3rd ed., 1896); *Mémoire sur la notion hébraïque de l'Esprit* (1879); *Les Origines littéraires de l'Apocalypse* (1888); *The Vitality of Christian Dogmas and their Power of Evolution* (1890); *Religion and Modern Culture* (1897); *Historical Evolution of the Doctrine of the Atonement* (1903); *Outlines of a Philosophy of Religion* (1897); and his posthumous *Religions of Authority and the Religion of the Spirit* (1904), to which his colleague Jean Réville prefixed a short memoir. These works show Sabatier as "at once an accomplished dialectician and a mystic in the best sense of the word." He died on the 12th of April 1901.

On his theology see E. Ménégot in *Expository Times*, xv. 30, and G. B. Stevens in *Hibbert Journal* (April 1903).

His brother, PAUL SABATIER, was born at St Michel de Chabrillanoux in the Cévennes on the 3rd of August 1858, and was educated at the faculty of theology in Paris. In 1885 he became vicar of St Nicolas, Strassburg, and in 1889, declining an offer of preferment which was conditional on his becoming a German subject, he was expelled. For four years he was pastor of St Cierge in the Cévennes and then devoted himself entirely to historical research. He had already produced an edition of the *Didache*, and in November 1893 published his important *Life of St Francis d'Assisi*. This book gave a great stimulus to the study of medieval literary and religious documents, especially of such as are connected with the history of the Franciscan Order. In 1908 he delivered the Jowett Lectures on Modernism at the Passmore Edwards Settlement, London.

SABAZIUS, a Phrygian or Thracian deity, frequently identified with Dionysus, sometimes (but less frequently) with Zeus. His worship was closely connected with that of the great mother Cybele and of Attis. His chief attribute as a chthonian god was a snake, the symbol of the yearly renovation of the life of nature. Demosthenes (*De corona*, p. 313) mentions various ceremonies practised during the celebration of the mysteries of this deity. One of the most important was the passing of a golden snake under the clothes of the initiated across their bosom and its withdrawal from below—an old rite of adoption. From Val. Max. i. 3, 2 it has been concluded that Sabazius was identified in ancient times with the Jewish Sabaoth (Zephaoth). Plutarch (*Symp.* iv. 6) maintains that the Jews worshipped Dionysus, and that the day of Sabbath was a festival of Sabazius. Whether he was the same as Sozon, a marine deity of southern Asia Minor, is doubtful. Some explain the name as the "beer god," from an Illyrian word *saboya*, while others suggest a connexion with *Zafo* (god of "health") or *εἰσβα*. His image and name are often found on "votive hands," a kind of *taïsmen* adorned with emblems, the nature of which is obscure. His ritual and mysteries (*Sacra Savadia*) gained a firm footing in Rome during the 2nd century A.D., although as early as 139 B.C. the first Jews who settled in the capital were expelled by virtue of a law which proscribed the propagation of the cult of Jupiter Sabazius.

See J. E. Harrison, *Prolegomena to Greek Religion* (1908), p. 414; H. Usener, *Götternamen* (1896), p. 44; F. Cumont, "Hypistes" in *Revue de l'Instruction publique en Belgique*, xl. (1899); C. S. Blinkenberg, *Archäologische Studien* (1904).

SABBATAI SEBI (1626-1676), Jewish mystic, whose Messianic claims produced an unparalleled sensation throughout the world, was born in Smyrna. He was of Spanish descent and was gifted with a personality of rare fascination. As a lad he was attracted by the mysticism of Luria (*q.v.*), which impelled him to adopt the ascetic life. He passed his days and nights in a condition of ecstacy. He began to dream of the fulfilment of Messianic hopes, being supported in his vision by the outbreak of English Millenarianism. Christian visionaries fixed the year 1666 for the millennium, and in his appeal to Cromwell on behalf of the return of the Jews to England Menasseh ben Israel (*q.v.*) made strong appeal to this belief. Sabbatai's father (Mordecai) was the Smyrna agent for an English house, and often heard of the expectations of the English Fifth Monarchy men. Dazzled by this confirmation of his nascent confidence, Sabbatai for a time found himself the object of suspicion and even persecution. This treatment, so far from extinguishing the flame, eventually converted it into a conflagration. It was in 1648 (the year which Kabbalists had calculated as the year of salvation) that Sabbatai proclaimed himself Messiah, and in Constantinople came across an able but somewhat unscrupulous man, who pretended that he had been warned by a prophetic voice that Sabbatai was indeed the long-awaited Redeemer. Others believed in him, but at first his adherents were a small circle of devotees who kept their faith a secret. He charmed men by his sweet singing of Psalms, and children were always fascinated by him. And now the era of his miracles begins. He journeyed to Jerusalem, and there was the instrument for conferring unexpected services on the community. An oppressive exaction was imposed by a local pasha, and in order to win the succour of Raphael Halebi, Sabbatai repaired to Cairo, being on his route at Hebron hailed as Messiah. His mission was completely successful. At Cairo Sabbatai married. As a boy he had been married and divorced twice—but these were merely nominal unions. Now, however, the romantic story of a beautiful girl (Sarah) was on people's lips; she was firm in her assertion that she was the destined bride of the Messiah. Sabbatai had, at the same time, announced that in a dream a spiritual bride had been promised to him. At the house of Halebi bride and bridegroom met. The adhesion of Halebi produced many imitators, and with a retinue of believers, a charming wife and considerable funds, Sabbatai returned in triumph to the Holy Land. Nathan of Gaza assumed the rôle of Elijah, the Messiah's forerunner, proclaimed the coming restoration of Israel and the salvation of the world through the bloodless victory of Sabbatai "riding on a lion with a seven-headed dragon in his jaws" (Graetz). Again 1666 was given as the apocalyptic year. Threatened with excommunication by the Rabbis of Jerusalem, Sabbatai returned to Smyrna (autumn of 1665). Here he was received with wild enthusiasm, and the masses were carried beyond all bounds. With delirious joy the Jews of Smyrna—men, women and children—fell down and worshipped. They prepared for the return. Men left their work to make ready for the start. They fasted, they rejoiced; one hour they chilled themselves in the cemeteries, the next they rushed frantically through the streets singing Psalmic refrains. Nor did Sabbatai's adherents all belong to the ignorant classes. The Rabbi Haim Benveniste and other men of repute and learning shared the general delusion. It is unnecessary to tell the rest of the story in detail. Many letters are extant, written home to English and Dutch business-houses, in which the marvels of Sabbatai are reported, sometimes with apparent belief in them. From the Levant the Sabbatean movement spread to Venice, Amsterdam, Hamburg and London. Sabbatai was no longer able to doubt the reality of his mission. Day by day he was hailed from all the world as king of the Jews. But his character was too weak to sustain the part. Though he was almost deified by many of his brethren, who at his word agreed to modify their religious observances, yet he was unable to turn the enthusiasm of thousands to any account. Had he boldly led the way to Jerusalem, he would probably have carried everything before him. At the beginning of the fateful year 1666 Sabbatai went (or was summoned) to Constantinople. Here

he was arrested, but reports of miracles continued, and many of the Turks were inclined to become converts. Soon he was transferred to Abydos, amidst the most tragic consternation of his deluded followers. In September Sabbatai was brought before the Sultan, and he had not the courage to refuse to accept Islam. And so the Messianic imposture ended in the apostasy of Sabbatai. The reaction among the Jews was terrible, and a sense of shame was joined to feelings of despair. But the sober-minded among the Jews—these had throughout been the vast majority—seized their opportunity to reclaim those who had been the victims of a terrible wrong. Yet many continued to believe in him, as he from time to time attempted to resume his rôle. In 1676 he died in obscurity in Albania. A sect of Sabbateans—the Dormeh of Salonica—survived him, and for many a long year the controversy for and against his claims left an echo in Jewish life.

The literature on the life and career of this remarkable man is very extensive. Sabbatai Sebi figures largely in English books of the period. A valuable account is given in particular by Graetz, *History of the Jews*, vol. v. ch. iv. 1. Zangwill has a brilliant sketch of Sabbatai's career in his *Dreamers of the Ghetto*. (I. A.)

SABBATH, the day of cessation from work,¹ which among the Hebrews followed six days of labour and closed the week.

1. *Observance*.—The later Jewish Sabbath, observed in accordance with the rules of the Scribes, was a very peculiar institution, and formed one of the most marked distinctions between the Hebrews and other nations, as appears in a striking way from the fact that on this account alone the Romans found themselves compelled to exempt the Jews from all military service. The rules of the Scribes enumerated thirty-nine main kinds of work forbidden on the Sabbath, and each of these prohibitions gave rise to new subtleties. Jesus's disciples, for example, who plucked ears of corn in passing through a field on the holy day, had, according to Rabbinical views, violated the third of the thirty-nine rules,² which forbade harvesting; and in healing the sick Jesus Himself broke the rule that a sick man should not receive medical aid on the Sabbath unless his life was in danger. In fact, as our Lord puts it, the Rabbinical theory seemed to be that the Sabbath was not made for man but man for the Sabbath, the observance of which was so much an end in itself that the rules prescribed for it did not require to be justified by appeal to any larger principle of religion or humanity. The precepts of the law were valuable in the eyes of the Scribes because they were the seal of Jewish particularism, the barrier erected between the world at large and the exclusive community of Yahweh's grace. The ideal of the Sabbath which all these rules aimed at realizing was absolute rest from everything that could be called work; and even the exercise of those offices of humanity which the strictest Christian Sabbatarians regard as a service to God, and therefore as specially appropriate to His day, was looked on as work. To save life was allowed, but only because danger to life "superseded the Sabbath." In like manner the special ritual at the temple prescribed for the Sabbath by the Pentateuchal law was not regarded as any part of the hallowing of the sacred day; on the contrary, the rule was that, in this regard, "Sabbath was not kept in the sanctuary." Strictly speaking, therefore, the Sabbath was neither a day of relief to toiling humanity nor a day appointed for public worship; the positive duties of its observance were to wear one's best clothes, eat, drink and be glad (justified from Isa. lviii. 13). A more directly religious element, it is true, was introduced by the practice of attending the synagogue service; but it is to be

¹ The grammatical inflexions of the word "Sabbath" would show that it is a feminine form, properly *sabbat-t* for *sabbat-t*. The root has nothing to do with resting in the sense of enjoying repose; in transitive forms and applications it means to "sever," to "put an end to," and intransitively it means to "desist," to "come to an end." The grammatical form of *sabbath* suggests a transitive sense, "the divider," and apparently indicates the Sabbath as dividing the month. It may mean the day which puts a stop to the week's work, but this is less likely. It certainly cannot be translated "the day of rest."

² From the Thirty-ninth was certainly the familiar "Sabbath day's journey" (Acts i. 12), based primarily, it would seem, upon the command in Ex. xvi. 29. It was a distance of 2000 cubits.

remembered that this service was primarily regarded not as an act of worship but as a meeting for instruction in the law.

2. *Attitude of Jesus.*—So far, therefore, as the Sabbath existed for any end outside itself it was an institution to help every Jew to learn the law, and from this point of view it is regarded by Philo and Josephus, who are accustomed to seek a philosophical justification for the peculiar institutions of their religion. But this certainly was not the leading point of view with the mass of the Rabbins,¹ and at any rate it is quite certain that the synagogue is a post-exilic institution, and therefore that the Sabbath in old Israel must have been entirely different from the Sabbath of the Scribes. But that it was destitute of any properly religious observance or meaning is inconceivable, for, though many of the religious ideas of the old Hebrews were crude, their institutions were never arbitrary and meaningless, and when they spoke of consecrating the Sabbath they must have had in view some religious exercise of an intelligible kind by which they paid worship to Yahweh. Indeed, that the old Hebrew Sabbath was quite different from the Rabbinical Sabbath is demonstrated in the trenchant criticism which Jesus directed against the latter (Matt. xii. 1-14; Mark ii. 27). The general position which He takes up, that "the Sabbath is made for man and not man for the Sabbath,"² is only a special application of the wider principle that the law is not an end in itself but a help towards the realization in life of the great ideal of love to God and man, which is the sum of all true religion. But Jesus further maintains that this view of the law as a whole, and the interpretation of the Sabbath law which it involves, can be historically justified from the Old Testament. And in this connexion He introduces two of the main methods to which historical criticism of the Old Testament has recurred in modern times: He appeals to the oldest history rather than to the Pentateuchal code as proving that the later conception of the law was unknown in ancient times (Matt. xii. 3 seq.), and to the exceptions to the Sabbath law which the Scribes themselves allowed in the interests of worship (v. 5) or humanity (v. 11), as showing that the Sabbath must originally have been devoted to purposes of worship and humanity, and was not always the purposeless arbitrary thing which the schoolmen made it to be. Modern criticism of the history of Sabbath observance among the Hebrews has done nothing more than follow out these arguments in detail, and show that the result is in agreement with what is known as to the dates of the several component parts of the Pentateuch.

3. *Old Usage.*—Of the legal passages that speak of the Sabbath all those which show affinity with the doctrine of the Scribes—regarding the Sabbath as an arbitrary sign between Yahweh and Israel, entering into details as to particular acts that are forbidden, and enforcing the observance by severe penalties, so that it no longer has any religious value, but appears as a mere legal constraint—are post-exilic (Exod. xvi. 23-30, xxxi. 12-17, xxxv. 1-3; Num. xv. 32-36); while the older laws only demand such cessation from daily toil, and especially from agricultural labour, as among all ancient peoples naturally accompanied a day set apart as a religious festival, and in particular lay weight on the fact that the Sabbath is a humane institution, a holiday for the labouring classes (Exod. xxiii. 12; Deut. v. 13-15). As it stands in these ancient laws, the Sabbath is not at all the unique thing which it was made to be by the Scribes. "The Greeks and the barbarians," says Strabo (x. 3, 9), "have this in common, that they accompany their sacred rites by a festal remission of labour." So it was in old Israel: the Sabbath was one of the stated religious feasts; like the new moon and the three great agricultural sacrificial celebrations (Hosea ii. 11); the new moons and the Sabbaths alike called men to the sanctuary to do sacrifice (Isa. i. 14); the remission of ordinary business belonged to both

alike (Amos viii. 5), and for precisely the same reason. Hosea even takes it for granted that in captivity the Sabbath will be suspended, like all the other feasts, because in his day a feast implied a sanctuary. This conception of the Sabbath, however, necessarily underwent an important modification when the local sanctuaries were abolished under the "Deuteronomic" reform, and those sacrificial rites and feasts which in Hosea's time formed the essence of every act of religion were limited to the central altar, which most men could visit only at rare intervals. From this time forward the new moons, which till then had been at least as important as the Sabbath and were celebrated by sacrificial feasts as occasions of religious gladness, fall into insignificance, except in the conservative temple ritual. The Sabbath did not share the same fate, but with the abolition of local sacrifices it became for most Israelites an institution of humanity divorced from ritual. So it appears in the Deuteronomic decalogue, and presumably also in Jer. xvii. 19 seq. In this form the seventh day's rest was one of the few outward ordinances by which the Israelite could still show his fidelity to Yahweh and mark his separation from the heathen. Hence we understand the importance attached to it in the exilic literature (Isa. lvi. 2 seq., lviii. 13), and the character of a sign between Yahweh and Israel ascribed to it in the post-exilic law. This attachment to the Sabbath, beautiful and touching so long as it was a spontaneous expression of continual devotion to Yahweh, acquired a less pleasing character when, after the exile, it came to be enforced by the civil arm (Neh. xiii.), and when the later law even declared Sabbath-breaking a capital offence. This increasing strictness is exemplified by the attitude of the Book of Jubilees (ii. 17-32, l. 6-13). But it is just to remember that without the stern discipline of the law the community of the second temple could hardly have escaped dissolution, and that Judaism alone preserved for Christianity the hard-won achievements of the prophets.³

4. *Early Christian Church.*—The Sabbath exercised a twofold influence on the early Christian church. On the one hand, the weekly celebration of the resurrection on the Lord's day could not have arisen except in a circle that already knew the week as a sacred division of time; and, moreover, the manner in which the Lord's day was observed was directly influenced by the synagogue service. On the other hand, the Jewish Christians continued to keep the Sabbath, like other points of the old law. Eusebius (H.E. iii. 27) remarks that the Ebionites observed both the Sabbath and the Lord's day; and this practice obtained to some extent in much wider circles, for the *Apostolical Constitutions* recommend that the Sabbath shall be kept as a memorial feast of the creation as well as the Lord's day as a memorial of the resurrection. The festal character of the Sabbath was long recognized in a modified form in the Eastern church by a prohibition of fasting on that day, which was also a point in the Jewish Sabbath law (comp. Judith viii. 6). On the other hand, Paul had quite distinctly laid down from the first days of Gentile Christianity that the Jewish Sabbath was not binding on Christians (Rom. xiv. 5 seq.; Gal. iv. 10; Col. ii. 16), and controversy with Judaizers led in process of time to direct condemnation of those who still kept the Jewish day (e.g. Co. of Laodicea, A.D. 363). Nay, in the Roman church a practice of fasting on Saturday as well as on Friday was current before the time of Tertullian. The steps by which the practice of resting from labour on the Lord's day instead of on the Sabbath was established in Christendom and received civil as well as ecclesiastical sanction are dealt with under SUNDAY; it is enough to observe here that this practice is naturally and even necessarily connected with the religious observance of the Lord's day as a day of worship and religious gladness, and is in full accordance with the principles laid down by Jesus in His criticism of the Sabbath of the Scribes. But of course the

¹ In actual life the Sabbath was often far from being the burden which the Rabbinical enactments would have led us to expect. It is celebrated by the very people who did observe it, in hundreds of hymns, which would fill volumes, as a day of rest and joy, of prementation of the pure bliss and happiness which are stored up for the righteous in the world to come" (S. Schechter, *Jewish Quart. Review*, iii. p. 763; cp. id., *Studies in Judaism*, pp. 296 sqq.).

¹ See the Mishnah, tract. "Shabbath" and the alleviation permitted in the tract. "Eruvin"; and compare Schürer, *Gesch. d. jud. Volkes* (2), pp. 393 seq., where the Rabbinical Sabbath is well explained and illustrated in detail.

² Cp. the discussion in *Hastings' Dict. Bible*, fol. 85b: "The sabbath is delivered into your hands, not you into the hands of the Sabbath" (quoted by S. R. Driver, *Hastings' Dict. Bible*, art. "Sabbath," iv. p. 322). See also art. *Midrash*, § 4, end.

complete observance of Sunday rest was not generally possible to the early Christians before Christendom obtained civil recognition.¹

5. *Origin.*—As the Sabbath was originally a religious feast, the question of the origin of the Sabbath resolves itself into an inquiry why and in what circle a festal cycle of seven days was first established. In Gen. ii. 1-3 and in Exod. xx. 11 the Sabbath is declared to be a memorial of the completion of the work of creation in six days. But it appears certain that the decalogue as it lay before the Deuteronomist did not contain any allusion to the creation (see DECALOGUE), and it is generally believed that this reference was added by the same post-exilic hand that wrote Gen. i. 1-ii. 4a. The older account of the creation in Gen. ii. 4b seq. does not recognize the hexaemeron, and it is even doubtful whether the original sketch of Gen. i. distributed creation over six days. The connexion, therefore, between the seven days' week and the work of creation is now generally recognized as secondary.² But, if the week as a religious cycle is older than the idea of the week of creation, we cannot hope to find more than probable evidence of the origin of the Sabbath. Unless the Sabbath was already an institution peculiarly Jewish, it could not have served as a mark of distinction from heathenism. This, however, does not necessarily imply that in its origin it was specifically Hebrew, but only that it had acquired distinguishing features of a marked kind. What is certain is that the origin of the Sabbath must be sought within a circle that used the week as a division of time. Here again we must distinguish between the week as such and the astrological week, i.e. the week in which the seven days are named each after the planet which is held to preside over its first hour.³ It is plain, however, that there is a long step between the astrological assignation of each hour of the week to a planet and the recognition of the week as an ordinary division of time by people at large. Astrology is in its nature an occult science, and there is no trace of a day of twenty-four hours among the ancient Hebrews. Moreover, it is doubtful from extant remains of Assyrian calendars whether the astrological week prevailed in civil life even among the Babylonians and Assyrians. They did not dedicate each day in turn to its astrological planet; and it is therefore precarious to assume that the Sabbath was in its origin what it is in the astrological week, the day sacred to Saturn, and that its observance is to be derived from an ancient Hebrew worship of that planet.⁴

The week, however, is found in various parts of the world in a form that has nothing to do with astrology or the seven planets, and with such a distribution as to make it pretty certain that it had no artificial origin, but suggested itself independently, and for natural reasons, to different races. In fact, the four quarters of the moon supply an obvious division of the month; and, wherever new moon and full moon are religious occasions, we get in the most natural way a sacred cycle of fourteen or

¹ See, further, E. Schürer in *Zeit. f. New-Test. Wissens.* (1905) or 1-66. For the theological discussions whether and in what sense the fourth commandment is binding on Christians, see DECALOGUE.

² The week, ended by the Sabbath, determined the 'days' of creation, not the 'days' of creation the week" (S. R. Driver, *Genesis* (1909), p. 35). At the same time, there was a peculiar appropriateness in associating the Sabbath with the doctrine that Yahweh is the Creator of all things; for we see from Isa. xl-lvii. that this doctrine was a mainstay of Jewish faith in those very days of exile which gave the Sabbath a new importance for the faithful.

³ If the day is divided into twenty-four hours and the planets preside in turn over each hour of the week in the order of their periodic times (Saturn, Jupiter, Mars, Sun, Venus, Mercury, Moon), we get the order of days of the week with which we are familiar. For, if the Sun presides over the first hour of Sunday, and therefore also over the eighth, the fifteenth and the twenty-second, Venus will have the twenty-third hour, Mercury the twenty-fourth, and the Moon, as the third in order from the Sun, will preside over the first hour of Monday. Mars, again, as third from the Moon, will preside over Tuesday (Dies Martis, Mardi) and so forth. This astrological week became very current in the Roman empire, but was still a novelty in the time of Dio Cassius (xxxvii. 18).

⁴ The evidence of the worship of Saturn among the oldest Hebrews is doubtful. Amos v. 26 (where Chiun is taken to represent Kawān-Saturn) is of uncertain interpretation, see W. R. Harper's discussion, *Hosea*, pp. 139-141 (*International Crit. Comm.*, 1905).

fifteen days, of which the week of seven or eight days (determined by half moon) is the half. Thus the old Hindus chose the new and the full moon as days of sacrifice; the eve of the sacrifice was called *upavasatha*, and in Buddhism the same word (*upōsatha*) has come to denote a Sabbath observed on the full moon, on the day when there is no moon, and on the two days which are eighth from the full and the new moon respectively, with fasting and other religious exercises.⁵ From this point of view it is most significant that in the older parts of the Hebrew Scriptures the new moon and the Sabbath are almost invariably mentioned together.⁶

Nor are other traces wanting of the connexion of sacrificial occasions—i.e. religious feasts—with the phases of the moon among the Semites. Thus the Harranians had four sacrificial days in every month, and of these two at least were determined by the conjunction and opposition of the moon.⁷ That full moon as well as new moon had a religious significance among the ancient Hebrews seems to follow from the fact that, when the great agricultural feasts were fixed to set days, the full moon was chosen. In older times these feast-days appear to have been Sabbaths (Lev. xxiii. 11; comp. the article PASSOVER). A week determined by the phases of the moon has an average length of $29\frac{1}{2} + 4 = 7\frac{1}{2}$ days, i.e. three weeks out of eight would have eight days. But there seems to be in 1 Sam. xx. 27, compared with verses 18, 24, an indication that in old times the feast of the new moon lasted two days.⁸ In that case a week of seven working days would occur only once in two months. We cannot tell when the Sabbath became dissociated from the month; but the change seems to have been made before the Book of the Covenant, which already regards the Sabbath simply as an institution of humanity and ignores the new moon. In both points it is followed by Deuteronomy.⁹ (W. R. S.; S. A. C.)

6. *The Babylonian and Assyrian Sabbath.*—The Babylonian calendars contain explicit directions for the observance of abstinence from certain secular acts on certain days which forms a close parallel to the Jewish Sabbatical rules. Thus for the 7th, 14th, 21st, 28th and also the 19th days of the intercalary Elul it is prescribed that "the shepherd of many nations is not to eat meat roast with fire nor any food cooked by fire, he is not to change the clothes on his body nor put on gala dress, he may not bring sacrifices nor may the king ride in his chariot, he is not to hold court nor may the priest seek an oracle for him in the sanctuary, no physician may attend the sick room, the day is not favourable for invoking curses, but at night the king may bring his gift into the presence of Marduk and Ishtar. Then he may offer sacrifice so that his prayers be accepted." Clearly, then, it was a day of suspended activity, but it will be noted that no religious observances are prescribed in place of the forbidden secular matters. So far no evidence is forthcoming that the same days of each month were observed as these of this special rarely occurring month. Calendars exist for other months which make no such regulations for any days. These abstentions are prescribed for the king and a few other persons; there is no evidence that they were observed by all the people. The 19th day is supposed to have had its sacred nature as the 49th day from the commencement of the preceding month, assuming that to have had 30 days. The months often had only 29 days, when the same character ought to have applied to the 20th day of the following month. There is no evidence that these days were called *sabbattu*, a word which is rendered by *אָמַר נָחַם יְהוָה*, "day of rest of the heart," and was thought to be the origin of the Sabbath. The name *sabbattu* was certainly applied to the 15th day of the month, and *אָמַר נָחַם יְהוָה* could mean "day of rest in the middle," referring to the moon's pause at the full. The frequent Old Testament association of "new moons and Sabbaths" may poi t to an original observance of the 1st and 15th days of the month. Many days are indicated in the calendar as *nubattu*, a term which signifies rest, pause, and especially a god's connubial rest with his consort goddess. The observance of such days was a bar to attending even to important diplomatic business or setting out on a journey. Such *nubattu* days fell on the 3rd, 7th and 16th of the intercalary month of Elul, and were noted as the *nubattu* of Marduk and his consort. It would be precarious to assume that the same days in each month were *nubattu*, for the *nubattu* fell on the 4th of Iyar on one occasion.

⁵ Childers, *Pali Dict.* p. 535; Kern, *Manual of Buddhism*, p. 99, *Mahāvagga*, ii. 1, 1 (Eng. trans. i. 239, 291).

⁶ Both were days of cessation from business (Amos viii. 5), and were fitting occasions to visit a prophet (2 Kings iv. 23). They naturally take their rise among an agricultural folk. On abstinence from work on the New Moon by Jewish women of the present time, see M. Friedmann, *Jews. Ques. and Res. iii.* (1891), p. 712. See also I. Benzinger, *Encyc. Biblica*, cols. 3401 sqq.

⁷ The others—according to the *Fihrist*, 319, 14—are the 17th and the 28th; see Chwolson, *Stabier*, ii. 8, 94 seq.

⁸ It appears from Judith vii. 6 that even in later times there were two days at the new moon on which it was not proper to fast.

⁹ See further J. M. Meinhold, *Sabbat und Woche im Alten Test.* (Göttingen, 1905); *Zeit. f. Alttest. Wissens.* 1909, pp. 81-112.

Possibly the intercalary month was abnormal, the incidence of observances depending not on the day of the month in ordinary months but on the day of the week reckoned consecutively through the year. For it is obvious that if each 7th day during the year was observed as above, it would, like our Sunday or a Jewish Sabbath, fall on a different day of the month in different months. It is quite possible that *sabbatium* and *sabbatum* are from the same root and originally meant much the same thing—a pause, abstinence, from whatever cause or for ceremonial purposes. The intercalary month being purely arbitrary may exhibit a normal arrangement, supposing that the month and the week begin together.

There are traces of what may be called a "five-day week" but also some traces of a period of seven days. The former would be an exact submultiple of the 30-day month, but the exact relation of seven days to the month is not very clear. If the 15th always was full moon day, the 7th would coincide well with half moon, but the 21st and 28th would fall away considerably from the moon's phases. The significance of seven throughout Babylonian literature is very marked, and most of the material has been collected by J. Hahn, *Siebentzähl und Sabbat* (1907). It is quite consistent with the evidence to suppose that a seven-day week was in use in Babylonia, but each item may be explained differently, and a definite proof does not exist. The enormous number of dated documents has induced some scholars to attempt a statistical research into the observance of the 7th, 14th, 21st, 28th and 19th days of the months as Sabbaths. This has not been carried out with sufficient caution. If the Sabbath involved abstinence from all such business as recorded in dated documents and always fell on the same day of the week, &c., should show a marked falling off in the number of dated documents. This appears actually to be the case in the period of the First Dynasty of Babylon and also in the 7th century in Assyria, where early Babylonian customs were kept up conservatively. In other cases the inclusion of documents relating to the temple business, payments of tithes and other dues, salaries to temple officials, and such ceremonies as marriages, &c., which may have demanded the presence of the congregation and were at least partly religious in nature, have been added to complicate the matter. Such business as did not profane the Sabbath according to Babylonian law, &c., should show a marked observance of their Sabbath. Further, if the Sabbaths fell on each 7th day through the year, any indication by dated documents of a falling off in the number of transactions on the 7th day of the month must obviously be completely disguised. As most of the records appealed to are from temple archives, it may be expected that the Sabbath days would show an increased number of records.

For reasons above indicated the whole subject is in its infancy. Even if it could be shown that the Pentateuchal regulations were universally observed in Israel from Mosaic times, it would not include a certain indebtedness to Babylonia for at least some of the institution. On the other hand, complete identity of regulations and observance in Babylonia and Israel at one period need not show more than development on the same lines. The evidence of Babylonian observance has not yet been exhaustively considered. Its most suggestive likenesses are indicated above, but further evidence may render the similarity less striking when the meaning of it is more fully understood. [C. H. W. J.]

7. *Sabbatical Year*.—The Jews under the second temple observed every seventh year as a Sabbath according to the (post-exilic) law of Lev. xxv. 1-7. It was a year in which all agriculture was remitted, in which the fields lay unown and the vines grew unpruned, only the spontaneous yield of the land might be gathered. That this law was not observed before the captivity we learn from Lev. xxvi. 34 seq. (cp. 2 Chron. xxxvi. 21); indeed, so long as the Hebrews were an agricultural people, in a land often ravaged by severe famines, the law of the Sabbatical year could not have been observed. Even in later times it was occasionally productive of great distress (1 Mac. vi. 49, 53; Jos. *Ant.* xiv. 16, 2). In the older legislation, however, we already meet with a seven years' period in more than one connexion. The release of a Hebrew servant after six years' labour (Exod. xxi. 2 seq.; Deut. xv. 12 seq.) has only a remote analogy to the Sabbatical year. But in Exod. xxiii. 10 seq. it is prescribed that the crop of every seventh year shall be left for the poor, and after them for the beasts. The difference between this and the later law is that the seventh year is not called a Sabbath, and that there is no indication that all land was to lie fallow on the same year. In this form a law prescribing one year's fallow in seven may have been anciently observed, but it scarcely originated from the analogy of a seventh day of rest. It is extended in v. 11 to the vineyard and the olive oil, but here the culture necessary to keep the vines and olive trees in order is not forbidden; the precept is only that the produce is to be left to the poor. In Deuteronomy this law is not repeated,

but a fixed seven years' period is ordained for the benefit of poor debtors, apparently in the sense that in the seventh year no interest is to be exacted by the creditor from a Hebrew, or that no proceedings are to be taken against the debtor in that year (Deut. xv. 1 seq.). See the discussion by Driver, *Internat. Crit. Comm.*, ad. loc., and the commentaries on Neh. v. 11.

LITERATURE.—In addition to the references already made, see the articles in *Ency. Bib.* and *Hastings' Dict. Bible* (with references); Fr. Bohn, *Sabbat im Alten Testament u. altjüdisch relig. Aberglauben* (Götterslev, 1903: an interesting list of unlucky days from an old Egyptian calendar on p. 57 seq.); and for post-Biblical literature, Fr. Weber's *Jüdische Theologie* (Index), by Franz Delitzsch and Schneidermann (1897). (W. R. S.; S. A. C.)

SABBATION, or **SAMBATYON**, a river (real or imaginary) in Media—named in some old authorities (Palestinian Talmud, and Midrash Gen. Rabba, lxxiii.)—the site of the exile of the Ten Tribes. But Josephus (*War*, vii. v. 1) has this curious passage, from which, no doubt, many of the subsequent legends were derived:—

"Now Titus Caesar carried some time at Berytus (Beirut) and then removed thence and gave magnificent shows in all the cities of Syria through which he went, and exhibited the captive Jews as proof of the destruction of that nation. He saw on his march a river (identified by Sir C. W. Wilson with 'the stream running from the intermittent spring *Fawad* *al-Deir* in the Lebanon') of such a nature as deserves to be recorded in history. It runs between Arcaea (Arka), which is part of Agrippa's kingdom, and Rapharæa (Rafaniyeh, at north end of the Lebanon), and has something very wonderful and peculiar in it. For when it runs, its current is strong, and has plenty of water; after which its springs fail for six days together, and leave its channel dry, as any one may see. After this it runs on the seventh day as it did before, and as though it had undergone no change at all, and it has been observed to keep this order perpetually and exactly: *whence they call it the Sabbatic river*, so naming it from the sacred Sabbath of the Jews."

Whiston, in his notes to Josephus, already points out that Pliny describes the same river (*Hist. Nat.* xxxi. 11), but according to his account the river ran for six days and rested on the seventh. This is the favourite form of the legend, for though there are intermittent streams in various parts of Asia, none has yet been found to correspond to the fixed regularity posited in the tradition. Various medieval travellers reported such rivers, e.g. Petahiah of Regensburg, who states that such a stream may be found near Jabneh, but his assertion is unfounded. Mahomedans still assert that Josephus's statement is true of the *Nahr-al-Arus* in the neighbourhood in which he locates his Sabbatic river, but modern travellers report that this stream runs every third day. Such facts would, however, be sufficient to explain the origin of the legend. The accounts of Josephus and Pliny do not assert that the intermittence of the current had any connexion with Saturday. Aqiba (q.v.) in the early part of the 2nd century A.D., however, assumes this connexion (*Sanhedrin* 65 b), and a confusion between the Sambatyon of the Lost Tribes and the Sabbatical river of Syria begins to manifest itself. It is owing to the narrative of Eldad the Danite (q.v.) that the Sambatyon river rose into wide fame in the 9th century. His diary became the *Arabian Nights* not only of the Jews but also of many medieval Christians and Moslems. Eldad describes the *Children of Moses*, a powerful and Utopian race, whose territory is surrounded by a wonderful river. He describes it in these terms:—

"The river Sambatyon is 200 yds. broad, about as far as a bow-shot. It is full of sand and stones, but without water; the stones make a great noise like the waves of the sea and a stormy wind, so that in the night the noise is heard at a distance of half a day's journey. There are sources of water which collect themselves in one pool, out of which they water the fields. There are fish in it, and all kinds of clean birds fly round it. And this river of stone and sand rolls during the six working days and rests on the Sabbath day. As soon as the Sabbath begins, fire surrounds the river, and the flames remain until the next evening, when the Sabbath ends."

Nöldeke (*Beiträge zur Geschichte des Alexanderromans*, 48) has shown that the Sambatyon appears in one version of the Alexander Legend. Kaswini, the author of the *Arab Cosmography*, also refers to the Sambatyon. So does Prester John in his letter addressed to the emperor Frederick; in his account it is the violence of the current of sand and stone that prevents the Lost Tribes from reuniting. It is unnecessary to summarize

the various embellishments of the legend; in one version the river attains a width of 17 m. and throws stones as high as a house. But there are no stones on Saturday; it then resembles a lake of snow-white sand. Menasseh ben Israel (*q.v.*), who gave vogue to this latter story in his *Hope of Israel*, adds the detail that if sand from Sambatyon be kept in a bottle it agitates itself during six days but remains still on the Saturday.

The site of the Sambatyon varies considerably in the different narratives. Media, Ethiopia, Persia, India, the Caspian district, —all these are suggested. Reggio identified the river with the Euphrates, Fünh with the Zeb in Adiabene. But as Neubauer remarks: "It would be lost time to trouble ourselves about the identification of this stream."

See Neubauer, "Where are the Ten Tribes?" in *Jewish Quarterly Review*, vol. i. *passim*; M. Seignosin in *Jewish Encyclopedia*, s. 681. (I. A.)

SABBIONETA, a town of Lombardy, Italy, in the province of Mantua, from which it is 20 m. S.W. by steam tramway, not far from the N. bank of the Po, 50 ft. above sea-level. Pop. (1901) 1835 (town); 7016 (commune). Its period of prosperity was under Vespasiano Gonzaga (d. 1591), who was its duke; by him it was transformed into a small "Residenzstadt." It was well fortified and built, and from this period date the ducal palace (now the Municipio), the theatre designed by Scozzi, &c. The church and the summer palace contain frescoes by the Campi di Cremona. Here in 1567 a Hebrew printing-press was set up.

SABELLIC,¹ the name originally given by Mommsen in his *Unteritalische Dialekte* to the pre-Roman dialects of Central Italy which was neither Oscan nor Umbrian. The progress of study has, however, grouped them under more specific names, such as the "North Oscan" group (see PAELIGNI) and the "Latinian" group (see LATIN LANGUAGE), and the only content now left for the term Sabellic consists of a group of 8 or 9 inscriptions to which it certainly cannot be applied with truth. They are probably, if not certainly, the most ancient inscriptions in existence on Italian soil. Since they were all found on a strip of the eastern coast running from the mouth of the Aternus on the south to Pesaro on the north, it is probably best to call them simply "East Italic" or "Adriatic."

Not even the transcription of their alphabet has reached the stage of certainty, for even in this small number of inscriptions the alphabet seems to vary. The chief doubt is about the value of **V** and **∨** (or **A** and **Λ**) which appear beside the symbol **Λ** on the same inscriptions; and of the dots in the middle of the line which are certainly not interpuncts. They may conceivably have some connexion with the dots in Venetic inscriptions, which R. S. Conway has endeavoured to explain (see VENETI). The most striking characteristic of the group of inscriptions is that the direction of the writing in alternate lines is not merely reversed but inverted ("serpentine boustrophedon" as on the Etruscan stele of Capua of the 5th century B.C.) (see ETRUSKIAN LANGUAGE). Thus if the first line consisted of the letters ABC in that order, the next would be **ƆƆƆ**, i.e. with each letter turned so as to face the left, and with its head downwards. This arrangement appears in some of the Venetic inscriptions also. The longest of the inscriptions is that from Greccio, now preserved in the Naples Museum. The probability is that this and all the rest were epitaphs, but a translation is as yet out of the question. The stone from Castignano gives us certain forms which seem to be recognizable as Indo-European, namely *paterefo*, *materefo*, though it is far from certain that the symbol **Ɔ**, which is here represented by *f*, really has that value.

Paul's conjecture that these inscriptions probably represented the language of some settlers from Illyria has little support except that of some coincidences in tribal and local names on the two sides of the Adriatic (e.g. "Truentum, quod solum Liburnorum in Italia relicuam est" (Plin. *Nat. Hist.* iii. 170), —entum being a frequent Illyrian ending, and *Liburni* an Illyrian tribe), though it is a priori likely enough.

For the authorities for the alphabets and the text of the inscriptions as known down to 1897, see R. S. Conway's *Italic Dialects*

¹ For the different tribes, see SABINE.

(Cambridge, 1897), ii. 528; and nothing has yet (1908) been added to what was written about the alphabets by Karl Pauli (*Altital. Stud.* iii., "Die Veneter," Leipzig, 1891, pp. 220 seq. and p. 423). Some plausible (but wholly uncertain) conjectures by W. Deecke as to the meaning of some of the inscriptions may be sought in the appendix to Zvetzoff's *Inserr. Insulae inferioris dialecticae*; and since 1897 a further inscription of this class has been found at Belmonte Piceno, which is preserved in the museum at Bologna and reported by Brizio in *Notiz. degli scavi*, 1903, p. 104.

It is to be noticed that a much longer and far more legible inscription from Novilara (now in the museum at Pesaro—a cast of it is at Bologna) sometimes spoken of as Sabellic, whose first two words are *mimnis erimes*, is perhaps more probably to be regarded as containing some variety of Etruscan, though its character is far from certain. Its alphabet closely resembles Etruscan of the 4th century B.C. It is a very interesting monument both for its own sake, since it is sculptured as well as inscribed (there is one—or more—hunting or pastoral scene on the back), and because the archaeological stratum (late Bronze period) of the cemetery from which it is believed to have come is clearly marked.

With a companion fragment it is fully described by Brizio in *Monumenti antichi*, v. (1895), and it has also been discussed by Ella Lattes in *Hermes* (xxxi. 465 and xliii. 32). (R. S. C.)

SABELLIUS (fl. 230), early Christian presbyter and theologian, was of Libyan origin, and came from the Pentapolis to Rome early in the 3rd century. To understand his position a brief review of the Christian thought of the time is necessary. Even after the elimination of Gnosticism the church remained without any uniform Christology; the Trinitarians and the Unitarians continued to confront each other, the latter at the beginning of the 3rd century still forming the large majority. These in turn split into two principal groups—the Adoptianists and the Modalists—the former holding Christ to be the man chosen of God, on whom the Holy Spirit rested in a quite unique sense, and who after toil and suffering, through His oneness of will with God, became divine, the latter maintaining Christ to be a manifestation of God Himself. Both groups had their scientific theologians who sought to vindicate their characteristic doctrines, the Adoptianist divines holding by the Aristotelian philosophy, and the Modalists by that of the Stoics; while the Trinitarians (Tertullian, Hippolytus, Origen, Novatian), on the other hand, appealed to Plato.

In Rome Modalism was the doctrine which prevailed from Victor to Calixtus or Callistus (c. 190–220). The bishops just named protected within the city the schools of Epigonus and Cleomenes, where it was taught that the Son is identical with the Father. But the presbyter Hippolytus was successful in convincing the leaders of that church that the Modalistic doctrine taken in its strictness was contrary to Scripture. Calixtus saw himself under the necessity of abandoning his friends and setting up a mediating formula designed to harmonize the Trinitarian and the Modalistic positions. But, while excommunicating the strict Unitarians (Monarchians), he also took the same course with Hippolytus and his followers, declaring their teaching to be ditheism. The mediation formula, however, proposed by Calixtus became the bridge by which, in the course of the decades immediately following, the doctrine of the Trinity made its way into the Roman Church. In the year 250, when the Roman presbyter Novatian wrote his book *De Trinitate*, the doctrine of Hippolytus, once discredited as ditheism, had already become official there. At the same time Rome and most of the other churches of the West still retained a certain leaning towards Modalistic monarchianism. This appears, on the one hand, in the use of expressions having a Modalistic ring about them—see especially the poems of Commodian, written about the time of Valerian—and, on the other hand, in the rejection of the doctrine that the Son is subordinate to the Father and is a creature (witness the controversy between Dionysius of Alexandria and Dionysius of Rome), as well as in the readiness of the West to accept the formula of Athanasius, that the Father and the Son are one and the same in substance (*ὁμοούσιος*).

The strict Modalists, whom Calixtus had excommunicated along with their most zealous opponent Hippolytus, were led

by Sabellius. His party continued to subsist in Rome for a considerable time afterwards,¹ and withstood Calixtus as an unscrupulous apostate. In the West, however, the influence of Sabellius seems never to have been important; in the East, on the other hand, after the middle of the 3rd century his doctrine found much acceptance, first in the Pentapolis and afterwards in other provinces.² It was violently controverted by the bishops, notably by Dionysius of Alexandria, and the development in the East of the philosophical doctrine of the Trinity after Origen (from 260 to 320) was very powerfully influenced by the opposition to Sabellianism. Thus, for example, at the great synod held in Antioch in 268 the word *ὁμοούσιος* was rejected, as seeming to favour Unitarianism. The Sabellian doctrine itself, however, during the decades above mentioned underwent many changes in the East and received a philosophical dress. In the 4th century this and the allied doctrine of Marcellus of Ancyra were frequently confounded, so that it is exceedingly difficult to arrive at a clear account of it in its genuine form. Sabellianism, in fact, became a collective name for all those Unitarian doctrines in which the divine nature of Christ was acknowledged. The teaching of Sabellius himself was very closely allied to the older Modalism ("Patripassianism") of Noetus and Praxeas, but was distinguished from it by its more careful theological elaboration and by the account it took of the Holy Spirit. His central proposition was to the effect that Father, Son and Holy Spirit are the same person, three names thus being attached to one and the same being. What weighed most with Sabellius was the monotheistic interest. The One Being was also named by him *ὑπόστασις*—an expression purposely chosen to obviate ambiguity. To explain how one and the same being could have various forms of manifestation, he pointed to the tripartite nature of man (body, soul, spirit), and to the sun, which manifests itself as a heavenly body, as a source of light and also as a source of warmth. He further maintained that God is not at one and the same time Father, Son and Spirit, but, on the contrary, has been active in three apparently consecutive manifestations or energies—first in the *πρόσωπον* of the Father as Creator and Lawgiver, then in the *πρόσωπον* of the Son as Redeemer, and lastly in the *πρόσωπον* of the Spirit as the Giver of Life. It is by this doctrine of the succession of the *πρόσωπα* that Sabellius is distinguished from the older Modalists. In particular it is significant, in conjunction with the reference to the Holy Spirit, that Sabellius regards the Father also as merely a form of manifestation of the one God—in other words, has formally put Him in a position of complete equality with the other Persons. This view prepares the way for Augustine's doctrine of the Trinity. Sabellius himself appears to have made use of Stoical formulas (*κατὰ τὴν οὐρανὴν ἑστῶς*), but he chiefly relied upon Scripture, especially such passages as Deut. vi. 4; Exod. xx. 3; Isa. xlv. 6; John x. 38. Of his later history nothing is known; his followers died out in the course of the 4th century.

The sources of our knowledge of Sabellianism are Hippolytus (*Philos.* bk. ix.), Epiphanius (*Haer.* lxi.) and Dionys. Alex. (*Epp.*); also various passages in Athanasius and the other fathers of the 4th century. For modern discussions of the subject see Schleiermacher (*Theol. Ztschr.* 1822, Hft. 3); Lange (*Ztschr. f. hist. Theol.* 1832, ii. 2); Dollinger (*Hippolyt u. Kalist.* 1853); Zahn (*Marcell v. Ancyra*, 1867); R. L. Ottley, *The Doctrine of the Incarnation* (1896); various histories of Dogma, and Harnack (*s.v.* "Monarchianism, 303") in Herzog-Hauck, *Realencycl. für prot. Theol. und Kirche*, xiii. 305. (A. H. A.)

ŠĀBIANS. The Šābians (*as-Sābi'ūn*) who are first mentioned in the Koran (ii. 59, v. 73, xxii. 17) were a semi-Christian sect of Babylonia, the Elkesaites, closely resembling the Mandaeans or so-called "Christians of St John the Baptist," but not identical with them. Their name is probably derived from the Aramaic *šāb*, a dialectical form of *šāb*, and signifies "those who wash themselves"; the term *al-mughāsilā*, which is sometimes applied to them by Arab writers, has the same meaning, and they were also known as *ἡμεροβαπτιστοί*. How Mahomet understood the

term "Šābians" is uncertain, but he mentions them together with the Jews and Christians. The older Mahomedan theologians were agreed that they possessed a written revelation and were entitled accordingly to enjoy a toleration not granted to mere heathen. Curiously enough, the name "Šābian" was used by the Meccan idolaters to denote Mahomet himself and his Moslem converts, apparently on account of the frequent ceremonial ablutions which formed a striking feature of the new religion.

From these true Šābians the pseudo-Šābians of Ḥarrān (*Carthae*) in Mesopotamia must be carefully distinguished. In A.D. 830 the Caliph Ma'mūn, while marching against the Byzantines, received a deputation of the inhabitants of Ḥarrān. Astonished by the sight of their long hair and extraordinary costume, he inquired what religion they professed, and getting no satisfactory answer threatened to exterminate them, unless by the time of his return from the war they should have embraced either Islam or one of the creeds tolerated in the Koran. Consequently, acting on the advice of a Mahomedan jurist, the Ḥarrānians declared themselves to be "Šābians," a name which shielded them from persecution in virtue of its Koranic authority and was so vague that it enabled them to maintain their ancient beliefs undisturbed. There is no doubt as to the general nature of the religious beliefs and practices which they sought to mask. Since the epoch of Alexander the Great Ḥarrān had been a famous centre of pagan and Hellenistic culture; its people were Syrian heathens, star-worshippers versed in astrology and magic. In their temples the planetary powers were propitiated by blood-offerings, and it is probable that human victims were occasionally sacrificed even as late as the 9th century of our era. The more enlightened Ḥarrānians, however, adopted a religious philosophy strongly tinged with Neoplatonic and Christian elements. They produced a brilliant succession of eminent scholars and scientists who transmitted to the Moslems the results of Babylonian civilization and Greek learning, and their influence at the court of Baghdad secured more or less toleration for Šābianism, although in the reign of Ḥartūn al-Rashid the Ḥarrānians had already found it necessary to establish a fund by means of which the conscientious scruples of Moslem officials might be overcome. Accounts of these false Šābians reached the West through Maimonides, and then through Arabic sources, long before it was understood that the name in this application was only a disguise. Hence the utmost confusion prevailed in all European accounts of them till Chwolsohn published in 1856 his *Ssabier und der Ssabismus*, in which the authorities for the history and belief of the Ḥarrānians in the middle ages are collected and discussed.

See also "Nouveaux documents pour l'étude de la religion des Harraniens," by Dozy and De Goeje, in the *Actes of the Sixth Oriental congress*, ii. 281 f. (Leiden, 1885). (R. A. N.)

SABICU WOOD is the produce of a large leguminous tree, *Lysioloma Sabicu*, a native of Cuba. The wood has a rich mahogany colour; it is exceedingly heavy, hard and durable, and therefore most valuable for shipbuilding. Sabicu, on account of its durability, was selected for the stairs of the Great Exhibition (London) of 1851, and notwithstanding the enormous traffic which passed over them, the wood at the end was found to be little affected by wear.

SABINE, SIR EDWARD (1788–1883), English astronomer and geodesist, was born in Dublin on the 14th of October 1788, a scion of a family said to be of Italian origin. He was educated at the Royal Military Academy, Woolwich, and obtained a commission in the royal artillery at the age of fifteen, attaining the rank of major-general in 1859. His only experience of warfare seems to have been at the siege of Fort Erie (Canada) in 1814. In early life he devoted himself to astronomy and physical geography, and in consequence he was appointed astronomer to various expeditions, among others that of Sir J. Ross (1818) in search of the North-West Passage, and that of Sir E. Parry soon afterwards. Later, he spent long periods on the inter-tropical coasts of Africa and America, and again among the snows of Spitzbergen. He was associated with Henry Williams Chisholm and others as a member of the Royal Commission of

¹ In the 18th century there was discovered in one of the catacombs of Rome an inscription containing the words "qui et Filius diceret et Pater inveniris." This can only have come from a Sabellian.

² Whether Sabellius himself ever visited the East is unknown.

1868-1869 for standardizing weights and measures. Sabine was for ten years (1861-1871) president of the Royal Society, and was made K.C.B. in 1869. He died at East Sheen, Surrey, on the 26th of May 1883.

Of Sabine's scientific work two branches in particular deserve very high credit—his determination of the length of the second's pendulum, and his extensive researches connected with terrestrial magnetism. The establishment of a system of magnetic observatories in various parts of British territory all over the globe was accomplished mainly on his representations; and a great part of his life was devoted to their direction, and to the reduction and discussion of the observations. While the majority of his researches bear on one or other of the subjects just mentioned, others deal with such widely different topics as the birds of Greenland, ocean temperatures, the Gulf Stream, barometric measurement of heights, arcs of meridian, glacier transport of rocks, the volcanoes of the Hawaiian Islands, and various points of meteorology.

SABINI, an ancient tribe of Italy, which was more closely in touch with the Romans from the earliest recorded period than any other Italian people. They dwelt in the mountainous country east of the Tiber, and north of the districts inhabited by the Latins and the Aequians in the heart of the Central Apennines. Their boundary, between the southern portion of the Umbrians on the north-west, and of the Picentines on the north-east, was probably not very closely determined. The traditions connect them closely with the beginning of Rome, and with a large number of its early institutions, such as the worship of Jupiter, Mars and Quirinus, and the patrician form of marriage (*confarreatio*).

Of their language as distinct from that of the Latins no articulate memorial has survived, but we have a large number of single words attributed to them by Latin writers, among which such forms as (1) *fircus*, Lat. *hircus*; (2) *awsum*, Lat. *aurum*; (3) *nouensiles*, Lat. *nouensides* ("the gods of the nine seats"); (4) the river name *Farfarus*, beside pure Lat. *Fabarius* (Servius, *ad Aen. vii. 715*); and (5) the traditional name of the Sabine king, *Numa Pompilius* (contrasted with Lat. *Quinctilius*), indicate clearly certain peculiarities in Sabine phonology: namely, (1) the representation of the Indo-European palatal aspirate *gh* by *f* instead of Lat. *h*; (2) the retention of *s* between vowels; (3) the change of medial and initial *d* to *t*; (4) the retention of medial *f* which became in Latin *b* or *d*; and (5) the change of Ind.-Eur. *q* to *p*. Not less clear is the well attested tradition (e.g. Paul *ex Fest. 327 M.*) that the Sabines were the parent stock of the Samnites, and this is directly confirmed by the name which the Samnites apparently used for themselves, which, with a Latinized ending, would be *Sabini* (see *SAMNITES* and the other articles there cited, dealing with the minor Samnite tribes).

It is one of the most important problems in ancient history to determine what was the ethnological relation of these tribes, whom we may call "Sabine," to the people of Rome on the one hand, and the earlier stratum or strata of population in Italy on the other. Much light has been thrown on this group of questions in recent years both from linguistic and from archaeological sources. For the historical and archaeological evidence which connects the Sabines with the patricians of Rome, see *ROME, Ancient History*. The linguistic side of the matter may be conveniently dealt with here. From this point of view the question to be asked is what language did the Sabines speak? Was it most nearly akin to Latin or to Oscan or again to Umbrian and Volscian?

A single monument of 5th- or 4th-century Sabine would be of unique value; but in the absence of any such direct evidence we are thrown back on a few cardinal facts: (1) Festus, though he continually cites the *Lingua Oscan* never spoke of *Lingua Sabina*, but simply of Sabini, and the same is practically true of Varro, who never refers to the language of the Sabines as a living speech, though he does imply (v. 66 and 74) that the dialect used in the district differed somewhat from urban Latin. The speech therefore of the Sabines by Varro's time had become too Latinized to give us more than scanty indications of what it had once been.

(2) The language of the Samnites was that which we now call Oscan (see *OSCA LINGUA*). (3) The evidence of the glosses and place-names already referred to confirms tradition by the resemblance which they show to the phonological characteristics of Oscan. On the other hand there are two or three forms called Sabine by Latin writers which do appear to show the sound *q* unchanged, especially the name of the Sabine god *Quirinus*, which seems to be at least indirectly connected with the name of the Sabine town *Cures*. We do not, however, know that the initial sound of this word was originally a *Velar q*, and Professor Ridgeway ("Who were the Romans," London, 1908, in *Proceedings of the British Academy*, iii. 19) rightly lays some stress on the fact that the name in Greek form is simply *κῠρίνος* (not *κῠρίνος*: whereas Lat. *Quintus* is regularly transcribed *κῠντρος*), and suggests that the initial sound may have been slightly modified so as to correspond with the pure Latin word *quirites* (spearmen). In one or two other examples of an apparent *q* in Sabine names or glosses it is not difficult to show that the sound was originally a pure palatal followed by a suffixal *u* (e.g. *tesqua*, "desert places," probably for **ters-c-u-a*, cf. *pās-c-u-a*, and Greek *τεροα-ίωβι*, Lat. *terra*, "dry land," from *tersū*), so that they would in fact offer no difficulty.

There is further an important piece of evidence which connects together all the Sabine tribes and distinguishes them sharply, at least in the 5th and following centuries B.C., from the earlier strata of population in Italy. As this point arises in connexion with so many tribes it is desirable to offer the evidence for it here once for all. It rests upon the different character of the suffixes used by particular tribes and communities to form their ethnic name.

There are only six suffixes so used among the names of ancient Italy.¹ These suffixes are: -ulo-, -io-, -co-, -no-, -ti- (or -ati-), -ensi-. The suffix -ulo- appears only in a few old names, *Siculi*, *Rutuli*, *Appuli*, *Podiculi* and *Vituli*, which would have been the pure Latin form, instead of *Itali*, which was taken over from the Grecized form *Ἰταλοί*.

2. Excluding this small group, the frequency of the occurrence of these suffixes in ancient Italy is shown by the following table:

Table of Ethnic Suffixes in Ancient Italy.

Dialectic Area.	-IO-	-CO-	-NO-	-TI-	-ENSI-	Totals.
Messapii	2	..	16	..	2	20
Peucetii	1	..	15	..	3	19
Daunii	1	..	8	3	2	14
Bruttii	2	..	11	2	4	19
Lucani	2	..	13	3	2	20
Hirpini	33	1	2	36
Frentani	4	4	2	10
Samnites	1	(1)	5	4	3	13
Campani	3	(1)	43	5	3	54
Aurunci	1	2	2	..	1	5
Volsci	(1)	2	..	1	4
Hernici	1	3	10	1	42
Marsi	1	3	2	..	6
Marsi	1	3	4	1	9
Aequi	6	2	..	9
Latini	4	1	44	8	20	77
Early Rome	2	..	19	..	6	27
Sabini	13	4	2	19
Etruria (including the Falisci)	5	2	34	9	20	70
Marrucini	1	(1)	2	1	2	7
Paellini	8	4	2	14
Vestini	5	4	2	14
Piceni	(1)	15	5	14	34
Umbri	23	35	15	73
Totals	27	7	354	106	107	601

The figures in brackets refer to the forms in -CINO-; see below.

3. The names in -io- seem to have been evenly distributed over the Italian area and not to mark any particular tribe or epoch.

4. The suffix -ensi- can be shown to have borne a political significance.

¹ This statement with those which follow is based upon the collections of the place-names of ancient Italy, arranged according to their locality, by R. S. Conway in *The Italic Dialects* (Cambridge, 1897).

that is to say, it was used by the Romans to form the names of the inhabitants of municipal towns, as for instance *Foro-tulenses*, the inhabitants of Forum Julii. There remain, therefore, the three suffixes *-co-*, *-no-*, and *-ti-*, and it will be seen from the table that the relative frequency of these suffixes in different dialect-areas varies very greatly. The suffix *-no-*, for example, has almost driven out any other in the district of the Hirpini, and it is greatly preponderant among the Campani, in the district of the Lucani, and among the Latini and Sabini themselves.

5. On the other hand, the *-co-* suffix, which is nowhere frequent, is practically confined to the central areas.

6. The *-ti-* suffix is comparatively frequent in the Volscian district and very frequent in the Umbrian; it is also fairly well represented in Latium and Etruria.

7. In the article VOLSCI it is shown that the addition of the *-no-* suffix is often a mark of the conquest of an original *-co-* folk by a Sabine tribe. It is also fairly frequently added to names formed with the *-ti-* suffix: *Ardea* gave first *Ardeates* and then *Ardeatini*; the *Picentes* became *Picentini*, the *Comertes Camertini*; of such forms there are no fewer than 54.

8. The addition of the *-ti-* suffix to the *-no-* ethnicon, as in *Iguvinales*, is comparatively rare, and no doubt denotes the opposite process, namely, the absorption of a *-no-* tribe by a population to whom it was natural to use the suffix *-ti-*. The two opposite processes confirm the inference that both are due to some change of race, not merely to a change of custom in the same population in a later age; for in that case the change would have been in one direction only.

The assumption of the Sabine origin of the *-no-* suffix is further confirmed by the practice of the Romans themselves. The folk of Latium after the Sabine conquest were no longer *Latiarum* but *Latini*; and over against the old name *Quiritis* was the new *Populus Romanus*. Just the same rough and ready nomenclature was applied to communities conquered on foreign soil; the *Σπαρτιάται* became *Spartani*, the *Συρακοῖσι* *Syracusani*, and the *Ἀσιατικοὶ Ἀσιανί*, and so on.

The assumption that Latin was properly the language of the Latian plain and of the Plebs at Rome, which the conquering patrician nobles learnt from their subjects, and substituted for their own kindred but different Sabine idiom, renders easier to understand the borrowing of a number of words into Latin from some dialect (presumably Sabine) where the velars had been labialized; for example, the very common word *bos*, which in pure Latin should have been **ros*. And in general it may be stated that the hypothesis of such an intermixture of forms from neighbouring dialects has been rendered in recent years far more credible by the striking evidence of such continual intermixture going on within quite modern periods of time afforded by the *Atlas linguistique de la France*, even in the portion which has already been published.

The conclusion, therefore, to which the evidence appears to lead us is that in, say, the 7th century, B.C., the Sabines spoke a language not differing in any important particulars from that of the Samnites, generally known as Oscan; and that when this warlike tribe combined with the people of the Latian plain to found or fortify or enlarge the city of Rome, and at the end of the 6th century to drive out from it the Etruscans, who had in that century become its masters, they imposed upon the new community many of their own usages, especially within the sphere of politics, but in the end adopted the language of Latium henceforth known as *lingua Latina*, just as the Normans adopted the language of the conquered English.

The glosses and place-names of the ancient Sabine district are collected by R. S. Conway, the *Italic Dialects* (Cambridge, 1897), p. 351. For the history of the Sabine district see Mommsen, *C.I.L.*, ix, p. 395; and Bloch, "Der italische Bund unter römischer Hegemonie" (Leipzig, 1880) and "La Conquista Romana della regione Sabina," in the *Rivista di storia antica* (1905), ix, p. 269. (R. S. C.)

SABINIANS, pope from 604 to 606, successor of St Gregory the Great. He incurred unpopularity by his unseasonable economies. The erudite Italian Augustinian Onofrio Panvino (1529-1568) in his *Epitome pontificum Romanorum* (Venice, 1557) attributes to this pope the introduction of the custom of ringing bells at the canonical hours and for the celebration of the eucharist.

SABLE, the name of a small quadruped, closely akin to the martens, and known by the zoological name of *Mustela sibirica*. It is a native of Siberia and famous for its fur. The name

appears to be Slavonic in origin, cf. Russian *sobol*, whence it has been adapted into various languages, cf. Ger. *Zobel*, Dutch *Sabel*; the Mod. Fr. *sibelline* and Med. Lat. *sibellina* derive from the Ital. form. The Eng. and Med. Lat. *sabellum* are from the O. Fr. *sable* or *sabile* (see MARTEN and FUR). "Sable" in English is a rhetorical or poetical synonym for "black." This comes from the usage in heraldry (first in French) for the colour equivalent to black, represented conventionally by a cross-hatching of vertical and horizontal lines. It has usually been assumed that this is an extension of the name of the fur, but sable fur is brown.

SABLÉ, MADELEINE DE SOUVRÉ, MARQUISE DE (1599-1678) French writer, was born in 1599, the daughter of Gilles de Souvré, marquis de Courtenuvaux, tutor of Louis XIII., and marshal of France. In 1614 she married Philippe Emmanuel de Laval, marquis de Sablé, who died in 1640, leaving her in somewhat straitened circumstances. With her friend the comtesse de St Maur she took rooms in the Place Royale, Paris, and established a literary *salon*. Here originated that class of literature of which the *Maximes* of La Rochefoucauld are the best-known example. The *Maximes* of the marquis de Sablé were in fact composed before those of La Rochefoucauld, though not published till after her death. In 1655 she retired, with the comtesse de St Maur, to the Convent of Port Royal des Champs, near Marly, removing in 1661, when that establishment was closed, to Auteuil. In 1669 she took up her residence in the Port Royal convent in Paris, where she died on the 16th of January 1678.

SABLÉ, a town of western France, in the department of Sarthe, on the river Sarthe, 30 m. W.S.W. of Le Mans by rail. Pop. (1906) 4952. Sablé has a château of the 18th century, a fortified gateway, relic of a medieval stronghold, and a modern church with fine stained glass of the early 15th century. Its importance, however, is chiefly due to the marble quarries of the vicinity, the products of which are worked in the town, where flour-milling, the manufacture of farm-implements and trade in cattle are also carried on. A communal college is among the public institutions. From the 11th century Sablé was the seat of a powerful barony, which in 1602 was made a duchy-peerage in favour of Urbain de Laval, marshal of France. The place afterwards came into the possession of Colbert de Torcy, nephew of the great Colbert who built the château. In 1488 a treaty which resulted in the union of France and Brittany was concluded at Sablé, between Charles VIII. and Duke Francis II.

SABLE ANTELOPE, the English name for a large and handsome South African antelope (*Hippotragus niger*), exhibiting the rare feature of blackness or dark colour in both sexes. The sable and the roan antelope (*H. equinus*) belong to a genus nearly related to the oryxes, with which they form a group or sub-family. In all these antelopes long cylindrical horns are present in both sexes; the muzzle is hairy; there is no gland below the eye; the tail is long and tufted; and in the breadth of their tall crowns the upper molar-teeth resemble those of the oxen. The sable and roan antelopes are distinguished from Oryx by the stout and thickly ringed horns rising vertically from a ridge over the eyes at an obtuse angle to the plane of the lower part of the face, and then sweeping backwards in a bold curve. Sable antelope are among the handsomest of South African antelopes, and are endowed with great speed and staying power. They are commonly met with in herds including from ten to twenty individuals, but on rare occasions as many as fifty have been seen together. Forest-dated highlands are their favourite resorts. The roan antelope is a larger animal, with shorter horns, whose general colour in both sexes is strawberry-roan. It is typically a South African species, but is represented by a local race in the eastern Sudan (*H. equinus bakeri*) distinguished by its redder colour and different face-makings.

SABLE ISLAND, an island of Nova Scotia, Canada, 110 m. S.E. of Cape Canso, in 43° 56' N. and 60° W. It is composed of shifting sand, and is about 20 m. in length by 1 m. in breadth, rising in places to a height of 85 ft. In the interior is a lake about 10 m. in length. At either end dangerous sandbars run out

about 17 m. into the ocean. It has long been known as "the graveyard of the Atlantic"; over 200 known wrecks have been catalogued, and those unrecorded are believed greatly to exceed this number. The coast is without a harbour and liable to fogs and storms; irregular ocean currents of great strength sweep round it, and its colour makes it indistinguishable until close at hand. Since 1873 an efficient lighthouse system and life-saving station has been maintained by the Canadian government, and the danger has been much lessened. Since 1904 it has been connected with the mainland by wireless telegraphy. The island is constantly changing in shape, owing to the action on the sand of wind and wave, and tends to diminish in size. Since 1763, when taken over by Britain, it has shrunk from 40 m. in length to 20, from 2½ in breadth to 1, and from 200 ft. in height to 85; since 1873 the western lighthouse has thrice been removed eastward. As this makes navigation still more dangerous, the Canadian government has planted thousands of trees and quantities of root-binding grass, and the work of destruction has been somewhat stayed. Wild fruits grow plentifully during the summer, and cranberries are exported. Wild ducks, gulls, and other birds nest in large numbers, and a native breed of ponies has long flourished.

Sable Island, estimated as being then over 100 m. in length, was known to the early navigators under the name of Santa Cruz. Early in the 16th century horses were left on its shores by the Portuguese, and the native ponies, supposed to be their descendants, are still exported. In 1598 a band of convicts were left by the marquis de la Roche, but in 1603 the survivors were restored to France.

See Rev. Geo Patterson in *Transactions of Royal Society of Canada* (1894 and 1897).

SABRE-FENCING, the art of attack and defence with the sabre, or broad-sword. Besides the heavy German basket-sabre and the *Schläger* (see below) there are two varieties of sabre used for fencing, the military sword and the so-called light sabre. These are nearly identical in shape, being composed of a slightly curved blade about 34 in. in length and a handle furnished with a guard to protect the hand; but the military sword, or broad-sword proper, the blade of which is about ½ in. wide near the guard, tapering to ¼ in. near the point, is considerably heavier than the light sabre and is generally preferred by military instructors, being almost identical with the regulation army sabre in size and weight. Until 1900 it was the common fencing sabre in Great Britain, the United States, and most European countries, although its use was practically confined to military circles. About 1900 the light Italian sabre was introduced and became the recognized cut-and-thrust weapon among fencers throughout the world. In Austria-Hungary it became popular as early as 1885, while in Italy, the country of its origin, it has been in use since the middle of the 19th century. Its blade is about ⅞ in. wide a little below the guard, tapering to ¼ in. just under the point. For practice this is truncated and the edge blunt, but in scoring both edge and point are assumed to be sharp, while in countries on the continent of Europe (though not in Great Britain or the United States) the back-edge (false-edge) is also supposed to be sharpened for some 8 in. from the point. In Italy when used for duelling the point and both edges are actually sharpened.

The modern sabre is a descendant of the curved light cavalry sword of the late 18th century, which was introduced into Europe from the Orient by the Hungarians.

The old-time European swords used for cutting were nearly all straight, like the Ital. *schiaona* and *spadroon*, the English and German two-handers and the Scotch claymore (see *Sword*). There was indeed a heavy curved fencing weapon called *dussack*, very popular in the German fencing schools of the 16th and 17th centuries, which was of wood, very broad and as long as the fencer's arm, with an elliptical hole for the hand in place of a guard. But the *dussack* was introduced from Bohemia, where, as in Hungary, swords were oriental in shape, and as it completely disappeared in the last half of the 17th century it can hardly be considered in any way as the ancestor of the modern

sabre. The old English *back-sword*, the traditional English weapon, though the curved form was not quite unknown, was almost invariably straight. The ancient English sword-and-buckler play (see *FENCING*) was, to the disgust of its devotees, driven out as a method of serious combat by the introduction at the beginning of the Elizabethan era of the Italian thrusting rapier. Nevertheless it survived as a sport up to the first half of the 18th century, being practised, together with the back-sword or broad-sword play, cudgelling or single-stick fencing, foiling and boxing, by the fencing masters of that period, whose exhibitions, given for the most part in the popular bear-gardens, were described by Pepps, Steele and others. The masters who figured in these "stage-fights" were called "prize-fighters"; and at that period they regarded boxing only as an unimportant part of their art. The most famous of them was Figg, the "Atlas of the Sword" (see *FENCING*). The back-sword of Figg's time was essentially the military sword then in use, having a single straight edge. The blows were aimed at the head, body or legs. Towards the close of the 18th century sticks began to be used for back-swording, the play at first being aimed at any part of the person; but the head soon came to be the sole object of attack, blows on the body and arms being used only to gain an opening. The usual defence was from a high hanging guard. No lunging was allowed. Fencing with the broad-sword did not, however, at any period entirely disappear in England, and was taught by all the regular masters, especially by the celebrated Angelo. The earlier play, of the time of Figg and later, was simple and safe. The prevailing defensive position was the hanging guard, high or medium, with the arm extended and the point downwards. There were also high inside and outside, tierce, quarte, low prime, seconde, and the head or "St George," parries; the last, a guard with the blade nearly horizontal above the head, being the supposed position of England's patron saint from which he dealt his fatal blow at the dragon. Owing to the great weight of the old back-sword wristplay was almost impossible, the cuts being delivered with a chopping stroke. Later in the 18th century a nimbler style, called the Austrian, came into fashion, owing to the introduction of a lighter, curved sabre, the principal guards being the medium, with extended hand and sword held perpendicularly with the point up; the hanging, with the point down, both outside and inside; the half-circle; the "St George"; and the spadron, with horizontal arm and sword pointing downwards. The spadron (Ital. *spadrona*), a light, straight, flat-bladed and two-edged sword, was also a popular 18th-century weapon, and was used both for cutting and thrusting. The thrusting attacks and parries were generally similar to those of the small-sword (see *FOL-FENCING*), but few or no circular parries were used. The cuts were like those of the broad-sword. The Germans, like the British, were once masters of the edge in fencing, but the art declined with the introduction of the point, and sabre-playing survived only in the army and in academic circles with the heavy basket-sabre (see below).

The school of sabre still taught in most armies, and up to the end of the 19th century by fencing-masters of all countries except Italy and Austria-Hungary, shows little advance from that in vogue in Angelo's time. Two fundamental guards are usual, one (taught at the French army school at Joinville-le-Pont) corresponding to the guard of tierce in foil-fencing, except that the left forearm rests in the small of the back; and the other a high hanging guard, with crooked arm and the point of the sabre directed slightly forwards. The methods of coming on guard differ considerably, but have nothing to do with fencing proper. In 1806 the Florentine (Radaelli) system of sabre was introduced into the British army, the cavaliere F. Masiello spending some time at Aldershot for the purpose of training the army sword-masters; but since the year 1901 regular instruction in swordsmanship has practically been abandoned.

Fencing on horseback for cavalry is simple in comparison with light sabre-play. The cavalry sword is of two patterns, one the heavy, straight cuirassier's sword, and the other somewhat lighter with a slightly curved blade. On the attack straight

point thrusts, and wide sweeping cuts are used. The three principal parries are the "head" (or "high prime") with horizontally held blade; the "tierce," on the right, parrying cuts at the left side of the head and body; and the "quarte," on the opposite side.

The modern style of fencing with the light sabre was perfected in Italy during the last quarter of the 19th century, the most important pioneer in its development having been G. Radaelli, a Milanese master, who became chief instructor of the sabre in the Royal Italian Military Fencing Academy in 1874, when it was transferred to Milan from Parma. Radaelli's system was described by F. Masiello, an army officer whose works remain the chief authority on the light sabre. An old-time rivalry between the Neapolitan and the northern Italian fencing methods came to a crisis when M. Parise, an expert of the southern school, secured first place for foil-fencing in a tournament instituted by the military authorities, the result being the transfer of the Military Fencing Academy to Rome under the title of *Scuola Magistrale di Roma*. There was, however, less difference between the two schools in sabre than in foil play, and the Radaelli system for the former was so generally esteemed that a master of that method was established at the Roman Academy.

The light fencing-sabre is made up of two principal parts, the blade and the handle. The blade, from 33½ to 34 in. long and slightly and gradually curved from hilt to point (which is truncated), has the tongue, or tang, which runs through the handle; the heel, or thick uppermost part of the blade fitting on to the guard; the edge, running from heel to point; the back-edge or false-edge (sometimes not allowed), running from the point along the back for about 8 in.; and the back, running from point to heel (unless there is a back-edge). The blade is fluted on both sides from the heel where the back-edge begins. The handle consists of the guard, of thin metal, extending from the pommel to the heel of the blade, to protect the hand; the grip (of wood, fish-skin, or leather, often backed with metal), shaped to fit the hand, through which the tongue of the blade passes; and the pommel, or knob, a button which finishes off the handle and holds the tongue in place.

The recognition of the light fencing-sabre as a practice weapon only, related to the heavier military sword as the foil is to the duelling-sword, at once makes apparent the difference between the play of the two cut- and thrust-weapons. As a light cut with the military sabre will be of little advantage in battle, however prettily delivered, it is evident that in order to produce a shock of impact sufficient to put an adversary out of action, a wide sweeping movement with the sword (*moulinet*; Ital. *molinelli*) is necessary. With the fencing-sabre a hit is a hit if properly delivered with the edge or point, however light it may be. For hits of this kind less force is necessary, and wide *moulinets* are not only useless but dangerous, since in making them the point must for a moment be directed away from the opponent, and momentary openings are thus left of which the opponent may take advantage by attacks on the preparation. For this reason the cuts of the Radaelli school are delivered with *moulinets* of very narrow radius, made as much as possible by a movement of the elbow only, keeping the point directed menacingly towards the opponent. Again, whereas in battle a wound on any part of the person may be effective and the school of the heavy sabre has to reckon with this fact, in fencing with the light sabre no hit lower than the hips counts, although hits upon any part of the person above the hips are good; in England cuts on the outside of the thigh are allowed. This somewhat narrows the scope of the fencing-sabre, just as the scope of the foil is narrower than that of the duelling-sword.

The military sword is, on account of its weight, usually held firmly in the hand with the thumb overlapping the fingers; but in holding the light sabre the thumb is placed on the flat of the grip, giving a perfect command over the movements of the blade, called by the Italians *pasteggio*. Both attacks and parries are executed as narrowly as possible, avoiding the wide movements common in heavy sabre-play, and the *moulinets* (which are ellipses described by the point as it is drawn back for a cut)

are made, not by swinging the sword round the head, but by drawing back the hand held in front of the body, and with the point directed forward. The thrusts with the light sabre are made with the thumb to the left; whereas in the French school it is turned down, so that the blade curves upward. The modern school allows no such parries as the "St. George," in executing which the blade is held at right angles to the body, but teaches that the point should always be directed towards the adversary as much as possible. The attacks are either "simple," "complex" or "secondary," and bear a general resemblance to those in foil-fencing (*q. n.*); simple attacks being such as are not preceded by other movements, as feints; complex attacks those preceded by feints, advances, or some other preliminary manoeuvre; and secondary attacks those carried out while the adversary is himself attacking or preparing to attack. The parries also correspond in nomenclature, and generally in nature, to those used in foil-play, but no circular or counter-parries are taught, though sometimes employed.

Terms used in Sabre-Fencing.—"Absence of the blade": a guard so wide as apparently to leave the body uncovered, so as to entice the adversary to attack. "Appuntata" (Fr. *remise*): a supplementary cut or thrust after the failure of an attack, when the adversary replies slowly or with a feint. "Assault" (Ital. *assalto*), a regular bout. "Attacks on the blade" (see below under "beat," "disarmament," "graze" and "press"). "Beat" (Ital. *batuta*): a hard dry stroke on the adversary's blade, in order to drive it aside and push home an attack; a "re-beat" is made by beating lightly on one side, then dropping the point quickly under the adversary's blade and beating violently on the other side. *Cavazione* (see below under "disengage"). "Completion" (see below under *riposte*). "Controtempo": to parry an attack in such a manner that the adversary is hit at the same time. "Deceive the blade": when the adversary attempts an "attack on the blade" to avoid contact by a narrow circular movement of the point and hand; this is generally followed by a straight thrust or cut, as the force of his blow will carry his blade wide and leave an opening. "Development" (attacks on the blade): attacks made while the adversary is making a complex attack. "Line" consisting of at least two movements (feint and real attack). *Disarmiento* (see below under "press"). "Disarmament" (Ital. *sforzo*): striking the adversary's weapon from his hand by means of a sweeping stroke along his blade from the point downwards. "Disengage" (Ital. *cavazione*): being on guard (engaged) in one line, to draw one's point under the adversary's sword and lunge on the other side: to avoid a cut by retiring the right foot behind the left; a time-cut at the adversary's arm is usually made at the same time. "Graze" (Ital. *filo*): to run one's blade along that of the adversary and push home the attack suddenly. "Invitation guard": a guard in any line with the blade intentionally so wide that the adversary lunges into the apparent opening, only to meet a prepared counter. *Incontro* (Ital. for double-hit): both fencers attacking at the same instant. "Lines" (of engagement): the four quarters into which the trunk is divided, attacks and parries opposite them being called after them. These are, with the hand held in "supination" (thumb on top of sabre-grip): upper right, "sixte"; upper left hand, "quarte"; lower right "octave" (not used in sabre); lower left "half-circle" (not used in sabre). When the hand is held in "pronation" (thumb down) the lines are: upper right, "tierce"; upper left, "prime"; lower right, "seconde"; lower left, "low prime" ("seconde" generally used). *Quinte* and *septime* are also lines of the Italian school. "Lunge": the advance of the body by stepping forward with the right foot in order to deliver a cut or thrust. "Opposition": pressing the hand and blade in attack towards the side the adversary's blade is on; the object being to occupy his blade and cover one's person from a "riposte." "Press": forcing the adversary's blade aside by a sudden push in order to create an opening for an attack, either directly or on the same side after he has recovered his blade and parried too wide on his supposed threatened side. "Preparation" (attacks on the blade): mostly made by "deceiving" when the adversary attempts a beat, graze or press. "Re-beat" (see "beat"). "Remise" (see "appuntata"). "Riposte": a quick cut or thrust made after parrying an attack, without lunging. When the riposte in its turn is parried and replied to with another riposte, the French call this second riposte the *lac-au-tou*. "Sforzo" (see "disarmament"). *Scandaglio*: studying an opponent's style at the beginning of a bout. "Stop-thrust": a direct thrust made as the adversary begins a complex attack, i.e. one of more than one movement. The stop-thrust must get home palpably before the adversary's attack or the attack alone is counted, the rule of scoring being that he who is attacked must take the parry. "Time-cut": a quick slash at the adversary's arm as he begins a complex attack. *Tocatot*: Ital. for "hit!" *Touché*: French for "hit!"

Manchette-Fencing (Fr. *manchette*, a cuff) is a variety of sabre-play popular in Germany, in which the fencers stand at such a

distance from each other that only hand and fore-arm can be reached with the last few inches of the sword nearest the point, both edges being supposed to be sharp. No thrusts are allowed, and both feet must remain stationary where they are planted when the bout begins. Narrow parries are necessary, though many cuts are avoided by withdrawing the hand. Manchette-fencing is not considered good practice for the light sabre and is therefore losing ground.

The German Basket-Sabre (*Krummer Säbel*, or *Krummsäbel*) is a descendant of the heavy cavalry sabre once in use in some branches of the German horse. It is now used almost exclusively by students. It has a strongly curved blade about 32 in. long and 1 in. broad, tapering slightly towards the end, which is truncated, no thrusts being allowed. The hand is protected by a large guard of heavy steel basket-work, and the handle is shaped to fit the hand, the forefinger being run through a leather loop. On account of the great weight of the weapon (about 2½ lb. more than half of which is in the guard) blows delivered with a full swing are impracticable, and all cuts are made from the elbow and wrist, the hand being generally kept as high as possible. The *Mensur* is the distance at which the combatants stand from one another. There are three recognized distances, that in general use being the middle, from which two sabres can be crossed at about 15 in. from the points. Neither combatant may move his left foot (the right in the case of a left-handed fencer) from the position in which it is placed at the beginning of the bout, all advances and retreats being made by the movements of the right foot and the body. The position of the engagement is in high tierce, the arm being held straight out towards the adversary. The feet are planted about 24 in. apart, the right in advance. The right shoulder is bent forward and the stomach drawn back, imparting a slight stoop to the fencer. There are eight cuts and as many parries. The basket-sabre is used in the more serious students' duels; the neck, wrist, armpits and body below the nipples being heavily bandaged.

Rapier-fencing among the students of the German universities and technical high-schools of Germany, Austria, Switzerland and Russia may be considered under the sabre, as the rapier, although originally used for thrusting as well as cutting, is now employed by students only to cut. According to the association of German fencing-masters the modern weapon when blunt and used only for practice is called *Rapier* or *Haurapier*, but when sharpened for duelling, *Schläger* (striker). It is derived from the long straight sword of the German *Reiters*, or light cavalry, who were famous in the 16th century and later. Its use, however, was only occasional before the middle of the 19th century, when it gradually took the place of the dangerous *Pariser*, or long French small-sword, for the semi-serious duels (*Mensuren*) of the students. There are two varieties of rapier, each having a thin flat blade about 33½ in. long and ⅞ in. wide and truncated at the point, but distinguished by the shape of the handle. The bell-rapier (*Glockenrapier*), used only at the north German universities of Leipzig, Berlin, Halle, Breslau, Königsberg and Greifswald, is furnished with a guard consisting of a cup or bell of iron about 4½ in. in diameter and 2 in. deep, joined to the pommel by a steel shaft protecting the hand. Its total weight is about 1¼ lb. The basket-rapier (*Korbapier*), used at all universities except those named above, has a handle protected by a sort of basket of heavy steel wire. Its total weight is 2 lb. The balance is just below the guard. The blade of the rapier is divided conventionally into the *forte*, the half next the hilt, and the *foible*. These are again divided into full and half *forte* and full and half *foible*, the half *foible* being the weakest quarter of the blade, nearest the point. Every bout, whether with sharp or blunt weapons, is preceded by the command *Auf die Mensur!* (on the mark, literally distance). The two fencers take position with feet apart and the right slightly in advance just far enough from one another to allow their heads to be reached by the sword without moving the feet, which remain firm during the entire bout. During the first half of the 19th century the objective points of the rapier included the upper arm and breast; but later the head, including the face, became

the sole target. In practice a heavy mask of wire with fork top, a glove with padded arm-piece (*Stulpe*) and a padded apron to protect body and legs are worn. There is one defensive position, which is with the arm stretched upward bringing the hand and hilt about 6 in. in front of and above the forehead, and the point of the rapier directed diagonally downward across the body and to the outside of the adversary's knees. The fencers having at the command *Bindet die Klängen!* (Join blades!) placed their hilts together with the points of the rapiers directed upwards, attack simultaneously at the command *Los!* (Go!). All blows are delivered from the wrist, slightly helped by the forearm, the hand never being dropped below the level of the eyes. No movement of the head or body is allowed except such as is unavoidably connected with that of the sword-arm.

BIBLIOGRAPHY.—For the light sabre see *La Scherma italiana di spada e di sciabola*, by Ferdinando Masiello (Florence, 1887); *Infantry Sword Exercise* (British War Office, London, 1896), practically the system of Masiello; *Istruzione per la scherma*, &c., by S. de Frate (Milan, 1885); *La Scherma per la sciabola*, by L. Barbasetti (Vienna, 1898); a German translation of the foregoing, *Das Säbel-fechten* (Vienna, 1899); *Die Fechtkunst*, by Gustav Hergsell (Vienna, 1892). For the old-style sabre see *Cold Steel*, by Alfred Hutton (London, 1899); *Broadsword and Singlestick*, by R. G. Allanson Winn and C. Phillips Welby. "All England" series (London, 1898); *Foil and Sabre*, by L. Rondelle (Boston, 1892), an exposition of the French military system. For sabre-fencing for cavalry see *The Cavalry Swordsman*, by Alfred Hutton (London, 1867); *L'Escri-mo du sabre à cheval*, by A. Alessandri and Emile André (Paris, 1895). For German basket-sabre and schläger, *Die deutsche Hiebfecht-schule für Korb- und Glockenrapier* (Leipzig, 1887), published by the association of German academic fencing-masters; *L'Escri-mo dans les universités allemandes*, &c., by L. C. Roux (Paris, 1885), a French exposition of the German student fencing. (E. B.)

SABZAWAR, a town of Afghanistan, situated at an elevation of 3550 ft. on the left bank of the river Harud, 93 m. S. of Herat. Sabzawar was once a city of considerable size, and still possesses a fortress with sides of about 200 or 250 yds. This fortress has been abandoned, and the town, which is the centre of a group of villages, is now fairly prosperous, with a bazaar of about 800 shops and a busy traffic with Seistan. The plains about Sabzawar are highly cultivated by the Nurzai, Duranis, and each village boasts its own little mud fort.

SABZEVAR, a district of the province of Khorasan in Persia, formerly called Baihak. It is situated between Nishapur on the east and Shahrud-Bostam on the west, and has a length of about 80 m. and a breadth of 50; its population is about 60,000, and it pays to the government a yearly revenue of £8000. The district has many flourishing villages and much cultivation; it produces much wool, excellent cotton, some silk, partly exported to Russia, and partly manufactured into various stuffs in the district, and fruits, exported dried in large quantities. The export trade is chiefly done by a few Russian Armenians who reside in Sabzevar town.

SABZEVAR, the capital of the district, is situated 150 m. E. of Shahrud and 65 m. W. of Nishapur, in 36° 12' N., 57° 30' E., at an elevation of 3100 ft. The population, which was 30,000 before the famine in 1871, is now about 15,000. There are some good caravanserais, a well-supplied bazaar, three colleges, two large and thirty small mosques, and post and telegraph offices.

SACCHARIC ACID, C₆H₁₀O₈ or HO₂C[CH(OH)]₂CO₂H, in chemistry, a tetroxydicarboxylic acid which exists in three stereoisomeric forms. The ordinary or dextro (*D*)-saccharic acid is formed in the oxidation of cane sugar, grape sugar, *D*-gluconic acid and many other carbohydrates with nitric acid. It forms a deliquescent mass. On standing, the syrupy acid gives the crystalline lactic acid, C₆H₈O₇. Sodium amalgam reduces it to gluconic acid, C₆H₁₂O₆ or OHC[CH(OH)]₂CO₂H, whilst hydriodic acid reduces it to adipic acid, HO₂C[CH₂]₂CO₂H, whilst acetic acid oxidizes it to dextro-tartaric acid and oxalic acid. Laevo (*L*)-saccharic acid is formed by oxidizing *L*-gluconic acid with nitric acid, whilst the inactive (*D*+*L*)-acid is obtained similarly from inactive gluconic acid. These acids closely resemble the *D* acid except in their action on polarized light. For their relations

to the glucoses see SUGAR. Mucic acid (*q.v.*) is isomeric with these acids.

SACCHARIN, the name given to several distinct chemical substances. The saccharin of commerce, so named from its excessively sweet taste, is a coal-tar product, being the imide of ortho-sulphobenzonic acid, $C_6H_4 \begin{matrix} \diagup CO \\ \diagdown SO_2 \end{matrix} NH$. It may be prepared by the oxidation of ortho-toluenesulphonamide $CH_3 \cdot C_6H_4 \cdot SO_2NH_2$, with potassium permanganate (C. Fahlberg and I. Remsen, *Ber.*, 1879, 12, p. 469); by the electrolytic oxidation of the above sulphonamide (German patent 35211); by the action of concentrated sulphuric acid on ortho-sulphamidobenzonic acid, $NH_2 \cdot SO_2 \cdot C_6H_4 \cdot CO_2H$ (German patent 113720); by warming the chloride of ortho-sulphobenzonic acid phenyl ester ($SO_2Cl \cdot C_6H_4 \cdot CO_2 \cdot C_6H_5$) with excess of aqueous ammonia (R. List and M. Stein, *Ber.*, 1898, 31, p. 1662); and from benzaldehyde ortho-sulphonic acid by conversion into its acid chloride, which with ammonia yields the corresponding acid-amide, which gives saccharin on oxidation with atmospheric oxygen (German patent 90488). It is a crystalline powder which melts at 220° C. with partial decomposition. It is soluble with difficulty in cold water, but is moderately soluble in hot water and readily soluble in alcohol. By the action of concentrated hydrochloric acid at 150° C. it is decomposed into ammonia and ortho-sulphobenzonic acid. With phosphorus pentachloride above 200° C. it yields orthochlorintrobenzene. Sodium saccharin, $C_6H_4(CO) \cdot (SO_2) \cdot N \cdot Na$, $2H_2O$, is used under the name of "soluble saccharin" or "crystallose," and is readily soluble in hot water. The ammonium salt is named "sucramine." Saccharin is largely used for sweetening purposes, pure saccharin being 500 times sweeter than sugar. Until 1891 the commercial product contained about 40% of the tasteless para compound and was only 300 times as sweet as sugar; the mixture, however, is now separated by dissolving out the saccharin with xylene, in which solvent the para compound is insoluble. Saccharin is used as a sugar substitute for diabetic patients. It is interesting to note that *o*-sulphobenzonic acid has an acid taste, and the sulphamide is tasteless; the sweetness of saccharin therefore appears to be connected with the formation of a cyclic anhydride. In the United Kingdom there is an import duty of 1s. 3d. per oz. on saccharin and similar products, and manufacturers have to take out a licence. In the United States the import duty is \$1.50+10% *ad valorem* per lb. Austria-Hungary, France, Belgium and Germany prohibit the importation. On the estimation of saccharin in commercial samples and for its detection in foods and beverages see J. H. Kastle, *Jour. Chem. Soc.*, 1905, 87, p. 503; E. M'K. Chace, *Jour. Amer. Chem. Soc.*, 1904, 39, p. 1627.

The lactones of the saccharic acids are also known as "saccharins." By boiling dextrin or laevulose with milk of lime the so-called "saccharin," a lactone of the formula,

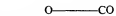

is obtained (E. Péligot, *Ber.*, 1880, 13, p. 196; H. Kiliani, *Ber.*, 1882, 15, p. 2954). It crystallizes in large prisms, has a bitter taste, and is easily soluble in hot water. Potassium permanganate oxidizes it to carbonic and acetic acids. Heating with caustic potash to 200° C. gives formic and lactic acids, and when reduced by hydriodic acid and phosphorus it is converted into α -dimethylbutyrolactone. "Iso-saccharin" and "meta-saccharin" are formed by the action of lime on milk sugar (H. Kiliani, *Ber.*, 1885, 18, p. 631). The former melts at 95° C., and on reduction by hydriodic acid and phosphorus is converted into α -dimethylvalerolactone. Meta-saccharin melts at 141-142° C. and is easily soluble in water.

SACCHETTI, FRANCO (c. 1335-c. 1400), Italian poet and novelist, was the son of Benci di Ugucione, surnamed "Buono," of the noble and ancient Florentine family of the Sacchetti (comp. Dante, *Par. c. xvi.*), and was born at Florence about the year 1335. While still a young man he achieved repute as a poet, and he appears to have travelled on affairs of more or less importance as far as Genoa, Milan and "Ischiavona." When a sentence of banishment was passed upon the rest of the house of Sacchetti by the Florentine authorities in 1380 it appears that Franco was expressly exempted, "per esser tanto uomo buono," and in 1383 he was one of the "eight," discharging the office of "prior" for the months of March and April. In 1385

he was chosen ambassador to Genoa, but preferred to go as podestà to Bibbiena in Casentino. In 1392 he was podestà of San Miniato, and in 1396 he held a similar office at Faenza. In 1398 he received from his fellow-citizens the post of captain of their then province of Romagna, having his residence at Portico. The date of his death is unknown; most probably it occurred about 1400, though some writers place it as late as 1410.

Sacchetti left a considerable number of *sonnets, canzoni, ballate, madrigali*, &c., which have never been printed, but which are still extant in at least one MS. in the Laurentian library of Florence. His *Novelle* were first printed in 1724, from the MS. in the same collection, which, however, is far from complete. They were originally 300 in number, but only 258 in whole or in part now survive. They are written in pure and elegant Tuscan, and, based as they are for the most part on real incidents in the public and domestic life of Florence, they are valuable for the light they throw on the manners of that age, and occasionally also for the biographical facts preserved in them.

SACCHI, ANDREA (c. 1600-1661), Italian painter of the later Roman school, was born at Nettuno near Rome in 1600, or perhaps as early as 1598. His father, Benedetto, a painter of undistinguished position, gave him his earliest instruction in the art; Andrea then passed into the studio of Albani, of whom he was the last and the most eminent pupil, and under Albani he made his reputation early. The painter of Sacchi's predilection was Raphael; he was the jealous opponent of Pietro da Cortona, and more especially of Bernini. In process of time he became one of the most learned designers and one of the soundest colourists of the Roman school. He went to Venice and to Parma to study Venetian colour and the style of Correggio; but he found the last-named master unadaptable for his own proper methods in art, and he returned to Rome. Sacchi was strong in artistic theory, and in practice slow and fastidious; it was his axiom that the merit of a painter consists in producing, not many middling pictures, but a few and perfect ones. His works have dignity, repose, elevated yet natural forms, severe but not the less pleasing colour, a learned treatment of architecture and perspective; he is thus a painter of the correct and laudable academic order, admired by connoisseurs rather than by ambitious students or the large public. His principal painting, often spoken of as the fourth best easel-picture in Rome—in the Vatican Gallery—is "St Romuald relating his Vision to Five Monks of his Order." The pictorial *crux* of dealing with these figures, who are all in the white garb of their order, has often been remarked upon; and as often the ingenuity and judgment of Sacchi have been praised in varying the tints of these habits according to the light and shade cast by a neighbouring tree. The Vatican Gallery contains also an early painting of the master—the "Miracle of St Gregory," executed in 1624; a mosaic of it was made in 1771 and placed in St Peter's. Other leading examples are the "Death of St Anna," in S Carlo ai Catinari; "St Andrew," in the Quirinal; "St Joseph," at Capo alle Case; also, in fresco, a ceiling in the Palazzo Barberini—"Divine Wisdom"—reckoned superior in expression and selection to the rival work of Pietro da Cortona. There are likewise altarpieces in Perugia, Foligno and Camerino. Sacchi, who worked almost always in Rome, left few pictures visible in private galleries: one, of "St Bruno," is in Grosvenor House. He had a flourishing school: Nicholas Poussin and Carlo Maratta were his most eminent scholars; Luigi Garzi and Francesco Lauri were others, and Sacchi's own son Giuseppe, who died young, after giving very high hopes. This must have been an illegitimate son, for Andrea was unmarried when he died at Nettuno in 1661.

SACCHINI, ANTONIO MARIA GASPARE (1734-1786), Italian musical composer, was born at Pozzuoli, on the 23rd of July 1734. He was the son of a poor fisherman and was heard singing on the sands by Durante, who undertook his education at the Conservatorio di Sant' Onofrio at Naples. Durante and Piccini taught him composition, and Nicola Fiesenza the violin. The intermezzo *Fra Donato* was written for the theatre of the Conservatorio in 1756, but his first serious opera was produced at Rome in 1762, and was followed by many others, nearly all of which were successful. In 1769 he went to Venice, and in consequence of the great success achieved there by the

production of his opera *Alessandro nell' Indie* he was appointed director of the Conservatorio dell' Ospedaletto, where he trained some admirable female singers and wrote church music. In 1772 he visited London, where, notwithstanding a cruel cabal formed against him, he achieved a brilliant success, especially in his four new operas, *Tamerlano*, *Lucio Vero*, *Nitteti e Perseo* and *Il Gran Cid*. Later he met with an equally enthusiastic reception in Paris, where in 1783 his *Rinaldo* was produced under the immediate patronage of Queen Marie Antoinette, to whom he had been recommended by the emperor Joseph II. But neither in England nor in France did his reputation continue to the end of his visit. He seems everywhere to have been the victim of bitter jealousy. Even Marie Antoinette was not able to support his cause in the face of the general outcry against the favour shown to foreigners; and by her command, given with the utmost reluctance, his last opera and undoubted masterpiece, *Edipe à Colone*, was set aside in 1786 to make room for Lemoine's *Phèdre*—a circumstance which so preyed upon his mind that he died of chagrin on the 7th (or 8th) of October 1786.

Sacchini's style was rather graceful than elevated, and he was deficient both in creative power and originality. But the dramatic truth of his operas, more especially the later ones, is above all praise, and he never fails to write with the care and finish of a thorough and accomplished musician. *Edipe* was extremely successful after his death, and was performed at the Académie nearly six hundred times.

SACERDOTALISM (from Lat. *sacerdos*, priest, literally one who presents sacred offerings, *sacer*, sacred, and *dare*, to give), a term applied, usually in a hostile sense, to the system, method and spirit of a priestly order or class, under which the functions, dignity and influence of the members of the priesthood are exalted in the ministry of religion, and in the church at the expense of the laity. This exalting of the priesthood in the Christian church is based on the claim that the priest exercises sacerdotal and supernatural powers in the celebration of the Eucharist.

SACHEVERELL, HENRY (1674-1724), English ecclesiastic and politician, was the son of Joshua Sacheverell, rector of St Peter's, Marlborough. He was adopted by his godfather, Edward Hearst, and his wife, and was sent to Magdalen College, Oxford, in 1689, was demy of his college from 1689 to 1701 and fellow from 1701 to 1713. Addison, another Wiltshire lad, entered at the same college two years earlier, but was also elected a demy in 1689; he inscribed to Sacheverell in 1694 his account of the greatest English poets. Sacheverell took his degree of B.A. in 1693, and became M.A. in 1695 and D.D. in 1708. His first preferment was the small vicarage of Cannock in Staffordshire; but he leapt into notice when holding a preaching at St Saviour's, Southwark. His famous sermons on the church in danger from the neglect of the Whig ministry to keep guard over its interests were preached, the one at Derby on the 15th of August, the other at St Paul's Cathedral on the 5th of November 1709. They were immediately reprinted, the latter being dedicated to the lord mayor and the former to the author's kinsman, George Sacheverell, high sheriff of Derby for the year; and, as the passions of the whole British population were at this period keenly exercised between the rival factions of Whig and Tory, the vehement invectives of this furious divine on behalf of an ecclesiastical institution which supplied the bulk of the adherents of the Tories made him their idol. The Whig ministry, then slowly but surely losing the support of the country, were divided in opinion as to the propriety of prosecuting this zealous parson. Somers was against such a measure; but Godolphin, who was believed to be personally alluded to in one of these harangues under the nickname of "Volpone," urged the necessity of a prosecution, and gained the day. The trial lasted from 27th February to 23rd March 1710, and the verdict was that Sacheverell should be suspended for three years and that the two sermons should be burnt at the Royal Exchange. This was the decree of the state, and it had the effect of making him a martyr in the eyes of the populace and of bringing about the downfall of the ministry. Immediately on the expiration of his sentence (13th April 1713) he was instituted to the valuable

rectory of St Andrew's, Holborn, by the new Tory ministry, who despised the author of the sermons, although they dreaded his influence over the mob. He died at the Grove, Highgate, on the 5th of June 1724.

See Hearne's *Diaries*, Bloxam's *Register of Magdalen* and Hill Burton's *Queen Anne*, vol. ii. There is an excellent bibliography by Falconer Madan (1887).

SACHEVERELL, WILLIAM (1638-1691), English statesman, son of Henry Sacheverell, a country gentleman, was born in 1638. His family had held a good position in Derbyshire and Nottinghamshire since the 12th century, the name appearing as Sent Cheveroll in the roll of Battle Abbey, and William inherited large estates from his father. He was admitted at Gray's Inn in 1667, and in 1670 he was elected member of parliament for Derbyshire. He immediately gained a prominent position in the party hostile to the Court, and before he had been six months in the House of Commons he proposed a resolution that all "popish recusants" should be removed from military commands; the motion, enlarged so as to include civil employment, was carried without a division on the 28th of February 1672-1673. This resolution was the forerunner of the Test Act, in the preparation of which Sacheverell took an active part, and which caused the break up of the cabal. He now took part in nearly every debate in the House of Commons, being recognized as one of the most able of the leaders of the opposition or country party. He strongly opposed the king's policy of alliance with France, advocating a league with the Dutch instead, and the refusal of supplies until the demands of the Commons should be complied with. Sacheverell took especial interest in the state of the navy and spoke in many debates on this question. In 1677 he carried an address to the king calling upon him to conclude an alliance with the United Provinces against Louis XIV., and when the Speaker adjourned the House by Charles's order Sacheverell made an eloquent protest, asserting the right of the House itself to decide the question of its adjournment. When parliament met early in 1678 assurances were received from Charles II. that he had arranged the treaties demanded by the Commons; but Sacheverell boldly questioned the king's good faith, and warned the Commons that they were being deceived. When the secret treaty with France became known, thus confirming Sacheverell's insight, the latter called for the disbandment of the forces and advocated the refusal of further supplies for military purposes; and in June 1678 he resolutely opposed Lord Danby's proposal to grant £300,000 per annum to Charles II. for life. Barillon mentions Sacheverell among the Whig leaders who accepted bribes from Louis XIV., but the evidence against him is not conclusive.

When Titus Oates began his pretended revelations in 1678 Sacheverell was among those who most firmly believed in the existence of a Popish plot. He was one of the most active investigators of the affair, and one of the managers of the impeachment of the five Catholic peers. He also acted for a time as chairman of the secret committee of the Commons, and drew up the report on the examination of the Jesuit Coleman, secretary to the duchess of York. He was a member of the committee for drafting the articles of impeachment against Danby in 1678, and was appointed one of the managers of the Commons; and in 1679, when the impeachment, interrupted by the dissolution of parliament, was resumed in the new parliament, he spoke strongly against the validity of Danby's plea of pardon by the king. The allegations made in Sacheverell's report on the examination of Coleman prompted the country party to demand the exclusion of James, duke of York, from the succession to the throne, the first suggestion of the famous Exclusion Bill being made by Sacheverell on the 4th of November 1678 in a debate—"the greatest that ever was in Parliament," as it was pronounced by contemporaries—raised by Lord Russell with the object of removing the duke from the King's Council. He vigorously promoted the bill in the House of Commons and opposed granting supplies till it should pass. When Charles offered an alternative scheme (1679) for limiting the powers of a Catholic sovereign, Sacheverell made a great speech in which he pointed out the

insufficiency of the king's terms for securing the object desired by the Whigs. In the conflict between the Petitioners and the Abhorers he supported the former, and on the 27th of October 1680 brought forward a motion asserting the right of petitioning the king to summon parliament, and proposed the impeachment of Chief Justice North as the author of the proclamation against tumultuous petitioning. Sacheverell was one of the managers on behalf of the Commons at the trial of Lord Stafford in Westminster Hall; but took no further part in public affairs till after the elections of March 1681, when he was returned unopposed for Derbyshire. He was prosecuted for riot in connexion with the surrender of the charter of Nottingham in 1682, being tried before Chief Justice Jeffreys, who fined him 500 marks.

At the general election following the death of Charles II. in 1685 Sacheverell lost his seat, and for the next four years he lived in retirement on his estates. In the convention parliament summoned by the prince of Orange, in which he sat for Heytesbury, he spoke in favour of a radical resettlement of the constitution, and served on a committee, of which Somers was chairman, for drawing up a new constitution in the form of the Declaration of Right; and he was one of the representatives of the Commons in their conference with the peers on the question of declaring the throne vacant. William III. appointed Sacheverell a lord of the admiralty, but he resigned the office after a few months. He procured the omission of Lord Jeffreys's name from the Act of Indemnity. In 1690 he moved a famous amendment to the Corporation Bill, proposing the addition of a clause—the purport of which was misrepresented by Macaulay—for disqualifying for office for seven years municipal functionaries who in defiance of the majority of their colleagues had surrendered their charters to the Crown. A celebrated debate on this question took place in the House of Commons in January 1690; but the evident intention of the Whigs to perpetuate their own ascendancy by tampering with the franchise contributed largely to the Tory reaction which resulted in the defeat of the Whigs in the elections of that year. Sacheverell was elected member for Nottinghamshire; but he died on the 9th of October 1691, before taking his seat. In the judgment of Speaker Onslow, Sacheverell was the "ablest parliament man" of the reign of Charles II. He was one of the earliest of English parliamentary orators; his speeches greatly impressed his contemporaries, and in a later generation, as Macaulay observes, they were "a favourite theme of old men who lived to see the conflicts of Walpole and Pulteney." Though his fame has become dimmed in comparison with that of Shaftesbury, Russell and Sidney, he was not less conspicuous in the parliamentary proceedings of Charles II.'s reign, and he left a more permanent mark than any of them on the constitutional changes of the period.

Sacheverell was twice married. His first wife was Mary, daughter of William Staunton of Staunton; and his second was Jane, daughter of Sir John Newton. His eldest son Robert represented the borough of Nottingham in six parliaments and died in 1714. The family became extinct in 1724.

BIBLIOGRAPHY.—Many of Sacheverell's speeches are reported in Anchtell Grey's *Debates of the House of Commons, 1607-1604* (10 vols., London, 1769). See also Sir George Sitwell, *The First Whig* (Scarborough, 1894); Gilbert Burnet, *History of my own Time* (6 vols., Oxford, 1833); Sir John Reesby, *Memoirs, 1639-1689*, edited by J. J. Cartwright (London, 1878); Roger North, *Autobiography*, edited by A. Jessopp (London, 1887); and *Lives of the Right Hon. F. North, Baron Grafton*, &c. (3 vols., London, 1826); *The Hatton Correspondence*, edited by E. M. Thompson for the Camden Society (2 vols., London, 1878); Laurence Eachard, *History of England* (3 vols., London, 1707-1718); and the *Histories of England* by Lingard, Von Ranke and Macaulay. (R. J. M.)

SACHS, HANS (1494-1576), German poet and dramatist, was born at Nuremberg on the 5th of November 1494. His father was a tailor, and he himself was trained to the calling of a shoemaker. Before this, however, he received a good education at the Latin school of Nuremberg, which left behind it a lasting interest in the stories of antiquity. In the spring of 1500 he began his apprenticeship, and was at the same time initiated into the art of the Meistersingers by a weaver, Leonhard Nunnenpeck. In 1511 he set out on his *Wanderjahre*, and worked

at his craft in many towns, including Regensburg, Passau, Salzburg, Munich, Osnabrück, Lübeck and Leipzig. In 1516 he returned to Nuremberg, where he remained during the rest of his life, working steadily at his handiwork and devoting his leisure time to literature. In 1517 he became master of his guild and in 1519 married. The great event of his intellectual life was the coming of the Reformation; he became an ardent adherent of Luther, and in 1523 wrote in Luther's honour the poem beginning *Die wittenbergisch Nachtigall, Die man jetzt höret überall*, and four remarkable dialogues in prose, in which his warm sympathy with the reformer is tempered by counsels of moderation. In spite of this, his advocacy of the new faith brought upon him a reproof from the town council of Nuremberg; and he was forbidden to publish any more *Büchlein oder Reimen*. It was not long, however, before the council itself openly threw in its lot with the Reformation. After the death of Hans Sachs's first wife in 1560 he married again. His death took place on the 19th of January 1576.

Hans Sachs was an extraordinarily fertile poet. By the year 1567 he had composed, according to his own account, 4275 *Meisterlieder*, 1700 tales and fables in verse, and 208 dramas, which filled no fewer than 34 large manuscript volumes; and this was not all, for he continued writing until 1573. The *Meisterlieder* were not printed, being intended solely for the use of the Nuremberg Meistersinger school, of which Sachs was the leading spirit. His fame rests mainly on the *Spruchgedichte*, which include his dramatic writings. His "tragedies" and "comedies" are, however, little more than stories told in dialogue, and divided at convenient pauses into a varying number of acts; of the essentials of dramatic construction or the nature of dramatic action Sachs has little idea. The subjects are drawn from the most varied sources, the Bible, the classics and the Italian novelists being especially laid under contribution. He succeeds best in the short anecdotal *Fastnachtsspiel* or Shrove-tide play, where characterization and humorous situation are of more importance than dramatic form or construction. Farces like *Der fahrende Schüler im Paradies* (1550), *Das Wildbad* (1550), *Das heiss Eisen* (1551), *Der Bauer im Fegfeuer* (1552) are inimitable in their way, and have even been played with success on the modern stage.

Hans Sachs himself made a beginning to an edition of his collected writings by publishing three large folio volumes (1558-1561); after his death two other volumes appeared (1578, 1579). A critical edition has been published by the Stuttgart *Literarischer Verein*, edited by A. von Keller and E. Goetze (23 vols., 1870-1866); *Sämtliche Fastnachtsspiele*, ed. by E. Goetze (7 vols., 1880-1887); *Sämtliche Fabeln und Schwänke*, by the same (3 vols., 1893). There are also editions of selected writings by J. Tittmann (3 vols., 1870-1871; new ed., 1883-1885) and B. Arnold (2 vols., 1885). See E. K. J. Lützelberger, *Hans Sachs* (1876); C. Schweitzer, *Étude sur la vie et les œuvres de Hans Sachs* (1887); K. Drescher, *Hans Sachs-Studien* (1890, 1891); E. Goetze, *Hans Sachs* (1891); A. L. Siefel, *Hans Sachs-Forschungen* (1894); R. Gené, *Hans Sachs und seine Zeit* (1894; 2nd ed., 1902); E. Geiger, *Hans Sachs als Dichter in seinen Fastnachtsspielen* (1904).

SACHS, JULIUS VON (1832-1897), German botanist, was born at Breslau on the 2nd of October 1832. At an early age he showed a taste for natural history, and on leaving school he became, in 1851, private assistant to the physiologist J. E. Purkinje at Prague. In 1856 he graduated as doctor of philosophy, and then adopted a botanical career, establishing himself as *Privatdozent* for plant physiology in the university of Prague. In 1859 he was appointed physiological assistant to the Agricultural Academy of Tharandt in Saxony; and in 1861 he was called to be director of the Polytechnic at Chemnitz, but was almost immediately transferred to the Agricultural Academy at Poppelsdorf, near Bonn, where he remained until 1867, when he was nominated professor of botany in the university of Freiburg-im-Breisgau. In 1868 he accepted the chair of botany in the university of Würzburg, which he continued to occupy (in spite of calls to all the important German universities) until his death on the 29th of May 1897.

Sachs achieved distinction as an investigator, a writer and a teacher; his name will ever be especially associated with the great development of plant physiology which marked the latter half of the 19th century, though there is scarcely a branch of

botany to which he did not materially contribute. His earlier papers, scattered through the volumes of botanical journals and of the publications of learned societies (a collected edition was published in 1892-93), are of great and varied interest. Prominent among them is the series of "Keimungsgeschichten," which laid the foundation of our knowledge of microchemical methods, as also of the morphological and physiological details of germination. Then there is his resuscitation of the method of "water-culture," and the application of it to the investigation of the problems of nutrition; and further, his discovery that the starch-grains to be found in chloroplasts are the first visible product of their assimilatory activity. His later papers were almost exclusively published in the three volumes of the *Arbeiten des botanischen Instituts in Würzburg* (1871-88). Among these are his investigation of the periodicity of growth in length, in connexion with which he devised the self-registering auxanometer, by which he established the retarding influence of the highly refrangible rays of the spectrum on the rate of growth; his researches on heliotropism and geotropism, in which he introduced the "clinostat"; his work on the structure and the arrangement of cells in growing-points; the elaborate experimental evidence upon which he based his "imbibition-theory" of the transpiration-current; his exhaustive study of the assimilatory activity of the green leaf; and other papers of interest. Sachs' first published volume was the *Handbuch der Experimentalphysiologie der Pflanzen* (1865; French edition, 1868), which gives an admirable account of the state of knowledge in certain departments of the subject, and includes a great deal of original information. This was followed in 1868 by the first edition of his famous *Lehrbuch der Botanik*, by far the best book of its kind. It is a comprehensive work, giving an able summary of the botanical science of the period, enriched with the results of many original investigations. The fourth and last German edition was published in 1874, and two English editions were issued by the Oxford Press in 1875 and 1882 respectively. The *Lehrbuch* was eventually superseded by the *Vorlesungen über Pflanzenphysiologie* (1st ed., 1882; 2nd ed., 1887; Eng. ed., Oxford, 1887), a work more limited in scope, but yet covering more ground than its title would imply; though it is a remarkable book, it has not gained the general recognition accorded to the *Lehrbuch*. Finally, there is the *Geschichte der Botanik* (1875), a brilliant and learned account of the development of the various branches of botanical science from the middle of the 16th century up to 1860, of which an English edition was published in 1890 by the Oxford Press. As a teacher Sachs exerted great influence, for his vigorous personality and his ready and lucid utterance enabled him not only to instruct, but to fire his students with something of his own enthusiasm.

A full account of Sachs' life and work was given by Professor Goebel, formerly his assistant, in *Flora* (1897), of which an English translation appeared in *Science Progress* for 1898. There is also an obituary notice of him in the *Proc. Roy. Soc. vol. lxiii.* (S. H. V.*)

SACHS, MICHAEL (1808-1864), German Rabbi. He was one of the first of Jewish graduates of the modern universities, taking his Ph.D. degree in 1836. He was appointed Rabbi in Prague in 1836, and in Berlin in 1844. He took the conservative side against the Reform agitation, and so strongly opposed the introduction of the organ into the Synagogue that he retired from the Rabbinate rather than acquiesce. Sachs was one of the greatest preachers of his age, and published two volumes of Sermons (*Predigten*, 1866-1891). He co-operated with Zunz (*g.v.*) in a new translation of the Bible. Sachs is best remembered for his work on Hebrew poetry, *Religiöse Poesie der Juden in Spanien* (1845); his more ambitious critical work (*Beiträge zur Sprach- und Alterthumsforschung*, 2 vols., 1852-1854) is of less lasting value. His poetical gifts he turned to admirable account in his translation of the Festival Prayers (*Mahzor*, 9 vols., 1855), a new feature of which was the metrical rendering of the medieval Hebrew hymns. Another very popular work by Sachs contains poetical paraphrases of Rabbinic legends (*Stimmen vom Jordan und Euphrat*, 1853). (I. A.)

SACK, a large bag made of a coarse material such as is described under **SACKING** below. The word occurs with very little variation in all European languages, cf. Gr. *sákcos*, Lat. *saccus*, Fr. *sac*, Span. *saco*, Du. *sak*, &c. All are borrowed from the Hebrew *sag*, properly a coarse stuff made of hair, hence a bag made of this material. Most etymologists attribute the widespread occurrence of the word to the story of Joseph and his brethren in Gen. xiv. The Hebrew word itself is probably Egyptian, as is evidenced by the Coptic *sok*. Apart from its ordinary meaning, the word is used as a unit of dry measure, which has varied considerably at different times and places and for different goods; it is the customary British measure for coals, potatoes, apples and some other goods, and is equivalent to three bushels. From the end of the 17th to the middle of the 18th century the sack or "sacque" was a fashionable type of gown for women, having a long flowing loose back—hanging in pleats from the neck. It is still used as a tailor's or dressmaker's term for a loose straight-back coat. The Fr. *sac* meant also pillage, plunder, whence *saccager*, to plunder a town, especially after it had been taken by assault or after a siege. There is no doubt that it is an extension of "sack," a bag, with a reference to the most obvious receptacle for booty. The slang expression "to give the sack," "to get the sack," of a person who has been turned out of a situation or been given notice to leave is an old French proverbial expression. Cotgrave gives *On luy a donné sa sac et ses quilles*, "he hath his passport given him, he is turned out to grazing, said of a servant whom his master hath put away." The *New English Dictionary* finds the expression also in 15th-century Dutch.

It remains to distinguish the name, familiar from English literature of the 16th and 17th centuries, of a Spanish wine, which was of a strong, rough, dry kind (in Fr. *vin sec*, whence the name), and therefore usually sweetened and mixed with spice and mulled or "burnt." It became a common name for all the stronger white wines of the South.

SACKBUT, SHAKBUSHE, SAGBUT, DRAW or DRAWING TRUMPET (Scotland, *draucht trumpet*) or FLAT TRUMPET (Fr. *saquebute*, *saqueboute*, *cacbuco*, *trompette harmonique*; Ger. *Possane*, *Busaun*, *Pusin*, *Zug-Trommet*; Ital. *tromba da tirarsi* or *tromba spessata*; Span. *sacabuche*; Dutch *basuin* 'Schuiftrumpette'), the earliest form of slide trumpet, which afterwards developed into the trombone. As soon as the effect of the slide in lengthening the main tube and therefore proportionally deepening the pitch of the instrument was understood, and its capabilities had been fully realized, the development of a family of powerful tenor and bass instruments followed as a matter of course. It is not known exactly in what country the principle of the slide was first discovered and applied to musical instruments; if it be not an Oriental device, then the credit is probably due to the Netherlands or to South Germany before or during the 13th century.

The early history of the sackbut is among the most interesting of all instruments. Various attempts have been made to fix the etymology of the word as derived from Span. *sacabuche* through French. The Rev. F. W. Galpin¹ suggests a derivation from *sacar*, to draw out, and *buche*, identical with *bücha* (Lat. *bucens*), used in the sense of a tube or pipe originally of boxwood. To accept this etymology would be to lose sight of the fact that all the technical names applied to the sackbut in various languages directly acknowledge its descent from the buccina (*g.v.*), with the exception of Italian, in which the recognition is indirectly made through the synonym *tromba*. A clue to the etymology of *sacabuche* is afforded by the well-known fact that not only did the Arabs after the conquest introduce oriental musical instruments by way of Spain to western Europe, but the Arabic names also clung to the instruments in many cases. The Arabs had a military trumpet they called *Buk* or *Bugue*, a word they had borrowed from the Christians,² and it is mentioned in a musical treatise of the 14th century (Escorial MS. 69) among the musical instruments then in use in Spain. It has been claimed on philological grounds that England derived her knowledge of the sackbut from France, but the oldest known form of the word in English is *shakbushe*, which occurs in the accounts of Henry VII.

¹ "The Sackbut, its Evolution and History," in *Proc. Mus. Assoc. London* (1906-1907).

² See Edw. W. Lane, *Arabic-English Lexicon* (London, 1863), bk. i. pt. i. p. 276.

for the 3rd of May 1495,¹ and is obviously of Spanish origin. Sackbut appears early in the 16th century.

The word *sacabuche* was at some time applied in Spain to the ship's pump; and the questions naturally arise, Which came first, and was the musical instrument named after the pump from the great resemblance in their respective actions as well as in outward form?² It is certainly significant that the Ital. *tromba*, from which sprang "trumpet" "trombone," means a pump as well as a trumpet and the trunk of an elephant. Even if it could be proved beyond doubt that the slide had been applied to the trumpet before the word *tromba* was used for it, there would still remain several difficulties to be disposed of. (1) The word *tromba*, *trumbin*, *trompe*, already general in the romances of the 12th and 13th centuries, was at first applied to the tubas and curved horns, probably from the similar curve of the elephant's trunk. (2) If *tromba* referred to the pump, it must have been applied to the slide trumpet, and *tromba da tirato* for "sackbut" is senseless tautology. (3) The etymology given above from *buk* or *bugue*, trumpet, supported by similarly compounded words in English, Scotch, Dutch, Italian, would have to be regarded as a strange but not unparalleled philological coincidence. The earliest instance yet discovered of the use of *sacabuche* as a musical instrument seems to be in the 14th century.³

The transformation of the busine (*buccina*) into the sackbut involved two or three processes, the addition of the slide being accomplished in at least two stages. It was applied first to the straight busine made in three or four sections having rings or knobs at the joints. The sliding portions or joints here doubtless served much as in our modern wood wind instruments for tuning purposes or for changing the key. The long slide, added for the purpose of obtaining a diatonic compass, denoted a further step in the evolution. When applied to the straight busine it differed materially from the slide of the sackbut or trombone, for the normal position of the instrument was with the slide fully drawn out, so that the knobs were equidistant; on the slide being gradually closed the pitch was proportionally raised in order to fill in the gaps of the first fifth by new fundamentals, upon each of which the harmonic series would be obtainable. An example of this early use of the slide is to be found in a miniature from a psalterium executed in the south of France during the 13th century, now preserved in the library of the university of Munich (MS. 24, 4to fol. 96b). Here (fig. 1) the performer is represented on a busine in which two of the knobs or rings denoting the joints or sections are shown touching each other. The hand is grasping the instrument just under the lower ring in the act of pushing it up to close the slide, as indicated by the position of the wrist. This is the earliest indication of the existence of the slide yet found by the writer, and the instrument, although straight, is one of the earliest sackbuts. The manipulation of the slide on the long straight busine must have been exceedingly difficult, requiring not only skill, but a long arm. This led to the next step in the evolution, i.e. the bending of the tube in three parallel branches like a flattened S, an example of which, also of the 13th century, is found on some carved woodwork from the abbey of Cluny.⁴



FIG. 1.

The folding of the busine marks the advent of the new double slide, like a U, made to draw out and lower the pitch. This radical change did not come all at once, the intermediate step being the folding of the busine, with the old single slide, the whole S being drawn up and down as the slide closed and opened again. This interesting development is shown (fig. 2) in a miniature by Taddeo Crivelli in the Borso Bible⁵ (1450-1471). The two upper joints defined by rings are clearly drawn of larger calibre than the lower folded portion, which has been drawn out to what would approximately correspond to the third position on the trombone lowering the pitch one tone. A single slide would require to be extended about twice the distance of the double or folded tube on the trombone to produce any given effect. This drawing of the sackbut must not be taken as showing the instrument in use in Crivelli's day; it is clearly retrospective for sackbuts in a more advanced stage are not uncommon in works of art of the same century. In a MS.⁶ preserved in the library of the Arsenal in Paris, executed for the dukes of Burgundy in the middle of the 15th century, is seen a trumpet of

the cavalry type with a single straight slide drawn out so far that the bell rests on the performer's foot (fig. 3).

The last transition immediately preceding the change into the trombone consisted in folding the tube to form two U-shaped bends, one of which pointed downwards and the other over the shoulder, reaching to the level of the back of the head; the third branch was bent over between the other two, but in a plane almost at right angles above them, the bell extending downwards beyond the first bend. Sackbuts of this type are to be seen in Dürer's picture in the Nuremberg town hall, and in others by artists of the 15th century, as, for instance, in Gentile Bellini's *Processione in piazza S. Marco* among the band to the right of the picture.



FIG. 2.



FIG. 3.

The further history and development of the sackbut are given under TROMBONE. See also TRUMPET and BUCCINA. (K. S.)

SACKETT'S HARBOR, a village in Jefferson county, New York, U.S.A., at the eastern end of Lake Ontario, on the south shore of Black River Bay, about 1 m. from its mouth, and about 10 m. W. by S. of Watertown. Pop. (1890) 787; (1900) 1266; (1905) 903; (1910) 868. Sackett's Harbor is served by the New York Central & Hudson River railway. It is built on low land, around a small, nearly enclosed harbour, the northern shore of which is formed by Navy Point, a narrow tongue of land extending about $\frac{1}{2}$ m. nearly due eastward from the mainland. About 1 m. to the W. by S. is Horse Island, approximately $\frac{1}{2}$ m. long (east and west), and nearly as broad, only a few feet above the lake level and separated from the mainland by a narrow strait, always fordable, and sometimes almost dry; at its eastern end is Sackett's Harbor Lighthouse. The harbour is deep enough for the largest lake vessels. The village is a summer resort. At Sackett's Harbor are Madison Barracks, a United States military post, established in 1813 and including a reservation of 99 acres; and a United States Naval Station. In the post cemetery is the grave of General Zebulon B. Pike, who was killed at York (now Toronto) on the 27th of April 1813.

The first settlement was made in 1801 by Augustus Sackett, and the village was incorporated in 1821. In the War of 1812 Sackett's Harbor was an important strategic point for the Americans, who had here a naval station, Fort Tompkins, at the base of Navy Point, and Fort Volunteer, on the eastern side of the harbour. In July 1812 a British squadron unsuccessfully attempted to capture a brig and schooner in the harbour. From Sackett's Harbor American expeditions against York (now Toronto) and Fort George respectively set out in April and May 1813; though scantily garrisoned it was successfully defended by General Jacob Brown (who had just taken command) against an attack, on the 29th of May, of Sir George Prevost with a squadron under Sir James Lucas Yeo. The British losses were 250; the American 157, including Lieut.-Colonel Eleuctus Backus, commander of the garrison before General Brown's arrival. Almost all the American stores at the naval station were destroyed to save them from the enemy. The blockade of the harbour by Yeo was abandoned in June 1814, after the defeat of a force from the squadron sent out to capture guns which were being brought from Oswego to Sackett's Harbor to equip the "Superior," an American vessel launched on the 1st of May, and a smaller vessel nearly completed. Sackett's Harbor was the starting-point of a force of 700 men under a Pole named von Schultz, who in November 1838, during the uprising in Upper Canada (Ontario) attempted to invade Canada, was taken prisoner near Prescott, was tried at Kingston, being defended by Sir John Macdonald, and with nine of his followers was executed in Kingston in December.

¹ See W. H. Black, Sir N. H. Nicolas, etc., *Excerpta historica* (London, 1833), p. 102.

² This question has been thoroughly investigated by the late Professor George Case in his work on the trombone.

³ See Felipe Pedrell, *Organografía musical. antigua española*, p. 116.

⁴ Illustration in Du Sommerard, *Les Arts au moyen âge*, Atlas, pl. i. ch. xii.

⁵ See Hermann Julius Hermann, "Zur Gesch. d. Miniaturmalerei am Hofe der Este in Ferrara," in *Jahrb. d. Kunsthinst. d. allerhöchsten Kaiserhauses* (Vienna, 1900), bd. xxi, pl. xlii.

⁶ Illustration in Du Sommerard, *op. cit.*, album, 4^e série, pl. xvii.

See A. T. Mahan, *Sea-Power in its Relation to the War of 1812* (2 vols., Boston, 1905); and William Kingsford, *The History of Canada*, vol. VIII. (Toronto, 1895).

SACKING AND SACK MANUFACTURE. Sacking is a heavy closely-woven fabric, originally made of flax, but now almost exclusively made of jute or of hemp. The more expensive kinds, such as are used for coal sacks, for government and other vessels, are made of hemp, but the jute fibre is extensively used for the same purpose, and almost entirely for coal sacks for local house supplies. The same type of fabric is used for wool sacks, cement bags, ore bags, pea sacks and for any heavy substance; it is also made up into a special form of bag for packing cops and rolls of jute and flax yarns for delivery from spinners to manufacturers. Proper sacking is essentially a twilled fabric, in which the number of warp threads per inch greatly exceeds the number per inch of weft. The illustration shows a typical kind of three-leaf twill, double warp sacking.

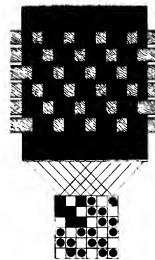

All three-leaf twill sackings are double in the warp, but four-leaf sackings are single. They are usually 27 in. wide, but other widths are made.

The lower part of the illustration shows four repeats of the three-leaf twill, while the lines drawn to the plan of the fabric show that each line of the design is reproduced in the cloth by two warp threads. The weft is single, but each one is usually about four times the weight of the warp for the same length (about 8 lb warp and 32 lb weft). Large quantities of cotton sacks are made for flour, sugar and similar produce; these sacks are usually plain cloth, some woven circular in the loom, others made from the piece.

Large quantities of seamless bags or sacks for light substances are woven in the loom, but these are almost invariably made with what is termed the double plain weave, i.e. the cloth, although circular except at the end, is perfectly plain on both sides. Circular bags have been made both with three-leaf and four-leaf twills, but it is found much more convenient and economical to make the cloth for these kinds, and in most cases for all other types, in the piece, and then to make it up into sacks by one or other of the many types of sewing machines. The pieces are first cut up into definite lengths by special machinery, which may be perfectly automatic, or semi-automatic—usually the latter, as many thicknesses may be cut at the same time, each of the exact length. The lengths of cloth are then separately doubled up, the sides sewn by special sewing machines of the Laine or Union make (of which there are seven or eight different kinds for different types of bags), and the ends hemmed. It will thus be seen that the length required is twice the length of the sack plus the amount for hemming the mouth.

The sack is now ready for delivery, unless the name of the owner, some trade mark, or other particulars are required to appear on it. These particulars are printed on in one or more colours by the Kimmond and Kidd patent multicolour sack-printing machine.

The chief centres for these goods are Dundee and Calcutta, all varieties of sacks and bags being made in and around the former city. (T. Wo.)

SACKVILLE, GEORGE, 1ST VISCOUNT (1716-1785), generally remembered as Lord George Sackville or Lord George Germain, third son of Lionel Cranfield Sackville, 1st duke of Dorset, was born on the 26th of January 1716. Educated at Westminster School and Trinity College, Dublin, he was gazetted captain in the 7th Cathcart's Horse (now 6th Dragoon Guards) in 1737, and three years later was transferred to Bragg's regiment of foot (Gloucestershire Regiment) as lieutenant-colonel; immediately afterwards the regiment sailed for active service on the Rhine, and although it was not present at the battle of Dettingen, its lieutenant-colonel was made brevet colonel and aide-de-camp to the king. It was not until two years later that Sackville took part in his first battle, Fontenoy. Wounded in the charge of

Cumberland's infantry column, he was taken to the tent of King Louis XV. to have his wound dressed. Released, by what means does not appear, he was sent home to serve against the Pretender in Scotland. He was given the colonelcy of the 20th (Lancashire Fusiliers), but was too late to take part in the battle of Culloden. In 1747-1748 he was again with the duke of Cumberland in the Low Countries, and in 1749 was transferred to the cavalry, receiving the colonelcy of the 7th (3rd) Irish Horse (Carabiniers). With this office he combined those of first secretary to his father, the lord-lieutenant of Ireland, and Irish secretary of war, and a seat in each of the two Houses of Commons at Westminster and Dublin, winning at the same time the repute of being "the gayest man in Ireland except his father." In 1755 he was promoted major-general, took an English command, and vacated his Irish offices. In 1757 he was made lieutenant-general of the ordnance, and transferred to a fourth colonelcy. In 1758, under the duke of Marlborough, he shared in the ineffective raid on Cancale Bay, and the troops, after a short sojourn in the Isle of Wight, were sent to join the allied army of Duke Ferdinand of Brunswick in Germany. Marlborough died shortly after they landed, and Sackville succeeded him as commander-in-chief of the British contingent. But no sooner had he taken over the command than his haughty and domineering temper estranged him both from his second-in-command, Lord Granby, and the commander-in-chief, Prince Ferdinand. This culminated on the day of Minden (August 1, 1758). The British infantry, aided by some of the Hanoverians, had won a brilliant success, and every man in the army looked to the British cavalry to charge and to make it a decisive victory. But Sackville, in spite of repeated orders from Prince Ferdinand, sullenly refused to allow Granby's squadrons to advance. The crisis passed, and the victory remained an indecisive success. Popular indignation was unbounded, and Sackville was dismissed from his offices. But his courage, though impugned, was sufficient to make him press for a court-martial, and a court at last assembled in 1760. This pronounced him guilty of disobedience, and adjudged him "unfit to serve his Majesty in any military capacity whatsoever." The sentence was executed with gratuitous harshness. It was read out on parade to every regiment in the service, with a homily attached, and placed on record in every regimental order book. Further, it was announced in the Gazette that his Majesty had expunged Sackville's name from the roll of the Privy Council. This, and Sackville's own dogged perseverance, turned the scale in his favour. No reverses to the British arms occurred to keep alive the memory of his lost opportunity, and in 1763 his name was restored to the list of the Privy Council. Hitherto without party ties in parliament, in 1769 he allied himself with Lord North. To this period belong the famous Junius Letters, with the authorship of which Sackville was erroneously credited. In 1770, under the terms of a will, he assumed the name of Germain. In the same year his coolness and courage in a duel with Captain George Johnstone, M.P., assisted to rehabilitate him, and in 1775, having meantime taken an active part in politics, he became secretary of state for the colonies in the North cabinet. Thus, though still standing condemned as unfit for any military employment, he exercised a powerful and unfortunate influence on the military affairs of the nation. Some of the business of the war department in those days fell to the colonial office, and Germain was practically the director of the war for the suppression of the revolt in the American colonies. What hopes of success there were in such a struggle Germain and the North cabinet dissipated by their misunderstanding of the situation and their friction with the generals and the army in the theatre of war. But this failure was not on the same footing as that of Minden, and in spite of virulent party attacks, King George III., on the resignation of the North ministry, offered him a peerage. Sackville, in characteristic fashion, stipulated for a viscounty, as otherwise he would be junior to his secretary, his lawyer and to Amherst, who had been page to his father. There was some opposition to his taking his seat in the House of Lords. But his health was failing and he withdrew from politics, spending his last years as a benevolent and autocratic country magnate. He died at

Stoneland Lodge (Buckhurst Park), Sussex, on the 26th of August 1785.

SACKVILLE, MORTIMER SACKVILLE-WEST, 1ST BARON (1820-1888), was descended from Sir Richard Sackville, a Kentish gentleman, and a cousin of Ann Boleyn. A member of parliament and courtier under Henry VIII, Richard Sackville became chancellor of the court of augmentations in 1548 and was knighted in 1549. He amassed a great deal of wealth, and Sir Robert Naunton said his name should be "fill-sack," rather than "Sack-ville." He was on friendly terms with Roger Ascham, whom he advised to write his *Scholemaster*. In 1604 his son Thomas was created earl of Dorset, and from him the earls and dukes of Dorset (*q.v.*) of the Sackville family were descended.

Mortimer Sackville-West was a younger son of George John Sackville-West, 5th Earl de la Warr (See DE LA WARR): his mother, Elizabeth, Baroness Buckhurst, being a daughter of John Frederick Sackville, 3rd duke of Dorset. When in 1873 his elder brother, Reginald Windsor, became 7th Earl de la Warr, Mortimer succeeded by arrangement to the extensive estates of the Sackvilles, including Knole Park, their beautiful Kentish residence, which had come to his family through his mother. In 1876 he was created Baron Sackville of Knole, and died on the 1st of October 1888.

His brother, LIONEL SACKVILLE-WEST (1827-1908), succeeded as 2nd baron. He had a long career in the diplomatic service. From 1872 to 1878 he was ambassador to the Argentine Republic; from 1878 to 1881 he represented his country at Madrid, and from 1881 to 1888 at Washington. His retirement was due to an unfortunate interference in American domestic politics, or what was taken as such, which caused some stir. He died in September 1908 and was succeeded by his nephew Lionel Edward (b. 1867) as 3rd baron. By a Spanish dancer, Josefa Duran de Ortega, known also as Pepita de Oliva, Mr Sackville-West, as the 2nd baron then was, had several children, and soon after his death one of these, calling himself Ernest Henri Jean Baptiste Sackville-West, claimed to be a lawful son and his father's heir. He asserted that between 1863 and 1867 Sackville-West had married his mother. The case came before the English courts of law in 1909-1910, and it was decided that the children of this union were all illegitimate, as Pepita's husband, Jean Antonio Gabriel de Oliva, was alive during the whole period of his wife's connexion with Sackville-West.

SACO, a city of York county, Maine, U.S.A., on the Saco river, and the Atlantic Ocean, opposite Biddeford, with which it is connected by bridges, and 14 m. S.W. of Portland. Pop. (1890), 6075; (1900) 6122 (903 foreign-born); (1910) 6583. It is served by the Boston & Maine railway, and is connected with Portland by an electric line. The actual municipal limits include an area of about 40 sq. m., but much of this is sparsely settled, and the centre of settlement, or city proper, is about 5 m. above the mouth of the Saco. The city has a public park (Pepperell Park) of 30 acres, the Dyer Library (1790), containing in 1908 16,000 volumes, and York Institute (established in 1866 and incorporated in 1867), with a library of 5000 volumes in 1908; and is the seat of Thornton Academy (co-educational), incorporated in 1811, opened in 1813, but closed during 1848-1889 after the burning of the old building. Old Orchard Beach, in the vicinity, extending along the shore front of the township of Old Orchard (pop. in 1900, 964) and part of the shore fronts of Saco and Scarborough, is a popular summer resort; in August 1907 nearly all the hotels were burnt, but others have since been built. At Saco the river falls about 55 ft. and provides excellent water-power. The city's principal manufactures are cotton goods and cotton-mill machinery. Saco was settled as early as 1631, and was the seat of the Gorges government from 1636 to 1653, when it passed under the jurisdiction of Massachusetts. Until 1762 Saco and Biddeford formed one town or plantation—until 1718 under the name of Saco, and from 1718 to 1762 under the name of Biddeford. In 1716 Sir William Pepperell acquired title to the principal part of what is now Saco, in 1752 this was made a separate parish, and ten years later

it was incorporated as a separate township under the name of Pepperellboro. In 1779 the Pepperell property was confiscated as that of a loyalist, and in 1805 the name of the township was changed to Saco. In 1867 Saco was chartered as a city.

SACRAMENT, in religion, a property or rite defined in the Anglican catechism as "an outward and visible sign of an inward and spiritual grace"; if the grace be allowed to be inherent in the external symbolic thing or act as well as in the faithful who receive or do it, this definition holds good not only for the Latin Church, but for more primitive religions as well. In the Greek Church the equivalent word is *μυστήριον*, a mystery, a usage which is explained below.

The Latin word *sacramentum* originally meant any bodily or sensible thing, or an action, or a form of words solemnly endowed with a meaning and purpose which in itself it has not. Thus the money deposited by each of two litigants in a sacred precinct or with a priest, was called a sacrament. The winner of the suit got back his deposit, but the loser forfeited his to the god or to the winning party. In Livy it signifies the oath (*q.v.*) which soldiers took among themselves not to run away or desert. Pliny uses it similarly of the oath by which the Christians of Bithynia bound themselves at their solemn meetings not to commit any act of wickedness. Tertullian (*c.* 160-240) uses it in both senses, of an oath, as in the passage of his treatise *About Spectacles*, where he says that no Christian "passes over to the enemy's camp without throwing away his arms, without abandoning the standards and sacraments of his chief." In the treatise *To the Nations*, i. 16, he speaks of "the sacraments of our religion," intending, it would appear, the love-feast and Eucharist. So in the *Apology*, ch. vii., he speaks of "the sacrament of infanticide and of the eating of a murdered child and of incest following the banquet," the crimes of which the Christians were commonly accused. In the work *Against Marcion*, iv. 34, he speaks of the sacrament of baptism and Eucharist. In the work against the Jews, ch. xi., he speaks of the letter *Tau* set in ink on the foreheads of the men of Jerusalem (*Ezek. ix. 4*) as "the sacrament of the sign," *i.e.* of the cross; and in chap. xiii. of the same work he dwells on the sacrament of the wood prefigured in 2 Kings vi. 6. The *stick* with which Elisha made the iron to swim in that passage, and the wood which Isaac carried up the mountain for his own pyre "were sacraments reserved for fulfilment in the time of Christ." In other words they were types, things which had a prophetic significance. In the same work, chap. x., he speaks of "the Sacrament of the Passion foreshadowed in prophecies." In his work *On the Soul*, chap. xviii., the aeons and genealogies of the Gnostics are "the sacraments of heretical ideas." In the work *About the Crown*, chap. iii., he describes how the faithful "take the sacrament of the Eucharist also in their meetings held before dawn." Elsewhere he speaks of "the sacraments of water, oil, bread." In the work *Against Valentiniens*, chap. xxxix., he speaks of the "great sacrament of the name," here rendering the Greek word *μυστήριον*, mystery. In the tract *On Monogamy*, chap. xi., he speaks of "the sacrament of monogamy." Elsewhere he talks of the "sacrament of faith," and "of the Resurrection," and "of human salvation," and "of the Pascha," and "of unction," and "of the body of Christ." Later Latin fathers use the word with similar vagueness, *e.g.* Augustine speaks of the salt administered to catechumens before baptism and of their exorcism as sacraments; and as late as 1120 Godefrid so calls the salt and water, oil and chrism, the ring and pastoral staff used in ordinations. But by this time the tendency was in the West to restrict the sense of the word. Thus Isidore Hispalensis, *c.* 630, in his book of *Origins*, vi. 19, recognized as sacraments baptism and the chrism, and the Body and Blood, and he writes thus: "Under the screen of corporeal objects a divine virtue of the sacraments in question secretly brings about salvation; wherefore they are called sacraments from their secret or sacred virtues." Bernard (*In coen. Dom.* § 4, op. ii. 88) calls the rite of washing feet a sacrament, because without it we have no portion with Christ (John xiii. 8), and therefore it is necessary to salvation. Hugo de St Victor, *c.* 1120, in his work *On the*

Sacraments, distinguishes six, but of different grades of importance. The two principal ones necessary to salvation are baptism and the Eucharist; then come the water of aspersion and the wearing of cinders, and so forth; these advance a man in sanctity. Lastly come those needful to the hallowing and instituting of other sacraments, those which concern the conferring of orders or of monkish habit. In his *Summa* he declares that as there are seven chief sins, either original or of act, so there must be seven sacraments to remedy them; but he only enumerates six, namely baptism and the sacraments of confirmation, of the altar, of penance, last unction and matrimony. Peter Lombard (c. 1150) added as a seventh that of ordination, and to this number the Latin Church adhered at the councils of Florence and Trent. This enumeration was also adopted in 1575 as against the Augustan confession of the year 1540 by Jeremiah Patriarch of Constantinople, and again in a council held in the same city in 1639 to anathematize Cyril Lucar, who with the Anglicans recognized two only, baptism and the Eucharist. It is hardly fair on the strength of these two pronouncements to attribute the doctrine of seven sacraments to the Eastern churches in general; except under a sporadic Latin influence, they have not troubled themselves so to define their number.

In this article it is impossible to attempt a history of the sacraments and of the controversies which in every age have arisen about them. It is enough to formulate a few general considerations of a kind to orientate and guide inquirers. To begin with, it is obvious that the number of sacraments must vary according to the criterions we use of what constitutes a sacrament. The Anglicans recognize baptism and the Eucharist alone, under the impression that Christ ordained these and none other. The Latin doctors by arguments as good as those usually put forth in such controversies have no difficulty in proving that Christ instituted all seven. How, they argue, could Paul (1 Cor. iv. 1) call himself and others "ministers of Christ and stewards of the mysteries of God" unless "the mysteries in question had been directly instituted by Christ. They contend even that extreme unction was so instituted, and that St James in his Epistle did but promulgate it. So Christ instituted confirmation *non exhibendo sed promittendo*, not by undergoing it and so setting it forth in His own person, but by promising to send the Paraclete. The sacrament of confession and penance He equally instituted when He assigned the power of the keys to the Apostles.

The Latin Church, following Gulielmus Antissiodorensis (c. 1215), distinguishes in each sacrament the matter from the form. The matter is the sensible thing which in accordance with Christ's institution can be raised to a sacramental plane. It is, e.g. water with immersion in the case of baptism; bread and wine in the Eucharist; anointing and laying on of hands in confirmation; contrition in the sacrament of penance. The form consists of the words used in the rite, e.g. in penance, of the formula "I absolve thee"; in the Eucharist, of the words "This is my body" and "This is the cup of my blood" or "This is my blood"; in confirmation, of the words "I sign thee with sign of the cross and confirm thee with chrism of salvation in name of Father and Son and Holy Spirit"; in baptism, of the words "I baptize thee in the name of Father, Son and Holy Spirit (or among the Greeks "N. or M. is baptized in the name," &c.). Merely verbal change in these formulae made without prejudicing the sense does not invalidate the sacrament. On the part of the minister or priest officiating must be present also an inward intention or will to do what the Church does. Thus a drunkard's or a madman's sacraments would only be mockery, even though the recipients received them in good faith and devoutly. On the other hand, sanctity of life on the part of the minister is not necessary in order to the validity of the sacraments which he confers, although this was held to be the case by the Donatists in the 4th century, and following them by the Waldensians and Albigenses in the 12th, and by the followers of Hus and Wycliffe in the 14th. The latter enunciated the following rule: "If a bishop or priest be

living in mortal sin, then he neither ordains, nor consecrates, nor baptizes." The Cathars even held it necessary, in case a bishop fell into mortal sin, to repeat his baptisms and ordinations, for they had been vitiated by his sins. On such points the Catholics followed the more sensible course.

Certain of the sacraments can obviously only be once conferred, e.g. baptism, confirmation and orders; but can be conditionally repeated, if there is a doubt of their having been validly conferred. In conditional baptism the Latins, since about the year 1227, use the formula, "If thou art not baptized, then do I baptize thee," &c. The Latins further insist on a strict observance of the traditional matter and form. Thus baptism is not valid if wine or ice be used instead of water, nor the Eucharist if water be consecrated in place of wine, nor confirmation unless the chrism has been blessed by a bishop; also olive oil must be used. The distinction, be it noted, of form and matter seems more appropriate to the sacraments of baptism, Eucharist, confirmation and last unction, than to those of orders, penance and matrimony. The recognition by the Church of the last-named as a sacrament was, in spite of the commendation uttered by Jesus (Mark x. 9), slow and arduous, owing to the encratic enthusiasms of the first generations of believers. In many regions baptism involved renunciation of married life, and for at least the first two hundred years marriage was a civil rite preceding baptism, which was deferred until the age of thirty or even later. Liturgical forms for consecrating marriage are of late development, and the Church took the institution under its protection through outside social pressure rather than of its own will and wish.

In any Latin pontifical or Greek euchologion we find numerous prayers for the consecration, not only of men, but of things. Here is an example of such a petition from the 9th century codex of Heribert, archbishop of Milan: "Be thou graciously pleased by the infusion of the Holy Spirit to strengthen and enhance the substance, of old approved by thee, of this oil here before thee; to the end that whatsoever in the human kind hath been touched therewith may speedily pass to a higher nature, and that the ancient Enemy may not, after anointing with the same, claim aught for himself, but that he may grieve for that he is exposed to the shafts of this blessed engine of defence, and groan because by the oil of peace the swellings of his antique fury are kept down and repressed: through our Lord Jesus Christ," &c.

Or again the following prayer for baptism over the water from the Ethiopic Statutes of the Apostles as translated by the Rev. G. Horner (London, 1904, p. 165): "God, my Lord almighty, who madest heaven and earth . . . who mingledst and unitedst the immortal with the mortal, who madest living man a combination of the two, and gavest to that which was made body a soul also, which thou causest to dwell within: stir this water and fill it up with thy Holy Spirit, that it may become water and Spirit for regeneration to those who are to be baptized: work a holy work and make them to become sons and daughters of thy holy name."

Such petitions as the above are common in the more ancient of the Christian cults, and are all alike inspired by the idea that a spirit or divine virtue can be confined in material objects which are to be brought into contact with or swallowed by men and animals. The same idea pervades old medical treatises; for a drug was not a chemical substance taking effect naturally on the human system, but something into which a supernatural virtue had been magically introduced, in order the more easily and efficaciously to be brought to bear upon the patient. The spirits which take possession of man or animal can equally take possession of a material substance, and even replace the substance, leaving the outward accidents of colour, shape and size unchanged. This primitive belief, termed "animism" by E. B. Tylor, asserts itself everywhere in Christianity; and objects thus invested with spiritual or curative powers are called by the Latin doctors sacramentals. Thus in the *Theologia dogmatica*

¹ *Monumenta veteris liturgie Ambrosianae*, by M. Magistretti and A. Ceriani (Milan, 1897), p. 99.

et moralis of P. M. Belmont, bishop of Claremont (8th ed., Paris, 1899, vol. iii. p. 119) the following definition is given of *sacramentalia*: "Sacramentals are certain things or actions instituted or consecrated by the Church for the production of certain spiritual effects, and sometimes for the obtaining of a temporal effect."

Some of the older authorities, like Caietanus and Soto, taught that sacramentals as above defined have power to produce their effects *ex opere operato*, i. e. by their own inherent virtue; others that they produce them *ex opere operantis*, i. e. through the merit and disposition of the user. But in the latter case, argues M. Belmont, what is the use of the prayers offered up over the substances; and how account for the differences of effects which by the testimony of the faithful are respectively caused by water duly blessed and by water falsely blessed? If the mere state of mind of the person using the water determines the effect, then in the case of both kinds of benediction, the true and the false alike, it would be one and the same. He therefore inclines to the opinion that there is no inherent virtue in sacramentals, but that God is moved by the prayers uttered in their consecration to produce salutary effects in those who use them. Thus he avoids on the one side the *opus operatum* view, and on the other a merely receptionist position.

The consecration of material objects and in general their use in religion and cult was consistently avoided by the Manicheans; not because they failed to share the universal belief of earlier ages that spirits can be inducted by means of fitting prayers and incantations into inanimate things, but because the external material world was held to be the creation of an evil demiurge and so incapable of harbouring a pure spirit. The sacramentals of the great Church were denounced by them as vehicles of the evil one; and this class of prejudice was carried to such a length that some of them eschewed even baptism with water and the sacrament of bread and wine. That they retained the laying on of hands in their spiritual baptism was an inconsistency which their orthodox opponents did not fail to note; the human hand, argued the latter, is, like the rest of the body, no less the work of the evil creator than water, oil, bread and wine, or than the wood, metal and stone out of which altars, images and churches are made. Relics for the same reason were abhorred by the Manicheans; the Catholics defending them on the ground that the bodies of saints participate in a divine virtue and have a power of making men whole and working miracles in the same manner as had the cloak of Elijah (2 Kings ii. 14), or the corpse of Elisha (*ibid.* xiii. 21), the hem of Christ's garment (Matt. ix. 20), Peter's shadow (Acts v. 15), the handkerchiefs or aprons of Paul's body (*ibid.* xix. 12). The Manicheans' answer to such arguments was that miracles worked by Christ and the Apostles in the material world were only apparitional and not real, while those of the Old Testament were satanic.

It has been argued that the sacramental rites of the Christians were largely imitated from the pagan mysteries; but for the first two hundred years this is hardly true, except perhaps in the case of certain Gnostic sects whose leaders intentionally amalgamated the new faith with old pagan ideas and rites. It is true that Gentile converts carried over into the new religion many ideas and habits of cult contracted under the old; this was inevitable, for no one lightly changes his religious habits and categories. For long generations the doctors of the Church fought bravely against such an infusion of heathen customs; thus in Latin countries we find the rule to keep New Year's day as a fast, just because the pagans feasted on it, giving one another gifts (*strenae*, Fr. *étrennes*) and taking omens for the coming year. But in the 4th century this puritanic zeal gave way; and this and other pagan feasts were taken over by the Church; and a similar earlier in Asia Minor Gregory the Thaumaturge was actively transforming into shrines and cult of martyrs the temples and idolatrous rites of heroes and demigods. In proportion as such conversion was facile and rapid, it was probably imperfect.

That baptism is called the Seal (*σφραγίς*), and Illumination (*φωτισμός*) in the 2nd century has been set down to the influence

of the pagan mysteries; but as a matter of fact the former term is a metaphor from military discipline, and the idea conveyed in the latter that *gnosis* or imparting of divine love is an illumining of the soul is found both in the Old and New Testaments. Nor because the pagans regarded the close meetings of the Christians usually held in private houses as mysteries in which incest and cannibalism were rife, does it follow that the Christians themselves accepted the comparison. On the contrary, as a thousand passages in the earlier apologists attest, they viewed the pagan mysteries with horror and detestation. Nor were they so solicitous, as it is pretended, to conceal from the authorities what they did and said in their liturgical meetings. The Christians' of Bithynia were evidently quite frank about them to Pliny (c. 112), and Justin in his Apology reveals everything to a pagan emperor (c. 150). That catechumens could not participate in the *agapē* or love-feast (of which in this epoch the Eucharist was merely an episode) does not give to those feasts the character of a Greek mystery. The uncircumcised proselyte was similarly excluded from the Paschal meal on which the Eucharist was largely modelled, even though it may not have been in any way a continuation of the same. Baptism and the *agapē* took their rise in Palestine, and in their origin certainly owed little or nothing to outside influences. For both there can be found Jewish models, if necessary. The sacred feasts of the Essenes and Therapeutae in particular, as described by Josephus and Philo, closely resembled the Eucharistic *agapē*.

Undeniably Clement of Alexandria and Origen apply the language of the Greek mysteries to Christian *gnosis* and life. "These are," says Clement, "divine mysteries, hidden from most and revealed to the few who can receive them." And Origen compares them to the sacred vessels, and would have them "guarded secretly behind the veil of the conscience and not lightly produced before the public." He who so produces them "dances out the word of the true philosophy,"—a technical description of the profanation of the mysteries. It is not even safe, according to these two fathers, to commit too much to writing; and Clement undertakes not to reveal in writing many secrets known to the initiated among his readers; otherwise the indiscreet eye of the heathen may rest on them, and he will have cast his pearls before swine. But we may discount most such talk in these writers as belletristic pedantry, copied as a rule from Philo of Alexandria, their literary model. In the latter's description of the *Therapeutae* (ed. Mangey, ii. 475) we read how each ascetic had "in his house a room in which in solitude they celebrated the mysteries of the holy life, introducing nothing therein, either to drink or to eat, nor anything else necessary for the uses of the flesh." And in scores of other passages Philo dwells on "the ineffable mysteries" of Jewish faith and allegory. He even writes thus: "O ye initiated ones, with purified sense of hearing, shall ye accept in your souls these truly sacred mysteries, nor divulge them to any of the uninitiated. . . . I have been initiated by Moses the friend of God in the great mysteries." But because he uses the language of the Greek mysteries, Philo never imitated the thing itself; and he is ever ready to denounce it in the bitterest terms. Clement and Origen really meant no more than he. At a later period, however, the difficulty of screening the rites of baptism and Eucharist from the eyes of catechumens and from their ears the creeds and liturgies—a difficulty which had ever been formidable and which after the overthrow of paganism must have become insurmountable—seems to have provoked not only a great outpouring on the part of the Christian rhetors, like Basil, Chrysostom, the Gregories and the Cyrils, of phrases borrowed from the Greek mysteries, but perhaps an actual use of precautions. Thus the bishop of Rome, Julius (c. 340), complained (Athanasius, *Apol. cont. Ariam*, 31, Migne 25, 300) that a court of law had not been cleared of catechumens, Jews and pagans, in a case where the legal discussion introduced the topic of the table of Christ; and the preachers of the 4th and

¹ Perhaps, however, Pliny refers only to the renegades among them.

5th centuries in their discourses often make a point of not citing the creed or describing the Eucharist; they stop short and ejaculate such remarks as *τασσω ο πιστος, norunt fideles* ("the faithful know it"). Such was the *Disciplina arcani*. All will admit who study the post-Nicene Church, that the Christian sacraments have stolen the clothes of the pagan mysteries, dethroned and forbidden by the Christian emperors. The catechuminate, an old institution, older in most regions than the mysteries themselves, suggested and rendered feasible such wholesale theft, especially in an age in which the sacerdotal class wished to be pre-eminent, and left nothing undone to enhance in the eyes of the multitude the importance and solemnity of rites which it was their prerogative to administer. The disappearance, too, of the pagan mysteries must have left a void in many hearts, and the clerics tried to fill it up by themselves masquerading as hierophants.

In the age of the Council of Nice the custom arose of baptizing children of three, because at that age they can already talk and utter the baptismal vows and responses. Not a few homilies of that age survive, denouncing the deferring of baptism, and urging on parents the duty of initiating their young children. Thus there is much evidence to show that long before A.D. 500 child baptism was in vogue. But in that case how can the creed and ritual of baptism, the Lord's Prayer and the Eucharistic formulae, have been kept secret? How can they have been the "awful mysteries," the "dread and terrible canons," the "mystic teachings," the "ineffable sentences," the "oracles too sacred to be committed to writing" which the homilists of that age pretend them to have been? Could our modern freemasons continue to hide their watchwords and ritual, or even make a pretence of doing so, if they were constrained by public opinion to initiate every child three years of age? The thing is absurd. When, therefore, we find such phrases in Greek and Latin homilies of the period of 350 to 550 we must regard them as elaborate make-believe. Because catechumens as well as the faithful were present at the sermons, the preachers thought it becoming to throw them in; but the audience must have been aware that their secrets were open ones.

LITERATURE.—*Theologia dogmatica et moralis ad mentem S. Thomae Aquinatis et S. Alphonsi de Liguorio* (6 vols., Paris, 1899); Gustav Anrich, *Das antike Mysterienwesen* (Göttingen, 1894); L. Duchesne, *Origines du culte chrétien* (Paris, 1898); Joseph Bingham, *Origines ecclesiasticæ* (London, 1834); Adolf Harnack, *Dogmengeschichte* (Freiburg, 1897). (F. C. C.)

SACRAMENTALS (*Sacramentalia*), in the Roman Catholic Church certain acts or ordinances instituted not by Christ, but by the Catholic Church with divine authority. They are believed, in their application to persons and things, to communicate *quasi ex opere operato* through ordained priests the grace of God, consisting in purification, supernatural reinvigoration and sanctification. The term is thus used to cover the rites of dedication, consecration and benediction, and, closely connected with the last-named, exorcism.

SACRAMENTARIANS, the name given to those who during the Reformation controversies not only denied the Roman Catholic "transubstantiation," but also the Lutheran "consubstantiation." They comprised two parties: (1) the followers of Capito, Carlsadt and Bucer, who at the diet of Augsburg presented the *Confessio Tetrapoliana* from Strassburg, Constance, Lindau and Memmingen; (2) the followers of the Swiss reformer Zwingli, who to the same diet presented his private confession of faith. The doctrinal standpoint was the same—an admission of a spiritual presence of Christ which the devout soul can receive and enjoy, but a total rejection of any physical or corporeal presence. After holding their own view for some years the four cities accepted the Confession of Augsburg, and were merged in the general body of Lutherans; but Zwingli's position was incorporated in the Helvetic Confession. It is a curious inversion of terms that in recent years has led to the name Sacramentarians being applied to those who hold a high or extreme view of the efficacy of the sacraments.

SACRAMENTO, the capital of California, U.S.A., and the county-seat of Sacramento county, 91 m. (by rail) N.E. of San

Francisco, on the eastern bank of the Sacramento river, about 61 m. above its mouth, at the point where it is joined by the American. Pop. (1850) 6820, (1870) 26,386, (1900) 29,282, of whom 6723 were foreign-born (1371 Germans, 1293 Irish, 964 Chinese, 655 English, 446 English Canadian and 337 Japanese) and 402 were negroes, (1910, census) 44,696. Land area (1906) 4.49 sq. m. Sacramento is on the direct eastward line to Ogden, Utah, of the Southern (once the Central) Pacific railway (which has its main shops here), the starting point of the Southern Pacific line to Portland, Oregon, the terminus of several shorter branches of the Southern Pacific and on the Western Pacific, which has repair shops here, and it is served by interurban electric railways connecting with places in the Sacramento and San Joaquin valleys. The city is about 200 m. below Red Bluff, the head of river navigation for boats drawing 2 or 2½ ft. of water; for boats drawing 4 to 5 ft. Colusa, 91 m. above Sacramento, is the head of navigation; at low water, vessels drawing 7 ft. of water go up the river to Sacramento. There are two daily steamer lines to San Francisco, besides freight lines.

The city site is level (formerly in many parts 5 ft. below flood-level of the river) and is about 30 ft. above sea-level, and the street plan is rectangular. The business quarter has been filled in, and levees have been built along the Sacramento and American rivers. The climate is mild: the average annual temperature is 60.5° F.; average for winter months, 48.3°; for spring, 59.5°; for summer, 71.7°; for autumn, 61.5°; average rainfall, 19.94 in.; average number of clear days *per annum*, 244. The principal buildings are: a very fine state capitol (cornerstone laid, 1860; completed, 1874) in a wooded park of 35 acres, in which is an Insectary where parasites of injurious insects are propagated; Roman Catholic and Protestant Episcopal cathedrals; the county court-house; the city hall; the public library (in 1908, 41,400 volumes); and the Crocker Art Gallery, which was presented to the city by the widow of Judge E. B. Crocker, one of the founders of the Central Pacific, with an art school and an exhibit of the minerals of the state. There is a state library of 140,000 volumes in the capitol; connected with it are travelling libraries sent out through the rural districts of the state. In Sacramento are the large state printing establishment, in which, in addition to other books and documents, text-books for the entire state school system are printed; the College of the Christian Brothers, Howe's Academy, Atkinson's Business College, St Joseph's Academy, the Stanford-Lathrop Memorial Home for Friendless Girls (1900), under the Sisters of Mercy, two other orphanages, the Southern Pacific Railway Hospital (1868), the Mater Misericordiae Hospital (1895, Sisters of Mercy), Wentworth Hospital, a City Receiving Hospital (1884), the Marguerite Home (for old ladies), the Mater Misericordiae Home (1895, Sisters of Mercy) and the Peniel Rescue Home (1899). Just outside the city limits is the State Agricultural Pavilion, with race track and live-stock exhibition grounds (where the State Agricultural Society holds its annual "State Exposition" in September).

The city has a large wholesale trade. Its prosperity rests upon that of the splendid Sacramento Valley, a country of grain and fruit farms, along whose eastern side lie the gold-producing counties of the state. It is the centre of the greatest deciduous fruit region of California, and shipped about 11,000 car-loads east of the Rocky Mountains in 1909. Sacramento derives electric power from Folsom, on the American river, 22 m. away, and from Colgate, on the Yuba river, 119 m. distant. The manufacturing interests of the city are large and varied: the city's manufactures include flour (1905, value \$1,172,747), lumber, distilled liquors, canned and preserved vegetables and fruits, packed meats, cigars and harness. In 1905 the total value of the factory product was \$10,319,416. In 1909 the assessed valuation of the city was about \$30,400,000, and the bonded indebtedness about \$1,100,000. The city owns its own water system, which has a capacity of 22 million gallons daily, and is a financial success.

In 1839 John Augustus Sutter (1803-1880), a Swiss military

official, was allowed to erect a fort on the then frontier of California, on the present site of Sacramento. He became a Mexican official (1840), and in 1841 obtained from the Mexican government a grant of 11 square leagues of land. Sutter's fort, or "New Helvetia" (a reproduction of which, with a historical museum, in Fort Sutter Park, is one of the objects of interest in the city), was on the direct line of overland immigration from the East, and its position—purposely selected by Sutter with a view to freedom of interference from Mexican officials—made Sutter a man of great importance in the last years of the Mexican régime. After the discovery of gold in 1848, made on Sutter's land, near the present Coloma, about 45 m. E.N.E. of Sacramento, several rival towns were started on Sutter's property near the fort. Of these fortune finally favoured Sacramento—a name already frequently applied to the fort, and adopted for the name of the settlement about its embarcadero or river landing in 1848. The first sale of town lots was in January 1849. Here began the determined movement for the organization of a state government. The extraordinary richness of the placer mines of '49 caused the city to grow with wonderful rapidity. In October 1849 its population was probably 2000, in December 4000 and a year later 10,000. Trouble with land "squatters" almost led to local war in 1850. In 1849 the city offered \$1,000,000 for the honour of being the state capital, which it finally secured in February 1854 (the legislature having already met here once in 1851). Between November 1849 and January 1853 the city was thrice devastated by fearful floods, and it was two-thirds destroyed by fire in November 1852; but though these misfortunes caused a collapse of inflated realty values they did not seriously cripple the city in its development. A city government was organized in August 1849, and in February 1850 this government was incorporated, and in 1863 reincorporated; the city and county governments were consolidated from 1858 to 1863; and a new city charter was received in 1893, coming into effect in 1894. The first local steam railway of California was opened from Sacramento in 1855, and here in 1863 was begun the building of the Central Pacific railway across the Sierras, the first train from the Atlantic coast reaching Sacramento in May 1869. In 1862 there was another flood, the most destructive in the history of the city; since then the measures taken for protection have secured safety from the river. The government of the city in the 'fifties was excessively corrupt and expensive. Progress since the end of the flush mining days has been steady and conservative.

SACRARIUM, the term in classic architecture given to the cella of a temple, and to the apartment in a dwelling-house which was sacred to a deity. In medieval architecture the term is applied on the European continent to that portion of a chancel, which, enclosed with a railing or balustrade in front of the altar, is devoted to the celebration of the Holy Eucharist; this in England is generally known as the presbytery.

SACRED HEART. Devotion to the Sacred Heart of Jesus is a cult peculiar to the modern Roman Catholic Church. The principal object of this devotion is the Saviour Himself. The secondary and partial object is that Heart which was the seat or organ of His love, and which forms the natural symbol thereof. Heart and love are viewed, not physiologically, but in their moral connexion. The chief liturgical expressions of this cult are the institution of a feast of the Sacred Heart and public representations of it by statues and pictures.

Private worship of Christ's heart in particular is of great antiquity in the Church, and is prominent in St. Gertrude and other mystics. It was greatly stimulated in the 17th century by St. Francis of Sales (*q.v.*) who gave this symbol to his Order (the Visitation) as its badge. The Venerable Fr. Eudes must also be mentioned as a great propagator of the devotion, in the same century, and he was the first to obtain a certain public, though only local, authorization of the new pious practices. Blessed Margaret Mary Alacoque (1647–1690), a Visitation nun of Paray-le-Monial, assisted by her director, the Venerable Claude de la Colombière, S.J. (1641–1682), was the instrument of the introduction of the specific worship of the Sacred Heart

into the Church by a decision of the supreme authority, although their work only took effect long after their death. Mary of Modena, the exiled queen of James II., at the instance of the Visitation, petitioned in 1697 for a proper Feast of the Sacred Heart. Neither then, however, nor on the presentation of new petitions in 1726, was an affirmative answer obtained. Meanwhile the chief objection, that of "novelty," was gradually removed by the multiplication of local manifestations, the genuineness of which was proved to the satisfaction of the Roman Congregation of Rights, and in 1765 it was allowed for houses of the Visitation and certain countries. It must be added that this devotion was strongly opposed, not only by the Jansenists, but by others within the Church, under the mistaken idea that the Heart of Christ was viewed in it as separate from the rest of His Being. The formulation of this objection by the synod of Pistoia, in 1786, however, only provoked a clearer explanation of the doctrine, which contributed to confirm the cult. In 1856 Pius IX. introduced the feast into the general calendar of the Roman Catholic Church, fixing the Friday after the Octave of Corpus Christi for its celebration. The Beatification of Blessed M.M. Alacoque in 1864 gave a new impetus to the cause of which she had been the apostle.

See Nic. Nilles, S.J., *De rationibus festorum SS. Cordis Jesu, &c.* (3rd ed., Innsbruck, 1873); E. Letrierce, S.J., *Études sur le Sacré Cœur et la Visitation* (Paris, 1890). These two works contain bibliographical lists. Dalgairns, *The Devotion to the Heart of Jesus* (1855); H. E. Manning, *The Glories of the Sacred Heart* (1876); Jos. Nix, *Cultus SS. Cordis Jesu... cum additamento de cultu purissimi cordis B.V. Mariæ* (2nd ed., Freiburg-i.-B., 1891). (H. B. M.)

SACRIFICE (from Lat. *sacrificium*; *sacer*, holy, and *facere*, to make), the ritual destruction of an object, or, more commonly, the slaughter of a victim by effusion of blood, suffocation, fire or other means. While the Hebrew word *qorban*, makes the killing of the victim the central feature of the ceremony, the Latin word brings out the fact that an act of sacralization (see TABOO) is an essential element in many cases. The sacrifice of desacralization is, however, also found; hence MM. Hubert and Mauss describe a sacrifice as "a religious act, which, by the consecration of a victim, modifies the moral state of the sacrificer or of certain material objects which he has in view," *i.e.* it either confers sanctity or removes it and its analogue, impurity. It is, in fact, "a procedure whereby communication is established between the sacred and profane spheres by a victim, that is to say by an object destroyed in the course of the ceremony." By this definition the term sacrifice is extended to cover the inanimate offering which is consumed by fire, broken or otherwise rendered useless for the purpose of human life.

Theories of Sacrifice.—Explanations of sacrifice, as of other rites, are naturally not wanting among the peoples who have practised or still practise it; but they are often of the nature of aetiological myths and give no clue to the original meaning. Scientific theories date from the second half of the last century, and were originated in the first instance by the English anthropological school.

(a) According to the view put forward by Dr. Tylor, the sacrifice is originally a gift, offered to supernatural beings by man for the purpose of securing their favour or minimizing their hostility. By a natural series of transitions the gift theory became transformed, in the minds of the sacrificers, into the homage theory, which again passed by an easy transition into the renunciation theory. These were, in fact, simply the popular theories of sacrifice put on an evidential basis by facts drawn from various stages of culture.

(b) With W. Robertson Smith, on the other hand, a new era was reached, in which the recently recognized existence of Totemism (*q.v.*) was made the basis of an attempt to give a

¹ Scipione de Ricci, bishop of Pistoia from 1780 to 1791, on the ex-Jesuits requesting him to consecrate a bell dedicated to this object, issued a pastoral letter (3rd June 1784) in which he pointed out that the spirit of true religion was "far removed from fetishism," and warned his flock against "cardiolatry." This pastoral was subsequently in 1786 annexed to the resolutions passed by the reforming synod of Pistoia (*q.v.*), and was condemned with eighty-four other propositions by papal bull in 1794.—Ed.

theory of origins. The first form of his theory distinguishes (i.) honorific, (ii.) piacular and (iii.) mystical or sacramental sacrifices; but the latter type is traced back to the same cycle of ideas as that in which the piacular sacrifice originated. (i.) The essential feature of this type was that the god and his worshippers shared the sacrifice and might thus be regarded as commensals, or table companions. The human commensals were the totem-kin, whom Robertson Smith conceived to have been in the habit of sharing a common meal in daily life, or at least of not mixing with other kins. The object of sharing the meal with the god was to renew the blood bond. The victim was the animal of a hostile totem-kin or an animal commonly offered to the god. The god was originally a stranger, taken into the kin by a rite of blood brotherhood, and this constitutes the dark point of the theory; for Robertson Smith regards the blood bond as relatively late; hence we do not see how the god became associated with the kin. (ii.) The piacular sacrifice arose from the need of atoning for bloodshed within the kinship group; properly speaking, the culprit himself should suffer: should he be unknown or beyond the reach of vengeance, a substitute had to be found. This was naturally found in the non-human member of the totem-kin—the totem animal; in a sense, therefore, the god died for his people. (iii.) In the mystical sacrifice the god is himself slain and eaten by his worshippers. In the *Religion of the Semites* (2nd ed., 1894) the theory was remodelled so as to overcome the difficulty pointed out above. The god, the victim and the human group are regarded as of the same kin; the animal (totem) is the earlier form of the god; the deity was originally female, for under matrilineal rules the mother alone is of kin to her children, but, with the rise of descent in the male line, the god was transformed into a male. The sacrifice is in its origin a communion; god and worshippers have a bond of kinship between them; but it is liable to be interrupted or its strength diminished. Ceremonies of initiation are the means by which the alliance is established between the deity and the young man, when the latter enters upon the rights of manhood; and the supposed bond of kinship is thus regarded as an artificial union from the outset, so far as the individual is concerned, although Robertson Smith still maintains the theory of the fatherhood of the god, where it is a question of the origin of the totem-kin. From the communion sacrifice sprang the *piaculum*, which here becomes a subsidiary form and finds its full explanation in the ideas connected with the mystic union of god and worshippers. For the object of the *piaculum* is the re-establishment of the broken alliance, which was precisely that of the communion sacrifice. With the decline of totemism arose the need for human sacrifice—the only means of re-establishing the broken tie of kinship when the animal species was no longer akin to man.

This theory of Robertson Smith's has been attacked from two sides. In the first place, L. Marillier (*Rev. de l'hist. des religions*, xxxvi. 243) argues that if there was an original bond of kinship between the god and the kin, there is no need to maintain it by sacrificial rites, and cites against Smith's view the practice of totemic groups. To this it might be replied that the real significance of initiation ceremonies is still obscure; it is a plausible argument that the child does not form part of the kin till after initiation, but this argument seems inconclusive, for in West Australia there is solidarity, according to Grey (*Journals*, ii. 239), between the whole of the kinship group, whether adult or not; and, moreover, nowhere are rites found which are intended to strengthen the union between a man and his totem by means of the blood bond, unless we include the aberrant totemism of the Arunta (Spencer and Gillen, *Native Tribes of Central Australia*, 167), who eat their totems in order to gain magical powers of increasing the stock of the totem animal. Marillier further argues that if, on the other hand, there was no bond between god and people but that of the common meal, it does not appear that the god is a totem god; there is no reason why the animal should have been a totem; and in any case this idea of sacrifice can hardly have been anything but a slow growth and consequently not the origin of the practice. In the second place,

MM. Hubert and Maus point out that Robertson Smith is far from having established either the historical or the logical connexion between the common meal and the other types of sacrifice; the simplest Semitic forms known to us are the most recently recorded; further their simplicity may mean no more than documentary insufficiency, and in any case does not imply any priority; the *piaculum* is found side by side with the communion at all times. Moreover, under *piaculum* are confused purification, propitiations and expiations; Smith's contention that purifications, whose magical character he recognizes but interprets as late, are not sacrificial, is far from conclusive.

(c) Building in part on the foundation laid by Robertson Smith, Dr J. G. Frazer has put forward the view that while the sacrifice of the god may have been piacular, it was also intended to preserve his divine life against the inroads of old age. This theory he exemplifies by two orders of cases, (i.) the putting to death of the man-god, who is often also the king, on whose health is held to depend the safety of his people, of the world, or even of the universe; and (ii.) the annual killing of the representative of the spirit of vegetation or of the Corn-spirit (see DEMONOLOGY).

(d) For L. Marillier sacrifice was, at its origin, essentially a magical rite—the liberation by the effusion of a victim's blood of a magical force which was to bend the gods to the will of man; from this arose, under the influence of cult of the dead, the gift theory of sacrifice. Adopting the theory of W. R. Smith, Marillier also maintained, but without clearly explaining the relation of this part of his theory to the preceding, that a human kinship group conceived the idea of allying itself with one god in particular. This they did by sacrificing a victim and effecting communion with the god by the application of its blood to the altar; or, more directly, by the sacrifice of the animal-god and the contact of the sacrificer with its blood.

(e) Dr Westermarck takes the view that human sacrifice is as a rule an act of substitution, in that men offer a victim in the hope of saving themselves; but he also recognizes funeral sacrifices of various kinds. Certain sacrifices of animals he explains as intended to transfer a conditional curse.

(f) The preceding theories are attempts, in the main, to derive from one source all the forms of sacrifice. MM. Hubert and Maus, while admitting that in all sacrifices is found some idea of purchase or substitution, decline to admit that all have issued from one primitive form. In their view, based on an analysis of Hebrew and Hindu forms of sacrifice, the unity of sacrifice consists in the immediate aim of the ritual, not in the ultimate end to be attained; for we rarely find a rite other than complex and by the same sacrifice more than one result may be sought or attained. The unity of procedure consists in the fact that every sacrifice involves putting the divine in communication with the profane by an intermediary—the victim—which may be piacular or honorific, a messenger or a means of divination, a means of alighting the eternal life of the species or a source of magical energy which the rite diffuses over objects in its neighbourhood.

(g) Our knowledge of primitive forms of sacrifice is meagre; even were it more extensive, it would probably be impossible to determine the origin or origins of sacrifice; for no ritual has necessarily survived unchanged in form and meaning since its inception, and even permanence of form cannot be taken to imply a corresponding permanence of meaning for the worshippers. If, however, we turn to Australia, where sacrifice is unknown, we find more than one class of rites in which we can trace an idea akin to some forms of sacrifice. Just as the German reaper leaves the last ears of corn as an offering to Wodan, so the Australian black offers a portion of a find of honey; in New South Wales a pebble is said to have been offered or a number of spears, in Queensland the skin removed in forming the body-scars. Thus it appears that the gift theory may after all be primitive; the worship of, or care for, the dead may have supplied in other areas the motive for the transition from offering to sacrifice or the evolution may have been due to the spiritualization of the gods. In Australia, among the Hottentots,

in the Malay Peninsula and elsewhere, blood ceremonies are in use which are unconnected with the slaughter of a victim; in this blood ritual we may see another possible source of sacrifice. The Arunta hold that the spirits of kangaroos are expelled by human blood from certain rocks. By parity of reasoning a blood ritual may have been adopted by peoples who practise the expulsion of evils, conceiving them either animistically or as powers; catharsis, in the sense of removal of uncleanness, is not necessarily primitive.

Principles of Classification.—It is possible to classify sacrifices according to (a) the occasion of the rite, (b) the end to be achieved, (c) the material object to be affected or (d) the form of the rite. (a) The division into periodical and occasional is important in Hindu and other higher religions, and the *sūtras* constantly draw the distinction; the former class is obligatory, the latter facultative. In less developed creeds the difference tends to remain in the background; but where sacrifices are found, solemn annual rites, communal, purificatory or expiatory, are celebrated, and these are held to be in like manner obligatory. (b) The end to be achieved is, as has been shown by Hubert and Mauss, sometimes sacralization, sometimes desacralization. In the former case the sacrificer is raised to a higher level; he enters into closer communion with the gods. In the latter either some material object, not necessarily animate, is deprived of a portion of its sanctity and made fit for human use, or the sacrificer himself loses a portion of his sanctity or impurity. In the sacrifice of sacralization the sanctity passes from the victim to the object; in that of desacralization, from the object to the victim. (c) Sacrifices may be classified into (i.) subjective or personal, where the sacrificer himself gains or loses sanctity or impurity; (ii.) objective, where the current of *mana* (see TABOO) is directed upon some other person or object, and only a secondary effect is produced on the sacrificer himself. (d) The form of the sacrifice is discussed in the next section.

Ritual.—For Hinduism and later Judaism we possess a wealth of material on which to base a comparative study of the forms of sacrifice; a form of this—animal sacrifice in the Vedas—has been analysed by MM. Hubert and Mauss. For Greece and Rome, where the instructions as to ritual were not embodied in the elaborate codes handed down in Hinduism or Judaism, our material is far less complete. For other areas we have often no description of the procedure at all, but merely the briefest outline of the actual process of slaughter, and we are ignorant whether the form of the rite is in reality simple (either from a loss of primitive elements or from never having advanced beyond the stage at which we find it), or whether the absence of detail is due to the inattention or lack of interest of the observer. It must therefore be understood that the following analysis of ritual, based on the most elaborate codes known to us, is by no means conclusive as to the primitive form or forms of sacrifice. The necessary elements of a Hindu sacrifice are: (1) the *sacrificer*, who provides the victim, and is affected, directly or indirectly, by the sacrifice; he may or may not be identical with (2) the *officiant*, who performs the rite; we have further (3) the *place*, (4) the *instruments* of sacrifice and (5) the *victim*; where the sacrificer enjoys only the secondary results, the direct influence of the sacrifice is directed towards (6) the *object*; finally, we may distinguish (7) *three moments of the rite*—(a) the *entry*, (b) the *slaughter*, (c) the *exit*.

The sacrifices of sacralization and desacralization mentioned above find their analogues in the Hindu scheme of the rite; sacralization and desacralization, sometimes performed by means of subsidiary sacrifices, are the essential elements of the preparation for sacrifice and the subsequent lustration. In the most developed forms, such as the offering of *soma*, they assumed a great importance; (1) the sacrificer had to pass from the world of man into a world of the gods; consequently he was separated from the common herd of mankind and purified; he underwent ceremonies emblematic of rebirth and was then subject to numberless taboos imposed for the purpose of maintaining his ceremonial purity. In like manner (2) the officiant prepared himself for his task; but in his case the natural sanctity of the priest relieved

him of the necessity of undergoing all that the common man had to pass through; in fact, this was one of the causes which brought him into existence; the other being the need of a functionary familiar with the ritual, who would avoid disastrous errors of procedure, destructive of the efficacy of the sacrifice. (3) Where there was an appointed place of sacrifice—the Temple at Jerusalem, according to later Jewish prescription—there was no need of preparation of a place of sacrifice; but the Hindu chose, each for himself, the site of his altar. (4) The necessary rites included (a) the establishment of the fires, friction being the only permitted method of kindling it, (b) the tracing on the ground of the *vedi*, or magical circle, to destroy impurities, (c) the digging of the hole which constituted the real altar, (d) the preparation of the post which represented the sacrificer and to which the victim was tied, and other minor details. (5) The victim might be naturally sacred or might have to undergo sanctification. In the former case (a) individual animals might be distinguished by certain marks, or (b) the whole species might be allied to the god; in the latter case the victim had to be without blemish; (c) the age, colour or sex of the victim might differ according to the purpose of the sacrifice. It was first cleansed; then plied with laudatory epithets; and, thirdly, soothed, so that it might be more acceptable to the gods and less likely to do an injury after its death, when its spirit was set free. It had now reached a degree of sanctity and only the priest might touch it; it was sprinkled with water, and anointed with butter; finally, the priest made three turns round it with a lighted torch in his hand, which finally separated it from the world and fitted it for its high purpose. The object of the sacrifice being to bridge the gulf between the sacred and profane worlds, the sacrificer had to remain in contact with the victim, either personally, or, to avoid ritual perils, by the intermediary of the priest. After excuses made to the animal or to the species in general, the victim was placed in position, and silence observed by all who were present. The cord was drawn tight and the victim ceased to breathe; its spirit passed into the world of the gods. But this did not conclude the ceremony, even as far as the victim was concerned; it remained to dispose of the corpse. After a rite intended to secure its perfect ceremonial purity, a part of the victim, the *vāṅś*, was removed, held over the fire and finally cast into it. The remainder, divided into eighteen portions, was cooked; seven fell to the sacrificer, after an invocation, which made them sacred by calling the deity to descend into the offering and thus sanctify the sacrificer. (6) Then followed the rites of desacralization, including burning of certain of the instruments, lustration of the post, destruction of the butter, &c. Finally the priest, the sacrificer and his wife performed a lustration, found in an exaggerated form in the "bath" which concluded the *soma* sacrifice, and the ceremonies were at an end.

How far this scheme of sacrifice holds good for other areas, and in particular for more primitive peoples, is an open question. Our data are nowhere so full as for India; where they are comparatively abundant they refer either to a civilized or semi-civilized people, or to an area, like West Africa, where the influence of Islam has introduced a disturbing element. Though the moralization of gods has only proceeded *pari passu* with the moralization of mankind, the deities of the more advanced nations are perhaps felt by them to be more terrible and more difficult of access than the divinities of lower races; herein lies one explanation of the power of the priesthood. Even if the conception of the relative sanctity of gods and men remained unaltered, it by no means follows that in primitive times the same precautions were necessary in approaching the former as were demanded by the consciousness of later generations. With our present knowledge the problem of the original form of sacrifice, if there be a single primary form, is insoluble.

No general survey of sacrificial ritual is possible here, but a few details as to the mode of slaying the victim and disposing of the body may be given. The head of the animal or man may be cut off (and custom often requires that a single blow shall suffice), its spine broken or its heart torn out; it may be

stoned, beaten to death or shot, torn in pieces, drowned or buried, burned to death or hung, thrown down a precipice, strangled or squeezed to death. The sacrificer may aim at causing a speedy death or a slow one. The corpse may be burnt, in part or as a whole; portions may be assigned to the priest, the sacrificer and the gods; the skull, bones, &c., may receive special treatment; the fat or blood may be set aside, and they or the ashes may be singled out as the share of the god, to be offered upon the altar; the skin of the victim may be employed as a covering for the idol or material representative of the god, either permanently or till the next annual sacrifice. The blood of the victim may be drunk by the priest as a means of inducing inspiration, its entrails may be employed in divination, its flesh consumed in a common meal, exposed to the birds and beasts of prey or buried in the earth.

It is equally impossible to give a general survey of the purposes of sacrifice; not only are they too numerous but it is rare to find any but mixed forms; the scapegoat, for example, is also a messenger to the dead, and its flesh is eaten by the sacrificers. Certain main types may, however, be enumerated.

Cathartic Sacrifice.—In primitive cults the distinction between sacred and unclean is far from complete or well defined (see TABOO); consequently we find two types of cathartic sacrifice—(i.) one to cleanse of impurity and make fit for common use, (ii.) the other to rid of sanctity and in like manner render suitable for human use or intercourse.

(i.) The most conspicuous example of the first class is the scapegoat. Two goats were provided by the ancient Hebrews on the Day of Atonement; the high priest sent one into the desert, after confessing on it the sins of Israel; it was not permitted to run free but was probably cast over a precipice; the other was sacrificed as a sin-offering. In like manner in the purification of lepers two birds were used; the throat of one was cut, the living bird dipped in the blood mingled with water and the leper sprinkled; then the bird was set free to carry away the leprosy. In both these rites we seem to have a duplication of ritual, and the parallelism of sacrifice and liberation is clear.

(ii.) As an example of the second class may be taken the sacrifice of the bull to Rudra. M.M. Hubert and Mauss interpret this to mean that the sanctity of the remainder of the herd was concentrated on a single animal; the god, incarnate in the herd, was eliminated by the sacrifice, and the cattle saved from the dangers to which their association with the god exposed them. In the Feast of Firstfruits we have another example of the same sort; comparable with this concentration of holiness is the respect or veneration shown to a single animal as representative of its species (see ANIMAL WORSHIP). In both these cases the object of the rite is the elimination of impurity or of a source of danger. But the Nazarite was equally bound to lay aside his holiness before mixing with common folk and returning to ordinary life; this he did by a sacrifice, which, with the offering of his hair upon the altar, freed him from his vow and reduced him to the same level of sanctity as ordinary men.

With regard to the scapegoat, it must be noted that we also meet with a more concrete idea of expulsion of evil (see DEMONOLOGY, EXORCISM), which is present among the most primitive peoples, such as the Australians. This raises the problem of how far the catharsis dealt with above is in its original form an elimination of impurity, and how far something more definite—a spirit or other principle of evil—is held to be expelled by scapegoat and allied ceremonies.

Communal Sacrifice.—In spite of the importance attached to the idea of the common meal by Robertson Smith, it is not a primitive rite of adoption. The custom of eating the body of the victim does not necessarily spring from any idea of communion with the god; it may also arise from a desire to incorporate the sanctity which has been imparted to it—an idea on a level with many other food customs (see COUVADE), and based on the idea that eating anything causes its qualities to pass into the eater. Where the victim is an animal specially associated with a god (the most conspicuous case is perhaps that of the corn spirit), it may be granted that the god is eaten; but precisely

in these cases there is no custom of giving a portion of the victim to the god.

Deficatory Sacrifice.—The object of certain sacrifices is to provide a tutelary deity of a house, town or frontier. (a) In Burma, as in many other countries, those who die a violent death are held to haunt the place where they met their fate; consequently when a town is built living men are interred beneath the ramparts and the pillars of the gates. (b) In parts of North America the *nagual* or *manitu* animal, of which the Indian dreams during the initiation fast and which is to be his tutelary spirit, is killed with certain rites. (c) Human representatives of the corn or vegetation spirits are killed; in these, as in other cases of the sacrifice of the man-god cited by Dr Frazer, the killing of the old god is at the same time the making of a new god. (d) Suicide is treated as a means of raising a human being to the rank of a god. (e) Gods may be sacrificed (in theriomorphic form) to themselves as a means of renewing the life of the god. (f) The method of creating a fetish (see FETTERISM) on the Congo resembles deficatory sacrifice; but here there is no actual slaughter of a human being; magical means are alone relied upon.

Honorific Sacrifices.—Whatever their origin, sacrifices tend to be interpreted as gifts to the god. Man seeks to influence his fellow men in various ways, by intimidation, by deceit, by bribery; and it is quite natural to find the same ideas in the sphere of religion. Food is often given to a god because he is believed to take pleasure in eating; the germ of this idea may have been identical with that of some funerary sacrifices—to nourish the divine life. At a later period, *pari passu* with the spiritualization of the god, comes a refinement of the tastes attributed to him, and the finer parts of the sacrifice, finally it may be only its savour, are alone regarded as acceptable offerings. Just as attendants are provided for the dead, so the god receives sacrifices intended to put slaves at his disposal. This latter idea was the more likely to arise, as the gift theory of sacrifice is closely associated with that of the god as the ruler or king to whom man brings a tribute, just as he had to appear before his earthly king bearing gifts in his hands. The honorific sacrifice is essentially a propitiation; it must be distinguished from the *piacular* (see below), to which in some aspects it is allied.

Mortuary Sacrifice.—Sacrifices, especially of human beings, are offered immediately after a death or at a longer interval. Their object may be (a) to provide a guide to the other world; (b) to provide the dead with servants or a retinue suitable to his rank; (c) to send messengers to keep the dead informed of the things of this world; (d) to strengthen the dead by the blood or life of a living being, in the same way that food is offered to them or blood rituals enjoined on mourners.

Piacular Sacrifice.—Whereas the god receives a gift in the honorific sacrifice, he demands a life in the piacular. This, according to Westermarck, is the central idea of human sacrifice: the victim is substituted for the sacrificer, to deliver him from perils by disease, famine or, more indefinitely, from the wrath of the god in general. The essential feature of the *piacular* is that it is an expiation for wrong-doing, and the victim is often human.

Human Sacrifice.—Many theories of the relation of human to animal sacrifice have been put forward, most of them on an insufficient basis of facts. It has been held that animal sacrifice is the primitive form and that the decay of totemism or lack of domestic animals has brought about the substitution of a human victim; but it has also been urged that in many cases animal victims are treated like human beings and must consequently have replaced them, that human beings are smeared with the blood of sacrifice, and must therefore have themselves been sacrificed before a milder régime allowed an animal to replace them. If tradition is any guide, human sacrifice seems in many important areas to be of secondary character; in spite of the great development of the rite among the Aztecs, tradition says that it was unknown till two hundred years before the conquest; in Polynesia human sacrifices seem to be comparatively modern; and in India they appear to have been rare among the Vedic peoples. On the whole, human sacrifice is far commoner

among the semi-civilized and barbarous races than in still lower stages of culture. In Australia, however, where sacrifice of the ordinary type is unknown, the ritual killing of a child is practised in connexion with the initiation of a magician; it is therefore by no means axiomatic that animals were offered before human beings; the problem of priority is one to be solved for each area separately, but probably no solution is possible; in the absence of Aztec traditions it would hardly have seemed probable that two centuries had seen so great a transformation.

Among the forms of human sacrifice must be reckoned religious suicide. This is perhaps mainly found in India but is not unknown in Africa and other parts of the world. Human sacrifices were known in ancient India and survived till late in the 19th century (see below); both Greeks and Romans practised them, no less than the wilder races of ancient Europe. Semites and Egyptians, Peruvians and Aztecs, slew human victims; Africa, especially the West Coast, till recently saw thousands of human victims perish annually; in Polynesia, Tahiti and Fiji were great centres of the rite—in fact, it is not easy to name an area where it has not been known.

No general survey of sacrifice on geographical lines is possible, but some of the more important features in each area may be noticed.

Sacrifice in Greece and Rome.—Both the mainland of Greece and the Greek colonies practised human sacrifice, usually as a means towards expulsion of evil. Thus, the Athenians maintained a number of outcasts, from whom in times of national calamity two were selected, one for the men, one for the women, and stoned to death outside the city; at the Thargelia two victims were annually put to death in the same way. Many animal sacrifices were known; of especial importance is the annual sacrifice of a goat on the Acropolis, though at other times the animal was not permitted to enter the temple.

Important features of Greek sacrifice, though not necessarily found in every rite, were the putting of wreaths and pieces of wool on the victim, the gilding of its horns, the lustration of the officiant and the sprinkling of those present with holy water. It was held inauspicious if the animal were unwilling; if it nodded all was well. Barley meal¹ was strewn on its neck, and a lock of hair cut from its forehead and burned. The animal was then clubbed, its throat cut and the altar sprinkled with its blood. Finally the body was skinned and cut up and the god's share burned on the altar.

The important Attic sacrifice of the Dipolia, known as *τὰ βοφῶνια*, demands some notice. Cakes were laid on the altar of Zeus Polieus and oxen driven round; the one which touched the cakes was the victim. An officiant at once struck it with his axe and another cut its throat; then all save the one who struck the first blow partook of its flesh. Then the hide was stuffed with grass and yoked to a plough; the participants were charged with ox murder and each laid the blame on the other; finally the axe was thrown into the sea. The interpretation of the rite is uncertain; it may perhaps be connected with agrarian rites.

At Rome the scapegoat did not suffer death; but in the Saturnalia a human victim seems to have been slain till the 4th century A.D. Many forms of animal sacrifice were found; the generalized account given above for Greece is true also for the Romans.

Sacrifice in Egypt.—Of Egyptian ritual little is known; our knowledge rests mainly on the evidence of pictures. At Deir el Bahri we see that the animal had its throat cut in Mahomedan fashion; it lay on its side, the legs tied together; the heart was taken out, then the liver; the burnt sacrifice was hardly known.

Sacrifice in India.—An account of animal sacrifice has been given above. Among human sacrifices may be mentioned the *suttee*, or custom of immolating a widow on the funeral pyre of the husband, and the Khond sacrifice of the Meriah, who was either purchased or the son of a victim father. Some days before

the sacrifice, the victim, who was often kept in captivity for long periods, was devoted by the cutting of his hair, previously unshorn, and his sanctity was increased later by various ceremonies of anointing. Finally he was taken in procession, stupefied or otherwise rendered incapable of resistance, and put to death by strangulation or pressure. The remains were dismembered and carried to the fields, excepting the portion offered to the earth goddess, which was buried.

Sacrifice in Africa.—Especially in West Africa many forms of sacrifice are found. In the annual "customs" of Dahomey, now abolished, hundreds of human victims were offered. Three main forms of human sacrifice existed in this area: (1) the scapegoat; (2) the messenger; and (3) the expiation, but combinations were not infrequent. The victim was often kept in captivity and well fed; to transfer their sins people laid their hands upon him as he was led in procession, his head covered with ashes; on the way to the place of sacrifice were three enclosures, the second open to chiefs and priest only, the third to the officiant and his helper alone; the blood of the victim was offered to the gods. At the present day the animal victim may be burned or drowned, buried in the earth or simply exposed. Sometimes the sacrificer's hands are laid on the victim before it is slain, or he may be smeared with its blood; in other cases the blood is smeared on the door posts, or the sacrificer is touched on every part of the body with the victim's body. On the Congo, if a man commits a murder, the community votes whether he shall die or be expelled; if the latter, a victim is killed, of which all must partake; but this is not, as might be imagined, a case of Robertson Smith's *piaculum* for the re-establishment of the tribal bond; for the criminal is driven out of the community.

Sacrifice in America.—Sacrifice was relatively infrequent and undeveloped among the Red Indians. The Pawnees, however, had an elaborate ritual, in which a human victim was sacrificed to the Morning Star; the blood of the victims was sprinkled on the fields, and the details of the rite are not unlike those of the Khond custom. The Iroquois sacrifice of the white dog bore in later times the character of a scapegoat festival; but it is doubtful how far this was an original feature. The animals were decorated with wampum and strangled, and then the sins of the people were transferred to them; then the remains were burned and the ashes gathered up, taken through the village and sprinkled before every house. In Mexico human sacrifices were very common; the lowest estimate is 20,000 annually. The victims were often fêted for a whole year and treated as divine; the heart was an offering to the god, the body was eaten by the priests and nobles and the head was preserved with those of previous victims.

BIBLIOGRAPHY.—H. Hubert and M. Mauss in *Année sociologique*, ii.; J. G. Frazer, *Golden Bough*, ii., iii.; W. R. Smith, *Religion of Semites*; L. Marillier, *Revue de l'h. des religions*, xxvii. 208 seq.; E. B. Tylor, *Primitive Culture*; Ed. Westermarck, *Origin of Moral Ideas* (esp. vol. i. for Human Sacrifice). For Greece and Rome see L. Farnell, *Cults of the Greek States*, especially i. 56, 88 seq.; W. W. Fowler, *Festivals*; and Pauly, *Realencyclopädie*, s.v. "Sacrificia." For West Africa, J. Johnson, *Yoruba Heathenism* (1899), reprinted in R. E. Dennett, *As the Black Man's Mind*; and the work of A. B. Ellis. For America see the works of Frazer and Westermarck and the references there given. On religious suicide see Lasch in *Globus*, lxxv. 69, and Westermarck vol. ii. See also articles "Sacrifice" in *Ency. Bibl.*, *Jewish Encyclopaedia*, &c.

(N. W. T.)

The Idea of Sacrifice in the Christian Church.

There can be no doubt that the idea of sacrifice occupied an important place in early Christianity. It had been a fundamental element of both Jewish and Gentile religions, and Christianity tended rather to absorb and modify such elements than to abolish them. To a great extent the idea had been modified already. Among the Jews the preaching of the prophets had been a constant protest against the grosser forms of sacrifice, and there are indications that when Christianity arose bloody sacrifices were already beginning to fall into disuse; a saying which was attributed by the Ebionites to Christ repeats this

¹ This sprinkling of the victims with sacrificial meal (Lat. *mola*) is the origin of the word *immolare*, to sacrifice, slaughter; Eng. "immolate," "immolation."

protest in a strong form, "I have come to abolish the sacrifices; and if ye do not cease from sacrificing the wrath of God will not cease from you" (Epiph. xxx. 16). Among the Greeks the philosophers had come to use both argument and ridicule against the idea that the offering of material things could be needed by or acceptable to the Maker of them all. Among both Jews and Greeks the earlier forms of the idea had been rationalized into the belief that the most appropriate offering to God is that of a pure and penitent heart, and among them both was the idea that the vocal expression of contrition in prayer or of gratitude in praise is also acceptable. The best instances of these ideas in the Old Testament are in Psalms I. and li., and in Greek literature the striking words which Porphyry quotes from an earlier writer, "We ought, then, having been united and made like to God, to offer our own conduct as a holy sacrifice to Him, the same being also a hymn and our salvation in passionless excellence of soul" (Euseb. *Dem. ev.* 3). The ideas are also found both in the New Testament and in early Christian literature: "Let us offer up a sacrifice of praise to God continually, that is, the fruit of lips which make confession to His name" (Heb. xiii. 15); "That prayers and thanksgivings, made by worthy persons, are the only perfect and acceptable sacrifices I also admit" (Just. Mart. *Trypho.* c. 117); "We honour God in prayer, and offer this as the best and holiest sacrifice with righteousness to the righteous Word" (Clem. Alex. *Strom.* vii. 6).

But among the Jews two other forms of the idea expressed themselves in usages which have been perpetuated in Christianity, and one of which has had a singular importance for the Christian world. The one form, which probably arose from the conception of Yahweh as in an especial sense the protector of the poor, was that gifts to God may properly be bestowed on the needy, and that consequently alms have the virtue of a sacrifice. Biblical instances of this idea are—"He who doeth alms is offering a sacrifice of praise" (Ecclus. xxiii. 2); "To do good and to communicate forget not, for with such sacrifices God is well pleased" (Heb. xiii. 16); so the offerings sent by the Philippians to Paul when a prisoner at Rome are "an odour of a sweet smell, a sacrifice acceptable, well pleasing to God" (Phil. iv. 18). The other form, which was probably a relic of the conception of Yahweh as the author of natural fertility, was that part of the fruits of the earth should be offered to God in acknowledgment of His bounty, and that what was so offered was especially blessed and brought a blessing upon both those who offered it and those who afterwards partook of it. The persistence of this form of the idea of sacrifice constitutes so marked a feature of the history of Christianity as to require a detailed account of it.

In the first instance it is probable that among Christians, as among Jews, every meal, and especially every social meal, was regarded as being in some sense a thank-offering. Thanksgiving, blessing and offering were co-ordinate terms. Hence the Talmudic rule, "A man shall not taste anything before blessing it" (*Tosephta Berachoth.* c. 4), and hence St Paul's words, "He that eateth, eateth unto the Lord, for he giveth God thanks" (Rom. xiv. 6; cp. 1 Tim. iv. 4). But the most important offering was the solemn oblation in the assembly on the Lord's day. A precedent for making such oblations elsewhere than in the temple had been afforded by the Essenes, who had endeavoured in that way to avoid the contact with unclean persons and things which a resort to the temple might have involved (Jos. *Antiq.* xviii. 1. 5), and a justification for it was found in the prophecy of Malachi, "In every place incense is offered unto my name and a pure offering; for my name is great among the Gentiles, saith the Lord of hosts" (Mal. i. 11, repeatedly quoted in early Christian writings, e.g. *Teaching of the Twelve Apostles.* c. 14; Just. Mart. *Trypho.* c. 28, 41, 116; Irenaeus iv. 17. 5).

The points in relation to this offering which are clearly demonstrable from the Christian writers of the first two centuries, but which subsequent theories have tended to confuse, are these. (1) It was regarded as a true offering or sacrifice; for in the *Teaching of the Twelve Apostles*, in Justin Martyr and in Irenaeus it is designated by each of the terms which are used

to designate sacrifices in the Old Testament. (2) It was primarily an offering of the fruits of the earth to the Creator; this is clear from both Justin Martyr and Irenaeus, the latter of whom not only explicitly states that such oblations are continued among Christians, but also meets the current objection to them by arguing that they are offered to God not as though He needed anything but to show the gratitude of the offerer (Iren. iv. 17, 18). (3) It was offered as a thanksgiving partly for creation and preservation and partly for redemption: the latter is the special purpose mentioned (e.g.) in the *Teaching of the Twelve Apostles*; the former is that upon which Irenaeus chiefly dwells; both are mentioned together in Justin Martyr (*Trypho.* c. 41). (4) Those who offered it were required to be not only baptized Christians but also "in love and charity one with another"; there is an indication of this latter requirement in the Sermon on the Mount (Matt. v. 23, 24, where the word translated "gift" is the usual LXX. word for a sacrificial offering, and is so used elsewhere in the same Gospel, viz. Matt. viii. 4, xxiii. 10), and still more explicitly in the *Teaching.* c. 14, "Let not any one who has a dispute with his fellow come together with you (i.e. on the Lord's day) until they have been reconciled, that your sacrifice be not defiled." This brotherly unity was symbolized by the kiss of peace. (5) It was offered in the assembly by the hands of the president; this is stated by Justin Martyr (*Apol.* i. 65, 67), and implied by Clement of Rome (*Ep.* i. 44. 4).

Combined with this sacrifice of the fruits of the earth to the Creator in memory of creation and redemption, and probably always immediately following it, was the sacred meal at which part of the offerings was eaten. Such a sacred meal had always, or almost always, formed part of the rites of sacrifice. There was the idea that what had been solemnly offered to God was especially hallowed by Him, and that the partaking of it united the partakers in a special bond both to Him and to one another. In the case of the bread and wine of the Christian sacrifice, it was believed that, after having been offered and blessed, they became to those who partook of them the body and blood of Christ. This "communion of the body and blood of Christ," which in early writings is clearly distinguished from the thank-offering which preceded it, and which furnished the materials for it, gradually came to supersede the thank-offering in importance, and to exercise a reflex influence upon it. In the time of Cyprian, though not before, we begin to find the idea that the body and blood of Christ were not merely partaken of by the worshippers but also offered in sacrifice, and that the Eucharist was not so much a thank-offering for creation and redemption as a repetition or a showing forth anew of the self-sacrifice of Christ. This idea is repeated in Ambrose and Augustine, and has since been a dominant idea of both Eastern and Western Christendom. But, though dominant, it has not been universal; nor did it become dominant until several centuries after its first promulgation. The history of it has yet to be written. For, in spite of the important controversies to which it has given birth, no one has been at the pains to distinguish between (i.) the theories which have been from time to time put forth by eminent writers, and which, though they have in some cases ultimately won a general acceptance, have for a long period remained as merely individual opinions, and (ii.) the current beliefs of the great body of Christians which are expressed in recognized formularies. A catena of opinions may be produced in favour of almost any theory; but formularies express the collective or average belief of any given period, and changes in them are a sure indication that there has been a general change in ideas.

It is clear from the evidence of the early Western liturgies that, for at least six centuries, the primitive conception of the nature of the Christian sacrifice remained. There is a clear distinction between the sacrifice and the communion which followed it, and that which is offered consists of the fruits of the earth and not of the body and blood of Christ. Other ideas no doubt attached themselves to the primitive conception, of which there is no certain evidence in primitive times, e.g. the idea of the propitiatory character of the offering, but these

ideas rather confirm than disprove the persistence of those primitive conceptions themselves.

All Eastern liturgies, in their present form, are of later date than the surviving fragments of the earlier Western liturgies, and cannot form the basis of so sure an induction; but they entirely confirm the conclusions to which the Western liturgies lead. The main points in which the pre-medieval formularies of both the Eastern and the Western Churches agree in relation to the Christian sacrifice are the following. (1) It was an offering of the fruits of the earth to the Creator, in the belief that a special blessing would descend upon the offerers, and sometimes also in the belief that God would be propitiated by the offerings. The bread and wine are designated by all the names by which sacrifices are designated (*sacrificia, hostiae, libamina*, and at least once *sacrificium placationis*), and the act of offering them by the ordinary term for offering a sacrifice (*immolatio*). (2) The offering of bread and wine was originally brought to the altar by the person who offered it, and placed by him in the hands of the presiding officer. In course of time there were two important changes in this respect: (a) the offerings of bread and wine were commuted for money, with which bread and wine were purchased by the church-officers; (b) the offerings were sometimes handed to the deacons and by them taken to the bishop at the altar, and sometimes, as at Rome, the bishop and deacons went round the church to collect them.¹ (3) In offering the bread and wine the offerer offered, as in the ancient sacrifices, primarily for himself, but inasmuch as the offering was regarded as having a general propitiatory value he mentioned also the names of others in whom he was interested, and especially the departed, that they might rest in peace. Hence, after all the offerings had been collected, and before they were solemnly offered to God, it became a custom to recite the names both of the offerers and of those for whom they offered, the names being arranged in two lists, which were known as diptychs. Almost all the old rituals have prayers to be said "before the names," "after the names." It was a further and perhaps much later development of the same idea that the good works of those who had previously enjoyed the favour of God were invoked to give additional weight to the prayer of the offerer. In the later series of Western rituals, beginning with that which is known as the *Leonine Sacramentary*, this practice is almost universal. (4) The placing of the bread and wine upon the altar was followed by the kiss of peace. (5) Then followed the actual offering of the gifts to God (*immolatio missae*). It was an act of adoration or thanksgiving, much longer in Eastern than in Western rituals, but in both classes of rituals beginning with the form "Lift up your hearts," and ending with the *Ter Sanctus* or *Trisagion*.² The early MSS. of Western rituals indicate the importance which was attached to this part of the liturgy by the fact of its being written in a much more ornate way than the other parts, e.g. in gold uncial letters upon a purple ground, as distinguished from the vermilion cursive letters of the rest of the MS. With this the sacrifice proper was concluded. (6) But, since the divine injunction had been "Do this in remembrance of me," the sacrifice was immediately followed by a commemoration of the passion of Christ, and that again by an invocation of the Holy Spirit (*epiclesis*) that He would make the bread and wine to become the body and blood of Christ. Of this invocation, which is constant in all Eastern rituals, there are few, though sufficient, surviving traces in Western rituals.³ Then after a prayer for sanctification, or for worthy reception, followed the Lord's Prayer, and after the Lord's Prayer the communion.

¹ In the course of the 8th and 9th centuries, by the operation of this proceeding an elaborate account exists in the very interesting document printed by Mabillon in his *Museum Italicum* as "Ordo Romanus I.," the small pails of wine which were brought were emptied into a large bowl, and the loaves of bread were collected in a bag.

² The elements of the form are preserved exactly in the liturgy of the Church of England.

³ It is found, e.g., in the second of Mone's masses from the Reichenau palimpsest, and in Mabillon's *Missale Gothicum*, No. 12; it is expressly mentioned by Isidore of Seville as the sixth element in the Eucharistic service, *De offic. eccl.* i. 15.

of causes which have not yet been fully investigated, the theory which is first found in Cyprian became the dominant belief of Western Christendom. The central point of the sacrificial idea was shifted from the offering of the fruits of the earth to the offering of the body and blood of Christ. The change is marked in the rituals by the duplication of the liturgical forms. The prayers of intercession and oblation, which in earlier times are found only in connexion with the former offering, are repeated in the course of the same service in connexion with the latter. The designations and epithets which are in earlier times applied to the fruits of the earth are applied to the body and blood. From that time until the Reformation the Christian sacrifice was all but universally regarded as the offering of the body and blood of Christ. The innumerable theories which were framed as to the precise nature of the offering and as to the precise change in the elements all implied that conception of it. It still remains as the accepted doctrine of the Church of Rome. For, although the council of Trent recognized fully the distinction which has been mentioned above between the Eucharist and the sacrifice of the mass, and treated of them in separate sessions (the former in Session xiii., the latter in Session xxii.), it continued the medieval theory of the nature of the latter. The reaction against the medieval theory at the time of the Reformation took the form of a return to what had no doubt been an early belief,—the idea that the Christian sacrifice consists in the offering of a pure heart and of vocal thanksgiving. Luther at one period (in his treatise *De captivitate Babilonica*) maintained, though not on historical grounds, that the offering of the oblations of the people was the real origin of the conception of the sacrifice of the mass; but he directed all the force of his vehement polemic against the idea that any other sacrifice could be efficacious besides the sacrifice of Christ. In the majority of Protestant communities the idea of a sacrifice has almost lapsed. That which among Catholics is most commonly regarded in its aspect as an offering and spoken of as the "mass" is usually regarded in its aspect as a participation in the symbols of Christ's death and spoken of as the "communion." But it may be inferred from the considerable progress of the Anglo-Catholic revival in most English-speaking countries that the idea of sacrifice has not yet ceased to be an important element in the general conception of religion. (E. H.A.)

SACRILEGE, the violation or profanation of sacred things, a crime of varying scope in different religions. It is naturally much more general and accounted more dreadful in those primitive religions in which cultual objects play so great a part, than in more highly spiritualized religions where they tend to disappear. But wherever the idea of sacred exists, sacrilege is possible. The word itself comes from the Lat. *sacrilegium*, which originally meant merely the theft of sacred things, although already in Cicero's time it had grown to include in popular speech any insult or injury to them.

The history of sacrilege reflects a large phase of the evolution of religion. In primitive religions inclusive of almost every serious offence even in fields now regarded as merely social or political, its scope is gradually lessened to a single part of one section of ecclesiastical criminology, following inversely the development of the idea of holiness from the concrete to the abstract, from fetishism to mysticism. The primitive defence against sacrilege lay directly in the nature of sacred things, those that held a cure for any violation or profanation. This brings us at once into the whole field of taboo (*q.v.*). From it we pass without a break, merely narrowing the application as the conception of sacredness grew clearer and less associated with magic, into early criminal law with its physical sanctions. The Levitical code exacted of the offender reparation for the damage with the addition of one-fifth of the amount, and an expiatory sacrifice (*Lev. v. 15, 16*). Even the gold and silver ornaments of the images of false gods were not to be coveted nor appropriated for fear of being contaminated with the curse which they could impart (*cf. Deut. vii. 25*). The tragic story of the stoning of Achan, who stole some of the spoils of Jericho which Joshua had consecrated to the treasury of Yahweh, is one of the most

graphic details of Old Testament history (cf. Joshua vii. 20-25).

No religion was more prodigal in rules to safeguard that which was holy or consecrated than the Jewish, especially in its temple laws; violation of them often led to mob violence as well as divine chastisement. The temple rules do not apply to synagogues, however, and unseemly conduct in them is liable only to civil action. The whole wide field of Jewish taboo naturally involves sacrilege as its reverse side. Such violations of holy things as making mock of the Scriptures, or even reciting them as one would ordinary literature, was sacrilege in the eyes of the rabbi. Even imitation of the style of the Talmud has also been accounted sacrilege.

While the Roman cults were amply protected by tobas, there was no comprehensive term in Roman law for religious violations and profanations in general. *Sacrilegium* was narrowly construed as the theft of sacred things from a sacred place. Sacred things, according to Gaius, were those things that had been definitely consecrated to the gods—and so had come to partake of their holiness. Sacred places did not include private shrines. According to Ulpian the punishment for *sacrilegium* varied according to the position and standing of the culprit and the circumstances under which the crime was committed. For the lower classes it was crucifixion, burning or the wild beasts. The latter penalty was also attached to theft of sacred things by night, but stealing by day from a temple objects of little value brought only sentence to the mines. People of higher rank were deported. During classical times the law kept to the narrow meaning of *sacrilegium*, but in popular usage it had grown to mean about the same as the English word. Traces of this usage are frequent in Augustan writers. The early church Fathers use the word most frequently in the restricted sense, although an effort has been made to read the wider meaning in Tertullian. But by the middle of the 4th century the narrower meaning had disappeared. In Ambrose, Augustine and Leo I., *sacrilegium* means sacrilege. The wider meaning had invaded the law as well. Mommsen was of the opinion that *sacrilegium* had no settled meaning in the laws of the 4th century. But it was rather that an enlarged application of the idea of sacred made the crime of sacrilege in the sense of *violatio sacri* a more general one. This was partly due to the influence of Christianity, which sought to include as objects of sacrilege all forms of church property, rather than merely those things consecrated in pagan cults, partly to the efforts of the later emperors to surround themselves and everything emanating from them with highest sanctions. In the Theodosian Code the various crimes which are accounted sacrilege include—apostasy, heresy, schism, Judaism, paganism, attempts against the immunity of churches and clergy or privileges of church courts, the desecration of sacraments, &c. and even Sunday. Along with these crimes against religion went treason to the emperor, offences against the laws, especially counterfeiting, defraudation in taxes, seizure of confiscated property, evil conduct of imperial officers, &c. There is no formal definition of sacrilege in the code of Justinian but the conception remains as wide. The church had found in the imperial law a strong protector.

The penitentials (*q.v.*), or early collections of disciplinary canons, gave much attention to sacrilege. In the earliest of them, sacrilege in the narrower sense is not a separate class of crime, but the wider usage goes with variations through the different collections. There is also the greatest difference in the penalties assigned, reaching from little more than restitution of property to penance of one to five or even fifteen years. The Frankish synods emphasize the crime of seizing church property of every kind, including the vast estates so envied by the lay nobility. In the Pseudo-Isidore the attempt was made to include even property on which the church had merely a legal claim. The murder or injury of the clergy is also sacrilege in both penitentials and capitularies. The practice of magic, superstition, &c., are also frequently referred to as sacrilege, especially during the long struggle with German heathenism. With the definite triumph of the church, the profanation of its sanctuaries became

less frequent, and once robbery or seizure of ecclesiastical possessions or violation of its privileges tended to absorb the attention of synods and popes. Gratian's Decretum mirrors two tendencies, the church legislation with its growingly less extended application, and the wide meaning as in Justinian's Code, owing to the revival of Roman law in the 11th century. It was thus once more declared to include all violations of the divine law. A somewhat distorted, but well-substantiated use of the word *sacrilegium* in medieval Latin was its application to the fine paid by one guilty of sacrilege to the bishop.

The penalties in the canon law included, in addition to restitution, penance, fines and excommunication; and right of asylum was denied to the culprit. The jurisdiction was something jointly shared with the temporal power in case corporal punishment were involved. The numerous enactments of councils to ensure the proper care of church property, prohibiting the use of churches for secular purposes, for the storing of grain or valuables, for dances and merry-making, do not technically come under the head of legislation against sacrilege. The worst sacrilege of all, defiling the Host, is mentioned frequently, and generally brought the death penalty accompanied by the cruellest and most ignominious tortures. The period of the Reformation naturally increased the commonness of the crime. Under the emperor Charles V. the penalty for stealing the Host was the stake; that for other crimes was graded accordingly. In France, in 1561, under Charles IX. it was forbidden under penalty of death to demolish crosses and images and to commit other acts of scandal and impious sedition. In the declaration of 1682, Louis XIV. decreed the same penalty for sacrilege joined to superstition and impiety, and in the somewhat belated religious persecution of the duke of Bourbon in 1724 those convicted of larceny in churches, together with their accomplices, were condemned, the men to the galleys for life or for a term of years, the women to be branded with the letter V and imprisoned for life, or for a term. When one takes into account that the next article of the declaration decreed death for domestic theft, the legislation is not relatively cruel. Yet even in the enlightened 18th century popular fanaticism made of sacrilege the most heinous offence. The trial of La Barre in 1766 at Abbeville (see VOLTAIRE) is the most famous in modern times. Convicted of wearing his hat while a religious procession was passing—as well as of blasphemy—he was accused as well of having mutilated a crucifix standing on the town bridge. Declared guilty, after torture, he was sentenced to have his tongue cut out, to be beheaded and the body to be burned, a sentence which was confirmed by the parlement of Paris and the bigoted king Louis XV. In the midst of the French Revolution respect for civic festivals was sternly enacted, but sacrilege was an almost daily matter of state policy. In the penal code the penalty for interfering with and molesting worshippers is slight, a fine of from 16 to 300 francs and prison from six days to three months, while damage or insult to the objects of worship brought only 16 francs to 500 francs fine, and prison from fifteen days to six months. In 1825 the reactionary parlement once more brought back the middle ages, by decreasing the death penalty for public profanation, the execution to be preceded by the *amende honorable* before the church doors. "Theft sacrilege" was treated in a separate series of equally savage clauses. This was a crime not recognized in the penal code, which was therefore to be modified by this law. No attenuating circumstances were to be recognized, as in the general scheme of the penal code. This ferocious legislation was expressly and summarily abrogated in 1830. (J. T. S.*)

English Law.—In English law, sacrilege is the breaking into a place of worship and stealing therefrom. At common law benefit of clergy was denied to robbers of churches. A statute of 1553 made the breaking or defacing of an altar, crucifix or cross in any church, chapel or churchyard punishable with three months' imprisonment on conviction before two justices, the imprisonment to be continued unless the offender entered into surety for good behaviour at quarter sessions. The tendency of the later law has been to put the offence of sacrilege in the same position as if the offence had not been committed in a sacred building. Thus breaking into a place of worship at night, says Coke, is burglary, for the church is the mansion house

of Almighty God. The Larceny Act of 1861 punishes the breaking into, or out of, a place of divine worship in the same way as burglary, and the theft of things sacred in the same way as larceny. Now by the Malicious Damage Act 1861 the unlawful and malicious destroying or damaging any picture, statue, monument or other memorial of the dead, painted glass or other monument or work of art, in any church, chapel, meeting-place or other place of divine worship is a misdemeanour punishable by imprisonment for six months, and in the case of a male under the age of sixteen years with whipping.

SACRISTY (through Fr. *sacristie*, from med. Lat. *sacristia* or *sacristina*), the term in ecclesiastical architecture given to the room or hall in a large church wherein are kept the vestments and utensils (*sacra*) used in the services and celebrations. Like the *diakonikon* in the Greek Church, it was usually situated on the north side of the chancel, but its position varies according to that of the chapter-house, as it is generally placed between the latter and the church.

SACRO BOSCO, JOHANNES DE [JOHN HOLYWOOD] (d. 1244 or 1256), astronomical author, studied at Oxford and was afterwards professor of mathematics at the university of Paris. He wrote a treatise on spherical astronomy, *Tractatus de sphaera*, first printed at Ferrara in 1472. This was the second astronomical work to be printed. Although recording no advance on the Arabian commentaries on Ptolemy, it gained a great reputation; twenty-four editions appeared before 1500, and at least forty between 1500 and 1647, in which year the last edition was published at Leiden. About the year 1232 he wrote *De annatione* or *De computo ecclesiastico* (printed editions at Paris in 1538 (?), 1550, 1572 and at Antwerp in 1547 and 1566), in which he points out the increasing error of the Julian calendar, and suggests a remedy which is nearly the same as that actually used under Gregory XIII. three hundred and fifty years later.

He also wrote *Algorismus* or *De arte numerandi*, printed in 1490 (?), in 1517 (Vienna), 1521 (Cracow), 1523 (Venice); *De astroliabio* and *Breviarum juris*.

SADDLE (a word common to Teutonic languages, cf. Ger. *Sattel*, Dut. *zadel*, also in Russ. *siello* and Lat. *sella*, for *sedla*; it is not derived directly from Lat. *sedile*, which means a chair, but all the words are to be referred to the root *sad-*, which gives Lat. *sedere*, Eng. "sit," "settle," "seat," &c.), a seat, usually of leather, fixed by girths to the back of a horse for riding; also a padded cushion for the back of a draught horse, fastened by girths and crupper; to it are attached the supports for the shafts, and rings for the reins (see **SADDLERY**). The word is also applied to many objects resembling a saddle in shape or function, such as a block to support a spar in a ship, or in machinery to support a rod, or in masonry (*q.v.*) the top or "apex stone" of the gable of a roof, &c.

Saddle bars, in architecture (Fr. *traverses*), are narrow horizontal iron bars passing from mullion to mullion, and often through the whole window from side to side, to steady the stone work, and to form stays, to which the lead work is secured. When the bays of the windows are wide, the lead lights are further strengthened by upright bars, passing through eyes forged on the saddle bars, and called stanchions. When saddle bars pass right through the mullions in one piece, and are secured to the jamps, they have sometimes been called "stay bars."

SADDLERY and HARNESS, two terms which embrace the whole equipment for the horse when used for riding or driving. "Harness" (O. Fr. *harnets*, mod. *harnais*, Ger. *Harnisch*, of unknown origin) was originally a general term for equipment, e.g. the body armour of a soldier. It is now usually confined to the draught horse's equipment, "saddle and bridle" being used of that of the riding horse.

Saddlery is principally a leather trade, and the craft has been established in England as a separate trade since the 13th century, when the London Saddlers' Company received its charter from Edward I. There is evidence also of its early prosperity at Birmingham: the principal seat of the cheaper saddlery trade is now at Walsall. Saddlery's ironmongery embraces the making of buckles, chains, stirrups, spurs, bits, hames, &c.

The "bridle" (O.E. *bridel* for *brigel*, from *bregdan*, to pull) is the combination of straps and buckles which fits on the horse's head, the headstall, together with the bit and reins which it keeps in position. The headstall consists of the headpiece passing behind the ears and joining the head-band over the forehead; the check-straps run down

the head to the bit to which they are fastened; in the driving bridle the "blinkers," rectangular or round leather flaps which prevent the horse from seeing anything except what lies in front, are attached to the check-straps; the nose-band passes round the head above the nostrils and the throat-lash from the top of the check-straps underneath the head. The "martingale" passes between the horse's legs with one end fastened to the girth and the other to the bridle or nose-band. It prevents the horse throwing up his head. The bit is the metal contrivance inserted in the mouth to which the reins are attached. There are innumerable patterns of bits, but they may be divided into the "snaffle" (Du. *snaafel*, horse's muzzle), the "curb" and combinations of the two. The "snaffle" for the riding horse has a smooth jointed steel mouthpiece, with straight cheek-bars, the rings for the reins and cheek-pieces of the headstall being fixed in the bars at the junction with the mouthpiece. A severer snaffle has the mouthpiece twisted and fluted. The bars prevent the horse pulling the bit through the mouth. The snaffle without bars is generally termed a "bridoon." The commonest form of bit used in driving is the double-ring snaffle, in which the rings work one within the other, the headstall straps fastening to one and the reins to the other, or, if the horse is driven on the double ring, the reins are buckled to both rings. The curb-bit (Fr. *courbe*, Lat. *curvus*, bent, crooked) is one to which a curb-chain or strap is attached, fastened to hooks on the upper ends of the cheek-bars of the bit and passing under the horse's lower jaw in the chin groove. The reins are attached to rings at the lower ends of the cheek-bars, the leverage thus pressing the curb-chain against the jaw. The mouthpiece of the curb-bit is unjointed and has in the centre a "port," i.e. a raised curve allowing liberty for the tongue and bringing the pressure on the base of the horse's jaw. The curb-bit and the bridoon can be used together with separate headstalls and reins, but there are many combination bits, such as the Pelham. In this the mouthpiece, without port, is that of the snaffle bit (it may be unjointed), with the rings fixed at the junction of the mouthpiece and cheek-bars; the lower ends have rein rings as in the plain curb-bit.

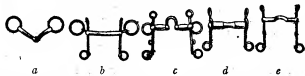

FIG. 1.—a, Bridoon or snaffle; c, Curb. Polo bits—b, Ruggy Pelham; e, Hanoverian with rubber mouth; d, Kerro Pelham. (From Messrs Champion and Wilton.)



FIG. 2.—Some Types of Driving Bits. (From Messrs. Champion and Wilton.)

The riding saddle is composed of the "tree," the framework or skeleton, the parts of which are the pommel or head, the projection which fits over the withers, and the side bars which curve round into the cantle or hind-bow. The tree in the best saddles is made of beechwood split with the grain; thin canvas is glued over the wood to prevent splitting, and iron or steel plates then riveted on the head and on the cantle. Linen webs are fastened lengthwise and across, over which is nailed canvas and serge between which the padding is stuffed. To the tree are fastened the stirrup-bars. The leather covering of the tree should be of pig-skin. Cheap saddles are made of sheep-skin stamped to imitate pig-skin. The various parts of the man's saddle are the seat, the skirt, i.e. the fold or pad of leather on either side of the head, and the hanging flaps; knee-rests are not used as much as they were, except where roughly broken-in horses are ridden. The saddle is cut straight over the withers with a squared cantle, as in the hunting saddle, or cut back over the withers with a round-ended cantle, as in the polo saddle. The saddles in use on the continent of Europe still retain the high pommel and cantle and heavy knee-rests discarded by riders trained in the British school and the hunting-field. The saddles of the East and of the Arabs keep their primitive shape, and they are really seats in which rather than on which the rider sits. The Mexican saddle, with its silver adornments and an embossed leather, is a characteristic type. It has a very high padded pommel and a round-headed projecting cantle.

The lady's side-saddle when first fully developed had two heads or pommels, between which the right leg was supported, the support for the left being the stirrup. The third pommel or "leaping head," against which the left leg rests, was, it is said, invented as the result of a match between two gentlemen riders to ride a steeplechase on side-saddles; the winner had provided himself this support for his left leg. At first the "leaping head" was only used in the

hunting-field and the double cow-horn was still retained; as its usefulness became apparent the second pommel practically disappeared.

Space forbids the discussion of the varieties of harness for the pair-horse carriage, the four-horse coach, the farm wagon, &c., or the different kinds of ornamentation that are or have been lavished upon it. The leather collar, heavily padded, passes over the head and

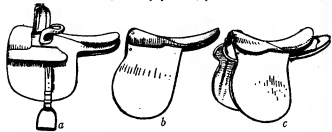

FIG. 3.—a, Side-saddle; b, hunting saddle; c, officer's regulation saddle (British army). (From models made by Messrs Champion and Wilton.)

rests firmly on the shoulders; the hames, linked pieces of metal, fit tightly round it and are fastened at the top by the hame-strap; they bear the traces, or straps which pass along the horse's sides and the shafts and are attached by loops slipped over hooks in the body of the carriage. Where the collar is dispensed with, the traces are attached to a breast-strap against which the horse works. This breast harness is much used for the lightly harnessed American trotting horses, and for military draught horses. The saddle pad is a narrow leather cushion girthed under the belly and held in position by the crupper-dock and the crupper, a loop strap passing under the tail. The saddle supports the shafts by the back-band and its tugs and by the belly-band. The reins pass from the bit through "terrets," or rings on the hames and pad. The harness on the horse's hind-quarters consists of the breeching, passing round behind the horse and helping in backing and stopping the vehicle, the hip-strap fastened to the breeching and passing over the hind-quarters, and the kicking-strap falling across the loins and fastened to the shafts. The bearing rein, when used merely as a support to the head, or as an aid to the improvement of the paces, consists of a separate bridle-neck with the reins passing through rings on the throat-band and thence slipped over a hook on the pad. The severer form, which brings the rein over the head-stall, keeps the horse's head up in a cramped attitude and the mouth continually working on the bit. A recent modification of the severer form is not attached to the bit.

Historical Sketch.—Questions as to the epoch in the history of mankind when the horse was first trained for draught and riding are for archaeologists and anthropologists to discuss (see HORSE, § History). With the domestication of the horse came the development of the bit; first a halter or hide round the muzzle, then a thong slipped into the mouth, finally replaced by wood or bone. Stone age objects have been found in lake-dwellings, such as that at Robenhause, near Zürich which may have been bits; one is slightly curved, with two knobs grooved at either end for the reins. Bits from the bronze age and the iron age can be seen in most museums showing that the forms have changed little. The Scandinavian museums are particularly rich in early remains of harness and horse-trappings. An early bronze age bit of bone with horn cheek-pieces and with holes on the upper ends for the head-stall, and on the lower ends for the reins, was found at the Corellettes lake dwelling, and a twisted bronze bit joined by interlocking rings with straight cheek-pieces and rings and loops for headstall and reins is in the National Museum at Zürich. In the late iron age burial of a Gaulish chief with his chariot at Somme-Bionne were found two horse's bits of the ordinary jointed snaffle type (see ARCHAEOLOGY, plate VI). A heavy snaffle unjointed bit with red and blue enamel ornamentation is illustrated in the British Museum *Guide to the Late Iron Age*. Assyrian and Babylonian monuments show the harness of the chariot horses and the bridling of the riding horse, cf. BABYLONIA AND ASSYRIA, Plate II, fig. 2.

In ancient Greece and Rome the bit and bridle were used during historic times, and allusions to riding without them refer to exhibitions of horsemanship. On Trajan's column the Numidians ride without bridles or bits, and various North African tribes trained their horses to obey their voice alone (cf. Claudian, *Epig.* i. 10, of the Gaulish *essedaris*, driving without bridle and reins). The *locus classicus* for the bridling and saddling of the Greek horse is Xenophon, Περὶ ἵππων. The Greek name for the bridle bit and reins collectively is χαλκίος (Lat. *frenum*), the bit proper is ὄπιον; in Lat. *frenum* is also used of the bit itself. The headstall (ἀρσάβια) and cheek-straps (τραπέαι) were richly decorated. In Homer (*Il.* iv. 142) the latter are ornamented with ivory plates stained with purple, and such have been found on the site of Troy (Schliemann, *Ilios*, 476, 631). The head-band also bore a crest (ὄσος, *crista*), and in front the ἔμυξ (frontale) might be extended down the face to serve as a defence, as in the medieval *chastrein*. This frontale was a special subject of decoration. Of the two principal types of ancient bits, the un-

jointed and the jointed mouthpiece, the latter is the most common form. There are also other forms of bits; those with sharp points were called *isulpa* (Virg. *Georg.* iii. 208). There is a Greek bit in the British Museum with revolving disks, a device which occurs in medieval bits, to give the horse something to keep turning in his mouth. The curb was also used: Xenophon distinguishes between the snaffle (ἄσιος χαλκίος) and the curb. The curb-strap or chain was termed ὄπιον, or ὄπιον, which, however, may mean a muzzle. A bronze bit found at Pompeii has a twisted and jointed metal mouthpiece and a plain curb bar acting as a curb-strap. The cheek-bars of the bit take a variety of forms: straight bars, circles with rays, square or oblong plaques, triangles and the swan-necked or S-shaped type are all found. In medieval times complicated and severe bits were used, and heavy bits with cruel mouthpieces and long elaborately curved cheek-bars are still used by Arabs and the riders of Central and South America. The bit of the armed war-horse in the middle ages was sometimes provided with very long cheek-bars covered with sharp spikes to prevent the foot-soldier catching hold of the bridle (see R. Tschille and R. Forrer, *Die Pferdesterne in ihrer Formen-Entwicklung*, 1903, for illustrations of bits from prehistoric times to the 16th century).

The saddle was not used in Egypt; the Assyrian monuments (cf. the illustration noticed above) chiefly show decorated saddle-cloths rather than any form of the saddle proper. The harness of the chariots of Egypt and Assyria are also illustrated on the monuments (see especially Sir J. G. Wilkinson, *Manners and Customs of the Ancient Egyptians*). The ancient Greeks rode bare-backed as in the Swanthorn frieze of the Parthenon and a saddle-cloth (ἄψιδιον, Lat. *ephippium*; *sella* as applied to a saddle is quite late). Even the saddle-cloth does not appear to have been in use till the 5th century. A 6th-century vase, found at Daphnae, Lower Egypt (Flinders-Petrie and Murray, *Tanis*, 1888, ii. pl. xxix.), shows a woman riding astride on a cloth, with fully developed headstall and powerful bit. A black-figured sarcophagus, now in the British Museum, from Clazomenae, shows a long pointed *ephippium* with a chest-strap. These indicate Asiatic influence, for Daphnae was an Ionian and Carian settlement of the 7th century B.C. In Xenophon (*l.c.*) we find that the saddle-cloth had been adopted by the Athenian cavalry, and from his advice as to the seat to be adopted for riding it seems to have been added. There were no stirrups (till the time of the emperor Maurice, A.D. 602), and the rider mounted at a vault or by blocks; mounting by the spear used as a vaulting pole was also practised as an athletic feat. On a funeral monument of the time of Nero in the museum at Mainz is the figure of a horseman on a saddle-cloth with something resembling the pommel and cantle of a saddle, but the first saddle proper is found in the so-called column of Theodosius at Constantinople (usually ascribed to the end of the 4th century A.D., though it may be more than 100 years earlier), where two figures are riding on high-backed saddles resting on embossed saddle-cloths. In medieval times the saddle was much like that of the Oriental saddle of to-day with high peaks before and behind. In the military saddle of the 14th and 15th century the high front parts of the saddle were armoured and extended to protect the legs of the rider. The jousting saddle (cf. the example in the Tower of London) becomes almost a box into which the rider is fixed; the high cantle fits round the rider's loins and when charging he lifted himself into practically a standing position in the stirrups. The saddle for use on the road or hunting was much like the Arab saddle of to-day, and similar forms are in use in Europe and elsewhere where the Bedouin has not been adopted. Women rode astride or on a pillion behind a male rider. The side-saddle is said to date from the end of the 12th century. For the harness of the ancient draught horse see CHARIOT.

BIBLIOGRAPHY.—J. C. Ginzor, *Wagen u. Fahrverke d. Griechen u. Römer*, &c. (1877); Daremberg and Saglio's *Dict. des antiquités grecques et rom.*, s.v. "Ephippium," "Frenum," &c.; Viollet-le-Duc's *Dict. rais. du mobilier français*, and the works referred to in the text. See ALSO DRIVING, RIDING and HORSE. (C. WE.)

SADDLEWORTH, an urban district in the Colne Valley parliamentary division of the West Riding of Yorkshire, England, 14 m. N.E. of Manchester, on the London & North Western railway. Pop. (1901) 12,320. It lies on the western side of the elevation of Stanedge, which here forms the watershed between streams flowing westward to the Irish Sea and eastward to the North Sea. Early earthworks and tumuli are numerous in the locality. The Huddersfield canal follows the valley, and, like the railway, is carried under Stanedge by a long tunnel.

SADDUCEES, a sect or party of the Jews mentioned in the historical books of the New Testament (with the exception of the fourth Gospel), by Josephus, and in the Talmud. According to all the authorities, the essential qualification for the title is the denial of certain beliefs which the Pharisees held to be implicitly contained in Scripture, and therefore necessarily part of Judaism as soon as they were formulated. From their own point of view they were orthodox conservatives, so far as they really cared to remain—for whatever reason—within the pale of Jewry and

to justify their presence there. From the standpoint of the Pharisees who championed the hope of everlasting life and believed in the existence of angels, through whom God could communicate with men, they were infidels. As the Pharisees accumulated the oral tradition which was afterwards codified and elaborated or preserved by fragments, which served some useful purpose, in the Talmud and other Rabbinic writings, the Sadducees acquired concrete regulations to oppose so long as they dared. The Pharisees even improved upon the Temple ritual, and their popularity enabled them to force the Sadducees into adopting the improvements.

But though some of those who bore the title may be reckoned at their best as orthodox conservatives, their position was, as far as our mainly *Pharisaic* authorities permit us to learn, merely negative; and all the information we possess, whether it rests on facts or on prejudice, points to their close affinity with the Jews who renounced their faith altogether and advertised the fact—say by habitual and unwarranted breach of the Sabbath, for example. In fact, broadly speaking, the Sadducees for the period during which they are reported to exist, represent and embody the tendency to conformity with neighbouring Gentiles, which is deplored and denounced by Jewish writers from Moses to Philo. And there is this to be said that idolatry may be an outward symbol of a real indebtedness to idolaters which is not necessarily wiped out when the tangible idols are smashed. Idolatry is plainly incompatible with the law of Moses: so were Greek caps; but the Jews who conformed to Hellenism in the time of Antiochus Epiphanes acquired much that was conserved and utilized in that great attempt to convert the Greek world to Judaism, whose best monument is the works of Philo. The process is normal: first, there is an unqualified adoption of a foreign culture by the Sadducees of the time being; then, after unqualified opposition, the Pharisees of the time admit whatever is admissible within the four corners of the Law and are confronted by other Sadducees who have not followed the first into temporary or permanent separation from the existing Jewish way of life and absorption in the immediate foreign environment, and who, therefore, will have none of the current innovations which the Pharisees have in course of time selected as capable of assimilation and reconciliation with the existing body of growing doctrine and practice. The Jews spoiled the Egyptians: some made a golden calf and worshipped it; others destroyed it and turned the spoils into vessels for the sanctuary: some again sighed for the fleshpots of Egypt, if they did not actually return thither.

The controversies of the Pharisees and Sadducees afford a typical example of this process. With the approval of Antiochus Epiphanes, the Sadducee section embraced the outward forms of Hellenism, and out of the persecution of the orthodox which followed was born the hope of a future life which was in the circumstances the necessary corollary of God's righteousness and was discovered to be latent in Scripture. Later Sadducees, who actually bore the name, resisted this and all the characteristics of the Pharisees and continued to flatter the predominant foreigner—Greek or Roman—by imitating him with less reckless bravado than the first Hellenizers and with growing assurance. They were men of the world, and men of *this* world, and, so far as they still professed and practised Judaism, they preferred to repudiate the additions for which they felt no need, but which had entered into the faith of their fathers. The Pharisees, who pruned and fed the tree of Judaism so that it might bear fruit for the healing of the Nation—and the nations in the latter days—gave them the opportunity of posing as the champions of the primitive standards. But, though the reformers thus played into the hands of the Sadducees, the people were not deceived by the badge which Sadducee priests adopted and paraded to save their faces: they loved the Pharisees and were ready to go to death at their bidding. The Sadducees were the hypocrites of the Jewish world, just as the Epicureans were the hypocrites of the Greek world. The rest of the Jews rated the Sadducees as atheists, just as the rest of the Greeks rated the Epicureans as atheists and discerned, as Plutarch said, the sardonic grin

behind the mask of their obsequious devotion to the ceremonies at which the force of public opinion compelled their attendance. The Sadducee was a Jew outwardly so long as he so retained place, power and profit. The destruction of Jerusalem, long before it was consummated in A.D. 70, robbed them of the place and nation which alone compensated them for the inconveniences of their nominal allegiance. They knew well enough the power of invincible Rome; and her advance warned them to take themselves and their talents to the market of the wide world, to which in heart and mind they had always belonged.

Josephus (*Ant.* xiii. 5. 9, §§ 171-173, Niese) introduces the Sadducees along with the Pharisees and Essenes in his account of Jonathan's reign (101-143 B.C.) as the third of the sects of the Jews, and defines their tenets thus: "They deny the existence of God (Josephus says 'Fate,' as he is speaking to pagans) and the Divine government of human affairs; and they assert that everything lies in our power, so that we are responsible for our good or bad fortune." Similarly, in the earlier history of the Jewish War (ii. 8. 14, §§ 164-166, Niese) to which he refers, he says: "The Sadducees do away with Destiny altogether and set God beyond the possibility of punishing or supervising men. They assert that man is free to choose good or evil since both are set before him, and that he receives good or evil according to his choice. They deny the immortality of the soul and the punishments and rewards of Hades. In contrast with the mutual friendliness and loyalty of the Pharisees, their behaviour towards one another is lacking in courtesy, and when they mix with their fellow-countrymen, they are as offhanded as if their fellows were aliens." Josephus might have added that they were disposed to treat aliens as they should have treated their friends.

In the New Testament there is already a tendency to ignore the Sadducees and to transfer to the surviving and active sect of the Pharisees denunciations addressed to hypocrites. The feud which set Pharisee and Sadducee against one another is ignored, and generally the condign oblivion which overtook this sect of the Jews is already beginning. "The Christian Fathers seem to confound them with the Samaritans, and the confusion is natural enough. The Sadducees were as little loyal to the Judaism of Jerusalem as the Samaritans—and they were less sincere and less interested in religion.

The Talmud reports ancient controversies on points of law; and gives the Sadducee a founder, Zadok the disciple of Antigonus the man of Socco who prohibited the hope of reward for service done to God. But this explanation of the name is as worthless as the rest of the Talmudic accounts of the Sadducees who were already dead and gone. For the present the explanation put forward by A. E. Cowley (*Encyc. Bib.* 4236) holds the field: a Persian word *Zindik* meaning *Zoroastrian*, and therefore infidel in the mouths of those who did not hold with Zoroaster, was applied to them by their opponents, and gradually altered so as to mean something in Hebrew—*i.e.* *Zadokite* or *Righteous*. Its acquired significance could be varied by the inflexion of the voice or the suggestion of inverted commas.

Schlörer (*Geschichte des jüdischen Volkes*, ii. 4th ed., pp. 447-456, 475-489) gives the evidence of the ancient authorities and references to modern studies of the subject. See also *Jews*. (J. H. A. H.)

SADE, DONATIEN ALPHONSE FRANÇOIS, COUNT [usually called the MARQUIS DE SADE] (1740-1814), French licentious writer, was born in Paris on the 2nd of June 1740. He entered the light-horse at fourteen and saw considerable military service before returning to Paris in 1766. Here his vicious practices became notorious, and in 1772 he was condemned to death at Aix for an unnatural offence, and for poisoning. He fled to Italy, but in 1777 he was arrested in Paris, removed to Aix for trial, and there found guilty. In 1778 he escaped from prison, but was soon re-arrested and finally committed to the Bastille. Here he began to write plays and obscene novels. In 1780 he was removed to the Charenton Lunatic Asylum, but was discharged in 1790, only to be recommitted as incurable in 1803. He died there on the 2nd of December 1814. Among his works, all of the type indicated, were *Justine* (1791), *Juliette* (1792), *Philosophie dans le boudoir* (1793) and *Les Crimes de l'amour* (1800). The word Sadism, meaning a form of sexual perversion, is derived from his name.

SÁ DE MIRANDA, FRANCISCO DE (1485-1558), Portuguese poet, was the son of a canon of Coimbra belonging to the ancient and noble family of Sá, and passed his early years by the banks of the river Mondego, the source of inspiration to poets in every age. He probably made his first studies of Greek, Latin and philosophy in one of the colleges of the Old City, and in 1505 went to Lisbon University, beginning at the same time to frequent

the court. Verse-making and gallantry occupied much of his time there, and by virtue of his talents and name he became one of a group comprising the greatest nobles and most celebrated poets of the age, including Bernardim Ribeiro and Christovão Falcão, who surrounded the beautiful and gifted D. Leonor de Mascarenhas. He seems to have resided for the most part in the capital down to 1521, dividing his time between the palace and the university, in the latter of which he had taken the degree of doctor of law by 1516. Honoured by the friendship of Prince John (afterwards John III.), he accompanied the court as it moved from place to place during the reign of King Manoel, and witnessed the triumphs of the Fortunate Monarch; and at a time when the flag of Portugal floated victorious in every sea and her ships encircled the globe, it was not surprising that the youthful poet should aspire to be the Virgil of a new Augustus ruling a universal monarchy. His studious and reflective mind and sound sense did not allow him, however, to nourish these illusions for long, and we find him pointing out in tones of prophetic melancholy the signs of decadence and future disaster. He had come out of the university so good a lawyer that he was able to act as *ad interim* professor of his faculty, and he was offered a judicial post, but his independent spirit and punctilious conscience led him to refuse it. He had only embarked on a legal career to please his father, and on the latter's death he abandoned law for moral and stoic philosophy and poetry, and resolved to travel. He had observed with regret the modest intellectual position of his country, for all her wealth and epic achievements, the latter of which had found no echo in poetry; and if he were to learn and be able to introduce new forms of art fed by fresh ideals, as he desired, he felt he must go abroad. The *Cancioneiro de Resende*, which represented the poetical efforts of courtiers for almost a century and contained Miranda's early verses, showed the extent of the national poverty by its artificiality, and lack of ideas, of sincerity and of good taste. These defects are not surprising, seeing that during most of that long period the literary movement had been confined to court circles and had remained essentially imitative of Spanish models, with hardly a vestige of national or popular inspiration about it. Portugal had been too busy building up a world-empire to imbibe much of the mental culture of the Renaissance, and even the classics were for the most part only known through Spanish translations. Direct intercourse between Portugal and Italy partook of a commercial rather than a literary or artistic character, and, previously to Miranda's journey, Italian poetry was practically unknown.

In the middle of July 1520 he set out across Spain for Italy, and spent the years 1521 to 1525 abroad, visiting Milan, Venice, Florence, Rome, Naples and Sicily "with leisure and curiosity." He enjoyed intimacy with Giovanni Rucellai, Lattanzio Tolomei and Sanazarro; he saluted the illustrious Vittoria Colonna, a distant connexion of his family, and in her house he probably talked with Bembo and Ariosto, and perhaps met Machiavelli and Guicciardini. He assisted at the rebirth of the Italian drama and saw the performance of classical prose comedies, a form of art which he was to transplant to Portugal. Lastly he heard the echoes of the Protestant revolt, and witnessed with horror the dissolution of morals which prepared the way for the Reformation.

Returning home in 1525, he brought with him the sonnet and canzone of Petrarch, the tercet of Dante, the *ottava rima* of Ariosto, the eclogue in the manner of Sanazarro, and Italian endecasyllabic verse. He did not, however, like his disciple Antonio Ferreira (*q.v.*), abandon the national *redondilha*, but rather continued to employ it and carried it to perfection in his *Cartas*. Settling down in Coimbra or its environs, he lived there from 1526-1527 until 1532. The visit of King John III. and his court to the city enabled him to resume his old relations with the reigning house and the cultivated members of the nobility, who received him affably and listened with interest to the story of his Italian tour. Gil Vicente, the court dramatist, was then at the height of his fame, but his *autos* appeared poor things to Sá de Miranda as compared with the comedies he had seen in Italy; and urged by his friends to present an example of the new style, he wrote the *Estrangeiros*. Produced in 1527-1528, it was

the first Portuguese prose comedy, and was composed on the lines of the classical Roman drama as modified by contemporary Italian authors like Ariosto; it had a great and immediate success, notwithstanding the opposition of the partisans of the popular auto, who saw themselves attacked in the prologue. In 1528 Miranda made his first real attempt to introduce the new forms of verse by writing in Spanish a canzone entitled *Fabula do Mondego*, and in 1530-1532 he followed it up with the eclogue *Aleixo*, which among its redondilhas has some endecasyllables—the earliest attempt at *ottava rima* in Portuguese. Various sonnets dedicated to friends also belong to this period. The foundations of the Italian school were now laid, and henceforth Miranda's reputation as a poet grew visibly, while he was also one of the most esteemed of courtiers; but the opposition of his literary foes increased with his very success. Moreover, in the sphere of politics pessimism had taken firm hold of him. From being a land of promise, India had become for him, as for Camoens, "the mother of villains, the stepmother of men of honour"; and though the wealth of the East poured into Lisbon, Portugal remained poor because agriculture was neglected and corn had to be imported from abroad. Miranda protested in vigorous terms against the fever of adventure and lust of gold, but few gave ear to his moralizings or had leisure to read poetry, and in 1534 he left the court.

The year 1532 had marked his passage from the active to the contemplative life, and the eclogue *Basto*, in the form of a pastoral dialogue written in redondilhas, opened his new manner. It has a pronounced personal note, and its episodes are described in a genuinely popular tone. The shepherds Gil and Bento represent, the one city sociability, the other rustic aloofness, or the contrast between life at court and in the country, and serve as a vehicle for the poet's ideas. The same epoch saw the composition of his *Cartas* or sententious letters in quintilhas, which, with *Basto* and his satires, make up the most original, if not the most valuable, portion of his legacy, and served as models for two centuries. His *allego* in *Aleixo* to the exile of Bernardim Ribeiro, and his defence of his friend, seem to have offended that powerful grandee, the count of Castanheira, and probably hastened his retirement from court, and the royal gift of a Comenda of the Order of Christ, situate by the river Neiva on the borders of Galicia, came opportunely, because the rents Sá de Miranda drew from it and a small private fortune enabled him to live in modest comfort at the neighbouring Quinta da Tapada. Poetry with him was never a mere pastime, and, after a short period of repose, the gift of a MS. of the verses of Garcilasso and Boscán, founders of the Italian school in Castile, encouraged him to resume the work of reform commenced at Coimbra; between 1535 and 1538 he composed five eclogues in endecasyllables, four in Spanish and one in Portuguese, which show evident traces of his influence.

Before long he heard echoes of his new song, first from the province, then from the court. In 1536 he married D. Briolanja de Azevedo, a lady of rare qualities and education, belonging to an illustrious Minho family. He spent the rest of his life in retirement at the Quinta da Tapada, which became a centre from which the reform of Portuguese poetry spread; for he developed great poetical activity in his retreat, and while he read and annotated Homer in the original Greek, he did not disdain domestic pleasures and country sports. His evenings were occupied by music and the performance of comedies and mimes, and by readings of Bembo and Ariosto with cultivated neighbours; and he extended hospitality to savants like Nicholas Cleynarts and Francisco de Hollanda, and launched on the career of letters such men as Diogo Bernardes, the author of the *Lima*.

In 1538 he wrote his second classical prose comedy, the *Vilhalpandos*, which was played before the Cardinal Infant Henry, afterwards king, at his request, and on the poet's death that prince saw to the printing of this and the earlier comedy. During the years 1543 to 1553, except for a few occasional poems Sá de Miranda kept silence, and the cause is not far to seek; the Inquisition had got to work, and the Jesuits had acquired control of the university and displaced the humanists. When

the king and court lent their presence to *autos da fé* and organized public penances, initiating a reign of fanaticisms and sadness, there was no place for poetry. Sá de Miranda could only deplore in private the misfortunes of his country and devote himself to polishing his verses and educating his children. His life's work was done, for the year 1550 saw Camoens writing his admirable sonnets, canzons and elegies, and the Italian school had definitely triumphed. The last eight years of Sá de Miranda's life produced a cycle of beautiful poems evoked by the personality of Prince John, the heir-apparent, who loved letters and especially poetry, and whose precocity of talent made him the hope of all patriots. In 1550 and 1551, after the prince's visit to the university of Coimbra, he honoured the master by asking for a collection of his poems, and on three occasions we find the latter despatching portions of his song-book to Lisbon accompanied by dedicatory sonnets. Moreover, he had the further gratification of receiving verses from Antonio Ferreira, Jorge de Montemayor, Diogo Bernardes, and André Falcão de Resende, which were so many proofs of the vitality of his school. Three misfortunes, however, came on him in quick succession. He lost his eldest son in 1553, Prince John died in 1554, and in 1555 his wife died. His friend King John III. passed away in 1557, and on the 15th of March 1558 Sá de Miranda followed him to the grave.

He was not a great writer and never entered into the hearts of his countrymen, remaining the poet of the cultured, who could understand him and pardon his metrical imperfections. He led the way, however, in a revolution in literature, and especially in poetry, which under his influence became higher in aim, purer in tone and broader in sympathy. He is obviously not at ease in the new forms which he had introduced, and his verse is, as a rule, austere, unharmonious and often difficult to understand, but these remarks do not, of course, apply to his redondilhas. Some of his sonnets are, however, admirable, and display a grave tenderness of feeling, a refinement of thought, and a simplicity of expression which give them a high value. As examples it is only necessary to mention the one beginning "O sol he grande . . ." and the lines he composed on the death of his wife. Sá de Miranda wrote much and successfully in Castilian, several of his best eclogues being in that language. The charm of these compositions lies in their convincing descriptions of natural scenery and country life, which he loved and comprehended to perfection.

Sá de Miranda's works were first published in 1595, but the admirable critical edition of Madame Micheliés de Vasconcellos (Halle, 1885), containing life, notes and glossary, supersedes all others so far as the poems are concerned. His plays can best be read in the 1784 edition of the collected works. No modern or critical edition is available. See also Oswald Crawford, *Portugal Old and New* (London, 1880); Dr Sousa Viterbo, *Estudos sobre Sá de Miranda* (3 parts, Coimbra, 1895-1896); Decio Carnciro, *Sá de Miranda e a sua obra* (Lisbon, 1895); and Dr Theophilus Braga, *Sá de Miranda* (Oporto, 1896).

SADHU, a Hindu ascetic, corresponding to the Mahomedan fakir (*q.v.*). The Sadhus, who are known also as Sanyasis, Gosains and Bairagis, are of various sects, hold peculiar opinions, indulge in strange practices, and subject themselves in many cases to cruel hardships and fantastic disciplines. They range in moral standing from the peripatetic philosopher to the idle vagabond. Some lead the life of contemplation, which Hindus consider especially holy; others pose as alchemists, physicians, fortune-tellers, palmists or acrobats; while others yet again practise voluntary tortures, such as holding one arm upright until it withers, or lying continually upon a bed of spikes. Some go about almost naked, or smeared all over with ashes; but the usual garment of an ascetic is stained an orange red with ochre. Hence was derived the colour of the Maharrata flag. Alone among Hindus their dead are buried instead of being burned, usually in a sitting posture, and often in salt. During the disturbed period of Indian history, before British rule was firmly established, armed bodies of Sanyasis or Gosains attached themselves to the Maharrata armies, and also ravaged Northern Bengal in the time of Warren Hastings.

SA'DI (*c.* 1184-1292). MUSLĪ-UDDĪN, or more correctly MUSHĀRĪF-UDDĪN B. MUSLĪ-UDDĪN, the greatest didactic poet and the most popular writer of Persia, was born about

1184 (A.H. 580) in Shiraz. After the premature death of his father he was taken under the protection of Sa'd b. Zengi, the atābeg of Fars, who sent him to pursue his studies in the famous medresseh of Baghdad, the Niẓāmiyya, where he remained about thirty years (1196-1224). About 1210 (A.H. 606) his literary fame had spread as far as Kashgar in Turkistan, which the young poet (who in honour of his patron had assumed the name of Sa'di) visited in his twenty-sixth or twenty-seventh year. After mastering all the dogmatic disciplines of the Islamic faith he turned his attention first to practical philosophy, and later on to the more ideal tenets of Sufic pantheism, under the spiritual guidance of the famous sheikh Shihāb-uddīn Umar Suhrawardī (died 1234; A.H. 632). Between 1220 and 1225 he paid a visit to a friend in Isfahan, went from there to Damascus, and returned to Isfahan just at the time of the inroads of the Mongols, when the atābeg Sa'd had been deposed by the victorious Khwarizm ruler of Ghiyāss-uddīn (1226). Sadly grievous by the misfortune of his patron and disgusted with the miserable condition of Persia, Sa'di quitted Shiraz and entered upon the second period of his life—that of his wanderings (1226-1256). He proceeded via Balkh, Ghazni and the Punjab to Gujārat, on the western coast of which he visited the famous shrine of Siva in Somnath. After a prolonged stay in Delhi, where he learnt Hindustāni, he sailed for Yemen. Overcome with grief at the loss of a beloved child (when he had married is not known), he undertook an expedition into Abyssinia and a pilgrimage to Mecca and Medina. Thence he directed his steps towards Syria and lived as a renowned sheikh for a considerable time in Damascus, which he had once already visited. There and in Baalbek he added to his literary renown that of a first-rate pulpit orator. Specimens of his spiritual addresses are preserved in the five homilies (on the fugitiveness of human life, on faith and fear of God, on love towards God, on rest in God and on the search for God). At last, weary of Damascus, he withdrew into the desert near Jerusalem and led a solitary wandering life, till one day he was taken captive by a troop of Frankish soldiers, brought to Tripoli, and condemned to forced labour in the trenches of the fortress. After enduring countless hardships, he was eventually rescued by a rich friend in Aleppo, who paid his ransom, and gave him his daughter in marriage. But Sa'di, unable to live with his quarrelsome wife, set out on fresh travels, first to North Africa and then through the length and breadth of Asia Minor and the adjoining countries. Not until he had passed his seventieth year did he return to Shiraz (about 1256; A.H. 653). Finding the place of his birth tranquil and prosperous under the wise rule of Abūbākr b. Sa'd, the son of his old patron (1226-1260; A.H. 623-658), the aged poet took up his permanent abode, interrupted only by repeated pilgrimages to Mecca, and devoted the remainder of his life to Sufic contemplation and poetical composition. He died at Shiraz in 1292 (A.H. 691) according to Hāmdallāh Mustaufi (who wrote only four years later), or in December 1291 (A.H. 690), at the age of 110 lunar years.

The experience of the world gained during his travels, his intimate acquaintance with the various countries he had visited, his insight into human character, together with an inborn loftiness of thought and the purest moral standard, made it easy for Sa'di to compose in the short space of three years his two masterpieces, which have immortalized his name, the *Būstān* or "Fruit-garden" (1257) and the *Gulistān* or "Rose-garden" (1258), both dedicated to the reigning atābeg Abū Bekr. The former, also called *Sa'dīnāma*, is a kind of didactic epopee in ten chapters and double-rhymed verses, which passes in review the highest philosophical and religious questions, not seldom in the very spirit of Christianity, and abounds with sound ethical maxims and matchless gems of transcendental speculation. The latter is a prose work of a similar tendency in eight chapters, interspersed with numerous verses and illustrated, like the *Būstān*, by a rich store of clever tales and charming anecdotes; it discusses more or less the same topics as the larger work, but has acquired a much greater popularity in both the East and the West, owing to its easier and more varied style, its attractive

lessons of practical wisdom, and its numerous *bons mots*. But Sa'di's *Diwān*, or collection of lyrical poetry, far surpasses the *Bisṭān* and *Gulistān*, at any rate in quantity, whether in quality also is a matter of taste. Other minor works are the Arabic *qaṣidas*, the first of which laments the destruction of the Arabian caliphate by the Mongols in 1258 (A.H. 656); the Persian *qaṣidas*, partly panegyric, partly didactical; the *marāthī*, or elegies, beginning with one on the death of Abū Bekr and ending with one on the defeat and demise of the last caliph, Mosta'sim; the *mulamma'ā*, or poems with alternate Persian and Arabic verses, of a rather artificial character; the *tarjī'āt*, or refrain-poems; the *ghazals*, or odes; the *shāhībiyyah* and *muḥatta'āt*, or moral aphorisms and epigrams; the *rubā'iyyāt*, or quatrains; and the *mufraddāt*, or distichs. Sa'di's lyrical poems possess neither the easy grace and melodious charm of Ḥāfiẓ's songs nor the overpowering grandeur of Jelālūd-dīn Rūmī's divine hymns, but they are nevertheless full of deep pathos and show such a fearless love of truth as is seldom met with in Eastern poetry. Even his panegyrics, although addressed in turn to almost all the rulers who in those days of continually changing dynasties presided over the fate of Persia, are free from that cringing servility so common in the effusions of Oriental encomiasts.

The first who collected and arranged his works was 'Alī b. Ahmad b. Bisūtūn (1326-1334; A.H. 726-734). The most exact information about Sa'di's life and works is found in the introduction to Dr W. Bacher's *Sa'di's Aphorismen und Sinngedichte (Shāhībiyyah)* (Strassburg, 1879; a complete metrical translation of the epigrammatic poems), and in the same author's "Sa'di Studien," in *Zeitschrift der morgenländischen Gesellschaft*, xxx. pp. 81-106; see also H. Ethé in *W. Geiger's Grundriss der iranischen Philologie*, ii. pp. 292-296, with full bibliography; and E. G. Browne, *Literary History of Persia*, pp. 525-539. Sa'di's *Kulliyāt* or complete works have been edited by Harrington (Calcutta, 1791-1795) (with an English translation of some of the prose treatises and of Daulat Shah's notice on the poet, of which a German version is found in Graf's *Rosengarten* (Leipzig, 1840 p. 229 sq.); for the numerous lithographed editions, see Rieu's *Fers. Cat. of the Brit. Mus.* ii. p. 596. The *Bisṭān* has been printed in Calcutta (1810 and 1828), as well as in Lahore, Cawnpore, Tabriz, &c., a critical edition with Persian commentary was published by K. H. Graf at Vienna in 1850 (German metrical translations by the same. Jena 1850, and by Schlechta-Wssehrd, Vienna, 1852); English prose translations by H. W. Clarke (London, 1879), and Ziauddin Gulam Mohiddin (Bombay, 1889); verse by G. Davy (Paris, 1882); French translation by Barbier de Meynard (Paris, 1880). The best editions of the *Gulistān* are by A. Sprenger (Calcutta, 1851) and by Platts (London, 1874); the best translations into English by Eastwick (1852) and by Platts (1873), the first four *bābs* in prose and verse by Sir Edwin Arnold (1899); into French by Deffremery (1858); into German by Graf (1846); see also S. Robinson's *Persian Poetry for English Readers* (1883), pp. 245-366. The *Pandānah*, or book of wisdom (of doubtful genuineness) has been translated by A. N. Wollaston (1908), with Persian text. Select *qaṣidas*, *ghazals*, elegies, quatrains and distichs have also been edited, with a German metrical translation, by Graf, in the *Z.D.M.G.* ix. p. 92 sq., xii. p. 82 sq., xiii. p. 445 sq., xv. p. 541 sq. and xviii. p. 60 sq. On the Süfī character of Sa'di in contrast to Ḥāfiẓ and Rūmī, comp. Ethé, "Der Süfismus und seine drei 'hauptvertreter,'" in *Morgenländische Studien* (Leipzig, 1870), pp. 95-124. (H.E.)

SADIYA, the extreme north-east frontier station of British India, in the Lakhimpur district of Eastern Bengal and Assam. It stands high on a grassy plain, nearly surrounded by forest-clad mountains, on the right bank of what is locally (but erroneously) considered the main stream of the Brahmaputra. On the opposite bank a railway has recently been opened which connects with the Assam-Bengal line. Sadiya is garrisoned by detachments of native infantry and military police, and is the base of a chain of outposts. There is a bazaar, to which the hill-men beyond the frontier—Mishmis, Abors and Khamtis—bring down rubber, wax, ivory and musk, to barter for cotton-cloth, salt, metal goods, &c.

SADLER, MICHAEL THOMAS (1780-1835), English social reformer and economist, was born at Snelston, Derbyshire, on the 3rd of January 1780. Settling down in business in Leeds in 1800, he early took an active part in political life, devoting himself particularly to the administration of the poor law. In 1828 he wrote *Ireland: its Evils and their Remedies*, in which he advocated a poor-law, and a tax on absenteeism. He also took a share in the Malthusian controversy, writing *The Law of Population: a Treatise in Disproof of the Superfecundity of*

Human Beings and developing the Real Principle of their Increase (1830). He entered parliament in 1829 as member for Newark, and devoted his efforts to questions of social reform. He took a leading part in the agitation for the prevention of child labour in factories—he was chairman of the committee appointed to inquire into the subject. He contested Leeds after the Reform Bill of 1832 (Aldborough, for which he had sat after Newark, being deprived of its member), but was defeated by Macaulay. In 1834 he was unsuccessful at Huddersfield, and failing health prevented any further attempts to re-enter parliament. He settled down in Belfast, where his firm had business interests, and died at New Lodge on the 20th of July 1835.

See R. B. Seeley, *Memoirs of M. T. Sadler* (1842).

SADLER (or SADLER), SIR RALPH (1507-1587), English statesman, the son of Henry Sadler, steward of the manor of Cilney, near Great Hadham, Hertfordshire, was born at Hackney, Middlesex, in 1507. While a child he was placed in the family of Thomas Cromwell, afterwards earl of Essex, whose secretary he eventually became. Between 1525 and 1529 his patron's letters are full of Sadler's name in connexion with Cardinal Wolsey's suppression of the monasteries; this probably brought him under the king's notice, for in 1536 he was made gentleman of the privy chamber, and from that time was continually employed by Henry VIII. In 1537 Sadler went first to Scotland to try to reconcile Margaret to her son King James V., and then to France on the same mission to James himself. He seems to have been successful, and was again in Scotland in 1540 trying to induce the king to follow his uncle's ecclesiastical policy. In or about January 1540, he was made secretary of state along with Sir Thomas Wriothesley, and was knighted, probably about the same time. On James V.'s death Sadler again went to Scotland (March 1543) to negotiate a marriage between prince Edward and his cousin Mary; he was unsuccessful, but still retained Henry's confidence. On Henry's death in 1547, Sadler was by his will made one of the councillors to the sixteen noblemen entrusted with the young king's guardianship. In the same year he was appointed treasurer to the army sent to Scotland, and for his services in rallying the repulsed cavalry at the battle of Musselburgh or Pinkie, he was created a knight-bannetier. He also received many grants of land, including the manor of Standon in Hertfordshire, where he built a magnificent house in 1546. When Mary ascended the throne he retired, living quietly till Elizabeth's accession. He issued the writs for the privy council meeting at Hatfield on the 20th of November 1558, and during the first year of the queen's reign he once more became a privy councillor. He sat in the parliament of January 1558-1559 as member for Hertford, which he had already represented in 1541, 1542 and 1553. Not long afterwards his strong Protestant sympathies and his acquaintance with Scotch affairs induced Elizabeth to send him (1559) to Scotland, ostensibly to settle the border disputes, but in reality to secure a union with the Protestant party there, and he was largely instrumental in bringing about the treaty of Leith, July 6th, 1560. In 1568 Sadler was appointed chancellor of the duchy of Lancaster, and in the same year was one of the English Commissioners employed in treating on the matters arising from the flight of the Queen of Scots. From this time he seems to have been continually engaged as a discreet and trusty servant in connexion with Mary's captivity, and was frequently sent with messages to her. On the 25th of August 1584, when, owing to the imputations made by his countess, George 6th earl of Shrewsbury was allowed to resign his guardianship of the Queen, Sadler was appointed to succeed him. In September Mary was removed from Sheffield to Wingfield and thence early in 1585 to Tutbury. In April, Sadler, after numerous petitions on his part, was permitted to resign his distasteful charge. He is said by some to have been sent to Scotland to announce to James VI. his mother's death, but this is not corroborated by the state papers. On the 30th of March 1587 Sadler died at Standon, and was buried in the church there. He had married about 1534 Elizabeth Mitchell,

whose first husband Matthew Barre had deserted her and was believed to be dead. Barre, however, re-appeared a few years later, and Sadler then obtained an act of parliament legitimizing his children. Sadler was not a brilliant statesman, but a most faithful and intelligent servant. His letters, particularly those on Scottish affairs, are most interesting.

BIBLIOGRAPHY.—*Letters and Negotiations of Sir Ralph Sadler* (Edinburgh, 1720); *The State Papers and Letters of Sir R. Sadler*, ed. Arthur Clifford, with a memoir by Sir Walter Scott (Edinburgh, 1809, 3 vols.); article by N. H. N. in *Gentleman's Magazine* for March, 1835; J. M. Cussans, *Hist. of Hertfordshire* (1870-1871, 3 vols.); *Memoir of the Life and Times of Sir R. Sadler*, by F. Sadleir Stoney (1877); *Life and Letters of Thomas Cromwell*, by R. B. Merriman (Oxford, 1902, 2 vols.).

SADO, an island belonging to Japan, lying 32 m. W. of Niigata, on 38° N., 138° 30' E. It has a circumference of 130 m., an area of 336 sq. m. and a population of 113,000. The port is Ebisa, on the east coast; and at a distance of 16½ m., near the west coast, is the town of Aikawa, having in its vicinity gold and silver mines, for which Sado is famous. They have been worked from very early times. Sado consists of two parallel hill ranges separated by a lower isthmus; the loftiest peak is that of Kimpokuzan (3815 ft.), to the north of Aikawa.

SADOLETO, JACOPO (1477-1547), Italian humanist and churchman, was born at Modena in 1477, and, being the son of a noted jurist, was designed for the same profession. He gave himself, therefore, to humanistic studies and acquired reputation as a Latin poet, his best-known piece being one on the group of Laocoon. Passing to Rome, he obtained the patronage of Cardinal Carafa and adopted the ecclesiastical career. Leo X. chose him as his secretary along with Pietro Bembo, and in 1517 made him bishop of Carpentras. Sadoleto had a remarkable talent for affairs and approved himself a faithful servant of the papacy in many difficult negotiations under successive popes, especially as a peacemaker; but he was no bigoted advocate of papal authority, and the great aim of his life was to win back the Protestants by peaceful persuasion—he would never countenance persecution—and by putting Catholic doctrine in a conciliatory form. Indeed his chief work, a *Commentary on Romans*, though meant as a prophylactic against the new doctrines, gave great offence at Rome and Paris. Sadoleto was a diligent and devoted bishop and left his diocese with reluctance even after he was made cardinal (1536). His piety and tolerant spirit, combined with his reputation for scholarship and eloquence and his diplomatic abilities, give him a unique place among the churchmen of his time. He died in 1547.

His collected works appeared at Mainz in 1607, and include, besides his theologico-irenic pieces, a collection of *Epistles*, a treatise on education (first published in 1533), and the *Phaedrus*, a defence of philosophy, written in 1538. The best collection is that published at Verona (1737-1738); it includes the life by Fiordibello. See also Péricaud, *Fragments biographiques sur Jacob Sadoleto* (Lyons, 1849); Joty, *Étude sur Sadoleto* (Caen, 1857); Balan, *Monumenta*, vol. 1. (Innsbruck, 1885); Rochini's edition of the letters (Modena, 1872).

SADOLIN, JØRGEN (c. 1499-1559) Danish reformer, the son of Jens Christensen, a curate and subsequently a canon of Viborg cathedral, and consequently, in all probability, born (c. 1499) out of wedlock, as his Catholic opponents frequently took care to remind him. He himself never used the name Sadolin, which seems to have been invented subsequently by his son Hans, and points to the fact that the family were originally saddle-makers. We first hear of him on the 1st of December 1525, when Frederick I. permitted him to settle at Viborg to teach young persons of the poorer classes "whatever might be profitable." On this occasion he is described as "magister" and no doubt got his degree abroad, where he seems to have been won for the Reformation. He sided with Hans Tausen when the latter first began to preach the gospel at Viborg, and Tausen, though himself only in priest's orders, shortly before he left the place, ordained Sadolin (1529). Amongst "the free priests" who attended the *herredag* of Copenhagen in 1530 Sadolin occupied a prominent place. Frederick subsequently transferred him to Funen, where he acted, according to his own expression, as "adjutor in verbo" to Knud

Gyldenstjerne, bishop of Odense. At the diocesan council held on the 27th of May 1532, during the absence of the bishop, he presented to the assembled priests a translation of Luther's catechism, with Luther's name omitted, preceded by an earnest plea in favour of a better system of education and a more practical application of the Christian life, which occupies a conspicuous place in the literature of the Danish Reformation. In the following year Sadolin published the first Danish translation of the Confession of Augsburg. He disappears during the troublous times of "C-revens Fejde" (1533-1536), though we get a glimpse of him at the end of 1536 as one of the preachers at *Vor Frue Kirke*, the principal church of Copenhagen. On the 2nd of September 1537 he was consecrated by the German reformer, Johann Bugenhagen, who himself only had priest's orders, superintendent, or first evangelical bishop, of Funen. As bishop he was remarkable for the success with which he provided the necessary means for the support of churches, schools and hospitals in his widespread diocese, which had been deprived of its usual sources of income by the wholesale confiscation of church property. Towards the Catholics he adopted a firm, but moderate and reasonable, tone, and his indulgence towards the monks in St Knud's cloister drew down upon him a fierce attack from the Puritan clergyman of Odense, who absurdly accused him of being a crypto-Catholic. He gave the funeral oration over Christian III. in St John's Church at Odense in February 1559, though now very infirm and blind, and died at the end of the same year.

See Bricka, *Dansk Biografisk Lx. Art. Sadolin* (Copenhagen, 1887). (R. N. B.)

SADOWA (Czech, *Sádová*), a village of Bohemia, Austria, 4 m. N.W. of Königgrätz. Pop. (1900) 183, exclusively Czech. Sadowa, with the small adjoining wood, was one of the principal and most hotly contested Prussian positions in the decisive battle now usually called by the name of Königgrätz (see SEVEN WEEKS' WAR).

SAEPINUM (mod. Altilia, near Sepino), a Samnite town 9 m. S. of the modern Campobasso, on the ancient road from Beneventum to Corfinium. It was captured by the Romans in 293 B.C. The position of the original town is on the mountain far above the Roman town, and remains of its walls in Cyclopean masonry still exist. The city walls (in *opus reticulatum*) of the Roman town were erected by Tiberius before he became emperor, the date (between 2 B.C. and A.D. 4) being given by an inscription. Within them are remains of a theatre and other buildings, including temples of Jupiter and Apollo, and there still exists, by the gate leading to Bovianum, an important inscription of about A.D. 168, relating to the *tratture* (see APULIA) in Roman days, forbidding the natives to harm the shepherds who passed along them (*Corp. inscr. Lat. ix. 2438*).

See L. Fulvio in *Not. degli scav.* (1878), 374.

SAETERSDAL, a district in the south of Norway, comprising the valleys of the Otter river and its tributaries. The river rises in the fields above the Bukken Fjord, and flows south to Christiansund. The natives preserve old customs and an individual costume. A railway follows the valley to Byglands Fjord (48 m.), on the lake of that name, fostering the local agricultural and timber trade, and a driving road continues to Viken i Valle from which bridle-paths lead to Dalen in Telemarken, and over the Enden and Malen fields to Lake Suldal on the Bratlandsdal route.

SAFED KOH ("white mountain"), in many respects the most remarkable range of mountains on the north-west frontier of India, extending like a 14,000 ft. wall, straight and rigid, towering above all surrounding hills, from the mass of mountains which overlook Kabul on the south-east to the frontiers of India, and preserving a strike which—being more or less perpendicular to the border line—is in strange contrast to the usual conformation of frontier ridge and valley. The highest peak, Sikaram, is 15,620 ft. above sea-level, and yet it is not a conspicuous point on this unusually straight-backed range. Geographically the Safed Koh is not an isolated range, for there is no break in the continuity of water divide which connects it

with the great Shandur offshoot of the Hindu Kush except the narrow trough of the Kabul river, which cuts a deep waterway across where it makes its way from Dukka into the Peshawar plains. Strategically it is an important topographical feature, for it divides the basin of the Kabul river and the Khyber route from the valley of Kurram, leaving no practicable pass across its rugged crest to connect the two. Its western slopes, where it abuts on the mountain masses which dominate the Kabul plain, are forest-covered and picturesque, with deep glens intersecting them, and bold craggy ridges; the same may be said of the northern spurs which reach downward through the Shinwari country towards Gandamak and Jalalabad. Here the snow lies late and moisture is abundant—but on the southern sun-scorched cliffs but little vegetation is to be seen. Approaching the Peshawar plains the Safed Koh throws off long spurs eastward, and amongst the foothills of these eastern spurs the Afridi Tirah long remained hidden from European eyes.

SAFES, STRONG-ROOMS AND VAULTS. The term "safe," whilst really including any receptacle for the secure custody of valuables provided with a lock or other device intended to prevent any person except the owner or some person authorized by him gaining access thereto, has gradually come to be confined to such receptacles when fitted with a vertical door, as distinguished from a lid, and of such a size that they can be moved into position, by the use of proper appliances, in one piece. Such receptacles, when so large as to require that their parts should be assembled *in situ*, fall under the term "strong-rooms," or in the case of safe-deposits "vaults," and when constructed with hinged lids, as distinct from doors, under the terms "cash-box," "deed-box" and "coffer." The term "coffer" is probably the most ancient, and in earlier days included, as it still does in France, what are now known as safes.

Although it is practically certain that boxes provided with locks or coffers must have followed closely on the development of locks (*q.v.*) and been in use in ancient Egypt, yet no examples remain to us of earlier date than the middle ages. The earliest examples extant were constructed of hard wood banded with hammered iron, and subsequent development took place rather on artistic than on practical lines up to the time of the introduction of boxes entirely of iron. On the continent of Europe the iron box was developed to a very high standard of artistic beauty and craftsmanship, but with no real increase of security. Several specimens of these coffers supposed to be of 17th-century workmanship are preserved in the museum at Marlborough House. Cast-iron chests seem to have been made in various parts of Great Britain in the early part of the 19th century, but the use of wrought iron was probably confined to London until 1820, or thereabouts, when the trade spread to Wolverhampton.

Up to this time no attempt had been made to make coffers fireproof, for though a patent for fireproofing had been taken out in 1801 by Richard Scott, it does not appear to have been used. In 1834, however, a patent was obtained by William Marr for the application of non-conducting linings, followed about four years later by a similar patent in the name of Charles Chubb. The foundation, however, of the modern safe industry was laid by Thomas Milner, originally a tinsmith of Sheffield, who after a few years' business in Manchester established, in 1830, works at Liverpool for the manufacture of tinsplate and sheet iron boxes and who later made plate iron chests or coffers and, probably the earliest, safes about the year 1846. To him is due the modern system of fireproofing, which owes its merit to the use not of non-conductors but of an absorbent material which in the case of fire will be permeated with moisture present in it, either in the form of liquid contained in tubes which burst or otherwise discharge their contents when subjected to heat, or mixed with it as water of crystallization in combination with an inorganic salt. The patent he obtained in 1840 contains the following claim: "Constructing, forming, or manufacturing boxes, safes, or other depositories of an outer case of iron or other metal or material, enclosing one, two, or more inner cases, with spaces or chambers between them, containing an absorbent material or composition, such as porous wood, dust of wood, dust of bones, or similar

substances, in which are distributed vessels, pipes or tubes filled with an alkaline solution or any other liquid or matter evolving steam or moisture, the tubes or vessels bursting or otherwise discharging themselves on the exposure of the box or other depository to heat or fire, into the surrounding absorbent matter, which thus pervaded with moisture and rendered difficult of destruction, protects the inner cases or boxes and their contents." In 1843, Edward Tann, Edward Tann, Junr., and John Tann took out a patent for securing the presence of moisture by means of a chemical salt. In their patent they give preference to alum in combination with Austin's cement or gypsum, but they also claim "any non-conductors of heat may be used, and for alum may be substituted sulphate of potash, muriate of ammonia, borax, impure potash, nitrate of soda, soda in cake, pearlsh, or any of the known alkalis." Milner considered this an infringement of his patent of 1840, and in an action before Lord Campbell and a special jury in the Queen's Bench, on the 3rd of June 1851, a verdict was given upholding his contention.

For some years no marked improvements in safes were made, although the manufacture had been taken up in various places by different firms. Safes had, however, been constructed of thicker materials, and some attention had been paid to the more secure attachment of the various parts; also, with the advent

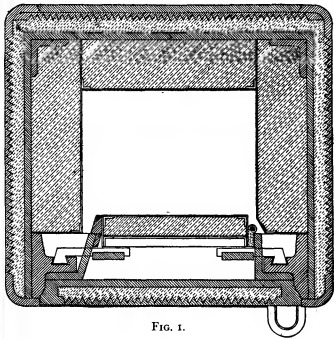

FIG. 1.

of the wrought-iron safe, as distinct from the coffer, the practice had developed of securing the door by a number of bolts operated by a handle and fastening them in the locked position by the lock proper, in order that a small key might be used (Charles Chubb's patent, 1845).

Concurrently with the increase of strength in safes and probably with the increased value of articles preserved in safes, the skill of the professional thief had also increased, and this went on for some years until the Cornhill burglary of 1865 called general attention to the question. In 1860 a patent was taken out by Samuel Chatwood for a safe constructed of an outer and inner body with the intervening space filled with ferro-manganese or speigeleisen in a molten state, the total thickness being 2 in. (fig. 1). The drilling of conical holes in the inner surface of the outer plate as shown in the figure renders the use of drills of any materials at present known quite inoperative; as the drill, even if it could be made sufficiently hard to pierce the speigeleisen, would on meeting it be bedded in the soft steel and unable to free itself. The construction of such a safe was an expensive matter, and it was not till after the robbery above referred to that he was enabled to sell a single example; it is, however, still in demand for the preservation of diamonds, as probably the only

absolutely drill-proof receptacle. This patent is noteworthy as being the only one connected with the lock and safe industry which has been extended by the privy council.

It is about this period (1860-1870), perhaps the most important in the history of safes, that the opening of safes by wedges seems to have become prominent. The effect of wedges was to bend out the side of the safe sufficiently to allow of the insertion of a crowbar between the body and the edge of the door, and various devices were adopted by different makers with the object of resisting this mode of attack. These devices may be placed in three classes: (1) the fixing to the door of studs or projections which, when the door closed, passed into holes or recesses in the frame of the body; (2) the use of bolts hooking into the side framing or entering the bolt holes at an angle; (3) the strengthening of the side framing and of the attachment of the bolts to the outer door-plate. The third of these methods (fig. 2) was patented by Samuel Chatwood in 1862, and is still very commonly employed. The second method was used by Chubb and Chatwood, but is not to-day in general use. The first method was used by all makers of repute, but has now been abandoned, as the increased structural strength of the better class of safes renders such devices unnecessary.

To prevent safes from being opened by the drilling of one or two small holes in such positions as to destroy the security of the lock itself, advantage was taken of the improvements in the

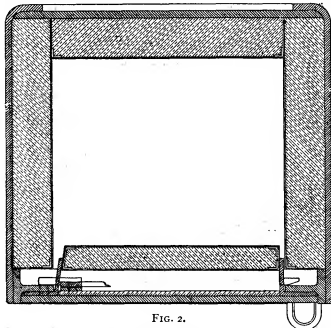

FIG. 2.

manufacture of high carbon steel, and even in what is to-day called the "fire-proof" safe a plate of steel which offers considerable resistance to drilling is placed between the outer door plate and the lock.

For many years little advance was made except such as consisted in substituting steel for iron and in general gaining increased strength by the utilization of better materials, although many safes are made and sold to-day which offer little if any more resistance to fire and thieves than those of 1860-1870. About 1888 the "solid" safe was introduced. In this the top, bottom and two sides of the safe, together with the flanges at the back only or at both back and front, are bent from a single steel plate (fig. 3). This construction, with solid corners, also illustrated in figs. 1 and 2, only became practicable in consequence of the great improvements which had been made in the quality of steel plates; the credit of its invention formed the subject of litigation, which, however, was not carried to an issue. The abolition of corner joints, which up to 1888 had been made by dovetailing and by the use of angle irons, had been previously attempted by welding, but the process was abandoned as commercially impracticable.

In the early days of the safe industry in America the conditions as far as protection from fire was concerned were entirely different from those obtaining in Great Britain. The timber construction employed in American buildings rendered fires much more fierce, but at the same time of very short duration, not more than an

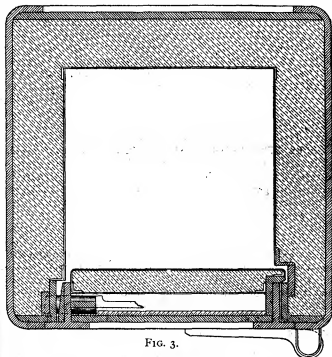

FIG. 3.

hour or two. To meet this condition of affairs thick sides of non-conducting materials were more efficacious than the chambers of steam-generating materials employed in British construction, but the gradual abandonment of timber and the increasing size of buildings have called for changes in the methods of fire-proofing.

The American "burglar proof" safe (fig. 4) seems to have developed from the fire-proof (fig. 5) simply by the addition of extra thicknesses of metal, usually alternately hard and soft, without any serious increase of structural strength; this construction, known as the "laminated" or "built up," offers little resistance to burglars, as the various layers can be separated from one another by the use either of explosives, especially nitroglycerine, or of wedges. In 1890 a commission was appointed by the U.S.A. government to report upon the strong-rooms or vaults of the treasury at Washington; and their report¹ was presented in September 1893. This commission based their conclusions on experiments conducted in their presence, as well as on well-authenticated experiments performed by safe-makers on their own and other makers' productions, and they found

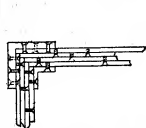

FIG. 4.—American Burglar-proof Construction.

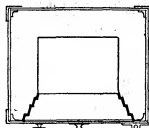

FIG. 5.—American Fire-proof Safe.

that, with the single exception of the Corliss safe, all the safes which came under their notice—and these comprised all the best-known American makes—could be opened by burglars by

¹ Report of Special Commission of Experts as to Means of Improving Vault Facilities of the Treasury Department (Washington, 1894).

drilling, by the use of explosives, and by the use of wedges and similar well-known tools. This Corliss safe consists of a spherical shell of cast iron several inches thick and with its exterior hardened by "chilling." It is fitted with a ground-in door rotating concentrically with the shell and internally. The spherical form and great thickness render the useful space in the interior very small and of inconvenient shape.

The requirements of a modern safe may be briefly summarized.

In fire- and thief-proof safes, the body and door must be constructed of sufficient thickness, and the joints as well as the attachment of the door to the body frame of sufficient strength, to remain uninjured by a fall from the highest position in which the safe may be placed to the basement, or by the impact of any debris, coping stones, girders, &c., falling from the highest part of the building to the basement. The space between the outer body and the inner casing must be properly charged with a steam-generating mixture in sufficient quantity to keep the interior of the safe moist for the whole time during which it may be subjected to heat in the case of a fire. The same requirements must be satisfied in burglar-proof safes. In addition, the body and door must be of such material and of such thickness that it is impossible to cut a sufficiently large hole to extract the contents, and so constructed that they cannot be dismembered; the framing and attachment of the bolts to the door must be able to resist the action of wedges or forcing screws; the vital parts of the lock and bolt-work must be further protected so that it is impossible to attack them by drilling, and this protection must not be liable to be destroyed by the action of heat; the lock itself must not be capable of having its security destroyed by the explosion of the largest quantity of explosive which can be inserted. If these conditions are satisfied there is little fear that the oxy-acetylene blowpipe, the electric arc or the use of the higher explosives can be made effective. The amount of protection required to meet the above conditions must, in each case, depend on what tools it is reasonable to anticipate may be employed by the burglar and the maximum time which he may have at his disposal. The use of high explosives has become a more frequent method of attack by burglars in Great Britain, but where the safes have been of the best quality, of solid construction and good workmanship, this means of attack has been rendered ineffective.

Strong-rooms and Vaults.—It is not hard to imagine that the use of strong-rooms was much earlier than that of safes; in fact, there can be no doubt that masonry rooms provided with heavy wooden doors secured by locks were in use in ancient Egypt, and that the development of strong-room doors attached to masonry rooms followed that of the old coffers very closely. No exact date can be obtained as to the introduction of what we may call modern strong-rooms, but it is only reasonable to suppose that, where larger quantities of valuables had to be preserved than a safe would conveniently hold, a safe-door of larger dimensions

would be made and attached to a masonry or brick room. The next step would be the discovery that the walls of such a room offered little protection against even unskilled violence, and the lining of the room with metal would immediately follow; the door frame, as a matter of course, being attached to the plating. Strong-rooms of this construction are in common use to-day by

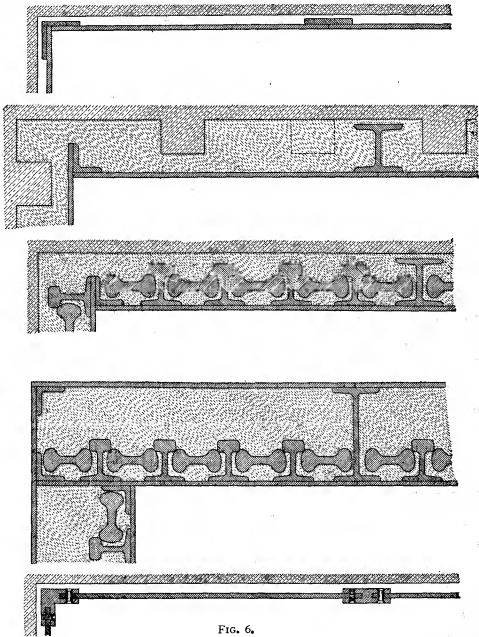

FIG. 6.

banks and other institutions; and, as with safes, so with strong-rooms, development has taken place in the direction of increasing the thickness and the structural strength as well as in the application of superior locking devices (see LOCKS).

This increase of structural strength has been carried along somewhat different lines by different makers in Great Britain and along still more diverse lines in America. Masonry or brick-work alone is now rarely relied on for the protection of goods of any great value; concrete, however, reinforced by old railway metals imbedded therein and sometimes connected together to form, as it were, a cage, is in use. Railway metals attached to steel plates and also bedded in concrete are very largely employed. Thick plates of steel and latterly of manganese and other special steels are also in common use. Various forms of strong-room walls are illustrated in fig. 6.

Usually a strong-room is provided with an open-work gate or

"grille" as well as a door, so that the contents may be protected by the gate during business hours without preventing the free access of air; they are usually also fitted for convenient subdivision. Safe deposit vaults do not differ in any way from strong-rooms, except that they are fitted up with small safes or *integers* provided with special locks, so that the renter can gain access to his own integer only, and this only with the assistance of a custodian.

Many electrical devices have been introduced, having for their object the giving of an alarm when strong-rooms or safes are improperly approached or tampered with. Most of these devices were quite useless, as they could at once be rendered inoperative; but though others displayed greater ingenuity, it is very questionable whether they are of any real utility, and they have not remained in common use. Where the value known to be contained in a strong-room is sufficiently great, an attack by tunnelling must be specially guarded against, and as in this form of attack the time which may be devoted to preparing for the actual breaking through is practically unlimited, the use of some device which will give warning of any such attack before the floor of the strong-room itself is reached is of very great importance. Probably the best of such devices, and one which is in practical use, consists of a network of small pipes, laid in concrete below the floor, and filled with glycerin or other liquid. To this network a mercury manometer is connected. If any breach is made in the pipe system, a leakage takes place, causing an alteration in the level of the mercury in the manometer, which may, if desired, be arranged to ring a bell. The manometer should in any case be observed regularly on the opening of the strong-room. (A. B. Ck.)

SAFETY-LAMP, a form of lamp, used especially in mines, which is so constructed that it will burn without igniting a gaseous explosive mixture by which it is surrounded. To effect this end, the flame is encircled with a protecting metal case which is perforated with numerous small holes. Through these air for feeding the flame can enter freely and the products of combustion escape; but the flame or gases cannot pass out at a sufficiently high temperature to cause the ignition of the explosive mixture outside, because on arriving at the perforations they give up much of their heat to the large metallic surface they encounter, by which it is conducted away. In 1816 Sir Humphry Davy discovered the suitability of wire gauze as the material of the metal case, when the substance of the wire was rightly proportioned to the size of the aperture. The standard adopted as the limit for safety at that time was a gauze of 28 iron wires to the linear inch, having 784 apertures per square inch, but in some lamps the apertures are occasionally made still smaller.

The common safety or Davy lamp consists of a small cylindrical oil lamp, covered with a cylinder of wire gauze about 6 in. long and 1½ in. in diameter, with a flat gauze top. The upper part of the gauze is doubled to prevent it from being worn into holes by the products of combustion, and the air for feeding the flame enters round the wick. The gauze is mounted in a cage, consisting of three upright wires, screwed into a flat brass ring at each end. A handle is attached to the upper ring, while the lower one screws on to a collar on the oil-vessel of the lamp. When the two parts are screwed together the lamp is locked by a bolt passing through both parts, which is screwed down flush with the surface of the outer ring, so that the gauze cannot be removed without the use of a key.

In Stephenson's safety-lamp, generally known as the "Geordie" from its inventor George Stephenson, the light is covered by a glass chimney, surrounded by an outer casing and top of wire gauze. The feed air is admitted through numerous small holes in a copper ring a little below the level of the wick. This is one of the safest forms of lamp, but requires considerable care in use, especially in keeping the small feed holes clear from dust and oil; the glass protects the lamp from becoming overheated, and when the air is dangerously charged with gas the light is extinguished.

In the lamp invented by Dr W. Reid Klancy (1776-1850) about the same time as those of Davy and Stephenson, a glass cylinder is substituted for the lower portion of the wire gauze. The air for supplying the flame, entering at the bottom of the gauze and passing down the inner side of the glass, protects the latter to some extent from becoming overheated, but a large amount of light is lost by absorption in the glass, so that there is no great advantage over the ordinary Davy lamp to compensate for the extra weight and cost, especially as the safety property of the lamp depends upon the glass cylinder, which may be readily broken when subjected to the ordinary accidents of working. A more perfect form of lamp of the same character is that of Mueseler, which is extensively used in Belgium. It differs from Clanny's lamp by the addition of a conical chimney above the flame, which produces a rapid draught, and consequently a more perfect cooling of the glass cylinder by the downflow of feed air for the flame.

The safety of the Davy lamp is endangered by exposure to a current of gas moving at more than 6 ft. a second, as the flame is then liable to be forced through the gauze, and the Clanny and Stephenson lamps are not safe in currents exceeding 8 and 10 ft. respectively. These early forms have therefore been improved and modified to meet the requirements of safety in air-currents travelling at a high velocity. In the Hepplewhite-Cray lamp there is a conical glass surrounding the light, with a gauze chimney, protected by an outer metal cylinder; the air supply to the flame is carried downwards through three tubes forming the standards of the cage. This lamp, in addition to giving a good light overhead owing to the shape of the glass, is peculiarly sensitive to gas, and therefore valuable in testing for fire-damp. Other approved lamps are the Deflector and those of Marsaut and Mueseler when specially bonneted to resist extra high-speed currents. The illuminant now generally used in Great Britain is a mixture of rape oil with half its volume or more of petroleum, which is more suitable than vegetable oil as animal oil alone. In Germany, and also in America, Wolf's lamp, burning benzoline or petroleum spirit upon an asbestos wick, is very popular as giving a much better light than oil. Special care is, however, required in filling, so that no free liquid may be left in the holder; the spirit must be entirely absorbed by a filling of sponge, and any superfluous quantity poured off. Portable electric lamps, supplied by accumulators or dry batteries, have been introduced into coal-mines; but owing to the weight and cost their use is as yet very restricted.

The ordinary safety-lamp affords indications of the presence of fire-damp (marsh gas) in the air of a mine. When the amount exceeds 2 or 2½ it may be detected by reducing the flame; till it is practically non-luminous, when a pale blue flame or luminous cap will be seen above the ordinary flame. This varies in size with the percentage of fire-damp, until when there is about 10% the blue flame fills the whole interior of the gauze cylinder. If the lamp is allowed to remain too long in such a fiery atmosphere, it becomes dangerous, because the gauze, becoming heated to redness, may fire the external gas. For detecting the presence of fire-damp in amounts less than 2½, special lamps with the non-luminous flames are adopted. In Pieler's lamp, which is of the ordinary Davy form, alcohol is burned in a silk wick, which is provided so that the flame can be hidden. When exposed in air containing 1% of a cap of 1½ in. is formed, which increases to 2 in. with 1%, and with 1½% the lamp is filled with a deep blue glow. Another and more useful method is that of Dr F. Clowes, who uses a hydrogen flame 0.4 in. long, obtained by attaching a cylinder containing compressed hydrogen to an ordinary safety-lamp. When used for gas testing the hydrogen is turned into the oil flame, which is for the time extinguished, and relighted when the observation is finished. So small a proportion as 0.2% of gas can be detected by this method.

The locking of safety-lamps, so as to render them incapable of being opened by the miners when at work, is a point that has given play to a large amount of ingenuity. One of the most favourite devices is a combination of the wick-holder with the locking bolt, so that the latter cannot be withdrawn without lowering the wick and extinguishing the flame. Another method consists in the use of a lead rivet, uniting the two parts of the lamp, impressed with a seal, which cannot be removed without defacing the device. All this class of contrivances have the defect of only being efficacious when the miners are not provided with matches or other means of obtaining a light. Another device, which has been adopted by Bidder, where the locking bolt is magnetized and held in place by a force which can only be overcome by the application of a battery of heavy and powerful steel magnets. These are kept in the lamp cabin at the pit bottom, where the lamps are cleaned and served out lighted to the miners at the commencement of the shift, and are collected before they return to the surface. (H. B.)

SAFFARIDS, a Persian dynasty of the 9th century, founded by **YAKUB** (Yaqub) b. Laith b. Saffar ("coppersmith") about 866, who, originally a leader of bandits and outlaws, became governor of Sejestan. He soon added to his province Herat, Fars, Balkh and Tokharistan, overthrew the Tahirids in Khorasan, and, nominally still dependent on the caliphs of Bagdad, established a dynasty in Sejestan (see CALIPHATE, section C, *Abbasids*, § 10, and PERSIA: *History*, section B). Soon after 900 the dynasty became subordinate to the Sāmānids (*q.v.*) and few of its rulers had any real authority. Under the last of the dynasty, Taj ud-din Binaltagin (1225-1229), a usurper of the royal family of the Khwarizm shahs, the country was captured by the Mongols. See S. Lane Poole, *Mahommedan Dynasties* (1891), p. 129; Stokvis, *Manuel d'histoire* (Leiden, 1888), vol. i. p. 137; on the later Saffarids, H. Sauvaire, in the *Namismatic Chronicle* (1881).

SAFFI, or ASEI, a seaport on the west coast of Morocco, in 32° 20' N. 9° 12' W., 106 m. W.N.W. of Marrākesh. (Pop. about 15,000.) Although the principal wool and grain port of central Morocco, the anchorage is an open roadstead and communication with the shore is at times difficult. The old palace with

beautifully decorated courts in fair repair, built by Mohammed XVII., is a prominent object above the town, and there are many interesting buildings and ruins.

SAFFLOWER (ultimately from the Arabic *safra*, yellow) or **BASTARD SAFFRON** (*Carthamus tinctorius*), a plant of the natural order composite; its flowers form the basis of the safflower dye of commerce. The plant is a native of the East Indies, but is cultivated in Egypt and to some extent in southern Europe. To obtain the dyeing principle—carthamin, $C_{26}H_{36}O_8$ —the flowers are first washed to free them from a soluble yellow colouring matter they contain; they are then dried and powdered, and digested in an alkaline solution in which pieces of clean white cotton are immersed. The alkaline solution having been neutralized with weak acetic acid, the cotton is removed and washed in another alkaline solution. When this second solution is neutralized with acid, carthamin in a pure condition is precipitated as a dark red powder. It forms a brilliant but fugitive scarlet dye for silk, but is principally used for preparing toilet rouge.

SAFFRON (Arab. *za'farān*), a product manufactured from the dried stigmas and part of the style of the saffron crocus, a cultivated form of *Crocus sativus*; some of the wild forms (var. *Thomasi*, *Cartwrightianus*) are also employed for the manufacture. The purple flower, which blooms late in autumn, is very similar to that of the common spring crocus, and the stigmas, which are protruded from the perianth, are of a characteristic orange-red colour. The fruit is rarely formed. The Egyptians, though acquainted with the bastard safflower, do not seem to have possessed saffron; but it is named in Canticles iv. 14 among other sweet-smelling herbs. It is also repeatedly mentioned ($\kappa\rho\kappa\omicron\varsigma$) by Homer, Hippocrates and other Greek writers; and the word "crocodile" was long supposed to have been derived from $\kappa\rho\kappa\omicron\varsigma$ and $\delta\epsilon\lambda\omicron\varsigma$, whence we have such stories as that "the crocodile's tears are never true save when he is forced where saffron growth" (Fuller's *Worthies*). It has long been cultivated in Persia and Kashmir, and is supposed to have been introduced into China by the Mongol invasion. It is mentioned in the Chinese materia medica (*Pun tsauu*, 1552-1578). The chief seat of cultivation in early times, however, was the town of Corycus (modern Korghoz) in Cilicia, and from this central point of distribution it may not improbably have spread east and west. According to Hehn, the town derived its name from the crocus; Raymond, on the other hand, with more probability, holds that the name of the drug arose from that of the town. It was cultivated by the Arabs in Spain about 961, and is mentioned in an English leech-book of the 10th century, but seems to have disappeared from western Europe till reintroduced by the crusaders. According to Hakluyt, it was brought into England from Tripoli by a pilgrim, who hid a stolen corn in the hollow of his staff. It was especially cultivated near Hinton in Cambridgeshire and in Essex at Saffron Walden, its cultivators being called "crokers."

Saffron was used as an ingredient in many of the complicated medicines of early times. That it was very largely used in cookery is evidenced by many writers; thus Laurentbergius (*Apparatus plantarum*, 1632) makes the large assertion "In te familiari vix ullus est telluris habitatus angulus ubi non sit croci quotidiana usurpatio aspersi vel incocti cibi." The Chinese used also to employ it largely, and the Persians and Spaniards still mix it with their rice. As a perfume it was worn in Greek halls, courts and theatres, and in the Roman baths. The streets of Rome were sprinkled with saffron when Nero made his entry into the city.

It was, however, mainly used as a dye. It was a royal colour in early Greek times, though afterwards, perhaps from its abundant use in the baths and as a scented salve, it was especially appropriated by the hetairae. In ancient Ireland a king's mantle was dyed with saffron, and even down to the 17th century the "lein-croich," or saffron-dyed shirt, was worn by persons of rank in the Hebrides. In mediæval illumination it furnished, as a glaze upon burnished tinfoil, a cheap and effective substitute for gold. The sacred spot on the forehead of a Hindu pundit is also partly composed of it. Its main use in England

was to colour pastry and confectionery, and it is still used for this purpose in some parts of the country (notably Cornwall).

One grain of saffron rubbed to powder with sugar and a little water imparts a distinctly yellow tint to ten gallons of water. This colouring power is due to the presence of polychlorite, a substance whose chemical formula appears to be $C_{26}H_{36}O_8$, and which may be obtained by treating saffron with ether, and afterwards exhausting with water. Under acids it yields the following reaction—

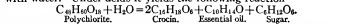

Polychlorite. Crocin. Essential oil. Sugar.
Crocin, according to Watts, *Dict. of Chem.*, has a composition of $C_{26}H_{36}O_8$ or $C_{26}H_{34}O_8$. This crocin is a red colouring matter, and it is surmised that the red colour of the stigmas is due to this reaction taking place in nature.

Saffron is chiefly cultivated in Spain, France, Sicily, on the lower spurs of the Apennines and in Persia and Kashmir. The ground has to be thoroughly cleared of stones, manured and trenched, and the corms are planted in ridges. The flowers are gathered at the end of October, in the early morning, just when they are beginning to open after the night. The stigmas and a part of the style are carefully picked out, and the wet saffron is then scattered on sheets of paper to a depth of 2 or 3 in.; over this a cloth is laid, and next a board with a heavy weight. A strong heat is applied for about two hours so as to make the saffron "sweat," and a gentle temperature for a further period of twenty-four hours, the cake being turned every hour so that every part is thoroughly dried. This is known as *cake saffron* to distinguish it from *hay saffron*, which consists merely of the dried stigmas.

The drug has naturally always been liable to great adulteration in spite of penalties, the severity of which suggests the surviving tradition of its sacred character. Thus in Nuremberg a regular saffron inspection was held, and in the 15th century we read of men being burned in the market-place along with their adulterated saffron, while on another occasion three persons convicted of the same crime were buried alive. Grease and butter are still very frequently mixed with the cake, and shreds of beef dipped in saffron water are also used. Good saffron has a deep orange-red colour; if it is light yellow or blackish, it is bad or too old.

SAFFRON WALDEN, a market-town and municipal borough in the Saffron Walden parliamentary division of Essex, England, beautifully situated near the Cam in a valley surrounded by hills, on a branch of the Great Eastern railway, 43½ m. N.N.E. from London. Pop. (1901) 5896. It has a somewhat ancient appearance and possesses a spacious market-place. Of the old castle, dating probably from the 12th century, but in part protected by much earlier earthworks, the keep and a few other portions still remain. Near it are a series of curious circular excavations in the chalk, called the Maze, of unknown date or purpose. The earthworks west and south of the town are of great extent; there was a large Saxon burial-ground here. The church of St Mary the Virgin, a beautiful specimen of the Perpendicular style, dating from the reign of Henry VII., but frequently repaired and restored, contains the tomb of Lord Audley, chancellor to Henry VIII. There is an Edward VI. grammar school, occupying modern buildings. The town possesses a museum with good archaeological and natural history collections, a literary institute and a horticultural society. The benevolent institutions include the hospital and the Edward VI. almshouses. There is a British and Foreign School Society's training college for mistresses. In the neighbourhood is the fine mansion of Audley End, built by Thomas, 1st earl of Suffolk, in 1603 on the ruins of the abbey, converted in 1190 from a Benedictine priory founded by Geoffrey de Mandeville in 1136. Brewing, malting and iron-founding are carried on. The borough is under a mayor, 4 aldermen and 12 councillors. Area, 7502 acres.

Saffron Walden (*Waledana*) was almost certainly fortified by the Britons, and probably by some earlier race. The town corporation grew out of the Guild of the Holy Trinity, which was incorporated under Henry VIII., the lord of the town, in 1514. It was dissolved under Edward VI., and a charter was obtained for Walden, appointing a treasurer and chamberlain and twenty-four assistants, all elective, who, with the commonalty, formed the corporation. In 1694 William and Mary made Walden a free borough, with a mayor, 4 aldermen and 12 town councillors. The corporation became a local board of health under the act of 1853, and a municipal borough in 1875. The culture of saffron was the most characteristic industry at Walden from the reign of Edward III. until its gradual extinction about 1768.

SAFRANINE, in chemistry, the azonium compounds of symmetrical diamino-phenazine and containing the ring system annexed:—

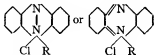

They are obtained by the joint oxidation of one molecule of a diamidine with two molecules of a primary amine; by the condensation of para-aminoazo compounds with primary amines (O. Witt, *Ber.*, 1877, 10, p. 874), and by the action of para-nitrosodialkylanilines with secondary bases such as diphenylmethaphenylenediamine. They are crystalline solids showing a characteristic green metallic lustre; they are readily soluble in water and dye red or violet. They are strong bases and form stable monacid salts. Their alcoholic solution shows a yellow-red fluorescence.

Phenosafranin is not very stable in the free state; its chloride forms green plates. It can be readily diazotized, and the diazonium salt when boiled with alcohol yields aosafranin or benzene induline, $C_{16}H_{12}N_2$. F. Kehrman showed that aosafranin could be diazotized in the presence of cold concentrated sulphuric acid, and the diazonium salt on boiling with alcohol yielded phenylphenazonium salts. Aosafranone, $C_{16}H_{12}N_2O$, is formed by heating aosafranin with concentrated hydrochloric acid. These three compounds are perhaps to be represented as ortho- or as paraquinones (see papers by F. Kehrman, O. Fischer and E. Hepp; R. Nietzki and others, *Ber.*, 1895 et seq.). The "safranin" of commerce is a tolosafranin. The first aniline dye-stuff to be prepared on a manufacturing scale was mauveine, $C_{16}H_{12}N_2Cl$, which was obtained by Sir W. H. Perkin by heating crude aniline with potassium bichromate and sulphuric acid. It is a N-phenylsafranin (see INDULINES).

SAGA (literally a story committed to writing), a word derived from Icel. *segja*, to say. The term is common to most of the Teutonic languages, where we find Eng. *say*, Ger. *sagen*, the O. Eng. *secgan*, Dan. *sig* and Swed. *segja*, all identical in meaning. A saga, therefore, was originally something reported, *segin saga*, a tale told, in English a *saw*. But the earliest literature of Scandinavia goes back to an age before writing was invented, and when the legends were first put down they were called sagas because they were things which had been told or repeated from mouth to mouth. The early books speak of sagas which, apparently, had never been written down and were in consequence lost; but, as soon as the art of writing was understood, the word *saga* began for the future to be used exclusively for written historical books. A volume made up of such histories was known as a *sögubók* or book of sagas. They were not rigidly historical; any story which was written down, and repeated according to the literary formula, was called a saga. The telling of tales was a recognized form of entertainment at Icelandic banquets, and in *Haraldsaga Harðrða* there are very interesting details regarding these public saga-tellings; the person who repeated or read the tale being known as the *sögumadr* or saga-man, and being held in high honour at the feast.

The saga was properly a creation of the peculiar conditions under which Icelandic society was constituted in the earliest medieval times. The aristocratic Icelander had no diversions, except games of strength and skill out of doors and the listening to professional story-tellers indoors. As has been often pointed out, the saga is a prose epic, and in its various kinds it follows strict laws of composition. The lesser epic, in its original form, was the biography of some heroic Icelander who had lived in the 10th or 11th century. It was composed with great regularity, so as to proceed uniformly from the birth of the hero to his death, and indeed from before the one date until after the other. The style is brief, clear and conversational; the hero was often a distinguished poet, and in that case some of the best of his verses are interwoven into the narrative, being put in his mouth on striking occasions. Alliteration takes a great part in the ornament of the style. The skill with which the story is told, the high romantic sense of honour and courage which is displayed, the quick turns of the dialogue, the brilliant evolution of the plot, all these give enduring charm to the more successful and ample of the sagas, and in the earlier examples

these qualities are very rarely missing. It is to be remembered, however, that the saga was intended to be listened to, not read, by an audience which was mainly interested in three subjects, namely fighting, litigation and pedigree. It was illegitimate for the saga-man, in the preparation of his epic, to allow himself to stray for any length of time from one of those three themes; since even love must be considered in the light of an episode.

The period of the saga-age, as it was called, the *sögu-öld* or epoch celebrated in the sagas, is now confined between the years 800 and 1030, and opens with the original colonization of Iceland. The deaths in 1030 of two great statesmen, Snorri and Skapti the Lawman, mark its close; almost immediately afterwards, before the end of the 11th century, the actual age of saga-composition is in full action; and lastly comes the *rit-öld*, or age of writing when the sagas were preserved in their present literary form, the blossoming time of which was the 13th century. According to the definite statement of the great historian, Sturla, the first man who wrote down in the Norse tongue, in Iceland, "hisories relating to times ancient and modern," was Ari Fróði (1067-1148); who was therefore the earliest of the saga-writers. He, as we know, was the author of three works of vast importance in the history of Icelandic literature. These were *Konunga-bók* or the Book of King, *Landnama-bók* or the Book of Settlements and *Islendinga-bók* or the Book of Icelanders. The second of these, in which Ari was assisted by Kolslegg Asbjörnsson, survives and is of priceless value. Of the first and third, we possess abbreviations and summaries. It is believed that the admirable style in which the sagas are composed was the invention of Ari, to whose individual genius the form of classic prose tradition is attributed. He has no rival in this respect, and is the true father of the Icelandic saga. The works of Saemund Vigfusson (1056-1133), who succeeded Ari as a writer of the lives of kings, are unfortunately lost.

We now pass to what are called the Greater or *Islendinga sagas*, which are of a more intense and romantic character than the historical biographies. Among these the greatest is *Njalssaga* (or *Njala*), which few critics will question to be the most eminent masterpiece of Icelandic literature. There is no clue to the name of the author, who was evidently a lawyer; extensive as is the work, it is evidently written by one hand, for peculiarities and felicitous originalities of style recur throughout the whole saga. It must have been composed between 1230 and 1280. Vigfusson has described *Njala* as being, *par excellence*, the saga of law, and adds, "the very spirit indeed of Early Law seems to breathe through its pages." The scene in which *Njal*, the Lawman of judgment and peace, is burned in his homestead by his enemies is perhaps the most magnificent passage which has been preserved in the whole ancient literature of the North. The story of *Njala* is placed at the close of the 10th and the first years of the 11th century. *Eyryggiassaga* deals with politics as *Njalssaga* deals with law; it is a precious compendium of history and tradition handed down from heathen times. It has been suggested that it may be, at all events in part, the work of Sturla the Lawman, who died in 1284. Extremely beautiful in its relation to external nature, a matter often ignored in the sagas, is *Laxdaelasaga*, which is also the most romantic in sentiment. It was probably written about 1235, but by whom is unknown. The aristocratic spirit of the great Icelandic families finds its most characteristic exposition in *Egilssaga*, a very vigorous tale of adventure, the central figure of which, Egil, is depicted with more psychological subtlety than is usual in the sagas; it probably belongs to about 1230. Into *Grettis saga* there enter biographical and mythical elements, curiously mingled; it is also confused in form, and is probably a recension, made about 1310, of two or more earlier sagas now lost, the finest parts of which it is thought that Sturla may have written. These are the five famous groups of anonymous narrative which are known as the Greater Sagas.

The Minor Sagas must be treated more briefly. *Henslaþorissaga*, belonging to the south-west of Iceland, deserves attention because of its extreme antiquity; it has been dated 993. *Gunnlaugssaga Ormsvungu* (The story of Gunnlaug Worm-

Tongue) is a love-story of great sentimental charm. In *Gislasaga* the gloom of the Icelandic outlaw-life is strikingly depicted in the adventures of Gisli, who is under a ban and is hunted from place to place. A very unusual specimen of the minor saga is *Bandamannasaga*, a comic story of manners in the north of Iceland in the 11th century, in which an intrigue of the old families banded against the pretensions of a wealthy *parvens*, is told in a spirit of broad humour. The most archaic of the minor sagas is *Kormakssaga*, the story of the loves of the dark-eyed Kormak and Steingerda; this is, according to Vigfusson, the most primitive piece of Icelandic prose writing that has come down to us. Another very ancient and very simple saga is *Vatnaelagsaga*. Among sagas which deal with the earliest history of America in the chronicles of Greenland and Vinland, a foremost place is taken by *Floamannasaga*, which possesses peculiar interest from its description of the shipwreck of colonists on the coast of Greenland; this belongs to the close of the 10th century. We possess a late (13th century) recension of what must have been equally important as a record of the Greenland colony in the 11th century, *Fostbraedrasaga*. Vigfusson formed a class of still shorter sagas than these, *thaettir* or "morsels" of narrative. At the close of the great period of the composition of all these anonymous sagas, of which few can have been written later than 1260, a work of enormous length and value was composed or compiled by a poet and historian of great eminence, Sturla Thordsson (1215-1284). About the year 1270 he began to compile the mass of sagas which is now known by his name as *Sturlungasaga*. The theory that Sturla was the author of the whole of this bulky literature is now abandoned; it is certain that *Hrafn Sveinbjornssaga*, for instance, belongs to an earlier generation, and the same is true of *Gudmundar Saga Góða*. Vigfusson distinguished these and other sagas, which Sturla evidently only edited, from those which it is certain that he composed, and gathered the latter together under the title of *Islandingsaga*. It is certain that it is to Sturla that we owe almost all our knowledge of Icelandic history from 1200 to 1260. *Islandinga* is divided into two main sections, the former closing in a general massacre of the characters of the story in about 1240, the latter dealing much more minutely with new persons and subsequent events. To Sturla also are attributed two saga-biographies, the *Hakonsaga* and the *Magnussaga*. It is a remarkable fact that while Icelandic saga-literature begins and ends with a definite figure of a writer, all that lies between is wholly anonymous. Ari was the earliest and Sturla the latest of the saga-writers of the classical period, but in the authors of *Njala* and *Laxdaela* we have nameless writers whose genius was still greater than that of the pioneer and of the rear-guard of Icelandic literature. These unknown men deserve a place of honour among the best narrative-writers who have ever lived. The elder brother of Sturla was called Olaf Hvitaskald, or the White Poet (1209?-1259); he was a learned man, who worked at the arrangement and compilation of the sagas which form the *Biskupunga*. In another class are the stories of bishops, *Biskupasögur*, which are not sagas in the true sense, but have considerable value as biographical material for reconstructing Icelandic social life in the 12th century. The admirable saga of Bishop Laurence (1266-1331) was composed by his private secretary, Einar Hafliðason (1304-1393), who also wrote *Annals*, and is the latest Icelandic biographer. After his time a long silence fell on the literature of the country, a silence not broken until the revival of Icelandic learning in the 17th century.

It is evident that a vast number of sagas must be lost; when we consider how many are preserved, we can only express amazement at the fecundity of the art of saga-telling in the classic age. The MSS., on which what we have were preserved, were all on vellum, and there were no sagas written on paper until the time of Bishop Odd, who died in 1630; there was an enormous destruction of vellums during the dark age. After 1640 it became the practice to make transcripts on paper from the perishing vellum MSS. The best authority on the history of the sagas is the copious *Prolegomena* to Dr Gudbrand Vigfusson's edition of the text of *Sturlungasaga*, published in 2 vols., by the Clarendon Press at Oxford in 1878. See also the edition of *Biskupasögur*, issued by the same author, at

Copenhagen, in 1858. Möbius and Vigfusson published the *Formögur* or archaic sagas in 1860, and all the work of Vigfusson calls for the closest attention from those interested in this subject. In connexion with the descents of Northmen on the shores of Britain particular interest attaches to the four volumes of sagas edited for the "Rolls" series (1887-1894). William Morris, who had done much to interpret the spirit of the sagas to English readers, and who published a translation of *Grettisaga* in 1869, started in 1891 the "Saga Library," in conjunction with Mr E. Magnússon; of this a sixth volume appeared in 1906. Mr Sephton has published versions of several of the purely historical sagas. No account has been given above of the famous *Heimskringla* or "Round of the World," of Snorri Sturluson, because this great work, although it contains stories of the kings of Norway, hardly belongs to the same class as the biographical sagas of Iceland. The *Heimskringla* is purely a storehouse of primitive Norwegian history.

(See also Jönsson, *Der oldnordiske og oldislandske Literaturshistorie* (Copenhagen, 1893-1902); F. W. Horn, *Geschichte der Literatur des skandinavischen Nordens* (Leipzig, 1879).)

SAGAING, a district and division of Upper Burma, lying to the south and west of Mandalay. The district has an area of 1862 sq. m.; pop. (1901) 282,658, showing an increase of 15% in the decade. It occupies both banks of the Irrawaddy, at its confluence with the river Chindwin. The chief crops are sesamum, millet, rice, peas, wheat and cotton. The total rainfall in 1905 was 34.76 in., taken at Sagaing. In the hot season the maximum shade temperature rises to a little over 100° F. The lowest readings in the cold season average about 56° F.

Sagaing, the headquarters town, is opposite Ava, a few miles below Mandalay; pop. (1901) 9643. It was formerly a capital of Burma. It is the terminus of the railway to Myitkyna. A steam ferry connects with the Rangoon-Mandalay line, and the steamers of the Irrawaddy Flotilla Company call daily.

The Sagaing division includes the four districts of Upper and Lower Chindwin, Shwebo and Sagaing; area, 29,566 sq. m.; pop. (1901) 1,000,483.

SAGALLO, a small settlement on the north shore of the Gulf of Tadjura, French Somaliland. A dismantled fort built by the Egyptians (who occupied the place between 1875 and 1884) is the most prominent object. In January 1889 Sagallo was occupied by a Cossack chief named Achinov, who was accompanied by the archimandrite Palsi and some 200 people, including priests, women and children. Palsi had been entrusted by the metropolitan of Novgorod with an evangelistic mission to the Abyssinian Church; while Achinov stated that he had a commission from the Negus for the purchase of arms and ammunition. The presence of Achinov at Sagallo (where he occupied the fort, which he found deserted) was regarded by the French government as an invasion of French territorial rights. The Russian foreign office having disavowed (7th of February) any connexion with Achinov, instructions were sent from Paris to secure the removal of the Cossacks. On the 17th of February French warships appeared off the port, and an ultimatum was sent to Achinov calling on him to surrender, but without effect. The fort was bombarded, and seven persons killed, two being women and four children. The Cossacks then surrendered, not having fired a shot. They were subsequently deported to Suez, whence they returned to Russia. Achinov was interned by the Russian government for some months (until October 1889). In 1891 he returned to Abyssinia. Palsi was promoted by his ecclesiastical superiors. In Paris the incident caused great excitement amongst the Russophiles, and the consequent demonstrations led to the suppression of the League of Patriots and the prosecution of M. Paul Déroulède.

See *L'Archimandrite Palsi et l'Ataman Achinov*, by vicomte de Constantin (Paris, 1891).

SAGAN, a town of Germany, in the Prussian province of Silesia, situated on the Boby, a tributary of the Oder, 60 m. S.S.E. of Frankfort-on-Oder and 102 m. S.E. of Berlin by the direct main line of railway to Breslau. Pop. (1905) 14,208. It is still partly surrounded by its old fortifications and has numerous medieval houses. It contains the handsome palace of the dukes of Sagan. Among other buildings are an Evangelical church with a conspicuous steeple and containing the burial vaults of the ducal family, and Augustine and a Jesuit

monasterial church, a medieval town-hall with old cloisters attached, a Roman Catholic gymnasium and a large hospital, named after its founder, the duchess Dorothea (1793-1862), wife of Edmund, duke of Talleyrand-Périgord-Dino. The leading industry of the town is cloth-weaving, with wool and flax spinning; there is also some trade in wool and grain.

The mediate principality of Sagan, now forming a portion of the Prussian governmental district of Liegnitz, and formed in 1397 out of a portion of the duchy of Glogau, has several times changed hands by purchase as well as by inheritance. One of its most famous possessors was Wallenstein, who held it for seven years before his death in 1634. Bought by Prince Lobkowitz in 1646, the principality remained in his family until 1787, when it was sold to Peter, duke of Courland, whose descendant, Prince Bozon (b. 1832), son of Napoleon Louis (1811-1898), duke of Talleyrand-Périgord, owned it in 1910. The principality has an area of nearly 500 sq. m. and a population of 65,000.

SAGAR or SAUGOR ISLAND, an island at the mouth of the Hugli river, in the Twenty-four Parganas district of Bengal. The word means "sea"; and, as being the place where the sacred stream of the Ganges is believed to mingle with the ocean, the island is one of the most frequented places of Hindu pilgrimage in all India, the time for the greatest annual gathering being in January. On the seaward face is a lighthouse, and farther out are the Sandheads, the cruising-ground of the Calcutta pilots.

SAGASTA, PRAXEDES MATEO (1827-1903), Spanish statesman, was born on the 21st of July 1827 at Torrejilla de Cameros, in the province of Logroño. He began life as an engineer, and from his college days he displayed very advanced Liberal inclinations. He entered the Cortes in 1854 as a Progressist deputy for Zamora. After the *coup d'état* of Don Leopold O'Donnell in 1856, Sagasta had to go into exile in France, but promptly returned, to become the manager of the Progressist paper *La Iberia*, and to sit in the Cortes from 1859 to 1863. He seconded the Progressist and revolutionary campaign of Prim and the Progressists against the throne of Queen Isabella, conspiring and going into exile with them. He returned, via Gibraltar, with Prim, Serrano and others, to take part in the rising at Cadiz, which culminated in the revolution of September 1868, and Sagasta was in succession a minister several times under Serrano and then under King Amadeo of Savoy, 1868-1872. Sagasta ultimately headed the most Conservative groups of the revolutionary politicians against Ruiz Zorrilla and the Radicals, and against the Federal Republic in 1873. He took office under Marshal Serrano during 1874, after the *pronunciamento* of General Pavia had done away with the Cortes and the Federal Republic. He vainly attempted to crush the Carlists in 1874, and to check the Alphonist military conspiracy that overthrew the government of Marshal Serrano at the end of December 1874. Barely eight months after the restoration of the Bourbons in the autumn of 1875, Sagasta accepted the new state of things, and organized the Liberal dynastic party that confronted Canovas and the Conservatives for five years in the Cortes, until the Liberal leader used the influence of his military allies, Jovellar, Campos and others, to induce the king to ask him to form a Cabinet in 1881. The Liberals only retained the confidence of the king by postponing the realization of almost all their democratic and reforming programme, and limiting their efforts to financial reorganization and treaties of commerce. A military and republican rising hastened Sagasta's fall, and he was not readmitted into the councils of Alphonso XII. On the death of that king in 1885, Sagasta became premier with the assent of Canovas, who suspended party hostility in the early days of the regency of Queen Christina. Sagasta remained in office until 1890, long enough to carry out all his reform programme, including universal suffrage and the establishment of trial by jury. A coalition of generals and Conservatives turned Sagasta out in July 1890, and he only returned to the councils of the regency in December 1892, when the Conservative party split into two groups under Canovas and Silvela. He was still in office when the final rising of the Cubans began in February

1895, and he had to resign in March because he could not find superior officers in the army willing to help him to put down the turbulent and disgraceful demonstrations of the subalterns of Madrid garrison against newspapers which had given offence to the military. Sagasta kept quiet until nearly the end of the struggle with the colonies, when the queen-regent had to dismiss the Conservative party, much shorn of its prestige by the failure of its efforts to pacify the colonies, and by the assassination of its chief, Canovas del Castillo. Sagasta's attempt to conciliate both the Cubans and the United States by a tardy offer of colonial home rule, the recall of General Weyler, and other concessions, did not avert the disastrous war with the United States and its catastrophe. The Liberal party and Sagasta paid the penalty of their lack of success, and directly the Cortes met in March 1899, after the peace treaty of the 10th of December 1898 with the United States, they were defeated in the senate. He pursued his policy of playing into the hands of the sovereign whilst keeping up the appearances of a Liberal, almost democratic, leader, skilful in debate, a trimmer *par excellence*, and abler in opposition than in office. He returned with the Liberals to power in March 1901. His task, however, was beyond his years. The economic situation was of the gravest. Strikes and discontent were rife. Still, Sagasta held on long enough to witness the surrender of the regency by Queen Christina into the hands of her son, Alfonso XIII., in May 1902. In the following December Sagasta was defeated on a vote of censure and resigned office. Shortly afterwards he fell into ill-health, and died at Madrid on the 15th of January 1903.

SAGE, RUSSELL (1816-1906), American financier, was born in Verona township, Oneida county, New York, on the 4th of August 1816. He worked as a farm-hand until he was 15, when he became an errand boy in a grocery conducted by his brother, Henry R. Sage, in Troy, New York. He had a part interest in 1837-1839 in a retail grocery in Troy, and in a wholesale store there in 1839-1857. He served as an alderman of Troy in 1841-1848, and as treasurer of Rensselaer county in 1845-1849. In 1853-1857 he was a Whig representative in Congress. He became an associate of Jay Gould in the development and sale of railways; and in 1863 removed to New York City, where, besides speculating in railway stocks, he became a money-lender and a dealer in "puts" and "calls" and "privileges," and in 1874 bought a seat in the New York Stock Exchange. He gradually accumulated a fortune, which at his death was variously estimated as from \$60,000,000 to \$80,000,000. On the 4th of December 1891 an attempt was made to assassinate him in his office by one Henry Norcross, who demanded a large sum of money, and upon being refused exploded a dynamite bomb, and was himself killed. Sage died in New York on the 22nd of July 1906. In 1866 he had married Miss Margaret Olivia Slocum (b. 1828), a graduate (1847) of the Troy Female Seminary (now the Emma Willard School). She inherited nearly all of his great fortune, and out of it she gave away a long series of liberal benefactions to various institutions.

SAGINAW, a city and the county-seat of Saginaw county, Michigan, U.S.A., situated on both banks of the Saginaw river, about 16 m. from its entrance into Saginaw Bay and about 66 m. N.W. of Detroit. Pop. (1890) 46,322, (1900) 42,345, of whom 11,435 were foreign-born, (1910) 50,510. Saginaw is served by the Grand Trunk, seven divisions of the Père Marquette (which has repair shops here) and four divisions of the Michigan Central railways, by interurban electric railways to Detroit and Bay City, and by steamboat lines to several of the lake ports. The city is built on level ground covering an area of about 13 sq. m. and somewhat more elevated than the surrounding country. In the city are St Vincent's Orphan Home (1875) and St Mary's Hospital (1874) under the Sisters of Charity, a Woman's Hospital (1888) and the Saginaw General Hospital

¹ Mr Sage's secretary was also killed, and one of his clerks, W. R. Laidlaw, jr., was badly injured. Laidlaw afterward repeatedly sued Sage for damages, claiming that Sage had used him as a shield at the moment of the explosion, but his suits were unsuccessful.

(1887); the Hoyt Library and the Public Library; a large auditorium, belonging to the city; an armoury; the Germania Institute, with a kindergarten, a gymnastic school and a German library; and a free bathhouse and manual training school (1903), a part of the public school system. There is an annual music festival in May. The city has parks, including Hoyt Park (27 acres), used for athletic sports, Rust Park (150 acres), occupying an island in the river, and Riverside Park, a pleasure resort. Saginaw is situated in a good farming region with a fertile soil, especially adapted to the culture of sugar beets; other important crops are beans, cabbages, tomatoes, cucumbers, hay, apples and grains. In the vicinity of the city there are salt wells, and Saginaw county is the most productive coalfield in the state—in 1907 its output was 1,047,927 tons, more than half the total for the state. The city is an important distributing centre, has a large wholesale trade (especially in groceries, hardware, boots and shoes, and dry goods), and in 1904 in the value of its factory products (\$10,403,508, 20-2% more than in 1900) it ranked fifth among the cities of the state. The municipality owns and operates the water-works. The first settlement was made on the west bank of the river in 1815 and was called Saginaw City; the settlement on the east side of the river made in 1840 was called East Saginaw and was financed by Eastern capitalists. East Saginaw in 1855 was incorporated as a village. East Saginaw and Saginaw City each received a city charter in 1859, but in 1890 the two were consolidated as the city of Saginaw, and in 1897 the charter was revised.

SAGITTA ("the arrow" or "dart"), in astronomy, a constellation of the northern hemisphere, mentioned by Eudoxus (4th century B.C.) and Aratus (3rd century B.C.), and catalogued by Ptolemy, Tycho Brahe and Hevelius, who each described 5 stars. The fable was that this constellation was one of the arrows with which Hercules killed the vulture which gnawed the liver of Prometheus. *S. Sagittae* is a short period variable, period 8-8.3 days, range in magnitude 5-6 to 6-4.

SAGITTARIUS ("the archer"), in astronomy, the 9th sign of the zodiac (*g.v.*) denoted by the symbol Υ an arrow or dart. It is also a constellation, mentioned by Eudoxus (4th century B.C.) and Aratus (3rd century B.C.), and catalogued by Ptolemy, Tycho Brahe 14 and Hevelius 22. The Greeks represented this constellation as a centaur in the act of shooting an arrow, and professed it to be Cratus, son of Eupheme, the nurse of the Muses. Several short period variables occur in the constellation, e.g. X₃ *Sagittarii*, W₁, *Sagittarii* and Y *Sagittarii*, having periods of 7-01, 7-59, 5-77 days respectively. *Nova Sagittarii* is a "new" star, which was discovered by Mrs Fleming in 1890; the nebula M. 17 *Sagittarii* is an omega or horse-shoe nebula, while the nebula and cluster M. 8 *Sagittarii* is a splendid irregular nebula associated with a great number of faint stars.

SAGO, a food-starch prepared from a deposit in the trunk of several palms, the principal source being the sago palm (*Metroxylon Sagu*) (see fig.), a native of the East Indian Archipelago, the sago forests being especially extensive in the island of Ceram. The trees flourish only in low marshy situations, seldom attaining a height of 30 ft., with a thick-set trunk. They attain maturity as starch-yielding plants at the age of about fifteen years, when the stem is gorged with an enormous mass of spongy medullary matter, around which is an outer rind consisting of a hard dense woody wall about 2 in. thick. When the fruit is allowed to form and ripen, the whole of this starchy core disappears, leaving the stem a mere hollow shell; and the tree immediately after ripening its fruit dies. When ripe the palms are cut down, the stems divided into sections and split up, and the starchy pith extracted and grated to a powder. The powder is then kneaded with water over a strainer, through which the starch passes, leaving the woody fibre behind. The starch settles in the bottom of a trough, in which it is floated, and after one or two washings is fit for use by the natives for their cakes and soups. That intended for exportation is mixed into a paste with water and rubbed through sieves into small grains, from the size of a coriander seed and larger, whence it is known according to size as pearl sago, bullet

sago, &c. A large proportion of the sago imported into Europe comes from Borneo, and the increasing demand has led to a large extension of sago-palm planting along the marshy river-banks of Sarawak.

Sago is also obtained from *Metroxylon Rumphii* as well as from various other East Indian palms such as the Gomuti palm (*Arenga saccharifera*), the Kittul palm (*Caryota urens*), the

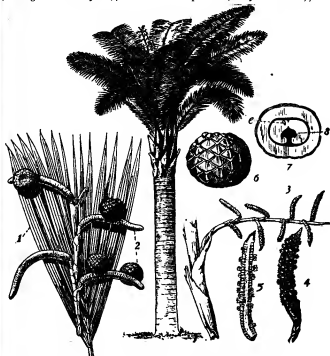

Sago Palm (*Metroxylon Sagu*), much reduced.

- 1, Portion of leaf.
- 2, Portion of female inflorescence in fruiting stage.
- 3, Branch of male inflorescence.
- 4, Spike of male flowers.
- 5, Same cut lengthwise.
- 6, Fruit.
- 7, Section of fruit and seed, *s*, embryo.

cabbage palm (*Corypha umbraculifera*), besides *Corypha Gebang*, *Raphia flabelliformis* and *Phoenix farinifera*, also from *Mauritia flexuosa* and *Guilielma speciosa*, two South American species. It is also obtained from the pith of species of *Cycas*.

SAGUENAY, a river of Quebec province, Canada, flowing into the St Lawrence 120 m. N.E. of Quebec. It drains Lake St John, from which it issues by two impassable rapids, La Grande and La Petite Décharge. Thence for 40 m. it flows E.S.E. in a series of rapids, navigable only by skilled boatmen in canoes, to Chicoutimi, the seat of a Roman Catholic bishop, a prosperous little town exporting great quantities of lumber. Six miles farther down is Ha Ha Bay, a favourite summer resort. From Chicoutimi the river is navigable by small steamers, and from Ha Ha Bay to the mouth by vessels of the largest size. It is indeed rather a loch or bay than a river, containing neither rock nor shoal, and having at its mouth a depth of some 600 ft. greater than that of the St Lawrence. Its width varies from three-quarters of a mile to two miles, and the waters are blackened by the shadow of treeless cliffs, over 1000 ft. in height, separated here and there by narrow wooded valleys, and culminating in Capes Trinity and Eternity, 1600 and 1800 ft. in height. Above Chicoutimi it runs through hills of about 400 ft. in height, densely wooded with spruce, maple and birch. Tadoussac, at its mouth, is the oldest European trading post in Canada.

Lake St John is a shallow basin, 26 m. by 20, with an area of 365 sq. m. It receives the waters of the Ashuapmucuan, often spoken of as the upper course of the Saguenay, the Mistassin, the Peribonka and various other important streams. A numerous farming population live near its shores. It is well known to anglers as containing the celebrated *ouinaniche*, or land-locked salmon, which attains a weight of about 6 lb.

SAGUNTUM, now Sagunto or Murviedro, an ancient town in a fertile district of eastern Spain (Castellon de la Plana) 20 m. N. of Valencia, close to the coast. Its history comprises one brief flash of tragic glory and a long obscure happiness. At the outbreak of the Second Punic War (219 B.C.) it was a large and commercially prosperous town of native—not Greek—origin. It sided with Rome against Carthage, and drew Hannibal's first assault. Its long and noble resistance, told by the Roman historian Livy in no less noble language, ranks with the Spanish defence of Saragossa in the Peninsular War. Finally in 218 Hannibal took it and passed on into Italy. Then we hear little more of it till at the opening of the Christian era it appears as a flourishing Romano-Spanish town with a Latin-speaking population and the rank of *municipium*. This later prosperity lasted most of the empire through, and is attested by inscriptions and ruins (notably a theatre, demolished by Suchet).

SAHARA, the great desert of northern Africa. The Sahara has an area, according to Dr A. Bludau's calculation of the areas of African river basins, of 3,459,500 sq. m., made up as follows:—

Drainage or slope to Atlantic	Sq. m.
Drainage or slope to Mediterranean	131,000
Drainage inland	502,000
Slope to Niger basin	2,602,500
	224,000
Total	3,459,500

This includes Tripoli and Fezzan, which practically belong to the desert zone, but does not include arid portions of the basins of the Nile and Niger, in which the drainage is at most intermittent, and which might with reason be included in the Sahara. The area would thus be brought up to at least 3½ million sq. m., about the area of Europe minus the Scandinavian peninsula.

The physical limits of this region are in some directions marked with great precision, as in parts of Morocco and Algeria, where the southern edge of the Atlas range looks out on what has almost the appearance of a boundless sea, and forms, as it were, a bold coast-line, whose sheltered bays and commanding promontories are occupied by a series of towns and villages—Tizgi, Figuig, El Aghuat, &c. In other directions the boundaries are vague, conventional and disputed. This is especially the case towards the south, where the desert sometimes comes to a close as suddenly as if it had been cut off with a knife, but at other times merges gradually and irregularly into the well-watered and fertile lands of the Sudan. While towards the east the valley of the Nile at first sight seems to afford a natural frontier, the characteristics of what is usually called the Nubian desert are so identical in most respects with those of the Sahara proper that some authorities extend this designation to the shores of the Red Sea. The desert, indeed, does not end with Africa, but is prolonged eastwards through Arabia towards the desert of Sind. As the Nubian region is described under **SUDAN: § Anglo-Egyptian**, the present article is confined to the country west of the Nile Valley, the Libyan desert inclusive. Its greatest length, along the 20th parallel of north latitude, is some 3200 m.; its breadth north to south varies from 800 to 1400 m.

The sea-like aspect of certain portions of the Sahara has given rise to much popular misconception, and has even affected the ideas and phraseology of scientific writers. Instead of being a boundless plain broken only by wave-like mounds of sand hardly more stable than the waves of ocean, the Sahara is a region of the most varied surface and irregular relief, ranging from 100 ft. below to 5000 and 6000 and even in isolated instances to 8000 ft. above the sea-level, and, besides sand-dunes and oases, containing rocky plateaus, vast tracts of loose stones and pebbles, ranges of the most dissimilar types, and valleys through which abundant watercourses must once have flowed.

In the centre of the Sahara is a vast mountain region known as the Ahaggar (Hoggar) Tasil or plateau. The culminating peaks of the Ahaggar range, Abou-el-Khar, to the south of Golea, have names of their own. The moving sands about Garama and other places engulfed in the popular story are regarded as archipelago (save perhaps in some instances in the Libyan desert), but there is abundant

The Ahaggar plateau is not inferior to the Alps in area, but its highest peaks do not greatly exceed 8000 ft. They are believed to be volcanic like those of Auvergne. Upon their summits snow is reputed to lie from December to March. South-east of the main plateau, and partly filling the valley between the Ahaggar plateau and the Tasil of the Asjer (see *infra*), are the Anafah mountains. To the north the valley is again contracted by the Irawen mountains.

Besides this central group of mountains, sometimes spoken of as the Atakor-N-Ahaggar (Summits of the Ahaggar), there are various other massifs in the Sahara. On the north-west of the Ahaggar, and separated from it by a wide plain, is the **Mountain ranges.** Muidir plateau, which extends nearly east and west 200 m. North-east of the Ahaggar (in the direction of Tripoli) is the Tasil of the Asjer (4000-5000 ft.), which runs for 300 m. in a N.E. to S.E. direction. South-east of the Tasil of the Asjer is a range of hills known as the Tummo (or War) mountains. Still farther south is the mountainous region of Tibesti (or Tu), with an average height of some 7000 ft., the volcanic cone of Tussid rising to an estimated height of 8800 ft. Towards the south and east the Tibesti highlands are connected with the lower ranges of Borku and Eneledi, which merge into the plains of Wadai and Darfur. The slopes are bare and rocky. By some authorities the Tasil of the Asjer, the Tummo, Tibesti and Borku ranges are considered "the orographic backbone" of the Sahara.

In addition to the plateaus and ranges named, there are several disconnected mountain masses. Midway between the Atakor-N-Ahaggar and Algeria are the Air and Aouda hills, in which Dr von Bary discovered (1877) the distinct volcanic crater of Tegindir with a vast lava-bed down its eastern side. By some writers Air (*q.v.*) is not included in the Sahara, as it lies within the limit of the tropical rains; but the districts farther south have all the characteristics of the desert. West of Air, and north-east of the bend of the Niger, lies the hilly region sometimes known as Adrar of the Ioras or of the Awellimden (the southern confederacy of the Tuareg). To the N.E., in FEZZAN (*q.v.*), are the dark mountains of Jebel-es-Soda, which arch a long S.E. towards Kufra by the similar range of the Harat; and to the extreme S. at no distance from the Atlantic, is the hilly country of the western Adrar (*q.v.*).

Nearly all the rock of the Sahara consists in the main of undulating surfaces of rock (distinguished as *hammada*), vast tracts of water-worn pebbles (*serrir*) and regions of sandy dunes (variously called *maghzer*, *erg* or *areg*, *tigidi*, and in the east *harat*), which occupy about one-ninth or one-tenth of the total area. The following is the general distribution of the dunes:—

From a point on the Atlantic coast south of Cape Blanco a broad belt of N.E. for about 1300 m., with a breadth varying from 50 to 300 m. This is usually called the Iguidi or Gidi, from the Berber word for dunes. In part it runs parallel with the Atlas mountains. Eastward it is continued, south of Algeria and Tunisia, by the Western Erg and Eastern Erg, separated by a narrow valley at Golea. South of the Eastern Erg (which extends as far north as the neighbourhood of the Gulf of Gabes) the continuity of the sandy tract is completely broken by the Hammada al-Homra (or Red Rock Plateau), but to the south of this region lie the dunes of Edeyen, which, with slight interruptions, extend to Murzuk in Fezzan. South of the hammada of Murzuk the dunes of Murzuk stretch south-east. This series of tracts may be called the northern zone of the Sahara; it forms a kind of bow, with its extremities respectively at the Atlantic and the Libyan desert and its apex in the south of Tunisia. In the south are the Juf (depressions), covering a vast area to the south-east of the middle portion of the Iguidi, another area between the Adghagh plateau and the Ahaggar, and a third between Air and Tibesti. The Juf or depressions are not, except in rare instances, below sea-level, but the Libyan desert is a region of dunes of unascertained limits; the characteristics of the Libyan desert being thought typical of the whole of the Sahara originated the idea of "a sea of shifting sand" as descriptive of the entire desert. Here a region of over 500,000 sq. m. extending east from the Tibesti mountains to the valley of the Nile, bounded south by Wadai and Darfur and north by Fezzan and the Cyrenaica, appears to be almost entirely sterile and increasingly covered by dunes. There is only one known route through this dreadful wilderness—one running north and south to the oases of Kufra, which lie in its centre. The dunes in the Libyan desert, so far as is known, run N.N.W. and S.S.E. In the Eastern Erg the dunes also lie in long lines in a N.N.W. and S.S.E. direction, presenting a gradual slope to windward and an abrupt descent to leeward. There they arc generally about 60 or 70 ft. high, but in other parts of the Sahara they are said to attain a height of upwards of 300 ft.

Under the influence of the wind the surface of the dunes is subject to continual change, but in the mass they have attained such a state of comparative equilibrium that their topographic distribution may be considered as permanent, and some of them, such as Gera (Peak) al-Shar and Gera Abou-el-Khar, to the south of Golea, have names of their own. The moving sands about Garama and other places engulfed in the popular story are regarded as archipelago (save perhaps in some instances in the Libyan desert), but there is abundant

evidence against the theory of M. Vatonne as to the dunes having been formed in situ.

Although now mainly waterless, the Sahara possesses the skeleton of a regular river-system. From the north side of the Atakor-n-

Skeleton river-system. Ahaggar, through which runs the "water-bearing" between the basins of the Mediterranean and Atlantic, begins Wadi Igharghar, which, running northwards between the Tassili plateau and the Irawen mountains, appears to lose itself in the sands of the Eastern Erg, but can be traced northwards for hundreds of miles. Its bed contains rolled fragments of lava and freshwater shells (*Cyrena* and *Planorbis*). In a line almost parallel to Wadi Igharghar, Wadi Mya descends from the plateau of Tademayt, and shows the importance of its ancient current by deep erosion of the Cretaceous rocks, in which a large number of left-hand tributaries have also left their mark. The streams flowing south from the Atlas, which seem to be absorbed in the sands of the desert, evidently find a series of underground reservoirs or basins capable of being tapped by artesian wells over very extensive areas. As Olympiodorus (quoted by Photius) mentions that the inhabitants of the Sahara used to make excavations from 100 to 120 ft. deep, out of which jets of pure water rose in columns, it is clear that this state of matters is (historically) of ancient date. Since 1856 French engineers have carried on a series of borings which have resulted in the fertilizing of extensive tracts. In Wadi Righ (otherwise Rhrh), which runs for 80 m. towards the south-west of the Shat Melir (department of Constantine, Algeria), the water-bearing stratum is among permeable sands, which are covered to a depth of 200 ft. by impermeable marls, by which the water is kept under pressure. In this valley many artesian wells have been sunk by the French. Connexions probably exist with subterranean water-supplies in the mountains to the north. That the water in the artesian reservoirs is kept aerated is shown by the existence below ground of fishes, crabs and freshwater molluscs, all of which were ejected by the well called Mezer in Wadi Righ. Further west the Wadis Zulfana and Ghir unite to form the Saura, known in Tuat as the Messaud. These rivers still carry water as far as the northern part of Tuat; thence the course of the Messaud was, apparently, S.W. to the eastern Juf. There are also well-marked river-beds in the central Sahara. The Wadi Telemis, rising in Adrar, of the Iforas, apparently joined the Niger near Gao, while the Wadi Tafassassent, which rose in the Ahaggar mountains, is believed to have been the ancient upper course of the lower Niger. In certain cases also the presence of steady supply of underground moisture for vegetation under the Saharan climate (beyond the few plants specially adapted to desert conditions) is exceptionally striking.

The existence of these wadis or river-beds is a factor in the consideration of the cause of the desert nature of the country. In all parts of the Sahara there is evidence of denudation carried out on a scale of unusual magnitude. The present surface of the desert has been exposed to the protracted wear and tear of the elements. But to determine the exact method by which the elements have done their work has hitherto proved beyond the power of science. The theory of *submarine* denudation was accepted

by many scientists of the mid-Victorian era. The sand-dunes, the salt efflorescence and deposits, and the local occurrence of certain modern marine molluscs all go to help the hypothesis of a diluvial sea. Nor is evidence lacking that in cretaceous times portions of the Sahara were covered by the sea. Colonel P. L. Montell brought home (1892) a fossil sea-urchin from Bilma. In 1902 at Tamaske, some 250 m. W. of Zinder, and a little north of Sokoto, a nautilus and four sea-urchins (fossils) were found by Captain Gaden in a limestone bed. Similar fossils occur in the region between Zinder and Air, and others of the same age have been found near Dakar. In his conclusions on these and other facts, de Lapparent held that an arm of the sea extended inland from the Atlantic to the eastern Sahara. This sea was bounded on the north and east by the mountains of Air, Ahaggar, the Asjer Tassili, &c. An extensive acquaintance with Saharan characteristics shows, however, that a sea for the Sahara as a whole is impossible. Henri Schirmer, who in 1893 published an admirable summary of Saharan geography up to that date, argued that the desert nature of the Sahara is due to forces which have been at work for ages, although, as in all deserts, the dryness is probably progressively increasing. The primary cause is to be sought in the existing distribution of land and sea. The great land-mass of North Africa causing an outflow of air in all directions (and consequently an inflow of rain) in the north, and in drought in summer, when the surface is intensely heated and the relative humidity of the atmosphere becomes so small that condensation is all but impossible. The vicinity of the comparatively cool Mediterranean in the north accentuates the force of the winds from that direction, which, blowing towards a lower latitude, are in their very nature dry winds. The influence of mountain ranges, such as the Atlas, round the border of the desert, is thus but a subordinate cause of the latter's dryness, which would probably be little diminished did the Atlas not exist. This dryness reacts again on the temperature conditions of the Sahara, accentuating both the daily and the annual variations. The intense heat of the day is compensated by the cold of the nights, so that the mean temperature is not excessive. The difference between the mean temperature of

the hottest and coldest month has been found to be as high as 45° F., and the extreme range at least 90° F., maxima of 112° and over having been frequently observed. As a result of the extreme dryness of the air, evaporation is excessive, and, being greater than the precipitation, involves a progressive desiccation of the Sahara. The surface of the rocks, heated by the sun and suddenly chilled by rapid radiation at night, gets fractured and crumbled; elsewhere the cliffs have been scored and the sand thus formed is at once turned by the wind into an active instrument of abrasion. In many places it has placed the flat rocks of the hammada as smooth as ice. Elsewhere it has scored the vertical faces of the cliffs with curious imitations of glacial striation, and helped to undercut the pillar or table-like eminences—remains of former more extensive plateaus—which, under the name qur, are among the most familiar products of Saharan erosion. The softer quartz rocks of the Quaternary and Cretaceous series have been made to yield the sand which, drifted and sifted by the winds, has taken on the form of dunes. The slightest breeze is enough to make the surface "smoke" with dust; and at times the weird singing of the sands, waxing louder and louder, tells the scientific traveller that the motion is not confined to the superficial particles. The dry wind of the Sahara is known in southern Europe as the Sirocco, and is mixed with it clouds of fine red dust, so named long since by Idrisi, the Arabian geographer. Dr Theobald Fischer and Dr Oscar Fraas agree in believing that the desiccation has markedly increased in historic times. Evidence derived from ancient monuments combined with the statements of Herodotus and Pliny are held to prove that the elephant, the rhinoceros, and the crocodile existed in North African regions where the environment is now utterly alien, and on the other hand that the camel is a late introduction.

Any attempt to improve the climatic conditions of the Sahara as a whole can hardly meet with success when the causes of its desiccation are considered. Much may, however, be done to modify local conditions, and fairly satisfactory results have been obtained in the direction of fixing the dunes and covering them with a growth of vegetation. Experiments carried out by the French at Ain Seffa, on the northern border of the desert, have shown that by protecting the sand from the action of the wind by a litter of alfalfa grass, time is given for the establishment of suitable trees, which include the tamarisk, acacia, eucalyptus, prickly pear, peach and aspen poplar, the last-named having proved the most capable of all of resisting the desert conditions. Such planting operations can only be carried out in favourable localities, such as valleys in which a certain amount of water is available. Wide areas like the arid stony plateau (hammada) must be abandoned as hopeless.

As already stated, the popular conception of the Sahara as a sand desert is erroneous. It is really a stony, wind-swept waste with much bare rock visible, the actual area of pure sand forming a relatively small portion. A broad belt of **Geological structure.** Archaean rocks extends throughout the desert, appearing at intervals in the form of hills and plateaus from beneath the superficial sands and Quaternary deposits. Examples are the granite of Air and the gneiss and mica-schists of this massif and of the Ahaggar plateau. Flanking this zone are immense tracts occupied by rocks of Devonian and Carboniferous ages, from which characteristic marine fossils have been obtained. The *productus* of El Hassi and between Wad Draa and the dunes of Igidi. *Productus africanus* is a common fossil of the Carboniferous rocks. At the close of the Carboniferous period it has been generally considered that the southern and central Sahara became dry land and has remained so up to the present day. Marine fossils of Cretaceous age have, however, been found within recent years in the central regions; while Eocene echinoids have been obtained near Sokoto (*Geol. Mag.*, 1904). During Lower Cretaceous times the Mediterranean covered the Algerian and Tripolitan Sahara and the northern portion of the eastern desert; the extensive development of the Cretaceous system being one of the most striking features of Saharan geology. At the close of the Cretaceous period the Tripolitan Sahara completely emerged, but parts of the Tunisian and Algerian Sahara seem to have remained below sea-level until the end of the Lower Eocene. Only on the extreme borders of the desert, however, do tertiary formations play any prominent part. During the Quaternary period the Sahara possessed a moister climate than the present. This is shown by the numerous water-cut valleys, now dry, and by the remains of hippopotamus in the Quaternary deposits.

The idea so long held that the Sahara represented the recently dried-up extension of the Mediterranean has been disproved by the investigations of French geologists. The sand is mainly derived from the wide expanse of Cretaceous sandstones, which become rapidly disintegrated by the contraction caused by the wide range of temperature between day and night. The loose sands of the Quaternary deposits also furnish abundant material. The true dune sand is remarkable for the uniformity of its composition and the geometrical regularity of its grains, which measure less than $\cdot 0937$ in. While individually these appear transparent or reddish yellow (from the presence of iron), they have in the mass a rich golden hue. According to Tissandier animal organisms, such as the microscopic shells of Rhizopoda, abundant in sea-sand, are strikingly absent.

Botanically the Sahara is the meeting-ground of representatives

of the "Mediterranean" and the "Tropical" floras which have accommodated themselves to the peculiar climatic conditions. The line of demarcation between the two floral areas, almost coinciding in the west with the Tropic of Cancer and in the east dipping south towards the meridian of Lake Chad, assigns

Botany and Zoology. by far the greater portion of the area to "Mediterranean" influences. Uniformity, in spite of differences of altitude and soil, is a general characteristic of the vegetation, which outside of the oases consists mainly of plants with a tufty, dry, stiff habit of growth. The oases are the special home of the date-palm, of which there are about 4,000,000 in the Algerian oases alone. In company with this tree, without which life in the Sahara would be practically impossible, are grown apples, peaches, oranges, citrons, figs, grapes, pomegranates, &c. From December to March wheat, barley and other northern grain crops are successfully cultivated, and in the hotter season rice, dukhn, durra and other tropical products. Altogether the casual flora has considerable variety; thirty-nine species are known from the Kufra group, forty-eight from the Auajila group.

Zoologically the Sahara is also partly Mediterranean, partly Tropical. Apart from the domestic animals (camels, asses, &c., and very noticeably a black breed of cattle in Adrar), the list of fifteen mammals comprises the jerboa, the fennec or fox, the jackal, the sand rat (*Psammodys obesus*), the hare, the wild ass and three species of antelope. In Borku, Air, &c., baboons, hyaenas and mountain sheep are not uncommon. Without counting migratory visitants, about eighty species of birds have been registered—the ostrich, the *Cathartes* or desert-lark (which often surprises the traveller with its song), *Emberiza Saharæ*, three species of *Dromæla*, &c. Tortoises, lizards, chameleons, geckos, skinks, &c. of fifteen different species were collected by the single Rohlf's expedition of 1873-1874; the serpents comprise the horned viper, *Psammodys subulans*, *Coelophis lacertina*, the python and several other species. The edible frog also occurs. *Cyprinodon dispar*, a fish not unlike *Cyprinodon calarianus*, is found in all the brackish waters of north Sahara and swarms in the lake of the Siwa oasis.

The chief centres of population in the Sahara are, firstly, the oases, which occupy positions where the underground water makes its way to the surface or is readily reached by boring; and, secondly, certain mountainous districts where the atmospheric moisture is condensed, and a moderate rainfall is the result. Except in the south of Algeria, where cultivation has been extended by means of artesian wells, the condition of the Sahara oases is far from prosperous. Prior to the French occupation, a feeling of insecurity had been engendered by the marauding habits of the nomad tribes; cultivation had become more restricted; and the decline of the caravan trade had brought ruin to certain centres, such as Murzuk. The most important are the oases of the Tuat region, especially Insalah; those of Ghat and Ghadames on the route from Tripoli to Zinder; and of Kufra, in eastern Sahara (see TUAT and TRIPOLI). The various confederations of the Tuareg, in the central Sahara, are grouped round hilly districts. The most important are the Awellimiden, on the left bank of the Middle Niger; and the Kel-UI, grouped around the mountainous districts of Air or Asben; the two northern confederations, those of the Ahaggar and Asjer, being less powerful. Much information respecting the Awellimiden confederation was obtained during the voyage down the Niger, in 1896, of Lieutenant Hourst of the French Navy, who was much struck with its powerful organization under the chief Maddidu. Northwest of Timbuktu in the district or "Kingdom" of Biru is the oasis and town of Walata, a Tuareg settlement. Other mountainous districts in which a certain amount of rain falls regularly, and which contain a population above the average for the Sahara, are Tibesti and Borku, in the east centre, and Adrar in the west. Tibesti and Borku are peopled by Tibbus; the western Adrar by Moors (Berbers). The northern portions of the Sahara are inhabited by nomad Arabs.

Attempts have been made by many explorers and writers to trace in certain of the existing inhabitants the remnants of an aboriginal race of negro affinities, which inhabited the Sahara before the arrival of the Berbers and Arabs.

Ethnology. E. F. Gautier, writing in 1908, maintained that the evidence available (for the central Sahara) rendered probable the hypothesis that at a period perhaps as recent as the Roman conquest of North Africa the Sahara was still neolithic and peopled by a race of agricultural negroes, who extended to the confines of Algeria. Negro influence is undoubtedly seen in various parts of the Sahara, but it may date from a much more

recent period than has been supposed. For example, the connexion between many of the place-names in Fezzan and the language of Bornu is attributable to the northward extension of the influence of the Bornu-Kanem empire between the 11th and 14th centuries A.D. The allusions by classical writers to Ethiopians as inhabitants of the Sahara prove little, in view of the very vague and general meaning attached to the word. The physical characteristics, and especially the dark colour, of many of the Saharan populations is apparently a stronger argument, but even this is capable of another explanation. Caravans of negro slaves from time immemorial passed northwards along the main desert routes, and it is just in the oases on these routes that the dark element in the population is chiefly found. It may therefore be attributed to the intermarriage of the original lighter inhabitants of the oases with such slaves. The Tibbu (*g.t.*) or Tebu, once thought to be almost pure negroes, proved, when examined by Gustav Nachtigal in Tibesti, where they are found in greatest purity, to be a superior race with well-formed features and figures, of a light or dark bronze rather than black. Their language is related to that of the Kanuri in Bornu, but it appears that the Kanuri have derived theirs from the Tibbu, not the Tibbu from the Kanuri. Physically, the Tibbu appear to resemble somewhat the Tuareg, and there is little doubt that they are a Hamitic, not a negro, people.

The commerce of the Sahara is not inconsiderable. Among the more important trade routes are (1) from Morocco to Cairo by Insalah and Ghadames, which is followed by the pilgrims of western Africa bound for Mecca; this route

has been largely superseded by the sea route from Tangier to Alexandria; (2) from Kuka (Lake Chad) to Murzuk and Tripoli; (3) from Kano and Zinder to Tripoli by Air and Ghat; (4) from Timbuktu to Insalah, Ghadames and Tripoli; (5) from Timbuktu to Insalah and thence to Algeria and Tunisia; (6) from Timbuktu to Morocco. The Senussi movement brought into prominence the desert routes between Wadai in the south and Jalo and Benghazi in the north, which partially superseded some of the older routes. Other causes tended to reduce the importance of the old routes. The long-established route from Darfur to the Kharga and Dakhila oases fell into disuse on the closing of the eastern Sudan by the Mahdist troubles. The great route leading from Tripoli via Ghadames and Ghat, to Zinder, Kano, and other great centres of the Hausa States maintains its importance, but the opening of trade from the side of the Niger by the British in the early years of the 20th century affected its value. The route across the western Sahara to Timbuktu is less used than formerly owing to the establishment by the French of a route from Senegal via Nioro to the Upper Niger. The old route, however, retains some importance on account of the salt trade from the Sahara, which centres at Timbuktu. Salt and date palms are the chief products of the Sahara. The principal sources of the salt supply are the rock-salt deposits of the Juf (especially Taudeni), the lakes of Kufra and the rock salt and brine of Bilma (*g.t.*).

The hope of an eventual commercial exploitation of the Sahara rests mainly on the possible existence of mineral wealth. To supply easy communication between Algeria and Nigeria the construction of a railway across the desert has found many advocates. Two principal routes have been suggested, the one taking an easterly line from Biskra through Wargla to Air (Agades) and Zinder—generally, the route followed by Fourcade (see below); the other starting from the terminus of the most westerly railway already existing, and reaching Timbuktu via Iglil and the Tuat oases. A third suggested route is one from Iglil to the Senegal, still farther west.

Reference may also be made to the proposal, strenuously advocated between 1870 and 1885, to open up the region to the south of Algeria and Tunisia by the construction of an inland sea. According to Colonel François Roudaire (1836-1885), the author of this scheme, deceptively styled the "flooding of the Sahara," it was possible to create an inland sea with an average depth of 78 ft. and an area of 3100 sq. m., or about fourteen times the size of the Lake Geneva. A French government commission decided that the excavation of the necessary canal would not be difficult, and that in spite of silting-up processes the canal would last at least 1000 to 1500 years. Ferdinand de Lesseps, Roudaire's principal supporter, visited the district in 1883 and reported that the canal would cost five years' labour and 150,000,000 francs. The scheme (which fell into abeyance on the

Trans-Saharan Railway Scheme.

The Flooding of the Sahara.

death of Roudaire) was based on the following facts. The Gulf of Gabes is separated by a ridge 13 m. across and 150 ft. high from Sbat-al Fejé, a depression which extends S.W. into the Sbat Jerid, which in its turn is separated from the Sbat Rbarsa only by a still narrower ridge. Sbat Garsa is succeeded westwards by a series of smaller depressions, and beyond them lies the Sbat Melhir, whose N.W. end is not far from the town of Biskra.

Politically the Sahara belongs partly to Morocco (Taflet, &c.), partly to the Turkish empire (Tripoli, Egypt, &c.), but principally to France. The French first acquired an interest in the

Political Divisions. Sahara by their conquest of Algiers (1830-45). They gradually extended their influence southward with the purpose of forming a junction with their possessions on the Senegal. The acquisition of Tunisia (1881) largely increased the hold of the French on the Sahara, and the work of French pioneers to the south of Algeria was recognized by the Anglo-French agreement of 1890, which assigned to France the whole central Sahara from Algeria to a line from Say on the Niger to Lake Chad. The southern limit of the territory was, however, not strictly defined until 1898, when a new agreement gave to France a rectangular block south of the line mentioned, including the important frontier town of Zinder. A further agreement in 1904 again modified the frontier in favour of France. To the north-east and east the boundary of the French sphere was extended, by an Anglo-French Declaration of March 1899, and defined as running south-east, from the intersection of the Tropic of Cancer with 16° E., until it meets the meridian of 24° E., following this south to the frontier of Darfur. French Sahara is thus connected with the French possessions in West Africa and with the Congo-Sahara territories of France on the south-east. On the west, where Spain claimed the Sahara coast between Capes Blanco and Bojador, the inland frontier was defined by the Franco-Spanish agreement of 1900, whereby Spain was apportioned a *Hinterland* with an average depth of 240 m. from the sea-shore.

It is impossible to ascertain the extent of the knowledge of the Sahara possessed by the ancients. The Egyptians penetrated the Libyan and Nubian deserts at points, and Carthaginians and Phoenicians were acquainted with the northern fringe of the desert in the west. European exploration dates from the beginning of the 19th century. In 1810 Captain G. F. Lyon and Joseph Ritchie penetrated from Tripoli to Murzuk, where Ritchie died. In 1822 came the great journey of Walter Oudney, Hugh Clapperton and Dixon Denham, from Tripoli to Lake Chad, and a year or two later Major A. G. Leing succeeded in reaching Timbuktu, also from Tripoli. In 1828 René Caillié crossed from Timbuktu to Morocco. Heinrich Barth in the course of his great journey (1849-1856), commenced from Tripoli under the leadership of James Richardson, traversed a considerable portion of the Sahara. Between 1859 and 1861 Henri Duveyrier explored parts of the Tuareg domain. Knowledge of the northern Sahara, from Morocco to Tripoli, was largely increased by the journeys of Gerhard Rohlfs, begun in 1861; Rohlfs subsequently crossing (1865) from Tripoli to Lake Chad by nearly the same route as that previously taken by Barth. In 1873-1874 Rohlfs visited the oases in the north of the Libyan desert and in 1878-1879 reached the oasis of Kufra. In 1876-1877 another German traveller, Erwin von Bary, made his way to Ghat and Air, but was assassinated. A French expedition under Colonel Paul Flatters after penetrating far south of Algeria was massacred (1881) by Tuareg. Farther west success was attained in 1880 by a German explorer, Dr Oster Lenz, who, starting from Morocco made his way, partly by a new route, to Timbuktu. In 1892 the Sahara was crossed from Lake Chad to Tripoli by the French Colonel Monteil.

It was not until 1890 that the central Sahara, from Algeria to Air, was traversed for the first time by Europeans. This was accomplished under the leadership of Fernand Fourreau. This journey was undertaken in pursuance of the efforts of the French to obtain effective control of the Sahara. South of Algeria military posts had been gradually pushed into the desert. Golea being until 1900 the farthest point which acknowledged French rule. The great desideratum was the opening up of a route to the Niger countries which might in time divert the trade from Tripoli to Algeria, but all attempts long proved fruitless, owing to the opposition of the tribes inhabiting central Sahara. In 1886 Lieutenant Palat was murdered a little south of Gurara, and in 1880 the same fate befell Camille Douls in Tidikelt (Tuat) in his attempt to reach Timbuktu from the north. In 1890 Fourreau—who in 1883 had undertaken a first journey of exploration

south of Wargla—reached the Tademaït plateau in 28° N., fixing the position of 35 places, and in 1892-1893 came the first of his long series of expeditions undertaken with a view of penetrating the country of the Azjer Tuareg, the powerful confederacy which lay on the route to Air and Lake Chad, never traversed in its entirety by a European. All efforts to obtain a passage were unavailing until in 1898-1899 Fourreau, accompanied by an escort of troops under Major Lamou, at last attained his object, finally reaching Zinder, the important trade centre on the borders of Nigeria, and midway between the river Niger and Lake Chad, on the 2nd of November 1899.

The important section of Fourreau's route began at Ain El-Hajaj, at about 26½° N., immediately beyond which the frowning *massif* of Tindessert had to be crossed by a most difficult route among a chaos of rocks and ravines, the geological formation being principally sandstone. After descending the southern escarpment of the "Tassili," the expedition crossed the mountainous region named Anahé, composed of quartz and granite, through which the line of partition between the basins of the Mediterranean and Atlantic was found to run. Thence the route lay across the wide plain of quartz gravel, strewn with blocks of granite, known to the Tuareg as Tiniri, to the well of In-Azaoua, beyond which a march of eleven days, with a water-supply at one point only, led to the first village of Air, where the Tuareg proved hostile. Agades, the capital of Air, was reached by a march through difficult mountains, with valleys which gradually opened into a wide plain. From Agades to Zinder the route lay, first, through the baré and arid district of Azauak; next, through the bush-covered Tagama, a district abounding in game; and, lastly, through the cultivated country of Damerghu. Zinder had only once before been reached by way of Air—by Barth's expedition in 1850. It was now occupied by a French force which had advanced from the Niger (see SENEGAL: Colony).

Fourreau's achievement was quickly followed by increased political activity of the French in the Sahara south of Algeria, where, in addition to the work of other explorers, surveys had been carried by French officers (especially Captains Germain and Laperrine in 1898) as far as the important centre of Insalah, the position of which had, as a result, been shifted some 25 m. E. of its former position on the maps, being found to lie in 2° 16' E., 20° 17' 30" N. Early in 1900 G. B. M. Flamand, who had been entrusted with a scientific mission to the Tuat oases, came into collision with the natives, and Insalah was occupied by the military escort which accompanied him. This was quickly followed by the occupation of Tuat, and Iglé (see TUAT).

Simultaneously with these events, an attempt was made to pave the way for the establishment of French influence in western Sahara by the expedition of Paul Blanchet to Adrar, which had not been visited since the middle of the 19th century. It returned in September 1900, only partially successful, Blanchet and his companions having been detained for some time as virtual prisoners on the borders of Adrar. The leader almost immediately succumbed to fever. In 1903-1909 the country N. of the lower Senegal, including Adrar, was brought under French control and organized as the territory of Mauretania.

The most marked progress was, however, effected in the central Sahara, where the French posts were gradually pushed farther south under a military organization, which resulted in the complete pacification of the Tuareg countries. Travel was thus made possible from one border of the desert to the other, and a number of successful expeditions gathered a rich harvest of results respecting the mapping, geology, and other features of this part of the Sahara. Some of the best work was done by Laperrine, Arnaud, Cortier and Nieger on the military side, and, on the civilian, by Villatte, Gautier and Chudeau. Apart from these French enterprises, Hanns Vischer, a Swiss in the service of British Nigeria, in 1906 travelled from Tripoli to Bornu through Murzuk and Bilma. In 1910 Capt. A. H. Haywood traversed the Sahara, being the first Englishman to cross the desert from Gao to Insalah.

AUTHORITIES.—Vatone, *Mission de Ghadames* (1863); H. Duveyrier, *Les Touaregs du Nord* (1864); Ville, *Explor. géologique du Masab, etc.* (1867); A. Pomet, *Le Sahara* (1872); F. G. Rohlfs, *Quer durch Afrika* (1874), *Drei Monate im libyischen Wüste* (1875) and *Kufra* (1881); V. Lareau, *Le Pays de Rikra-Ouargla* (1879); G. Nungtall, *Sahara und Sudan* (3 vols., 1879-1880); C. Roland, "Le Cratère du Sahara septentrional" (with geological map of the Central Sahara), in *Bull. de la Soc. Géol. de France* (1881); Roudaire,

Rapport sur la dernière expéd. des Chotts (1881) (and other reports by the same author); Tchiחתר, "The Deserts of Africa and Asia," in *British Association Reports* (Southampton, 1882); Derré-cagaix, "Explor. du Sahara: les deux missions du Lieut.-Colonel Flatters," in *Bull. de la Soc. de Géogr.* (1882); O. Lenz, *Timbuktu. Reise durch Marokko, &c.* (1884); and E. L. Reclus, *Nouv. Géographie univ.* xi. (1886); H. Schirmer, *Le Sahara* (Paris, 1893); P. Vuillot, *L'Exploration du Sahara* (Paris, 1895); P. J. Monteil, *Le Sahara. Louâ à Tripoli* (Paris, 1895); F. Fourreau, *D'Alger au Congo par le Tchad* (Paris, 1902) and *Documents scientifiques de la mission saharienne*, fasc. i-iii. (Paris, 1903-1905); Privat-Deschanel, "Peut-on reboiser le Sahara?" *Rev. scientifi.* (1896); K. A. Zittel, *Paläontologie der libyschen Wüste* (Cassel, 1893); G. Rolland, *Chemin de fer transsaharien, géologie du Sahara algérien, et aperçu géologique sur le Sahara de l'océan atlantique à la mer rouge* (Paris, Imp. Nat., 1891); J. Walthier, *Die Denudation in der Wüste* (Leipzig, 1900); M. Honoré, *Le Transsaharien et la pénétration française en Afrique* (Paris, 1901); E. Dürkop, *Die wirtschafts- und handels-geographischen Provinzen der Sahara* (Wolffenbüttel, 1902); W. J. Harding King, *A Search for the Masked Twareks* (London, 1903); A. Bernard and N. Lacroix, *La Pénétration saharienne* (Algiers, 1906); C. Vélain, "Etat actuel de nos connaissances sur la géographie et la géologie du Sahara d'après les explorations les plus récentes," *Revue de géogr. t. i.* (1906-1907), pp. 447-517; J. Lahache, "Le Déssechement de l'Afrique française est-il démontré?" *Bul. Soc. Géogr. Marseille*, 31 (1907), pp. 149-185; E. Arnaud and M. Cortier, *Mission Arnaud-Cortier: nos confins sahariens* (Paris, 1908); E. F. Gautier and R. Chudeau, *Missions au Sahara*, t. i. "Sahara algérien," par E. F. Gautier (Paris, 1908), t. ii. "Sahara sudanais," par R. Chudeau (Paris, 1909); H. Vischer, *Across the Sahara from Tripoli to Bornu* (London, 1910); H. J. Ll. Beadnell, "Sand Dunes of the Libyan Desert," *Geog. Jour.* (April 1910); E. Fallot, "Le Commerce du Sahara," *Qués. dip. et col. t. 15* (1903), pp. 209-225. (E. HZ.; F. R. C.)

SAHARANPUR, a city and district of British India, in the Meerut division of the United Provinces. The city is situated on a stream called the Damaula Nadi, 907 ft. above sea-level, 998 m. by rail from Calcutta. Pop. (1901) 66,254, of whom more than half are Mahomedans. It is an important junction of the North-Western railway with the Oudh and Rohilkhand line. The government botanical gardens were established in 1817. There are railway workshops, and a large industry is pursued in wood-carving.

The DISTRICT OF SAHARANPUR has an area of 2228 sq. m. It forms the most northerly portion of the Doab, or alluvial tableland between the Ganges and Jumna. The Siwalik hills rise precipitously on its northern frontier; at their base stretches a wild submontane tract, with much forest and jungle. Cultivation generally in this part is backward, the surface of the country being broken by ravines. South of this tract lies the broad alluvial plain of the Doab, with fertile soil and good natural water-supply. This portion of the country is divided into parallel tracts by numerous streams from the Siwaliks, while the Eastern Jumna and Ganges canals cover the district with a network of irrigation channels. The annual rainfall averages about 37 in. The population in 1901 was 1,045,230, showing an increase of 4.4% in the decade. The principal crops are wheat, rice, pulse, millet, and maize, with some sugar-cane and cotton. The district contains the towns of Roorkee and Hardwar.

During the later years of the Mogul empire, Saharanpur suffered much from the perpetual raids of the Sikhs, but in 1785 the district under Ghulam Kadir enjoyed comparative tranquillity. On his death the country fell into the hands of the Mahrattas. It was afterwards again overrun by the Sikhs, remaining practically in their hands until their defeat at Charaon November 1804, when it passed under British rule. Several disturbances subsequently took place among the native chiefs; but from 1824 to 1857 nothing occurred to disturb the peace of the district. The Mutiny in this part was soon quelled.

SAHEL (Arabic for "shore"); a common place-name in countries where Arabic is the dominant language. By *sahel* any coast belt may be indicated, but the name has become the definite designation of certain districts, e.g. the Tunisian coast between the gulfs of Hammamet and Gabes. Another region so called is that part of the Sahara washed by the Atlantic. The name is also used to designate the territory under French jurisdiction west of Timbuktu and north of the Senegal. **Sahel** thus understood comprises regions which form the inter-

mediate zone between the fertile lands of the Sudan and the desert. In its plural form, Swahili, the word has become the tribal name of the natives inhabiting the coast strip opposite Zanzibar.

SAHIB, a title of respect in India, specially used to designate Europeans. The word is Arabic, and originally means a companion. It is generically fixed to the titles of men of rank, as Khan Sahib, Nawab Sahib, Raja Sahib, and is equivalent to master. The proper feminine form is *sahiba*; but the hybrid term *mehsahib* (from *mamam* and *sahib*) is universally used in India for European ladies.

SAHOS, or ΣΗΘΟΣ, Africans of Hamitic stock living to the W. of Massawa. Some authorities regard them as true Abyssinians, but more probably they are akin to the Gallas and Afars. They are for the most part Mahomedans, but some few are Christians.

SAHYADRI, a mountain range of India. The term, which is Sanskrit rather than vernacular, is applied to the entire system of the Western GHATS (*q.v.*) from the Tapi river to Cape Comorin, but more especially to that part of the system in the Bombay Presidency. In this restricted sense the Sahyadri hills begin in Khandesh district, and run S. as far as Gao.

In the territory of the Nizam of Hyderabad, the cross range forming the watershed between the river systems of the Tapi and the Godavari, is locally known as Sahyadri Parbat.

SAIDAPET, a town of British India, administrative headquarters of Chingleput district, Madras, on the South Indian railway, 5 m. S.W. of Madras city, from which it is separated by a line of tanks. Pop. (1901) 14,254. The government teachers' college has a hostel or boarding-house for Brahmans, opened in 1897. The agricultural college, originally (1865) a model farm, has been transferred to Coimbatore.

SAID PASHA (c. 1830—), surnamed KUCHUK, Turkish statesman, was at one time editor of the Turkish newspaper *Jeride-i Havadis*. He became first secretary to Sultan Abd-ul-Hamid II. shortly after his accession, and is said to have contributed to the realizations of his majesty's design of concentrating power in his own hands; later he became successively minister of the interior and Vali of Brussa, reaching the high post of grand vizier in 1879. A Turkish statesman of the old school, he was regarded as somewhat bigoted and opposed to the extension of foreign influence in Turkey. He was grand vizier four more times under Abd-ul-Hamid. In 1896 he took refuge at the British embassy at Constantinople, and, though then assured of his personal liberty and safety, remained practically a prisoner in his own house. He came into temporary prominence again during the revolution of 1908. On the 22nd of July he succeeded Ferid Pasha as grand vizier, but on the 6th of August was replaced by Kiamil Pasha, a man of more liberal views, at the instance of the young Turkish committee.

SAID PASHA KURD (1834-1907), Turkish statesman, son of Hussein Pasha, was born at Suleimanif. After holding various administrative posts he became governor-general of the Archipelago (1881), minister for foreign affairs (1882), ambassador at Berlin (1883) and again foreign minister in 1885. He was afterwards president of the Council of State, an office which he held till his death on the 29th of October 1907.

SAIGA (*Saiga tatarica*), the native designation of a desert-dwelling antelope, easily recognized by its extraordinary swollen and puffy nose, in which the apertures of the tubular nostrils are directed downwards. The ringed lyrate horns of the males are amber-coloured, and wide apart on the head. There is a small gland on each side of the face below the eye; and the ears are remarkable for their short and rounded form. The colour is whitish in winter and sandy in summer. It is the sole representative of its genus. At the present day the headquarters of this antelope are the Kirghiz Steppes, but a century ago its range extended as far west as Poland. During the latter part of the Tertiary period the saiga was much more widely distributed, fossilized remains having been obtained from many parts of Western Europe, including Britain.

SAIGO, TAKAMORI (1832-1877), Japanese patriot, was born in Satsuma in 1832. From early youth he took a prominent part in the politics of his clan, and owing to his extreme opinions with regard to the expediency of abolishing the Tokugawa administration, he was banished (1838) to the island of Oshima (Satsuma), where he attempted unsuccessfully to commit suicide. Ultimately he rose to high rank in the newly organized imperial government, but in 1873 he retired from the cabinet by way of protest against its decision not to take armed action against Korea. Thenceforth he became the rallying point of a large number of men dissatisfied with the new administration, and in 1877 he headed a rebellion which taxed all the resources of the central government. After several months of desperate fighting, Saigo and a small remnant of his followers made a swift retreat to Kagoshima, and fell fighting (September 14) within sight of their homes. Saigo's patriotism and his great services in the cause of the restoration of the administrative power to the throne were so fully recognized that his son was raised to the peerage with the title of marquis, and his own memory was honoured by the erection of a bronze statue in Tokyo.

SAIGON, a town of French Indo-China, capital of the colony of Cochinchina, on the right bank of the river Saigon, 34 m. from the sea. Pop. (1905) 54,745, of whom 8749 were French (exclusive of troops), 152 Europeans of other nationalities, about 30,000 Annamese, 14,000 Chinese. The town is enclosed by the river Saigon on the east, the Chinese Arroyo on the south and the Arroyo of the Avalanche on the north, while on the west it extends towards the neighbouring town of Cholom. Double rows of trees give shade in all the streets, the width and uniformity of which, together with the beautiful gardens (including the zoological gardens), make Saigon one of the finest towns of the Far East. It is lighted chiefly by electricity and its water-supply is secured by a filtering reservoir. The chief public buildings are the government house, the palace of the lieutenant-governor of Cochinchina, the law courts, the theatre, the post-office and the cathedral. The commercial port, at the mouth of the Chinese Arroyo, carries on a large rice trade. The naval harbour comprises an arsenal and has a repairing dock.

Saigon is the seat of two chambers of the court of appeal of French Indo-China, of tribunals of first instance and of commerce, and of the vicar apostolic of Cochinchina. Its municipal council consists of eight French and four native members elected by universal suffrage. This body elects a mayor and two assistants.

Before the French conquest, Saigon, then known as *Gia-dinh-thanh*, was the capital of Lower Cochinchina, which consisted of the "six southern provinces" of the Annamese empire, and constituted a vice-royalty under the government of a *kinhluoc*. In 1836 it was fortified for the emperor Gia Long by Colonel Ollivier. The French captured it in 1859, and it was part of the territory ceded in 1862.

SAIL, the English equivalent of the common Teutonic word for one of the two universal means of propulsion of a vessel through the water, the other being the oar (*q.v.*). For the various types of sail see RIGGING, and for the textile material used see SAILCLOTH below. The origin of the O. Eng. *segl* or *segel* and its cognates, e.g. Dutch *zeil*, Dan. *seil*, Ger. *Segel*, &c., is not known; it is certainly not connected with the Lat. *sagulum*, cloak, mantle. It may be derived from the Indo-European root *sagh-*, seen in Sanskrit *śah*, endure, the idea being of that which bears up against or resists the wind.

SAILCLOTH, now more commonly called canvas (*q.v.*), usually a double warp, single weft fabric of the same structure as bagging (*q.v.*), although it is sometimes made with single threads of warp. Hemp and ramie are occasionally used in the manufacture of this cloth, but flax and cotton are the chief fibres employed. Many of the sails of fishing smacks and similar vessels are made entirely of cotton—the fabric sometimes

retaining its natural colour, but more often dyed or stained tan. Since most of the larger vessels are now driven by steam, the quantity of cloth used for sails is comparatively small. A large quantity of cloth, however, is used on steamships for covers, and for coal bags, sailcloth buckets, &c.

The very best kind of sailcloth is made from long flax, as this fibre possesses flexibility, lightness and strength combined. The number of threads per inch of warp varies from 14 double threads to 48 double threads, and from 12 to 36 shots per inch of weft, while the usual widths are 18, 24, 30 and 36 in. Cotton canvas has for its limits about 26 to 54 threads of warp per inch, and 15 to 46 shots per inch; the warp yarn for cottons may be 2, 3 or several ply.

Great care has to be exercised in the manufacture of canvas for the British Admiralty. The yarns must be made wholly from long flax, well and evenly spun, and properly twisted. They must also be free from blacks, and be twice boiled in order to remove all injurious matter. From the grey state to the cleaned state the yarns must lose 10% of weight, and no deleterious substance whatever must be used in any stage. The mill washing and first boiling reduce the weight about 8%, while about 2% is removed during the second boiling. Finally, the yarn is thoroughly washed to remove all traces of alkali. The successive processes which the yarn is subjected to remove all impurities, and leave the yarn in the best condition for weaving. Canvas is made in sixteen different qualities; the heaviest is No. 0000, then follow Nos. 000, 00, 0, 1, 2, 3, 4, 5, 6, 7, 8, 9, 10, 11 and 12. Of these sixteen varieties Nos. 1 to 8 are mostly in use. Nos. 1, 2, 4, 6 and 7 are used for royal navy canvas, and Nos. 4 and 6 for the merchant navy. The canvas for the Admiralty is 24 in. wide, and the pieces, termed bolts, should be as nearly as practicable 40 yds. of legal measure in length, and to be completely manufactured—particular attention being given to the weaving; the selvages to be evenly and well manufactured, the thrum to be left on each end of the bolt, and to be made as nearly as possible in the proportion of weights given below.

The breaking tests for red and grey canvas are 5% below those for white canvas.

Sailmaking is a very ancient industry, but it is, naturally, much less important than it was before the introduction of steamships. The operations of the sailmaker may be stated as follows. The dimensions of mast and yards and sail plan being supplied, the master sailmaker is enabled to determine the dimensions of each sail—after due allowance for stretching—in terms of cloths and depth in yards—if a square sail, the number of cloths in the head, and number in the foot and the depth in yards; if a fore-and-aft sail (triangular), the number of cloths in the foot and the depth in yards of the luff or stay and of leech or after-leech; if a fore-and-aft sail (trapezium form), the number of cloths in the head, number in foot, and the depth of mast or luff and of after-leech. These particulars obtained, there is got out what is technically termed a "casting," which simply means the shape, length, &c., of each individual cloth in the sail. These figures are given to the cutter, who proceeds to cut out the sail cloth by cloth in consecutive order, numbering them 1, 2, 3, 4, &c.; the series of cloths thus cut out are handed over to the workman, who joins them together by carefully made double flat seams, sewn with twine specially prepared for the purpose, with about 120 stitches in a yard. In the heavy

Canvas Number.	Weight of Warp.	Weight of Bolt.	Length of Bolt.	Reed.	No. of Threads.	Breaking Test for Warp.	Breaking Test for Weft.	Dimensions of Testing Strip.
	lb.	lb.	yds.	Score.	Double.	lb.	lb.	in.
1	26	46	39	16 $\frac{1}{2}$	660	340	480	24×1
2	24	43	39	16 $\frac{1}{2}$	660	320	460	24×1
3	22	40	39	16 $\frac{1}{2}$	660	300	440	24×1
4	19	36	39	17	680	280	400	24×1
5	18	33	39	17	680	260	370	24×1
6	18	33	39	17	680	250	350	24×1
7	15	27	40	20	800 single	330	390	24×1 $\frac{1}{2}$
8	14	23	40	20	800 "	310	380	24×1 $\frac{1}{2}$

sails the seam is about 1 $\frac{1}{2}$ in. in width, and in the British navy stuck or stitched in the middle of the seam to give additional strength; the seams in the lighter sails are about 1 in. wide. The whole of the cloths are then brought together, and spread out, and the tabling (or hemming, so to speak) is turned in and finished off with about 72

stitches to a yard. Strengthening pieces or "linings" are affixed where considered necessary, in courses and top-sails such pieces as reef-bands, middle-bands, foot-bands, leech-linings, bunt-line cloths; in top-sails (only a top-lining or brim; in other and lighter sails such pieces as mast-lining clew and head, tack and corner pieces; holes, such as head, reef, stay (luff), mast, cringle, bunt-line, &c., are also made where required, a grommet of line of suitable size being worked in them to prevent their being cut through. The next thing to be done is to secure the edges of the sail. Bolt-ropes, a comparatively soft laid rope made from the finer hemp yarn (Italian) is used for this purpose; in the British navy it ranges from 1 in. (increasing in size by quarter inches) up to 8 in. inclusive; it is then neatly sewn on with roping twine specially prepared, the needle and twine passing between and clear of every two strands of the rope in roping. Where slack sail has to be taken in, it is the practice to leave it to the judgment of the sail-maker; but where possible it is better to set up the rope by means of a tackle to a strain approximate to what it will have to bear when in use, and whilst on the stretch mark it off in yards, as also the edge of the sail in yards, so that by bringing the marks together in roping the sail will stand flat. In the British navy the largest size of rope sewn on to a sail is 6 in; sizes above this are used for foot and clew ropes of top-sails and courses, being first wormed, parcelled (that is, wound round with strips of worn canvas), tarred and served over with spun yarn; the foot of the sail is then secured to it by being marled in. Where two sizes of bolt-rope is used in roping a sail have to be connected, it is effected by a tapered splice. Cringles (similar to the handle of a maund) formed by a strand of bolt-rope, mostly having a galvanized iron thimble in them as a protection, are then stuck where necessary, as at the corners, sides or leeches, mast or luff; they are required either for making stationary or hauling "tars" by tackle or otherwise certain parts of the sail when in use. Fore-and-aft sails, such as spankers, gaff-sails and storm try-sails, are reduced in size by reef-points made of stout line (4 to 20 lb), crow-footed in the middle, a hole being pierced through every seam; one-half of the point is passed through and the crowfoot sewn firmly to the sail; the number of reefs depends upon the size of the sail, and the reefs are placed parallel to the foot. The sails—now finished in respect of making—have to be fitted, that is, such ropes have to be attached to each of them as are necessary for proper use; such ropes may, be sewn on as follows: head-earings, robands, reef-earings, reef-lines, spilling and slab lines, reef-tackle pendant, reef-points, bow-line bridles, bunt-line toggles, bunt-becket, leech-line strops and toggles, toggles in clews, sheet ropes, down-haul, lacings, head and stay, tack-ropes (gaff top-sail), tack lashing, bending strops, matting and gaskets.

The tools and appliances of a sailmaker are very numerous: a bench about 7 ft. long and 15 in. high, upon which he sits; palms

for seaming and roping to fit the hand, made of hide lined with leather, a plate properly tempered being fixed in it having chambers to catch the head of the needle, thus acting as a thimble; needles of various sizes, that for seaming being the smallest; and fids, splicing, serving and stretching knife, rubber sail-hook, bobbin for twine, and sundry small articles. (T. Wo.)

SAINFOIN (*Onobrychis sativa*) in botany is a low-growing perennial plant with a woody rootstock, whence proceed the stems, which are covered with fine hairs and bear numerous long pinnate leaves, the segments of which are elliptic. The flowers are borne in close pyramidal or cylindrical clusters on the end of long stalks. Each flower is about half an inch in length with

The indehiscent pods or legumes are flattened from side to side, wrinkled, somewhat sickle-shaped and crested, and contain a single olive-brown seed shaped like a small bean. In Great Britain the plant is a native of the calcareous districts of the southern counties, but elsewhere it is considered as an escape from cultivation. It is native throughout the whole of Central Europe and Siberia; but it does not seem to have been cultivated in Great Britain till 1651, when it was introduced from France or French Flanders, its French name being retained. Alphonse de Candolle (*Origin of Cultivated Plants*, p. 104) considers that the cultivation of sainfoin originated in the south of France as late perhaps as the 15th century. It is grown as a forage plant, being especially well adapted for dry limestone soils. It has about the same nutritive value as lucerne, and is esteemed for milch cattle and for sheep in winter. Besides the common form, a second known as giant sainfoin is met with in cultivation, being more rapid in its growth.

SAINT (lat. *sanctus*, "holy"), the term originally applied, e.g. in the New Testament and in the most ancient monuments of Christian thought, to all believers. In this sense it is still used by those modern Christian sects which profess to base their polity on the Bible only (e.g. the Mormons or "Latter Day Saints"). In ancient inscriptions it often means those souls who are enjoying eternal happiness, or the martyrs. Thus we find inscriptions in the Catacombs such as *vivas inter sanctos, refrigera cum spiritu sancto*, and people were buried *ad sanctos*. For a long time, too, *sanctus* was an official title, particularly reserved for bishops (v. *Analecta Bollandiana*, xviii. 410-411). It was not till almost the 6th century that the word became a title of honour specially given to the dead whose cult was publicly celebrated in the churches. It was to the martyrs that the Church first began to pay special honour. We find traces of this in the 2nd half of the 2nd century, in the *Martyrium Polycarpi* (xviii. 3) in connexion with a meeting to celebrate the anniversary of the martyr's death. Another passage in the same document (xvii. 3) shows clearly that this was not an innovation, but a custom already established among the Christians. It does not follow that it was henceforth universal. The Church of Rome does not seem to have inscribed in its calendar its martyrs of an earlier date than the 3rd century. The essential form of the cult of the martyrs was that of the honours paid to the illustrious dead; and these honours were officially paid by the community. They consisted in a gathering at the martyr's tomb on the anniversary of his death. St Cyprian, speaking of the confessors who died in prison, wrote to his priests, "Denique et dies eorum, quibus excedunt, adnotate, ut commemoraciones eorum inter memorias martyrum celebrare possimus" (*Epist.* xii. 2). The list of anniversaries of a church formed its *Martyrology* (q.v.). In the early days each church confined itself to celebrating its own martyrs; but it was not long before it became customary to celebrate the anniversaries of martyrs of other churches. In the oldest Roman ferial we already find festivals of Carthaginian martyrs, and similarly, in the Carthaginian calendar, Roman festivals, while Wright's *Syriac Martyrology* contains numerous traces of this exchange of festivals. From the 5th century onwards certain celebrated saints were honoured almost universally; St Augustine (*Sermo*, 276, § 4) says that the festival of St Vincent was celebrated throughout the whole of the Christian world. The same was the case of the festivals of St Stephen, St James and St John, and St Peter and St Paul, as is shown by the liturgical documents, but these festivals were held in connexion with that of Christmas (26th, 27th and 28th December), and were not strictly speaking anniversaries.

The calendars at first included only martyrs, but their scope was gradually widened. The first to find a place in them were the bishops. Apparently they were at first arranged in a series of anniversaries separate from that of the martyrs, as seems to be shown by the existence at Rome of the *Depositio episcoporum* side by side with the *Depositio martyrum*; the two lists seem to have been combined, as in the calendar of Carthage, which includes the *dies natalicorum martyrum et depositioes episcoporum*. Some of the most famous bishops also ended by passing from one calendar into the other. Finally, the ascetics came to share in the honours paid to the martyrs, and we see in the *Historia religiosa* of Theodoret how quickly this



Sainfoin (*Onobrychis sativa*). 1, Fruit, nat. size.

lanceolate calyx-teeth shorter than the corolla, which latter is papilionaceous, pink, with darker stripes of the same colour.

assimilation took place. In times of persecution the martyrs were buried among the rest of the faithful, but one can understand that their tombs, at which gatherings took place at least on the day of their anniversary, were distinguished from the ordinary tombs by some sign. When the peace of the Church permitted it, they were enshrined in chapels and often in sumptuous basilicas. In the West the buildings were erected over their tombs, which were left intact; but in the East there was no hesitation in disturbing the graves of the saints and removing the bodies to a basilica built to receive them. It is in this way that the relics of St Babylas were placed in the sanctuary built by Gallus at Daphne (Socrates, *Hist. eccl.* iii. 18; Sozomen, *Hist. eccl.* v. 19). As a matter of fact, the discipline of the Eastern churches with regard to the relics was, from the very beginning, much less severe than that of Rome and a great number of the Western churches. From the 4th century on are recorded cases of translation of the bodies of saints, and they did not even shrink from dividing the sacred relics. In the West the principle already laid down by St Gregory the Great in his letter to Constantia, namely that of not disturbing the bodies of the saints, was for a long time the rule in all cases, and the portions distributed to the churches were simply *brandea*, that is to say, linen which had lain upon the tomb of the saint, or, in other words, representative relics. But as early as the 7th century there is proof of a relaxation of this rule which had so well safeguarded the authenticity of the relics. It was finally disregarded altogether; in the 9th century translations of relics were extremely frequent, and led to inextricable confusion in the future.

As to the belief in the efficacy of the prayers of the saints for those still living on earth, and similarly in the efficacy of the prayers addressed to the saints, St Cyril of Jerusalem indicates in the following words the advantages of the commemoration of the saints: "Then we make mention also of those who have fallen asleep before us, first of patriarchs, prophets, apostles, martyrs, that God would at their prayers and intercessions receive our supplication" (Cat. *Myst.* v. 9). It is difficult to understand a much-discussed passage of Origen (*De oratione*, 14), except as applying to prayer addressed to the saints. The Fathers of the 4th century, and notably the Cappadocian Fathers, provide us with a quantity of evidence on this subject, which leaves no doubt as to the practice of the invocation of saints, nor of the complete approval with which it was viewed. St Basil, for example, says: "I accept also the holy apostles, prophets and martyrs, and I call upon them for their intercession to God, that by them, that is by their mediation, the good God may be propitious to me, and that I may be granted redemption for my offences" (*Epist.* 360).

The cult of the saints early met with opposition, in answer to which the Church Fathers had to defend its lawfulness and explain its nature. The Church of Smyrna had early to explain its position in this matter with regard to St Polycarp: "We worship Christ, as the Son of God; as to the martyrs, we love them as the disciples and imitators of the Lord" (*Martyrium Polycarpi*, xvii. 3). St Cyril of Alexandria defends the worship of the martyrs against Julian; St Asterius and Theodoret against the pagans in general, and they all lay emphasis on the fact that the saints are not looked upon as gods by the Christians, and that the honours paid to them are of quite a different kind from the adoration reserved to God alone. St Jerome argued against Vigilantius with his accustomed vehemence, and especially meets the objection based on the resemblance between these rites and those of the pagans. But it is above all Augustine in his *Confession of Faith*, as well as in his sermons and elsewhere, clearly defined the true character of the honours paid to the saints: "Non eis templa, non eis altaria, non sacrificia exhibemus. Non eis sacerdotes offerunt, absit, Deo praestantur. Etiam apud memorias sanctorum martyrum cum offerimus, nonne Deo offerimus? . . . Quando audistis dici apud memoriam sancti Theogenis: offero tibi, sancte Theogenis: aut? offero tibi Petre, aut: offero tibi Paule?" (*Sermo*, 273, 7; cf. *Contra Faustum*, xx. 21). The undoubted abuses which grew up, especially during the middle ages, raised up, at the time of the Reformation, fresh adversaries of the cult of the saints. The council of Trent, while reproving all superstitious practices in the invocation of the saints, the veneration of relics and the use of images, expresses as follows the doctrine of the Roman Church: "That the saints who reign with Christ offer to God their prayers for men; that it is good and useful to invoke them by supplication and to have recourse to their aid and assistance in order to obtain from God His benefits through His Son our Saviour Jesus Christ, who alone is our Saviour and Redeemer" (*Sess.* xxv.). At the present day the canonization (*q. v.*) of saints is reserved in the Roman Church to the sovereign pontiff. The Anglican Church, while still commemorating many of the Catholic saints, has not, since the Reformation, admitted any new names to the authoritative list, with the single exception of that of King Charles I., whose "martyrdom" was celebrated by authority from the Restoration until the year 1859.

See D. Petavius, *De theologicis dogmatibus, De incarnatione*, l. xiv.; F. Suarez, *Defensio fidei catholicae* (against King James I.); L. Duchesne, *Les Origines du culte chrétien*, ch. viii.; E. Lucius, *Die Anfänge des Heiligenkults* (Tübingen, 1904); H. R. Percival, *The Invocation of Saints* (London, 1896); A. P. Forbes, *An Explanation of the Thirty-nine Articles* (Oxford, 1878). (H. DE.)

ST AFFRIQUE, a town of Southern France, capital of an arrondissement in the department of Aveyron, on the Sorgues, 68 m. N.N.W. of Beziers on a branch line of the railway to Clermont Ferrand. Pop. (1906) town, 4473; commune 6571. An old bridge over the Sorgues and some megaliths in the neighbourhood, especially the dolmen at Tiergues, are of antiquarian interest. There is considerable trade in wool and Roquefort cheese.

St Afrique grew up in the 6th century around the tomb of St African, bishop of Comminges. In the 12th century a fortress was built on the neighbouring rock of Caylus. The possession of St Afrique was vigorously contested during the wars of religion. It was eventually occupied by the Huguenots till 1629, when it was seized and dismantled by a royal army.

ST ALBANS, EARLS AND DUKES OF. The English title of earl of St Albans was first borne by Richard Bourke, or de Burgh, 4th earl of Clanricarde (d. 1635), who was lord president of Connaught from 1604 to 1616 and governor of Galway in 1616. In 1624 he was made Baron Somershill and Viscount Tunbridge in the English peerage, and in 1628 earl of St Albans, Baron Imanney and Viscount Galway. He became the third husband of Frances, dowager countess of Essex, whose first husband had been Sir Philip Sidney, and his English titles became extinct on the death of his only son, Ulick, 2nd earl of St Albans and marquess of Clanricarde, in 1657.

The second creation of an earl of St Albans was in 1660, when Henry, Baron Jermyn, was made an earl under this title; but again it became extinct on his death in 1684.

The dukedom of St Albans was created in 1684 in favour of CHARLES BEAUCLERK (1670-1726), a natural son of Charles II. by Nell Gwynne. Born in London on the 8th of May 1670, Charles was made Baron Hedington and earl of Burford in December 1676. He became colonel in the 8th regiment of horse in 1687, and took service with the emperor Leopold I., being present at the siege of Belgrade in 1688. After the battle of Landen in 1693, William III. made him captain of the gentlemen pensioners, and four years later gentleman of the bedchamber. His father had given him the reversion of the office of hereditary master falconer and that of hereditary registrar of the Court of Chancery, which fell vacant in 1698. His Whig sentiments prevented his advancement under Anne, but he was restored to favour at the accession of George I. He died at Bath on the 10th of May 1726. His wife Diana, daughter and heiress of Aubrey de Vere, 2nd earl of Oxford, was a well-known beauty, who became lady of the bedchamber to Caroline, princess of Wales, and survived until the 15th of January 1742. Charles was succeeded by his eldest son, CHARLES BEAUCLERK, 2nd duke of St Albans (1696-1751), while his youngest son, Lord Aubrey Beauclerk (c. 1710-1741), became a captain in the royal navy, and perished in a fight in the West Indies on the 22nd of March 1741. The second duke's son and heir, GEORGE BEAUCLERK, 3rd duke (1730-1786), was followed by his second cousin, George Beauclerk (1758-1787), 4th duke, who died unmarried, and was succeeded as 5th duke by his cousin, Aubrey Beauclerk (1740-1802). He was succeeded by his son Aubrey, the 6th duke (1765-1815), whose infant son Aubrey 7th duke (b. 1815), died within a year of his father. The 8th duke, William (1766-1825), was the second son of the 5th duke. His son William (1801-1849), the 9th duke, married the actress Harriot Mellon, widow of the banker Thomas Coutts. She was celebrated for her beauty, and was painted by Romney. Her fortune derived from her first husband passed to her granddaughter Angela, Baroness Burdett-Coutts in her own right. The 9th duke was succeeded by his son by a second marriage, William Amelius Aubrey de Vere (1849-1898), the 10th son, Charles Victor Albert Aubrey de Vere, became the 11th holder of the title.

ST ALBANS, HENRY JERMYN, EARL OF (c. 1604-1684), was the third son of Sir Thomas Jermyn of Rushbrooke, Suffolk. At an early age he won the favour of Queen Henrietta Maria, whose vice-chamberlain he became in 1628, and master of the horse in 1630. He was a consummate courtier, a man of dissolute morals, and much addicted to gambling. He was member for Bury St Edmunds in the Long Parliament and an active and reckless royalist. He took a prominent part in the army plot of 1641, and on its discovery fled to France. Returning to England in 1643, he resumed his personal attendance on the queen, and after being raised to the peerage as Baron Jermyn of St Edmundsbury in that year, he accompanied Henrietta Maria in 1644 to

France, where he continued to act as her secretary. In the same year he was made governor of Jersey, whence he conducted the prince of Wales to Paris. He conceived the idea of ceding the Channel Islands to France as the price of French aid to Charles against the parliament; and in other respects also he meddled with foreign politics, his great influence with the queen being a continual embarrassment to royalist statesmen, especially after the execution of Charles I. When Charles II. went to Breda, Jermyn remained in Paris with Henrietta Maria, who persuaded her son to create him earl of St Albans in 1660. Gossip which the historian Hallam accepted as authentic, but which is supported by no real evidence, asserted that Jermyn was secretly married to the widow of Charles I. At the Restoration St Albans became lord chamberlain, and received other appointments. He supported the policy of friendship with France, and he contributed largely to the close secret understanding between Charles II. and Louis XIV., being instrumental in arranging the preliminaries of the treaty of Dover in 1669. In 1664 he obtained a grant of land in London near St James's Palace, where Jermyn Street preserves the memory of his name, and where he built the St Albans' market on a site afterwards cleared for the construction of Regent Street and Waterloo Place. The earl, who was a friend and patron of Abraham Cowley, died in St James's Square, for the building of which he had provided the plan in January 1684. St Albans being unmarried, the earldom became extinct at his death, while the barony of Jermyn of St Edmundsbury passed by special remainder, together with his property, to his nephew Thomas Jermyn, and after the latter's death to Thomas's brother Henry Baron Dover (q.v.).

ST ALBANS, a city, municipal borough, and market town in the St Albans parliamentary division of Hertfordshire, England, on the main line of the Midland railway and on branches of the London & North-Western and the Great Northern lines, 20 m. N.W. of London. Pop. (1891) 12,898; (1901) 16,019. St Albans became the seat of a bishop in 1877; the diocese covering the greater part of Essex and Hertfordshire, with small portions of Cambridgeshire, Bedfordshire and Buckinghamshire. The great cathedral, or abbey church, is finely situated on the steep hill, above the small river Ver, on which the central part of the city is placed.

Shortly after the martyrdom of St Alban, probably in 303, a church was built on the spot where he was slain, and in 793 Offa, king of Mercia, who professed to have discovered the relics of the martyr, founded in his honour a monastery for Benedictines, which became one of the richest and most important houses of that order in the kingdom. The abbots, Ealdred and Ealmer, at the close of the 10th century began to break up the ruins of the old Roman city of Verulamium for materials to construct a new abbey church; but its erection was delayed till the time of William the Conqueror, when Paul of Caen, a relative of Archbishop Lanfranc, was in 1077 appointed abbot. The cathedral at Canterbury as built by Lanfranc was almost a reproduction of St Stephen's, Caen; but Paul, while adopting the same model for St Albans, built it on a much larger scale. The church was consecrated in 1115, but had been finished some years before. Of the original Norman church the principal portions now remaining are the eastern bays of the nave, the tower and the transepts, but the main outlines of the building are still those planned by Paul. It is thus one of the most important specimens of Norman architecture in England, with the special characteristic that, owing to the use of the flat broad Roman tile, the Norman portions are peculiarly bare and stern. The western towers were pulled down in the 13th century. About 1185 Robert de Gorham repaired and beautified the early shrine and rebuilt the chapter-house and part of the cloister; but nothing of his work now remains except part of a very beautiful doorway discovered in recent times. About 1200 Abbot John de Cella pulled down the west front and portions of the north and south aisles. He began the erection of the west front in a new and enriched form, and his work was continued by his successor William de Trumpington in a plainer manner. In 1257 the eastern portion was pulled down, and between the middle of the 13th and the beginning of the 14th century a sanctuary, ante-chapel and lady chapel were added, all remarkably fine specimens of the architecture of the period. In 1323 two great columns on the south side suddenly fell, and this necessitated the rebuilding of five bays of the south aisle and the Norman cloisters. Various incongruous additions were made during the Perpendicular period, and much damage was also done during the dissolution of the abbey to the finer work in the interior. Structural dangers gave rise to an extensive restoration and partial rebuilding, begun under the direction of Sir Gilbert Scott, and completed in 1894 by Lord

Grimthorpe, some of whose work was, and remains, the subject of much adverse criticism. The abbey's extreme length outside is 550 ft., which is exceeded by Winchester by 6 ft. The nave (202 ft.) is the longest Gothic nave in the world and exceeds that of Winchester by about 20 ft. The length of the transepts is 175 ft. inside. The monastic buildings have all disappeared except the great gateway.

St Michael's church, within the site of Verulamium, was originally constructed in the 10th century. Considerable portions of the Norman building remain. The church contains the tomb of Lord Chancellor Bacon. St Stephen's church, dating from the same period, contains some good examples of Norman architecture. St Peter's church has been in great part rebuilt, but the Early Perpendicular nave remains. The restored clock-house in the market-place was built by one of the abbots in the reign of Henry VIII. There is an Edward VI. grammar school. The principal modern buildings are the corn exchange, the court-house, the prison, the public baths, a technical school and the public library. There are two hospitals (one for infectious diseases), a dispensary and almshouses founded in 1734 by Sarah, duchess of Marlborough. The principal industries are the manufacture of silk, straw-plaiting, brush-making, letterpress and chromo-lithographic printing. There are also breweries and iron-foundries. A public park of 24 acres was opened in 1894, and a recreation ground in 1898. The increase in population is largely due to the growth of a residential district on the outskirts, owing mainly to the convenient proximity to London. The city is governed by a mayor, 4 aldermen and 12 councillors. Area, 997 acres.

To the south-west of the present city of St Albans stood the ancient Verulamium (q.v.), one of the oldest towns in Britain, on Watling Street. The ruins served as a quarry not only to the builders of the Abbey, but also for the other churches and the monastic buildings of St Albans, and Roman bricks are found even in the fabric of the churches of neighbouring villages, as at Sandridge, 2½ m. N.E. After being burnt by Boadicea, Verulamium revived, and its church was famous early in the 8th century. The origin of the royal castle of Kingsbury is variously assigned to the 6th and 8th centuries. In the 9th and 10th centuries the abbots enlarged the town, which was confirmed to them as a borough by Henry II. In 1253 a charter gave borough jurisdiction to the good men of St Albans; but the borough court was, apparently, discontinued for about 200 years after the rebellion of 1381. A charter of 1533, confirmed in 1553 and 1559-1560, incorporated the mayor and burgesses. Charters of 1663, 1664 and 1685, and the Municipal Corporations Act of 1835, altered the form of the corporation; and in 1877 St Albans became a city. Two burgesses were returned to the parliament of 1306-1307, and to others, until, after 1336, such right fell into abeyance until its resumption in 1553. Its abolition, as a result of corrupt electioneering practices, took place in 1852.

During Wat Tyler's insurrection the monastery was besieged by the townspeople, many of whom were executed in consequence. At St Albans the Lancastrians were defeated on the 21st of May 1455, their leader, the duke of Somerset, being killed, and Henry VI. taken prisoner; here, too, Queen Margaret defeated the earl of Warwick on the 17th of February 1461. During the civil wars the town was garrisoned for the parliament. On a printing press, one of the earliest in the kingdom, set up in the abbey the first English translation of the Bible was printed.

See *Victoria County History, Herts.*, vol. ii.; Peter Newcome, *The History of the Abbey of St Albans* (London, 1793); and *Chronica monasterii S. Albani*, edited by H. T. Riley for the "Rolls" series (1865-1876).

SAINT ALBANS, a city and the county-seat of Franklin county, Vermont, U.S.A., 57 m. (by rail) N.N.W. of Montpelier. Pop. (1900) 6239, including 1201 foreign-born; (1910) 6381. St Albans is served by the Central Vermont railway, which has general offices and shops here, and by an electric line connecting with Lake Champlain at St Albans Bay and with Swanton, 9 m. N. The city is built on a plain less than 3 m. from Lake Champlain and about 300 ft. above it; surrounding hills (Aldis and Bellevue) rise still higher and command charming views of the Green Mountains, Lake Champlain and the Adirondacks. Among the prominent buildings are a U.S. customs-house, the city hall, the court house, a public library, a hospital (1882), the Warner Home for Little Wanderers (1882), two Roman Catholic parochial schools and two convents. There are marble quarries in the vicinity, but the surrounding country is devoted largely to dairying. St Albans has a large creamery, manufactures condensed milk and ships large quantities of butter.

The first permanent settlement here was established in 1786; the township of St Albans (pop. in 1900, 1715) was incorporated in 1859, and the larger part of it was chartered as the city of St Albans in 1897. On the 19th of October 1864 Lieut. Bennett H. Young led from Canada about twenty-five un-uniformed Confederate soldiers in a raid on St Albans. They looted three banks, wounded several citizens, one mortally, and escaped to Canada, where Young and twelve others were arrested and brought to trial. But they were never punished, and even the \$75,000 which had been taken from them on their arrest was returned to them. Later, however, the Canadian government refunded this amount to the banks. In 1866 and again in 1870 the Fenians made St Albans a base for attacks on Canada, and United States troops were sent here to preserve neutrality.

SAINT ALBIN, ALEXANDER CHARLES OMER ROUSSELIN DE CORBEAU, COMTE DE (1773-1847), French politician, was born in Paris, of a noble Dauphinois family, and was educated at the Collège d'Harcourt. He embraced the revolutionary ideas with enthusiasm. As civil commissioner at Troyes he was accused of terrorism by some, and by the revolutionary tribunal of moderation. He was imprisoned for a short time in 1794. On his release the Citizen Roussein entered the ministry of the interior, and under the Directory he became secretary-general, and then civil commissioner of the Seine. Attached to the party of Bernadotte, he was looked on with suspicion by the imperial police, and during the later years of the empire spent his time in retirement at Provence. During the Hundred Days, however, he served under Carnot at the ministry of the interior. Under the Restoration he defended Liberal principles in the *Constitutionnel*, of which he was the founder. Although Louis Philippe had been his friend since the days of the Revolution, he accepted no office from the monarchy of July. He retired from the *Constitutionnel* in 1838, and died on the 15th of June 1847. His chief works deal with the soldiers of the Revolution. They are: *Vie de Lazare Hoche* (2 vols., 1798); *Notice historique sur le général Marbot* (1800); *M. de Championnet* (1860); and notices of others posthumously published by his son, Hortensius de Saint Albin, as *Documents relatifs à la Révolution Française* . . . (1873).

ST ALDEGONDE, PHILIPS VAN MARNIX, HEER VAN (1538-1598), Dutch writer and statesman, was born at Brussels, the son of Jacob van Marnix, baron of Pottes. He studied theology under Calvin and Beza at Geneva and, returning to the Netherlands in 1560, threw himself energetically into the cause of the Reformation, taking an active part in the compromise of the nobles in 1565 and the assembly of St Trond. He made himself conspicuous by issuing a pamphlet in justification of the iconoclasts who devastated Flanders in 1566, and on Alva's arrival next year had to fly the country. After spending some time in Friesland and in the Palatinate he was in 1570 taken into the service of William, prince of Orange, and in 1572 was sent as his representative to the first meeting of the States-general assembled at Dordrecht. In 1573 he was taken prisoner by the Spaniards at Maaslandsdijks, but was exchanged in the following year. He was sent as the representative of the insurgent provinces to Paris and London, where he in vain attempted to secure the effective assistance of Queen Elizabeth. In 1578 he was at the diet of Worms, where he made an eloquent but fruitless appeal for aid to the German princes. Equally vain were his efforts in the same year to persuade the magistrates of Ghent to cease persecuting the Catholics in the city. He took a conspicuous part in arranging the Union of Utrecht, and in 1583 was chosen burgmaster of Antwerp. In 1585 he surrendered the city, after a 13 months' siege, to the Spaniards. Violently attacked by the English and by his own countrymen for this act, he retired from public affairs and, save for a mission to Paris in 1590, lived henceforth in Leiden or on his estate in Zeeland, where he worked at a translation of the Bible. He died at Leiden on the 15th of December 1598.

St Aldegonde, or Marnix (by which name he is very commonly known), is celebrated for his share in the great development of Dutch literature which followed the classical period represented by such writers as the poet and historian Pieter Hooft. Of his works the best known is the *Roman Bee-hive* (*De rotsche byen-korf*), published in 1569 during his exile in Friesland, a bitter satire on the faith and

practices of the Roman Catholic Church. This was translated or adapted in French, German and English. As a poet, St Aldegonde is mainly known through his admirable metrical translation of the Psalms (1580), and the celebrated *Wilhelmus van Nassauwe*, one of the two officially recognized national anthems of Holland, is also ascribed to him. His complete works, edited by Lacroix and Quinet, were published at Brussels in 7 vols. (1855-1859), and his religious and theological writings, edited by Van Turenneberg, at Paris, in 3 vols. (1871-1891).

See E. Quinet, *Marnix de St Aldegonde* (Paris, 1854); Juste, *Vie de Marnix* (The Hague, 1858); Frédéric, *Marnix en zijne nederlandsche geschriften* (Ghent, 1882); Tjalm, *Philips van Marnix, heer van Sint-Aldegond* (Amsterdam, 1896).

ST ALDWYN, MICHAEL EDWARD HICKS BEACH, 1ST VISCOUNT (1837-), English statesman, son of Sir Michael Hicks Beach, 8th Bart., whom he succeeded in 1854, was born in London in 1837, and was educated at Eton and Christ Church, Oxford, where he graduated with a first class in the school of law and modern history. In 1864 he was returned to parliament as a Conservative for East Gloucestershire, the county in which his estates of Williamstrip Park were situated; and during 1868 he acted both as parliamentary secretary to the Poor Law Board and as under-secretary for the Home Department. In 1874 he was made chief secretary for Ireland, and was included in the Cabinet in 1877. From 1878 to 1880 he was secretary of state for the colonies. In 1885 he was elected for West Bristol, and the Conservative party having returned to power, became chancellor of the exchequer and leader of the House of Commons. After Mr Gladstone's brief Home Rule Ministry in 1886 he entered Lord Salisbury's next Cabinet again as Irish secretary, making way for Lord Randolph Churchill as leader of the House; but troubles with his eyesight compelled him to resign in 1887; and meanwhile Mr Goschen replaced Lord Randolph as chancellor of the exchequer. From 1888 to 1892 Sir Michael Hicks Beach returned to active work as president of the Board of Trade, and in 1895—Mr Goschen being transferred to the Admiralty—he again became chancellor of the exchequer. In 1899 he lowered the fixed charge for the National Debt from twenty-five to twenty-three millions—a reduction imperatively required, apart from other reasons, by the difficulties found in redeeming Consols at their then inflated price. When compelled to find means for financing the war in South Africa, he insisted on combining the raising of loans with the imposition of fresh taxation; and besides raising the income-tax each year, up to 1s. 3d. in 1902, he introduced taxes on sugar and exported coal (1901), and in 1902 proposed the reimposition of the registration duty on corn and flour which had been abolished in 1869 by Mr Lowe. The sale of his Netheravon estates in Wiltshire to the War Office in 1898 occasioned some acrid criticism concerning the valuation, for which, however, Sir Michael himself was not responsible. On Lord Salisbury's retirement in 1902 Sir Michael Hicks Beach also left the government. He accepted the chairmanship of the Royal Commission on Ritualistic Practices in the Church, and he did valuable work as an arbitrator; and though when the fiscal controversy arose he became a member of the Free-food League, his parliamentary loyalty to Mr Balfour did much to prevent the Unionist free-traders from precipitating a rupture. When Mr Balfour resigned in 1905 he was raised to the peerage as Viscount St Aldwyn.

ST AMAND-LES-EAUX, a town of northern France, in the department of Nord, at the junction of the Elnon with the Scarpe, 22 m. S.E. of Lille by rail. Pop. (1906), town, 10,105; commune, 14,454. The town has a communal college and a school of drawing, and carries on iron-founding and the manufacture of porcelain, hosiery, chains and nails, but is better known for its mineral waters and mud baths. There are five springs; the water (69° to 77° F.) contains sulphate of lime and sulphur, and deposits white gelatinous threads without smell or taste. The mud baths are of benefit to patients suffering from rheumatism, gout and certain affections of liver and skin. Though from the discovery of statues and coins in the mud it is evident that these must have been frequented during the Roman period, it was only at the close of the 17th century that they again became of more than local celebrity. Of the abbey there remain

an entrance pavilion serving as town hall and the richly decorated façade of the church, both dating from the 17th century.

St Amand owes its name to St Amand, bishop of Tongres, who founded a monastery here in the 7th century. The abbey was laid waste by the Normans in 882 and by the count of Hainaut in 1340. The town was captured by Mary of Burgundy in 1477, by the count of Ligne, Charles V.'s lieutenant, in 1521, and finally in 1667 by the French. In 1793 St Amand was the headquarters of General Dumouriez in revolt against the Republican government.

ST-AMAND-MONT-ROND, a town of central France, capital of an arrondissement in the department of Cher, 39 m. S. by E. of Bourges on the railway to Montluçon. Pop. (1906), 7711. The town stands at the foot of the hill of Mont-Rond on the right bank of the Cher, at its confluence with the Marmande and on the canal of Berry. A church of the period of transition from the Romanesque to Gothic style and several old houses are the more interesting buildings. The beautiful château of Meillant, built from 1500 to 1510 by the admiral Charles of Amboise, is 5½ m. from St Amand; and the abbey of Noirlac, a fine type of Cistercian abbey with a 12th-century church, is 2½ m. from the town.

The town grew up round a monastery founded by St Amand, a follower of St Columban, in the 7th century. Its ruined stronghold, on the hill of Mont-Rond, was of importance in the middle ages, and during the Fronde, when it belonged to the great Condé, was a centre of resistance to the royal troops, by whom it was taken after a siege of eleven months in 1652. It was for a time the property of Sully, who retired to it under the regency of Marie de' Medici.

SAINT-AMANT, MARC ANTOINE DE GÉRARD, SEUR DE (1594-1661), French poet, was born near Rouen in the year 1594. His father was a merchant who had, according to his son's account, been a sailor and had commanded for 22 years *une escadre de la reine Elizabeth*—a vague statement that lacks confirmation. The son obtained a patent of nobility, and attached himself to different great noblemen—the duc de Retz and the comte d'Harcourt among others. He saw military service and sojourned at different times in Italy, in England—a sojourn which provoked from him a violent poetical attack on the country, *Albion* (1643)—in Poland, where he held a court appointment for two years, and elsewhere. Saint-Amant's later years were spent in France; and he died at Paris on the 29th of December 1661.

Saint-Amant has left a not inconsiderable body of poetry. His *Albion* and *Rome ridicule* set the fashion of the burlesque poem, a form in which he was excelled by his follower Paul Scarron. In his later years he devoted himself to serious subjects and produced an epic, *Moïse sauvé* (1653). His best work consists of Bacchalian songs, his *Débâche* being one of the most remarkable convivial poems of his kind.

The standard edition is that in the *Bibliothèque Elzévirienne*, by M. C. L. Livet (2 vols. Paris, 1855).

SAINT ANDRÉ, ANDRÉ JEANBON (1749-1813), French revolutionist, was born at Montauban (Tarn-et-Garonne) on the 25th of February 1749, the son of a feller. Although his father was a Protestant, St André was brought up by the Jesuits at Marseilles and took orders. He turned Protestant, however, and became pastor at Castras and afterwards at Montauban. The proclamation of liberty of worship made him a supporter of the Revolution, and he was sent as deputy to the Convention by the department of Lot. He sat on the Mountain, voted for the death of Louis XVI. and opposed the punishment of the authors of the September massacres. In July 1793 he was president of the Convention, entered the Committee of Public Safety the same month and was sent on mission to the Armies of the East. On the 20th of September 1793 he obtained a vote of one hundred million francs for constructing vessels, and from September 1793 to January 1794 reorganized the military harbours of Brest and Cherbourg. In May 1794 he took part with Admiral Villaret de Joyeuse in a fight with the English. Finally, after a mission in the south, which lasted from July 1794 to March 1795 and in which he showed great moderation, he was arrested on the 28th of May 1795, but was released by the amnesty of the year IV. He was then appointed consul at Algiers and Smyrna (1798), was kept prisoner by the Turks for three years, and subsequently became prefect of the department of Mont-Tonnerre (1801) and commissary-general of the three

departments on the left bank of the Rhine. He died at Mainz on the 10th of December 1813.

See *LeVintenniel Jeanbon St André* (Paris, 1901).

SAINT ANDRÉ, JACQUES D'ALBON, SEIGNEUR DE (c. 1505-1562), French soldier and favourite of Henry II. of France. He was made marshal of France, governor of Lyons and ambassador in England. He served with great bravery against the emperor Charles V. in 1552. In 1557 he was taken prisoner at the battle of Saint Quentin, but was released the following year, and took part in negotiating the peace of Cateau-Cambrésis. After the death of Francis II. he formed in 1561 with the constable de Montmorency and Francis, duke of Guise, an alliance known as "the triumvirate" against the Protestants and the queen-mother. He perished at the battle of Dreux by the hand of a private enemy.

ST ANDREWS, a city, royal burgh, university town and seaport of Fife-shire, Scotland. Pop. (1901), 7621. It is situated on a bay of the North Sea, 12½ m. S.E. of Dundee by the North British railway, via Leuchars junction. It occupies a plateau of sandstone rock about 50 ft. high, on the north breaking off in precipitous cliffs in which the sea has worn numerous caves. The Eden enters St Andrews Bay to the north-west of the Links; and Kinness Burn, skirting the south side of the town, flows into the harbour. Almost the whole activity of St Andrews is centred in education and golf. There are a few small businesses, however, such as brewing, tanning, shipping and fishing. The harbour, which is somewhat difficult of access, is protected by a pier 630 ft. long. The city has been called the "Mecca of Golf," partly because the Royal and Ancient Golf Club, founded in 1754, is the legislative authority of the game, and partly because its beautiful links—acquired by the town in 1894 and containing three courses—rank amongst the finest in the world. For the sake of the game, the bracing air and the bathing which the sandy beach of its bay affords, visitors are attracted to St Andrews in great numbers. The chief modern buildings include the town hall, the Templars' Hall, the Volunteer Hall, the Gibson Hospital, the Memorial Cottage Hospital, the Marine Biological Station (erected by Dr C. H. Gatty and opened in 1896), the Library and the Golf Club House, erected in 1853. The city was never surrounded by walls, and of its ancient gates the West Port only remains. The Martyrs' Memorial, erected to the honour of Patrick Hamilton, George Wishart, and other martyrs of the Reformation epoch, stands at the west end of the Scores on a cliff overlooking the sea.

The cathedral originated partly in the priory of Canons Regular founded by Bishop Robert (1122-1159). At the end of the 17th century some of the priory buildings were still entire and considerable remains of others existed, but nearly all traces have now disappeared except portions of the priory wall and the archways, known as the Pends. The wall is about three-quarters of a mile long, and bears turrets at intervals. The 3rd marquis of Bute undertook the restoration of the priory, but the work was interrupted by his death in 1900. The cathedral was founded by Bishop Arnold (1150-1162), to supply more ample accommodation than was afforded by the church of St Regulus. Of this church in the Romanesque style, probably dating from the 10th century, there remain the square tower, 108 ft. in height, and the choir, of very diminutive proportions. On a plan of the town, about 1530, a chancel appears, and on seals affixed to the city and college charters there are representations of other buildings attached. The cathedral was constructed in the form of a Latin cross, the total length inside the walls being 355 ft., the length of the nave 200 ft., of the choir and lateral aisles 62 ft., and of the lady chapel at the eastern extremity 50 ft. The width at the transepts was 166 ft. and of the nave and choir 62 ft. The building was finished in the time of Bishop Lambertson (1297-1328), and was dedicated on the 5th of July 1318, the ceremony being witnessed by Robert Bruce. When entire it had, besides a central tower, six turrets, of which two at the east and one of the two at the west extremity, rising to a height of 100 ft., remain. The building was partly destroyed by fire in 1378, and the restoration and further embellishment were completed in 1440. It was stripped of its altars and images in 1550. It is believed that about the end of the 16th century the central tower gave way, carrying with it the north wall. Afterwards large portions of the ruins were taken away for building purposes, and nothing was done to preserve them until 1826. Since then it has been tended with scrupulous care, an interesting feature being the cutting out of the ground-plan in the turf. The principal portions extant, partly Norman and partly Early English, are the

east and west gables, the greater part of the south wall of the nave and the west wall of the south transept.

The picturesque ruins of the castle are situated on a rocky promontory much worn away by the sea. It is supposed to have been erected by Bishop Roger about the beginning of the 13th century as an episcopal residence, and was strongly fortified. It was frequently taken by the English, and after it had been captured by the Scottish regent, Andrew Murray, in 1336-1337, was destroyed lest it should fall into their hands. In 1336-1337, was destroyed lest it was rebuilt by Bishop Trail in the form of a massive fortification with a moat on the south and west sides. James I. spent some of his early years within it under the care of Bishop Wardlaw, and it was the birthplace of James III. (1445). From a window in the castle Cardinal Beaton witnessed the burning of George Wishart in front of the gate (1546), and in the same year he was murdered within it by a party of Reformers. The castle was taken from the conspirators by the French, among the prisoners captured being John Knox. Some years afterwards it was repaired by Archbishop Hamilton, but in less massive and less substantial form. By 1656, however, it had fallen into such disrepair that the town council ordered the materials to be used for repairing the pier. The principal remains are a portion of the south wall enclosing a square tower, the "bottle dungeon"—so named from its shape: it was a cell hewn out of the solid rock—below the north-west tower, the kitchen tower and a curious subterranean passage. The grounds have been laid out as a public garden.

The town church, formerly the church of the Holy Trinity, was originally founded in 1112 by Bishop Turgot. The early building was a beautiful Norman structure, but at the close of the 18th century it should have fallen into such disrepair that the town council ordered the materials to be used for repairing the pier. The principal remains are a portion of the south wall enclosing a square tower, the "bottle dungeon"—so named from its shape: it was a cell hewn out of the solid rock—below the north-west tower, the kitchen tower and a curious subterranean passage. The grounds have been laid out as a public garden.

The town church, formerly the church of the Holy Trinity, was originally founded in 1112 by Bishop Turgot. The early building was a beautiful Norman structure, but at the close of the 18th century it should have fallen into such disrepair that the town council ordered the materials to be used for repairing the pier. The principal remains are a portion of the south wall enclosing a square tower, the "bottle dungeon"—so named from its shape: it was a cell hewn out of the solid rock—below the north-west tower, the kitchen tower and a curious subterranean passage. The grounds have been laid out as a public garden.

The great university of St Andrews owed its origin to a society formed in 1410 by Lawrence of Lindores, abbot of Scone, Richard Cornwall, archdeacon of Lothian, William Stephen, afterwards archbishop of Dunblane, and a few others. A charter was issued in 1411 by Bishop Henry Wardlaw (d. 1440), who attracted the most learned men in Scotland as professors, and six bulls were obtained from Benedict XIII. in 1413 confirming the charter and constituting the society a university. The lectures were delivered in various parts of the town until 1430, when Wardlaw allowed the lecturers the use of a building called the Paedagogium, or St John's. St Salvador's College was founded and richly endowed by Bishop Kennedy in 1456; seven years later it was granted the power to confer degrees in theology and philosophy, and by the end of the century was regarded as a constituent part of the university. In 1512 St Leonard's College was founded by Prior John Hepburn and Archbishop Alexander Stewart on the site of the buildings which at one time were used as a hospital for pilgrims. In the same year Archbishop Stewart nominally changed the original Paedagogium into a college and annexed to it the parish church of St Michael of Tarvet; but its actual erection into a college did not take place until 1537, when it was dedicated to the Blessed Virgin Mary of the Assumption. The outline of the ancient structure is preserved, but its general character has been much altered by various restorations. It forms two sides of a quadrangle, the library and principal's residence being on the north and the lecture rooms and the old dining-hall on the west. The University library, which now includes the older college libraries, was founded about the middle of the 17th century, rebuilt in 1764, and improved in 1829 and 1880-1890. The lower hall in the older part of the building was used at times as a provincial meeting-place for the Scottish parliament. When the constitution of the colleges was remodelled in 1579 St Mary's was set apart for theology; and in 1747 the colleges of St Salvador and St Leonard were formed into the United College. The buildings of St Leonard's are now occupied as a school for girls. The college chapel is in ruins. The United College occupies the site of St Salvador's College, but the old buildings have been removed, with the exception of the college chapel,

now used as the university chapel and the parish church of St Leonard's, a fine Gothic structure, containing an elaborate tomb of Bishop Kennedy and Knox's pulpit; the entrance gateway, with a square clock tower (152 ft.); and the janitor's house with some class-rooms above. The modern building, in the Elizabethan style, was erected between 1827 and 1847. University College, Dundee, was in 1890 affiliated to the university of St Andrews. This arrangement was set aside by the House of Lords in 1895, but a re-affiliation took place in 1897. In 1887-1888 a common dining-hall for the students was established; in 1892 provision was made within the university for the instruction of women; and for the board and residence of women students a permanent building was opened in 1896. To the south of the library medical buildings, erected by the munificence of the 3rd marquess of Bute, were opened in 1890. It was during the principalship of Dr James Donaldson, who succeeded John Tulloch (1823-1886), that most of the modern improvements were introduced.

Madras College, founded and endowed by Dr Andrew Bell (1755-1832), a native of the city, is a famous higher-class school.

The town, which is governed by a council, provost and bailies, gives its name to the district group of burghs for returning one member to parliament, the other constituents being the two Anstruthers, Craik, Cupar, Kilrenny and Pittenweem.

Four miles N.W. is Leuchars (pop. 711), the church of which, dating from 1100, contains some beautiful Norman work in the chancel and apse, the nave being modern. It was in this church that Alexander Henderson (1583-1646) heard the sermon that led him to give up Episcopacy. At Guard Bridge (pop. 715), so named from the six-arched bridge erected by Bishop Wardlaw at the mouth of the Eden, are a large paper-mill and brickworks. Mt Melville, to the S.W. of the city, was the residence of the novelist G. J. Whyte-Melville (1821-1878), and Kinalmildie, to the S., was the birthplace of Sir Robert Ayton the poet (1570-1638). On the shore, to the S.E., stands the huge detached rock which, from its shape, bears the name of the Spindle rock.

History.—St Andrews was probably the site of a Pictish stronghold, and tradition declares that Kenneth, the patron saint of Kennoway, established a Culdee monastery here in the 6th century. The foundations of the little church dedicated to the Virgin were discovered on the Kirkheugh in 1860. Another Culdee church of St Mary on the Rock is supposed to have stood on the Lady's Craig, now covered by the sea. At that period the name of the place was Kilrymont (Gaelic, "The church of the King's Mount") or Muckross. Another legend tells how St Regulus or Rule, the bishop of Patras in Achaia, was guided hither bearing the relics of Saint Andrew. The Pictish king Angus gave him a tract of land called the Boar Chase, no doubt the Boar hills of the present day, and the name of the spot was changed to St Andrews, the saint soon afterwards (747) becoming the patron-saint of Scotland (but see ANDREW, Sr). St Andrews is said to have been made a bishopric in the 9th century, and when the Pictish and Scottish churches were united in 908, the primacy was transferred to it from Dunkeld, its bishops being thereafter known as bishops of Alban. It became an archbishopric during the primacy of Patrick Graham (1466-1478). The town was created a royal burgh in 1124. In the 16th century St Andrews was one of the most important ports north of the Forth and is said to have numbered 14,000 inhabitants, but it fell into decay after the Civil War. Defoe says that when he saw it one-sixth of its houses were ruinous and the sea had so encroached on the harbour that it was never likely to be restored; but the slight improvement in trade and public spirit which Bishop Pococke seemed to detect in 1760 continued throughout the 19th century.

AUTHORITIES.—S. W. Martine, *History and Antiquities of St Rule's Chapel, St Andrews* (1782); Grierson, *Deeds relating to St Andrews* (1807); 3rd ed. 1808; *Reliquiae Divi Andree* (1797); *Liber Cartarum Sancti Andree* (Bannatyne Club, 1841); W. F. Skene, "Ecclesiastical Settlements in Scotland," in *Proc. Soc. Antiq. Scot.* (1862-1863); C. J. Lyon, *History of St Andrews* (1843); A. M'Lachlan, *St Andrews: its Historical Associations and Public Buildings* (Edinburgh, 1885); D. Hay Fleming, *The Martyrs and Confessors of St Andrews* (Cupar, 1887); *Register of the Christian Congregation of St Andrews, 1559-1600* (Edinburgh, Scottish History Society, 1880-1890); *Guide to St Andrews*; Andrew Lang, *St Andrews* (London, 1893); D. R. Kerr, *St Andrews in 1645-1646* (London, 1895); James Maitland Anderson,

The University of St Andrews: an Historical Sketch (1878); *Annual Register of St Andrews University*.

SAINT ARNAUD, JACQUES LEROY DE (1801–1854), marshal of France, was born at Paris on the 20th of August 1801. He entered the army in 1817, and after ten years of garrison service, which he varied by gambling and wild courses, he still held only the lowest commissioned grade. He then resigned, led a life of adventure in several lands and returned to the army at thirty as a sub-lieutenant. He took part in the suppression of the Vendée émeute, and was for a time on General (Marshal) Bugeaud's staff. But his debts and the scandals of his private life compelled him to go to Algeria as a captain in the Foreign Legion. There he distinguished himself on numerous occasions, and after twelve years had risen to the rank of *maréchal de camp*. In 1848 he was placed at the head of a brigade during the revolution in Paris. On his return to Africa, it is said because Louis Napoleon considered him suitable to be the military head of a *coup d'état*, an expedition was made into Little Kabylia, in which St Arnaud showed his prowess as a commander-in-chief and provided his superiors with the pretext for bringing him home as a general of division (July 1851). He succeeded Marshal Magnan as minister of war and superintended the military operations of the *coup d'état* of the 2nd of December (1851) which placed Napoleon III. on the throne. A year later he was made marshal of France and a senator, remaining at the head of the war office till 1854, when he set out to command the French in the Crimea, his British colleague being Lord Raglan. He died on board ship on the 20th of September 1854 shortly after commanding at the battle of the Alma. His body was conveyed to France and buried in the Invalides.

See *Lectures du Maréchal de Saint Arnaud* (Paris, 1855; 2nd edition with memoir by Sainte-Beuve, 1858).

ST ARNAUD, a town of Kara-Kara county, Victoria, Australia, 158 m. by rail N.W. of Melbourne. Pop. (1901), 3656. It is a flourishing town with a fine town hall, a school of mines and the court house, in which sittings of the supreme court are held. There are tanneries, chaff and wood yards, and flour- and bone-mills in the town, which lies in a gold-mining, pastoral and agricultural district, the mining being chiefly quartz. To the N.W. is some of the finest agricultural land in the colony.

ST ASAPH, a cathedral city and a contributory parliamentary borough of Flintshire, N. Wales, on the Rhyl-Denbigh branch of the London & North-Western railway, about 6 m. from each of these towns. Pop. (1901), 1788. Its Welsh name, Llanelwy, is derived from the Elwy, between which stream and the Clwyd it stands. Asaph, to whom the cathedral (one of the smallest in Great Britain) is dedicated, was bishop here after Kentigern's return hence to Glasgow, and died in 596. The small, irregularly built town has also a parish church (Anglican), remains of a Perpendicular chapel near Ffynnon Fair (St Mary's Well), a bishop's house, a grammar school (1882) and almshouses for eight poor widows, founded in 1678 by Bishop Barrow. The hill on which St Asaph stands is Bryn Paulin, supposed to have been the camping-ground of Suetonius Paulinus, on his way to Anglesey. The early cathedral, of wood, was burned by the English in 1247 and 1282, and that built by Bishop Anian in the 13th century (Decorated) was mostly destroyed during the war of Owen Glendower in 1402; Bishop Redman's building (c. 1480) was completed by the erection of the choir about 1770. During the Civil War the Parliamentarians did not spare the building. The choir and chancel were restored, from designs by Sir Gilbert Scott, in 1867–1868, the nave in 1875. The church is plain, cruciform, and in style chiefly Decorated but partly Early English, with a square tower; it has a library of nearly 2000 volumes (some rare); memorials to Bishop Dafydd ab Owain (d. 1502), to Bishop Luxmore (d. 1830), to the poetess Felicia Hemans, a resident near St Asaph (d. 1835); and Perpendicular oak choir stalls. In the neighbourhood is the modern mansion of Bodelwyddan, of which the estate was bought by Sir W. Williams, speaker of the House of Commons in Charles II.'s time.

ST AUGUSTINE, a city and the county-seat of St John's county, Florida, U.S.A., in the N.E. part of the state, about 36 m. S.E. of Jacksonville. Pop. (1900) 4272, including 1735 negroes; (1910) 5494; many of the native whites are descendants of those Minorans who were settled at New Smyrna, Florida, by Andrew Turnbull in 1760, and subsequently removed to St Augustine. St Augustine is served by the Florida East Coast railway and by the Florida East Coast Canal, an inland waterway from the St John's river to the Florida Keys.

The city stands on a narrow, sandy peninsula, about 12 ft. above the sea, formed by the Matanzas and San Sebastian rivers, and is separated from the ocean by the northern end of Anastasia Island. St George, the chief street in St Augustine, is only 17 ft. wide, and Treasury Street is, at its east end, an alley across which two people may clasp hands. There are many old houses, some of which have balconies projecting above the streets. At its northern end is the old fort of San Marco (now renamed Fort Marion in honour of General Francis Marion), a well-preserved specimen of Spanish military architecture, begun, it is supposed, about 1656 and finished in 1756. The St Francis barracks (now the state arsenal) occupy the site of the old Franciscan convent, whose walls still remain at the first storey. In the military cemetery are buried a number of soldiers who were massacred by the Seminoles near the Great Wahoo Swamp on the 28th of August 1835. At the end of St George Street and near Fort Marion is the City Gate (two pillars, each 20 ft. high); from this gate a line of earthworks formerly stretched across the northern end of the peninsula. In the centre of the city is the Plaza de la Constitución, in which are an obelisk erected in 1813 to commemorate the Spanish Liberal Constitution of 1812, and a monument (1872) to citizens who died in the Confederate Army. On this square are the market (built in 1840, partially burned in 1887, and afterwards rebuilt), often erroneously spoken of as "the slave market"; a Roman Catholic cathedral (built in 1791, but not finished in 1887, and enlarged in 1887–1888); Trinity church (Protestant Episcopal); and the post office (once the Spanish government building). In the western part of the city is the beautiful Memorial Presbyterian Church, built in 1889 as a memorial to his daughter, by Henry M. Flagler. Facing King Street (the Alameda) is the magnificent Hotel Ponce de Leon (Spanish Renaissance), of shell-concrete, also by Flagler. The Alcazar (with a large swimming pool fed by a sulphurous artesian well), in the Moorish style, and the Alcazar Annex (with a large sun parlour), formerly the Cordova Hotel, designed and built by Franklin W. Smith, in the Hispano-Moorish style, are also famous hostels. In an old building (restored) is housed the Wilson Free Public Library. Another old building houses the collections of the St Augustine Institute of Science and Historical Society, organized in 1884. St Augustine is the seat of the state school for the deaf and blind (1885).

At St Augustine are car and machine shops of the Florida East Coast railway. Oyster canning and fishing are engaged in to some extent, and cigars are manufactured, but the city is important chiefly as a winter resort, the number of its visitors approximating 25,000 a year. The climate is delightful, the mean temperature for the winter months being about 58° F. and for the entire year about 70° F.

St Augustine is the oldest permanent settlement of Europeans in the United States. It was founded by Spanish colonists under the leadership of Pedro Menendez de Avilés, who sighted land here in 1565, on the 28th of August, St Augustine's day, whence the name. On the 6th of September he landed and began his fortifications. St Augustine's colonial history is almost identical with the history of Florida (q.v.) under Spanish dominion. In 1586 it was burned by Sir Francis Drake, who captured the fort, and in 1605 it was pillaged by Captain John Davis, an English freebooter. It was here frequent conflicts with the English settlements in South Carolina and Georgia, beginning in 1681 with an attack by the Spanish on Port Royal, South Carolina. In 1702 Governor James Moore of South Carolina captured St Augustine, but not the fort; and there were subsequent expeditions under General James Edward Oglethorpe (see GEORGIA). When Florida was ceded to England in 1763, nearly all the Spanish inhabitants of St Augustine went to Cuba. Under English control the city prospered, but when in 1783 Florida was re-ceded to Spain, nearly all the English inhabitants left for the Carolinas, Georgia or the West Indies, and it became merely a military post. In 1821 St Augustine, with the rest of Florida, passed under American control. The Spanish inhabitants remained. On the 7th of January 1861, three days before Florida passed her Ordinance of Secession, the small United States garrison was compelled by a state force to evacuate; but on the 11th of March 1862 the fort was

recaptured without bloodshed by a Federal force, and was held by the Federals until the close of the Civil War.

See George R. Fairbanks, *The History and Antiquities of the City of St Augustine* (New York, 1858); Charles B. Reynolds, *Old St Augustine* (St Augustine, 1885); and D. Y. Thomas, "Report upon the Historic Buildings, Monuments and Local Archives of St Augustine," in vol. i. pp. 333-352 of the *Annual Report* (1905) of the American Historical Association.

ST AUSTELL, a market town in the St Austell parliamentary division of Cornwall, England, 14 m. N.E. of Truro, on the Great Western railway. Pop. of urban district (1901) 3340. It is pleasantly situated on a steep slope 2 m. inland from St Austell bay on the south coast. To the north the high ground culminates at 1034 ft. above the sea in Hensbarrow Downs, so called from a barrow standing at the loftiest point. The church of the Holy Trinity is Perpendicular, with Decorated chancel, richly ornamented in a manner unusual in the county. The town is the centre of a district productive of china clay (kaolin), about 400,000 tons being annually exported by sea to the potteries of Staffordshire and to Lancashire, when it is used in the calciferous works for sizing. The deposits of clay became important about 1763, and Josiah Wedgwood acquired mines in the neighbourhood. Mines were previously worked for tin and copper, and in some cases after being exhausted of ore continued to be worked for clay. The Carclaze mine to the north-east is notably rich; it is a shallow excavation of great superficial extent, which appears to have been worked from very early times. Close to St Austell is a good example of an ancient baptistery, called Menacuddle Well, the little chapel being Early English.

ST BARTHOLOMEW, or **ST BARTHÉLEMY**, an island in the French West Indies. It lies in 17° 55' N. and 63° 60' W., about 130 m. N.W. of Guadeloupe, of which it is a dependency. It is shaped like an irregular crescent, the horns, enclosing the bay of St Jean, pointing to the N.; its surface is hilly, culminating near the centre in a limestone hill 1003 ft. high. It is 8 sq. m. in area, and devoid of forests, and water has often to be imported from the neighbouring island of St Kitts. The surrounding rocks and shallows make the island difficult of access. Despite the lack of water, sugar, cotton, cocoa, manioc and tobacco are grown. The capital, Gustavia, on the S.W. coast, possesses a small but safe harbour. Lorient is the only other town. The inhabitants, mainly of French and negro descent, are English-speaking, and number about 3000. St Bartholomew was occupied by France in 1648 and ceded to Sweden in 1784. In 1877 it was again acquired by France at the cost of £11,000.

ST BARTHOLOMEW, MASSACRE OF, the name given to the massacre of the Huguenots, which began in Paris on St Bartholomew's day, the 24th of August 1572. The initiative for the crime rests with Catherine de' Medici. Irritated and disquieted by the growing influence of Admiral Coligny, who against her wishes was endeavouring to draw Charles IX. into a war with Spain, she resolved at first to have him assassinated. The blow failed, and the admiral was only wounded. The attempt, however, infuriated the Huguenots, who had flocked to Paris for the wedding of Henry of Navarre and Marguerite de Valois. Charles IX. declared that the assassin should receive condign punishment. Catherine then conceived the idea of killing at a blow all the Huguenot leaders, and of definitely ruining the Protestant party. After holding a council with the Catholic leaders, including the duke of Anjou, Henry of Guise, the marshal de Tavannes, the duke of Nevers, and René de Birague, the keeper of the seals, she persuaded the king that the massacre was a measure of public safety, and on the evening of the 23rd of August succeeded in wringing his authorization from him. The king himself arranged the manner of its execution, but it is scarcely probable that he fired upon the Huguenots from a window of the Louvre. The massacre began on Sunday at daybreak, and continued in Paris till the 17th of September. Once let loose, it was impossible to restrain the Catholic populace. From Paris the massacre spread to the provinces till the 3rd of October. The duc de Longueville in Picardy, Chabot-Charny (son of Admiral Chabot) at Dijon, the comte de Matignon (1525-1597) in Normandy, and other provincial governors, refused to authorize the massacres.

François Hotman estimates the number killed in the whole of France at 50,000. There were many illustrious victims, among them being Admiral Coligny, his son-in-law Charles de Téliigny and the logician Peter Ramus. Catherine de' Medici received the congratulations of all the Catholic powers, and Pope Gregory XIII. commanded bonfires to be lighted and a medal to be struck.

See H. Bordier, *La St Barthélemy et la critique moderne* (Paris, 1879); H. Baumgarten, *Vor der Bartholomäusnacht* (Strassburg, 1882); and H. Mariéjol, "La Réforme et la Ligue" (Paris, 1904), in vol. vi. of the *Histoire de France*, by E. Lavisse, which contains a more complete bibliography of the subject.

ST BENOÎT-SUR-LOIRE, a village of north-central France, in the department of Loiret, on the right bank of the Loire, 22 m. E.S.E. of Orléans by road. St Benoît (lat. *Floriacum*) possesses a huge basilica, the only survival of a famous monastery founded in the 7th century to which the relics of St Benedict were brought from Monte Cassino. Of great importance during the middle ages, owing partly to its school, the establishment began to decline in the 16th century. In 1562 it was pillaged by the Protestants and after the buildings were restored by Richelieu, the abbey did not recover its former position. The basilica was built between c. 1025 and 1218. Its narthex has a second storey supported on columns with remarkable carved capitals; there are two sets of transepts, above which rises a square central tower. In the interior are the tomb of Philip I., stalls of the 15th century, and, in the crypt, a modern shrine containing the remains of St Benedict, which still attract many pilgrims.

ST BERNARD PASSES, two of the best-known passes across the main chain of the Alps, both traversed by carriage roads. The Great St Bernard (8111 ft.) leads (53 m.) from Martigny (anc. *Octodurus*) in the Rhone valley (Switzerland) to Aosta (anc. *Augusta Praetoria*) in Italy. It was known in Roman times. The hospice on the pass was founded (or perhaps re-founded) by St Bernard of Menthon (d. about 1081), and since the 12th or early 13th century has been in charge of a community of Austin canons, the mother-house being at Martigny. Annually the servants of the canons, and the famous dogs, save many lives, especially of Italian workmen crossing the pass. In May 1800 Napoleon led his army over the pass, which was then traversed by a bridle road only. The Little St Bernard (7179 ft.) also was known in Roman times, and the hospice refounded by St Bernard of Menthon, though it is now in charge of the military and religious order of SS. Maurice and Lazarus. The pass leads (39 m.) from Bourg St Maurice in the Isère valley (French department of Savoie) to Aosta, but is much less frequented by travellers than its neighbour opposite. (W. A. B. C.)

There is no certain mention of the road over the pass of the Great St Bernard (*Alpis Poenina*, *Poeninus Mons*) before 57 B.C. when Julius Caesar sent Servius Galba over it, "because he wished that the pass, by which traders had been accustomed to go at great risk and with very high transport charges, should be opened." But even in Strabo's time it was impassable for wheeled traffic; and we find that *Augusta Praetoria* originally had but two gates, one opening on the road towards the Little St Bernard (*Alpis Graia*), the other towards *Eporodia* (Ivrea), but none towards the *Alpis Poenina*. But the military arrangement of the German provinces rendered the construction of the road necessary, and it is mentioned as existing in A.D. 66. Remains of it cut in the rock, some 12½ ft. in width, still exist near the lake at the top of the pass. On the plain at the top of the pass is the temple of Jupiter *Poeninus* (Peninus), remains of which were excavated in 1890-1893, though objects connected with it had long ago been found. The oldest of the votive-tablets which can be dated belongs to the time of Tiberius, and the temple may be attributed to the beginning of the empire; objects, however, of the first Iron age (4th or 5th century B.C.) were also found and many Gaulish coins. Other buildings, probably belonging to the post station at the top of the pass, were also discovered. Many of the objects found then and in previous years, including

¹ So *Not. degli scavi* (1891), 81; but the statement is contradicted, *ibid.* (1894), 44.

many votive-tablets, are in the museum at the hospice of the Great St Bernard.

See *Notizie degli scavi, passim*, especially E. Ferrero (1890), 294; C. Promis, *Antichità di Aosta* (Turin, 1862).

The Little St Bernard was known to the Romans as Alpis Graia. It derived its name from the legend that Hercules, returning from Spain with the oxen of Geryon, crossed the Alps by this route, though the legend rather suits the route through the Maritime Alps. According to many modern scholars, Hannibal passed this way over the Alps, though the question has been much discussed (see art. HANNIBAL, and Patsch in Pauly-Wissowa, *Realencyclopädie* i., 1604). In any case it was the principal pass over the Alps into Gallia Comata until the pass of the Alpis Cottia (Mont Genève) was opened by Cn. Pompeius in 75 B.C., and became the principal route, though the road was only completed under Augustus by Cottius in 3 B.C. Various remains of the road are visible, and those of a building (possibly a temple of Jupiter) have been found on the summit of the pass.

See *Notizie degli scavi* (1883), 7 (1894), 46; and C. Promis, *Antichità di Aosta* (Turin, 1862), 115 sqq. (T. As.)

ST BERTRAND-DE-COMMINGES, a village of south-western France at the foot of the Pyrenees in the department of Haute-Garonne, about 70 m. S.W. of Toulouse by rail and road. St Bertrand stands about 1 m. from the left bank of the Garonne on the slopes of an isolated hill crowned by its celebrated cathedral of Notre Dame. The façade of the church with its square tower and the first bay with its aisles are Romanesque, and belong to a church begun about the end of the 11th century by Bishop Bertrand (1075-1123), afterwards canonized. The nave with its side chapels and the choir, in the Gothic style, date from the first half of the 14th century and were chiefly the work of Bertrand de Goth, bishop from 1205 to 1209 and afterwards Pope Clement V. The choir screen, rood-loft and altar, which form an enclosure within the church, are masterpieces of Renaissance wood-carving, as are also the choir stalls. The church contains several tombs, the most interesting of which are the fine white marble tomb of Bishop Hugh of Châtillon (d. 1352), and the mausoleum of St Bertrand (both of the 15th century), whose relics are preserved in the treasury. On the south side of the church there is a ruined cloister of Romanesque architecture.

St Bertrand-de-Comminges (Lugdunum Convenarum) was founded in 72 B.C., and before the end of the 5th century became the seat of a bishopric suppressed at the Revolution. The town was destroyed towards the end of the 6th century by Guntrum, king of Burgundy, after it had served as a refuge to Gondwald, pretender to the crown of Aquitaine.

SAINT-BON, SIMONE ARTURO (1823-1892), Italian admiral, was born at Chambéry on the 20th of March 1823. Leaving the Naval Academy in 1847, he attained the rank of commander in 1860, and that of vice-admiral in 1867. He took part in the Crimean war, distinguished himself in 1860 at the siege of Ancona, and was decorated for valour at the siege of Gaeta. At the battle of Lissa, in 1866, his vessel, the "Formidable," forced the entrance of the port of San Giorgio and silenced the Austrian batteries, for which exploit he received a gold medal. In 1873 he was elected deputy, and appointed by Minghetti to be minister of marine, in which position he revolutionized the Italian navy. Insisting upon the need for large battleships with high powers of attack and defence, and capable of fighting as single units, he introduced the colossal types of which the "Dulio" and the "Dandolo" were the earliest examples. Falling from power with the Right in 1876, he resumed active service, but in 1891 was again appointed minister of marine. He died on the 26th of November 1892, while still in office. He is remembered in Italy as the originator of the modern Italian fleet.

ST BRIEUC, a town of western France, capital of the department of Côtes-du-Nord, 63 m. N.W. of Rennes by the railway to Brest. Pop. (1906) town 15,270; commune 23,041. It stands 200 ft. above the sea, between 1 and 2 m. from the English Channel and less than a mile from the right bank of the Gouët, at the mouth of which is its seaport, Le Légué. St Brieuc is the seat of a bishopric in the province of Rennes, and has a cathedral dating from the 13th century, but partially rebuilt in the 18th, and afterwards extensively restored. In the interior the tombs

of the bishops and a Renaissance organ-loft deserve mention. The oldest part of the episcopal palace date back to the 16th century. The hôtel-de-ville contains a museum and picture gallery. An Ursuline convent serves as barracks. There are numerous houses of the 15th and 16th centuries, in one of which James II, king of England, is said to have lodged in 1689. A colossal image of the Virgin looks down upon the town from an eminence on the north, and there is a statue of Du Guesclin. The industries include wool-spinning, timber-sawing, iron and steel-working, and the manufacture of brushes and agricultural implements.

St Brieuc owes its origin and its name to the missionary St Briocus, who came from Wales in the 5th century, and whose tomb afterwards attracted crowds of pilgrims. The place was defended in 1375 by Olivier de Clisson against the duke of Brittany, and again attacked by the same Clisson in 1394, the cathedral suffering greatly in both sieges. In 1502 the town was pillaged by the Spaniards, in 1601 ravaged by the plague, and in 1628 surrounded by walls of which no traces remain. Between 1602 and 1768 the states of Brittany several times met at St Brieuc. During the Reign of Terror Chouans and Republicans carried on a ruthless conflict with each other in the vicinity. The ancient fort of Péran, built of vitrified granite, is about 5 m. S. of St Brieuc.

ST CATHARINES, a city of Ontario, Canada, and the capital of Lincoln county, on the Welland Canal and the Grand Trunk, and St Catharines and Niagara Central railways, 35 m. S. of Toronto, with which it has steamer connexion. Pop. (1901) 9946. It is connected by electric tramways with the neighbouring towns and villages, and is in the midst of a fine fruit-growing district. Its excellent water-power provides motive force for numerous industries, among which are flour-mills and factories for the manufacture of edge tools and agricultural implements. Bishop Ridley College, under Anglican control, is an important residential school. There are mineral springs which are much visited by invalids.

ST CHAMOND, a manufacturing town of east-central France, in the department of Loire, 7½ m. N.E. of St Étienne, on the railway from St Étienne to Lyons. Pop. (1906) 14,147. The town lies in a small basin surrounded by mountains at the confluence of the Janon with the Gier, an affluent of the Rhone. It has coal-mines forming part of the Rive-de-Gier basin. The milling of raw silk, the manufacture of ribbons and laces of every kind, dyeing and the construction of naval and railway material are the foremost industries. There are also metal-foundries, manufactories of nails, heavy iron goods, looms and other industrial establishments.

St Chamond, founded in the 7th century by St Ennemond or Chamond, archbishop of Lyons, became the chief town of the Jarret, a little principality formed by the valley of the Gier. Silk-milling was introduced in the town in the middle of the 16th century by Gayotti, a native of Bologna. Remains are found at St Chamond of a Roman aqueduct, which conveyed the waters of the Janon along the valley of the Gier to Lyons.

ST CHARLES, a city and the county-seat of St Charles county, Missouri, U.S.A., situated on the N. bank of the Missouri river, about 20 m. above its mouth, and about 23 m. N.W. of St Louis. Pop. (1910) 9437. It is served by the Wabash and the Missouri, Kansas & Texas railway systems, and by an electric railway to St Louis. A great steel bridge, 6335 ft. long (built 1868-1871), crosses the river and gives entry to the Wabash railway from St Louis. It has three spans of 305 to 321 ft., which at the time of their construction were the longest of their kind in the world. A highway bridge also crosses the river, and is the only wagon bridge between Jefferson City and the mouth of the river. At St Charles are a Presbyterian school for women (Lindenwood College); St Charles Military College (Methodist Episcopal, 1837), the Academy of the Sacred Heart (1818); St Joseph's Hospital, and the Emmaus Asylum for Epileptics. St Charles has important car works (among the largest in the United States), a large shoe factory, flour mills, brick and tile yards and breweries. St Charles county is very fertile, and its yield of wheat is especially large. At the sand works at Klondike, in the southern part of the county, large quantities of silica are blasted, crushed, bolted and shipped.

A French settlement was begun at St Charles in 1769, and soon

thereafter a Spanish official was placed in residence. St Charles was organized as a village under territorial law in 1809, and in 1849 was chartered as a city. It was the first capital of the state (1820-1826).

SAINT CLAIR, a borough of Schuylkill county, Pennsylvania, U.S.A., on Mill Creek, 3 m. N. of Pottsville, and about 40 m. by rail N.N.W. of Reading. Pop. (1910) 6455. Saint Clair is served by the Pennsylvania and the Philadelphia & Reading railways. It is engaged chiefly in the mining (very largely surface-stripping) and shipping of anthracite coal, and in the manufacture of miners' supplies. Saint Clair was settled in 1825 and was incorporated as a borough in 1850.

ST CLAIR, a lake and river of North America, forming part of the boundary between the state of Michigan, U.S.A., and the province of Ontario, Canada. The lake is 29 m. long and 20 broad. It contains numerous islands, receives from the Canadian side several rivers, the largest of which is the Thames, and is drained into Lake Erie by the Detroit river. At its foot are the cities of Detroit (Michigan) and Windsor (Ontario). On the north it receives the St Clair river, the outlet of Lake Huron. The shores of both lake and river are flat, and their waters shallow, but, owing to the enormous traffic which passes through, they have been in great part canalized, and can accommodate the largest steamers.

ST CLAUDE, a town of eastern France, capital of an arrondissement in the department of Jura, 42 m. S.S.E. of Lons-le-Saunier by rail. Pop. (1906) 9558. The town is beautifully situated 1300 ft. above sea-level at the western base of Mont Bayard, among the heights of the eastern Jura at the confluence of the Bienné and the Tacon. The latter river is crossed by a fine suspension bridge. The cathedral of St Pierre, once the abbey-church, a building of the 14th to the 18th centuries, contains fine 15th-century stalls and a retables of the Renaissance period. The town is the seat of a bishop, suffragan of Lyons, and of a sub-prefect. St Claude has been noted since the close of the middle ages for its fancy articles in horn, tortoise-shell, hardwood, ivory, &c., and there are manufactures of briar-root pipes. Diamond-cutting and lapidary work and the manufacture of measures are also prosperous industries.

The town derives its name from that of an archbishop of Besançon who died in the 7th century in the monastery founded here in the 5th century. This monastery subsequently acquired almost independent sovereignty in the locality, and held its retainers in a state of serfdom till the Revolution. Voltaire pleaded the cause of the serfs, though unsuccessfully, before the *parlement* of Besançon, and in memory of his services a statue was erected to him in 1887. St Claude was constituted a bishopric in 1762. The abbey-buildings and most of the town were destroyed by fire in 1799.

ST CLOUD, a town of northern France, in the department of Seine-et-Oise, on the left bank of the Seine, 2 m. W. of the fortifications of Paris by road. Pop. (1906) 7316. Picturesquely built on a hill-slope, St Cloud overlooks the river, the Bois de Boulogne and Paris; and, lying amid the foliage of its magnificent park and numerous villa gardens, it is one of the favourite resorts of the Parisians. The palace of St Cloud, which had been a summer residence for Napoleon I., Louis XVIII., Charles X., Louis Philippe and Napoleon III., was burned by the Prussians in 1870 along with part of the village. In spite of the damage inflicted on the park at the same period its magnificent avenues and ornamental water still make it one of the pleasantest spots in the neighbourhood of Paris. Every year in September, at the time of the pilgrimage of St Cloud, a fair lasting four weeks is held in the park. Within its precincts are situated the national Sèvres porcelain manufactory and the Breteuil pavilion, the seat of the international commission on the metre. St Cloud possesses a modern church in the style of the 12th century with an elegant stone spire; and here, too, is established the higher training college for male teachers for the provincial training colleges of primary instruction.

Cloald or Cloud, grandson of Clovis, adopted the monastic life and left his name to the spot where his tomb was discovered

after the lapse of 1200 years, in a crypt near the present church. He had granted the domain to the bishops of Paris, who possessed it as a fief till the 18th century. At St Cloud Henry III. and the king of Navarre (Henry IV.) established their camp during the League for the siege of Paris; and there the former was assassinated by Jacques Clément. The castle was at that time a plain country house belonging to Pierre de Gondi, archbishop of Paris; in 1658 it was acquired by the duke of Orleans, who was the originator of the palace which perished in 1870. Peter the Great of Russia was received there in 1717 by the regent, whose grandson sold the palace to Marie Antoinette. It was at St Cloud that Bonaparte executed the *coup d'état* of 18th Brumaire (1799); after he became emperor the palace was his favourite residence, and there he celebrated his marriage with Marie Louise. In 1815 it was the scene of the signing of the capitulation of Paris; and in 1830 from St Cloud Charles X. issued the orders which brought about his fall. Napoleon III. was there when he received the *senatusconsult* which restored the empire in his favour (1st December 1852). Seized by the Prussians at the beginning of the investment of Paris in 1870, St Cloud was sacked during the siege.

ST CLOUD, a city in Stearns, Benton and Sherburne counties, Minnesota, U.S.A., and the county-seat of Stearns county, about 65 m. N.W. of Minneapolis, on both banks of the Mississippi river, and about 970 ft. above sea-level. Pop. (1900) 8663, of whom 1907 were foreign-born; (1910 U.S. census) 10,600. It is served by the Great Northern and the Northern Pacific railways. It is the seat of one of the State Normal Schools (1869), and of the Minnesota State Reformatory (1887). In the city are the Carnegie library, a Federal building, a Roman Catholic cathedral, St Raphael's Hospital (Roman Catholic), St Clotilda's Academy of Music and two business colleges. The Mississippi has a considerable fall here, and provides valuable water-power. Among the manufactures are flour, barrels, bricks, and foundry and machine-shop products—the Great Northern maintains extensive car and repair shops here. In 1905 the value of the city's factory product was \$1,994,476, an increase of 27.8% since 1900. There are large lumber yards, and excellent grey and red granites (St Cloud is called "the Granite City") from neighbouring quarries are exported. The city lies in a large grain-growing and stock-raising district. St Cloud was settled in 1852, platted in 1854, incorporated as a village in 1868, and chartered as a city in 1889. Until reached by the Great Northern railway, St Cloud was the Hudson's Bay Company's terminus for the unloading of furs from the wooden ox-carts ("Red river" carts).

ST CROIX or SANTA CRUZ, the largest island in the Danish West Indies. It lies 65 m. S.E. of Puerto Rico, in 17° 40' N. and 64° 14' W., is 22 m. long, varies in breadth from 1 m. to 6 m., and has an area of 84 sq. m. Pop. (1901) 18,500. Parallel with the western coast is a range of hills, culminating in Mount Eagle (1164 ft.). The narrower western part is also hilly, but on the S. shore there are marshy tracts with lagoons of brackish water. Sugar is the staple product, and near Christianståd there is a central factory conducted by the government. The planters are mostly English, and their language predominates. The capital, Christianståd (locally known as "Bassin"), is situated at the head of an inlet on the N. coast, but its harbour is to a large extent choked with mud. It is a picturesque town, and the seat of the Danish governor during half the year. The only other town, Frederickståd, stands on an open roadstead on the W. coast. It is locally known as "West End," and part of the town, wrecked by the blacks in 1878, lies in ruins. The climate is healthy, the mean annual temperature being 74° F. and the average rainfall 45.7 in. per annum.

St Croix was discovered in 1493 by Columbus, and was owned in turn by the Dutch, British and Spanish. In 1651 it was taken by France, and two years later was given to the Knights of Malta by Louis XIV. In 1733 it was purchased by Denmark. Slavery was abolished in 1848 after a violent insurrection which had broken out among the slaves.

See Sir H. H. Johnston, *The Negro in the New World* (1910).

SAINT-CYRAN, a French Benedictine abbey in the province of Berry, now comprised in the department of the Loiret. From 1620 to 1643 it was held by the famous Jansenist reformer, DuVerger (*q.v.*), who is consequently often spoken of by French writers as the Abbé de Saint-Cyran.

ST CYR-L'ÉCOLE, a town of northern France in the department of Seine-et-Oise, 3 m. W. of Versailles at the end of the old park of Louis XIV. Pop. (1906) 2696. Its importance is due to the famous military school (*école spéciale militaire*) in which officers for the cavalry and infantry are trained. It was established in 1808 in the convent which Madame de Maintenon founded for the education of noble young ladies in poor circumstances. Racine's *Esther* and *Athalie* were first acted here, having been written expressly for the pupils. Madame de Maintenon's tomb is still preserved in the chapel. The convent was suppressed at the Revolution, and the gardens are now partly transformed into parade-grounds.

ST DAVIDS (*Tyddewi*), a cathedral town of Pembrokeshire, Wales, situated near the sea to the S.E. of St David's Head, the most westerly promontory of South Wales. Pop. (1901) 1710. St Davids is 10 m. distant from the station of Fishguard on the Great Western railway, and about 16 m. from Llesgerton to the N.E., and 16 m. from Haverfordwest to the E. The little town, locally known as "the city," stands in a lofty position east of the Cathedral Close, and consists of five streets, which converge on an open space called the Cross Keys, formerly used as a market-place and distinguished by its High Cross, a single shaft erect on a square base of six steps, restored in 1873. From the cross a lane leads westward to the Tower Gate, flanked by two ancient towers in a ruinous condition. From this point is obtained a superb view of the close with the cathedral and ruined palace in the valley of the Alun below, to which the rocky outline of Carn Llidi forms an imposing background.

The cathedral church of SS. Andrew and David, in spite of centuries of neglect and ill-advised alterations, remains the largest and most interesting pile of ecclesiastical buildings in the Principality. It is largely built of a beautiful purple-hued sandstone, which is quarried locally. Its proportions are: length (exclusive of the Trinity and Lady chapels), 254 ft.; breadth of nave and aisles, 51½ ft.; breadth of transepts including tower, 116 ft.; and height of central tower, 116 ft. In spite of the antiquity of its foundation, the earliest and main portion of the existing fabric was erected under Bishop Peter de Leia (1176-1198) in the transitional Norman-English style. Bishop David Martyn (1290-1288) built the Lady Chapel; Bishop Henry de Gower (1328-1347), one of the greatest of ecclesiastical builders in Wales, made many additions in the Decorated style, including the stone rood-screen and southern porch; and Bishop Edward Vaughan (1509-1522) erected the Trinity Chapel between the choir and Lady Chapel. Under the last-named prelate the magnificence of St Davids reached its height, but owing to the changes during the Reformation and the unscrupulous rapacity of Bishop William Barlow (1536-1548) the fabric suffered severely; nor was it spared later during the Civil Wars, when the Lady Chapel, the aisles of the presbytery, and even the transepts were unroofed and partially dismantled. In 1793 the cathedral was repaired by Thomas Nash, who rebuilt the western front in a debased Perpendicular style. The work of much-needed restoration was carried out throughout the latter half of the 19th century, especially between 1862 and 1869, when Sir Gilbert Scott strengthened the building at a cost of over £43,000. In 1873 Nash's incongruous work was replaced by a new facade intended to harmonize with the original design of Bishop de Leia, and at the beginning of the 20th century the Lady Chapel and Bishop Vaughan's Chapel were restored in memory of Bishop Basil Jones (d. 1897) and of Deans Allen and Phillips. The interior of the nave, separated by six wide bays from the aisles, is singularly impressive with its triforium and clerestory windows. It possesses an elaborate roof of Irish oak, the gift of Treasurer Owen Pole (c. 1500). The nave is divided from the choir by Bishop Gower's fine stone screen, whilst the choir itself contains the richly carved stalls erected by Bishop Tully (1460-1481), the episcopal throne, and an elegant oak screen that serves to separate choir and presbytery. The painted roof (freely restored) exhibits the coats-of-arms of Bishops Tully and Edward Martin, Treasurer Owen Pole and other benefactors. The eastern wall of the choir has been greatly altered by the addition of modern Venetian mosaic designs in the original lower triplet of lights, and by the insertion of lancet windows in place of a large Perpendicular window of the 15th century. Bishop Vaughan's chapel contains fine Tudor fan vaulting, and the Lady Chapel good decorated sedilia. The cathedral, before the Reformation, was remarkably rich in sculptured tombs and monuments, but many

of these have perished and all the brasses have disappeared. In the presbytery stands prominent the altar tomb with modern brasses inserted of Edmund Tudor, earl of Richmond (d. 1456), father of King Henry VII. Among the other surviving monuments, all more or less injured and defaced, are the tombs of Bishop Gower and of several bishops of St Davids; the canopied effigies popularly but erroneously attributed to Prince Rhys (d. 1196) and his son Rhys; the stone base of the destroyed shrine of St David; a priest's effigy formerly believed to be that of the celebrated Giraldu Cambrensis; and the large Jacobean monument of Treasurer Thomas Lloyd (d. 1612). To the north of the cathedral is to be seen the ruined shell of the beautiful chapel with an adjoining tower, forming part of the college of St Mary, founded by John of Gaunt and Bishop Adam Houghton in 1377.

On the west bank of the Alun stands the splendid and indeed unique ruin of the episcopal palace erected by Bishop Gower (c. 1342). Built for the purpose of culture and entertainment rather than for defence, Bishop Gower's ecclesiastical mansion is "essentially a palace and not a castle; and it is hardly too much to affirm that it is altogether unsurpassed by any existing English edifice of its kind." Built upon vaulted cellars, the palace occupies three sides of a quadrangle 120 ft. square, and though roofless and deserted for nearly three hundred years it retains most of its principal features. The great hall, 96 ft. by 33 ft., possesses a traceried wheel-window; the chief portal is still imposing; and the chapel retains its curious bell-turret; while the peculiar but singularly graceful arcaded parapet of the roof extends in great thoroughness to the whole length of the building. Partially dismantled by Bishop Barlow (1540) the half-ruined palace was occasionally occupied by succeeding bishops prior to the Civil Wars, and in 1633 a chapter was held within its walls under Bishop Field.

The Close, 18 acres in extent and extra-parochial, contains the deanery and other residences of the cathedral clergy, mostly occupying the sites of ancient buildings. It formerly owned four gateways, of which the South or Tower Gate alone remains. The whole of the wild and bleak but picturesque neighbourhood of St Davids teems with legendary and historical associations, and cromlechs and ruined chapels are numerous, amongst the latter the chapels of St Justinian (Capel Stinan) and St Non being the most remarkable.

History.—At some unknown period in the 6th century the celebrated patron saint of Wales, Dewi or David, removed the chief seat of South Welsh ecclesiastical life to Menevia or Menapia (Mynyw), which is traditionally reported to have been the saint's birthplace. The site chosen for this new foundation was the marshy valley of the Alun—the *Vallis Rosina* of medieval historians—and this spot became known henceforth as Tyddewi or St Davids. The dread of an imminent Anglo-Saxon invasion of Gwent, the determination to remove his monastic clergy from court influence, and the desire of opening closer communication with the sister Churches of Ireland, are among the various reasons suggested for David's remarkable policy, which made St Davids the leading religious centre in South Wales for nearly a thousand years. From the 7th to the 11th centuries the successors of St David occasionally ventured to exercise metropolitan rights over South Wales, and even over all land west of the Severn, and the character and extent of these ancient claims have frequently been made the subject of speculation or controversy among historians, some of whom have not hesitated to designate the early Celtic holders of the see by the title of "archbishop." These ill-defined claims were destroyed by St Anselme's forcible appointment of the Norman monk Bernard to the bishopric in 1115, from which date to the present time St Davids has ranked as a suffragan see of Canterbury; nor has its ancient independence ever been seriously asserted, save by the intrepid Gerald de Barri (Giraldu Cambrensis), who vainly strove from 1199 to 1205 to induce Pope Innocent III. to acknowledge the power of the cathedral chapter to elect its own bishops without reference to English king or primate. St Davids early became popular as a place of pilgrimage, and amongst the many supplicants who visited St David's shrine were William the Conqueror, Henry II. and Edward I. with Queen Eleanor. Probably with a view to conciliate the native clergy for Anselme's unpopular policy in Wales, Henry I. obtained from Pope Calixtus II. the canonization of St David about 1120, and in local esteem two pilgrimages to St Davids were vulgarly supposed to be equivalent to one journey to Rome itself: a sentiment preserved in the curious monkish hexamer:

"Roma semel quantum bis dat Menevia tantum."

From 1115 to the Reformation the see was held by prelates

(many of them natives of Wales) who did much to enrich and beautify the vast group of ecclesiastical buildings in the Close. But with the partial destruction of the palace and the removal of the episcopal residence to Abergwili, it was not long before St Davids sank into a mere monument of its former splendour and importance. In 1539 Bishop Barlow even petitioned Thomas Cromwell for permission to remove the see itself to Carmarthen, a request which tradition declares Henry VIII. refused to grant solely out of respect for the memory of his grandfather Edmund Tudor, whose tomb had recently been taken from the suppressed priory of Grey Friars at Carmarthen and set up before the high altar of the cathedral. During the 17th and 18th centuries all the ancient buildings of the Close, except the cathedral (which served also as a parish church for the village of St Davids), were allowed to fall into hopeless ruin. Amongst the 119 bishops who have held the see since its foundation by St David may be mentioned Asser, the friend of King Alfred (d. 906); Samson (10th century), honoured by the Welsh chroniclers with the proud title of "Archbishop of the Isle of Britain"; Rhyddmarch (d. 1096), the first biographer of St David; Henry de Gower (d. 1347), the munificent patron of art; Robert Ferrar, burned at Carmarthen in 1555 under Queen Mary; Richard Davies (d. 1581), patriot and translator of the Welsh Book of Common Prayer; Archbishop William Laud, bishop of the see between 1621 and 1627; George Bull, divine (d. 1710); and Connop Thirlwall, scholar and historian (d. 1875). The official title of the bishops of St Davids is *Episcopus Menevensis*. (H.M.V.)

ST DENIS, an industrial town of northern France, capital of an arrondissement in the department of Seine, 5 m. N. of Paris. Pop. (1906) 62,323. St Denis, an important junction on the northern railway, stands in a plain on the right bank of the Seine, which is here joined by the canal of St Denis. It has numerous metallurgical works, where railway material, naval engines and the like are constructed, distilleries of spirits, glass-works, potteries and manufactories of drugs, chemical products, oils, nickel plate and pianos. The name and fame of the town are derived from the abbey founded by Dagobert I. on the spot where St Denis, the apostle of Paris, was interred. The abbey buildings, occupied by a school for daughters of members of the Legion of Honour, founded by Napoleon I., date from the 18th century.

The church exhibits the transition from the Romanesque to the Gothic style. The west front was built between 1140 and 1149. The right-hand tower is almost pure Romanesque; that on the left was Gothic, and its spire was carried to a height of 280 ft., but it was struck by lightning in 1837 and reconstructed in so clumsy a manner that it had to be reduced to the level of the roof of the nave. The rose window, now occupied by a clock face, dates from the 13th century. Under one of the three rows of arches above the main entrance runs an inscription recording the erection of the church by Abbot Suger (*q.v.*), minister of Louis VI., with abbatical funds and its consecration in 1140. The porch formed by the first three bays of the church contains some remains of the basilica of Pippin the Short and Charlemagne, by whom the church was rebuilt. The nave proper (235 ft. long and 57 wide) has seven bays, and dates, as well as most of the choir and transepts, from the reign of St Louis. The secondary apse (*roundpoint*) and its semicircular chapels (consecrated in 1144) are considered as the first perfected attempt at Gothic. The transepts have fine façades, the north of the 12th, the south of the 13th century, each with two unfinished towers; if the plan had been fully carried out there would have been six towers besides a central spire in lead. The church contains a series of tombs of the kings and princes of the royal houses of France. The most remarkable are those of Louis XII. and Anne of Brittany, executed from 1516 to 1532; of Henry II. and Catherine de' Medici, a masterpiece by Germain Pilon (1564-1583); of Louis of Orleans and Valentine of Milan, from the old church of the Celestines at Paris (1502-1515); of Francis I. and Claude of France, one of the most splendid tombs of the Renaissance, executed under the direction of Philibert Delorme (1550-1560); and that of Dagobert, which, though considerably dilapidated, ranks as one of the most curious of medieval (13th-century) works of art. In the apse some stained glass of the time of Suger remains. The crypt dates partly from the 10th or 11th century. In the centre is the vault where the coffin of the king used to lie until, to make room for that of his successor, it was removed to its final resting-place. It is at present occupied by the coffin of Louis XVIII., the last sovereign whose body was borne to St Denis. Besides fine statues, the crypt contains the Bourbon vault, in which among other coffins are deposited the remains of Louis XVI. and Marie Antoinette.

St Denis, the ancient *Catulliacum*, was a town of no pretensions till the foundation of its abbey, which became one of the most powerful in France. The rebuilding of the church, begun in the 12th century by Suger, was completed in the 13th century. Among the many domains of the abbey was the French Vexin. It was held during the later middle ages by the French kings and vassals of the abbey, and to this fact is due their adoption of the oriflamme or red banner of St Denis as the royal standard. St Louis caused mausoleums to be erected with figures of the princes already buried in the abbey; and from his time to that of Henry II. every monarch in succession had his monument. Louis XIV. reduced the abbey to the rank of a priory; and at the Revolution it was suppressed, the tombs being violated and the church sacked (1793). Two years later all the remains that could be recovered were placed in the museum of the Petits Augustins at Paris; but the bronze tombs had been melted down, the stained-glass windows shattered, and large numbers of interesting objects stolen or lost. Louis XVIII. caused all the articles belonging to St Denis to be brought back to their original site, and added numerous other monuments from the suppressed abbeys. But it was not till after 1848 that, under the direction of Viollet le Duc, the basilica recovered its original appearance. St Denis, which was the key of Paris on the north, was more than once pillaged in the Hundred Years' War, suffering especially in 1358 and 1406. A sanguinary battle, in which the Catholic leader Constable Anne de Montmorency found victory and death, was fought between Huguenots and Catholics in the neighbourhood on the 10th of November 1567.

See F. de Guilhaume, *Monographie de l'Église royale de St Denis* (Paris, 1848).

ST DIÉ, a town of eastern France, capital of an arrondissement in the department of Vosges, 38 m. N.E. of Epinal by rail. Pop. (1906) town, 16,783; commune, 22,136. St Dié is situated on the Meurthe in a basin surrounded by well-wooded hills. The town, part of which was laid out in a uniform style after the fire of 1757, is built largely of red sandstone. Its cathedral has a Romanesque nave (12th century) and a Gothic choir; the portal of red stone dates from the 18th century. A fine cloister (13th century), containing a stone pulpit, communicates with the Petite-Église or Notre-Dame, a well-preserved specimen of Romanesque architecture (12th century). The hôtel-de-ville contains a theatre, a library with some valuable manuscripts, and a museum of antiquities. There is a monument by Mercié to Jules Ferry, born in the town in 1832. St Dié is the seat of a bishop and of a sub-prefect. The town benefited from the immigration of Alsatians after the Franco-German War of 1870-71, and its industries include the spinning and weaving of cotton, bleaching, wire-drawing, metal-founding, and the manufacture of hosiery, woodwork of various kinds, machinery, iron goods and wire-gauge.

St Dié (*Deodatum*, *Theodata*, *S. Deodati Famium*) grew up round a monastery founded in the 7th century by St Deodatius of Nevers, who gave up his episcopal functions to retire to this place. In the 10th century the community became a chapter of canons; among those who subsequently held the rank of provost or dean were Giovanni de' Medici, afterwards Pope Leo X., and several princes of the house of Lorraine. Among the extensive privileges enjoyed by them was that of coining money. Though they co-operated in building the town walls, the canons and the dukes of Lorraine soon became rivals for the authority over St Dié. Towards the end of the 15th century one of the earliest printing-presses of Lorraine was founded at St Dié. The institution of a town council in 1628, and the establishment in 1777 of a bishopric which appropriated part of their spiritual jurisdiction, contributed greatly to diminish the influence of the canons; and with the Revolution they were completely swept away. During the wars of the 15th, 16th and 17th centuries the town was repeatedly sacked. It was also partially destroyed by fire in 1065, 1155, 1554 and 1757. Funds for the rebuilding of the portion of the town destroyed by the last fire were supplied by Stanislas, last duke of Lorraine.

ST DIZIER, a town of north-eastern France, in the department of Haute-Marne, 45 m. N.N.W. of Chaumont by rail, on the Marne and the Haute-Marne canal. Pop. (1906) town, 10,316; commune, 14,661. The town is a very important centre of the iron trade, with foundries, forges and engineering

works, and has trade in grain and timber. It dates from the 3rd century, when the relics of Bishop St Didier (whence the name of the town) were brought thither after the destruction of Langres by the Germans. It sustained a memorable siege against Charles V. in 1544.

STE ANNE DE BEAUPRÉ, a post-village of Montmorency county, Quebec, Canada, at the junction of the Ste Anne river with the St Lawrence, and on the Quebec, Montmorency & Charlevoix railway, 22 m. below the city of Quebec. It stands in a rolling agricultural country, with hills in the background; and near by, on the Ste Anne river, are beautiful falls and excellent fishing. For over two centuries Ste Anne has been known as a Roman Catholic place of pilgrimage, and many miracles are still said to be performed through the intercession of the saint, the mother of the Virgin. In the basilica, an over-ornate building, are ever-increasing piles of crutches and other aids, cast aside by the cured. The resident population is about 1500, chiefly composed of hotel-keepers and members of religious orders, but throughout the year many pilgrimages are made, and on such days as the feast day of Ste Anne (26th of July) 30,000 people are often present. The total number of pilgrims in 1905 was 170,000. In addition to the basilica the village contains numerous religious edifices, the chief being the Scala Santa, built in imitation of the Holy Stairs at Rome.

SAINTE-BEUVE, CHARLES AUGUSTIN (1804-1869), French critic, was born at Boulogne-sur-Mer (No. 16 Rue du Pot d'Étain) on the 23rd of December 1804. He was a posthumous child, his father, a native of Picardy, and controller of town-dues at Boulogne, having married in this same year, at the age of fifty-two. The father was a man of literary tastes, and used to read, like his son, pencil in hand; his copy of the Elzevir edition of Virgil, covered with his notes, was in his son's possession, and is mentioned by him in one of his poems. Sainte-Beuve's mother was half English, her father, a mariner of Boulogne, having married an Englishwoman. The little Charles Augustin was brought up by his mother, who never remarried, and an aunt, his father's sister, who lived with her. They were poor, but the boy, having learnt all he could at his first school at Boulogne, persuaded his mother to send him, when he was near the age of fourteen, to finish his education at Paris. He boarded with a M. Landry, and had for a fellow-boarder and intimate friend Charles Neate, afterwards fellow of Oriel College and member of parliament for the city of Oxford. From Landry's boarding-house he attended the classes, first of the Collège Charlemagne, and then of the Collège Bourbon, winning the head prize for history at the first, and for Latin verse at the second. In 1823 he began to study medicine, attending lectures on anatomy and physiology and walking the hospitals. But meanwhile a Liberal newspaper, the *Globe*, was founded in 1827 by Paul François Dubois, one of Sainte-Beuve's old teachers at the Collège Charlemagne. Dubois called to his aid his former pupil, who, now quitting the study of medicine, contributed historical and literary articles to the *Globe*, among them two, which attracted the notice of Goethe, on Victor Hugo's *Odes et ballades*. These articles led to a friendship with Victor Hugo and to Sainte-Beuve's connexion with the romantic school of poets, a school never entirely suited to his nature. In the *Globe* appeared also his interesting articles on the French poetry of the 16th century, which in 1828 were collected and published,¹ and followed by a second volume containing selections from Ronsard. In 1829 he made his first venture as a poet with the *Vie, poésies, et pensées de Joseph Delorme*. His own name did not appear; but Joseph Delorme, that "Werther in the shape of Jacobin and medical student," as Guizot called him, was the Sainte-Beuve of those days himself. About the same time was founded the *Revue de Paris*, and Sainte-Beuve contributed the opening article, with Boileau for its subject. In 1830 came his second volume of poems, the *Consolations*, a work on which Sainte-Beuve looked back in later life with a special affection. To himself it marked and expressed, he said, that epoch of his

life to which he could with most pleasure return, and at which he could like best that others should see him. But the critic in him grew to prevail more and more and pushed out the poet.² In 1831 the *Revue des deux mondes* was founded in rivalry with the *Revue de Paris*, and from the first Sainte-Beuve was one of the most active and important contributors. He brought out his novel of *Volupté* in 1834, his third and last volume of poetry, the *Pensées d'août*, in 1837. He himself thought that the activity which he had in the meanwhile exercised as a critic, and the offence which in some quarters his criticism had given, were the cause of the less favourable reception which this volume received. He had long meditated a book on Port-Royal. At the end of 1837 he quitted France, accepting an invitation from the academy of Lausanne, where in a series of lectures his work on Port-Royal came into its first form of being. In the summer of the next year he returned to Paris to revise and give the final shape to his work, which, however, was not completed for twenty years.³ In 1840 Victor Cousin, then minister of public instruction, appointed him one of the keepers of the Mazarin Library, an appointment which gave him rooms at the library, and, with the money earned by his pen, made him for the first time in his life easy in his circumstances, so that, as he afterwards used to say, he had to buy rare books in order to spend his income. A more important consequence of his easier circumstances was that he could study freely and largely. He returned to Greek, of which a French schoolboy brings from his *lycée* no great store. With a Greek teacher, M. Pantasides, he read and re-read the poets in the original, and thus acquired, not, perhaps, a philological scholar's knowledge of them, but a genuine and invaluable acquaintance with them as literature. His activity in the *Revue des deux mondes* continued, and articles on Homer, Theocritus, Apollonius of Rhodes, and Meleager were fruits of his new Greek studies. He wrote also a very good article in 1844 on the Italian poet Leopardi; but in general his subjects were taken from the great literature which he knew best, that of his own country—its literature both in the past and in the contemporary present. Seven volumes of *Portraits*, contributed to the *Revue de Paris* and the *Revue des deux mondes*, exhibit his work in the years from 1832 to 1848, a work constantly increasing in range and value.⁴ In 1844 he was elected to the French Academy as successor to Casimir Delavigne, and was received there at the beginning of 1845 by Victor Hugo.

From this settled and prosperous condition the revolution of February 1848 dislodged him. In March of that year was published an account of secret-service money distributed in the late reign, and Sainte-Beuve was put down as having received the sum of one hundred francs. The smallness of the sum would hardly seem to suggest corruption; it appears probable that the money was given to cure a smoky chimney in his room at the Mazarin Library, and was wrongly entered as secret-service money. But Sainte-Beuve, who piqued himself on his independence and on a punctilious delicacy in money matters, was indignant at the entry, and thought the proceedings of the minister of public instruction and his officials, when he demanded to have the matter sifted, tardy and equivocal. He resigned his post at the Mazarin and accepted an offer from the Belgian government of a chair of French literature in the university of Liège. There he gave the series of lectures on Chateaubriand and his contemporaries which was afterwards (in 1860) published in two volumes.⁵ He liked Liège, and the Belgians would have been glad to keep him; but the attraction of Paris carried

¹ Sainte-Beuve was at this time a devoted Catholic and a little later for a very short period a disciple of Lamennais. But he gradually separated from his Catholic friends, and at the same time a coldness grew up between him and Victor Hugo. He became the lover of Madame Hugo, and a definite separation between the former friends ensued in 1834. [E.D.]

² *Port-Royal* (1840-1848, 5 vols.; 3rd and revised ed., 1866; 5th ed. with index, 1888-1897).

³ He was a friend of Madame Récamier, at whose house he met Chateaubriand. He became an especially close friend of Louis Mathieu, Comte Moët, for whose niece, Mme d'Arbouville, he conducted a lasting attachment. [E.D.]

⁴ *Chateaubriand et son groupe littéraire sous l'Empire*.

⁵ *Tableau historique et critique de la poésie française au XVI^e siècle* (2nd ed., 1842).

him back there in the autumn of 1849. Louis Napoleon was then president. Disturbance was ceasing; a time of settled government, which lasted twenty years and corresponds with the second stage of Sainte-Beuve's literary activity, was beginning. Dr Véron, the editor of the *Constitutionnel*, proposed to him that he should supply that newspaper with a literary article for every Monday; and thus the *Causeries du lundi* were started. They at once succeeded, and "gave the signal," as Sainte-Beuve himself says with truth, "for the return of letters." Sainte-Beuve now lived in the small house in the Rue Montparnasse (No. 11), which he occupied for the remainder of his life, and where in 1850 his mother, from whom he seems to have inherited his good sense, tact and finesse, died at the age of eighty-six. For three years he continued writing every Monday for the *Constitutionnel*; then he passed, with a similar engagement, to the *Moniteur*. In 1857 his Monday articles began to be published in volumes, and by 1862 formed a collection in fifteen volumes; they afterwards were resumed under the title of *Nouveaux lundis*, which now make a collection of thirteen volumes more. In 1854 he was nominated to the chair of Latin poetry at the college of France. His first lecture there (in 1855) was received with interruptions and marks of disapprobation by many of the students, displeased at his adherence to the empire; at a second lecture the interruption was renewed. Sainte-Beuve had no taste for public speaking and lecturing; his *frontis mollities*, he said, unfitted him for it. He was not going to carry on a war with a party of turbulent students; he proposed to resign, and when the minister would not accept his resignation of his professorship he resigned its emoluments. The *Étude sur Virgile*, a volume published in 1857, contains what he had meant to be his first course of lectures. He was still a titular official of public instruction; and in 1858 his services were called for by Gustave Rouland, then minister of public instruction, as a lecturer (*maître de conférences*) on French literature at the École Normale Supérieure. This work he discharged with assiduity and success for four years. In 1859 he was made commander of the Legion of Honour, having twice previously to 1848 refused the cross. During the years of his official engagement his Monday contributions to the *Moniteur* had no longer been continuous; but in 1862 an arrangement was proposed by which he was to return to the *Constitutionnel* and again supply an article there every Monday. He consented, at the age of fifty-seven, to try this last pull, as he called it, this "dernier coup de collier"; he resigned his office at the École Normale and began the series of his *Nouveaux lundis*. They show no falling off in vigour and resource from the *Causeries*. But the strain upon him of his weekly labour was great. "I am not a *monsieur* nor a gentleman," he writes in 1864, "but a workman by the piece and by the hour." "I look upon myself as a player forced to go on acting at an age when he ought to retire, and who can see no term to his engagement." He had reason to hope for relief. Except himself, the foremost literary men in France had stood aloof from the empire and treated it with a hostility more or less bitter. He had not been hostile to it; he had accepted it with satisfaction, and had bestowed on its official journal, the *Moniteur*, the lustre of his literature. The prince Napoleon and the princess Mathilde were his warm friends. A senatorship was mentioned; its income of £1600 a year would give him opulence and freedom. But its coming was delayed, and when at last in April 1865 he was made senator, his health was seriously compromised. The disease of which he died, but of which the doctors did not ascertain the presence until his body was opened after his death—the stone—began to distress and disable him. He could seldom attend the meetings of the senate; the part he took there, however, on two famous occasions—when the nomination of Ernest Renan to the college of France came under discussion in 1867, and the law on the press in the year following—provoked the indignation of the great majority in that conservative assembly. It delighted, however, all who "belonged," to use his own phrase, "to the diocese of free thought"; and he gave further pleasure in this diocese by

leaving the *Moniteur* at the beginning of 1869, and contributing to a Liberal journal, the *Temps*.¹ His literary activity suffered little abatement, but pain made him at last unable to sit to write; he could only stand or lie. He died in his house in the Rue Montparnasse on the 13th of October 1869.

The work of Sainte-Beuve divides itself into three portions—his poetry, his criticism before 1848 and his criticism after that year. His novel of *Vulpéité* may properly go with his poetry.

We have seen his tender feeling for his poetry, and he always maintained that, when the "integrating molecule," the foundation of him as a man of letters, was reached, it would be found to have a poetic character. And yet he declares, too, that it is never without a sort of surprise and confusion that he sees his verses detached from their context and quoted in public and in open day. They do not seem made and quoted in his way. This admirable critic knew, indeed, the radical inadequacy of French poetry. It is to English poetry that he resorts in order to find his term of comparison, and to award the praise which to French poetry he refuses. "Since you are fond of the poets," he writes to a friend, "I should like to see you read and look for poets in another language, in English for instance. There you will find the most rich, the most dulcet and the most new poetical literature. Our French poets are too soon read; they are too slight, too mixed, too corrupted for the most part, to excite in ideal even when they have the talent for strength of line, to hold and occupy for long a serious mind."

But, even as French poetry, Sainte-Beuve's poetry had faults of its own. Critics who found much in it to praise yet pronounced it a poetry "narrow, puny and stilted," and its style "slowly dragging and laborious." Here we touch on a want which must no doubt be recognized in him, which he recognized in himself, and whereby he is separated from the spirits who succeed in uttering their most highly inspired note and in giving their full measure—some want of flame, of breath, of pinton. Perhaps we may look for the cause in a confession of his own: "I have my weaknesses; they are the whole of me. King Solomon his duty with my earthly life, and my satiety with life, may have regretted sometimes that I was thus extinguishing my fire, but I did not ever pervert that heart." It is enough for us to take his confession that he extinguished or impaired his fire.

Yet his poetry is characterized by merits which make it readable still and readable by foreigners. So far as it exhibits the endeavour of the romantic school in France to enlarge the vocabulary of poetry and to give greater freedom and variety to the alexandrine, it has interest chiefly for readers of his own nation. But it exhibits more than this. It exhibits already the genuine Sainte-Beuve, the author who, as M. Duvergier de Hauranne said in the *Globe* at the time, "sent à sa manière, écrit comme il sent," the man who, even in the forms of an artificial poetry, remains always "un penseur et un homme d'esprit." That his Joseph Delorme was not the Werther of romance, but a Werther in the shape of Jacobin and medical student, the only Werther whom Sainte-Beuve by his own practical experience really knew, was a novelty in French poetical literature, but was entirely characteristic of Sainte-Beuve. All his poetry has this stamp of direct dealing with common things, of plain unpretending reality and sincerity; and this stamp at that time made it, as *l'étranger* said, "a kind of poetry absolutely new in France."

It has been the fashion to disparage the criticism of the *Critiques et portraits littéraires*, the criticism anterior to 1848, and to sacrifice it, in fact, to the criticism posterior to that date. Sainte-Beuve has himself indicated what considerations ought to be present with us in reading the *Critiques et portraits*, with what reserves we should read them. They are to be considered, he says, "rather as a dependency of the elegiac and romanesque part of my work than as express criticisms." They have the copiousness and enthusiasm of exuberance; they have all its exuberance. He judged Victor Hugo, Chateaubriand, Lamartine, Victor Hugo, more coolly, judged them differently. But the *Critiques et portraits* contain a number of articles on personages, other than contemporary French poets and romance-writers, which have much of the soundness of his later work, and, in addition, an abundance and fervour of their own which are not without their attraction. Many of these are delightful reading. The articles on the Greek poets and on Leopardi have been already mentioned. Those on Boileau, Molière, Pierre Daunou and Charles Claude Fauriel, on Madame de la Fayette and Mademoiselle Alais may be taken as samples of a whole group which will be found to support perfectly the test of reading, even after we have accustomed ourselves to the later work of the master. Nay, his soberness and tact show themselves even in this earlier stage of his criticism, and even in treating the objects of his too fervid youthful enthusiasm. A special object of this was Victor Hugo, and in the first article on him in the *Portraits contemporains* we have certainly plenty of enthusiasm, plenty of exuberance. We have the epithets "adorable," "sublime," "supreme," given to Victor Hugo's poetry; we are told of "the majesty of its high and sombre philosophy." But the article next

¹ This course of action definitely separated him from the Bonapartists and led to a quarrel with Princess Mathilde.—[E.D.]

following this, and written only four years later, in 1835, is the article of a critic, and takes the points of objection, seizes the weak side of Victor Hugo's poetry, how much it has of what is "creux," "sonore," "artificiel," "voulu," "théâtral," "violent," as distinctly as the author of the *Causeries* could seize it. "The Frank, energetic and noble, who has mastered to perfection the technical and rhetorical resources of the Latin literature of the decadence," is a description never to be forgotten of Victor Hugo as a poet, and Sainte-Beuve launches it in this article, written when he was but thirty years old, and still a painter of "portraits de jeunesse" only.

He had thus been steadily working and growing; nevertheless, 1848 is an epoch which divides two critics in him of very unequal value. When, after that year of revolution and his stage of seclusion and labour at Liège, he came back to Paris in the autumn of 1849 and commenced in the *Constitutionnel* the *Causeries du lundi*, he was astonishingly matured. Something of fervour, enthusiasm, poetry, he may have lost, but he had become a perfect critic—a critic of measure, not exuberant; of the centre, not provincial; of keen industry and curiosity, with "Truth" (the word engraved in English on his seal) for his motto; moreover, with gay and amiable temper, his manner as good as his matter—the "critique souriant," as, in Charles Monselet's dedication to him, he is called.

The root of everything in his criticism is his single-hearted devotion to truth. What he called "fictions" in literature, in politics, in religion, were not allowed to influence him. Some one had talked on his being tenacious of a certain set of literary opinions. "I hold very little," he answers, "to literary opinions; literary opinions occupy very little place in my life and in my thoughts. What does occupy me seriously is life itself and the object of it."

"I am accustomed incessantly to call my judgments in question anew, and to re-cast my opinions the moment I suspect them to be without validity." "What I have wished" (in *Port-Royal*) "is to say not a word more than I thought, to stop even a little short of what I believed in certain cases, in order that my words might acquire more weight as historical testimony." To all exaggeration and untruth, from whatever side it proceeded, he had an antipathy. "I turn my back upon the Michelets and Quinets, but I cannot hold out my hand to the Veullots."

But Sainte-Beuve could not have been the great critic he was had he not had, at the service of this his love of truth and measure, the conscientious industry of a Benedictine. "I never have a holiday. On Monday towards noon I lift up my head, and breathe for about an hour; after that the wicket shuts again and I am in my prison cell for seven days." The *Causeries* were at this price. They came once a week, and to write one of them as he wrote it was indeed a week's work. The "irresponsible indolent reviewer" should read his notes to his friend and provider with books, M. Paul Chéron of the National Library. Here is a note dated the 2nd of January 1853: "Good-day and a happy New Year. To-day I set to work on Grimm. A little dry; but after St François de Sales" (his Monday article just finished); "one requires a little relief from roses. I have of Grimm the edition of his *Correspondance* by M. Taschereau. I have also the *Memoirs* of Madame d'Épinay, where there are many letters of his. But it is possible that there may be notices of him mentioned in the biographical book of that German whose name I have forgotten. I should like, too, to have the *first editions* of his *Correspondance*; they came out in successive parts." Thus he prepared himself, not for a grand review article once a quarter, but for a newspaper review once a week.

His adhesion to the empire caused him to be represented by the Orleanists and Republicans as without character and patriotism, and to be charged with baseness and corruption. The Orleanists had, in a great degree, possession of the higher press in France and of English opinion—Liberal English opinion, more especially. And with English Liberals his indifference to parliamentary government was indeed a grievous fault in him; "you Whigs," as Croker happily says, "are like quack doctors, who have but one specific for all constitutions." To him either the doctrine of English Liberals, or the doctrine of Republicanism, applied absolutely, was what he called a "fiction," one of those fictions which "always end by obscuring the truth." Not even on M. de Tocqueville's authority would he consent to receive "les hypothèses dites les plus hono-

ables"—"the suppositions which pass for the most respectable. All suppositions he demanded to sift, to see them at work, to know the place and time and men to which they were to be applied. For the France before her eyes in 1849 he thought that something "solid and stable"—"un mur," "a wall," as he said—was requisite, and that the government of Louis Napoleon supplied the wall. But no one judged the empire more independently than he did, no one saw and denounced its faults more clearly; he described himself as being, in his own single person, "the *gouche* of the empire," and the description was just.

To these merits of mental independence, industry, measure, lucidity, his criticism adds the merit of happy temper and disposition. Goethe long ago noticed that, whereas Germans reviewed one another as enemies whom they hated, the critics of the *Globe* reviewed one another as friends. This arose from the higher social development of France and from the closer relations of literature with life there. But Sainte-Beuve has more, as a critic, than the external politeness which once at any rate distinguished his countrymen—he has a personal charm of manner due to a sweet and humane temper. He complained of *un peu de dureté*, "a certain dose of hardness," in the new generation of writers. The personality of an author had a peculiar importance for him; the poetical side of his subjects, however latent it might be, always attracted him, and he always sought to extricate it. This was because he had the moderate, gracious, amiably human instincts of the true poetic nature. "Let me beg of you," he says in thanking a reviewer who praised him, "to alter one or two expressions at any rate. I cannot bear to have it said that I am the *first* in anything whatever, as a writer least of all; it is not a thing which can be admitted, and these ways of classing people give offence." Literary man and loyal to the French Academy as he was, he can yet write to an old friend after his election: "All these academies, between you and me, are pieces of childishness; at any rate the French Academy is. Our last quarter of an hour of solitary reverie or of serious talk, yours and mine, in our youth, was better employed; but, as one gets old, one falls back into the power of these nothings; only it is well to know that nothings they are."

Perhaps the best way to get a sense of the value and extent of the work done in the last twenty years of his life by the critic thus excellently endowed is to take a single volume of the *causeries du lundi*, to look through its list of subjects, and to remember that with the qualities above mentioned all these subjects are treated. Any volume will serve; let us take the fourth. This volume consists of articles on twenty-four subjects. Twenty of these are the following: Mirabeau and Sophie, Montaigne, Mirabeau and Comte de la Marck, Mademoiselle de Soudry, André Chénier as politician, Saint-Evremond and Ninon, Joseph de Maistre, Madame de Lambert, Madame Necker, the Abbé Maury, the Duc de Lauzun of Louis XVI's reign, Marie Antoinette, Buffon, Madame de Maintenon, De Bonald Amoyot, Mallet du Pan, Marmontel, Chamfort, Rulhière. Almost every personage is French, it is true; Sainte-Beuve had a maxim that the critic should prefer subjects which he possesses familiarly. The great place of France in the world is very much due to her eminent gift for social life and development; and this gift French literature has afforded, fashioned, perfected, and continues to reflect. And nowhere shall we find such interest more completely and charmingly brought out than in Sainte-Beuve's *Causeries du lundi* and the *Nouveaux lundis*. As a guide to bring us to a knowledge of the French genius and literature he is unrivalled. (M. A.)

AUTHORITIES.—See his "Ma Biographie" in *Nouveaux lundis*, xiii., *Lettres de la princesse* (1873); *Correspondance* (1877-1878) and *Nouvelle Correspondance* (1880); the Vicomte d'Haussonville's *Sainte-Beuve* (1875); Scherer, *Études sur la littérature contemporaine*, iv., G. Michoud, *Sainte-Beuve avant les Lundis* (1903). Sainte-Beuve's centenary was celebrated in various ways; for centenary criticism see the *Edinburgh Review* (April 1905) ("Sainte-Beuve and the Romantics"); *Monthly Review* (April 1905) (by F. Brunetiere); *Revue des Deux Mondes* (March 1905) (by Victor Giraud). In the *Œuvres choisies de Juste Olivier* (1879) are some "Souvenirs"; and in 1903 the *Revue des Deux Mondes* published several interesting articles on a correspondence of Sainte-Beuve with Olivier.